

Trailblazer® 275 and 325

Issued July 2012 • Index No. ED/4.75

Gas or LP Engine-Driven
Welder/AC Generator 

Quick Specs

Industrial Applications

Fabrication
Maintenance
Repair
Structural Steel Work
Sheet Metal
Pipe

Processes (X-Ray Quality)

Stick (SMAW)
MIG (GMAW)
Flux-Cored (FCAW)
DC TIG/Pulsed TIG (GTAW/GTAW-P)
Air Carbon Arc (CAC-A) Cutting and Gouging
Rated: 3/16-inch carbons,
Capable: 1/4-inch carbons*
Air Plasma Cutting and Gouging with
optional Spectrum® models
Rated: 5/8-inch mild steel

*Available for 325 models only

Output Range

	275	325
DC Stick	30–275 A	30–325 A
MIG/Flux-Cored	10–35 V	10–35 V
DC TIG	10–275 A	10–325 A
Pulsed TIG (peak)	10–275 A	10–325 A

Generator Power Output Rated at 104° F (40° C)

Peak: 12,000 W — Continuous: 10,500 W

Excel™ Power (Recommended Option)

2400 W (120 V, 20A) 60 Hz pure sine power at all speeds

Electronic Fuel Injection (EFI) (Recommended Option)

Uses up to 27 percent less fuel

The Power of Blue.®

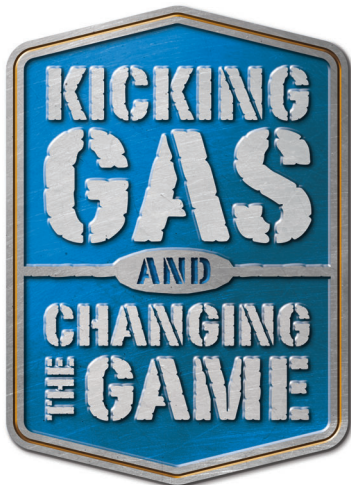

Designed for the professional welder, our Trailblazer welder/generators deliver unbeatable arc performance in all weld processes, providing the smoothest, most stable arc in the industry. The independent welder and generator power system means no interaction between jobsite tools and the welding arc.

When you add optional engineered exclusives like Excel power and Electronic Fuel Injection (EFI), your new Trailblazer becomes more fuel-efficient, cost-effective and quieter than ever before.



Trailblazer 325 EFI model shown.



Fewer refueling trips

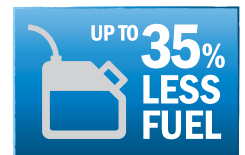

Significant cost savings

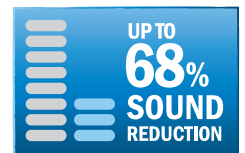

Safer, more productive jobsite



Easier mobility and uses less truck space and payload



Welder/generator is warranted for 3 years, parts and labor.
Engine is warranted separately by the engine manufacturer.



Miller Electric Mfg. Co.
An Illinois Tool Works Company
1635 West Spencer Street
Appleton, WI 54914 USA

Equipment Sales US and Canada
Phone: 866-931-9730
FAX: 800-637-2315
International Phone: 920-735-4554
International FAX: 920-735-4125

Website
MillerWelds.com



Base Model New Technologies (Standard on all models.)

Smart-Cor™ Technology

Smart-Cor technology in our new Trailblazer® welder/generators includes a newly designed ten-degree skewed rotor and Wave Filter™ technology for a new level of clean generator power. The independent welder and generator power system means no interaction between jobsite tools and the welding arc.

Wave Filter technology and 10-degree skewed rotor. The electronics found in some jobsite tools, plastic fusion welders, bore welders and appliances — such as furnaces and air conditioners — are sensitive to “dirty” generator power, which is measured in terms of harmonic frequencies and crest factor.

The ten-degree skewed rotor creates cleaner generator power by eliminating slot harmonics. Slot harmonics make up a portion of the total harmonic frequencies in a generator, and by eliminating them, generator power is smoother power, not spiked power.

The Wave Filter technology has taken total harmonic frequencies to a new low, and has a nearly perfect crest factor — which means that Trailblazer welder/generators will deliver cleaner power in any situation and keep your jobsite tools running without interruption.

Auto-Speed™ Technology

Traditional high-speed welder/generators always run at maximum speed (3600 RPM) while you're welding — regardless of whether you need that much power. And when you're running harder than you need to be, your fuel efficiency drops dramatically.

Auto-Speed technology automatically adjusts the engine speed to match your actual weld load requirements. Need more power? The engine will automatically ramp up. Change processes to something requiring less power, and the Trailblazer will automatically slow the engine down. For example, under low loads — such as welding with a 1/8-inch stick electrode — the engine will run at idle speed (2400 RPM). By automatically varying the engine speed, you can significantly reduce fuel consumption — and cost.

Innovative Design

Engine is rotated to the front to create more efficient airflow. Benefits it provides:

- Quieter operation
- Reduced size and weight
- Easier maintenance

Wave Filter technology

3-phase advanced hybrid welding power

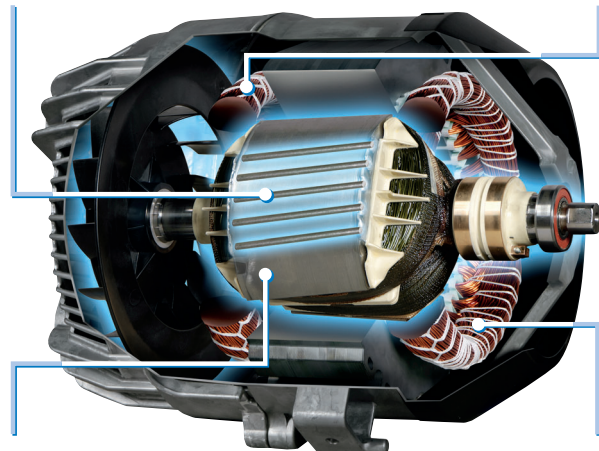

Ten-degree skewed rotor

12,000 watts of clean generator power

Improved Arc Performance

We've engineered the new Trailblazer to provide high-quality welds across a variety of applications — knowing quality welds begin with a quality arc. That's why we've significantly improved the performance for all welding processes and made it easy to fine-tune the arc to match your personal preferences and welding style.

- Three Stick modes for optimized arc performance — XX18, XX10 and Gouge
- Two Wire modes for simplified setup — Solid and Flux-Core
- Three TIG modes for optimized arc performance — Auto-Stop™, Auto-Crater™ and Pulse
- **NEW!** TIG Pulse mode available for out-of-position welding, thin metals and stainless steel where a lower amount of heat is desired while welding
- Infinite arc control available in the Stick and Solid Wire modes for easier fine tuning of tough-to-weld materials and out-of-position applications

Optional New Technologies

Add Excel™ Power and Electronic Fuel Injection (EFI) to Maximize your Trailblazer's Performance

Improve generator performance with Excel power

Excel power provides 120 volt, 60 hertz of pure sine wave generator power at idle speed and while welding. When connected to the Excel power receptacle, you get up to 2400 watts of the cleanest generator power available. Plus, you can run most jobsite tools — like grinders, chop saws, drills and lights — at idle speed, which provides:

- Exceptional fuel-efficiency
- Quieter operation
- Extended runtimes
- Longer engine life

Maximize performance with EFI

EFI optimizes the air/fuel ratio for all engine speeds and loads. Choose EFI for:

- Up to 27% better fuel-efficiency
- Extended runtimes up to 27%
- Fast, easy starts in all climates
- Reliable operation, even with infrequent use
- Fewer emissions — 27% less CO and 33% lower HC+NOx levels

Exceptional Fuel Efficiency

All new Trailblazers include innovative Auto-Speed technology, which enhances fuel-efficiency by regulating engine speed. By adding **optional** Excel power and EFI, you'll experience even more dramatic fuel savings and extended runtimes.



Excel™ Power (Recommended option)

Traditional welder/generators run at 3600 RPM when generator loads are applied. But when you add Excel power to your Trailblazer, you can plug in most jobsite tools and the machine will continue at idle speed (2400 RPM) — allowing you to do the same job while burning less fuel. When combined with Auto-Speed technology, Excel power allows you to weld and run tools at idle speed.

Electronic Fuel Injection (EFI) (Recommended option)

Electronic Fuel Injection significantly enhances fuel savings and extends runtimes by optimizing the air/fuel ratio for all engine speeds and loads. When you add EFI to your Trailblazer, your machine will run at peak fuel efficiency, regardless of how you're using it.

Annual Fuel Savings*

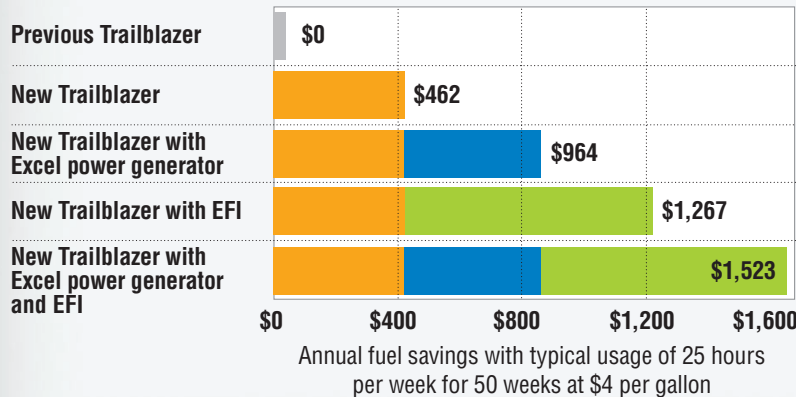

Longest Runtimes*

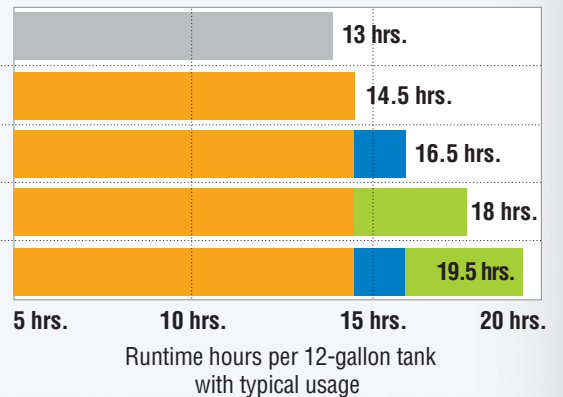

*Based on typical usage — 150 amps welding 40% of the time; 20 amps generator power 30% of the time; and idling without load 30% of the time.

Significantly Less Noise

The new Trailblazer runs as low as 65 decibels — that's almost 11 fewer than previous models.* On a typical jobsite, it would take twelve new Trailblazers running simultaneously to equal the sound output of only one of the older model.



*Sound cannot be measured using a linear scale; therefore, the decibel (dB) unit is used. It is a logarithmic unit used to describe a ratio of power, sound pressure, voltage or intensity that gauges the sound output.

Sound of 12 new Trailblazers



Sound of 1 previous Trailblazer



Reversed Generator Airflow

Exclusive engine and generator packaging design operates cooler and more efficiently. The engine is rotated towards the front to create more efficient airflow. More efficient airflow and exclusive engine location are significant contributors to reduced sound level and size reduction. Hot air recirculation is eliminated when machine is mounted in tight spots, and internal parts are kept cool for optimal performance.



Specifications (Subject to change without notice.)



Smaller and Lighter Design

Thanks to Smart-Cor™ technology and a new engine generator position, the new Trailblazer welder/generator takes up less space on trucks and trailers — leaving more room on your truck for other equipment and tools. Plus, they're easier to move safely around jobsites — even with weld cables and running gear attached.



Mounting Specifications

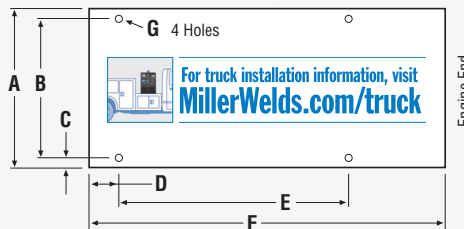

- A. 20 in. (508 mm)
- B. 16.5 in. (419 mm)
- C. 1.75 in. (44.5 mm)
- D. 12.18 in. (309 mm)
- E. 22.1 in. (562 mm)
- F. 40.32 in. (1024 mm)
- G. .406 in. (10.3 mm) diameter

Model	Welding Mode	Process	Amp/Volt Ranges	Rated Weld Output at 104° F (40° C)*	Single-Phase Generator Power	Sound Levels at 7 m (23 ft.)	Dimensions	Net Weight**
Trailblazer 275	CC/DC	Stick/TIG	10–275 A	275 A at 28 V, 100% Duty Cycle	Peak: 12,000 watts Continuous: 10,500 watts Excel™ Power (optional): 2400 watts, 20 A at 120 V, 60 Hz pure generator power at idle speed and while welding	Weld: 150 A Load: 65 dB (90 Lwa), 325 A Load: 73.5 dB (98.5 Lwa) Generator Power: Excel Power: 65 dB (90 Lwa), 12 kW Standard Power: 73.5 dB (98.5 Lwa)	H: 28 in. (711 mm) H: 32.75 in. (832 mm) (to top of exhaust) W: 20 in. (508 mm) D: 40.5 in. (1029 mm)	275 Model: 459 lb. (208 kg) 325 Model: 460 lb. (209 kg)
	CV/DC	MIG/FCAW	10–35 V	275 A at 28 V, 100% Duty Cycle				
Trailblazer 325	CC/DC	Stick/TIG	10–325 A	325 A at 28 V, 100% Duty Cycle	Peak: 12,000 watts Continuous: 10,500 watts Excel™ Power (optional): 2400 watts, 20 A at 120 V, 60 Hz pure generator power at idle speed and while welding	Weld: 150 A Load: 65 dB (90 Lwa), 325 A Load: 73.5 dB (98.5 Lwa) Generator Power: Excel Power: 65 dB (90 Lwa), 12 kW Standard Power: 73.5 dB (98.5 Lwa)	H: 28 in. (711 mm) H: 32.75 in. (832 mm) (to top of exhaust) W: 20 in. (508 mm) D: 40.5 in. (1029 mm)	275 Model: 459 lb. (208 kg) 325 Model: 460 lb. (209 kg)
	CV/DC	MIG/FCAW	10–35 V	325 A at 28 V, 100% Duty Cycle				

*Rated at sea level. **Net weight without fuel. Certified by Canadian Standards Association to both the Canadian and U.S. Standards.

Engine Specifications (Engines warranted separately by the engine manufacturer.)

Engine Brand/Warranty	Horsepower (HP)	Type	Weld Speed	Idle Speed	Fuel Capacity	Oil Capacity	Standard Shutdowns
Kohler: 3-year mfg.	25 HP at 3600 RPM	Twin-cylinder, four-cycle overhead valve, industrial air-cooled, gasoline* (carburetor or EFI) or LP	Auto-Speed™ 2400, 2800, 3200 or 3600 RPM	2400 RPM	12 gal. (45 L)	1.5 qt. (1.4 L)	Low Oil Pressure

*Fuel stabilizer is recommended for gas engines that are used infrequently.

Performance Data

WELD FUEL CONSUMPTION

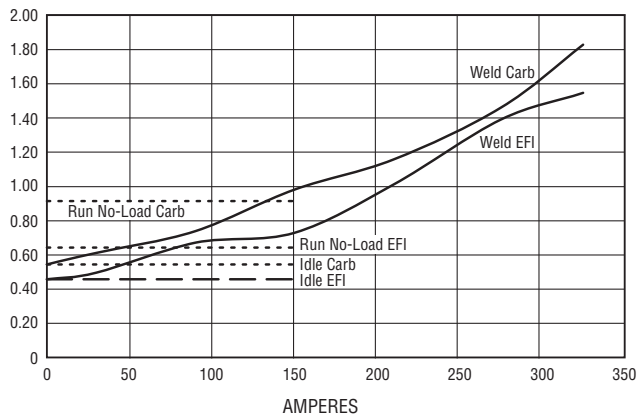

AUXILIARY POWER FUEL CONSUMPTION

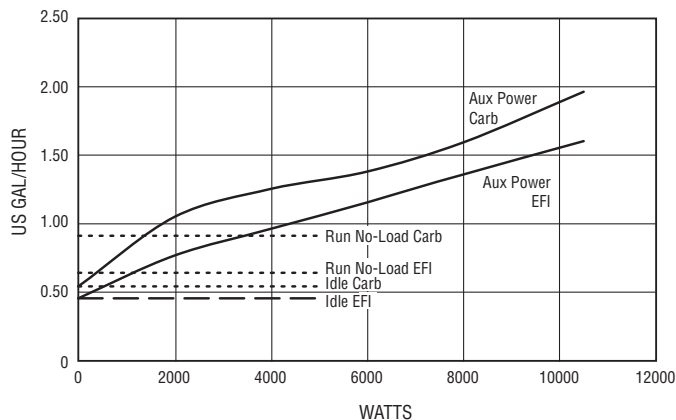

Function and Benefit Guide

1. Weld process switch

Two Wire modes — Solid and Flux-Core

- Solid: Arc characteristics optimized for steel wires which most commonly use the short circuit transfer. Turn arc control (#3) to “soft” for stainless wires and to “stiff” for aluminum.
- Flux-Core: Arc characteristics optimized for wires commonly used in construction and hard facing applications.

Three Stick modes — XX18, XX10 and Gouge

- XX18: Optimized for the majority of Stick welding applications.
- XX10: Hot start and arc characteristics optimized for pipe applications.
- Gouge: Maximized output for Air Carbon Arc Cutting and Gouging.

Three Lift-Arc™ TIG modes — Auto-Stop™, Auto-Crater™, and Pulse

- Auto-Stop™: No Auto-Crater allows full control on pipe welds with short or long arc length. Auto Stop feature allows arc to be broken without loss of shielding gas.

Note: Auto-Stop prevents arc flare when the arc breaks.

- Auto-Crater™: Ideal for most DC TIG applications. Ramps down current at the end of the weld to “crater-out” without use of a remote control.
- Pulse: Ideal for out of position, thin metals, and stainless steels where a lower amount of heat is desired while welding.

Note for DC TIG Pulse: background amps = 25 percent of peak, peak time = 40 percent, at 100 PPS.

- 2. **Front panel fuel gauge** with six LEDs to indicate fuel level. The amber LED lights when fuel is low.

- 3. **Arc Control** is active in the Stick and Solid Wire processes. It allows the operator to customize arc characteristics to match preference, electrode and joint design from a softer arc with more fluid puddle to a stiffer arc with an often more controllable puddle. The Star setting is optimized for most applications and pointing the control at soft or stiff is optimal for most of those arc preferences. Control is fully adjustable from 0 to 25 Soft or 0 to 25 Stiff.

4. Self-calibrating digital meters

- Preset and actual amperage/voltage
- Process settings
- Maintenance functions: hour meter, oil change interval, RPMs

- 5. **Standard 14-pin receptacle with Auto Remote Sense™** for simple connection of remote controls and wire feeders.

- 6. **Engine control:** Auto-Speed™ position adjusts engine to run at lower speeds depending on total power needed for welding.

- 7. **Optional Excel™ power (factory option, see page 8)** provides pure generator power at idle speed and while welding.

Note: If Trailblazer is ordered without Excel power option, unit is shipped with two standard duplex receptacles.

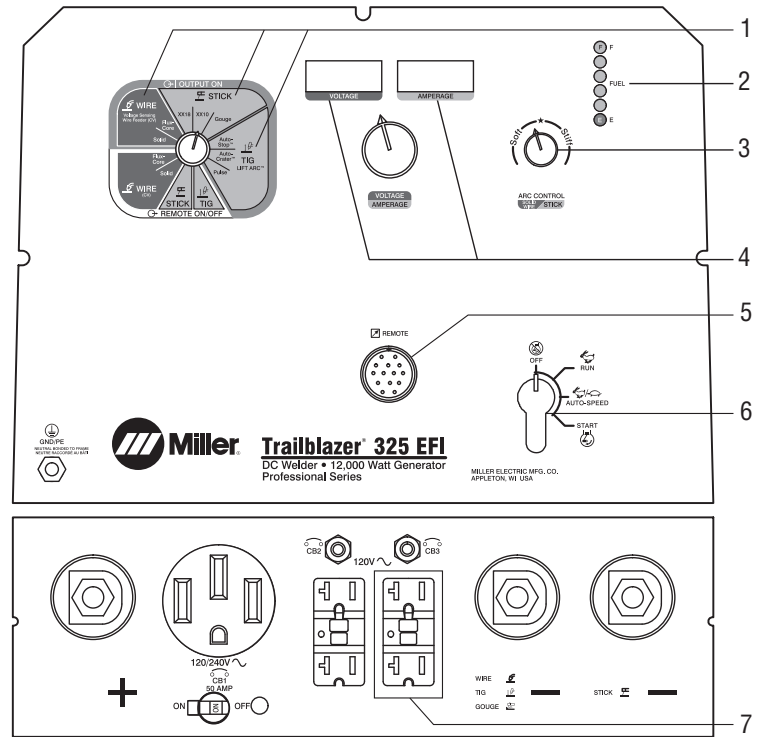

Easier Maintenance

With its intuitive design, the daily maintenance of our new Trailblazer welder/generators is faster and easier. With front panel maintenance displays, you know when your equipment needs to be serviced. And servicing is simple because of:

- Oil checks that can be performed from the top by the front panel
- Sunvision™ technology that provides easy-to-read digital meter maintenance displays in both direct sunlight and shade
- Toolless panels that allow for quick access
- Single-side fuel fill and oil drain/filter

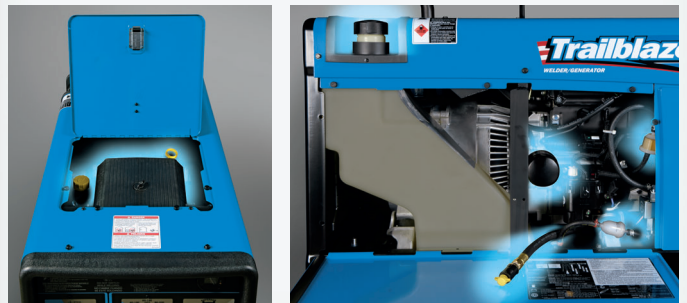

Genuine Miller® Options *Available as factory option. See ordering information on back page.

GFCI Protection* #300 975 Field Kit contains two GFCI 120 VAC duplex receptacles. (240 VAC GFCI receptacle not required).

LP Gas* Liquid withdrawal with vaporizer and regulator. Does not include tanks, brackets, or hose from tank to regulator.
Note: Requires LP Tank Mounting Assembly #300 917.

Electric Fuel Pump* #195 214 Field For gas models at high altitude. Improves engine starting and high-output performance.

Spark Arrestor #300 924 Field Mandatory when operating on California grasslands, brush or forest-covered land, and all National Forests. For other areas, check your state and local laws.



Rear Mount
#300 922 shown.

Remote Oil Drain and Filter Kit
#300 922 Field. Kohler, rear mount
#300 923 Field. Kohler, front mount
Makes servicing easy when engine drive is mounted in tight spots.



Female Receptacle

Adapter Cord, Full KVA #300 517 Field NEMA 14-50P to NEMA 6-50R. Adapts engine drive 120/240 V plug to common Millermatic® and Spectrum® 240 V plug.

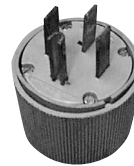

Full KVA Plug Kit
#119 172 Field 120/240 VAC, 50 A plug (NEMA 14-50P) to fit full KVA receptacle.

Order the following from Miller Service Parts.

Engine Tune-Up Kits
#230 015 Field. Kohler CH 730 (Gas)
#246 115 Field. Kohler ECH 730 (EFI Gas)
#252 838 Field. Kohler CH 730 (LP)
Tune-up kits include spark plugs (gas/LP models) and engine filters.

Genuine Miller® Accessories



Never Flat™ Tires

Available on Bobcat and Trailblazer Running Gear.

- Eliminate costly jobsite downtime
- Maintain constant tire pressure and will not develop flats
- Protect against punctures
- Preserve maneuverability, even when weighed down with heavy welding cable



Multi-Terrain Running Gear

#300 913 Gas/LP, with inner tubes
#300 914 Gas/LP, with Never Flat™ tires

Includes two heavy-duty 15-inch tires, two 8-inch rubber swivel casters and a heavy-duty handle. Recommended for all surfaces and applications, and is easy to move around the jobsite.



Hose and LP Tank Mounting Assembly

#300 917 LP
Designed for use with Multi-Terrain Running Gear, Protective Cage, or by itself. Includes bracket and clamp to mount 33- and 43-pound tanks horizontally, and hose with fittings to converter.

Note: Not for use with Gas Cylinder Mounting Assembly or Off-Road Running Gears. Not recommended for use with Protective Cover.



Off-Road Running Gear

#300 909 Gas, with inner tubes
#300 910 Gas, with Never Flat™ tires

Includes four heavy-duty 15-inch tires and a rugged handle to provide maximum maneuverability.

Note: Not for use with Gas Cylinder Mounting Assembly or LP Tank Mounting Assembly.



Protective Cage with Cable Holders

#300 921 Gas/LP
Rugged cage with cable holders protects your investment. Can be used with running gear, Gas Cylinder Mounting Assembly, LP Tank Mounting Assembly, or with trailer.

Protective Covers



#300 919 For Gas models **without** Protective Cage or Running Gear (shown)
#300 920 For Gas models **with** Protective Cage and/or Running Gear

Heavy-duty, water-resistant and mildew-resistant covers protect and maintain the finish of the welder.



Off-Road Running Gear with Protective Cage and Never Flat™ Tires

#300 912 Gas
Running gear and rugged cage with

cable holders protects your investment and is easy to move around the jobsite.

Note: Not for use with Gas Cylinder Mounting Assembly or LP Tank Mounting Assembly.



Gas Cylinder Mounting Assembly

#300 918 Gas
Designed for use with Multi-Terrain Running Gear, Protective Cage, or by itself. Includes base tray with bottle bracket, vertical support rack and safety chain.

Note: Not for use with LP Tank Mounting Assembly or Off-Road Running Gears. Not recommended for use with Protective Cover.

Stick (SMAW) Welding

Weld Leads

- #173 851 2/0, 350-amp, 100 percent duty cycle. 50-foot stinger and 50-foot work cable.
- #043 952 2/0, 300-amp, 100 percent duty cycle. 100-foot stinger and 50-foot work cable.

Plasma Cutting



Spectrum 375 X-TREME and 625 X-TREME shown.

Spectrum® 375 X-TREME™ #907 529

See Lit. Index No. PC/9.2.

Spectrum® 625 X-TREME™ #907 531

See Lit. Index No. PC/9.6.

Spectrum® 875 #907 390-01-1

See Lit. Index No. PC/9.8.

The Spectrum 375 X-TREME and 625 X-TREME come complete with protective X-CASE™ (not shown).

MIG/Flux-Cored Welding

Millermatic® Passport® Plus #907 401

Portable, all-in-one MIG package features ultimate arc performance, self-contained gas bottle, and flexibility to plug into 115- or 230-volt power with Miller exclusive Multi-Voltage Plug (MVP™). See Lit. Index No. DC/12.53.



Millermatic 211 Auto-Set with MVP shown.

Millermatic® 140 Auto-Set™ #907 335

See Lit. Index No. DC/12.42

Millermatic® 180 Auto-Set™ #907 312

See Lit. Index No. DC/12.44

Millermatic® 211 Auto-Set™ with MVP™ #907 422

See Lit. Index No. DC/12.54

Millermatic® 212 Auto-Set™ #907 405

See Lit. Index No. DC/12.46

The Millermatic line of MIG welders are complete arc welding power source, wire feeder and gun packages designed for portability and ease of use.

Note: The Millermatic machines can be operated utilizing generator power.



SuitCase® X-TREME™ 8VS Wire Feeder #951 181

SuitCase® X-TREME™ 12VS Wire Feeder #951 184

Lightweight, portable, voltage-sensing wire feeders include secondary contactor and gas valve. See Lit. Index No. M/6.41.



SuitCase® 8RC Wire Feeder #951 186

SuitCase® 12RC Wire Feeder #951 188

Lightweight, modular design and flexible enough to run a variety of wires up to 5/64-inch diameter. Comes standard with remote voltage control. See Lit. Index No. M/6.5.



Spoolmatic® 30A

Spool Gun #130 831

Air-cooled, 200-amp, 1-pound spool gun for aluminum MIG. See Lit. Index No. M/1.73.

Requires WC-24 Control (#137 549).

XR™ Wire Feeders and Guns

Push-pull system designed to handle difficult-to-feed soft alloy wires such as aluminum. See Lit. Index No. M/1.7, M/1.71, and M/1.73.

TIG (GTAW) Welding



Dynasty® 200 Series

For premium portable AC/DC TIG arc quality. See Lit. Index No. AD/4.8.

Remote Controls



Wireless Remote Hand Control #300 430

For remote current, voltage and contactor control. Receiver plugs directly into the 14-pin

receptacle of Miller machine. 300-foot (91.4 m) operating range.



RHC-14 Hand Control

#242 211 020

Miniature hand control for remote current and contactor control. Dimensions: 4 x 4 x 3.25 inches (102 x 102 x 82 mm).

Includes 20-foot (6 m) cord and 14-pin plug.



RFCS-14 HD Foot Control

#194 744

Heavy-duty foot current and contactor control. Includes 20-foot (6 m) cord and 14-pin plug.



RMLS-14 #129 337 14-pin plug

Momentary- and maintained-contact rocker switch for contactor control. Push forward for maintained contact and back for momentary contact. Includes 20-foot (6 m) cord.



RCC-14 Remote Contactor and Current Control

#151 086 14-pin plug

Rotary-motion fingertip control fastens to TIG torch using two Velcro® straps. Includes 28-foot (8.5 m) control cord.

Extension Cords for 14-Pin Remote Controls

#242 208 025 25 ft. (7.6 m)

#242 208 050 50 ft. (15.2 m)

#242 208 080 80 ft. (24.4 m)

Trailers and Hitches



HWY-1000 Trailer #195 013

A 1000-pound (454 kg) capacity highway trailer with welded steel tubing frame, heavy-duty axle with roller bearing hubs and leaf-spring suspension. The HWY-1000 comes with jack stand, 2-inch (50 mm) ball hitch, fenders and lights.

Note: Trailer is shipped unassembled.

Cable Tree #195 023

Provides an area to conveniently wrap weld cables and extension cords on the HWY-1000 trailer.



Dual Hitch #300 831

2-inch (50 mm) ball hitch and 3-inch (76 mm) lunette eye in one reversible assembly.

Ordering Information

Equipment and Options	Stock No.	Description	Qty.	Price
Trailblazer® 275 (Kohler)	#907 506-001 #907 506	With GFCI Receptacles		
Trailblazer® 275 EFI (Kohler)	#907 508	Electronic Fuel Injection with Excel™ Power		
Trailblazer® 275 LP (Kohler)	#907 509 #907 509-001	LP Engine LP Engine with Excel™ Power		
Trailblazer® 325 (Kohler)	#907 510-001 #907 510 #907 510-002 #907 510-003	With GFCI Receptacles With Electric Fuel Pump With Excel™ Power		
Trailblazer® 325 EFI (Kohler)	#907 512 #907 512-001	Electronic Fuel Injection Electronic Fuel Injection with Excel™ Power		
GFCI Protection	#300 975	Field		
Electric Fuel Pump	#195 214	Field. For gas engines at high altitudes		
Spark Arrestor	#300 924	Field		
Remote Oil Drain and Filter Kit	#300 922 #300 923	Field. Rear mount for Kohler Field. Front mount for Kohler		
Adapter Cord, Full KVA	#300 517	Field		
Full KVA Plug	#119 172	Field		
Engine Tune-Up Kits		Field. See page 6. <i>(Order from Miller Service Parts)</i>		
Accessories				
Off-Road Running Gear	#300 909 #300 910	Gas models, with inner tubes. <i>Not for use with Gas Cylinder or LP Tank Mounting Assembly</i> Gas models, with Never Flat™ tires. <i>Not for use with Gas Cylinder or LP Tank Mounting Assembly</i>		
Off-Road Running Gear with Protective Cage	#300 912	Gas models, with Never Flat™ tires. <i>Not for use with Gas Cylinder or LP Tank Mounting Assembly</i>		
Multi-Terrain Running Gear	#300 913 #300 914	Gas/LP models, with inner tubes Gas/LP models, with Never Flat™ tires		
Protective Cage w/Cable Holders	#300 921	Gas/LP models		
Gas Cylinder Mounting Assembly	#300 918	Gas models. <i>Not for use with LP Tank Mounting Assembly or Off-Road RGs.</i> <i>Not recommended for use with protective cover.</i>		
Hose and LP Tank Mounting Assembly	#300 917	LP models. <i>Not for use with Gas Cylinder Mounting Assembly or Off-Road RGs.</i> <i>Not recommended for use with protective cover.</i>		
Protective Covers		See page 6		
Spectrum® Plasma Cutters		See page 7		
Millermatic® Passport® Plus	#907 401	Includes gas bottle and MVP. See Lit. Index No. DC/12.53		
Millermatic® Series MIG Welders		See page 7		
SuitCase® Portable Wire Feeders		See page 7		
Spoolmatic® 30A Spool Gun	#130 831	Requires WC-24 Control. See Lit. Index No. M/1.73		
WC-24 Control	#137 549	See Lit. Index No. M/1.73		
XR™ Wire Feeder Control and Guns		See Lit. Index No. M/1.7, M/1.71, and M/1.73		
Dynasty® 200 Series TIG Welders		See Lit. Index No. AD/4.8		
Remote Controls and Cords		See page 7		
HWY-1000 Trailer	#195 013			
Cable Tree	#195 023			
Dual Hitch	#300 831			

Date:

Total Quoted Price:

Distributed by: