



NEBRASKA
DEPT. OF ENVIRONMENT AND ENERGY

N
EXTENSION
Pesticide Safety Education Program

**University of Nebraska Extension
Institute of Agriculture and Natural Resources
and the
Nebraska Department of Environment and Energy**

Extension is a Division of the Institute of Agriculture and Natural Resources at the University of Nebraska–Lincoln cooperating with the Counties and the United States Department of Agriculture.

The University of Nebraska does not discriminate based upon any protected status. Please see go.unl.edu/nondiscrimination.

© 2019, The Board of Regents of the University of Nebraska on behalf of Nebraska Extension. All rights reserved.

Table of Contents

Chemigation Links	iii
Acknowledgements	iii
Introduction	1
Factors Affecting Chemigation Practice	1
Irrigation Systems	5
Chemigation Equipment and Safety Devices	8
Management	17
Calibration Procedures	21
Laws and Regulations	30
Appendix A Summary - Nebraska Chemigation Act	36
Appendix B NDEE Rules and Regulations Pertaining to Chemigation	39
Appendix C Leakage Test	49
Appendix D Certified Chemigation Check Valve Models	50
Appendix E Calculating Irrigated Acreages	52
Appendix F Fertilizer and Pesticide Containment	57
Appendix G Disposing of Livestock Waste Through an Irrigation Distribution Systems..	59
Appendix H Nebraska Natural Resources Districts	61
UNL Extension Publications	64

Disclaimer

Reference to commercial products or trade names is made with the understanding that no discrimination is intended of those not mentioned and no endorsement by Nebraska Extension is implied for those mentioned.

Chemigation Links

UNL Water Page - <https://water.unl.edu/article/agricultural-irrigation/chemigation>

Chemigation Training Manual - <https://go.unl.edu/2019chemigationmanual>

Calibration Workbook <https://go.unl.edu/chemigationcalbrationworkbook>

Chemigation Calculator Spreadsheet V1 - <https://go.unl.edu/chemigationcalculator>

NDEE Chemigation website - <https://go.unl.edu/ndeechemigation>

NDEE FAQ - <https://go.unl.edu/ndeechemigationfaq>

Online Chemigation Course Directions-

Part 1A <https://go.unl.edu/chemigationcoursedirections1a>

Part 1B <https://go.unl.edu/chemigationcoursedirections1b>

Part 1C <https://go.unl.edu/chemigationcoursedirections1c>

Part 2 <https://go.unl.edu/chemigationcoursedirections2>

Proceed to Online Nebraska Chemigation Training <https://campus.extension.org/>

Using Chemigation Safely and Effectively

Written By:

William Kranz, Chuck Burr, John Hay, Jim Schild, & Dean Yonts

ATTENTION: With the passage of LB302, on July 1, 2019, the Nebraska Department of Environmental Quality and the Nebraska Energy Office merged into the Nebraska Department of Environment and Energy. The Chemigation manual, Calibration Workbook, and Certification Exam will reflect this change and will be replaced with **Nebraska Department of Environment and Energy (NDEE), which was formerly known as Nebraska Department of Environmental Quality (NDEQ).**

ACKNOWLEDGEMENTS

This edition of the Nebraska chemigation training manual has been published in response to changes in state and federal laws and comments from instructors. Other changes were made at the recommendation of several Nebraska Natural Resources Districts.

Drafts of the manual were substantially improved thanks to critiques and comments from both internal and external reviewers, including: Dean Yonts, Panhandle Research and Extension Center; Jim Schild, Scottsbluff County Extension Educator; Tom Trehwitt, Nebraska Department of Environmental Quality; Dick Erhman, Nebraska Department of Environmental Quality; and Chuck Burr, Phelps County Extension Educator.

Special thanks also are extended to Valmont Industries for granting permission to reproduce pages from their design guide on calculating irrigated acres.

Finally, this publication was originally written by a work group consisting of Ed Vitzthum, DeLynn Hay, John Witkowski and William Kranz under a contract with the US Department of Agriculture. Technical contributions were provided by Dean Eisenhauer, Professor of Biological Systems Engineering Department; Darrell Watts, Professor Emeritus; Jose Payero, formerly Associate Professor, West Central Research and Extension Center; Gary Buttermore, Nebraska Department of Environmental Quality; Gary Newton, Agri-Inject, Inc.; Marc Anderson, Private Consultant; Gene Ross, Nelson Irrigation; Dale Christensen, Valmont Mfg; and Dave Aiken, UNL Extension Water Law Specialist.

William Kranz, Editor

Introduction

Chemigation is the term commonly used to describe the practice of applying agrichemicals (i.e. fertilizer-including livestock waste, insecticides, herbicides, fungicides, nematicides, and other chemicals) through an irrigation distribution system.

As irrigation technology has become increasingly more sophisticated over recent decades, chemigation has become common in many of the semi-arid western states of the U.S. and notably in Nebraska. Unquestionably, the widespread use of the practice is attributable, at least in part, to the several advantages it offers producers (Threadgill, 1985):¹

- Excellent uniformity of chemical application.
- Prescription application of chemicals.
- Easy chemical incorporation and activation.
- Reduced soil compaction.
- Reduced mechanical damage to crop.
- Reduced operator hazards.
- Potential reduction of chemical requirements.
- Potential reduction of adverse environmental impacts.
- Economical (compared to cost of ground or aerial application).
- Effectiveness.

While there are advantages to chemigation, there are also some disadvantages and concerns:

- Additional capital outlay is required for equipment.
- The practice requires more intensive management on the part of the producer.
- There are both human and environmental safety considerations that must be taken into account.

It is the last of the disadvantages that prompted passage of the Nebraska Chemigation Act and subsequent adoption of regulations requiring training and certification of persons who chemigate. This publication, and other materials, are intended as references for producers and others seeking certification as chemigators. It is intended solely as a guide for safe and effective chemigation. Information in this publication should never be used in place of directions contained in chemical injection and irrigation system operator manuals and/or chemical product labels and labeling.

Factors Affecting Chemigation

Regardless of whether a fertilizer or pesticide will be applied, the first consideration is the needs of the growing crop. The decision to apply a pesticide, for example, would be made because the producer or a certified crop advisor scouted the field and determined that a pest was present in numbers exceeding the economic threshold.

Irrigation System Location

Equally important, especially when a pesticide is to be applied, is ensuring that the application does not endanger human health and safety, domestic animals, fish and wildlife (especially any endangered or threatened species), ground or surface water sources or neighboring crops. Applications over roadways or in close proximity to occupied buildings

(e.g. an adjacent residential area) must be avoided. When applicable, use restrictions such as those listed above, are always found on product labels. Pesticide labels and labeling have the force of law; failure to comply may result in prosecution. Restrictions also may apply if wells used for chemigation are near municipal water wells. Check with local regulatory agencies about such restrictions before chemigating.

Drift and Runoff Potential

Potential for drift or runoff - or both - should be high on the list of concerns for any producer planning to chemigate. Pesticide labels prohibit both; thus whenever either occurs, it is a label violation and the person responsible is subject to prosecution.

Regardless of label prohibitions, common sense dictates that wind drift and runoff should be avoided. Any chemical loss from the target area, or any damage to nontarget crops, become additional and unnecessary production expenses. Add to that the potential costs for environmental damages, and there are more than enough reasons to avoid drift and runoff.

Drift potential during a chemigation event can be affected by several variables. Among them are: system type (volume gun, center pivot with end gun, solid set) sprinkler type and position, operating pressure, droplet size, use/ nonuse of an adjuvant, and weather conditions at the time of the application.

Researchers at the University of Nebraska-Lincoln's Northeast Research and Extension Center, applied chlorpyrifos (Lorsban 4E) with crop oil to R3 stage corn through a 1,260 ft. long center pivot equipped with high angle, high pressure (60psi) impact sprinklers. They found significant amounts of the pesticide at monitoring stations as far as 330 ft. from the end of the pivot. When applied without crop oil, residues declined markedly at a distance of 200-265 ft. from the end of the pivot. Drift in both cases was concentrated directly in line with the direction of air movement. Wind speed during the study averaged just under 14 miles per hour (Byers, et al, 1993)².

Runoff can occur whenever the irrigation system is applying water at a rate greater than the infiltration rate of the soil. The occurrence of runoff depends not only on the irrigation system application rate and soil water infiltration rate, but also factors such as the field slope, soil surface roughness, and the presence of a crop canopy or residue. Runoff during chemigation may pose a potential hazard to ground and surface water, livestock, adjacent crops and wildlife.

Relatively high application rates are characteristic of the outer portion of center pivot irrigation systems, especially those operating at low pressures. Care should be taken to ensure that the sprinkler package is matched to field conditions. Depending on the type of chemical being applied and soil characteristics, the amount of water being used to apply the chemical can usually be adjusted to prevent runoff.

Soil Characteristics

Soils can differ considerably over relatively short distances. Several different soil textures are commonly found within a single field. The rate at which water and/or agricultural chemical(s) enters the soil (infiltration rate) differs according to soil texture. Thus, variations in soil texture will influence irrigation system management and chemigation operations.

For example, coarse-textured sandy soils have high infiltration rates. Assuming that other factors are equal (e.g. slope, compaction), there is less potential for runoff on coarse-textured soils than on fine-textured silty or clayey soils that have greater infiltration rates.

On coarse-textured sandy soils, chemigating with excessive amounts of irrigation water could result in leaching the chemical(s) below the crop root zone. Where fine-textured, clayey soils are to be chemigated, the situation is reversed. The potential for deep percolation of water and/or chemical(s) is decreased, but the potential for runoff increases.

Consult Natural Resources Conservation Service (NRCS) soil survey maps for specific soil characteristics. UNL Extension, NRCS and Natural Resources District (NRD) personnel as well as certified crop consultants can help provide assistance with irrigation management.

Topography

Topography of the field can substantially affect uniformity of water application through sprinkler irrigation systems lacking sprinklers with pressure regulators. Differences in elevation along the length of the sprinkler system will cause differences in pressure at each nozzle outlet. This results in uneven water distribution, especially with low pressure systems. Uneven water distribution can be corrected by using pressure regulators on each individual sprinkler. If distribution variances are not corrected, the irrigation system may be unsuitable for chemigation.



Sloping terrain such as that pictured here increases runoff potential.

Irrigation System Characteristics

Physical characteristics of an irrigation system can affect the capacity for applying agricultural chemicals. Most irrigation systems can be used to apply fertilizers or pesticides that must be incorporated into soil. However, only a sprinkler system can be used where foliar application is needed. Any system used to chemigate must have the appropriate injection equipment and anti-pollution safety devices installed, and the entire system must be in good working order. The section titled “Chemigation Equipment and Safety Devices” discusses system equipment requirements in detail.

Calibration

Accurate calibration of the chemical injection system is critical. Without calibration there is no way to determine whether the amount of chemical applied is too much, too little, or—by chance—just right. Over application is needlessly expensive and if a pesticide is over-applied, the person responsible can be prosecuted for misuse of a pesticide. Under-application frequently does not provide the desired effect. See the chapter on Calibration Procedures for additional information.

Uniformity

When deciding if chemigation should be used as an application method using a sprinkler system, the uniformity of water and chemical application should be considered. The versatility of center pivot and some linear move sprinkler systems allow them to irrigate a broad range of field shapes using end guns and corner systems. Developments in sprinkler packages allow irrigators to install nozzles at various distances from the soil surface using several different nozzle types. Technological advances have led to improvements in the water application by these systems.

End Guns

End guns can add more than 10 acres to the irrigated area of the center pivot if operated for the entire revolution. Intermittent use of end guns to accommodate roads, fence lines or farmsteads will result in different irrigated areas when the end gun is on than when it is off. Thus, when a system is calibrated with the end gun off, fixed rate chemical injection pumps will apply less chemical per acre when the end gun is on. The opposite is true if calibration occurs with the end gun on. This leads to nonuniform chemical application that can sometimes be seen from the air. If the sprinklers are pressure regulated, the change in chemical application is limited to the area irrigated by the end gun. Without regulators, the entire area irrigated while the end gun is running will have a different amount of chemical applied than when the system was calibrated.

The water application pattern of end guns is also affected by wind speed and direction. Where wind direction is parallel with the sprinkler system, it reduces the sprinkler throw or wetted radius significantly. Water and chemical meant for the area outside the main system can be deposited within the main irrigated area. A crosswind elongates the pattern in the direction parallel with the wind direction and reduces the pattern width in the direction perpendicular to the wind direction. (see figure below).

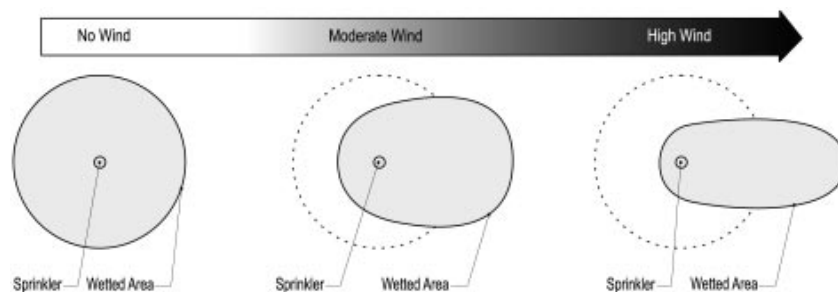

Wind impact on low pressure spray head on 5' drops

Corner Systems

When the center pivot includes a corner system, the potential difference is much greater. Center pivot manufacturers have incorporated this fact into their designs. In all cases, the main system is slowed down as the corner arm extends and speeds up as the corner arm retracts. In this way the area irrigated per hour is kept very similar to when the corner system is retracted. There are two ways to deal with water application as the corner system extends outward:

- 1) *Increase the flow rate into the system to account for the added acres of the corner arm.* If successful, this would ensure that chemical application is similar for the entire irrigated area. The down side is that the main portion of the system applies more water when the corner is extended than when it is retracted. For the season, the overall difference in depth between corner and non-corner areas depends on the length of the corner arm and how many times water and chemical is applied to the field.
- 2) *Reduce the flow rate to the main system to account for the added acres of the corner arm.* This is accomplished by turning off some sprinklers on the main system as the arm extends. If successful, this would ensure that both water and chemical are applied at the same rate regardless of whether the corner is extended or not. The down side is that by turning off some sprinklers on the main system, water application uniformity is sacrificed for the main system. It is possible that the reduced uniformity may not affect yield, but the potential for yield impacts exists during heavy irrigation seasons.

Sprinkler Position

One goal of both chemical and water applications is that both be distributed as uniformly as possible. Recent sprinkler package developments have raised some concerns about the effect of nozzle position on water application uniformity. Research conducted in Kansas and Nebraska has demonstrated that nozzles positioned to operate within a corn canopy can lead to dry areas between adjacent nozzles. When positioned within 4 feet of the soil surface, the crop canopy intercepts the water application pattern to limit water application to an area within 5 to 10 feet from the nozzle. Reducing nozzle spacings to less than 7.5 feet is necessary to ensure uniform water and chemical application when nozzles operate in the corn canopy (Lamm, 1989, Yonts, et al., 2006)^{4,5}

Irrigation Systems

There are three basic types of irrigation systems:

- sprinkler
- surface
- drip or trickle

Sprinkler Systems

There are several types of sprinkler systems and most are well-suited for chemigation. The sprinkler systems include:

- center pivot
- self-propelled linear move
- solid set

- hand move lateral
- side roll lateral
- tow-line lateral
- hose drag traveler

This manual focuses mainly on chemigating with center pivot and linear sprinkler systems.

Center pivot, linear systems

Center pivot and linear systems are most commonly used for chemigation. When properly designed, calibrated and operated, they provide a high degree of water and chemical application uniformity.

Center pivots can have a high rate of water application near the outer portions of the circle. If the soil infiltration rate is exceeded, runoff of the chemical-water solution may occur. Therefore, a nozzle package should be selected to minimize runoff potential. Work with an irrigation system dealer, NRCS, or UNL Extension personnel to select a nozzle package to match the field and crop.

In some situations, the quantity of irrigation water applied with the agrichemical will be small enough that runoff may not be a major concern. The amount of water applied by a center pivot during one irrigation is determined by the irrigation pumping rate, system length and the revolution time of the center pivot system. The minimum irrigation amount will be applied when the system is operated at the maximum rotation speed. Consult your system operator's manual for specific system water application depth information.

Solid set, hand move, and tow lines

Each of these is a type of stationary sprinkler system. They differ from self-propelled systems in that they are set on a given area of the field and do not move while water is being applied. A limitation of hand move and tow line systems when used for chemigation is the potential for operator exposure to the chemical(s) being applied as the system is moved from one application site to the next. Another limitation of stationary systems is distortion of the water distribution by wind. Chemicals should not be applied through these systems if wind causes the spray to drift to nontarget areas.

Hose drag traveler

This type of system may be acceptable for chemigating when operated in low wind conditions. In general, travelers have poor application uniformity and susceptibility to wind drift limits their suitability for chemigating. Like the stationary systems, the hose and volume gun equipment present a risk of chemical exposure. These two factors make a hose drag traveler a poor system for use with chemigation.

Furrow Irrigation Systems

In general, furrow irrigation systems have limited potential for chemigation. Water distribution is typically nonuniform along the row. It is possible to get a substantially better distribution than the average, but it requires more time than many producers feel they can devote

to the effort. Further, since there is no possibility of foliar application, any chemigation would be limited to application of fertilizer solutions, most typically nitrogen.

More recently, the development of equipment and management guidelines for surge-flow irrigation has made it possible to obtain a more uniform water application in comparison to conventional furrow irrigation. With experience, it is possible to program surge valves to make relatively uniform water applications when field conditions are good. This has stimulated renewed interest in fertigating through surge irrigation. The question is whether surge can give consistently uniform water applications across a field, so the operator can have confidence that the fertilizer application is uniform from one end of the field to the other and from row to row.

The University of Nebraska has conducted research using surge irrigation to fertigate silt loam soils with good intake rates. The results have shown that when properly managed, the uniformity of water distribution under surge irrigation is clearly better than for typical furrow irrigation. However, point to point variation in infiltration along a row and from row to row raises serious questions about using fertigation in furrows as a standard practice to apply supplemental N. There was more non-uniformity in distribution from top to bottom of the field than would be desirable for fertilizer distribution. Not surprisingly, there also was a large difference in infiltration between wheel-track and non-wheel-track rows. Local infiltration variability related to soil condition resulted in substantially more infiltration of fertilizer materials at some points than others. In addition, there were row to row differences in infiltration and fertilizer distribution on rows that were presumably identical in terms of tillage and wheel track history.

Runoff of high-nitrate water is another concern during fertigation with any furrow irrigation system. It is possible to operate a surge system to obtain nearly zero runoff. However, research on medium textured soils in Nebraska has shown that this results in a nonuniform distribution along the furrow. Allowing some runoff to occur will usually provide a more even distribution along the row. This creates a problem of what to do with the high nitrate runoff water. If it goes to a reuse pit, it can become a point source of contamination. If it is held behind a dike at the end of the rows, it may result in areas of excessively high N application at the lower end of the field.

The University currently does not have research results on very fine textured soils such as silty clay loams, clay loams, etc. On soils with low intake rates, it may be easier to obtain a more uniform distribution along the row. However, the row-to-row variability because of compaction by tractor wheels, etc., and the issue of management of high nitrate runoff still remain as limiting factors.

Because research results show non-uniform application, and potential for ground water and surface water contamination by high nitrate runoff, fertigating through either conventional or surge irrigation in furrows is not recommended on medium- and coarse-textured soils. An exception is in emergency situations where weather or some other problem has kept machinery out of the field until the crop is too tall to get through with conventional equipment.

Drip or Trickle Systems

Drip or trickle irrigation consists of frequent, slow application of water to soils through emitters located at selected points along water delivery lines. Most drip lines are placed 12-16 inches below the ground (subsurface drip irrigation), but they can also be placed on the soil surface or suspended above the ground.

Most drip systems only apply water to a portion of the soil. While some emitters are able to apply water to a larger area using a spray nozzle style emitter, most systems are not designed to apply water uniformly to the entire crop canopy. Thus, drip systems usually are not suitable for broadcast or foliar applications.

Chemigation Equipment and Safety Devices

Equipment required to apply chemicals through an irrigation system includes:

- a chemical supply tank (with agitator)
- a chemical injection system
- a calibration tube
- required safety devices.

Chemical Supply Tank

To avoid potential reactions with chemicals placed in it, the chemical supply tank should be constructed of a corrosion resistant material such as stainless steel or sunlight resistant plastic. Some pesticide labels may include statements that the product should only be placed in a specific type of tank. Product labels also will include a warning if chemical interaction is a potential problem.

The tank should be designed to prevent any wind-borne foreign materials - dirt, leaves, crop residue - and rainwater from getting into the tank. It also should be completely drainable with a sump at the drain port for ease in rinsing. Accurate, easily readable gallon marks should be on the outside of the tank.

Agitation in the chemical tank is required with some pesticides (tank mixes, dry flowables, flowables, wettable powders, or any other suspended formulations). Hydraulic agitation may be sufficient for some soluble chemicals, while mechanical agitation may be necessary for other types of chemicals. *Refer to the product label for specific instructions.*

Chemical Injection System

A mechanically durable, reliable and accurate chemical injection system, specifically designed for chemigating, is essential. Like the chemical supply tank, wettable parts should be made from stainless steel or other non-reactive materials. To help ensure uniform applications, a delivery accuracy of plus or minus one percent is desirable within the minimum to maximum operating range. It also should be easily adjusted while running.

The operating range of the injection pump should be consistent with intended chemical application rates. These can range from an ounce per acre for some insecticides to as much as 50 gallons per acre for some fertilizers. Consequently, injection rates may need to range from as low as 0.2 gallons per hour to as much as 400 gallons per hour depending on the irrigated area. No single pump can do all jobs. Controls on most pumps are graduated in units or percentages which represent the amount of liquid pumped at a particular setting. However, these settings may not be exact. Avoid operating a pump at its maximum output or near its minimum output. Such usage can result in inaccurate pumping rates. Piston pumps, in particular, lose suction capabilities

proportionally as piston stroke length is reduced to pump smaller amounts. It always is best to operate the pump in the range from 10% to 90% of its rated capacity.

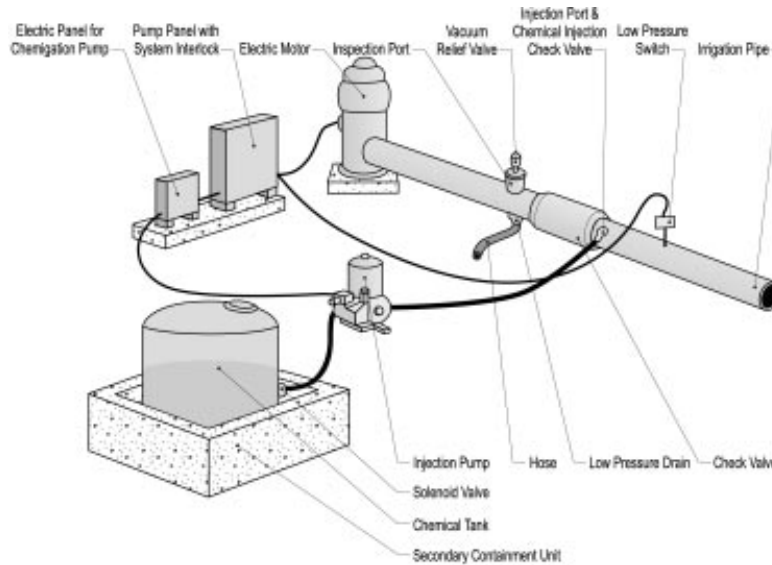

There are three main types of injection devices used to add chemicals to irrigation water. Chemicals may be injected by: 1) centrifugal pump, 2) positive displacement pump, or 3) pressure differential methods including venturi meters and water-driven pumps. The two main types of chemical injection pumps used in Nebraska are listed under the broad category of positive displacement pumps. In general, piston pumps are used to inject nitrogen fertilizers and diaphragm pumps are used to inject pesticides.

Piston pumps (figure 1) inject chemical into the irrigation water at a rate determined by the piston diameter, length of the stroke and the number of strokes per minute. Since the chemical pump is most often driven by an electric motor or the power take-off of the engine powering the water pump, the number of strokes per minute is nearly constant and determined by the installation. Piston pumps are calibrated by adjusting the length of the piston stroke. To do this the pump must be shut off. Consequently, accurate calibrations are somewhat tedious. Chemical or fertilizer comes into direct contact with the piston and seat allowing excessive wear and potential leakage to the environment. Moving parts, such as motor to gearbox coupling, eccentric arm, and plunger arm are generally exposed, creating danger to the operator and others.

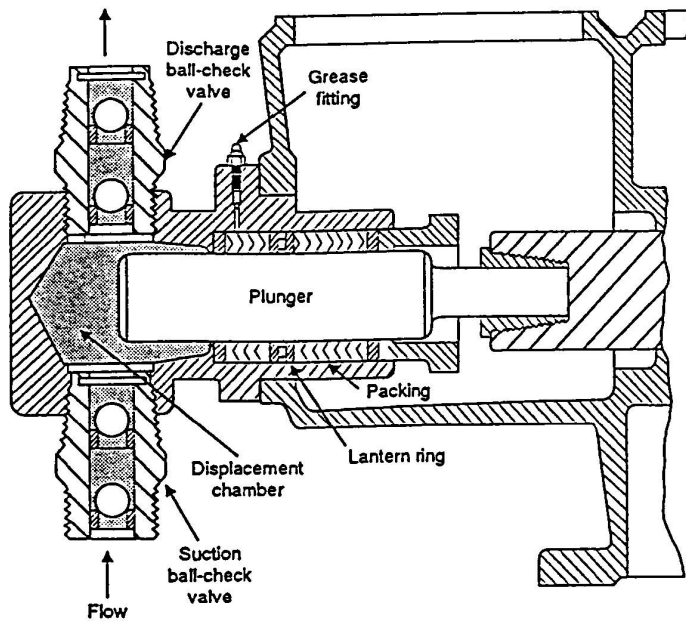

Figure 1. Cross-section drawing of the pump mechanism for a piston type chemical injection pump (Poynton, 1983).

Diaphragm pumps (figure 2) are so named because they have a membrane or diaphragm separating the drive mechanism from the product being pumped. The mode of action remains that of a positive displacement pump but the chemical being pumped is not in direct contact with the piston. The chemical(s) to be injected determines the diaphragm material that is selected. Selecting an appropriate pump diaphragm will eliminate leakage problems that are associated with piston pumps. Advantages of a diaphragm pump include: a) easier to calibrate by simply turning an adjustment dial, b) easier to achieve precise injection rates due to fine gradations on the dial, and c) easier to adjust injection rates because the system does not need to be shut off for adjustment.

Venturi meters (figure 3) use the difference between the inlet and outlet pressure of the meter to add chemical into irrigation water. As water passes through the throat of the meter, pressure energy is converted to velocity energy. In the process, a nearly perfect vacuum is developed at the throat. The vacuum creates a pressure differential that causes chemical to be forced out of the chemical supply tank into the bypass line. The chemical injection rate is varied by using a needle valve or orifice plate placed inline between the chemical supply tank and the meter. Systems with large pipelines place the venturi in a shunt or bypass line arrangement. To insure that the pressure in the bypass line is greater than the mainline pressure, a booster pump is installed in the bypass line. This eliminates the need for artificially creating a pressure differential by installing a throttling valve in the mainline.

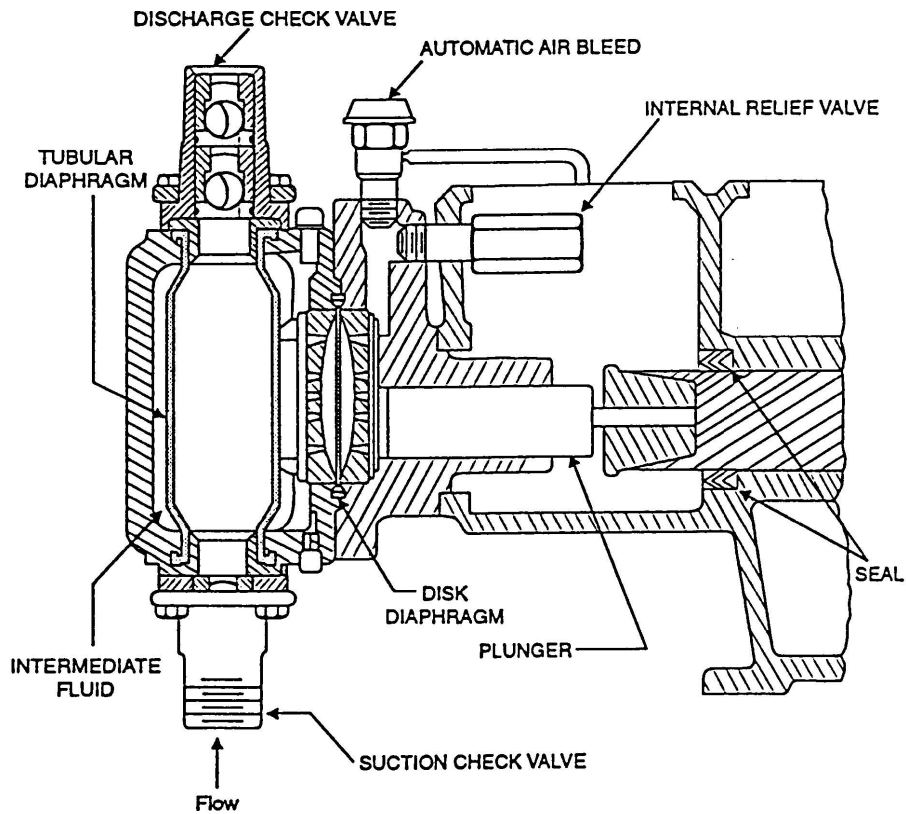

Figure 2. Cross-section drawing of the pump mechanism for a diaphragm type chemical injection pump (Poynton, 1983).

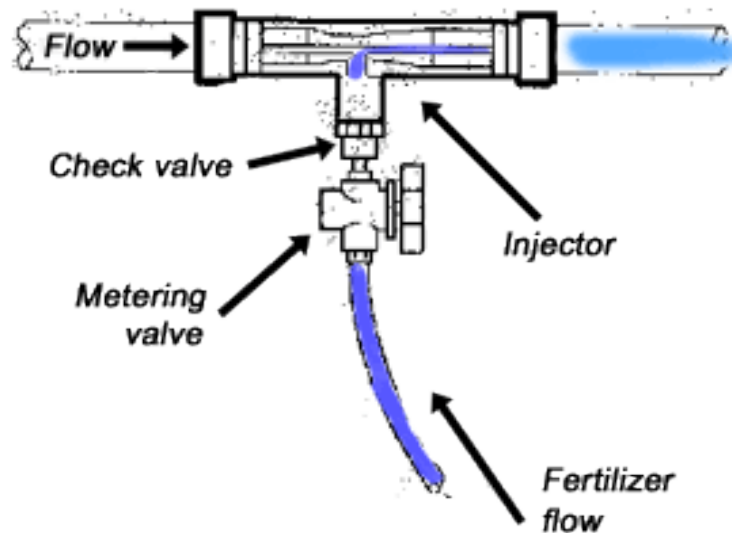

Figure 3. Schematic drawing of a venturi injector.

Venturi meters were primarily designed to operate in drip irrigation systems used for vegetable production and greenhouses. These systems typically have a water supply that can be maintained at a constant pressure. However, water pressure supplied to center pivots in Nebraska

varies because few fields are flat, end guns are used intermittently, and the pumping water level increases somewhat with pumping time. These factors cause the pipeline pressure to change, thus increasing or decreasing the chemical injection rate. Adding a booster pump greatly diminishes the effect of pressure differences on the injection rate, but, in general, the injection rate will vary depending on the pressure in the pipeline at the point of injection.

Calibration Tube

A calibration tube should be located in the chemical line between the chemical supply tank and the injection pump. It is used to measure output of the injection unit during calibration. It should be transparent for ease in viewing the liquid level, resistant to breakage, ultraviolet light (UV) stabilized (sunlight resistant), and graduated in units of volume (pints, ounces, milliliters, etc.). To properly calibrate an injection system, it is necessary to monitor the chemical injection rate for at least one minute and as long as five minutes. Therefore, calibration tubes must be large enough to hold the amount of chemical to be injected during that time. Capacity of the injection system will dictate the size of calibration tube. Fertilizer application will normally require a large 4000-5000 ml calibration tube while an insecticide should use a 1000 ml calibration tube.

Required Safety Devices

Whenever proper safety devices are not installed and maintained on chemical injection and irrigation equipment, there is potential for polluting the water supply. This problem has been addressed by industry, federal regulators and state lawmakers. Three specific hazards are of concern if no safety equipment is present:

1. an unexpected shutdown of the irrigation pumping plant due to mechanical or electrical failure while it is unattended, causing concentrated chemicals or a mixture of chemicals and water to backflow into the water supply;
2. an irrigation pumping plant shutdown while the injection equipment continues to operate, possibly causing concentrated chemical or a mixture of water and chemical to backflow into the water source, and/or cause an undesirably high concentration of chemicals in the irrigation pipeline; and
3. a chemical injection system shutdown while the irrigation pump continues to operate, possibly causing water to backflow through the chemical supply tank and overflow chemical on the ground.

The American Society of Agricultural Engineers in 1982 issued an Engineering Practice document, "Safety Devices for Chemigation," (ASAE EP409.1). It addressed chemigation in its broadest sense, i.e. injecting any liquid chemical - fertilizer or pesticide into an irrigation system. The document has been revised or reaffirmed several times, most recently in December 2013.

The U.S. Environmental Protection Agency, in its Pesticide Registration (PR) Notice 87-1, focused solely on pesticide applications. The document, dated, March 11, 1987, is directed at pesticide manufacturers whose product(s) are labeled for application by chemigation. The notice requires that container labels of such pesticides include statements listing the safety devices that must be in place for legal application of the product. Approximately two years later, the agency modified its requirements, providing a list of alternative chemigation safety equipment deemed to offer an equivalent level of protection.

Legislation of most states where chemigation is practiced, including, Nebraska, requires essentially the same safety devices and equipment mandated under EPA's Label Improvement Program. With a few exceptions, they parallel the ASABE recommendations. Safety devices and equipment needed in Nebraska are specified in the Nebraska Chemigation Act (Summary in Appendix A) and Title 195 of the Rules and Regulations of the Nebraska Department of Environment and Energy (NDEE) [Appendix B]. For the latest changes in Title 195, see the following URL: http://deq.ne.gov/RuleAndR.nsf/Title_195.xsp.

Safety devices and equipment required by the Nebraska Chemigation Act and NDEE's rules and regulations include:

1. *Irrigation pipeline check valve.* A check valve must be installed in the irrigation pipeline between the irrigation pump and the point of chemical injection into the irrigation pipeline to prevent water and chemical from draining or siphoning into the water source. NDEE regulations require that the valve body and all components be constructed of corrosion resistant materials or be coated or treated to prevent corrosion. It must contain a spring-loaded sealing mechanism designed to close prior to or at the moment water stops flowing in the downstream direction. ASABE adds that direction of flow should be clearly indicated on the outside of the device. It also must pass an Underwriters Laboratory, Inc. test for leakage (Appendix C). The check valve must be able to withstand for one minute a hydrostatic pressure double its rated working pressure without leakage at joints or at the valve seat. It also must be able to withstand for 16 hours an internal hydrostatic pressure equivalent to the head of a column of water five (5) feet high retained within the downstream portion of the valve body. A list of check valves certified by NDEE as meeting these requirements appear in Appendix D.

- Where system configuration and terrain are suitable, EPA regulations accept a gooseneck pipe loop downstream from the irrigation water pump as an alternative to having an irrigation pipeline line check valve and low pressure drain. The bottom side of the pipe at the loop apex must be at least 24 inches above the highest sprinkler or other type of water emitter. The loop must contain either a vacuum relief or combination air and vacuum relief valve at the apex of the pipe loop. The pesticide injection port must be located downstream of the apex of the pipe loop and at least 6 inches below the bottom side of the pipe at the loop apex.

In the 1989 revision of its ruling on mandatory chemigation safety equipment, EPA allowed the gooseneck pipe loop as an alternative to having an irrigation pipeline check valve and low pressure drain. NDEE, however, has not specifically included this alternative in Chapter 195 of its regulations. Contact your local NRD to ascertain whether this option can be used on your field site.

2. *Vacuum relief valve.* The vacuum relief valve must be located on top of the irrigation pipeline between the irrigation pump and the irrigation pipeline check valve (figure 4) to prevent a vacuum that could cause siphoning when the water flow stops. NDEE specifies that the vacuum relief valve should be at least 3/4 in. in diameter. Most systems have vacuum relief valves greater than 2-inches in diameter.

3. *Inspection port.* In most cases, the vacuum relief valve also serves as an inspection port. It is provided to check for malfunction of the irrigation pipeline check valve and low pressure drain. It must be sited between the irrigation pump and the irrigation pipeline check valve so that the inlet to the low pressure drain can be observed (figure 4). A minimum 4-inch diameter opening is required for the inspection port.

4. *Low pressure drain.* The low pressure drain must be installed on the bottom of the horizontal pipe between the irrigation pump and the irrigation pipeline check valve. The drain must, in all instances, be located on the irrigation pipeline before the point of chemical injection. The drain must be constructed of corrosion resistant material, or coated to prevent corrosion, and must be installed at or below the bottom of the pipe. The drain opening must be at least $\frac{3}{4}$ -inch in diameter and open automatically when water flow stops. In addition, a hose or conduit $\frac{3}{4}$ -inch or greater in diameter must be attached to the low pressure drain and the outlet must be at least 20-feet from the irrigation well or water source.

- ASABE further recommends that the drain have a closing pressure of at least 1 psi but not exceeding 5 psi. They also recommend grading the soil surface, if necessary, to ensure that drainage is carried at least 20 feet from the irrigation water source. In the event that the mainline check valve leaks slowly, this drain will ensure that the solution will drain away from, rather than toward, the well or other water source.

5. *Chemical injection line check valve.* A check valve must be installed in the chemical injection line between the chemical injection pump and the chemical injection port on the irrigation pipeline. Its purpose is two fold: 1) to prevent gravity flow from the chemical supply tank into the irrigation pipeline, and 2) to prevent irrigation system water from flowing into the chemical supply tank causing an overflow. To help achieve these objectives, it is recommended that the injection port and check valve be placed in the irrigation pipeline *above* the liquid level in the chemical supply tank; an ideal location is in the upright column of the pivot. Nebraska regulations require that the valve be constructed of chemically resistant materials and designed to have a minimum opening (cracking) pressure of 10 psi (69 kPa).

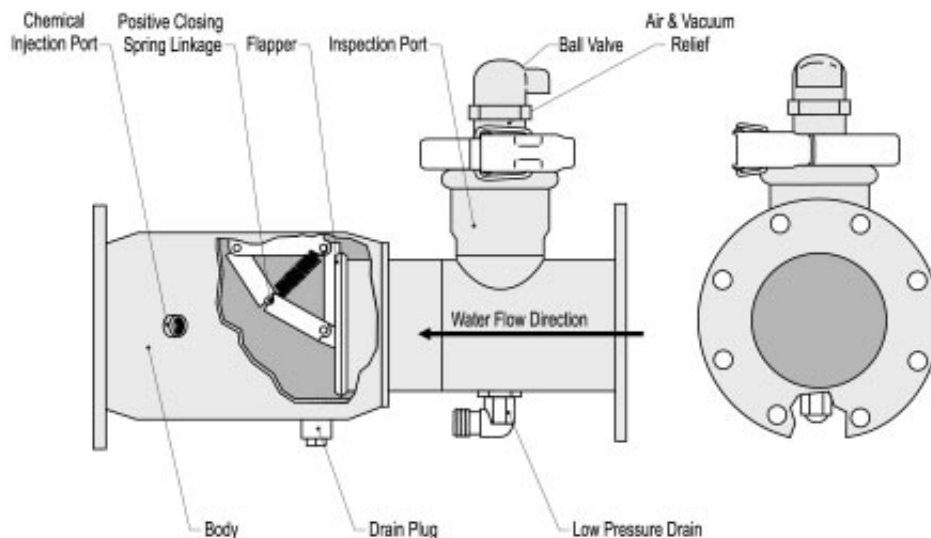

Figure 4. Schematic drawing of typical irrigation pipeline check valve.

As an alternative to meeting the opening pressure requirement, Nebraska regulations allow a vacuum relief valve to be placed in the chemical injection line between the injection pump

and the chemical injection line check valve. The vacuum relief valve must: 1) be constructed of chemically resistant materials; 2) open at atmospheric pressure; 3) be at an elevation greater than the highest part of the chemical supply tank; and 4) be the highest point in the injection line.

Pesticide labels include requirements for a normally closed solenoid valve between the chemical supply tank and the chemical injection device. EPA's List of Alternative Chemigation Safety Equipment (March 22, 1989) approves three alternative devices in lieu of a normally closed solenoid valve:

1. *“Functional spring-loaded check valve with a minimum of 10 psi cracking pressure. The valve must prevent irrigation water under operating pressure from entering the pesticide injection line and must prevent leakage from the pesticide supply tank on system shutdown. This valve must be constructed of pesticide resistant materials. [Note: this single device can substitute for both the solenoid-operated valve and the functional, automatic, quick closing check valve in the pesticide injection line.] **Nebraska’s Chemigation Act requires this check valve.***
2. *“Functional normally closed hydraulically operated check valve. The control line must be connected to the main water line such that the valve opens only when the main water line is adequately pressurized. This valve must prevent leakage from the pesticide supply tank on system shutdown. The valve must be constructed of pesticide resistant materials.*
3. *“Functional vacuum relief valve located in the pesticide injection line between the positive displacement pesticide injection pump and the check valve. This alternative is appropriate only for those chemigation systems using a positive displacement pesticide injection pump and is not for use with venturi injection systems. This valve must be elevated at least 12 inches above the highest fluid level in the pesticide supply tank and must be the highest point in the injection line. The valve must open at 6 inches water vacuum or less and must be spring loaded or otherwise constructed such that it does not leak on closing. It must prevent leakage from the pesticide supply tank on system shutdown. The valve must be constructed of pesticide resistant materials.”*
6. *Simultaneous interlock.* Nebraska regulations require the irrigation pumping plant and the chemical injection pump to be interlocked so that if the pumping plant stops, the injection pump also will stop. This will prevent pumping chemicals into the irrigation pipeline after the irrigation pump stops.

On systems with an engine-driven irrigation pump, the chemical injection pump can be belted to the drive shaft or an accessory pulley of the engine. Another alternative includes operating the injection equipment using power generated by the pumping plant power unit. These types of installations are directly interlocked so that the injection device operates only when the irrigation pumping plant is operating.

SAFETY NOTE:

Never operate an irrigation pump from a stationary power plant without a drive shaft shield between the engine and irrigation pump. See ASABE Standard S318.17, *Safety for Agricultural Field Equipment (June, 2009)*, for shielding recommendations.

When the irrigation pump is powered by an electric motor, a separate electric motor usually powers the chemical injection pump. Electric controls for the irrigation pump, irrigation distribution system, and injection pump should be wired so that all three shut down if any one of the three fails.

Some agricultural chemicals have relatively low flash points making them very flammable. In such cases, wiring must conform to the National Electrical Code requirements specified for hazardous area applications. Check chemical labels for specific requirements.

Additional Safety Measures

As part of their “special use precautions,” some pesticide labels will include a requirement that there be a functional pressure switch in either the irrigation line or the water pump that will stop the water pump motor whenever water pressure decreases to the point that it would adversely affect the pesticide distribution.

Two points are important. 1) It is essential to read all parts of the product label completely before chemigating with a pesticide. 2) Pesticide labels have the force of law; any deviation from label provisions constitutes misuse of a pesticide and subjects the violator to potential prosecution.

The American Society of Agricultural and Biological Engineers also recommends that several additional safety measure be implemented:

- 1) Provide a fresh water source near the chemical supply tank and injection pump for washing off any chemicals that contact the skin. The fresh water outlet from the irrigation system must be located between the irrigation pipeline check valve and the water supply. It should never be used as a port for injecting any agricultural chemical, nor should it be used as a source of drinking water. To minimize potential for skin contact, protective goggles, face shields, and chemical-resistant clothing should be worn when making chemical dilutions. Concentrated chemicals should generally be added to water in preparing dilutions in a chemical supply tank unless directions specify otherwise.
- 2) A strainer should be installed between the chemical supply tank and the injection pump to prevent clogging of the injection pump, check valve, or other equipment. The mesh size of the strainer will be dependent on the type of chemical being injected. For most chemicals, a 50-mesh screen should be used. This device should be inspected before and after each use.
- 3) Locate all chemical supply and mixing tanks, injection pumps, etc. a safe distance from potential sources of electric arc or spark to reduce the explosion hazard caused by the flammability of some chemicals.
- 4) The surface topography in the vicinity of the well or water source should be graded so that any spilled chemical drains away from, rather than toward, the water supply.
- 5) All equipment and accessories, including hoses, seals, gaskets, etc., that come in contact with chemical mixtures must be resistant to all formulations of agricultural chemicals being applied, including emulsifiers, solvents, and other carriers in addition to the active ingredient.

The equipment and measures described above will provide, in most cases, an acceptable level of operator safety as well as protect against contamination of the irrigation water source. However, if your irrigation water source is near a municipal well field, additional antipollution protection equipment may be required. In such cases, contact your Natural Resources District or the Nebraska Department of Environment and Energy.

Management

One disadvantage of chemigation, though it is a relatively minor one, is that it requires management. Anytime a chemical is applied through an irrigation system, several steps must precede as well as follow the application.

Most chemigation-related chemical accidents are the result of careless practices, poor selection of chemigation equipment, or lack of knowledge on how to handle chemicals safely. Time spent taking precautionary safety measures is an investment in the health and safety of yourself, your family and others, and in protecting the environment. It also helps assure that desired results are achieved.

Read, Comply With Product Label

If you plan to apply a pesticide, *always read the product label* before starting to chemigate and comply with all directions given. Ensure that:

1. the product is labeled for application by chemigation (some product labels may include a statement prohibiting use through any irrigation system);
2. the crop on which you plan to apply the pesticide is listed on the label;
3. the rate at which the product is applied does not exceed quantities or frequency specified;
4. all items of personal protective clothing and equipment (PPE) specified are used;
5. empty pesticide containers are triple rinsed and recycled or disposed of as directed;
6. restricted entry intervals are observed.

Equipment Maintenance and Inspection

Among the most frequent causes of chemical spills in Nebraska have been hose ruptures, hose clamp failures, and leaking connections - all defects that an adequate pre-operation inspection should detect. To help ensure safe chemigation events, equipment must be maintained properly. All hoses, clamps and fittings must be in good repair. It is strongly recommended that all chemical injection line hoses and clamps be replaced annually. Inspect them for deterioration before each chemigation operation.

All components that are in contact with chemicals, from the supply tank to the point of injection on the irrigation pipeline, should be constructed of chemically resistant materials.

Before chemigating, inspect equipment to be certain that the following items are functioning properly:

- the irrigation system main pipeline check valve and vacuum relief valve;
- the low pressure drain (also check drain hose for proper connection and breakage and ensure that it is draining to the desired location);
- the chemical injection line check valve;
- the irrigation system and pumping plant main control panel and the chemical injection pump safety interlock;
- the injection system including the in-line strainer;
- the irrigation pump and power source.

Plug First Nozzles on Center Pivots

To facilitate monitoring of the chemigation operation, the main control panel, water pump, chemical supply tank, chemical injection pump and the area around them must be kept free of chemical contamination. Plugging the nozzle outlets in the immediate area of this equipment will significantly reduce the possibility of inadvertent exposure to chemical contamination.

Personal Protective Clothing and Equipment

Pesticides by definition are products that are toxic, some more so than others. These products also pose some degree of threat to human health as well. Depending on the relative toxicity of the pesticide and the type of formulation, applicators and handlers normally need some type of personal protective clothing and equipment (PPE).

The *relative toxicity* of a pesticide is indicated on the product label by a “signal word.” Those labeled “CAUTION” are least toxic; those labeled “WARNING” are more toxic; those labeled “DANGER” are most toxic.

Chemicals can enter the human body by any of three “routes of entry:”

1. through the mouth (orally),
2. absorption through the skin (dermally), or
3. by breathing into the lungs (inhalation).

“*Route of entry statements*,” therefore, appear on the label to indicate actions a user must take to avoid exposure. Here are some examples of these statements: “May be fatal if swallowed. Harmful if absorbed through skin. Avoid breathing vapor or spray mist. Do not get in eyes, on skin, or on clothing.”

Ordinarily the label next lists the specific items of protective clothing, personal protective equipment, and footwear (PPE) that must be used. The applicator is legally responsible for using all safety equipment and protective clothing listed. In general, the more toxic the pesticide, the greater the need for protective clothing and/or equipment.

Based on the example statements listed above, the product label would include PPE requirements such as: “Applicators and other handlers must wear: coveralls over short-sleeved shirt and short pants, chemical-resistant gloves such as Barrier Laminate or Viton, chemical-resistant shoes plus socks, protective eyewear, chemical-resistant headgear for overhead exposure, chemical-resistant apron when cleaning equipment and mixing or loading.”

Accidental Spills

One of the most frequent causes of accidental spills is rupture of a chemical supply tank. Liquid fertilizer tanks, in particular, are often constructed of molded plastics or fiberglass. “Weathering” of these tanks over time tends to stress seams where the sections have been joined, and eventually the tank fails.

When a tank ruptures there are several consequences:

- The producer loses several hundred gallons of valuable fertilizer.
- The area onto which the product flows becomes contaminated. All contaminated soil must be excavated and disposed of, usually by spreading in an agronomically acceptable manner on nearby crop land.
- The incident must be reported (see details below).
- The spill may represent a threat to ground water beneath the spill site or nearby surface water sources.

To prevent such incidents, *it is strongly recommended that secondary containment be provided.*

Nebraska Department of Environment and Energy rules and regulations on secondary containment appear in Title 198 (June, 2011). A summary of those rules is included in this manual as Appendix F.

If a spill occurs, apply the four “C’s:”

- **Control** — plug the hole, return the tank to the upright position, or such other corrective action as may be necessary;
- **Contain** — dike the area with soil, or apply absorbents; avoid letting chemical flow away from the spill site into any surface water source;
- **Contact** --- call the NRD and NDEE immediately;
- **Clean up** — special precautions, such as removing the contaminated soil, may be necessary to prevent ground water contamination.

Regardless of the size of the spill, 1) avoid getting the chemical on your skin, clothing or shoes, especially if it is a pesticide; 2) keep persons, especially children, away from spills; 3) keep potential spill damage to a minimum.

Under provisions of the Nebraska Chemigation Act, “actual or suspected” accidents, such as spills, are to be reported to the Nebraska Department of Environment and Energy (402-471-2186) and the local Natural Resources District within 24 hours of discovery. Accidents that occur after normal working hours (8 a.m.-5 p.m.) are to be reported to the Nebraska State Patrol (402-471-4545). All information available about the accident at the time of discovery must be reported, such as time of occurrence, type and quantity of material, location, and any corrective or cleanup actions that have been or are being taken. Failure to report an accident subjects violators to a fine of up to \$5000, or a Class III misdemeanor.

Monitoring

During any chemical application, periodically monitor the irrigation system and chemical injection equipment to be certain that both are operating properly. Check the wind speed and direction periodically to ensure that wind drift will not transport chemical to a nontarget area.

Avoid Nontarget Application

Ground, Surface Water: Certain conditions may preclude chemigating. For example, if there is an uncapped abandoned well, flowing water in a creek channel or a wetland within the target area, chemigation would not be a legal option. Any person who contaminates ground water or applies an agricultural chemical to permanent or semi-permanent surface water areas, violates state as well as federal law and is subject to prosecution.

End Guns: End gun shutoffs that fail to function and unfavorable weather conditions are among the common sources of nontarget or off-target applications. **The use of end guns during chemigation is *not* recommended.** Ordinarily end guns operate intermittently. As they turn on and off, the operating pressure of the system changes resulting in a nonuniform chemical application.

Spray Drift: Spray from continuous move irrigation systems can be carried considerable distances by wind. Drift can result in violations of the law for misapplication of a pesticide and illegal pesticide residues in or on a crop. It also can damage your own or a neighbor's nontarget crops.

Wind variation also can have a detrimental effect on other types of sprinkler systems such as solid set, hand move laterals, side roll laterals, and tow-line laterals. To minimize problems associated with wind drift, these steps can be taken:

- avoid use when winds are strong enough to cause significant drift (10 mph or greater);
- space the sprinklers and lines more closely together, if possible;
- operate at night when winds are relatively calm.

Runoff—Deep Percolation

The irrigation system should be managed so that runoff or deep percolation of the water-chemical mixture does not occur. If runoff does occur within the field, precautions should be taken to prevent runoff from leaving the field when chemical is being applied. With a given sprinkler package on a center pivot, reducing the application depth by making a faster revolution will reduce the potential for runoff and deep percolation. Good irrigation management practices must be used throughout the entire irrigation season to avoid movement of water below the crop root zone and with the potential for chemical leaching.



Surface runoff from a field with little crop residue cover

Flush Injection Equipment and Irrigation System

To prevent accumulation of precipitates, flush the injection system for at least 10 minutes with clean water after use. Flush the injection system while the irrigation system is still operating so that the water used for cleaning will be applied to the field where the chemigation application was made.

After injection is completed, operate the irrigation pump for at least 10 minutes to flush the irrigation system of any chemical. Some systems, especially drip systems, may take longer than 10 minutes to flush completely.

Calibration Procedures

The objective of each chemigation event is to apply the amount of chemical specified on the product label. Accurate calibration of the chemical injection system is critical. Without calibration there is no way to determine whether the amount of chemical applied is too much, too little or, by chance, just right. Over application is needlessly expensive and if a pesticide is over-applied, the person responsible can be prosecuted for misuse of the pesticide. Under-application frequently does not provide the desired effect. See the chapter on Calibration Procedures for additional information.

Calibrating a chemigation system is not difficult. It requires some time, simple equipment and accurate calculations. Do not rely solely on data provided by the manufacturer. Manufacturer's suggestions can eliminate the need for much trial and error, but in-field conditions do not necessarily match factory test sites. Nebraska research has proven that injection pumps with the same model number can deliver significantly different chemical injection rates. The same research found that injection rates were significantly impacted by the operating pressure of the irrigation system. Consequently, the only way to be sure that the injection rate is appropriate is to calibrate the injection pump for the current operating conditions.

Equipment Needs

Measuring equipment includes: a stopwatch, a measuring wheel or tape (preferably 100 ft), a pocket calculator, and marking flags or stakes large enough to be seen easily at a distance.

Calibration is a procedure to determine the amount of chemical that is applied to a given area during a predetermined amount of time. For convenience - and *accuracy* - many chemical injection systems are sold with a calibration tube installed. Ordinarily it is a cylinder, graduated in units of volume, installed in the chemical injection system between the chemical supply tank and the chemical injection pump. The calibration tube should be clear, sunlight and breakage resistant, and hold enough chemical to inject for a minimum of five (5) minutes.

Though not nearly as accurate as a calibration tube, a pressure relief/regulating valve also can be used for calibration. This valve can be used for "rough" calibrations of pump output by installing it on the end of the injection/metering pump output hose, setting the pressure equal to the irrigation line pressure at the point of injection and directing the output volume into a measuring container for a specific time period. This method is superior to open discharge pumping into a catch basin because pressure is maintained against the pump.

General Procedures

The injection equipment and safety devices required for applying agricultural chemicals through all types of irrigation systems are similar, as are the calibrating procedures. In general, it is necessary to determine the:

1. wetted area to be treated in acres,
2. total amount of chemical required, (in gallons)
3. time required to treat the area, (in hours)
4. chemical injection rate per hour,
5. calibration setting on the chemical injection pump.

Specific procedures will be outlined for calibrating center pivot, stationary sprinkler, and drip or trickle systems.

Calibrating a Center Pivot System

The calibration process is based on the given measurements of the irrigation system (length, end gun wetting area, etc.), some common mathematical constants and conversions, and the desired rate of chemical application. The following example illustrates the procedure.

1. *Determine the area to be treated in acres:*

The simplest case is a complete circle without intermittent end guns or corner watering systems. The formula is:

$$\text{Wetted area of the center pivot (ac)} = \pi \times \text{WR}^2 \div 43560 \text{ sq ft/acre}$$

Where **WR** = the wetted radius (pivot length in feet plus effective throw of end gun, if used) and

Assume: $\text{WR} = 1300 \text{ ft}$
 $\pi = 3.14$

Wetted area: $= 3.14 \times 1300^2 \div 43560$
 $= 3.14 \times 1300 \times 1300 \div 43560$
 $= \mathbf{122 \text{ acres}}$

Determining irrigated area is more complex for partial circles, irregularly shaped fields, circles with intermittent end guns and other atypical situations. Methods for determining area in many of these situations are presented in Appendix E.

In most cases, it may be wise to leave the end gun off because the water pattern is easily distorted by wind. In addition, if an end gun shut off fails, an off-target application may result. *Finally, remember that when the end gun is turned off, the area treated is less and consequently the amount of chemical applied per acre will change if a constant rate injection pump is used add chemical to the distribution system.*

2. Determine the total amount of chemical required to treat the area.

$$\text{Total amount chemical required} = \text{acres treated} \times \text{application rate/acre}$$

Assume that 12 gallons of 28% UAN solution will be applied per acre.

$$\begin{aligned} \text{Chemical required} &= 122 \text{ acres} \times 12 \text{ gal/acre} \\ &= \mathbf{1464 \text{ gallons of 28\% UAN}} \end{aligned}$$

3. Time required to treat area in hours:

Time required to treat the area is the amount of time needed for the pivot to make one complete cycle or revolution.

Travel speed of any moving system, pivot or linear, must be measured accurately. For center pivots, the percent timer setting determines the percent of a minute the last tower moves. So for a percent timer setting of 20%, the last tower will move for 12 seconds out of each minute. When measuring the irrigation system travel speed it should be running “wet” (with water) at the speed and pressure that will be used while chemigating. If the system speed setting is changed or the irrigation pump engine throttle is adjusted, always recalibrate. Avoid determining pivot speed at one percentage setting and mathematically calculating the pivot speeds for other settings, other than to obtain a “rough” figure.

Wheel slippage can vary considerably from one percentage setting to another. In addition, travel speed is affected by wheel track depth so it is a good idea to record travel speed at the beginning, middle and end of the growing season.

Two measurements, **time** and **distance**, are required to calculate the travel speed of the pivot. The measurements can be taken in two ways:

- 1) record the time necessary for the outer pivot tower to travel a premeasured distance (usually a minimum of 50 ft.), or
- 2) measure the distance traveled by the outer pivot tower in a preselected time (usually a minimum of 10 minutes).

The end result of either method is travel speed in ft/minute. **Note:** *a measurement error of only a few feet or a few minutes can result in a significant error in the calibration process.* If the percentage timer is set at less than 100% when determining pivot speed, take the beginning and end time measurements at the same points in the move/stop cycle of the pivot. Measurements taken over greater distances or for longer times also will improve accuracy. If the terrain is rolling, check rotational speed at several locations in the field and calculate the average value. It also is wise to verify rotational speed several times throughout the season to account for differences in wheel track resistances due to cover, soil compaction and wheel track depth.

The first step in determining the treatment time is to determine the system travel speed by monitoring the outer pivot tower. In this example we will use Method 2 described above.

Travel speed = distance traveled ÷ elapsed time.

*Assume: Distance traveled = 20 ft
Time required = 10 min*

$$\begin{aligned}\text{Travel speed} &= 20 \text{ ft} \div 10 \text{ min} \\ &= \mathbf{2.0 \text{ ft/min}}\end{aligned}$$

Travel speed, along with distance around the outside wheel track, become the basis for determining the amount of time needed for the pivot to make one complete cycle (revolution). Circumference of the last wheel track and pivot travel speed are the two measurements needed to calculate revolution time. Circumference is calculated by the formula:

Circumference of the last wheel track = $2 \times \pi \times r$

Where: **r** = the distance from the pivot point to outside wheel track in feet.

*Assume: r = 1280 ft
 $\pi = 3.14$*

$$\begin{aligned}\text{Circumference} &= 2 \times 3.14 \times 1280 \text{ ft} \\ &= \mathbf{8038 \text{ ft}}\end{aligned}$$

The sprinkler package printout will list the system length and distance between the pivot point and each sprinkler and tower position, including the last tower. The length required for this calculation is from the pivot point to the last wheel track. It does not include the overhang. If the original system information is not available, it is a good idea to accurately measure this distance with a wheel or measuring tape once and permanently record it in the control panel.

Revolution time is calculated by dividing the circumference of the last wheel track in feet by the travel speed in feet per minute.

Revolution time = circumference (feet/rev) ÷ travel speed (ft/min)

$$\begin{aligned}\text{Revolution time} &= 8038 \text{ ft/rev} \div 2.0 \text{ ft/min} \\ &= \mathbf{4019 \text{ min/rev}}\end{aligned}$$

To convert the revolution time to hours, divide the above answer by 60.

$$\begin{aligned}\text{Revolution time (hrs)} &= 4019 \text{ min/rev} \div 60 \text{ min/hr} \\ &= \mathbf{67 \text{ hr/rev}}\end{aligned}$$

It is a good chemigation management practice to record the revolution time of several irrigation events and store the percent timer settings and revolution times in the control panel for reference. Since each revolution includes a hundred or so potential revolution time measurement locations, each revolution provides a very accurate measurement of travel speed.

4. *Chemical injection rate (per hour):*

The injection rate is the total amount of chemical needed to treat the field (Step 2) divided by the revolution time in hours (Step 3).

Chemical injection rate, (gal/hr) = total chemical needed (gallons) ÷ hours/revolution

$$\begin{aligned}\text{Injection rate} &= 1464 \text{ gal} \div 67 \text{ hr/rev} \\ &= \mathbf{21.8 \text{ gph}}\end{aligned}$$

5. *Calibration of the chemical injection pump:*

Knowing the chemical injection pump capacity in relation to the delivery rate needed can help establish an initial pump setting. To determine an initial (or estimated) chemical injection pump setting, the desired injection rate is divided by the pump's rated or maximum capacity.

Assume that the pump's maximum injection rate is 60 gph.

$$\begin{aligned}\text{Estimated pump setting} &= 21.8 \text{ gph} \div 60 \text{ gph} \\ &= \mathbf{0.36 (36\%)}\end{aligned}$$

Thus 36% is the suggested first setting for the initial calibration attempt. Increase or decrease the injection rate based on the quantity of chemical pumped from the calibration tube at 1 minute intervals. If the calibration tube scale is expressed in milliliters or ounces, it will be necessary to convert gallons per hour (gph) to that scale. To make this conversion, multiply the injection rate in gph by one of the following constants:

$$\mathbf{\text{gph} \times 63.07 = \text{milliliters/minute (ml/min)}}$$

$$\mathbf{\text{gph} \times 2.133 = \text{ounces/minute (oz/min)}}$$

1. If calibration tube scale is in milliliters:

$$21.8 \text{ gph} \times 63.07 = \mathbf{1375 \text{ ml/min}}$$

2. If calibration tube scale is in ounces:

$$21.8 \text{ gph} \times 2.133 = \mathbf{46.0 \text{ oz/min.}}$$

The application rate expressed in *ml/min* or *oz/min* becomes the injection rate at which the chemical injection pump must be set to achieve the desired chemical treatment.

Chemicals vary in viscosity and density. Always make the final calibration with the chemical to be injected and at the operating pressure of the irrigation system. When the desired injection rate has been bracketed, check the final adjustment by continuing to pump from the calibration tube over an extended period - at least 5 minutes.

There are some other points to bear in mind in calibrating a chemical injection pump. First, remember that book output values of chemical injection pumps are normally measured at the factory based on using a specific drive shaft speed. Any variance from the tested shaft speed will alter the pump output. Chemical injection pump wear also will alter output. When the chemical injection pump is belt driven from the drive shaft of the engine powering the irrigation pump, a tachometer is helpful.

Calibrating a Stationary Sprinkler System

Solid set, hand lines, and wheel lines are examples of stationary irrigation systems that can be used for applying agricultural chemicals.

An advantage of the stationary system is being able to inject the chemical anytime during the irrigation process. A herbicide may be injected midway through the irrigation process to allow additional water to be applied for incorporation. A foliar insecticide, in contrast, will usually be applied near the end of the irrigation to limit the amount of water that is applied following the insecticide application to reduce wash off.

Here is an example of one way to calibrate a stationary sprinkler system for a fertilizer application.

1. *Determine the acres to be irrigated in one set.*

Multiply the lateral spacing along the main line by the length of the lateral and divide by 43,560 (square feet per acre). If more than one lateral is being operated simultaneously, also multiply by the number of laterals.

Assume that each set of the irrigation system has 10 laterals that are 800-foot long and spaced 40 feet apart.

$$\begin{aligned}\text{Area irrigated} &= \text{length (ft) x spacing (ft) x number of laterals} \div 43560 \text{ (sq ft/acre)} \\ &= 800 \text{ ft x } 40 \text{ ft x } 10 \div 43560 \text{ sq ft/acre} \\ &= \mathbf{7.3 \text{ acres}}\end{aligned}$$

2. *Determine the total amount of 28% UAN solution needed to treat the field.*

$$\text{Total amount chemical required} = \text{acres treated x application rate/acre}$$

Assume that 12 gallons of 28% UAN solution per acre.

$$\begin{aligned}\text{Chemical required} &= 7.3 \text{ acres x } 12 \text{ gal/ac} \\ &= \mathbf{87.6 \text{ gallons}}\end{aligned}$$

3. *Determine the depth of water to be applied during the application.*

Assume that 1.0 inch of water will be applied and that the nitrogen solution will be injected during the first half of the irrigation period.

4. *Determine the rate of water application by the irrigation system.*

Attach a short piece of hose to the nozzle outlet(s) of one sprinkler, start the irrigation system, and measure flow for 1 minute. Repeat this procedure at several sprinklers along the lateral and determine the average sprinkler flow rate. Given the sprinkler flow rate in gallons per minute and the spacing between sprinklers and spacing between sprinkler laterals, the water application rate in inches per hour can be determined from application rate tables or with the following equation:

$$\text{Water application rate (in/hr)} = [96.3 \times q_s] \div [S_1 \times S_m]$$

where:

- 96.3 = conversion coefficient
- q_s = flow rate from each sprinkler, gallons per minute
- S_1 = spacing between sprinklers on lateral, feet
- S_m = spacing between laterals on mainline, feet

Assume:

- Sprinkler flow rate = 4 gpm
- Sprinkler spacing = 40 ft
- Lateral spacing = 40 ft

$$\begin{aligned} \text{Application rate} &= [96.3 \times 4 \text{ gpm}] \div [40 \text{ ft} \times 40 \text{ ft}] \\ &= \mathbf{0.24 \text{ in/hr}} \end{aligned}$$

Water application rate also can be determined from the sprinkler manufacturer's application rate table. This method requires knowing the size of the sprinkler nozzles (usually stamped on the nozzle) and discharge pressure, then using these data to enter the application rate table. Adjust the irrigation time to apply the amount of water necessary for proper chemical application.

5. *Determine the time required for a net water application of 1.0 inch.*

First, divide the net depth of water to be applied (1.0 inch) by the rate of water application (Step 5).

$$\text{Gross irrigation depth (in)} = \text{net irrigation depth (in)} \div \text{irrigation efficiency.}$$

Assume:

- Net irrigation = 1.0 in
- Irrigation application efficiency = 80%

$$\begin{aligned} \text{Gross irrigation depth} &= 1.0 \text{ in} \div 0.8 \\ &= \mathbf{1.25 \text{ in}} \end{aligned}$$

Then calculate the irrigation time to apply the gross irrigation depth.

$$\text{Irrigation time} = \text{Gross irrigation (in)} \div \text{Water application rate (in/hr)}$$

$$\begin{aligned} \text{Irrigation time} &= 1.25 \text{ in} \div 0.24 \text{ in/h} \\ &= \mathbf{5.2 \text{ hours}} \end{aligned}$$

6. *Fill the solution tank with 88 gallons of 28% UAN solution for each irrigation set (Step 2).*
7. *Determine the chemical injection rate.*

Divide the total gallons to apply (Step 2) by the injection time required to apply the chemical.

Chemical injection rate (gph) = total chemical required (gal) ÷ injection time (hr)

Assume that UAN solution will be applied for the last 2.5 hours of the irrigation time.

$$\begin{aligned}\text{Injection rate} &= 87.6 \text{ gal} \div 2.5 \text{ hrs} \\ &= \mathbf{35 \text{ gph}}\end{aligned}$$

8. *Calibrate the delivery rate of the injection pump to make certain the rate is correct.*

If chemical solution is to be applied throughout or during the last part of the irrigation, allow the irrigation system to operate long enough after the injection to completely flush the chemical from the system. The time required will normally be a minimum of 10 minutes and may be as long as 15 to 20 minutes.

Calibrating a Drip or Trickle System

To calculate the amount of chemical to apply per acre through a drip system, the lateral movement of water from the emitter must be measured. But, because the pattern of water movement is often irregular, it is difficult to calculate the area irrigated.

A more workable method is to apply solutions of a known chemical concentration for a definite period of time. The amount of chemical in solution is expressed in parts per million (ppm). For this example we will use a 170 ppm 28% UAN solution. Injection will occur for 6 hours. Based on the system design, each set or zone of the field will contain several acres.

To calibrate a drip irrigation system and injection pump, do the following:

1. *Determine the gallons of water being delivered per hour per acre by the drip system.*

Collect the water from 10 randomly selected emitters for a given period. If a short time period is used, water volume measurements must be very accurate made since the amount of water will be small. Calculate average flow per emitter and convert to the flow rate per hour per emitter. The amount of water delivered per acre can then be calculated by multiplying the number of emitters/acre by the flow rate. For subsurface drip irrigation systems, use manufacturer's published flow rates or use a flow meter to record the water flow rate over a larger area.

Assume: Average flow rate for 10 randomly selected emitters was 0.6 oz/min.

$$\begin{aligned}\text{Average flow rate} &= 0.6 \text{ oz} \times 60 \text{ min/hr} \div 128 \text{ oz/gal} \\ &= 36 \text{ oz/hr} \div 128 \text{ oz/gal} \\ &= \mathbf{0.28 \text{ gal/hr}}\end{aligned}$$

Assume there are 8712 emitters per acre and each emitter delivers 0.28 gallon per hour.

The system flow rate per acre irrigated is calculated by multiplying the number of emitters by the average flow rate per emitter in gallons per hour.

System flow rate = number of emitters x average flow rate

$$\begin{aligned}\text{System flow rate} &= 8712 \times 0.28 \text{ gal/hr} \\ &= \mathbf{2440 \text{ gal/hr/ac}}\end{aligned}$$

2. *Determine the weight of the water applied.*

Each gallon of water weighs 8.33 pounds. Multiply the number of gallons delivered per hour per acre by the drip system (Step 1) by the weight of one gallon of water.

$$\begin{aligned}\text{Water weight} &= 2440 \text{ gal/hr/ac} \times 8.33 \text{ lb/gal} \\ &= \mathbf{20325 \text{ lb/hr/acre}}\end{aligned}$$

To get the total weight of water applied to each zone, multiply the weight of the water applied per hour by the number of hours the system runs.

Total water weight = weight per hour x hours of injection

$$\begin{aligned}\text{Total water weight} &= 20325 \text{ lb/hr/acre} \times 6 \text{ hr} \\ &= \mathbf{121951 \text{ lb/acre}}\end{aligned}$$

3. *Determine the application rate assuming 28% UAN solution is used*

A 170 ppm solution contains 170 pounds of nitrogen per 1,000,000 pounds of water. Multiply the nitrogen parts per million in solution by the total weight of the water applied during the irrigation period and then divide by 1000000.

N Application rate = concentration (ppm) x water weight (lbs/ac) ÷ 1,000,000 lbs water

$$\begin{aligned}\text{N Application rate} &= 170 \text{ ppm} \times 121951 \text{ lbs water} \div 1000000 \text{ lbs water} \\ &= \mathbf{20.7 \text{ lb of N per acre}}\end{aligned}$$

4. *Determine the total amount of 28% UAN solution required*

Assume: 28% UAN solution contains 2.98 lb-N/gal

$$\begin{aligned}\text{Application rate} &= 20.7 \text{ lb/acre} \div 2.98 \text{ lbs/gal} \\ &= \mathbf{7.0 \text{ gal/ac}}\end{aligned}$$

Multiply the 28% UAN solution application rate per acre by the number of acres treated to get the total UAN solution needed. Add 7.0 gallons of 28% UAN solution to the solution tank for each acre to be irrigated.

5. *Determine injection rate per acre by dividing the gallons of 28% UAN solution per acre by the injection time in hours.*

$$\begin{aligned}\text{Injection Rate} &= \mathbf{\text{gallons per acre} \div \text{injection time}} \\ \text{Injection Rate} &= 7.0 \text{ gallons/ac} \div 6 \text{ hours} \\ &= \mathbf{1.2 \text{ gph/ac}}\end{aligned}$$

Calibrate the delivery rate of the chemical injection pump to make certain the rate is correct. If the fertilizer will move rapidly in the soil, it is desirable to inject it during the last portion of the irrigation event. If the fertilizer does not move readily in the soil, it can be injected earlier. If the application occurs at the end of the total irrigation time, operate the irrigation system long enough after the injection is done to completely flush the fertilizer from the system. The time required will depend on the length of drip lines and the size of the delivery pipelines.

Laws and Regulations

Federal and state laws and regulations, and some local regulations affect the practice of chemigation. Laws, regulations, court decisions and administrative rulings relating to agricultural chemical use and chemigation change frequently. Accordingly, they will be discussed here only in general terms.

Federal Laws and Regulations

Federal Insecticide, Fungicide and Rodenticide Act

All pesticide applications, including those made through an irrigation system, are subject to provisions of the Federal Insecticide, Fungicide and Rodenticide Act (FIFRA) as amended.

FIFRA provisions that will affect a chemigator include requirements to:

1. use pesticides only as directed by the label;
2. be a certified pesticide applicator or be supervised by a certified applicator if you plan to purchase or use any pesticide classified “For Restricted Use Only.”

A pesticide label (i.e. the document affixed to the pesticide container) along with any supplemental labeling that may be provided, has the same force as federal law. A person who uses any pesticide in a manner inconsistent with its label provisions violates FIFRA and is subject to possible legal actions. Therefore, before buying or using a pesticide it is important to first read the product label and fully understand its contents. This is especially true for pesticides to be used in chemigation.

Note: *Pesticide applicator training and certification and chemigation training and certification are totally separate requirements. Being a certified pesticide applicator does NOT exempt a producer who plans to chemigate from completing required chemigation training and certification. Similarly, being a certified chemigator does not exempt a producer who plans to use “Restricted Use Only” pesticides from having to complete a pesticide applicator training program.*

The Office of Pesticide Programs of the U.S. Environmental Protection Agency (EPA) issued a Pesticide Registration (PR) notice to manufacturers in early 1987 outlining a number of requirements for labeling pesticides intended for use in irrigation systems. Such pesticides must be clearly labeled stating that this method of application is acceptable. Product containers must bear several “generic” warning statements along with a listing of safety devices that must be installed and functioning before the product can legally be applied. The requirements vary depending upon water source as well as type of irrigation system. Subsequently, the PR Notice was amended in 1989, (See Table 1) but the requirements parallel those outlined in the section titled “Chemigation Equipment and Safety Devices”.

Like any other pesticide application, the site (crop) on which the pesticide is to be applied must appear on the label. It is a violation of FIFRA to use a pesticide if the crop is not listed on the label. A pesticide may be applied against any pest occurring on any crop or site specified on the label unless use of the pesticide is limited only to those pests specified on the labeling.

Applying more pesticide than the label specifies also violates FIFRA. Thus calibration is essential to ensure that the proper rate is being applied. (See “Calibration Procedures”) It is permissible, however, to apply a pesticide at any dosage, concentration or frequency less than that specified on the label without exceeding annual per acre application rates. Because of possible ineffective pest control, chemical manufacturers do not warranty applications at less than label specified rates.

Clean Water Act

The objective of the Clean Water Act (CWA) is to restore and maintain the chemical, physical and biological integrity of the nation's waters. By definition, these include essentially all forms of surface water - streams, rivers, lakes, ponds, wetlands. The long-term objective is to eliminate all discharges of pollutants from all sources into these waters.

Agriculture has long been identified by EPA as a leading generator of nonpoint source pollution. Numerous studies conducted by the U.S. Geological Survey and others have noted both nutrient and pesticide loading of many rivers and streams in the midwest. Nutrient loading in the Mississippi River and its tributaries has resulted in a hypoxia area in the Gulf of Mexico. The EPA has been working on a new water quality emphasis aimed at reducing the transport of sediment and agrichemicals from cropland into the surface waters of the US.

Federal Safe Drinking Water Act

There may be cases in which an irrigation well is situated close to a municipal water well. Any backflow of water and/or chemicals that enters an aquifer which is, or could be, used as a public drinking water source is a violation of the federal Safe Drinking Water Act (SDWA).

Under provisions of the SDWA, each state is required to prepare and implement an approved Wellhead Protection Program. Nebraska's program is administered by the NDEE. For details on the program, contact NDEE.

EPA issued a final list of unregulated contaminants in 1998 known or anticipated to occur in public drinking water supplies. The list will be used over the next few years by EPA as it weighs various regulatory options aimed at preserving drinking water quality. Over 30 pesticides or pesticide degradates are on the list.

In its 1996 amendments to the SDWA, Congress directed EPA to establish a national occurrence data base of both regulated and unregulated contaminants. Every five years EPA must establish a list of unregulated contaminants to be monitored. The agency issued a final rule in September 1999 with revisions to the "Unregulated Contaminant Monitoring Regulation for Public Water Systems." The contaminant list in the final rule, includes several pesticides.

Equipment Requirements for Chemigation with Pesticides

PR Notice 87-1

TABLE 1. List of equipment requirements when injecting pesticides.

Sprinkler Chemigation	System Connected to Public Water Supply*	Flood (basin), Furrow and Border Chemigation
<ol style="list-style-type: none"> 1. Check valve, vacuum relief valve, low pressure drain. 2. Automatic, quick-closing check valve in pesticide injection pipeline. 3. Interlocking controls between pesticide injection pump, and water pump. 4. Pressure switch to stop pump motor when water pressure drops 	<ol style="list-style-type: none"> 1. Reduced-pressure-zone backflow preventer (RPZ) or equivalent in water supply line upstream from the point of pesticide introduction Or Water from public water system discharged into a reservoir prior to pesticide introduction with complete physical break between the fill pipe outlet and the overflow rim of the reservoir at least twice the inside diameter of full pipeline. 2. Automatic, quick-closing check valve in the pesticide injection pipeline. 3. Normally-closed solenoid-operated valve on the intake side of the pesticide injection pump. 4. Interlocking controls between the pesticide injection pump and the water pump. 5. Metering pump, such as a positive displacement injection pump (e.g. diaphragm pump) design, constructed of materials compatible with pesticides, and capable of being fitted with the system interlock. 	<p>Same requirements as “Sprinkler Chemigation” with the addition of:</p> <p>Metering pump, such as a positive displacement injection pump (e.g., diaphragm pump) design, constructed of materials compatible with pesticides, and capable of being fitted with system interlock</p>

**A system providing piped water for human consumption that has at least 15 connections or regularly serves an average of at least 25 individuals daily at least 60 days out of the year.*

Federal Endangered Species Act

This law is intended to protect endangered and threatened species. Under terms of the law, the EPA is required to work with the U.S. Department of Agriculture and Department of the Interior to protect endangered species from pesticides while allowing agricultural production to continue. One of EPA's actions was to ask the U.S. Fish and Wildlife Service to revise and expand biological opinions on the effects of selected pesticides on both aquatic and terrestrial species.

Based on the FWS report, the EPA has implemented an Endangered Species Protection Program. EPA's program uses generic labeling of affected products directing users to follow use limitations found in county bulletins issued for any area that is habitat for, or is used by, an endangered or threatened species. Bulletins have been issued for 32 counties in Nebraska. The bulletins contain maps and habitat descriptions of the listed species, and affected pesticides are identified with directions for use.

EPA maintains a toll-free Endangered Species Hotline (800-447-3813) that pesticide users can contact to obtain a county map. The maps also can be obtained through the U.S. Fish and Wildlife Service, Nebraska Department of Agriculture, and Nebraska Game and Parks Commission.

Resource Conservation and Recovery Act

Bulk storage and disposal of pesticides or pesticide contaminated materials, such as containers and rinsate is subject, under some conditions, to the requirements of the Resource Conservation and Recovery Act. EPA or state permits may be required for bulk chemical storage. Be sure to follow label directions carefully in disposing of such materials. Chemical spills may be treated as improper or unauthorized disposal of hazardous materials. Be sure to notify state environmental officials immediately if a spill occurs and follow their instructions regarding spill containment and cleanup. Those responsible for spills will be liable for containment and cleanup costs under RCRA, the Comprehensive Environmental Remediation, Compensation, and Liability Act (CERCLA or Superfund) law, or both.

Chemical storage above certain threshold quantities is subject to the Emergency Planning and Community Right to Know Act. Designated state and local emergency response officials must be notified, and facility emergency response plans must be developed.

Hazardous Materials Transportation Act (HMTA)

The federal Department of Transportation (DOT) regulates hazardous materials transport under the HMTA. Many pesticides have been designated by DOT as hazardous materials, and are subject to DOT transportation regulations. In general, producers transporting hazardous materials intrastate on local roads between fields of the same farm are exempt from these regulations. However, travel on a federal highway and interstate travel is regulated. Most pesticide manufacturers and distributors provide the information needed to follow HMTA regulations. Detailed information on hazardous materials transport is available through DOT's Research and Special Programs Administration, 800-467-4922.

Food, Agriculture, Conservation and Trade Act

Persons who apply restricted use pesticides are required to keep records of every RUP application. The recordkeeping requirements are part of the Food, Agriculture, Conservation and Trade Act of 1991, also known as the 1990 Farm Bill. While federal regulations require that records be kept only two years, the Nebraska Pesticide Act requires that the following records be retained for 3 years:

1. Brand or product name and EPA registration number of the pesticide applied
2. The total amount of pesticide applied
3. Location of the application, area treated and the crop, commodity, stored product, or site that the pesticide was applied. Location can be specified using the designation:
 - county, range, township, and section
 - an accurate map or written description
 - an identification system approved by the USDA Farm Services Agency
 - the legal property description
5. Month, day and year of application
6. Name and certification number of the certified applicator who made or supervised the application

Whenever a pesticide is applied through a sprinkler irrigation system it is recommended that detailed records be kept of the application. In addition to the information specified in the federal standards, it is strongly recommended that wind speed and direction as well as ambient air temperature should also be recorded at the start of the application and at 4-6 hour intervals throughout the application. While these records are not required by law, having them available will be invaluable in the event of drift damage claims.

Nebraska Laws and Regulations

Chemigation in Nebraska also is subject to provisions of the Nebraska Chemigation Act. The act is available on-line at: <http://www.deq.state.ne.us>. For user convenience, a two-page summary of the act is included in this manual as Appendix A. Printed copies of the entire law are available upon request from the NDEE. NDEE agency is responsible for implementing and administering that law.

The department's rules and regulations on chemigation (Title 195) are available at: http://deq.ne.gov/RuleAndR.nsf/Title_195.xsp. Printed copies are available upon request from NDEE. For convenience, a copy of the rules and regulations is included as Appendix B.

Applications of livestock waste through an irrigation system are governed by Title 130 of NDEE's rules and regulations. For convenience, a copy of that chapter, current when this manual was printed, is included as Appendix G.

Under provisions of the Nebraska Chemigation Act, Natural Resources Districts (NRDs) are responsible for inspecting each irrigation system through which any agricultural chemical will be applied. Purpose of the inspection is to ensure that mandatory safety devices are installed and functioning.

NRDs have rule-making authority. Because of local concerns about ground water quality, some districts have adopted restrictions on the amount and timing of fertilizer applications. Persons planning to apply nutrients through an irrigation system should first check with the appropriate NRD and comply with all applicable regulations. A directory of the NRDs, current when the manual was printed, appears as Appendix H.

Some communities may regulate the use or storage of agricultural chemicals within designated wellhead protection areas, or through traditional community zoning. Check with local zoning officials regarding local requirements.

References

- ¹ Threadgill, E. Dale. 1985. Introduction to Chemigation: History, Development, and Current Status. In Proceedings of the Chemigation Safety Conference. University of Nebraska Center for Continuing Education. Lincoln, NE.
- ² Byers, Mathew E., et al. "Drift during Center-Pivot Chemigation of Chlorpyrifos with and without Crop Oil." Bulletin of Environmental Contamination and Toxicology (1993) 51: 60-67.
- ³ Lamm, F.R., 1998. In-Canopy Sprinkler Application for Corn: What Works and What Doesn't Work. Proceedings of the Central Plains Irrigation Short Course and Exposition. North Platte, NE pp. 70-73.
- ⁴ Yonts, C. Dean, Norman L. Klocke, William L. Kranz, Derrel L. Martin, and Kelly Wertz. 2007. Application Uniformity of In-Canopy Sprinklers. G1712. University of Nebraska Cooperative Extension.
- ⁵ ASAE EP409.1, *Safety Devices for Chemigation*, St. Joseph, MI, American Society of Agricultural Engineers, December 1999.

APPENDIX A

Summary

Nebraska Chemigation Act

This summary provides a brief review of the requirements of the Nebraska Chemigation Act and the Rules and Regulations of the Nebraska Department of Environment and Energy. Refer to the complete text of the Act and Rules and Regulations for the complete and exact language. For interpretation of the Act or Rules and Regulations with respect to specific situations you will need to consult with the NDEE or private legal counsel. Italics are used to indicate key or important points.

1. Definitions:

Applicator — any person engaged in the application of chemicals by means of chemigation. Includes any person operating equipment used for chemigation whether for himself or herself or on behalf of the permit holder for the land on which the chemigation will take place.

Chemical — *any fertilizer, fungicide, herbicide, or pesticide mixed with the water supply.*

Chemigation — any process whereby chemicals are applied to land or crops in or with water through an onfarm irrigation distribution system.

Injection location — *each site* where chemicals will be applied through an irrigation distribution system.

Irrigation distribution system — any device or combination of devices having a hose, pipe, or other conduit, which connects directly to any source of ground or surface water, through which water or a mixture of water and chemicals is drawn and applied for agricultural or horticultural purposes.

Open discharge system — a system in which the water is pumped or diverted directly into a ditch or canal in such a manner that the force of gravity at the point of discharge into the ditch or canal cannot cause water to flow back to the point from which the water was pumped or diverted.

Permit holder — the owner or operator of land who applies or authorizes the application of chemicals to such land by means of chemigation. Party primarily responsible for any liability arising from chemigation on the property.

Pesticide — any substance intended for preventing, destroying, repelling or mitigating any pest, insect, rodent, nematode, fungus, weed, or other form of plant or animal life or virus, except viruses on or in living humans or animals, and any substance or mixture of substances intended for use as a plant regulator, defoliant, or desiccant.

Restricted use pesticide — a pesticide classified for restricted use by the Federal Insecticide, Fungicide and Rodenticide Act.

2. After January 1, 1987, a chemigation permit is required for each chemigation injection location. **No permit is required for open discharge systems.** Permit applications are made to the NRD where the injection location is located. NRD reviews application, conducts inspection and approves or denies application within 45 days. Initial permit application fee is established by each NRD.

3. NRD must be notified within 10 days of any change of information on the permit application.

4. Emergency permit for 45 days can be obtained within 48 hours if equipment requirements are met and the applicator is certified. Emergency permit application fee is established by each NRD.
5. Permits expire on June 1 of the year following the year of issue and must be renewed before expiration. A list of names and estimated amounts of all chemicals used in the chemigation system is required for renewal. Renewal permit fee is established by each NRD.
6. NRD *must be notified within 72 hours of any replacement or alterations of approved chemigation equipment.*
7. NRD shall conduct area wide, selective, and periodic inspections to insure compliance.
8. Permits will not be issued or renewed if:
 - a. required information is not provided, or
 - b. irrigation distribution system does not comply with equipment standards, or
 - c. applicator is not certified, or
 - d. fee is not paid.
9. NRD shall deny, suspend, refuse renewal of, or revoke permit applied for or issued if fraud or deceit was used to obtain a permit, or if any provisions of the Act, Standards, or Rules and Regulations are violated.
10. Written 10-day notice required before permit denial, refusing renewal, suspension or revocation of permit. A hearing can be requested.
11. NRD or NDEE can order immediate suspension of chemigation if there is an actual or imminent threat of danger to persons or the environment.
12. Equipment required:
 - a. check and vacuum relief valves in the irrigation pipeline
 - b. inspection port to check operation of irrigation pipeline check valve
 - c. automatic low-pressure drain
 - d. chemical injection line check valve
 - e. simultaneous interlock between the power system of the chemical injection unit & the irrigation pumping plant.
13. See Chapters 9 and 10 of the NDEE Chemigation Rules and Regulations for specific equipment requirements and standards.
14. Applicators must be certified by attending a training session and passing a written examination. Each applicator's certificate expires four years after the date of issuance and must be renewed by attending a training session and passing a written examination.
15. Posting is required when chemigation is used to apply restricted use pesticides or chemicals that have a label that requires posting. Chapter 12 of Rules and Regulations provides posting details.
16. Actual or suspected accidents related to chemigation must be reported within 24 hours of discovery. The permit holder must carry out a cleanup and recovery plan developed by NDEE.
17. Compliance with the Nebraska Chemigation Act shall be an affirmative defense to any civil action resulting from a person's use of chemigation.
18. Ten days to comply with Act or Rules and Regulations after notification of violation. NRD or NDEE can revoke permit if there is not satisfactory compliance.

- 19. NRD or NDEE may apply for restraining order, a temporary or permanent injunction, or a mandatory injunction against violators.
- 20. A compliance schedule can be established in lieu of the 10-day compliance requirement.
- 21. Penalties

<u>Violation</u>	<u>Penalty</u>
<i>Emergency Permit Violation</i>	Permit revocation without hearing, Class II misdemeanor
<i>Operating without required equipment</i>	Civil penalty of not more than \$5,000 per day or Class IV misdemeanor
<i>Operating with no permit or revoked permit</i>	Civil penalty of not more than \$5,000 per day or Class II misdemeanor
<i>Operating with suspended</i>	Civil penalty of not more than \$5,000 per day or Class II misdemeanor
<i>Tampering or damaging equipment</i>	Civil penalty of not more than \$5,000 per day or Class I misdemeanor
<i>Failure to report accident</i>	Civil penalty of not more than \$5,000 per day or Class III misdemeanor
<i>Any other violation</i>	Civil penalty of not more than \$5,000 per day or Class IV misdemeanor

- 23. NDEE can assume NRD responsibilities, after a hearing, if NRD is not carrying out requirements of the Act.
- 24. NDEE or NRD orders can be applied to the District Court.

APPENDIX B

Department of Environment and Energy **Rules and Regulations Pertaining** **to Chemigation**

Table of Contents

SUBJECT OR TITLE	CODE ENABLING LEGISLATION	SECTION
Accident Investigation and Remediation	46-1131	Ch. 15
Accident Reporting	46-1131	Ch. 14
Certification and Revocation Process for Chemigation Applicators	46-1128, 46-1129 and 46-1129.01	Ch. 13
Definitions	46-1104 thru 46-1116	Ch. 1
District Responsibilities	46-1117, 46-1123, 46-1136 (2)	Ch. 8
Effective Date	84-906	Ch. 16
Equipment; Replacement, Repair	46-1136(1)	Ch. 10
Equipment; Standards, Installation	46-1127, 46-1136(1)	Ch. 9
Inspections, Access	46-1117 thru 46-1119, 46-1121, 46-1122, 46-1124 and 46-1127	Ch. 11
Permits; Emergency	46-1119(1)(3)	Ch. 6
Permits; Expiration, Renewal	46-1121(2), 46-1136(2)	Ch. 4
Permits; Fees	46-1117.01, 46-1119(2), 46-1121, 46-1136(2)	Ch. 7
Permits; Issuance, Denial	46-1117, 46-1121(2), 46-1126 (2), 46-1138	Ch. 3
Revocation, Suspension	46-1138	
Permits; Special	46-1117.01 and 46-1136(2)	Ch. 5
Permits; When Required, Applications	46-1117, 46-1117.01	Ch. 2
Posting	46-1130	Ch. 12

Title 195 - NEBRASKA DEPARTMENT OF ENVIRONMENT AND ENERGY**Chapter 1 - DEFINITIONS**

- 001 **Applicator** means any person engaged in the application of chemicals by means of chemigation. Applicator shall include any person operating equipment used for chemigation whether for themselves or on behalf of the permitholder for the land on which the chemigation will take place.
- 002 **Chemical** means any fertilizer, fungicide, herbicide, or pesticide mixed with the water supply.
- 003 **Chemigation** means any process whereby chemicals are applied to land or crops in or with water through an onfarm irrigation distribution system.
- 004 **Council** means the Environmental Control Council.
- 005 **Department** means the Department of Environment and Energy.
- 006 **Director** means the Director of Environment and Energy.
- 007 **District** means a natural resources district created pursuant to Chapter 2, article 32.
- 008 **Fertilizer** means any formulation or product used as a plant nutrient which is intended to promote plant growth and contains one or more plant nutrients recognized by the association of American Plant Food Control Officials in its official publication.
- 009 **Injection location** means each site where chemicals will be applied through an irrigation distribution system.
- 010 **Irrigation distribution system** means any device or combination of devices having a hose, pipe, or other conduit, which connects directly to any source of ground or surface water, through which water or a mixture of water and chemicals is drawn and applied for agricultural or horticultural purposes. Irrigation distribution system shall not include any hand-held hose sprayer or other similar device which is constructed so that an interruption in water flow automatically prevents any backflow to the water source.
- 011 **Open discharge system** means a system in which the water is pumped or diverted directly into a ditch or canal in such a manner that the force of gravity at the point of discharge into the ditch or canal cannot cause water to flow back to the point from which the water was pumped or diverted.
- 012 **Permitholder** means the owner or operator of land who applies or authorizes the application of chemicals to such land by means of chemigation. The permitholder shall be the party primarily responsible for any liability arising from chemigation on the property.
- 013 **Pesticide** means any substance or mixture of substances intended for preventing, destroying, repelling, or mitigating any pest, insect, rodent, nematode, fungus, weed, or other form of plant or animal life or virus, except viruses on or in living humans or animals, and any substance or mixture of substances intended for use as a plant regulator, defoliant, or desiccant.
- 014 **Restricted use pesticide** means a pesticide that is classified for restricted use under the provisions of section 3(d)(1)(C) of the Federal Insecticide, Fungicide, and Rodenticide Act, 7 U.S.C. §§ 135, et seq.
Enabling Legislation: Neb. Rev. Stat. §§ 46-1104 thru 46-1116
Legal Citation: Title 195, Ch. 1, Nebraska Department of Environment and Energy

Title 195 - NEBRASKA DEPARTMENT OF ENVIRONMENT AND ENERGY
Chapter 2 - PERMITS; WHEN REQUIRED, APPLICATIONS (*Revised: April 1, 2012*)

- 001 After January 1, 1987, no person shall apply or authorize the application of chemicals to land or crops through the use of chemigation, unless such person obtains a permit from the district in which the well or diversion is located, except that nothing in this chapter shall require a person to obtain a chemigation permit to pump or divert water to or through an open discharge system.
- 002 An application must be filed with the district for each injection location. The following information is the minimum requirement of the Department.
- 002.01 Name, address and telephone number of applicant.
- 002.02 Calendar Year for which application is being made.
- 002.03 Legal description of the injection location site, defined to the quarter of quarter section (forty-acre increment).
- 002.04 Whether the application is for an initial, renewal or emergency permit.
- 002.05 The name(s) of the certified *chemigation* applicator(s) and, if known, their certification number and the expiration date of their certification.
- 002.06 Whether the chemical injection equipment to be used is stationary or portable.
- 002.07 Signature of the permit applicant and date of signing. The signature must be that of the proposed permitholder or a person holding power of attorney from the applicant.
- 002.08 If the application is for a renewal permit, in addition to the information required in 002.01 through 002.07, the applicant shall list the names and estimated amounts of all the chemicals that were used in the chemigation system the previous year.
- 003 All applications for a chemigation permit must be completed on forms provided by the Department. Application forms shall be available at each district and county extension office and the Department, and such other locations as the district deems advisable.
- 004 A person is hereby authorized by rule to inject chemicals for maintenance of a subsurface drip irrigation system once each calendar year, provided such system:
- 004.01 Is equipped with an irrigation pipeline check valve, and
- 004.02 Is permitted under Title 122 – Rules and Regulations for Underground Injection and Mineral Production Wells.
- Enabling Legislation: Neb. Rev. Stat. §§ 46-1117, 46-1117.01
Legal Citation: Title 195, Ch. 2, Nebraska Department of Environment and Energy

Title 195 - NEBRASKA DEPARTMENT OF ENVIRONMENT AND ENERGY
Chapter 3 - PERMITS; ISSUANCE, DENIAL, REVOCATION, SUSPENSION
(*Revised: April 1, 2012*)

- 001 Except as provided in Chapters 5 and 6, the district shall review each completed application, conduct an inspection, and approve or deny the application within forty-five days after the application is filed.
- 002 No chemigation permit shall be issued or renewed by the district, except as provided in Chapter 5, if any of the following conditions occur:
- 002.01 The applicant has failed to provide the required information, as specified in Chapter 2, 002, on the application form.
- 002.02 The irrigation distribution system does not comply with the equipment standards of Chapters 9 and 10;
- 002.03 The applicator has not been certified as a chemigation applicator by the Department;
or
- 002.04 Failure of the applicant to remit the appropriate fee.

- 003 The permitholder shall notify the district within ten days of any changes in the information provided on the permit application.
- 004 The district shall deny, suspend, refuse renewal of, or revoke a permit applied for or issued on any of the following grounds:
- 004.01 Fraud or deceit was used in obtaining a permit:
- 004.02 Failure to notify the district of equipment replacement or alteration within seventy-two hours:
- 004.03 Failure of the applicator or permitholder to notify the district and Department of an actual or suspected spill or accident within twenty-four hours;
- 004.04 Failure of the permitholder to carry out cleanup measures developed by the Department within the time specified; or
- 004.05 Violation of any other provisions of the Nebraska Chemigation Act or any standards or rules and regulations adopted pursuant to the Act.
- 005 The district or Department shall immediately suspend a permit if the district or Department concludes that there is an actual or imminent threat of danger to the public or the environment as a result of operation of a chemigation system.
- 006 The district shall notify any person found to be in violation of the Nebraska Chemigation Act or any rules or regulations issued pursuant to the Act that said person has ten days in which to comply. If the violation has not been corrected in the ten day period then the district shall notify the Department of the violation. If after a preliminary investigation the Department determines there is a violation then the person's permit shall be revoked until compliance is met. For systems operated by the permitholder the district may establish a schedule for compliance in lieu of the ten-day compliance requirement.
- Enabling Legislation: Neb. Rev. Stat. §§ 46-1117, 46-1121(2), 46-1126(2), 46-1138
 Legal Citation: Title 195, Ch. 3, Nebraska Department of Environment and Energy

Title 195 - NEBRASKA DEPARTMENT OF ENVIRONMENT AND ENERGY
Chapter 4 - PERMITS; EXPIRATION, RENEWAL *(Revised: September 16, 2015)*

- 001 Permits issued during the calendar year shall expire on June 1 of the following year, except as provided in Chapter 6.
- 002 A permit may be renewed each year upon payment of the annual renewal fee and completion of an application form providing all the information requirements of Chapter 2, 002.
- 003 Permits not renewed on or before June 1 shall not be reinstated without filing a new application containing the information prescribed in Chapter 2, 002, payment of the initial application fee, and an inspection which shows compliance with the Chemigation Act and these regulations.
- 004 Permits are not transferrable.
- Enabling Legislation: Neb. Rev. Stat. §§ 46-1121(2), 46-1136(2)
 Legal Citation: Title 195, Ch. 4, Nebraska Department of Environment and Energy

Title 195 - NEBRASKA DEPARTMENT OF ENVIRONMENT AND ENERGY
Chapter 5 - PERMITS; SPECIAL *(Revised: April 1, 2012)*

- 001 If the district determines by inspection that a chemigation system does not need all of the safety equipment prescribed in Chapters 9 and 10, it shall forward such information to the Department for review. If the Department concurs with the district, the Department shall grant approval to the district to issue a special permit.

- 002 The following information shall be provided by the district and is the minimum requirement of the Department.
002.01 Name, address and telephone number of the applicant.
002.02 Legal description of the system location.
002.03 U.S. Geological survey map showing the system layout topographically with the location and elevation of existing equipment and injection location indicated.
002.04 Location, nominal diameter and length of all pipe in the irrigation distribution system.
- 003 Issuance of a special permit shall not relieve the permit holder or applicator from compliance with all other responsibilities under the act or these regulations.
Enabling Legislation: Neb. Rev. Stat. §§ 46-1117.01, 46-1136(2)
Legal Citation: Title 195, Ch. 5, Nebraska Department of Environment and Energy

Title 195 - NEBRASKA DEPARTMENT OF ENVIRONMENT AND ENERGY
Chapter 6 - PERMITS; EMERGENCY *(Revised: September 16, 2015)*

- 001 A person may file an application with the district for an emergency permit. An emergency permit shall be issued in accordance with the conditions of Chapter 3, 002.
001.01 If the district has not denied an emergency permit within two working days after the application is filed, the permit shall be deemed issued. Working day shall mean Monday through Friday but shall not include Saturday, Sunday, or a federal or state holiday. In computing two working days, the day of receipt of the permit is not included and the last day of the two working days is included.
001.02 An emergency permit shall be valid for a period of forty-five days from the date of issuance.
- 002 Any holder of an emergency permit or an applicator applying chemicals pursuant thereto who violates any of the provisions of the Nebraska Chemigation Act or standards, rules and regulations adopted under it, shall have such permit automatically revoked by the district or the Department, without a hearing and subject to penalties as specified in the Chemigation Act.
Enabling Legislation: Neb. Rev. Stat. §§ 46-1119(1)(3)
Legal Citation: Title 195, Ch. 6, Nebraska Department of Environment and Energy

Title 195 - NEBRASKA DEPARTMENT OF ENVIRONMENT AND ENERGY
Chapter 7 - PERMITS: FEES *(Revised: September 16, 2015)*

- 001 The fee for initial application for a permit or special permit shall not exceed one hundred and fifty dollars payable to the district. The district shall transfer five dollars of this fee to the Department.
- 002 The annual fee for renewal of a permit or special permit shall not exceed one hundred dollars payable to the district. Two dollars of the annual fee shall be transferred by the district to the Department.
- 003 The application for an emergency permit shall be accompanied by a fee not to exceed five hundred dollars payable to the district. The district shall transfer ten dollars of this fee to the Department.
- 004 The district shall forward the appropriate fees for the first half of the calendar year to the Department by September 1 of the calendar year and the fees for the last half of the calendar year by March 1 of the following year.
Enabling Legislation: Neb. Rev. Stat. §§ 46-1117.01, 46-1119(2), 46-1121, 46-1136(2)
Legal Citation: Title 195, Ch. 7, Nebraska Department of Environment and Energy

Title 195 - NEBRASKA DEPARTMENT OF ENVIRONMENT AND ENERGY
Chapter 8 - DISTRICT RESPONSIBILITIES *(Revised: April 1, 2012)*

- 001 The district may require additional information and adopt and promulgate rules and regulations as necessary to carry out its responsibilities under the Nebraska Chemigation Act (Secs. 46-1101 thru 46-1148). Such information requirements, and rules and regulations must be based on a justifiable need and are subject to approval by the Director.
- 002 Each district shall establish permit fees as required under the Nebraska Chemigation Act (Sec. 46-1121)
- 003 Each district shall submit an annual report to the Department by March 1 of each year, which shall include the following information for the previous year:
- 003.01 The number of permit applications received by the district;
 - 003.02 The number of permit applications approved by the district;
 - 003.03 The number of chemigation system inspections made by the district at each permitted injection site and whether the inspections were initial inspections, for equipment replacement or repair, or routine monitoring; and
 - 003.04 The name of all chemicals and estimated amounts used in chemigation systems within the district the previous year.
- 004 The district shall maintain each application or the information contained in the application for a period of five years and shall provide such information to the Department upon request.
Enabling Legislation: Neb. Rev. Stat. §§ 46-1117, 46-1123 and 46-1136(2)
Legal Citation: Title 195, Ch. 8, Nebraska Department of Environment and Energy

Title 195 - NEBRASKA DEPARTMENT OF ENVIRONMENT AND ENERGY
Chapter 9 - EQUIPMENT; STANDARDS, INSTALLATION *(Revised: April 1, 2012)*

- 001 Any irrigation distribution system, except an open discharge system, through which chemigation is performed shall be equipped with the mechanical devices specified in paragraphs 002 through 007 of this Chapter. The equipment shall be installed in accordance with the manufacturer's specifications and at the location specified. This shall not be construed to prevent the use of portable chemigation equipment if such equipment meets the requirements set forth herein.
- 002 Irrigation pipeline check valve. The check valve shall be located in the pipeline between the irrigation pump and the point of chemical injection into the irrigation pipeline. Its purpose is to prevent a mixture of water and chemical from draining or siphoning back into the irrigation water source.
- 002.01 Existing irrigation distribution systems which, as of July 1, 1987 are equipped with a properly located check valve shall be considered in compliance, until repaired or replaced, if the valve provides a watertight seal against reverse flow.
 - 002.02 Irrigation distribution systems which are not equipped with a check valve or contain a check valve which after repair cannot meet the requirement in 002.01, shall be equipped with a check valve as specified in Chapter 10.
 - 002.03 For check valves manufactured or assembled after July 1, 1987, the manufacturer of the valve assembly shall provide verification to the director that the valve model has been tested and certified by an independent laboratory as meeting the criteria specified in Appendix C.
 - 002.04 All check valves installed on an irrigation distribution system after January 1, 1988, shall be models certified to the director as specified in 002.03 above.

- 003 Vacuum relief valve. The vacuum relief valve shall be located on the pipeline between the irrigation pump and the irrigation pipeline check valve. Its purpose is to prevent creation of a vacuum when the water flow stops. If the valve connection will also serve as the inspection port, the permitholder will ensure removal of the valve at the time of inspection.
- 004 Inspection port. The inspection port or other viewing device shall be located on the pipeline between the irrigation pump and the irrigation pipeline check valve. In many cases the vacuum relief valve connection can serve as the inspection port.
- 004.01 The inspection port or viewing device shall be situated in such a manner that the inlet to the low pressure drain can be observed.
- 004.02 A minimum four-inch diameter orifice or viewing area is required for systems without an existing port or device after January 1, 1988.
- 005 Low-pressure drain. The low-pressure drain shall be located on the bottom of the horizontal pipe between the irrigation pump and the irrigation pipeline check valve. Its purpose is to drain any mixture of water and chemical away from the irrigation water source.
- 005.01 The drain shall be constructed of corrosion resistant material or otherwise coated or protected to prevent corrosion;
- 005.02 The drain shall have an orifice of at least three-quarter inch diameter and shall not extend into the horizontal pipe beyond the inside surface of the bottom of the pipe; and
- 005.03 When the pipeline water flow stops, the drain will automatically open. A tube, pipe or similar conduit shall be used to discharge the solution at least twenty feet from the irrigation water source.
- 006 Chemical injection line check valve. The chemical injection line check valve shall be located between the point of chemical injection into the irrigation pipeline and the chemical injection pump. Its purpose is to prevent flow of water from the irrigation system into the chemical supply tank and to prevent gravity flow from the chemical supply tank into the irrigation pipeline.
- 006.01 The valve shall be constructed of chemically resistant materials.
- 006.02 The valve shall be designed to prevent irrigation water under operating pressure from entering the chemical injection line; and
- 006.03 The valve shall be designed to have a minimum opening (cracking) pressure of ten psi. When the chemical injection pump is shut down, the valve shall prevent any leakage from the chemical supply tank.
- 006.04 As an alternative to the minimum opening pressure requirement in 006.03 above, a vacuum relief valve may be placed in the injection line between the chemical injection line check valve and chemical injection pump. The vacuum relief valve shall be constructed of chemically resistant materials, shall open at atmospheric pressure, shall be at an elevation greater than the highest part of the chemical supply tank and shall also be the highest point in the injection line.
- 007 Simultaneous interlock device. The irrigation pumping plant and the chemical injection pump shall be interlocked so that if the pumping plant stops, the injection pump will also stop. Its purpose is to prevent pumping chemicals into the irrigation pipeline after the irrigation pump stops.

Enabling Legislation: Neb. Rev. Stat. §§ 46-1127, 46-1136(1)

Legal Citation: Title 195, Ch. 9, Nebraska Department of Environment and Energy

Title 195 - NEBRASKA DEPARTMENT OF ENVIRONMENT AND ENERGY
Chapter 10 - EQUIPMENT; REPLACEMENT, REPAIR *(Revised: April 1, 2012)*

- 001 Any permitholder who replaces or alters or authorizes the replacement or alteration of chemigation equipment which was previously approved by the district shall notify the district within seventy-two hours of such replacement or alteration. The district shall conduct an inspection of the replaced or altered equipment to determine compliance with Chapter 9.
- 002 Replacement equipment shall meet the requirements of Chapter 9, and in the case of irrigation pipeline check valves, shall meet the following minimum requirements:
- 002.01 The valve body and all components shall be constructed of corrosion resistant materials or otherwise coated or protected to prevent corrosion;
 - 002.02 The valve shall contain a sealing mechanism designed to close prior to or at the moment water ceases to flow in the downstream direction. This mechanism shall be either diaphragm-actuated by hydraulic line pressure, spring loaded or weight loaded to provide a watertight seal against reverse flow;
 - 002.03 The valve shall be designed to meet the leakage tests specified in Underwriters Laboratory, Inc., Standard UL 312, Chapter 16, Leakage Test, page 11, dated May 22, 1984;
 - 002.04 All moving components of the valve shall be designed to prevent binding, distortion or misalignment during water flow; and
 - 002.05 The valve shall be designed to allow for easy repair and maintenance, including removal from the pipeline if required to perform such work.
- 003 The equipment required in these rules and regulations shall be maintained in working condition during all times of chemigation. When required, the equipment shall be repaired to its originally designed condition.
- Enabling Legislation: Neb. Rev. Stat. §§ 46-1136(1)
Legal Citation: Title 195, Ch. 10, Nebraska Department of Environment and Energy

Title 195 - NEBRASKA DEPARTMENT OF ENVIRONMENT AND ENERGY
Chapter 11 - INSPECTIONS, ACCESS *(Revised: April 1, 2012)*

- 001 Employees of the district and the Department shall have access at all reasonable times to inspect chemigation systems and otherwise carry out their duties under the Chemigation Act.
- 002 The district shall conduct an inspection of each injection location for which an application for a chemigation permit has been received to determine compliance with the equipment standards of Chapters 9 and 10 except as provided for in Chapter 5.
- 002.01 The inspection for a permit application to be issued according to Chapters 3 and 5 shall be conducted within forty-five days after the application is filed.
 - 002.02 For each special permit issued according to Chapter 5, an inspection shall be conducted prior to permit renewal.
 - 002.03 For each emergency permit issued, an inspection shall be conducted during the forty-five day effective period of the permit if not inspection was conducted prior to permit issuance.
- 003 The district shall conduct an inspection of replaced or altered equipment after being notified of such changes by the permitholder to determine compliance with Chapter 10. When in compliance, the district shall approve the continuance of the permit. If not in compliance, the permit shall be suspended under Chapter 3, 004.05 until compliance is demonstrated and approval for operation is given by the district.

- 004 Each application for renewal is subject to inspection of equipment and site to determine compliance with the Chemigation Act. When an inspection is made and compliance is not demonstrated, renewal shall be refused, suspended, or revoked (pursuant to Chapter 3, 004) until compliance is achieved and approval for operation given by the district.
- 005 The district shall develop an areawide, selective and periodic inspection program to insure compliance with the Nebraska Chemigation Act and these rules and regulations.
Enabling Legislation: Neb. Rev. Stat. §§ 46-1117 thru 46-1119; 46-1121, 46-1122, 46-1124 and 46-1127
Legal Citation: Title 195, Ch. 11, Nebraska Department of Environment and Energy

Title 195 - NEBRASKA DEPARTMENT OF ENVIRONMENT AND ENERGY
Chapter 12 - POSTING *(Revised: April 1, 2012)*

- 001 Signs shall be posted on chemigated fields when a restricted use pesticide or a chemical for which the label requires posting is used.
- 002 The signs required in these rules and regulations shall meet the following requirements:
- 002.01 A sign shall be posted at each usual point of entry into a treated area and at the point of chemical injection if located outside the treated area. Each sign shall be posted in such a manner that it is clearly visible and legible.
- 002.02 The sign shall contain the words “KEEP OUT, CHEMICAL APPLICATION THROUGH IRRIGATION SYSTEM
- 002.03 The lettering on the sign shall be a color which clearly contrasts with the background and the letters shall be two and one-half inches in height.
- 002.04 Each sign shall be posted and maintained during the chemigation period and until the end of reentry period as specified by the chemical label. The sign shall be posted no sooner than 48 hours prior to the start of chemigation and shall be removed, covered, or otherwise made illegible, no later than 48 hours after the end of reentry period.
Enabling Legislation: Neb. Rev. Stat. §§ 46-1130
Legal Citation: Title 195, Ch. 12, Nebraska Department of Environment and Energy

Title 195 - NEBRASKA DEPARTMENT OF ENVIRONMENT AND ENERGY
Chapter 13 - CERTIFICATION AND REVOCATION PROCESS FOR
CHEMIGATION APPLICATORS *(Revised: April 1, 2012)*

- 001 The Department shall conduct or contract with the University of Nebraska Cooperative Extension Service to conduct annual statewide training sessions in the safe use of chemigation. All chemigation applicators are required to attend a training session.
- 002 The director shall issue a card entitled “Chemigation Applicator Certification” to those individuals who attend a training session and pass a written examination approved by the Department acknowledging his/her satisfactory competency in the use of chemigation.
- 003 The Chemigation Applicator Certification, shall expire on January 1 of the fourth year after the date of issuance.
- 004 The Chemigation Applicator Certification shall be renewed by attending a training session and passing a written examination approved by the Department.
- 005 A Chemigation Applicator Certification may be revoked by the Department if the applicator:
- 005.01 Operates a chemigation system that is known to be defective or not in compliance with permit requirements;
- 005.02 Fails to report any actual or suspected chemigation accident to the district and the Department;

005.03 Operates or authorizes operation of a chemigation system without the necessary permit; or;

005.04 Violates any of the provisions of the Nebraska Chemigation Act or subsequent regulations or standards.

006 Any person who has a certification revoked shall be afforded an opportunity for a fair hearing as provided in Neb. Rev. Stat. §81-1507(2)(3). The hearing shall be held upon written application to the director within thirty days after receipt of the notice from the director of such revocation. On the basis of such hearing the director shall affirm, modify or revoke his or her previous determination. The hearing shall be considered conducted as a contested case subject to Title 115, Rules of Practice and Procedure.

Enabling Legislation: Neb. Rev. Stat. §§ 46-1128, 46-1129 and 46-1129.01

Legal Citation: Title 195, Ch. 13, Nebraska Department of Environment and Energy

Title 195 - NEBRASKA DEPARTMENT OF ENVIRONMENT AND ENERGY

Chapter 14 - ACCIDENT REPORTING *(Revised: April 1, 2012)*

001 The applicator or permitholder shall report any actual or suspected accident related to the use of chemigation in his or her system to the Department and the appropriate district within twenty-four hours of its discovery.

002 Notification shall be made by telephone to the Department and the appropriate district during office hours, from 8 a.m. to 5 p.m., Monday through Friday. After hours and holidays, reports shall be made to the Nebraska State Patrol. All information known about the accident at the time of discovery is to be included, such as time of occurrence, quantity and type of material, location, and any corrective or cleanup actions presently being taken.

Enabling Legislation: Neb. Rev. Stat. §§ 46-1131

Legal Citation: Title 195, Ch. 14, Nebraska Department of Environment and Energy

Title 195 - NEBRASKA DEPARTMENT OF ENVIRONMENT AND ENERGY

Chapter 15 - ACCIDENT INVESTIGATION AND REMEDIATION

(Revised: April 1, 2012)

001 Any actual or suspected accident resulting from the use of chemigation shall be investigated by the appropriate district and the Department. The applicator or permitholder shall supply any additional information requested in the course of the investigation regarding the amount and type of substance(s) involved, the well and equipment involved, and information the applicator or permitholder would reasonably be expected to know.

002 The Department shall determine any immediate action necessary according to Part I of the Ground Water Remedial Action Protocol (Title 118, Chapter 10 - Ground Water Quality Standards and Use Classification).

003 The Department shall perform the appropriate assessments and develop a workplan for any further (final) remedial action according to Part II of the Ground Water Remedial Action Protocol (Title 118, Chapter 10). The remedial action workplan shall be carried out by the permitholder under the supervision of the Department or the district.

Enabling Legislation: Neb. Rev. Stat. §§ 46-1131

Legal Citation: Title 195, Ch. 15, Nebraska Department of Environment and Energy

APPENDIX C

Leak Test

1. A check valve shall withstand for 1 minute, without leakage at joints or at the valve seat, an interval hydrostatic pressure of two times the rated working pressure of the valve. Slight weeping of water at the valve seat is acceptable for metal-to-metal seats. Leakage past clappers with, or in contact with, resilient seats, is not acceptable.
2. For the purposes of this test, “slight weeping” is defined as leakage not exceeding 1 fluid ounce per hour (0.008 mL/sec) per inch (25.4 mm) of nominal valve size.
3. A check valve shall withstand for 16 hours, without leakage at the valve seat, an internal hydrostatic pressure equivalent to the head of a column of water 5 feet (1.5 m) high retained within the downstream portion of the valve body. No leakage shall occur as evidenced by wetting of paper placed beneath the valve assembly. This test is to be conducted with the valve in both the horizontal and vertical position if intended for such use.

“This material is based on and taken, with permission from Underwriters Laboratories Inc. Standard for Safety for Check Valves For Fire-Protection Service, UL 312, Sixth Edition dated April 21, 1980, Copyright 1975, 1985 (by Underwriters Laboratories Inc.) copies of which may be purchased from Underwriters Laboratories Inc., Publications Stock, 333 Pfingsten Road, Northbrook, IL 60062.”

“UL shall not be responsible to anyone for the use of or reliance upon a UL Standard by anyone. UL shall not incur any obligation or liability for damages, including consequential damages, arising out of or in connection with the use, interpretation of, or reliance upon a UL Standard.”

APPENDIX D



NEBRASKA
DEPT. OF ENVIRONMENTAL QUALITY

This guidance document is advisory in nature but is binding on an agency until amended by such agency. A guidance document does not include internal procedural documents that only affect the internal operations of the agency and does not impose additional requirements or penalties on regulated parties or include confidential information or rules and regulations made in accordance with the Administrative Procedure Act. If you believe that this guidance document imposes additional requirements or penalties on regulated parties, you may request a review of the document.

00-051

November, 2016

Certified Chemigation Check Valve Models and Manufacturers

NOTE: Even though a model meets the testing criteria, each field installation must not leak when inspected by Natural Resources District personnel.

Ames Company, Inc.
P.O. Box 1387 Woodland, CA 95695
Model(s) Available: 8-inch
(A113-31)

Lake Co. Irrigation Systems
P.O. Box 2248 Bakersfield, CA 93303
Model(s) Available: 4-inch, 6-inch, 8-inch, and 10-inch

API International, Inc. 12505 SW Herman Road
Tualatin, OR 97062
Model(s) Available: 4-inch (CMV-FL-4), 6-inch (CMV-FL-6), 8-inch (CMV-FL-8), 10-inch (CMV-FL-10)

Lindsay Mfg. Co.
P.O. Box 156 Lindsay, NE 68644
Model(s) Available: 8-inch

Boice Crane Industries, Inc.
P.O. Box 429 Gothenburg, NE 69138
Model(s) Available: 8-inch

Midwest Irrigation Co. Box 516
Henderson, NE 68371
Model(s) Available: 4-inch (CVP-4), 6-inch (CVP-6 & CVM-6, 8-inch (CVP-8 & CVM-8 & CVMW-8), 10-inch (CVP-10), 12-inch (CVP-12)

Clemons Sales Corp. 6983 Supply Way
Boise, ID 83705
Model(s) Available: 8-inch

Morrill Industries, Inc. 22223 South Brennan
Escalon, CA 95320
Model(s) Available: 4-inch (1533-4), 6-inch (1533-6), 8-inch (1533-8), 10-inch (1533-10)

Fresno Valves & Castings
P.O. Box 40 Selma, CA 93662
Model(s) Available: 4, 6, 8, 10, and 12-inch
available in Model CVW-150

Northern Pump & Irrigation Co. Box 576
Henderson, NE 68371
Model(s) Available: 6-inch (6NCCVFF; 6331-6NCCVFF), 8-inch (8NCCVFF; 6331-8NCCVFF), 10-inch (10NCCVFF). [Availability includes FF, FC, TC, PP, PE and PC models]
P.O. Box 528 Eugene, OR 97440

Kroy Industries, Inc. Box 309
York, NE 68467
Model(s) Available: 8-inch F-F
Pierce Corporation

Model(s) Available: 6-inch, 8-inch, 10-inch

Reinke Mfg. Co., Inc.
P. O. Box 566 Deshler, NE 68340
Model(s) Available: 8-inch (CV 8 [Blue
River □])

T-L Irrigation Co.
P.O. Box 1047 Hastings, NE 68901
Model(s) Available: 6-inch, 8-inch, 10-inch.
(T-L valves also sold by Agri-Inject, Inc. of
Yuma, CO under an agreement with T-L
Irrigation)

Valmont Industries, Inc. Valley, NE 68064

Model(s) Available: 8-inch (1K01813;
1K01814; 1K01819)

Water Specialties Corp. 191 W. Poplar
Avenue Porterville, CA 93257
Model(s) Available: 6-inch (ML-CV 6), **8-**
inch (ML-CV 8), **10-inch** (ML-CV 10), **12-**
inch (ML- CV 12)

Waterman Industries, Inc.
P.O. Box 458 Exeter, CA 93221
Model(s) Available: 4-inch (CPC-30), **6-inch**
(CPC-30 & -30B), **8-inch** CPC-30 & -30B);
10- inch (CPC-30 & -30B)

APPENDIX E

IRRIGATED ACREAGES

Irrigated acreage, when combined with the crop water needs, form the basis for the system water requirement. Thus, accurate field measurements properly size the center pivot and also help determine the volume of water to be pumped.

1. Determine the precise field dimensions and draw a scaled field map. Label all dimensions.

2. Generally, the pivot is located to provide the largest possible center pivot system.

NOTE: Allow at least 5' end gun clearance from obstructions.

3. Locate pivot and draw circles of radius equal to system length (including overhang) and effective end gun coverage.

NOTE: Maintain 30' clearance between end gun and any roadway, and 50' clearance from any high voltage power lines.

4. With a corner system, the pivot is located to allow the largest possible basic center pivot and to allow corner arm extension to the maximum acres beyond the reach of the basic system.

NOTE: The last tower on the basic system of a corner system should miss all obstructions by 30-35 feet.

5. Segment the irrigated area into parts of a circle and into triangles and label dimensions.

Compute the area of each segment, then sum the areas for the total acreage.

CONVENTIONAL ELECTRIC OR WATER DRIVE CENTER PIVOT

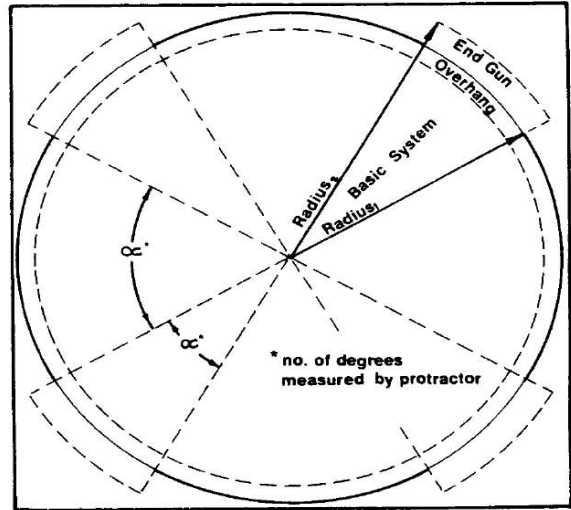

CORNER SYSTEM

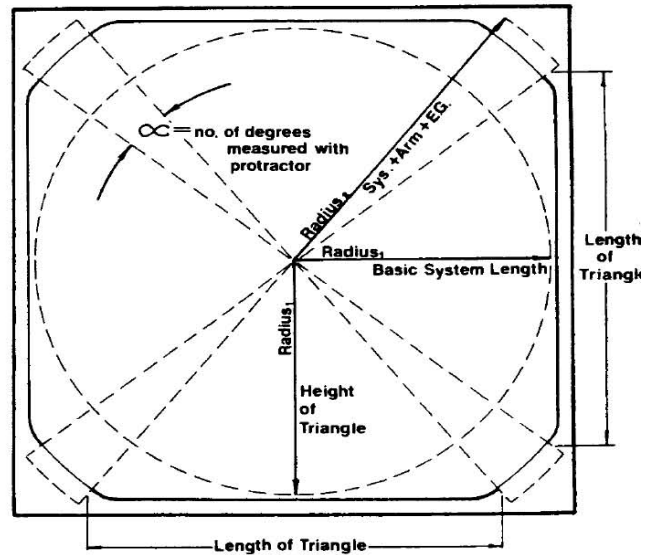

The effective lengths of the Corner System swing arms are:

170' Span = 243'
 185' Span = 258'
 plus
 effective E.G. Coverage (See Water Application Section)

Pages 31-35 Copyrighted © 1994 by Valmont Industries.
 Reprinted by permission.

DETERMINE IRRIGATED ACREAGE

Formulas for calculating acreages in fields and segments are shown below:

1. Area of a square = L^2
 "L" is the length in feet of one side of the square.

if $L = 2640'$
 $L^2 = 2640 \times 2640$
 Area = 6,969,600 sq. ft.
 Acres = $\frac{6,969,600 \text{ ft}^2}{43,560 \text{ ft. sq.}} = 160 \text{ acres}$

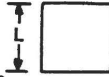

*One (1) Acre = 43,560 ft²

$$\text{Acres} = \frac{\text{ft.}^2}{43,560 \text{ ft. sq.}}$$

2. Area of a rectangular field. (A)

Area = $L_1 \times L_2$
 Area = 2640' x 5280
 = 13,939,200
 Acres = $\frac{13,939,200 \text{ sq. ft.}}{43,560} = 320 \text{ acres}$

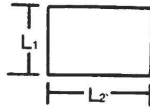

3. Area of a circle

Area = $R^2 \times \pi$
 if $R = 1300$
 $A = 1300^2 \times 3.14$
 = 5,309,291
 Acres = $\frac{5,309,291 \text{ sq. ft.}}{43,560 \text{ sq. ft.}} = 121.88 \text{ acres}$

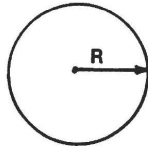

($\pi = 3.1416$)

4. Area of a part circle

Area = $(R^2 \times \pi) \times \frac{\alpha}{(360)^\circ}$
 if $R = 1300$ & $\alpha = 270^\circ$
 Area = $(1300^2 \times 3.14) \times \left(\frac{270^\circ}{360^\circ}\right)$
 = 3,981,968 ft²

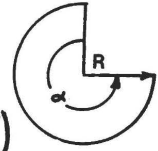

Acres = $\frac{3,981,968 \text{ ft}^2}{43,560 \text{ ft}^2} = 91.41 \text{ acres}$

α = number of degrees, measured with a protractor

5. Area of a triangle

$$\text{Area} = \frac{H \times L}{2}$$

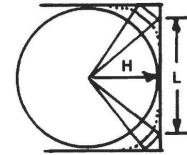

if $H = 1300 \text{ ft.}$
 & $L = 1900 \text{ ft.}$
 Area = $\frac{(1300)(1900)}{2} = 1,235,000 \text{ ft}^2$
 Acres = $\frac{1,235,000}{43560} = 28.4$
 = 1,235,000 ft²

"H" is the same as system length and is equal to the "radius"

"L" is length of the base in the triangle

NOTE: To calculate (estimate) the acreage included in a very irregularly shaped area irrigated by a corner system, draw a straight line or a circular arc that will most nearly provide an "average" boundary.



On the following page you will find several typical examples incorporating the above segment formulas into whole field average calculations.

STANDARD ELEC/WATER DRIVE

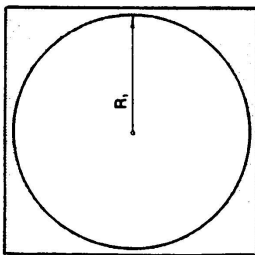

FULL CIRCLE W/O E.G.

$$\begin{aligned} \text{Area} &= \frac{R^2 \pi}{43560} \\ &= \frac{1294 \times 1294 \times 3.1416}{43560} \\ &= 120.7 \text{ Acres} \end{aligned}$$

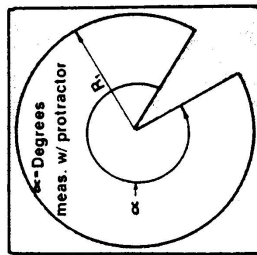

PART CIRCLE W/O E.G.

$$\begin{aligned} \text{Area} &= \left(\frac{R^2 \pi}{43560} \right) \times \left(\frac{\alpha}{360} \right) \\ &= \frac{1294 \times 1294 \times 3.1416}{43560} \times \frac{330}{360} \\ &= 110.7 \text{ Acres} \end{aligned}$$

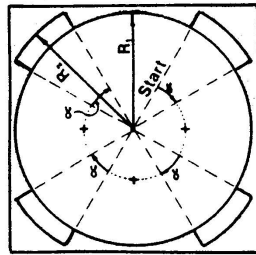

FULL CIRCLE WITH E.G.

$$\begin{aligned} \text{Area} &= \left[\frac{R_1^2 \pi}{43560} \times \left(\frac{360 - 4\alpha}{360} \right) \right] + 4x \left[\frac{R_2^2 \pi}{43560} \times \left(\frac{\alpha}{360} \right) \right] \\ &= \left[\frac{1294 \times 1294 \times 3.1416}{43560} \times \left(\frac{360 - 4 \times 30}{360} \right) \right] + \\ &= 4x \left[\frac{1364 \times 1364 \times 3.1416 \times 30}{43560} \right] \\ &= 125.2 \text{ Acres} \end{aligned}$$

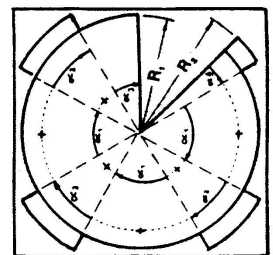

PART CIRCLE WITH E.G.

$$\begin{aligned} \text{Area} &= 3x \left[\frac{R_1^2 \pi}{43560} \times \left(\frac{\alpha_1}{360} \right) \right] + 3x \left[\frac{R_2^2 \pi}{43560} \times \left(\frac{\alpha_2}{360} \right) \right] + \left[\frac{R_1^2 \pi}{43560} \times \left(\frac{\alpha_3}{360} \right) \right] \\ &= 3x \left[\frac{1294 \times 1294 \times 3.1416}{43560} \times \frac{60}{360} \right] + 3x \left[\frac{1364 \times 1364 \times 3.1416 \times 30}{43560} \right] + \left[\frac{1294 \times 1294 \times 3.1416 \times 30}{43560} \right] \\ &= 109.58 \text{ Acres} \end{aligned}$$

CORNER SYSTEMS

FULL CIRCLE - 4 CORNERS

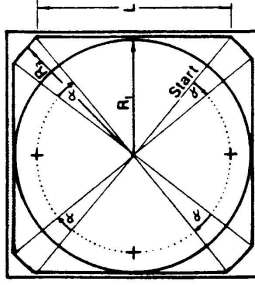

$$\begin{aligned} \text{Area} &= 4x \left[\frac{\left(\frac{R_1 L}{2} \right)^2}{43560} \right] + 4x \left[\frac{R_2^2 \pi}{43560} \times \left(\frac{\alpha}{360} \right) \right] \\ &= 4x \left[\frac{(1268 \times 2100)^2}{43560} \right] + 4x \left[\frac{1581 \times 1581 \times 3.1416 \times 14}{43560} \times \left(\frac{14}{360} \right) \right] \\ &= 150.3 \text{ Acres} \end{aligned}$$

PART CIRCLE

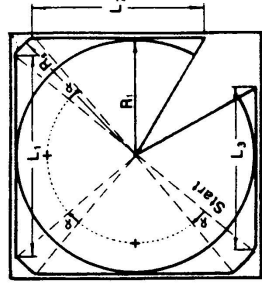

$$\begin{aligned} \text{Area} &= \left[2 \left(\frac{R_1 L_1}{2} \right) + \left(\frac{R_1 L_2}{2} \right) + \left(\frac{R_1 L_3}{2} \right) \right] \frac{1}{43560} + 3x \left[\frac{R_2^2 \pi}{43560} \times \left(\frac{\alpha}{360} \right) \right] \\ &= \left[2 \left(\frac{1268 \times 2100}{2} \right) + \left(\frac{1268 \times 1800}{2} \right) + \left(\frac{1268 \times 1900}{2} \right) \right] \frac{1}{43560} + \\ &= 3x \left[\frac{1581 \times 1581 \times 3.1416 \times 16}{43560} \times \left(\frac{16}{360} \right) \right] \\ &= 139 \text{ Acres} \end{aligned}$$

RECTANGULAR FIELD

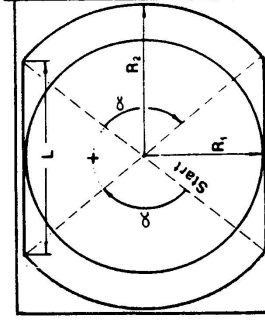

$$\begin{aligned} \text{Area} &= \left[2 \left(\frac{R_1 L}{2} \right) + 2x \left(\frac{R_2^2 \pi}{43560} \times \left(\frac{\alpha}{360} \right) \right) \right] \\ &= \left[2 \left(\frac{1268 \times 2050}{2} \right) + 2x \left(\frac{1581 \times 1581 \times 3.1416 \times 110}{43560} \times \left(\frac{110}{360} \right) \right) \right] \\ &= 169.8 \text{ Acres} \end{aligned}$$

ODD SHAPE FIELD

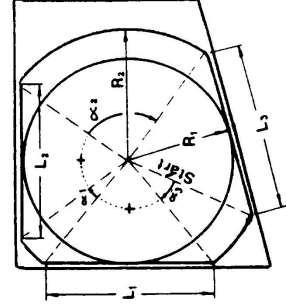

$$\begin{aligned} \text{Area} &= \left[\frac{R_1 L_1}{2} + \left(\frac{R_1 L_2}{2} \right) + \left(\frac{R_1 L_3}{2} \right) \right] \frac{1}{43560} + \left[\frac{R_2^2 \pi}{43560} \times \left(\frac{\alpha_2}{360} \right) \right] + \\ &= \left[\frac{R_2^2 \pi}{43560} \times \left(\frac{\alpha_1}{360} \right) \right] + \left[\frac{R_2^2 \pi}{43560} \times \left(\frac{\alpha_3}{360} \right) \right] \\ &= \left[\frac{1268 \times 1650}{2} + \left(\frac{1268 \times 1700}{2} \right) + \left(\frac{1268 \times 1600}{2} \right) \right] \frac{1}{43560} + \\ &= \left[\frac{1581 \times 1581 \times 3.1416 \times 90}{43560} \times \left(\frac{90}{360} \right) + \left[\frac{1581 \times 1581 \times 3.1416 \times 15}{43560} \times \left(\frac{15}{360} \right) \right] + \right. \\ &= \left. \left[\frac{1581 \times 1581 \times 3.1416 \times 26}{43560} \times \left(\frac{26}{360} \right) \right] \right] \\ &= 137.64 \text{ acres} \end{aligned}$$

NOTE: Lengths & Angles must be measured in the field or from maps, etc./The above dimensions & angles are only typical examples.

Determine Irrigated Acreage

DOT METHOD

The Dot Method can be very useful when calculating areas of non-circular or non-square fields. By simply counting the dots inside the field boundaries, and multiplying by a conversion factor, the acreage is determined. Note, however, that the field or aerial photo must be to a known scale.

1. Draw the field and irrigated area to scale or obtain an aerial photography and draw the system coverage on the photo. A scale of one inch = 660 feet is common with aerial photos and has a conversion factor of 0.156 acres/dot. On drawings of one inch = 330 feet, the conversion factor is 0.0391 acres/dot. Other conversion factors are listed on the overlay.
2. Lay the overlay over the map and insure that it does not shift during the counting process. When dots fall on the area boundary, count every other dot.
3. Note the small squares contain four dots and major squares contain 64 dots; the counting of squares can greatly speed up the computation.
4. After all dots are counted, multiply this sum by the conversion factor to obtain acres.

Corner Machine Acreage Equations — Square Field

1. 170' swing spans:

- a. 85 end gun with 70' EGR

$$\text{Acres} = \frac{(\text{DLRDU}) 1.898}{10,000} \times 1.191$$

- b. 100 end gun with 90' EGR

$$\text{Acres} = \frac{(\text{DLRDU}) 1.898}{10,000} \times 1.876$$

2. 185' swing spans:

- a. 100 end gun with 90' EGR

- b.
$$\text{Acres} = \frac{(\text{DLRDU}) 1.898}{10,000} \times 1.887$$

DLRDU = Distance from pivot to last regular drive unit.

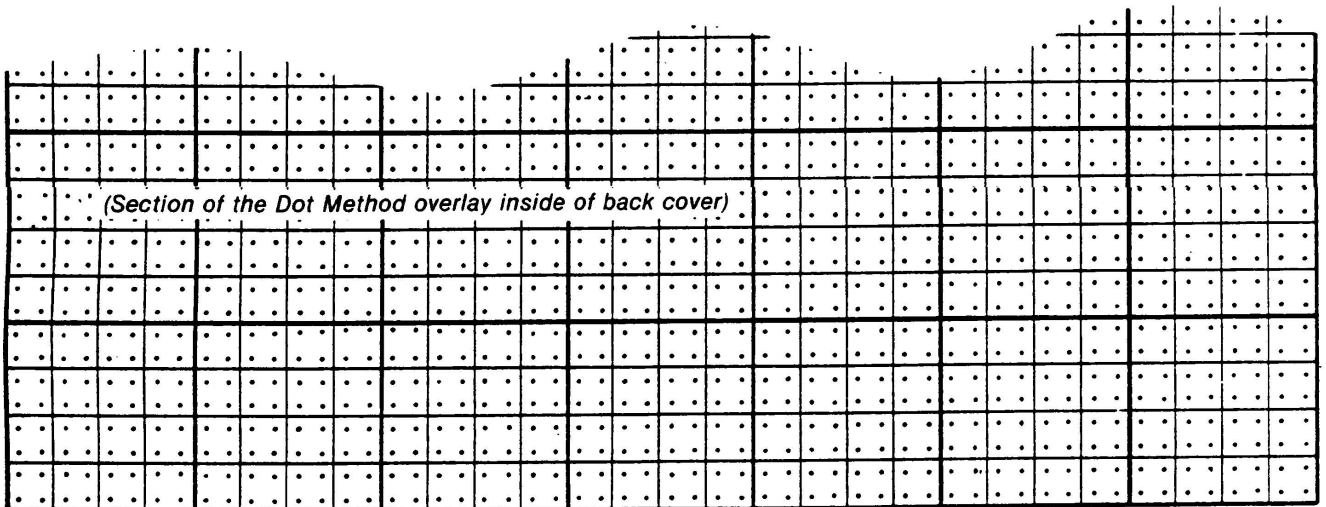

MODIFIED ACREAGE GRID — 64 DOTS PER SQUARE INCH

For maps of any scale, place grid over area to be measured; count dots and multiply by conversion factor to compute acreage. When dots fall on area boundary, count every other dot.

MAP SCALES, EQUIVALENTS, AND CONVERSION FACTORS

Fractional Scale	Inches Per Mile	Acres Per Square Inch	Conversion Factor Each Dot Equals:
1: 7,920	8.00	10.00	0.156 Acres
1: 9,600	6.60	14.692	0.230 Acres
1: 15,840	4.00	40.000	0.624 Acres
1: 20,000	3.168	63.769	0.966 Acres
1: 31,680	2.00	160.000	2.500 Acres
1: 63,360	1.00	640.000	10.000 Acres
1: 125,000	0.507	2,490.980	38.922 Acres
1: 250,000	0.253	9,963.906	155,686 Acres
1: 500,000	0.127	39,855.627	622.744 Acres

APPENDIX F

Fertilizer and Pesticide Containment in Nebraska

Do you have or use pesticide storage containers larger than 500 gallons?

Do you have or use fertilizer containers larger than 2000 gallons or several containers adding to more than 3000 gallons?

Do you apply pesticide or fertilizer solutions for hire?

If you answered yes to any of these questions you may be subject to the secondary containment regulations found in ***Title 198 - Rules and Regulations Pertaining to Agricultural Chemical Containment***, which require secondary containment (diking) and loadout facilities (load or rinse pad). The Title 198 regulations were initially approved in 1992 and amended in 1994 and 1999 and most recently in 2011. The regulations apply to both private and commercial storage, as well as commercial applicators of fertilizers and pesticides. Title 198 is administered by the Nebraska Department of Environment and Energy (NDEE).

When is pesticide containment required? Secondary containment and a loadout facility are required when total bulk pesticide storage capacity exceeds 500 gallons. Even if secondary containment is not required, a custom applicator must have a loadout facility when the custom applicator uses pesticides from original containers larger than 3 gallons or when the custom applicator uses pesticide or fertilizer mixtures of more than 100 gallons.

For example, you have 3 containers of bulk pesticide and each one has a 200 gallon capacity. The combined capacity of the three containers is 600 gallons which exceeds the 500 gallon threshold, so secondary containment and a loadout facility is required.

Another example is a custom applicator who uses pesticides from 2.5 gallon containers but prepares a pesticide mixture that fills a 200 gallon tank mounted on a truck. Since the pesticide mixture exceeds the 100 gallon limit, a loadout facility is required unless all loadout activities (i.e. loading, rinsing, mixing, washing, etc.) are conducted at the application site as part of the normal application.

The secondary containment and loadout facility requirements for pesticide storage and use have been in effect for everyone since January 1, 1995.

When is fertilizer containment required? The situations where bulk fertilizer storage must be contained are a little more complicated. Secondary containment is required when the capacity of a single container exceeds 2,000 gallons, when the capacity of two or more containers exceeds 3,000 gallons, or when fertilizer storage exceeds 25 percent of the container capacity for any container larger than 500 gallons any time between November 1 and March 15. One exception provided for in the 1999 amendment allows the use of one or more containers up to 6,000 gallons of combined capacity at the application site between March 15 and October 1 for up to 21 consecutive days without secondary containment. However, this exception does not apply to containers used in chemigation and is specific to that application site.

For example, a 2,500 gallon stationary fertilizer container requires containment, as do two 1,600 gallon containers (except at the application site as noted above). However, a single 1,600 gallon container does not have to be contained as long as it does not have more than 400 gallons (i.e. 25 percent of 1,600) of fertilizer in it anytime between November 1 and March 15.

A loadout facility is required in conjunction with fertilizer storage when the stored amount exceeds 5,000 gallons. There is an exception for application site loadout activities, which would also apply to 6,000 gallon fertilizer containers used at the application site as noted above.

There are some other special situations and exceptions worth note. By definition anhydrous ammonia, dry fertilizer, and feedlot manure are not considered bulk fertilizer and are not subject to the Title 198 regulations. Normal application site loadout activities are generally exempt from the regulations. Containers designed and used for transportation and application site loadout activities are also excluded.

For example, a 2,500 gallon container mounted on a trailer and moved from application site to application site (such as field to field during the planting season) is not required to have containment or a loadout facility. A 6,000 tip-tank or other similar type container moved to a field and set-up for use in that field between March 15 and October 1 and used for no more than 21 days is also not required to have containment or a loadout facility. However, these containment or loadout exceptions do not apply to trailer mounted or tip-tanks when these containers are used for chemigation or for satellite-type operations to other fields.

The transportation related and 6,000 gallon application site exceptions do not apply to containers used in chemigation. The regulations specify that any container used in the application of a bulk pesticide or bulk fertilizer through a chemigation system is considered storage and subject to the regulations and volume limits as appropriate. For example, a 2,100 gallon container mounted on a truck or trailer and used only for chemigation during the summer is required to have secondary containment. But a single 1,600 gallon container either placed on the ground or on a trailer and used for chemigation is not required to have secondary containment as long as it is not used for storage of more than 400 gallons (i.e. over 25 percent of its capacity) between November 1 and March 15.

There is no registration or permit. However, a construction plan is required and for new facilities it must include either certification from a Nebraska registered engineer that the facility design complies with the regulations or be a generic or standardized design that has been approved by the Department. One such standardized design was submitted and has been approved by the Department for a reinforced concrete facility plans are available on request. Any change to a generic design must be certified by a professional engineer.

As with all its programs, the NDEE encourages voluntary compliance. However, the NDEE can seek court ordered injunctions, fines, or other legal remedies as provided for in the Nebraska Environmental Protection Act in order to obtain compliance with the regulations. The Department will be conducting a number of compliance inspections during the year and has also worked out an agreement with Pesticide Program of the Nebraska Department of Agriculture to provide for some additional inspections.

For specific information or a copy of the Title 198 regulations please contact the Agriculture Section, Nebraska Department of Environment and Energy, P.O. Box 98922, Lincoln, Nebraska 68509, or phone (402)471-4239, or visit our website at www.deq.state.ne.us.

APPENDIX G

Disposing of Livestock Waste Through An Irrigation System

NEBRASKA DEPARTMENT OF ENVIRONMENT AND ENERGY TITLE 130 Chapter 10 — DISPOSAL THROUGH AN IRRIGATION DISTRIBUTION SYSTEM; EQUIPMENT REQUIREMENTS

001 Any irrigation distribution system, except an open discharge system, through which livestock wastes are distributed shall be equipped with one of the mechanical devices specified in Paragraph *002* of this Chapter. The equipment shall be installed in accordance with the manufacturer's specifications and at the location specified. The purpose of this equipment is to prevent livestock wastes or a mixture of livestock wastes and water from being pumped, drained, or siphoned into the irrigation water source.

001.01 A livestock operation proposing to use an irrigation distribution system for disposal shall submit a plan to the Department for its approval detailing the type and location of mechanical devices to be installed.

001.02 An irrigation distribution system which is disconnected from the irrigation water source during livestock waste application shall be considered in compliance with the requirements set forth in this Chapter.

001.03 The Department will conduct an annual inspection of each injection location to determine compliance with this chapter. Inspections conducted by the Natural Resources Districts, pursuant to Title 195 (NAC), Rules and Regulations Pertaining to Chemigation, will qualify as meeting the requirements of this Chapter.

002 Irrigation pipeline check valve assembly. The check valve assembly may be one component or a combination of components consisting of an irrigation pipeline check valve, vacuum relief valve, inspection port and low pressure drain. The assembly shall be located in the pipeline between the irrigation pump and the point of livestock wastes injection into the irrigation pipeline.

002.01 Irrigation pipeline check valve. The check valve shall be located in the pipeline between the irrigation pump and the point of livestock wastes injection into the irrigation pipeline.

002.01A Existing irrigation distribution systems which, as of the date of these rules and regulations, are equipped with a properly located check valve shall be considered in compliance if the valve provides a watertight seal against reverse flow.

002.01B Irrigation distribution systems which are not equipped with a check valve or contain a check valve which after repair cannot provide a watertight seal against reverse flow shall be equipped with a check valve model certified to the director as meeting the leakage test requirements in Appendix C, Title 195 (NAC), Rules and Regulations Pertaining to Chemigation.

002.02 Vacuum relief valve. The vacuum relief valve shall be located on the pipeline between the irrigation pump and the irrigation pipeline check valve. Its purpose is to prevent creation of a vacuum when the water flow stops.

002.03 Inspection port. The inspection port or other viewing device shall be located on the pipeline between the irrigation pump and the irrigation pipeline check valve. In many cases the vacuum relief valve connection can serve as the inspection port.

002.03A The inspection port or viewing device shall be situated in such a manner that the inlet to the low pressure drain can be observed.

002.03B A minimum four-inch diameter orifice or viewing area is required.

002.04 Low-pressure drain. The low-pressure drain shall be located on the bottom of the horizontal pipe between the irrigation pump and the irrigation pipeline check valve. Its purpose is to drain any mixture of water and livestock waste away from the irrigation water source.

002.04A The drain shall be constructed of corrosion resistant material or otherwise coated or protected to prevent corrosion.

002.04B The drain shall have an orifice of at least three-quarter inch diameter and shall not extend into the horizontal pipe beyond the inside surface of the bottom of the pipe; and

002.04C When the pipeline water flow stops, the drain will automatically open. A tube, pipe or similar conduit shall be used to discharge the solution at least 20 feet from the irrigation water source.

Enabling Legislation: Neb. Rev. Stat. §§81-1504(10)(12)(21); 81-1505(10)

Legal Citation: Title 130, Ch. 10, Nebraska Department of Environment and Energy

APPENDIX H

Nebraska Natural Resources Districts

Upper Big Blue NRD

105 Lincoln Avenue
York, NE 68467
Voice: (402) 363-6601
Fax: (402) 362-1849

Lower Big Blue NRD

805 Dorsey Street
Box 826
Beatrice, NE 68310
Voice: (402) 228-3402
Fax: (402) 223-4441

Lower Elkhorn NRD

601 East Benjamin Avenue, Suite 101
Norfolk, NE 68702
Voice: (402) 371-7313
Fax: (402) 371-0653

Little Blue NRD

100 East 6th Street
P.O. Box 100
Davenport, NE 68335
Voice: (402) 364-2145
Fax: (402) 364-2484

Lower Loup NRD

2620 Airport Drive
P.O. Box 210
Ord, NE 68862
Voice: (308) 728-3221
Fax: (308) 728-5669

Lewis & Clark NRD

608 North Robinson Ave.
P.O. Box 518
Hartington, NE 68739
Voice: (402) 254-6758
Fax: (402) 254-6759

Papio-Missouri River NRD

8901 South 154th Street
Omaha, NE 68138-3621
Voice: (402) 444-6222
Fax: (402) 895-6543

Nemaha NRD

62161 Hwy 136
Tecumseh, NE 68450
Voice: (402) 335-3325
Fax: (402) 335-3265

Upper Loup NRD

39252 Hwy 2
P.O. Box 212
Thedford, NE 69166
Voice: (308) 645-2250
Fax: (308) 645-2308

Upper Niobrara-White NRD

430 East 2nd Street
Chadron, NE 69337
Voice: (308) 432-6190
Fax: (308) 432-6187

Middle Niobrara NRD

526 East First
Valentine, NE 69201
Voice: (402) 376-3241 or
Fax: (402) 376-1040

Twin Platte NRD

TierOne Bank Center
111 South Dewey Street
P.O. Box 1347
North Platte, NE 69103-1347
Voice: (308) 535-8080
Fax: (308) 535-8207

Lower Niobrara NRD

410 Walnut Street
P.O. Box 350
Butte, NE 68722
Voice: (402) 775-2343
Fax: (402) 775-2334

Central Platte NRD

215 Kaufman Avenue
Grand Island, NE 68803
Voice: (308) 385-6282
Fax: (308) 385-6285

North Platte NRD

100547 Airport Road
P.O. Box 280
Scottsbluff, NE 69363-0280
Voice: (308) 632-2749
Fax: (308) 632-4346

Lower Platte North NRD

511 Commercial Park Road
P.O. Box 126
Wahoo, NE 68066
Voice: (402) 443-4675
Fax: (402) 443-5339

South Platte NRD

551 Parkland Drive
P.O. Box 294
Sidney, NE 69162-0294
Voice: (308) 254-2377
Fax: (308) 254-2783

Lower Platte South NRD

3125 Portia Street
Lincoln, NE 68501-3581
Voice: (402) 476-2729
Fax: (402) 476-6454

Upper Republican NRD

511 East 5th Street
P.O. Box 1140
Imperial, NE 69033
Voice: (308) 882-5173 or 882-5584
Fax: (308) 882-4521

Lower Republican NRD

30 North John Street
P.O. Box 618
Alma, NE 68920-0168
Voice: (308) 928-2182 or (800) 353-1297
Fax: (308) 928-2317

Middle Republican NRD

220 Center
P.O. Box 81
Curtis, NE 69025
Voice: (308) 367-4281 or 800-873-5613
Fax: (308) 367-4285

Tri-Basin NRD

1723 North Burlington
Holdrege, NE 68949
Voice: (308) 995-6688 or (877) 995-6688
Fax: (308) 995-6992

Upper Elkhorn NRD

301 North Harrison
O'Neill, NE 68763
Voice: (402) 336-3867
Fax: (402) 336-1832

UNL EXTENSION PUBLICATIONS

Following are the titles of several NebGuides and Extension Circulars on topics relating to chemigation. Single copies of these publications are available upon request without charge at local Cooperative Extension offices. Copies of these publications and others are available online at the following URL:

<http://extensionpubs.unl.edu>

EC782	Water Quality Criteria for Irrigation
G1712	Application Uniformity of In-Canopy Sprinklers
G1851	Minimum Center Pivot Design Capacities in Nebraska
G1328	Water Loss from Above-Canopy and In-Canopy Sprinkler
G888	Flow Control Devices for Center Pivot Irrigation Systems
G1124	Converting Center Pivot Sprinkler Packages: System Considerations
G2033	Nebraska Pesticide Container and Secondary Containment Rules
EC3006	Worker Protection Standard for Agricultural Establishments
G1736	Rinsing Pesticide Containers
G1773	Spray Drift of Pesticides
G758	Protective Clothing and Equipment for Pesticide Applicators
EC2505	Managing the Risk of Pesticide Poisoning and Understanding the Signs and Symptoms
EC2008	Irrigation and Nitrogen Management: <i>User Education/Certification Program</i>
EC117	Fertilizer Suggestions for Corn
G1955	Understanding the Pesticide Label
EC2009	Basic Soil and Water Resources and Irrigation Engineering/Agricultural Water Management and Related Terminology
G2000	Tillage and Crop Residue Affect Irrigation Requirements
EC3017	Center Pivot Irrigation Handbook
EC776	Advantages and Disadvantages of Subsurface Drip Irrigation
EC732	Irrigation Efficiency and Uniformity, and Crop Water Use Efficiency
EC2000	Variable Rate Application of Irrigation Water with Center Pivots
EC778	Application of Liquid Animal Manures Using Center Pivot Irrigation Systems
G1850	Irrigation Management for Corn
EC3002	Soil Water Sensors for Irrigation Management
EC3036	Irrigation Scheduling Strategies When Using Soil Water Data
G1367	Irrigating Soybean