



Intermec



**User's
Manual**

**TRAKKER[®] Antares[™]
2425 Hand-Held Terminal**

P/N 064024-001

Intermec® Corporation
6001 36th Avenue West
P.O. Box 4280
Everett, WA 98203-9280

U.S. service and technical support: 1-800-755-5505
U.S. media supplies ordering information: 1-800-227-9947

Canadian service and technical support: 1-800-688-7043
Canadian media supplies ordering information: 1-800-268-6936

Outside U.S. and Canada: Contact your local Intermec service supplier.

The information contained herein is proprietary and is provided solely for the purpose of allowing customers to operate and/or service Intermec manufactured equipment and is not to be released, reproduced, or used for any other purpose without written permission of Intermec.

Information and specifications in this manual are subject to change without notice.

© 1996 by Intermec Corporation
All Rights Reserved

The word Intermec, the Intermec logo, JANUS, IRL, TRAKKER, Antares, Duratherm, Precision Print, PrintSet, Virtual Wedge, and CrossBar are either trademarks or registered trademarks of Intermec Corporation.

Throughout this manual, trademarked names may be used. Rather than put a trademark (™ or ®) symbol in every occurrence of a trademarked name, we state that we are using the names only in an editorial fashion, and to the benefit of the trademark owner, with no intention of infringement.

Contents

Before You Begin xv
 Warranty Information xv
 Safety Summary xv
 Warnings and Cautions xvi
 About This Manual xvii

1

Getting Started

What Is the TRAKKER Antares 2425 Terminal? 1-3
 Accessories for the Terminal 1-4

Using the Terminal for the First Time 1-5
 Unpacking the Terminal 1-5
 Charging the Main Battery Pack 1-6
 Connecting the Backup Battery 1-6
 Installing the Main Battery Pack 1-9
 Charging the Backup Battery 1-13
 Configuring the Controller and Access Point 1-14
 Turning On the Terminal for the First Time 1-15
 Configuring the Terminal 1-17
 Setting the Time and Date 1-17
 Setting the Network Parameters 1-20
 Starting the Application 1-25
 Verifying That the Terminal Is Operating Correctly 1-26

Turning the Terminal On and Off 1-29

Enabling Bar Code Symbolologies 1-30

Where Do You Go From Here? 1-32

2

Learning How to Use the Terminal

TRAKKER 2425 Terminal Features 2-3

Using the Keypad 2-4

Finding the Special Keys 2-4

How to Type the Characters Printed on the Keypad 2-6

Using the Function Left/Right and Shift Keys 2-7

Capitalizing All Characters 2-8

How to Use the Cursor Keys 2-9

Quick Reference Keypad Chart 2-10

How to Use the Terminal's Display 2-11

Using the Display As a Viewport 2-12

Adjusting the Display From the Keypad 2-13

Understanding the Icons 2-15

Understanding the Terminal's Audio Signals 2-18

Learning About the Terminal's Batteries 2-19

Main Battery Pack 2-19

Removing and Installing the Main Battery Pack 2-20

Charging the Main Battery Pack 2-25

Backup Battery 2-26

Charging the Backup Battery 2-26

Removing and Installing the Backup Battery 2-27

Disposing of the NiCad Backup Battery 2-33

Checking the Power Remaining in the Batteries 2-33

Recognizing a Low or Discharged Battery 2-34

Managing Your Battery Power 2-35

Learning About the Terminal's Memory 2-36

Using the Scan Module 2-37

Installing a Scan Module 2-38

Using the Standard Range Scan Module 2-40

Scanning Options 2-42

3

Configuring the Terminal

How to Configure the Terminal 3-3

Learning About Configuration Parameters 3-3

Choosing the Symbologies the Terminal Decodes 3-4

Specifying How the Terminal Will Communicate 3-5

Controlling How the Terminal Will Operate 3-5

Configuring the Terminal With the Menu System 3-6

Exploring the Configuration and System Menus 3-7

Selecting Menus and Commands 3-9

Filling In Fields and Marking Check Boxes 3-10

Entering ASCII Control Characters 3-12

Exiting Screens and Saving Changes 3-14

Exiting the Configuration Menu 3-14

Exiting the TRAKKER 2400 Menu System 3-15

Configuring the Terminal by Scanning Bar Codes 3-17

Saving Configuration Changes in Flash Memory 3-19

Restoring the Terminal's Default Configuration 3-21

Upgrading the Firmware 3-23

Recording Your Terminal's Configuration 3-25

4

Operating the Terminal in a Network

How the TRAKKER 2425 Fits Into Your Network 4-3

Installing and Configuring the Terminal 4-6

Planning the Network Connection 4-6

Configuring the Model 200 Controller 4-7

Configuring the 0100 Access Point 4-7

Configuring the Terminal 4-8
Defining the Network Parameters 4-8

Using RF Communications on the Terminal 4-11
Using the Icons to Monitor Communications 4-12
Using the Terminal Between Access Points 4-14

Configuring the Terminal Over the Network 4-15
Configuring the Terminal From the Controller 4-15
Configuring the Terminal From the Host Computer 4-17

About Network Connectivity and Protocols 4-21

5

Running Applications

Learning About the Terminal Applications 5-3

Starting Your Application 5-4

Using 3270 and 5250 Terminal Emulation 5-5
Using the 3270 or 5250 Keypad 5-6
Configuring 3270 or 5250 TE Parameters 5-8
Configuring Terminal Emulation Screens and Options 5-8
Exiting the TE Configuration Menu 5-12
Understanding Status Line Messages 5-13
Auto-Advancing Through Fields on 5250 TE Screens 5-14

Using VT100/220/320 or ANSI Terminal Emulation 5-16
Using the VTXXX/ANSI Keypad 5-17
Configuring VTXXX/ANSI TE Parameters 5-19
Configuring Terminal Emulation Screens and Options 5-19
Exiting the TE Configuration Menu 5-24

Unsupported TE Functions 5-25

Using 3270 and 5250 Screen Mapping 5-26
 Starting the Screen Mapping Application 5-26
 Running Screen Mapping on Your Terminal 5-27
 Requesting a New Template 5-28
 Loading a Validation File 5-29

Using the Viewport 5-30
 How the Viewport Works 5-30
 Using the Cursor Keys 5-32
 Using the Paging Keys 5-33
 Using the Roll Keys (5250 Only) 5-35

6

Troubleshooting

How to Use This Chapter 6-3

Finding and Solving Problems 6-4
 Terminal Will Not Turn On 6-5
 Problems While Operating the Terminal 6-6
 Problems While Configuring the Terminal 6-10
 Terminal Will Not Communicate With Network Devices 6-13
 Problems Using Terminal Emulation Applications 6-15
 Problems Using the Screen Mapping Application 6-18
 Bar Code Labels Will Not Scan 6-23
 Guidelines for Managing Batteries 6-26

Booting and Resetting the Terminal 6-28
 Booting the Terminal 6-28
 Booting the Terminal on Resume 6-28
 Using the Boot Menu 6-29
 Resetting the Terminal 6-30

Maintaining and Cleaning the Terminal 6-31
 Replacing the Antenna 6-32
 Cleaning the Scan Module Window and Display 6-34

Running Diagnostics 6-35

Running Diagnostics From the Menu System 6-36

Defining the Diagnostics Screens 6-39

Defining the Software Diagnostics Screens 6-40

Application Events 6-40

Clear Task Profile 6-41

Error Logger 6-42

Task Status 6-43

Defining the Hardware Diagnostics Screens 6-44

Battery Monitor 6-44

Battery Status 6-45

Beeper Test 6-46

Destructive RAM Test 6-47

Display Test 6-48

Hardware Configuration 6-49

Keypad Test 6-50

Radio Test 6-51

RS-232 Loop Back 6-52

Scanner Test 6-53

Defining the System Diagnostics Screens 6-54

Access Point 6-54

Subsystem Versions 6-55

Suspend-Resume Test 6-56

7

Reader Command Reference

Using Reader Commands 7-3

Using Accumulate Mode 7-4

Enter Accumulate Mode 7-6

Backspace 7-6

Clear 7-6

Enter 7-7

Exit Accumulate Mode 7-7

Operating Reader Commands 7-8
Backlight On and Off 7-9
Change Configuration 7-10
Default Configuration 7-11
Multiple-Read Labels 7-12
Reset Firmware 7-13
Scanner Trigger On and Off 7-14
Test and Service Mode 7-15

8

Configuration Command Reference

Using Configuration Commands 8-3
Configuration Commands Listed by Category 8-4
Entering Variable Data in a Configuration Command 8-5
Append Time 8-6
Automatic Shutoff 8-7
Beep Volume 8-8
Codabar 8-10
Code 11 8-12
Code 16K 8-13
Code 2 of 5 8-14
Code 39 8-16
Code 49 8-20
Code 93 8-22
Code 128 8-23
Command Processing 8-25
Controller IP Address 8-29
Decode Security 8-31
Default Router 8-32
Display Backlight Timeout 8-34

TRAKKER Antares 2425 Hand-Held Terminal User's Manual

Display Contrast 8-36
Interleaved 2 of 5 8-37
Keypad Caps Lock 8-39
Keypad Clicker 8-40
MSI 8-41
Network Activate 8-43
Network Loopback 8-44
Plessey 8-45
Postamble 8-46
Preamble 8-48
Resume Execution 8-50
RF Domain 8-51
RF Security Identification 8-52
RF Wakeup On Broadcast 8-54
Scan Ahead 8-55
Scanner Mode 8-56
Scanner Redundancy 8-57
Scanner Selection 8-59
Scanner Timeout 8-60
Scanner Trigger 8-61
Subnet Mask 8-62
Terminal IP Address 8-64
Time and Date 8-66
Time in Seconds 8-67
UDP Port 8-68
UPC/EAN 8-70

9**3270 and 5250 TE Command Reference****Command Descriptions 9-3**

Attention 9-3
Backtab 9-4
Clear 9-4
Cursor Home 9-5
Delete 9-5
End 9-5
Enter 9-6
Enter TE Configuration Menu 9-6
Erase Input 9-6
Erase to End of Field 9-7
Error Reset 9-7
Fast Cursor Right or Left 9-8
Field+ and Field- 9-9
Field Exit 9-10
Help 9-10
Home 9-11
Insert 9-11
New Line 9-11
Paging Keys (Viewport) 9-12
Reset 9-13
Roll Up and Roll Down 9-13
Scroll Viewport Keys 9-14
Status 9-15
System Request 9-15
Tab 9-16

Program Function Keys 9-17**Program Attention Keys for 3270 Terminals 9-21****Other Keys 9-22**

10

VT100/220/320 and ANSI TE Command Reference

Editing Key Commands for VT220/320 Terminals 10-3

Backspace 10-3

End 10-3

Find 10-4

Home 10-4

Insert 10-4

Next Screen 10-4

Paging Keys (Viewport) 10-5

Previous Screen 10-6

Remove 10-6

Select 10-6

Program Function Keys 10-7

Additional Functions 10-10

A

Appendix A – Terminal Specifications

Physical and Environmental Specifications A-3

Default Configuration A-7

Configuration Commands by Syntax A-10

B

Appendix B – Full ASCII Charts

Full ASCII Table B-3

Full ASCII Bar Code Chart B-6

Control Characters B-6

Symbols and Punctuation Marks B-8

Numbers B-10

Uppercase Letters B-11

Lowercase Letters B-12

C

Appendix C – Terminal Emulation Command Reference

3270 and 5250 TE Command Summary C-3

3270 and 5250 TE Keypad C-3

3270 and 5250 TE Command Summary C-5

3270 and 5250 Additional Functions C-9

VT100/220/320 and ANSI TE Command Summary C-10

VTXXX/ANSI TE Keypad C-10

VTXXX/ANSI TE Command Summary C-11

VTXXX/ANSI Additional Functions C-13

Program Function Keys C-14

G

Glossary

I

Index

Before You Begin

This section introduces you to standard warranty provisions, safety precautions, warnings and cautions, document formatting conventions, and sources of additional product information. A list of Intermec manuals is also provided to guide you in finding the appropriate information.

Warranty Information

To receive a copy of the standard warranty provision for this product, contact your local Intermec support services organization. In the U.S. call 1-800-755-5505, and in Canada call 1-800-688-7043. Otherwise, refer to the Worldwide Sales & Service list that ships with this manual for the address and telephone number of your Intermec sales organization.

Safety Summary

Your safety is extremely important. Read and follow all warnings and cautions in this book before handling and operating Intermec equipment. You can be seriously injured, and equipment and data can be damaged if you do not follow the safety warnings and cautions.

Do not repair or adjust alone Do not repair or adjust energized equipment alone under any circumstances. Someone capable of providing first aid must always be present for your safety.

First aid Always obtain first aid or medical attention immediately after an injury. Never neglect an injury, no matter how slight it seems.

Resuscitation Begin resuscitation immediately if someone is injured and stops breathing. Any delay could result in death. To work on or near high voltage, you should be familiar with approved industrial first aid methods.

Energized equipment Never work on energized equipment unless authorized by a responsible authority. Energized electrical equipment is dangerous. Electrical shock from energized equipment can cause death. If you must perform authorized emergency work on energized equipment, be sure that you comply strictly with approved safety regulations.

Note: For laser compliance and safety information, refer to the TRAKKER Antares 2425 Manual Supplement that is shipped with your terminal.

Warnings and Cautions

The warnings and cautions in this manual use the following format.



Warning

A warning alerts you of an operating procedure, practice, condition, or statement that must be strictly observed to avoid death or serious injury to the persons working on the equipment.

Avertissement

Un avertissement vous avertit d'une procédure de fonctionnement, d'une méthode, d'un état ou d'un rapport qui doit être strictement respecté pour éviter l'occurrence de mort ou de blessures graves aux personnes manipulant l'équipement.



Caution

A caution alerts you to an operating procedure, practice, condition, or statement that must be strictly observed to prevent equipment damage or destruction, or corruption or loss of data.

Conseil

Une précaution vous avertit d'une procédure de fonctionnement, d'une méthode, d'un état ou d'un rapport qui doit être strictement respecté pour empêcher l'endommagement ou la destruction de l'équipement, ou l'altération ou la perte de données.

Notes: Notes are statements that either provide extra information about a topic or contain special instructions for handling a particular condition or set of circumstances.

About This Manual

This manual contains all of the information necessary to install, configure, operate, and troubleshoot the TRAKKER® Antares™ 2425 terminal.

This manual was written for two audiences:

- All users who need to know how to use the terminal to collect data.
- MIS personnel, operations personnel, analysts, and programmers who need to know how to install, configure, test, and use the terminal to operate in a 2.4 GHz radio frequency network. You should have a good knowledge of your company's network and data collection software. You should be familiar with data communications and network protocols.

What You Will Find in This Manual

This table summarizes the information in each chapter and appendix.

| Chapter | What You Will Find |
|---------|---|
| 1 | Summarizes the terminal's features, functions, and accessories. Describes how to unpack your new terminal and get it started for the first time. |
| 2 | Explains how to use the terminal's keypad, display, audio signals, batteries, and scan modules. |
| 3 | Explains how to change the terminal's configuration. |
| 4 | Describes the 2.4 GHz radio frequency network and explains how to install and configure the terminal to communicate with other devices in the network. |
| 5 | Explains how to configure and use the terminal to emulate IBM 3270, IBM 5250, or VT100/220/320 and ANSI terminals. Provides instructions for configuring and running the applications firmware that ships with your terminal. |
| 6 | Lists solutions for the problems you may have while operating the terminal. Explains how to use the terminal's diagnostics to research and troubleshoot problems. |
| 7 | Describes the commands that change the terminal's operation. |
| 8 | Describes the commands that change the terminal's configuration. |

What You Will Find in This Manual (continued)

| Chapter | What You Will Find |
|---------|--|
| 9 | Lists all of the terminal emulation commands you can use on the TRAKKER 2425 terminal to emulate IBM 3270 or 5250 terminals. |
| 10 | Lists all of the terminal emulation commands you can use on the TRAKKER 2425 terminal to emulate VT100/220/320 and ANSI terminals. |
| A | Presents the terminal's specifications, lists the configuration command names and syntax, and describes the terminal's default configuration settings. |
| B | Contains reference tables including the full ASCII table and full ASCII bar code chart. |
| C | Provides a summary of available terminal emulation (TE) commands for all supported terminals. A keypad chart shows how to enter all characters on each TE keypad and lists bar codes for performing the same function. |

Terminology

You should be aware of how these terms are being used in this manual:



















| Term | Description |
|-----------------|---|
| T2425 | The term "T2425" indicates the specific type of terminal, the TRAKKER 2425 terminal. |
| Terminal | The generic term "terminal" indicates any TRAKKER 2400 series terminal. More specific terms, such as "TRAKKER 2425 terminal" or "T2425" indicate a specific type of terminal. |
| TRAKKER 2400 | The term "TRAKKER 2400" indicates any terminal in the TRAKKER 2400 series of hand-held data collection terminals. |
| TRAKKER Antares | The term "TRAKKER Antares" identifies the product family. The terms TRAKKER 2425 and T2425 are used in this manual to identify the TRAKKER Antares 2425 terminal. |

For definitions of the technical terms used in this manual, see the glossary.



Conventions for Input From a Keypad or Keyboard

This table describes the formatting conventions for input from PC or host computer keyboards and terminal keypads:

| Convention | How to Interpret the Convention |
|---|--|
| Special text | Shows the command as you should enter it into the terminal. See “Conventions for Commands” later in this chapter. |
| <i>Italic text</i> | Indicates that you must replace the parameter with a value. See “Conventions for Commands” later in this chapter. |
| Bold text | Indicates the keys you must press on a PC or host computer keyboard. For example, “press Enter ” means you press the key labeled “Enter” on the PC or host computer keyboard. |
|  | Shows the key you must press on the terminal. For example, “press  ” directs you to press the Enter key on the terminal keypad. |
|      | Shows a series of terminal keys you must press and release in the order shown. For example, “Press      to run the TRAKKER 2400 Menu System.” |
|  -  -  | Shows a series of terminal keys you must press simultaneously. Also, you must press and hold the keys in the order shown. For example, “Press  -  -  to reset the terminal.” |

Conventions for Bar Codes

You can scan the bar codes listed in this manual to enter data or perform a command. The bar code labels in this manual are printed in the Code 39 symbology. Each bar code includes the name and human-readable interpretation. For example:

Change Configuration ——— Name
 ——— Bar code (Code 39)
\$+ ——— Human-readable interpretation

242XU.146

The asterisks (*) at the beginning and end of the human-readable interpretation are the start and stop codes for a Code 39 bar code label. If you are using a bar code printing utility, it may automatically supply the asterisks as the start and stop code, so that you only need to type the actual text of the command. You can also create and print configuration labels and reader command labels in Code 93, which has its own start and stop codes.

Conventions for Software Screens and Messages

This manual includes illustrations that represent how the TRAKKER 2425 terminal displays software screens and messages. Here are two examples:

```
MAIN MENU
Configuration Menu
Diagnostics Menu
System Menu
About TRAKKER 2400

↑↓ Select item
[Enter] Next screen
[F1] Help
[Esc] Exit
```

```
File Name:
```

242XU.007



Conventions for Commands

This manual includes sample commands that are shown exactly as you should type them on your terminal or network device. The manual also describes the syntax for many commands, defining each parameter in the command. This example illustrates the format conventions used for commands:

To send a configuration command from the Model 200 Controller, use this syntax:

```
$+command[command]...[command n]
```

where:

- \$+* is the Change Configuration command.
- command* is a configuration command. For example, BV is the command to set the Beep Volume on the terminal. Enter the command BV0 to turn off the beep volume.

You can include multiple configuration *command* parameters in the command to configure the terminal.

This table defines the conventions used in the example:

| Convention | Description |
|---------------------|---|
| Special font | Commands appear in this font. You enter the command exactly as it is shown. |
| <i>Italic text</i> | Italics indicate a variable, which you must replace with a real value, such as a number, filename, keyword, or command. |
| [] | Brackets enclose a parameter that you may omit from the command. Do not include the brackets in the command. |
| Required parameters | If a parameter is not enclosed in brackets [], the parameter is required. You must include the parameter in the command; otherwise, the command will not execute correctly. |
| where | This word introduces a list of the command's parameters and explains the values you can specify for them. |

TRAKKER Antares 2425 Hand-Held Terminal User's Manual

Other Intermec Manuals

You may need to refer to the manuals listed below for additional information about your TRAKKER 2425 terminal or 2.4 GHz radio frequency network. To order additional manuals, contact your local Intermec representative or distributor.

| Manual | Intermec Part No. |
|---|------------------------------|
| <i>0100 Access Point User's Manual</i> | 062367 |
| <i>The Bar Code Book</i> | 051241 |
| <i>Model 200 Controller System Manual</i> | 063439 |
| <i>Model 200 Controller Technical Reference Manual</i> | 064398 |
| <i>TRAKKER 2400 Series Application Development Tools System Manual</i> | 064433 |
| <i>TRAKKER 2400 Series Belt Clip Instruction Sheet</i> | 064218 |
| <i>TRAKKER 2400 Series Handstrap Instruction Sheet</i> | 064217 |
| <i>TRAKKER 2400 Series Holster Instruction Sheet</i> | 064215 |
| <i>TRAKKER 2400 Series Module for Cabled Scanners Instruction Sheet</i> | 064219 |
| <i>TRAKKER 2400 Series Standard Range Scan Module Instruction Sheet</i> | 064220 |
| <i>TRAKKER 2400 Series Vehicle-Mount Holder Instruction Sheet</i> | 064214 |
| <i>TRAKKER 2425 Hand-Held Terminal Getting Started Guide</i> | 064183 |

1

Getting Started

This chapter introduces the TRAKKER® Antares™ 2425 terminal and explains how to get your new terminal up and running.

What Is the TRAKKER Antares 2425 Terminal?

The TRAKKER Antares 2425 terminal (T2425) is a hand-held data collection terminal. You use the terminal to collect and transmit data via radio communications in a 2.4 GHz network. The T2425 ships loaded with the terminal emulation or screen mapping application you ordered. You can use the terminal to emulate 3270, 5250, or VT100/220/320 and ANSI terminals.

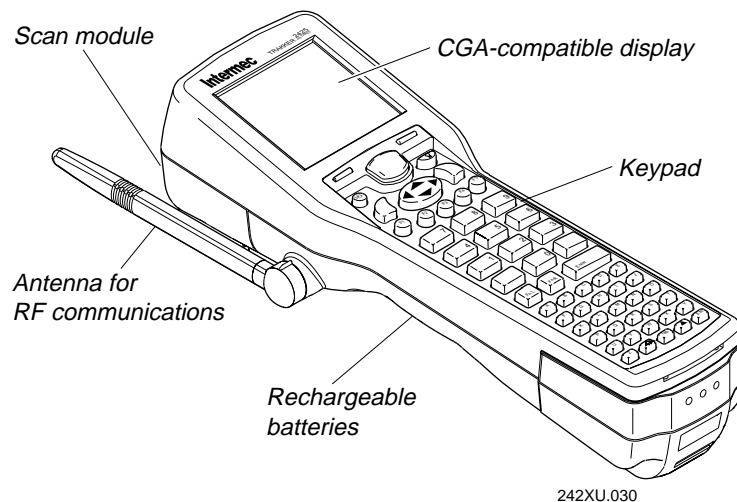

The T2425 is ergonomically designed to make data collection easy and includes these features:

- Keypad with 56 keys to support data collection. The terminal ships with a keypad to match the application you ordered.
- Rechargeable lithium-ion battery pack (shipped separately) for main power and rechargeable NiCad backup battery for memory backup
- 16 line by 20 character CGA-compatible display, angled for easy viewing
- Adjustable antenna for 2.4 GHz radio frequency communications
- Scan module accessories for bar code data collection

Accessories for the Terminal

You can use these accessories with the TRAKKER 2425 terminal:

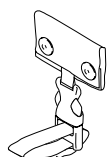

Belt Clip The belt clip lets you attach the terminal to your belt and have it hang at your side so you can have both hands free. The belt clip snaps around your belt and a Velcro strap holds the terminal to the belt clip.

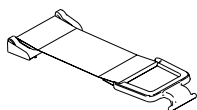

Handstrap The elastic handstrap attaches to the back of the terminal to let you hold the terminal easily and securely for long periods of use.

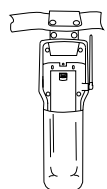

Holster The holster is a convenient way for you to carry the terminal on your belt when you are not using it. The holster attaches to your belt and holds the terminal at your side.

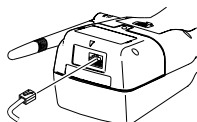

Module for Cabled Scanners This module has a scanner port that lets you attach a wand, laser scanner, or CCD scanner for bar code data collection.



Standard Range Scan Module The standard range laser scan module works as an integrated scanner that lets you scan bar code labels from up to 30 inches away depending on the bar code height and density.



Vehicle-Mount Holder You can attach this holder to a vehicle, such as a forklift, so that you can securely store the terminal while the vehicle is moving.

Note: You also need a main lithium-ion battery pack and a battery charger to charge the main lithium-ion battery pack. See your Intermec sales representative for the main battery packs and battery chargers that are currently available.

Using the Terminal for the First Time

Follow these steps to start using your new TRAKKER 2425 terminal:

1. Unpack the terminal and documentation.
2. Charge the main battery pack (ordered separately).
3. Connect the backup battery.
4. Install the charged main battery pack.
5. Charge the backup battery.
6. Configure the Model 200 Controller and 0100 Access Point.
7. Turn on the terminal.
8. Configure the terminal.
9. Start the terminal emulation or screen mapping application.
10. Verify that the terminal is operating correctly.

These steps are described in detail in the next sections.

Unpacking the Terminal

When you remove the terminal from its box, save the box and shipping material in case you need to ship or store the terminal. Check the contents of the box against the invoice for completeness and contact your local Intermec service representative if there is a problem. The shipping box contains:

- TRAKKER 2425 hand-held terminal
- *TRAKKER 2425 Hand-Held Terminal Getting Started Guide*
- *TRAKKER 2425 Manual Supplement*
- *Lithium-Ion Battery Safety Instruction Information*
- Standard range scan module or module for cabled scanners
- Scan module documentation

You also need a lithium-ion battery pack and battery charger. Both accessory items are shipped separately. You should have two lithium-ion battery packs so that you can use one battery while the other is recharging.

Charging the Main Battery Pack

The terminal's main battery pack is a lithium-ion battery. You must fully charge the battery pack before you can use the terminal. The battery pack is the main power source for the terminal.

To charge the main battery pack

- Place the battery pack in an empty slot in the battery charger. The battery pack is fully charged in about 2 hours.

For help, see the documentation that came with your battery charger.

Tip: Keep a spare charged main battery pack on hand to operate the terminal without interruption.

Connecting the Backup Battery

The backup battery is a NiCad battery that backs up all memory and the real-time clock while you change the main battery pack. The backup battery is shipped inside the terminal, but it is not connected.

To connect the backup battery

1. Open the battery door by pushing down on the battery door latch and sliding it toward the bottom end of the terminal. Lift up the top edge of the battery door to remove it.

Opening the Battery Door

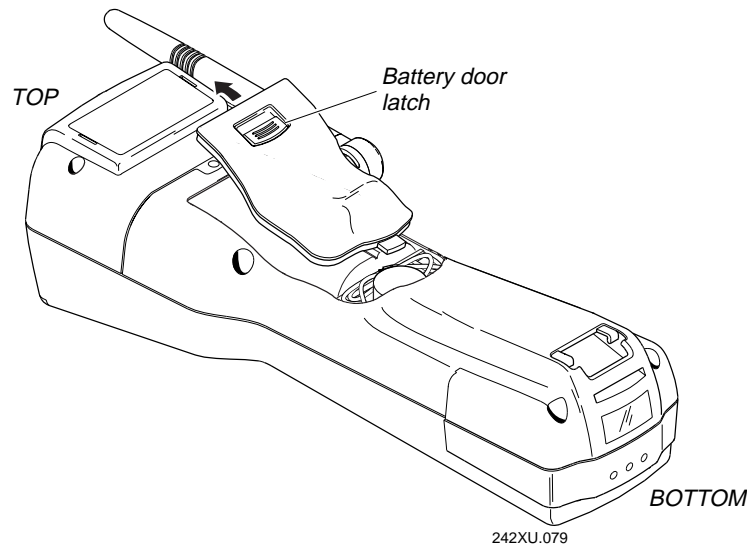

2. Find the two connectors in the backup battery compartment. One connector is attached to the backup battery. The other connector is attached to the terminal. Firmly push the two battery wire connectors together until they lock.

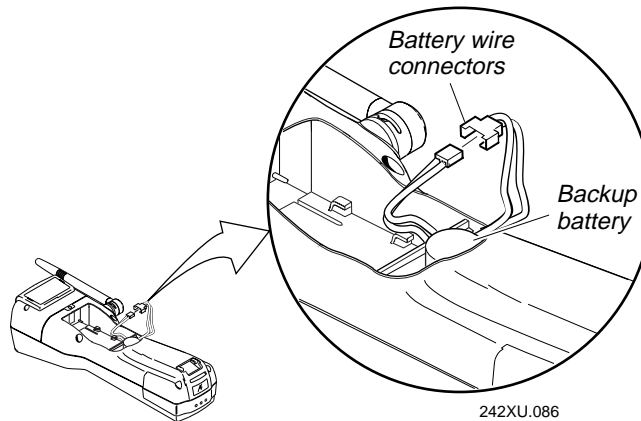

3. Gently fold and push the backup battery wires into the open area of the backup battery compartment near the wall.

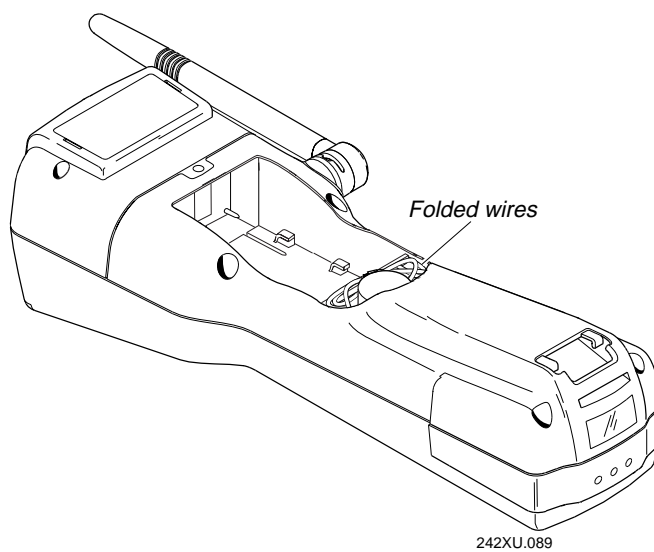

4. Leave the battery door off to continue with the next procedure and install the main battery pack.

Installing the Main Battery Pack

Next, install the fully charged main (lithium-ion) battery pack into the TRAKKER 2425 terminal.

Note: You should always keep a charged main battery pack installed in the terminal to maximize the backup battery's life.

To install the main battery pack

1. If the battery door is not off, open the battery door by pushing down on the battery door latch and sliding it toward the bottom end of the terminal. Lift up the top edge of the battery door to remove it.

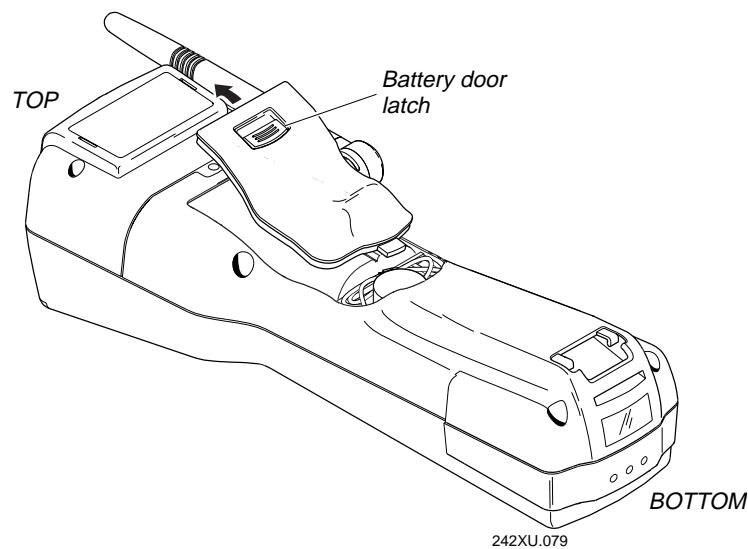

2. Hold the battery pack with the flat side facing down toward the inside of the battery compartment. The small arrow on the top of the battery pack must point toward the top (display) end of the terminal.

3. Place the battery pack into the upper (larger) half of the battery compartment.

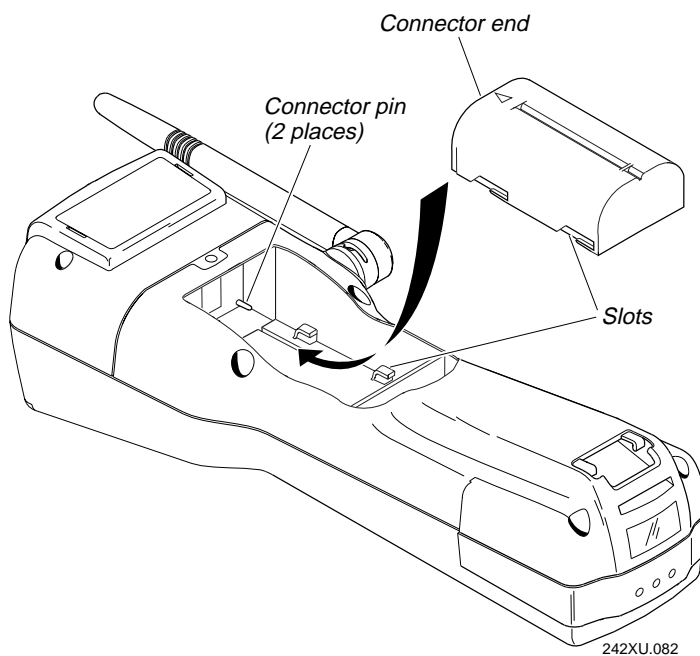

4. Hook the slots on the bottom of the battery pack into the slots on the bottom of the battery compartment.
5. Slide the battery pack toward the top end of the terminal until it fits and locks into the connectors inside the bottom case. The battery pack must be all of the way forward to close the battery door.

Installing the Battery Pack

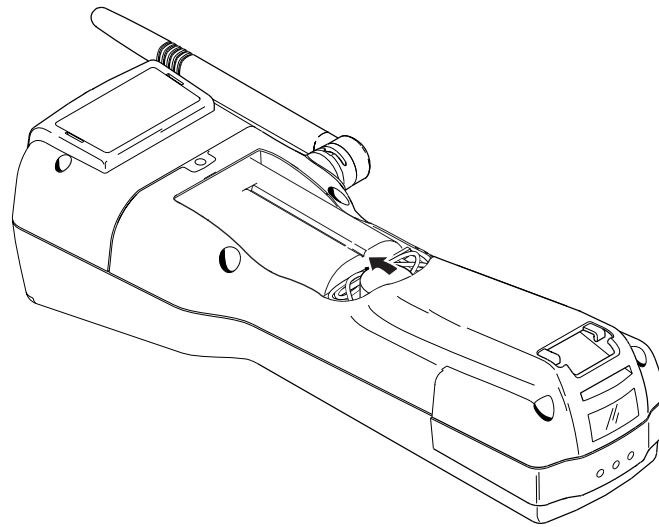

242XU.102

6. On the inside of the battery door, make sure the rubber bumper is installed over the ridge near the wall. The rubber bumper keeps the battery pack in place.

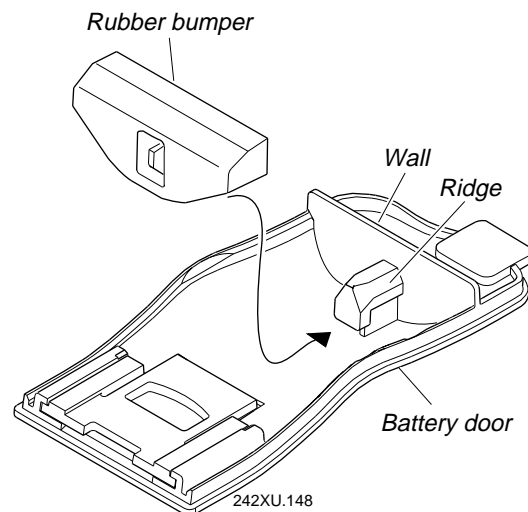

242XU.148

7. Hook the bottom edge of the battery door into the bottom case above the backup battery compartment. Push the door down to close it over the battery compartment. Push the battery door latch down and slide it toward the top end of the terminal to lock the door in place.

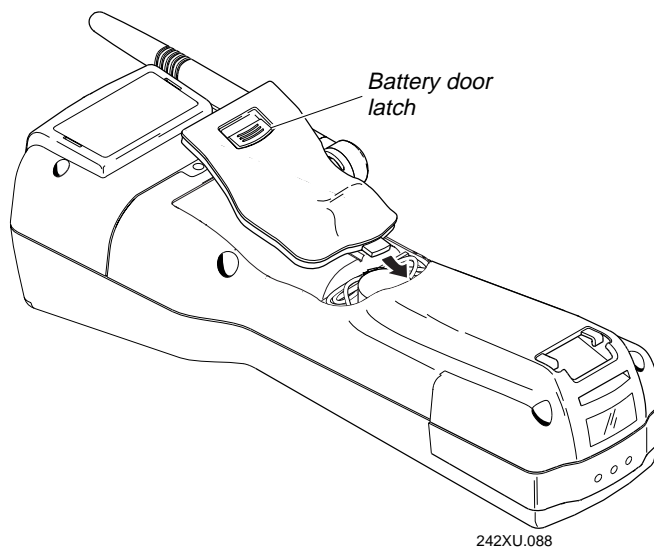

Note: *If the battery door will not shut, the battery pack is not correctly installed. Remove the battery pack and repeat Steps 2 through 6 to install the battery pack.*

Charging the Backup Battery

You must fully charge the backup battery. The main battery pack charges the backup battery when required with the terminal turned on or off.

Note: *The backup battery charger operates between 32°F and 104°F (0°C and 40°C). If you are using the terminal in an environment that is outside this temperature range, the backup battery will not charge.*

To charge the backup battery

1. Install a fully charged main battery pack. For help, see “Installing the Main Battery Pack” earlier in this chapter.
2. Leave the terminal turned off and let the main battery pack charge the backup battery. The backup battery will be fully charged in approximately 18 hours. After you finish charging the backup battery, the main battery pack still has most of its power remaining.

Note: *The backup battery charges enough within 20 minutes to operate the terminal. However, the backup battery will only provide limited backup power if it is not fully charged.*

Configuring the Controller and Access Point

The TRAKKER 2425 terminal can communicate with a host computer in Intermecc's 2.4 GHz network through the 0100 Access Point, the Model 200 Controller, and your Ethernet network.

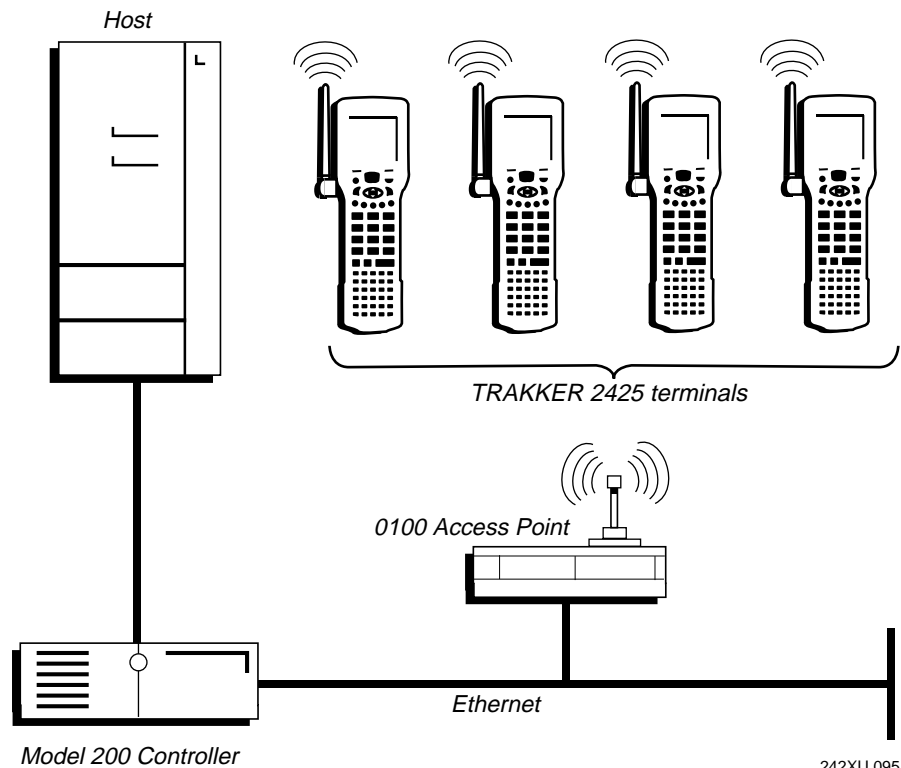

242XU.095

Note: All devices in the 2.4 GHz network must have an IP address. All access points that the TRAKKER 2425 may communicate with must be in the same IP subnetwork. For help, see Chapter 4, "Operating the Terminal in a Network."

To use your T2425 terminal in Intermecc's 2.4 GHz network, you must first install the Model 200 Controller and the 0100 Access Point. For help, see the *Model 200 Controller System Manual* (Part No. 063439) and the *0100 Access Point User's Manual* (Part No. 062367).

To configure the terminal, you must know the value of these parameters:

- Controller IP address
- Terminal IP address (for each T2425 terminal in the network)
- RF domain (access point)
- RF security identification (ID) (optional) (access point)

Once you have configured the controller and access point, you can configure the terminal for the 2.4 GHz network.

Turning On the Terminal for the First Time

Once the batteries are charged and a scan module is installed, you are ready to turn on the terminal and configure it.

Important: *You must have a scan module attached to use the terminal. A scan module is usually installed at the Intermec factory. For help, see "Using the Scan Module" in Chapter 2.*

To turn on the terminal

1. Press the  key on the top left of the keypad. The TRAKKER Antares screen appears.



Note: If the TRAKKER Antares screen does not appear, you may have a problem with the batteries. Make sure the main battery pack is fully charged and installed correctly. Make sure a scan module is installed correctly. For help, see Chapter 6, "Troubleshooting."

Once the terminal has finished initializing the firmware, this warning screen appears. The terminal creates a configuration file the first time you turn it on.

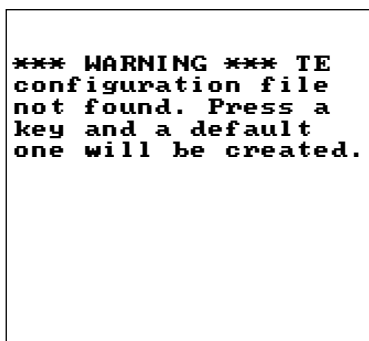

```
*** WARNING *** TE
configuration file
not found. Press a
key and a default
one will be created.
```

242XU.129

2. Configure the terminal now. Follow the instructions in the next section, "Configuring the Terminal."

Note: To configure the terminal, press and start the TRAKKER 2400 Menu System. If you press any other key, you will see messages that the terminal cannot connect to the controller. Follow the instructions in the next section, "Configuring the Terminal."

Configuring the Terminal

You need to set these network parameters to begin using the terminal:

- Time and date
- Network activate
- Controller IP address
- Terminal IP address
- RF domain
- RF security identification (ID)

You use the TRAKKER 2400 Menu System to set these parameters.

Note: *If the terminal is on a different IP subnetwork from the Model 200 Controller, you must also configure the default router and subnet mask. For help, see Chapter 4, “Operating the Terminal in a Network.”*

Setting the Time and Date

If you have not turned on the terminal, follow the instructions for “Turning On the Terminal for the First Time” earlier in this chapter.

1. Press **[f]** **[↵]** **[T]** **[2]** **[M]** or scan this bar code label to access the TRAKKER 2400 Menu System.

Enter Test and Service Mode



..-.

Note: *You must press the **[↵]** (Left Enter) key in this key sequence. The **[↵]** key is located just under the **[V]** key.*

The Main Menu appears.

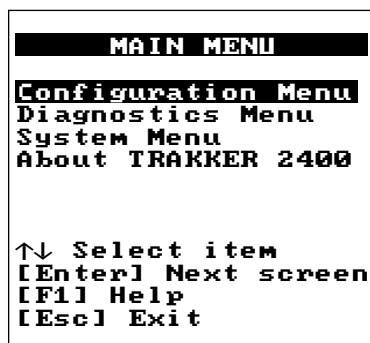

242XU.001

2. Press ▼ twice to choose the System Menu and then press . The System Menu appears.

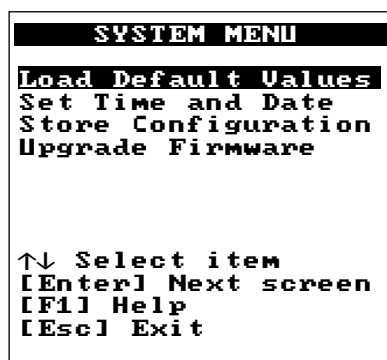

242XU.051



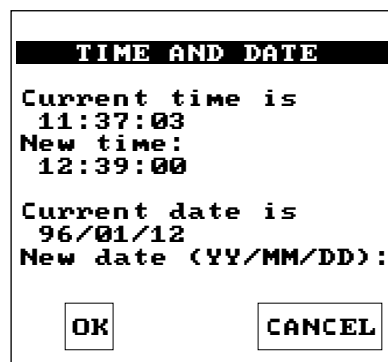





- Press ▼ to choose the Set Time and Date command and then press . The Time and Date screen appears.



242XU.009

- Type the current time in the format HH MM SS with a space character between each field and then press ▼. The program fills in the colon character in the time field.









For example, to enter the time 08:05:03, type:



        ▼

Note: The time is not actually updated until you exit the Time and Date screen. When you set the time, set the time ahead so that the correct time is saved when you exit the screen in Step 6.

- Type the current date in the format YY MM DD with a space character between each field and then press ▼. The program fills in the slash character in the date field.

For example, to enter the date August 9, 1996, type:

        ▼

- Press  to save the changes and exit the Time and Date screen.
- Press  to exit the System Menu. The Main Menu appears. Continue with the next procedure to set the required network parameters.





Setting the Network Parameters

In this procedure, you activate network communications and set your controller and terminal IP addresses. You also need to set the RF domain and RF security identification password. For a detailed definition of these parameters, see Chapter 4, "Operating the Terminal in a Network."

To set the network parameters

1. Press ▼ to choose the Configuration Menu and then press . The Configuration Menu appears.

Note: If you are not in the TRAKKER 2400 Menu System, press

     *to access the Main Menu.*

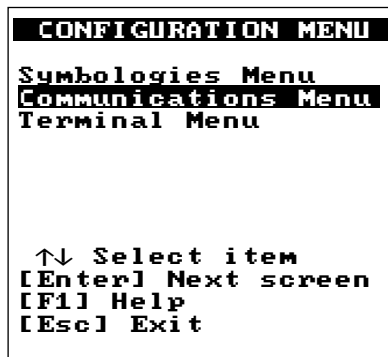

242XU.010

2. Press ▼ to choose the Communications Menu and then press . The Communications Menu appears.

Communications Menu

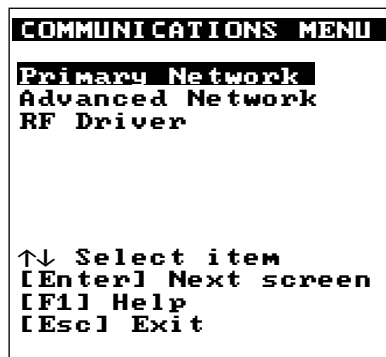

242XU.011

3. Press to choose the Primary Network command. The Primary Network screen appears.

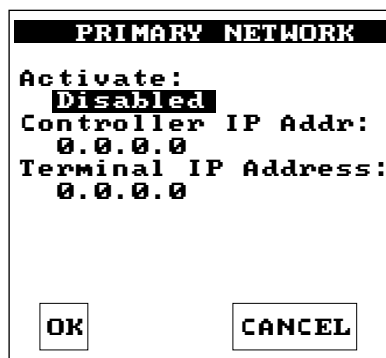

242XU.012

4. In the Activate field, press to toggle the field and display the 2.4 GHz RF option and activate radio frequency network communications. Press to move to the next field.
5. In the Controller IP Address field, type in the IP address for the Model 200 Controller in your network.

The address field consists of four separate numbers. Each number in the field is separated by a period and can be a number from 0 to 255. Type the address in the format nnn.nnn.nnn.nnn and then press ▼.

For example, if your Controller IP address is 192.100.100.2, type:

1 9 2 . 1 0 0 . 1 0 0 . 2

Note: The network cannot be activated if the first address segment in the IP address is set to 0, 127, or a number greater than 223.

6. In the Terminal IP Address field, type in the terminal's IP address. The IP address must match the address set on the controller.

The address field consists of four separate numbers. Each number in the field is separated by a period and can be a number from 0 to 255. Type the address in the format nnn.nnn.nnn.nnn and then press ▼.

For example, if your Terminal IP address is 192.100.100.3, type:

1 9 2 . 1 0 0 . 1 0 0 . 3

Note: The network cannot be activated if the first address segment in the IP address is set to 0, 127, or a number greater than 223.

7. Press to save the changes and exit the Primary Network screen.
8. Press ▼ twice to choose the RF Driver command and then press . The RF Driver screen appears.

```
RF DRIVER
Domain: 00
Security ID:
(ID unchanged)
Wakeup on Broadcast:
No
OK CANCEL
```

242XU.013

9. In the Domain field, type a number from 0 to 15 and then press ▼. The domain must match the number set on the access points.
10. In the Security ID field, type the RF security identification password and then press ▼. The password can be up to 20 characters long and must match the security ID set on the access points.

Note: If you have not changed the Security ID in the current session, the words, (ID unchanged), display instead of the actual password. If you change the Security ID, you see the actual password until you save the changes.

11. Press to save the changes and exit the RF Driver screen.

Note: If the terminal is on a different IP subnetwork from the Model 200 Controller, you must also configure the default router and subnet mask. Choose the Advanced Networks command to set these parameters. For help, see Chapter 4, "Operating the Terminal in a Network."

12. Press to exit the Communications Menu. The Configuration Menu appears.
13. Press to exit the Configuration Menu.
14. Press to choose Yes and save the new configuration in RAM. Once the changes are saved, the terminal uses the new configuration.

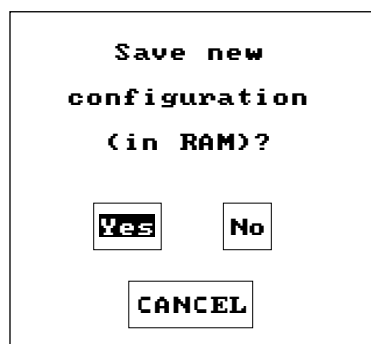

242XU.059

15. Press to exit the TRAKKER 2400 Menu System.

16. Press to choose Yes and store your changes permanently in flash memory.

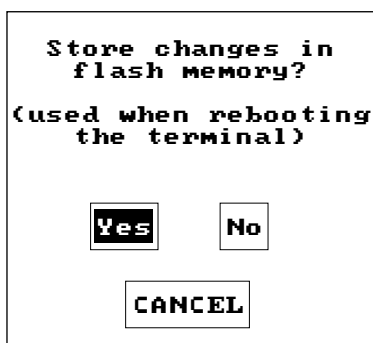

242XU.054

17. Press to choose OK and exit the TRAKKER 2400 Menu System. Continue with the next procedure to start your application.



242XU.055

Starting the Application

Your terminal has been configured and loaded with only one of these applications:

- 3270 and 5250 screen mapping
- IBM 3270 terminal emulation
- IBM 5250 terminal emulation
- VT100/220/320 and ANSI terminal emulation

To start the application

1. After you exit the TRAKKER 2400 Menu System, this warning screen appears again.

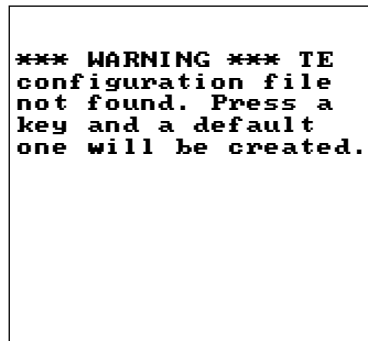

```
*** WARNING *** TE
configuration file
not found. Press a
key and a default
one will be created.
```

242XU.129

2. Press  to continue.

An introduction screen appears for your application followed by a series of messages. The terminal will try to establish communications with the Model 200 Controller and the host computer. Once the terminal connects, you see the message:

Connected to Host.

Note: While the terminal is connecting to the controller, the terminal ignores any input from the keypad or scanner. Wait until the terminal is connected before you try to enter any data.

The login or initial screen for each application appears. You can begin using the terminal to collect data.

3270/5250 Sign On Screen

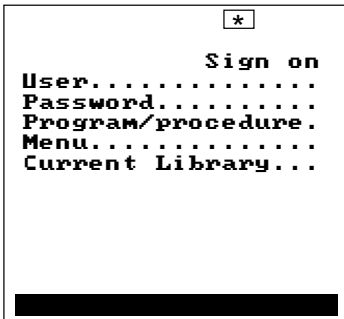

VTXXX/ANSI Login Screen



Screen Mapping Screen



242XU.014

If the terminal will not connect, see Chapter 6, "Troubleshooting" or the *Model 200 Controller System Manual*.

Verifying That the Terminal Is Operating Correctly

Once you have configured the terminal, your TRAKKER 2425 terminal is ready for operation.

To verify that the Network Activate command is enabled and the radio is working

1. If the terminal is not on, press $\text{\textcircled{P}}$ to turn it on.
2. Look at the top line of the terminal's display. If the Radio icon does not appear, the Network Activate command is enabled and the radio is working. You may see other icons on the display.

If the Radio icon (shown in the illustration) remains on solid, the Network Activate command is disabled, or there is a problem with the radio card and the radio is turned off.



242XU.116

Make sure the Network Activate command is enabled. For help, see “Configuring the Terminal” earlier in this chapter.

If the network is activated and the Radio icon still appears, there may be a problem with the radio. For help, contact your local Intermec service representative.

To verify that the terminal is communicating with the 0100 Access Point

1. If the terminal is not on, press Ⓜ to turn it on.
2. Look at the top line of the terminal’s display. If the Connect icon (shown in the illustration) or remains on solid, the terminal is communicating with the access point and is trying to establish communications with the controller. The terminal can send and receive data to the access point.

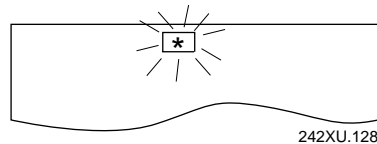

If the Connect icon is not blinking or is not on, you need to check the network configuration. For help, see “Configuring the Controller and Access Point” or “Configuring the Terminal” earlier in this chapter.

To verify that the terminal is communicating with the Model 200 Controller

1. If the terminal is not on, press Ⓜ to turn it on.
2. Look at the top line of the terminal’s display. If the Connect icon (shown in the illustration) appears and remains on solid, the terminal is communicating with the controller. The terminal can send and receive data to the access point and controller.

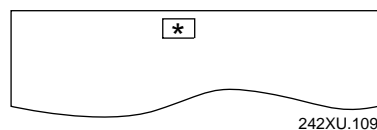

If the Connect icon blinks or is not on, you need to check the network configuration. For help, see “Configuring the Controller and Access Point” or “Configuring the Terminal” earlier in this chapter.

Note: *The Connect icon is not instantaneously updated but does tell you the communications status the last time data was sent or received from the terminal.*

To verify that the application is running

1. If the terminal is not on, press $\text{\textcircled{I/O}}$ to turn it on. The login or initial screen for your application should appear.

3270/5250 Sign On Screen



VTXXX/ANSI Login Screen

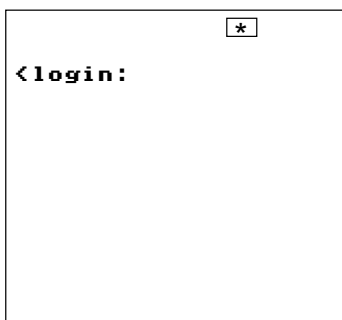

Screen Mapping Screen



242XU.014

2. Use the keypad to type data in a field, or use the scan module to scan bar code labels.

To learn more about using the terminal's keypad and display, see Chapter 2, “Learning How to Use the Terminal.”

Turning the Terminal On and Off

The terminal's Suspend/Resume key is the  key in the upper left corner of the keypad, as shown in this illustration.

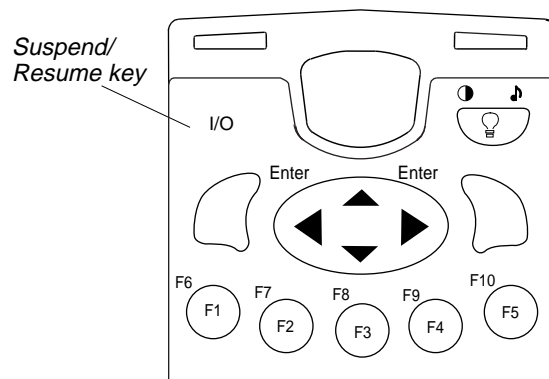

242XU.045

When you press  to turn off the terminal, the terminal does not actually shut off, but goes into a Suspend mode. This mode is referred to as “off” in the rest of this manual. In Suspend mode, the terminal saves all memory and turns off the power to most of the hardware.

When you press  to turn on the terminal, the terminal either resumes exactly where it was when you turned it off, or the terminal boots and restarts your application. Resume is controlled through a parameter or command called Resume Execution. For help, see “Resume Execution” in Chapter 8.

If you change the main battery pack while the terminal is turned off, the terminal resumes or boots the next time the terminal is turned on. The backup battery saves all memory while you change the main battery pack.





Enabling Bar Code Symbologies





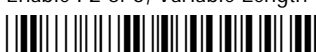

The TRAKKER 2425 terminal can decode several different types of bar code symbologies. Each symbology such as Code 39 uses a different scheme for encoding data as bar code. You must configure the terminal to decode the type of bar code symbology used in your bar code labels.

Only enable the bar code symbologies that you need to scan. For more information about each symbology and the configuration options, see Chapter 8, "Configuration Command Reference."

The terminal can decode the bar code symbologies shown in the next table. You can scan the bar code labels in the table to enable a symbology.

Note: Only three symbologies, Code 39, Code 128, and UPC/EAN, are enabled when you unpack the terminal.

| Bar Code Symbology | Enabled? | To Enable the Symbology |
|----------------------------------|----------|---|
| Codabar | No | Enable Standard Codabar, ABCD Start/Stop Code  *\$+CD21* |
| Code 11 | No | Enable Code 11 With Two Check Digits  *\$+CG2* |
| Code 16K | No | Enable Standard Code 16K  *\$+CP1* |
| Code 2 of 5 | No | Enable Code 2 of 5, 3 Bar Start/Stop, Label Length of 1  *\$+CC001* |
| OR enable: | | |
| Interleaved 2 of 5 (I 2 of 5) | No | Enable I 2 of 5, Variable Length With a Check Digit  *\$+CA99* |

| Bar Code Symbology | Enabled? | To Enable the Symbology |
|--------------------|------------|---|
| Code 39 | YES | Enable Code 39 Full ASCII With No Check Digit  *\$+CB111* |
| Code 49 | No | Enable Code 49  *\$+CJ1* |
| Code 93 | No | Enable Code 93  *\$+CF1* |
| Code 128 | YES | Enable Standard Code 128  *\$+CH1* |
| MSI | No | Enable MSI Without Check Digits  *\$+CN10* |
| Plessey | No | Enable Plessey With Reverse Start Code  *\$+CI10* |
| UPC/EAN | YES | Enable UPC-A/EAN-13, UPC-E, EAN-8  *\$+CE1111111* |

Where Do You Go From Here?

Now that your new TRAKKER 2425 terminal is up and running, you can use this manual to learn how to perform these tasks:

For Help With This Task

To learn how to use the terminal's keypad, display, audio signals, batteries, and scan module

To learn how to change the terminal's configuration

To add the terminal to your 2.4 GHz RF data collection system and learn how to communicate with other devices

To learn how to configure and use terminal emulation and screen mapping on the terminal

To learn how to reset the terminal, solve problems, and respond to error messages

See This Chapter

Chapter 2, "Learning How to Use the Terminal"

Chapter 3, "Configuring the Terminal"

Chapter 4, "Operating the Terminal in a Network"

Chapter 5, "Running Applications"

Chapter 6, "Troubleshooting"

2

Learning How to Use the Terminal

This chapter describes and explains how to use the terminal's keypad, display, audio signals, batteries, memory, and scan modules.

TRAKKER 2425 Terminal Features

This chapter tells you about these features on the TRAKKER 2425 terminal:

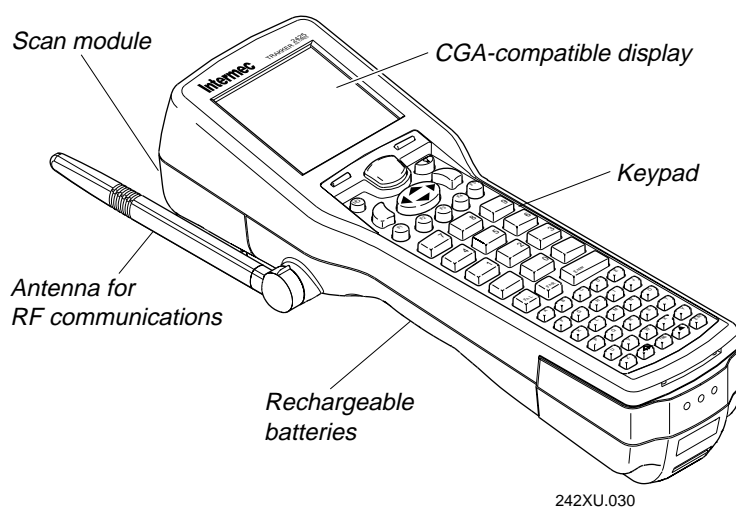

Keypad There are four keypad options: an alphanumeric keypad and three different terminal emulation keypads. The terminal ships with a keypad that supports the type of application you ordered on the terminal.

CGA-compatible display The terminal display is a backlit LCD display that is 16 lines by 20 characters. Depending on the application, you can use the viewport features to move around a full 25 line by 80 character display.

Audio signals The terminal and scan module have a beeper and internal speakers to sound audio signals as you scan bar code labels and enter data.

Antenna for RF communications The T2425 terminal uses radio frequency (RF) to communicate with the 0100 Access Point and the Model 200 Controller.

Rechargeable batteries The terminal uses a rechargeable lithium-ion battery pack and a rechargeable NiCad backup battery to provide power.

Memory The terminal has a total of 1MB RAM for system memory, and 2MB flash memory for long term storage of firmware, configuration data, and user applications.

Scan modules You must attach a scan module to the terminal to scan bar code data. There are two scan module options: a standard range scan module and a module for cabled scanners.

Using the Keypad

The TRAKKER 2425 terminal has four keypad options:

- Standard alphanumeric keypad for 3270 and 5250 screen mapping
- IBM 3270 terminal emulation keypad
- IBM 5250 terminal emulation keypad
- VT100/220/320 and ANSI terminal emulation keypad

All four alphanumeric keypads have 56 keys. Although the keypad is smaller than a desktop terminal keyboard, you use special keys on the T2425 terminal keypad to access all of the keys and functions you need.

A terminal emulation (TE) keypad comes with the TE option you ordered for the T2425 terminal. Each TE keypad is similar to the standard alphanumeric keypad, but contains additional keys that are available on an IBM 3270 keyboard, IBM 5250 keyboard, or VTXXX or ANSI keyboard.

Finding the Special Keys

Before you use the terminal's keypad, make sure you can find all of the different types of keys on the keypad. You need to use these special keys on all four keypad options.

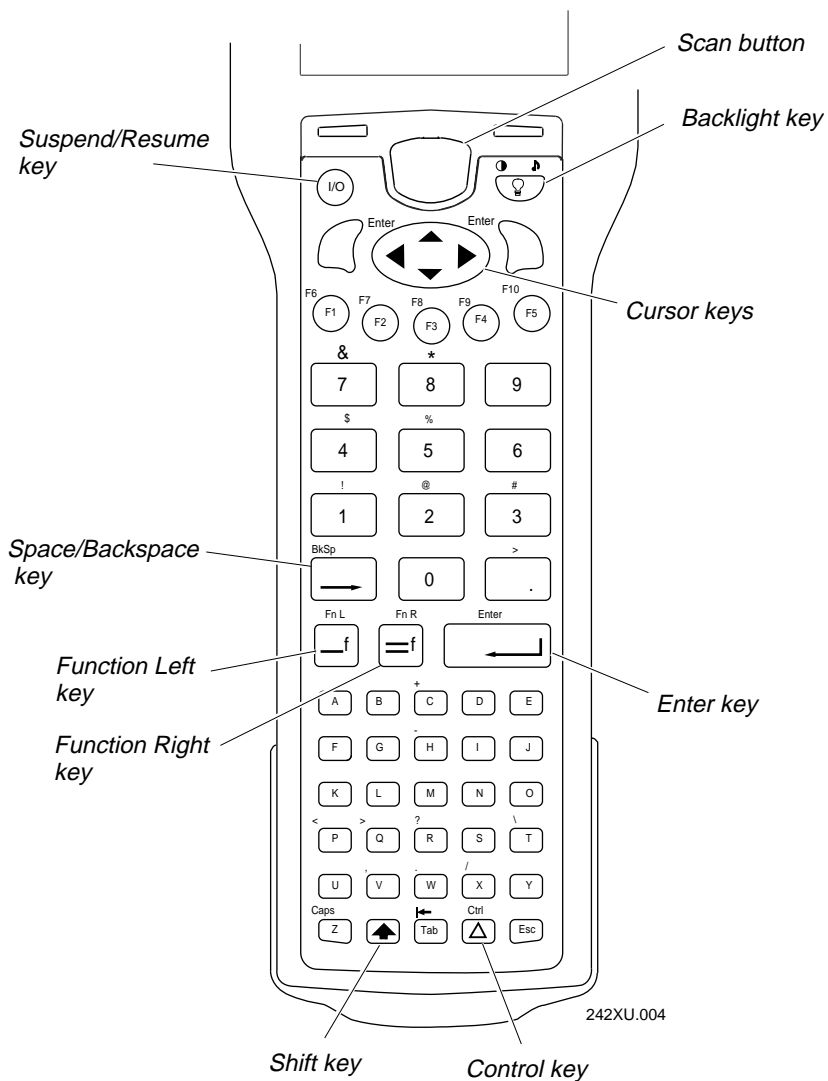

The special keys that you use to type characters or perform functions are explained in the next sections. You can use the Backlight key to turn on the backlight, change the display contrast, and change the beep volume. For help, see "Adjusting the Display From the Keypad" later in this chapter.

Finding the Special Keys



How to Type the Characters Printed on the Keypad



The TRAKKER 2425 terminal keypad is easy to use. Characters, symbols, and functions are printed in four places on or above the keys. The keys are also color-coded to make it easier to remember key combinations.



| Position on the Keypad | Color | To Type the Character |
|--------------------------|--------|---|
| Middle of the key | White | Press the key. |
| Left side above the key | Blue | Press the blue  key, then the key. |
| Centered above the key | Green | Press the green  key, then the key. |
| Right side above the key | Orange | Press the orange  key, then the key. |

Note: Some keys do not have any characters printed above the key on the top cover of the keypad.



To learn how to type characters, use these illustrations and examples from the alphanumeric keypad and the IBM 5250 terminal emulation keypad.

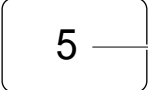

To type characters using the basic keypad

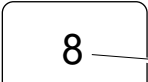

% ——— To type the % character, press  .

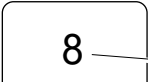

 ——— To type the number 5, press .

To type characters using the IBM 5250 terminal emulation keypad

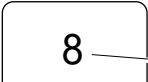
 ——— To use the Fld+ function, press  .

 ——— To type the asterisk (*) character, press  .

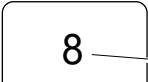

 ——— To use the Fld- function, press  .

 ——— To type the number 8, press .



242XU.124

Using the Function Left/Right and Shift Keys

The TRAKKER 2425 keypad does not have a physical key for every character and function available. You use the Function Left (FnL), Function Right (FnR), and Shift keys to access characters or perform functions that do not have a physical key on the keypad. You also use the Shift key to type uppercase alphabetic characters.

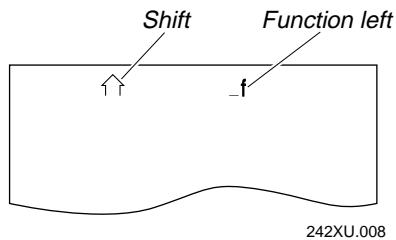
When you press , , or , the key is held in a buffer until you press another key. The icon appears on the terminal's display to remind you that the key is being held in the buffer. When you press another key, the key combination is entered into the terminal and the icon disappears.





To flush the , , or  key from the buffer without performing any action, just press the key again. The icon disappears from the display.

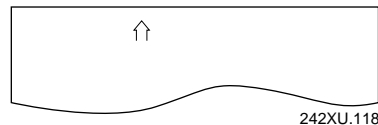

To use the FnL, FnR, and Shift keys

1. Press , , or . The Function Left, Function Right, or Shift icon appears on the terminal's display.

For example, press . The Shift icon appears on the terminal display.





2. Press the second key. For example, press  to type the uppercase letter A. The Shift icon disappears from the terminal's display.

To flush the key from the keypad buffer without entering any key, press , , or  again. The icon disappears from the terminal's display.

Capitalizing All Characters



To type all alphabetic characters as uppercase letters, you can press  before every letter you type, or you can enable the Caps Lock feature.

To enable Caps Lock

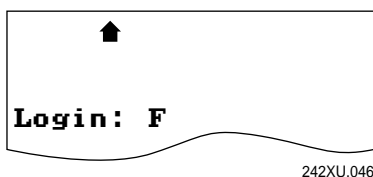

1. Press .
2. Press . The Caps Lock icon appears on the terminal's display.
3. Type an alphabetic character. The letter appears as an uppercase character on the terminal's display. For example, press  to type an uppercase letter F. Caps Lock remains enabled until you disable it.



To type a lowercase letter with Caps Lock enabled

- Press  and an alphabetic character. For example, press   to type a lowercase letter f.

To disable Caps Lock

1. Press .
2. Press . The Caps Lock icon disappears from the terminal's display.
3. Type an alphabetic character. The letter appears as a lowercase letter on the terminal's display.

Note: You can also use the Keypad Caps Lock configuration command to enable or disable Caps Lock on the terminal. For help, see "Keypad Caps Lock" in Chapter 8.

How to Use the Cursor Keys

You can press keys to move the cursor around an application screen. The terminal's cursor keys work the same as cursor keys on a regular keyboard. You use the oval-shaped cursor key to move the cursor up, down, right, or left on the display.

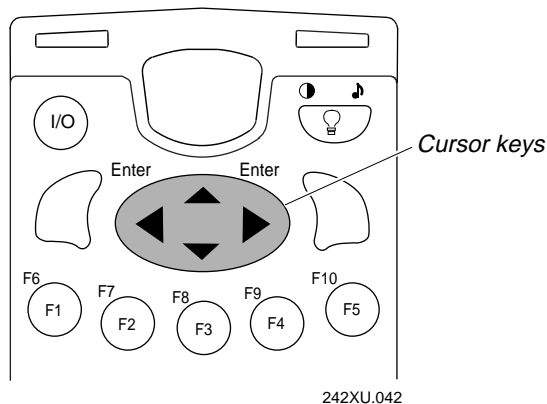

242XU.042

| To Use This Cursor Key | Press | Description |
|------------------------|-------|--|
| Arrow up | ▲ | Moves the cursor up one row or line. |
| Arrow down | ▼ | Moves the cursor down one row or line. |
| Arrow right | ▶ | Moves the cursor one character to the right. |
| Arrow left | ◀ | Moves the cursor one character to the left. |

On the terminal emulation keypads, you can use the cursor keys to move around the terminal's screen if you are running a program or entering data in a screen. For help, see Chapter 5, "Running Applications."

Quick Reference Keypad Chart

Use this keypad chart to enter any character or function on the alphanumeric keypad. For help about additional functions that are available on a TE keypad, see Chapter 5, "Running Applications."

| To Enter | Press the Key(s) | To Enter | Press the Key(s) |
|----------------------|------------------|-----------------------|------------------|
| 0 to 9 | to | tab | |
| a to z | to | viewport down | |
| A to Z | to | viewport end | |
| backlight on/off | | viewport home | |
| backtab | | viewport left | |
| beep volume | | viewport right | |
| Bksp (backspace) | | viewport up | |
| caps | | . (period) | or |
| contrast | | , (comma) | |
| ctrl | | + | |
| cursor down | | - (dash) | |
| cursor left | | / (slash) | |
| cursor right | | \ (backslash) | |
| cursor up | | ? | |
| enter | | < | |
| escape | | > | or |
| F1 to F5 | to | ! (exclamation point) | |
| F6 to F10 | to | @ | |
| FnL (function left) | | # | |
| FnR (function right) | | \$ | |
| resume/suspend | | % | |
| shift | | & | |
| space | | * (asterisk) | |

How to Use the Terminal's Display

You can use the TRAKKER 2425 terminal's display to view data, run terminal emulation applications, monitor the terminal's status, and for many other functions. The terminal's black and white display is 16 lines by 20 characters and is CGA compatible.

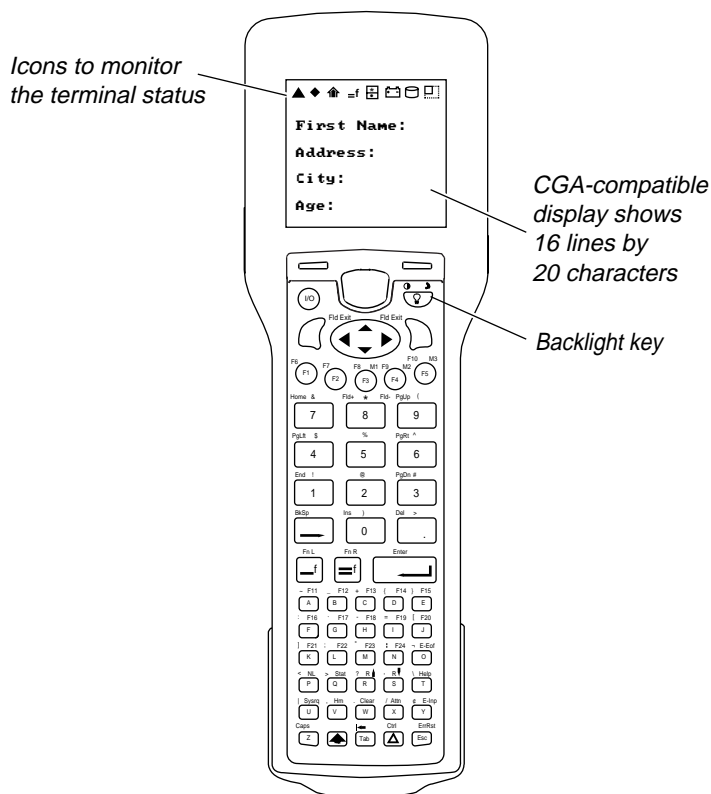

242XU.122

You can use these features of the display:

- In an application, use the terminal's display as a viewport to see a full-size terminal screen of 25 lines by 80 characters.
- Adjust the display's backlight, contrast, and audio signal volume from the keypad.
- Use the terminal's icons to monitor the status of special keys, battery power, RF and network communications, and viewport movement.

Each display feature is explained in the next sections.

Note: If you are using the terminal in a cold environment, the LCD display may respond and display information more slowly than in a warm environment.

Using the Display As a Viewport

The TRAKKER 2425 terminal display shows 16 lines by 20 characters of data at one time. In terminal emulation (TE) applications, the terminal's display may show only part of each 25 line by 80 character screen that appears on a full-size terminal. You can use the terminal display as a viewport to move around and see the entire 25 x 80 screen.

The viewport lets you view screens and enter data by showing the part of the screen you are using. When you are using TE, the viewport automatically moves to the cursor when there is data entry from the host computer or the terminal. You can configure the viewport for your TE applications to:

- Follow the cursor
- Center the viewport around the cursor

For help on configuring the TE viewport options, see Chapter 5, "Running Applications."

The first time you turn the terminal on, it displays the upper left corner of a full-size terminal screen. This is the viewport's home position. A screen or application that displays more than 16 lines by 20 characters of data at one time has data in the unseen area of the display. When you move the cursor or viewport out of the home position (upper left corner), the Viewport icon displays until the viewport is returned to its home position.

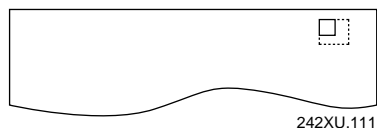

Adjusting the Display From the Keypad

The Backlight key is one of the special features built into the terminal's keypad. You can use the Backlight key to:

- Turn the backlight on and off on the terminal's display.
- Adjust the display contrast.
- Change the beep volume of the terminal's audio signals.

For a detailed description of the backlight, contrast, and beep volume commands, see Chapter 8, "Configuration Command Reference."

Note: The Backlight key temporarily changes the backlight, contrast, or beep volume. These changes are not saved permanently in flash memory.

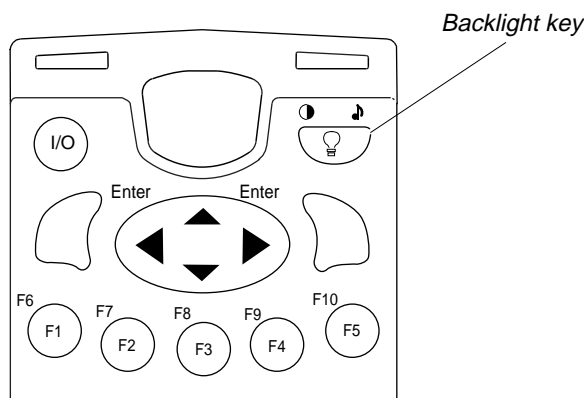

242XU.049

To turn the backlight on and off



- Press . Turn the backlight on to more easily see the terminal's display in dimly-lit environments.

The backlight stays on for the length of time set in the Display Backlight Timeout command or until you press  again. For more information about the command, see "Display Backlight Timeout" in Chapter 8.





Note: You use the battery power at a faster rate with the backlight turned on.





To change the display contrast

- Press  . Each time you press  , it makes the display contrast one level darker.

There are eight contrast levels. If the contrast is at the darkest level and you press  , the contrast changes to the lightest contrast level.

To change the beep volume of the audio signals

- To change the volume of the terminal's audio signals, press  . Each time you press  , it makes the beep volume one level louder.

There are five beep volume levels including off. If the volume is at the loudest level and you press  , the beep volume is turned off. If you press   again, the volume changes to the quietest level.

Understanding the Icons

You can use the terminal's icons to monitor the status of special keys, battery power, saving data to flash memory, RF and network communications, and viewport movement. As you use the terminal, the icons are turned on and off in the top line of the terminal display to indicate the current status.

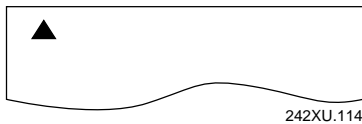

Ctrl This icon appears when you press \triangle . The key is stored in the keypad buffer until you press another key. When you press a second key, the key combination is entered into the terminal and the icon disappears.

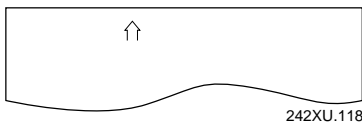

Shift This icon appears when you press \uparrow . The key is stored in the keypad buffer until you press another key. When you press a second key, the key combination is entered into the terminal and the icon disappears.

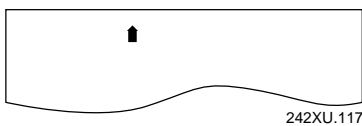

Caps Lock This icon appears when you press $_f$ z to enable the Caps Lock feature and type all alphabetic characters as uppercase letters. When you press $_f$ z to disable Caps Lock, the icon disappears.

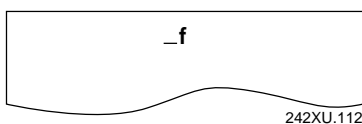

Function Left This icon appears when you press $_f$. The key is stored in the keypad buffer until you press another key. When you press a second key, the key combination is entered into the terminal and the icon disappears.

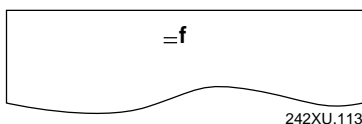

Function Right This icon appears when you press $=f$. The key is stored in the keypad buffer until you press another key. When you press a second key, the key combination is entered into the terminal and the icon disappears.

Understanding the Icons (continued)

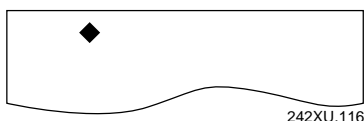

Radio This icon appears when the Network Activate command is disabled, or there is a problem with the radio card and it is turned off. The Radio icon disappears when the network is enabled and the radio is on and transmitting. For help, see Chapter 4, "Operating the Terminal in a Network."

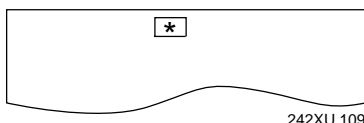

Connect This icon contains an asterisk and tells you if the terminal is connected via RF communications to the 0100 Access Point and the Model 200 Controller.

- If the Connect icon is not displayed, the terminal is not connected to the access point. You may be out of range of an access point or the terminal may not be configured correctly. If the Network Activate command is disabled, the Connect icon is not displayed, but the Radio icon does appear.
- If the Connect icon blinks, the terminal is trying to connect to the controller. You may be out of range of an access point, the access point may have recently been turned off, or data collection is not started on the controller.
- If the Connect icon appears and remains on solid, the terminal is or was connected and communicating with the access point and the controller within the last 2 minutes.

The Connect icon is not instantaneously updated but does tell you the communications status the last time data was sent or received from the terminal. For help with network communications, see Chapter 4, "Operating the Terminal in a Network."

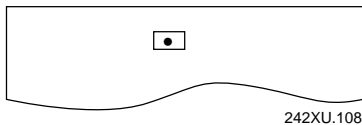

Data This icon contains a period. It appears on the display when data is buffered in the RF interface. The data is either waiting to be transmitted to the Model 200 Controller, or received data has not been accepted by the terminal's application. When no data is being buffered in the RF interface, the Data icon is off.

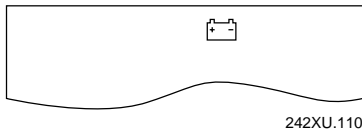

Battery This icon appears when one or both of the batteries have a low power charge. The Battery icon appears with the terminal turned on or off.

- The Battery icon turns on and remains on and the terminal beeps every 15 seconds when the main battery pack has about 5 to 45 minutes of power left.
- The Battery icon blinks when the backup battery charge is low.
- The Battery icon blinks and the terminal beeps every 15 seconds when both batteries are low.

The Battery icon disappears when you replace or charge the main battery pack, or charge the backup battery. For help with the batteries, see "Learning About the Terminal's Batteries" later in this chapter.

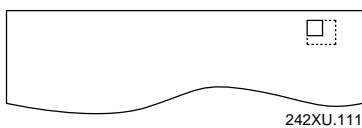



Viewport This icon appears when you move the viewport out of the upper left corner of the display, which is the viewport's home position. When you move the viewport back to the home position, the icon disappears.

Understanding the Terminal's Audio Signals



The TRAKKER 2425 terminal and scan module have a beeper and internal speakers to sound audio signals or beep sequences as you use the terminal. For example, you hear a low beep tone each time you enter or scan a valid command.

You can change the beep volume to meet the needs of your working environment. For example, use a quiet beep in a library or a loud beep in a manufacturing plant. There are two ways to change the beep volume:

- Use the Backlight key (press  ) on the keypad. For help, see “Adjusting the Display From the Keypad” earlier in this chapter.
- Use the Beep Volume command. For help, see “Beep Volume” in Chapter 8.

The next table explains the purpose of each beep sequence you may hear.

| Beep Sequence | Description |
|--|---|
| Low beep | You entered a valid command or the data you entered was stored. |
| High beep | You entered valid data, the terminal decoded a label, or the terminal decoded the last row of a two-dimensional symbology. |
| Three low beeps | You entered or scanned an invalid command or data. |
| Four low beeps | When you boot the terminal, you hear four low beeps once the power-on self test (POST) has executed successfully. |
| Low beep, high beep, low beep, high beep | You hear this beep sequence when POST failed and did not execute successfully. For help, see “Problems While Operating the Terminal” in Chapter 6. |
| Click | When you press a key, the terminal sounds a click. You can disable the keyclick. For help, see “Keypad Clicker” in Chapter 8. The terminal also clicks while you are scanning a two-dimensional symbology (Code 16K or Code 49) bar code label. |
| Low beep (every 15 seconds) | The main battery pack is low. You need to replace or recharge the battery pack. For help, see the next section, “Learning About the Terminal's Batteries.” |

Learning About the Terminal's Batteries

There are two rechargeable batteries in the TRAKKER 2425 terminal:

Main Battery Pack This lithium-ion battery provides the main power source to operate the terminal.

Backup Battery This NiCad (Nickel-Cadmium) battery backs up all memory and the real-time clock while you change the main battery pack.

Main Battery Pack

The main power source for the terminal is a lithium-ion battery pack. Follow these tips to get the best battery performance and life possible:

- You should always keep a charged main battery pack installed in the terminal to maximize the backup battery's life.
- When you remove a battery pack, insert another charged battery pack in the terminal.
- Keep a spare charged battery pack available so you can continue to operate the terminal without interruption.
- If you use the terminal for extended periods of time in a sub-freezing environment, you may need to change the battery pack more often.
- If you have been using the terminal in a cold temperature environment and need to replace or charge the battery pack, let the battery packs warm up for a half hour before you charge them.
- Store the battery chargers and spare battery packs in a warm (office) environment to assure the most efficient operation.

Removing and Installing the Main Battery Pack

The battery pack is the main power source for the terminal and it charges the backup battery when required. If the main battery pack charge goes low, you need to replace it or charge the battery pack as soon as possible.

There are two ways to find out if the battery pack is low:

- The Battery icon appears and remains on solid on the top line of the display, and the terminal beeps once every 15 seconds.
- Check the status of the battery pack using the Battery Status diagnostic test. For help, see "Running Diagnostics" in Chapter 6.

If you have been using the terminal in a cold temperature environment and need to replace or charge the battery pack, let the battery packs warm up for a half hour before you charge them. Store the battery chargers and spare battery packs in a warm (office) environment.



Caution

Removing the battery pack while the terminal is on may cause loss of data.

Conseil

Ne détachez pas le jeu de piles pendant que le lecteur est actif car cela pourrait entraîner la perte de données.

To remove the battery pack

1. Press  to turn off the terminal.
2. Open the battery door by pushing down on the battery door latch and sliding it toward the bottom end of the terminal. Lift up the top edge of the battery door to remove it.

Note: *If you have a handstrap installed, stretch the handstrap's elastic band to allow the T-bar to slide out of the T-bar opening on the bottom end of the terminal. Move the handstrap out of the way to open the battery door.*

Opening the Battery Door

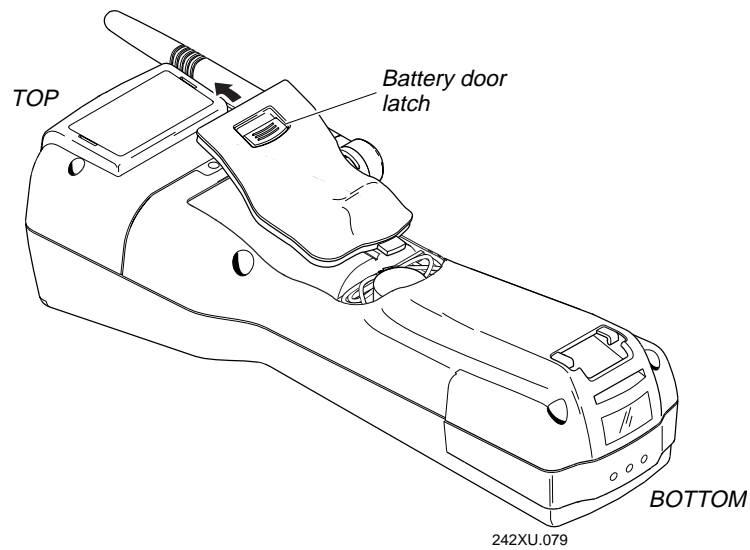

3. Disconnect the battery pack from the connectors inside the bottom case by sliding the battery pack toward the bottom end of the terminal.

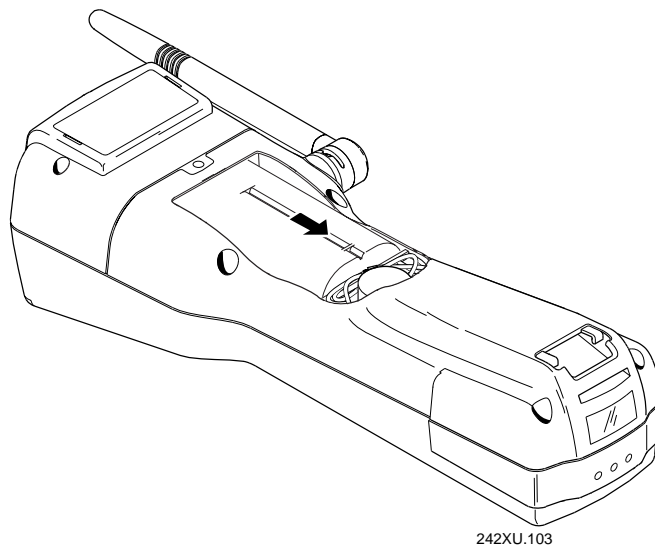

4. Tilt the terminal to one side and let the battery pack drop out of the compartment into your hand. Continue with the next instructions to install a charged battery pack.

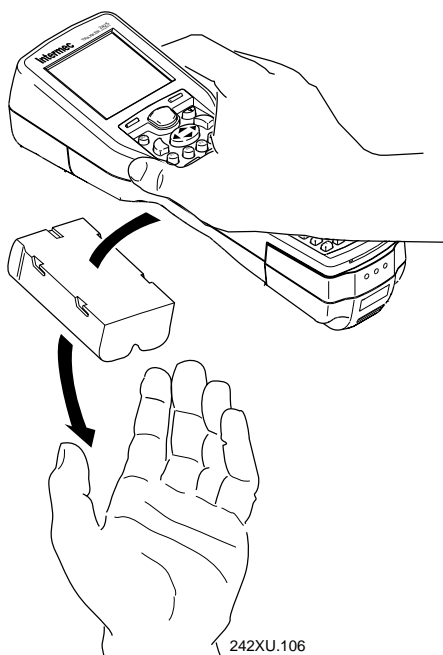

To install the battery pack

1. Hold the battery pack with the flat side facing down toward the inside of the battery compartment. The small arrow on the top of the battery pack must point toward the top (display) end of the terminal.
2. Place the battery pack into the upper (larger) half of the battery compartment.

Installing the Battery Pack

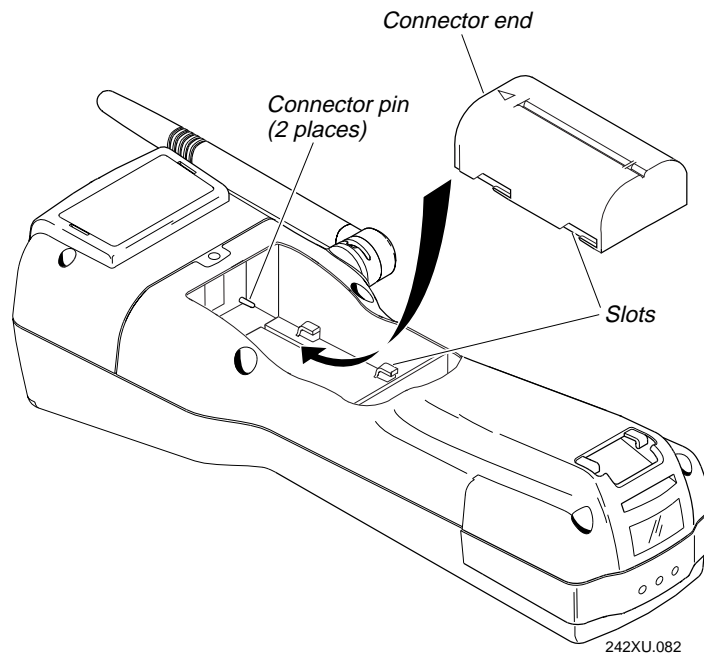

3. Hook the slots on the bottom of the battery pack into the slots on the bottom of the battery compartment.
4. Slide the battery pack toward the top end of the terminal until it fits and locks into the connectors inside the bottom case. The battery pack must be all of the way forward to close the battery door.

Installing the Battery Pack

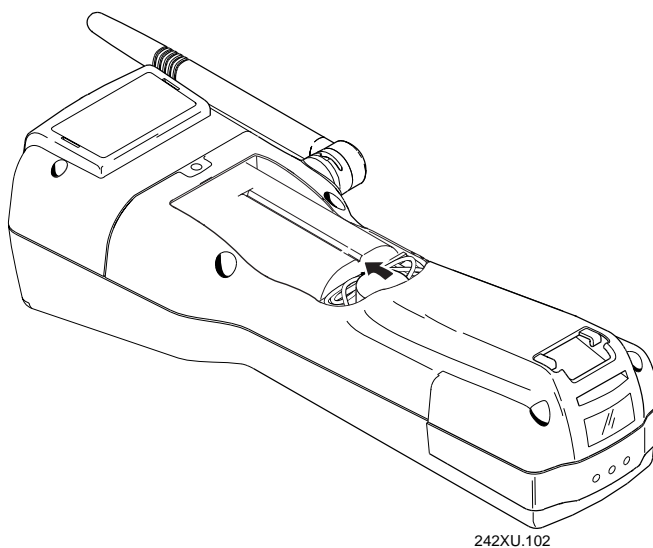

242XU.102

5. On the inside of the battery door, make sure the rubber bumper is installed over the ridge near the wall. The rubber bumper keeps the battery pack in place.

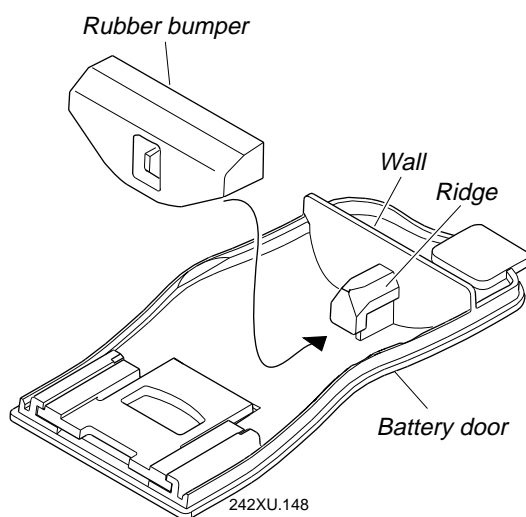

242XU.148

6. Hook the bottom edge of the battery door into the bottom case above the backup battery compartment. Push the door down to close it over the battery compartment. Push the battery door latch down and slide it toward the top end of the terminal to lock the door in place.

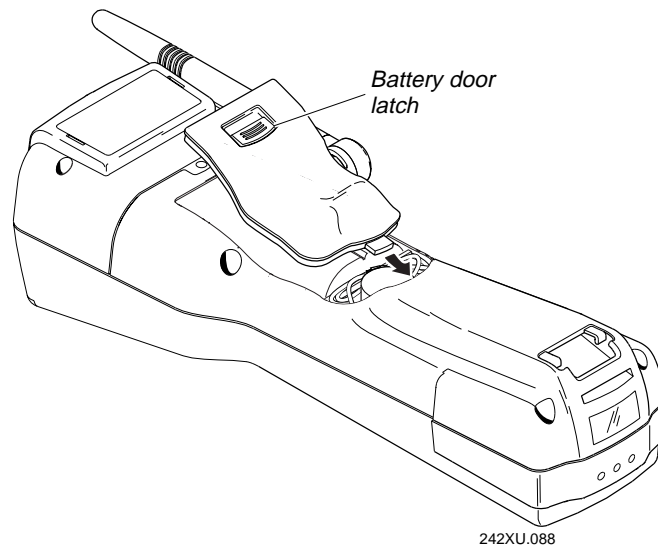

Note: If the battery door will not shut, the battery pack is not correctly installed. Repeat Steps 1 through 5 above to install the battery pack.

Charging the Main Battery Pack

You can recharge the main battery pack using the accessory battery charger. The battery charger uses a charging method that maximizes battery life.

To charge the main battery pack

- Place the battery pack in an empty slot in the battery charger. Charge it for a minimum of 2 hours to fully charge the battery pack.

For help, see the documentation that came with your battery charger.

Tip: Keep a spare charged main battery pack on hand to operate the terminal without interruption.

Backup Battery

The backup battery is a NiCad battery that is designed to back up all memory and the real-time clock while you remove a discharged main battery pack and insert a charged battery pack. You can remove and replace the backup battery if it will no longer hold a charge, or if the battery is dead.

The main battery pack charges the backup battery when required with the terminal turned on or off. You should keep a charged main battery pack installed in the terminal to maximize the backup battery's life.

The backup battery will provide backup battery power for:

- A maximum of 1 month if a fully-charged main battery pack is installed.
- A maximum of 3 days if a main battery pack is not installed.

The backup battery power depends on how much power is left in the battery pack and the backup battery when you turn off the terminal. If the backup battery is still providing backup power when you turn the terminal back on, the terminal resumes exactly where it was when you turned it off, or restarts your application.

If you plan to store the terminal for a long period of time, insert a fully charged main battery pack to maximize battery life. Store the terminal in a warm (office) area to make sure the backup battery continues to charge.

Note: *If Resume Execution is allowed, the terminal will resume the application when you turn on the terminal. Otherwise, the terminal boots and the application restarts. For help, see "Resume Execution" in Chapter 8.*

Charging the Backup Battery

The main battery pack charges the backup battery when required with the terminal turned on or off. The terminal continuously monitors the backup battery voltage level and charges the backup battery for a fixed duration of time whenever the voltage level gets low. If the main battery pack is low or discharged, it will not be able to charge the backup battery.

There are two ways to find out if the backup battery charge is low:

- The Battery icon is blinking on the top line of the display.
- Check the status of the backup battery using the Battery Status diagnostic test. For help, see "Running Diagnostics" in Chapter 6.

Note: The backup battery charger operates between 32°F and 104°F (0°C and 40°C). If you are using the terminal in an environment that is outside this temperature range, the backup battery will not charge. Move the terminal to a warmer environment to charge the backup battery.

To fully charge a discharged backup battery

1. Install a fully charged main battery pack. For help, see “Removing and Installing the Main Battery Pack” earlier in this chapter.
2. The main battery pack charges the backup battery. It will be fully charged in approximately 18 hours. After you finish charging the backup battery, the main battery pack still has most of its power remaining.

Note: The backup battery charges enough to operate the terminal within 20 minutes. However, the backup battery will only provide limited backup power if it is not fully charged.

Removing and Installing the Backup Battery

The backup battery should provide years of backup battery power and you will seldom need to replace it. You can remove and replace the backup battery if it will no longer hold a charge, or the battery is dead. Call your local Intermec service representative to order a new backup battery.



Caution

When you replace the backup battery, all data stored in RAM is lost.

Conseil

Lors du remplacement de la batterie de secours, toutes les données stockées dans la mémoire vive (RAM) sont perdues.

To remove the backup battery

1. Save your data or last transaction and exit your application.
2. Press  to turn off the terminal.
3. Open the battery door by pushing down on the battery door latch and sliding it toward the bottom end of the terminal. Lift up the top edge of the battery door to remove it.

Note: If you have a handstrap installed, stretch the handstrap's elastic band to allow the T-bar to slide out of the T-bar opening on the bottom end of the terminal. Move the handstrap out of the way to open the battery door.

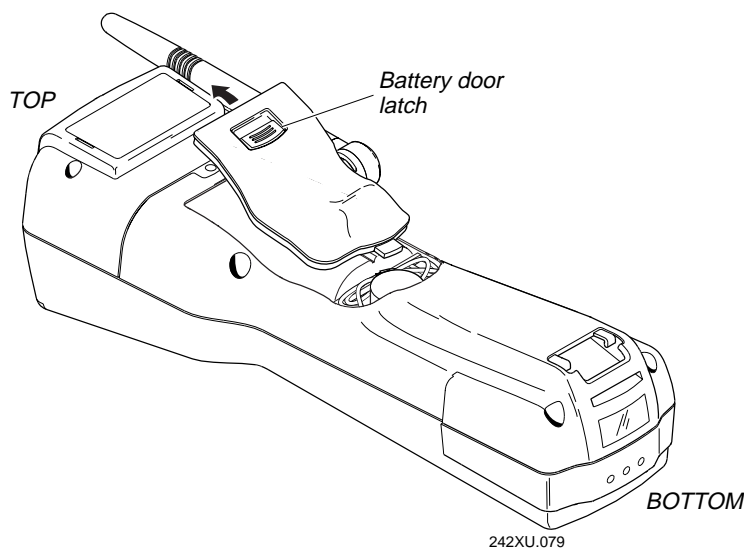

4. Remove the main battery pack. For help, see “Removing and Installing the Main Battery Pack” earlier in this chapter.
5. Hold each of the backup battery connectors and gently pull to disconnect the backup battery.

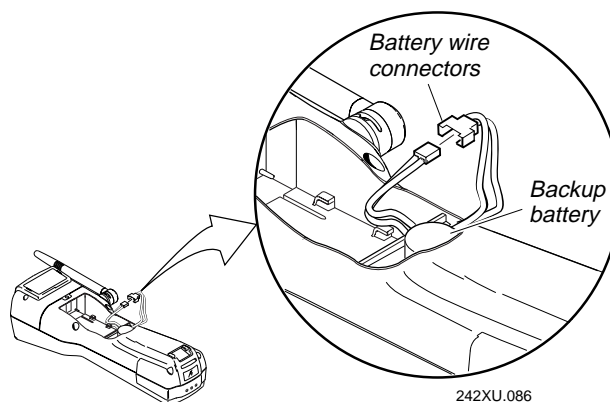

6. Holding the visible end of the backup battery, slide the battery up and out of the battery compartment. Continue with the next instructions to install the new backup battery.

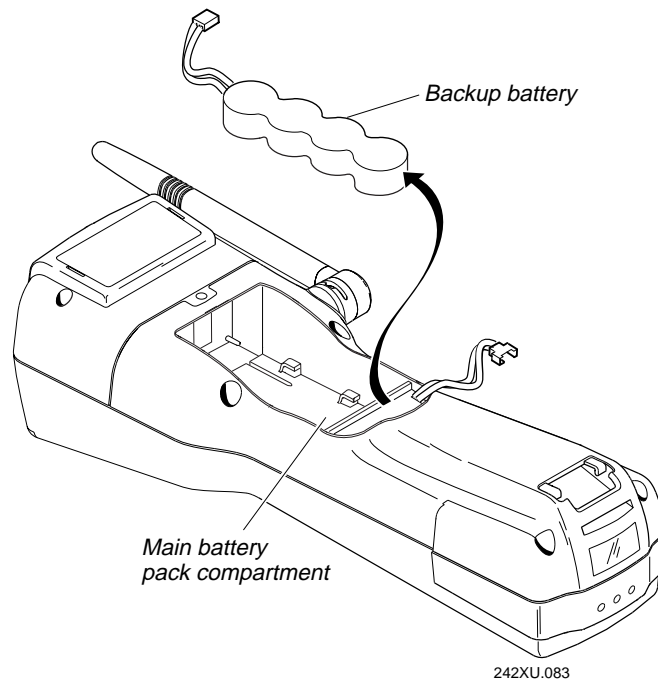

To install a backup battery

1. Slide the backup battery into the lower half of the battery compartment. The wired end of the backup battery should be visible in the battery compartment.

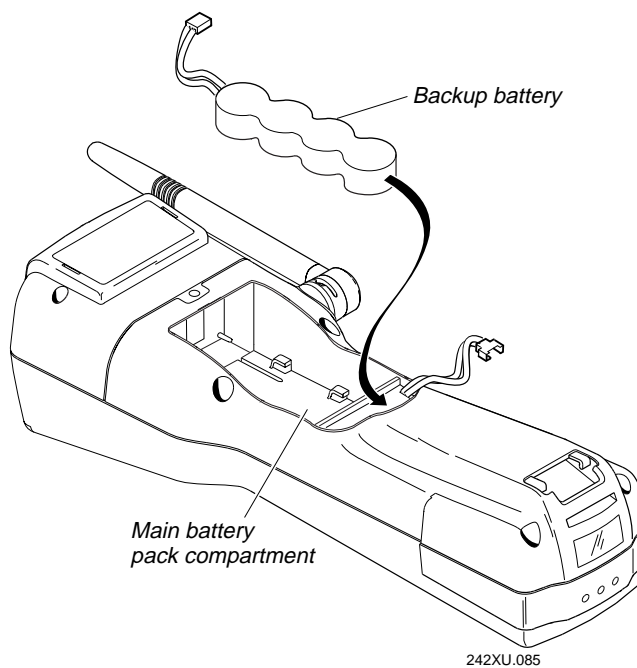

2. Find the two connectors in the backup battery compartment. One connector is attached to the backup battery. The other connector is attached to the terminal. Firmly push the two battery wire connectors together until they lock.

Connecting the Battery Wires

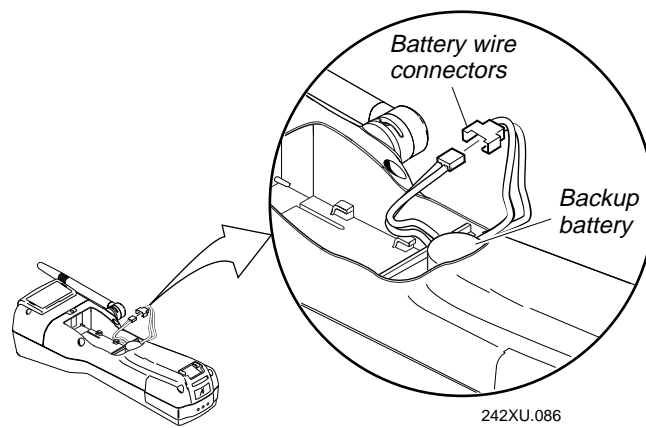

3. Gently fold and push the backup battery wires into the open area of the backup battery compartment near the wall.

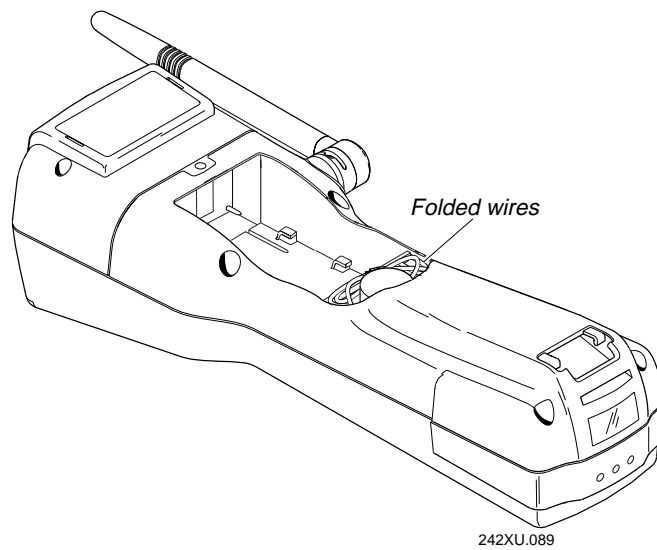

4. Install a fully charged main battery pack. For help, see “Removing and Installing the Main Battery Pack” earlier in this chapter.
5. Hook the bottom edge of the battery door into the bottom case above the backup battery compartment. Push the door down to close it over the battery compartment. Push the battery door latch down and slide it toward the top end of the terminal to lock the door in place.

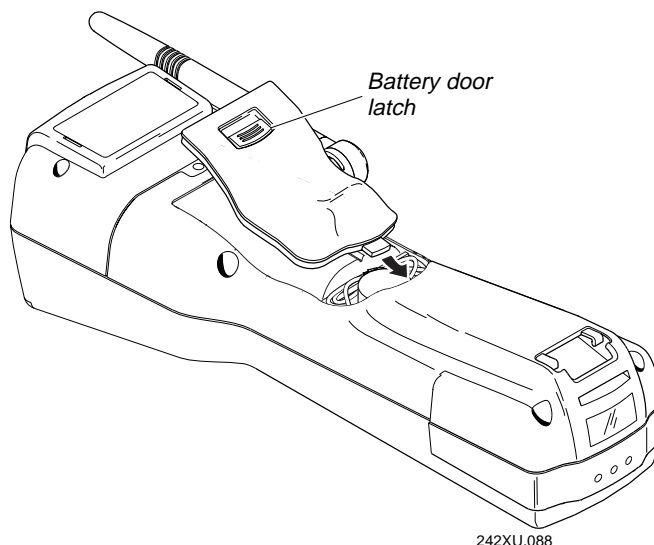

The main battery pack charges the backup battery. The backup battery will be fully charged in approximately 18 hours.

Note: *The backup battery charges enough to operate the terminal within 20 minutes. However, the backup battery will only provide limited backup power if it is not fully charged.*

Disposing of the NiCad Backup Battery

The materials used in the construction of the TRAKKER 2425 NiCad backup battery are recyclable. Intermec strongly urges that you recycle the backup batteries when they reach the end of their useful lives. Additionally, the Environmental Protection Agency has classified worn out or damaged NiCad batteries or battery packs to be hazardous waste. Several states have passed legislation that prohibits discarding these batteries into the municipal waste stream.

If you have any question on how to recycle or dispose of the NiCad backup batteries, contact your local, county, or state hazardous waste management office.

Checking the Power Remaining in the Batteries

You can use the terminal's diagnostics to check the power remaining in the main battery pack, and to check the status of the backup battery. Use the TRAKKER 2400 Menu System to check the status of the batteries. For help, see "Running Diagnostics" in Chapter 6.

Recognizing a Low or Discharged Battery

If you see the Battery icon or hear a beep every 15 seconds, the terminal is indicating that the main battery pack or the backup battery power is almost exhausted. Use this table to find out which battery is low or discharged.

Low Battery Warning

What You Need to Do

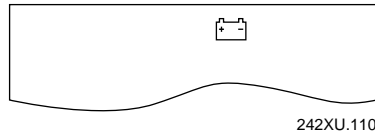

The Battery icon turns on and stays on, and the terminal beeps every 15 seconds.

Main battery pack is low (5 to 45 minutes of power left). Replace the battery pack with a spare charged battery pack, or charge the battery pack.

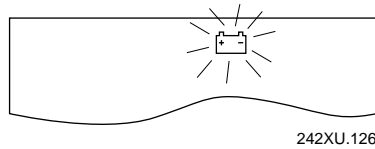

The Battery icon blinks.

Backup battery is low. Keep a charged main battery pack installed in the terminal. Leave the terminal off and let the battery pack charge the backup battery. The backup battery charge will be fully charged in approximately 18 hours.

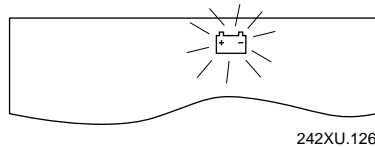

The Battery icon blinks and the terminal beeps every 15 seconds.



The main battery pack and the backup battery charge are both low. Immediately, turn off the terminal.

Replace the main battery pack with a spare charged battery pack. Leave the terminal off and let the battery pack charge the backup battery. The backup battery charge will be fully charged in approximately 18 hours. If the Battery icon continues to blink, you need to replace the backup battery.

Managing Your Battery Power

To maximize the life of the terminal's backup battery and main battery pack, use these power management features.

Tip: *Keep a spare, charged main battery pack on hand to operate the terminal without interruption. Always keep a charged or partially charged main battery pack in the terminal.*

| Situation | Ways to Save Battery Power |
|---|---|
| You are not using the terminal for 5 minutes or longer. | Press  to put the terminal in Suspend mode. Suspend mode maximizes the life of the main battery pack's power. Make sure the battery pack is charged (not in a low battery state). |
| You are operating the terminal and the main battery pack charge becomes low. (The Battery icon remains on solid.) | Press  to put the terminal in Suspend mode. Remove the main battery pack and insert another charged battery pack. For help, see "Main Battery Pack" earlier in this chapter. |
| You are operating the terminal and the backup battery charge becomes low. (The Battery icon blinks.) | Press  to put the terminal in Suspend mode. Keep a charged main battery pack installed in the terminal. The battery pack will fully charge the backup battery in approximately 18 hours. |

Note: *If you use the terminal in a cold temperature environment, battery life will be reduced. For more information, see "Guidelines for Managing Batteries" in Chapter 6.*

Learning About the Terminal's Memory

The terminal comes with the following memory:

Flash memory Provides 2MB of flash memory for long term storage of user applications (terminal emulation or screen mapping application), Intermec firmware, and configuration data.

RAM memory Provides 512K RAM system memory and an additional 512K RAM for user applications. The contents of RAM are saved when you change the main battery pack. RAM is erased when you reset the terminal or change the backup battery.

Using the Scan Module

You use the scan module accessories with the TRAKKER 2425 terminal to scan and enter bar code data. The terminal decodes the bar code label and enters the data or command you scanned.

There are two types of scan modules available:

- Module for cabled scanners
- Standard range scan module

Important: *You must have a scan module attached to use the terminal.*

The module for cabled scanners has a port to attach a wand, laser scanner, or CCD scanner. The standard range scan module has an integrated laser scanner. For more information about either scan module, see the instruction sheet that ships with the module.

You can scan bar code labels with the integrated standard range scan module, or with the scanner device that is connected to the module for cabled scanners.

When you unpack the terminal and begin using it, only three bar code symbologies are enabled: Code 39, Code 128, and UPC/EAN. If you are using bar code labels that are encoded in another symbology, you need to enable that symbology on the terminal. For help, see “Enabling Bar Code Symbologies” in Chapter 1, or find the symbology in Chapter 8, “Configuration Command Reference.”

Note: *The Scan button on the terminal keypad does not activate the scanner device connected to the module for cabled scanners.*

The next sections cover these topics:

- Installing a Scan Module
- Using the Standard Range Scan Module
- Scanning Options

Installing a Scan Module

To use the terminal, you must have a scan module installed on the terminal. The scan module is usually installed at the Intermec factory.

You may want to change the scan module and install another type of scan module on the terminal. Use these instructions to remove and install the scan module.

Note: *Observe all static electricity precautions before installing a module.*

To install a scan module

1. Make sure the terminal is off and then lay it face down on a clean and sturdy work surface.
2. Use a Phillips screwdriver and remove the three screws that secure the scan module to the terminal.
3. Remove the existing scan module from the terminal.
4. To install the module, align the module guides with the guides on the terminal (see illustration). **Gently** press down on the module to seat the connector guide pins and the module connector into the connector on the terminal.

Note: *The module guide pins and connector should fit easily into the connector on the terminal. DO NOT force the module into the connector or you may damage the module connector, the terminal connector, or both.*

5. Insert the three screws into the module and tighten them to secure the scan module to the terminal.

Installing a Scan Module

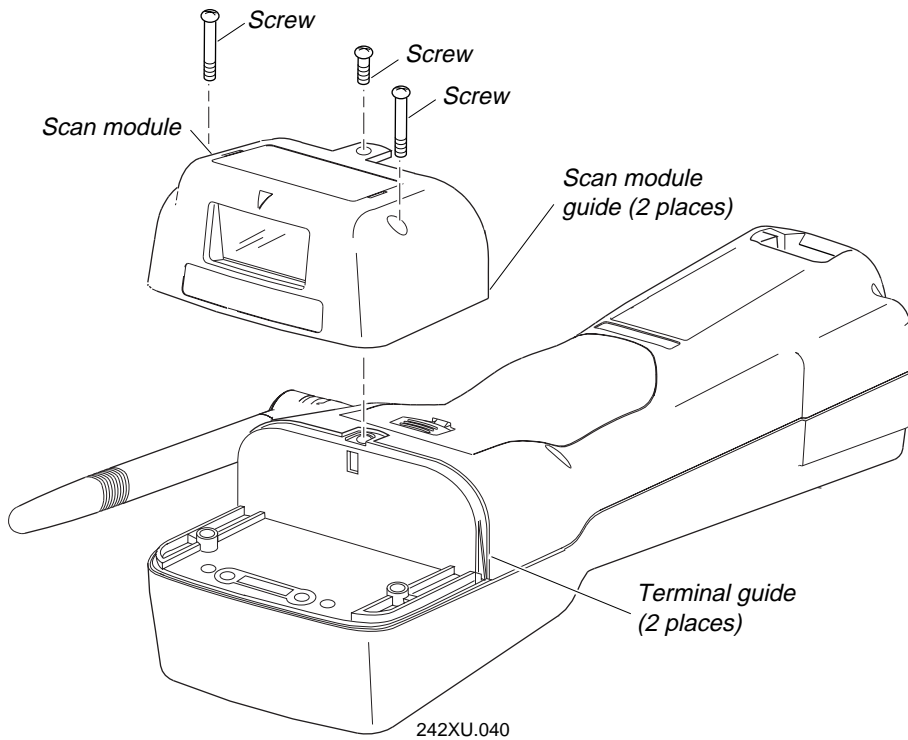

Using the Standard Range Scan Module

The standard range laser scan module emits a beam of laser light that is visible on a bar code label as you scan it. The terminal decodes the bar code label and enters the data or command you scanned.



Warning

Do not look directly into the window area or at a reflection of the laser beam while the laser is scanning. Long-term exposure to the laser beam can damage your vision.

Advertissement

Ne regardez pas directement la réflexion d'un rayon laser ou dans la fenêtre du laser lorsque celui-ci est en opération. Si vous regardez trop longtemps un rayon laser, cela peut endommager votre vue.

To scan a bar code label with the standard range scan module

1. Press  to turn on the terminal.
2. Hold the terminal at a slight angle a few inches from the bar code label. The laser scanner window in the scan module must be pointing toward the label.
3. Push the Scan button on the keypad. Direct the beam so that it falls across all bars in the bar code label. After the terminal successfully reads the label, you hear a high beep. The scanner stays on or turns off depending on the scanning options you have configured.

When the scanner laser beam is on, both scanner light emitting diodes (LEDs) at the top of the keypad are lit in a yellow color. Once the bar code label is scanned successfully, the LEDs are lit in a green color. The LEDs turn off after 2 seconds unless you start scanning another label.

Note: *Some of the scanning options described in the next section allow you to scan multiple bar code labels without having to press the Scan button each time. The yellow LEDs stay lit any time the scanner laser beam is on.*

4. Release the Scan button.

Scanning Labels With the Standard Range Scan Module

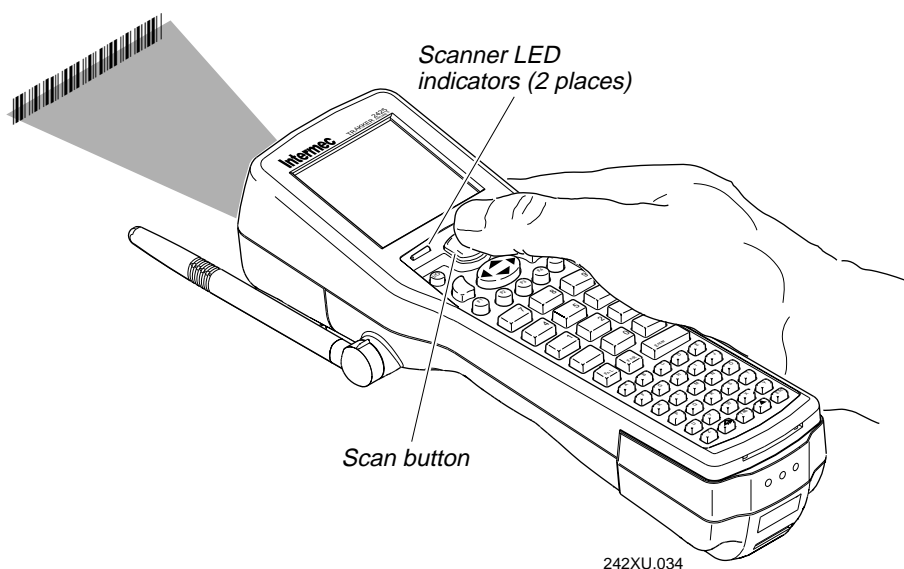

To successfully read a bar code label, the laser beam in the scan module must see all the bars in a label and a “quiet zone” at each end of the label. A quiet zone is a clean, non-printed space.

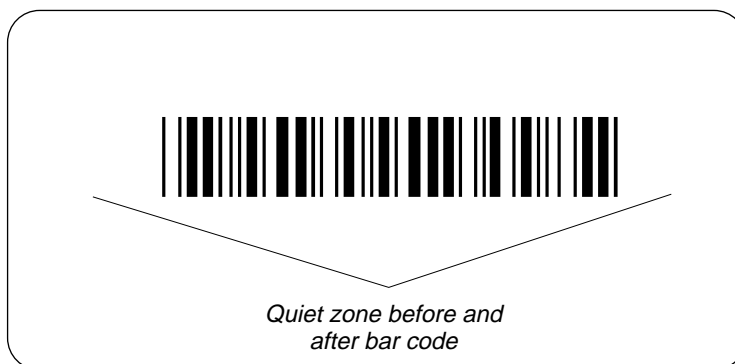

242XU.076

With the standard range scan module, you will have the best success if you hold the terminal so that the horizontal reading angle is near zero and the vertical reading angle is near 20 degrees. To get the best scan angle, hold the terminal so that the scan module is pointing toward bar code label. Tilt the terminal up or down slightly (20 degrees). You can also watch the laser beam. The laser beam becomes the brightest at the best scan angle.

Optimum scan angles vary with the type and printing quality of the bar code label, the distance of the terminal from the label, and the lighting of the work area.

***Note:** You should not scan the bar code label “straight on.” In a 2-degree conical “dead zone” directly above the label, the laser beam may reflect back into the scanner window and prevent the terminal from reading the label. At certain angles and straight on, you may not see the laser beam.*

Scanning Options

You can set several configuration command parameters to configure the laser scanner to meet your needs. The parameters available are:

Decode Security Defines the security level to use when decoding bar codes. When you select a lower decode security level, the terminal can decode bar codes with poorer print quality.

Scan Ahead Allows you to scan a number of bar code labels at one time. The labels are held in a stack until the terminal can process the data.

Scanner Mode Defines how the scanner operates when you press the Scan button or activate a cabled laser scanner. In One-Shot mode, the laser turns on and stays on until you release the button or scanner trigger, or a label is decoded. In Automatic mode, you can continuously scan bar code labels without having to release the button or scanner trigger between labels.

Scanner Redundancy Defines the number of scans (voting) the scanner takes of the same label. When set, voting requires the terminal to decode the same bar code label multiple times during a single scanner event, and compare the decoded information for a match before signaling a good read.

Scanner Selection Identifies the type of scanner you have connected to the TRAKKER 2425 terminal module for cabled scanners. The terminal can optimize the scanning performance by using the scanner you define in this command.

Scanner Timeout Defines the maximum length of time the scanner stays on each time you press the Scan button or activate the cabled laser scanner.

Scanner Trigger Allows you to set the triggering to level or edge triggering. With level triggering, you activate the scanner and the laser turns on and stays on until you release the Scan button or the trigger on a cabled scanner. In edge triggering, you activate the scanner and the laser turns on and stays on until you activate the scanner a second time, or the scanner timeout turns the laser off.

There are several ways to set the scanner commands on the terminal. For help configuring the terminal, see Chapter 3, “Configuring the Terminal.” For help using the scanner configuration commands, see Chapter 8, “Configuration Command Reference.”

3

Configuring the Terminal

This chapter explains how to configure the terminal, discusses the terminal's configuration parameters, describes how to restore the default configuration, and concludes by listing the configuration parameters.

How to Configure the Terminal

You can configure the TRAKKER 2425 terminal by using either of the methods described in detail in this chapter:

Using the TRAKKER 2400 Menu System With menus and dialog boxes, the TRAKKER 2400 Menu System lets you view the current configuration and modify configuration parameters.

Configuring the terminal by scanning bar codes You can change the terminal's current configuration by scanning Code 39 or Code 93 bar code labels that contain configuration commands. This is a fast, easy way to change the terminal's configuration. You can scan the bar code labels in this manual, or you can create your own bar code labels.

Note: *You can also configure the terminal over the network from the Model 200 Controller or the host computer. For help, see "Configuring the Terminal Over the Network" in Chapter 4.*

Learning About Configuration Parameters

You can customize many operating characteristics of the TRAKKER 2425 terminal, such as the volume of its audio signals and the bar code symbologies it decodes. These characteristics are controlled by configuration parameters. The values you set for the configuration parameters determine how the terminal operates.

By customizing the terminal's configuration, you can set up the terminal to operate easily and efficiently within your data collection system.

Note: *To learn the purpose and syntax of each configuration parameter or command, see Chapter 8, "Configuration Command Reference." The commands are listed alphabetically.*

The configuration parameters can be organized into three groups, which are discussed in the next sections: bar code symbologies, communications, and general operation. When you configure the terminal, you are performing one or more of these tasks:

- Choosing the Symbologies the Terminal Decodes
- Specifying How the Terminal Will Communicate
- Controlling How the Terminal Will Operate

Choosing the Symbologies the Terminal Decodes

This list contains all the bar code symbologies the terminal can decode:

- Codabar
- Code 2 of 5
- Interleaved 2 of 5 (I 2 of 5)
- Code 11
- Code 39
- MSI
- Code 128
- Code 49
- Plessey
- Code 16K
- Code 93
- UPC/EAN

When the terminal ships, only these three symbologies are enabled:

- Code 39
- Code 128
- UPC/EAN

If you are using one of the other symbologies to encode your bar code labels, you need to configure the terminal and enable the symbology. To quickly enable symbologies, see “Enabling Bar Code Symbologies” in Chapter 1.

To ensure that the terminal can operate quickly and efficiently, you should enable only the bar code symbologies that you are going to scan. When you enable each bar code symbology, you may need to set a check digit, the length of the bar code label, or other options. For help, see Chapter 8, “Configuration Command Reference.”

Specifying How the Terminal Will Communicate

Before you can use the terminal to communicate with other devices in your network, you must set the network parameters, radio frequency parameters, and address information. For example, you must set the Controller IP Address so the terminal can transmit data to and receive data from the Model 200 Controller. To learn how to configure the terminal to fit into your network, see Chapter 4, “Operating the Terminal in a Network.”

Controlling How the Terminal Will Operate

The operating parameters let you adjust the way the terminal operates. By customizing the operating parameters, you can:

- set the terminal to automatically shut off after a specified length of time.
- set the terminal to resume applications or restart applications.
- modify data transactions by appending the time.
- modify bar code data by using preambles and postambles.
- enable or disable specific reader commands.
- change the frequency and volume of the beeper or audio signals.
- control the display contrast and backlight timeout.
- enable or disable the keypad clicker and keypad caps lock.
- customize the way the scan module operates by selecting scan ahead data buffering, type of scanner device, decode security level, scanner timeout value, and trigger modes.

Configuring the Terminal With the Menu System

The TRAKKER 2400 Menu System is a menu-driven application that lets you configure the terminal, view system information, and run diagnostics. You can access the TRAKKER 2400 Menu System while running any application.

To access the TRAKKER 2400 Menu System

- Press **[F]** **[L]** **[T]** **[2]** **[M]** or scan this bar code:

Note: You must press the **[L]** (Left Enter) key in this key sequence, not the **[R]** (Right Enter) or **[↵]** keys.

Enter Test and Service Mode



..

The Main Menu appears, displaying four menu options.

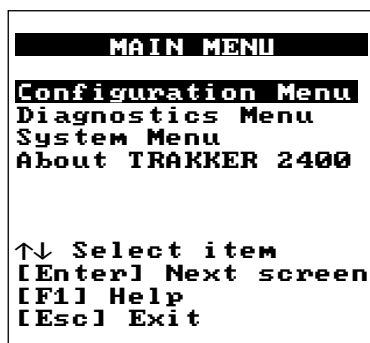

242XU.001

Configuration Menu Choose the Configuration Menu to configure bar code symbologies, network and communications parameters, and the terminal's operating characteristics.

Diagnostics Menu Choose the Diagnostics Menu to run hardware, software, or system diagnostics to help analyze and fix problems on the terminal. You can also view information about the system. For help, see “Running Diagnostics” in Chapter 6.

System Menu Choose the System Menu to load the default configuration, set the time and date, store the terminal’s configuration in flash memory, and upgrade the firmware.

About TRAKKER 2400 Choose this option to see part number and version information about the boot code and firmware loaded on the T2425 terminal. You may need this information if you are working a problem with an Intermec representative.

Exploring the Configuration and System Menus

When you access the TRAKKER 2400 Menu System, the Main Menu appears. You use the Configuration Menu and the System Menu to configure the terminal.

The Configuration Menu contains these commands:

```
CONFIGURATION MENU
Symbologies Menu
*Communications Menu
Terminal Menu

↑↓ Select item
[Enter] Next screen
[F1] Help
[Esc] Exit
```

242XU.010

Symbologies Menu Choose the Symbologies Menu to configure and activate the bar code symbologies the terminal can decode. An asterisk (*) on the Symbologies Menu indicates that the symbology is active. For help, see “Choosing the Symbologies the Terminal Decodes” earlier in this chapter.

Communications Menu Choose the Communications menu to configure the primary network parameters, the advanced network parameters, and the RF driver parameters. For help, see Chapter 4, "Operating the Terminal in a Network."

Terminal Menu Choose the Terminal Menu to configure the way the terminal, keypad, scanner, or display operate. For help, see "Controlling How the Terminal Will Operate" earlier in this chapter.

The System Menu contains these commands:

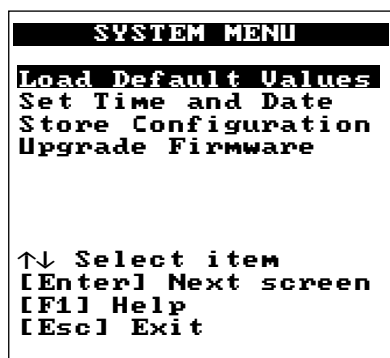

242XU.051

Load Default Values Lets you load the default configuration values. For help, see "Restoring the Terminal's Default Configuration" later in this chapter.





Set Time and Date Lets you set the current time and date. For help, see "Setting the Time and Date" in Chapter 1.



Store Configuration Stores the current configuration in flash memory, including any changes you have made in the menu system. When you exit the TRAKKER 2400 Menu System, you will also be prompted to save your changes. For help, see "Exiting the TRAKKER 2400 Menu System" later in this chapter.

Upgrade Firmware Lets you upgrade the system firmware on the terminal. For help, see "Upgrading the Firmware" later in this chapter.

You can use the keystrokes described next to move around in the TRAKKER 2400 Menu System, or you can scan bar code labels. For a list of bar code labels, see the “Full ASCII Bar Code Chart” in Appendix B.

Selecting Menus and Commands

Press ▲ or ▼ to choose a menu name from the Main Menu. Then press , , or  to display the commands in the selected menu. In this example, you press ▼▼ to display the System Menu:

Note: In the menu system, the , , and  keys all work the same way.

```

MAIN MENU
Configuration Menu
Diagnostics Menu
System Menu
About TRAKKER 2400

↑↓ Select item
[Enter] Next screen
[F1] Help
[Esc] Exit

```

```



SYSTEM MENU
Load Default Values
Set Time and Date
Store Configuration
Upgrade Firmware

↑↓ Select item
[Enter] Next screen
[F1] Help
[Esc] Exit

```

242XU.058

Press ▲ or ▼ to choose a command or option from a menu, and then press  to execute the command or option.

Note: You can press  at any time to display an online help screen. Press  to exit a help screen.

Filling In Fields and Marking Check Boxes

Screens list the options for each configuration parameter, diagnostic, or system option. Below each option name is either a toggle field or an entry field:

- In a toggle field, you press ◀, ▶, or to view the options for that field.
- In an entry field, you type a value into the field. To edit the data in an entry field, use the ◀, ▶, , or keys. On a terminal emulation keypad, you can also use the Delete and Insert keys to edit an entry field.

For example, the Code 49/Code 16K screen has toggle and entry fields. The Code 49 field is a toggle field. Press to toggle between Enabled and Disabled. The Function Codes field for F1, F2, and F3 are entry fields. You type a value into the field for each function code.

```
CODE 49 / CODE 16K
Code 49: Enabled
Code 49
Function Codes:
F1:
F2:  \x0D\x0A
F3:
Code 16K:
Standard
OK      CANCEL
```

242XU.052

Some screens contain check boxes. Check boxes are used when more than one option can be selected at one time.

To mark or clear check boxes

- Press . For example, to disable the Backlight reader command, choose the Backlight check box and press to clear the check box.

Marking or Clearing Check Boxes on the Reader Command Menu

```
READER COMMAND MENU
[Space] to enable or
disable a command
[X] Backlight
[X] Backspace
[X] Change Config
[X] Clear
[X] Default Config
[X] Enter Accum
[X] Exit Accum
[X] Multi-Read
[X] Reset
↓ more
```

```
[X] Scanner On
[X] Scanner Off
[X] Test & Service

OK CANCEL
```

242XU.053

To move to the next field

- Press ▼ or .

To move to the previous field

- Press ▲.

Entering ASCII Control Characters

You can include ASCII control characters in a postamble or preamble in the TRAKKER 2400 Menu System. For a definition of the postamble or preamble, see Chapter 8, "Configuration Command Reference."

Note: You can also configure the postamble or preamble to characters from the extended ASCII character set such as the Field Exit code for 5250 TE. For help, see "Auto-Advancing Through Fields on 5250 TE Screens" in Chapter 5.

To enter ASCII control characters for a preamble or postamble

1. Decide which ASCII control character you want to set for the preamble or postamble. Look up the control character in the Full ASCII Table in Appendix B and find the two-digit hexadecimal number.

For example, you find ETX in the Full ASCII Table and learn that 03 is the two-digit hexadecimal number for ETX.

2. Use the TRAKKER 2400 Menu System to configure a preamble or postamble. From the Main Menu, choose Configuration Menu.
3. From the Configuration Menu, choose Terminal Menu.
4. From the Terminal Menu, choose Preamble/Postamble.

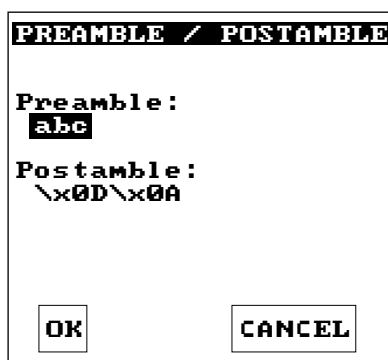

242XU.057

5. Move the cursor to the field for the preamble or postamble.

6. Type the control character or escape character sequence in the preamble or postamble field.

- To type a control character in the preamble or postamble field, use this syntax:



```
\xhh
```

where *hh* is the one or two-digit hexadecimal number for the ASCII control character. For example, to enter ETX as a preamble, type:

```
\x03
```

- To type an escape character (backslash) in the preamble or postamble field, use the next table. The application ignores the first backslash (\) character and saves the next character(s). For example:

| Enter These Characters | Preamble/Postamble Saved |
|------------------------|--------------------------|
| \\ | \ |
| \h | h |
| \x | x |
| \\k | \k |
| \ | no data |

7. Press  or choose OK to save your changes and exit the screen.
8. Choose another menu from the Terminal Menu or press  to exit. The Configuration Menu appears.

For help exiting the menu system, see “Exiting the Configuration Menu” later in this chapter.

Exiting Screens and Saving Changes

When you exit a screen, you can save or discard your changes:

| Task | Description |
|--|---|
| To exit a screen and save the changes | Choose OK and press <input type="button" value="↵"/> . Or, press <input type="button" value="↵"/> in any field except the Cancel button. |
| To exit a screen and discard the changes | Choose Cancel and press <input type="button" value="↵"/> . Or, press <input type="button" value="Esc"/> in any field. |

Exiting the Configuration Menu

1. Press to exit the Configuration Menu. If you have made any changes to the current configuration, this screen prompts you to save the new configuration in RAM.

The current configuration (also called the runtime configuration) is the set of parameters currently enabled on the terminal.



242XU.059

2. Choose Yes and press to save your changes in RAM and update the current configuration on the terminal. Choose No and press to exit without changing the configuration. The Main Menu appears.

3. Choose another menu from the Main Menu or press to exit the TRAKKER 2400 Menu System.

For help exiting the menu system, see the next procedure for “Exiting the TRAKKER 2400 Menu System.”

Exiting the TRAKKER 2400 Menu System

1. From the Main Menu, press . If you have made any changes, this screen prompts you to store the changes in flash memory.

You can also save the runtime configuration in flash memory by choosing the Store Configuration command from the System Menu. For help, see “Saving Configuration Changes in Flash Memory” later in this chapter.

Note: When you boot or reset the terminal, it uses the configuration you last saved in flash memory.

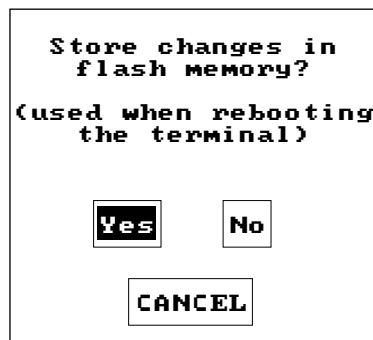

242XU.054

2. Choose Yes and press to save your changes in flash memory. Choose No and press to exit without saving. The Exiting TRAKKER 2400 Menu System screen appears.

Note: If you changed the configuration, you are prompted to save your changes in RAM as you exited the Configuration Menu. If you want the configuration changes to be stored in flash memory, you need to choose Yes in this screen.

Exiting TRAKKER 2400 Menu System Screen



242XU.055

3. Choose OK and press to exit the TRAKKER 2400 Menu System. Choose Cancel and press to return to the Main Menu.

After you exit the menu system, the terminal will resume the application you were running when you started the menu system.

Configuring the Terminal by Scanning Bar Codes

You can configure the terminal by scanning bar code labels listed in this manual or by creating your own Code 39 or Code 93 bar code labels. For help, see Chapter 8, “Configuration Command Reference.”

Note: If you are working in the TRAKKER 2400 Menu System, you cannot scan configuration commands. Exit the menu system to scan configuration commands.

For example, you can use the Beep Volume configuration command to adjust the volume of the terminal’s audio signals. You can scan this bar code label to set the beep volume to a quiet audio level:

Set Beep Volume to Quiet



S+BV1

You can create bar code labels that contain more than one configuration command. For example, you can create one bar code label to configure the terminal for:

- One-Shot Scanner mode (SB0)
- Scanner Redundancy set to high (SR2)
- Beep Volume set to very loud (BV4)
- Disable Keypad Clicker (KC0)

One-Shot Scanner Mode, Set Scanner Redundancy to High, Set Beep Volume to Very Loud, Disable Keypad Clicker



S+SB0SR2BV4KC0

To configure these same four configuration commands, you can scan four separate bar code labels in Chapter 8, “Configuration Command Reference.”

When you create a bar code label to set several configuration commands, follow these rules:

- The bar code label must be printed using Code 39 or Code 93 symbology.
- The bar code label must include the start and stop character. Most bar code printing utilities automatically include the start and stop character.
- The bar code label must start with \$+ (Change Configuration command).
- Each configuration command must include the command syntax and the value for the command. For example, BV is the command syntax for Beep Volume and the value 4 sets the beep volume to very loud.
- If you set one configuration command to a string of ASCII characters and another configuration command follows, you must enclose the value in quotes. If you do not include the quotation marks, the terminal will interpret everything after the first command as data and will not find the second configuration command.

For example, to set the preamble to BV, use \$+ADBV (no quotes are needed). To set the preamble to BV and turn off the beep volume, use \$+AD"BV"BV0, or change the order and use \$+BV0ADBV. To clear the preamble and postamble from a single label, use \$+AD""AE.

Note: To scan a Code 39 bar code label that includes quotes, you must configure the terminal to use Code 39 in Full ASCII mode. For help, see "Code 39" in Chapter 8.

- To include quotation marks when you set a value, the entire value must be enclosed in quotation marks. Type two sets of quotation marks (""") to include one quotation mark as the value for a command. For example, to set the preamble to ABC"D, use \$+AD"ABC""D".

When you scan bar code labels, you change the terminal's current runtime configuration. The changes are not saved in the terminal's flash memory. To save the changes in flash memory, use the TRAKKER 2400 Menu System. For help, see the next section, "Saving Configuration Changes in Flash Memory."

Saving Configuration Changes in Flash Memory

The TRAKKER 2425 terminal uses two copies of the configuration:

Runtime or RAM configuration is the current or active set of parameters and options enabled on the terminal. The configuration is stored in RAM and will be lost if you boot or reset the terminal.

Boot or flash configuration is the set of parameters and options last saved in flash memory. The configuration is stored in flash memory and will be saved and used if you boot or reset the terminal.

Here are the three ways you can configure the terminal and how the configuration is updated:

| Configure the Terminal | Runtime or RAM Configuration Updated? | Boot or Flash Configuration Updated? |
|--|---------------------------------------|--------------------------------------|
| Using the TRAKKER 2400 Menu System | Yes (see Note) | Yes (see Note) |
| Scanning bar code labels | Yes | No |
| From the network (Model 200 Controller or host computer) | Yes | No |

Note: You are prompted to save your changes in RAM and flash as you exit the Configuration Menu and the TRAKKER 2400 Menu System. Your changes are saved if you choose Yes at each screen.

If you configure the terminal by scanning bar code labels or from the network, you may want to save the changes in flash memory.

To save configuration changes in flash memory

1. Press or scan this bar code. The Main Menu appears.

Enter Test and Service Mode



..

2. Choose System Menu and press . The System Menu appears.

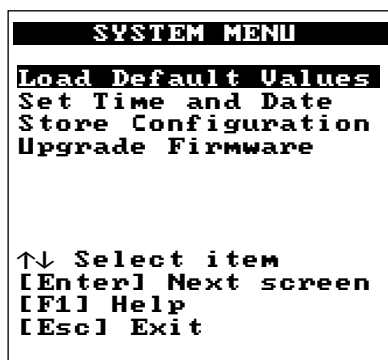



242XU.051

3. Choose the Store Configuration command and press . The Store Configuration screen appears.



242XU.072

4. Choose OK to save the configuration in flash memory. To exit without saving the configuration, choose Cancel. The System Menu appears.
5. Press  to exit the System Menu. The Main Menu appears.
6. Choose another menu from the Main Menu or press  to exit the TRAKKER 2400 Menu System.

Restoring the Terminal's Default Configuration

When you configure the terminal according to the instructions presented in this chapter, the parameters remain in effect until you reconfigure them. If you configure the terminal but do not save your changes in flash memory, the parameters will remain in effect until you boot or reset the terminal.

The default configuration for the terminal is listed in Appendix A. You can use the TRAKKER 2400 Menu System or scan the Default Configuration bar code label to return the terminal to its default configuration. For help on the Default Configuration label, see “Default Configuration” in Chapter 7.

For example, if you load the default values, the Controller IP Address is set to a default value of 0.0.0.0, and Beep Volume is set to normal volume level.

Note: If you restore the default configuration, you need to set the primary network communications parameters to reestablish communications with other devices in the 2.4 GHz network.

To restore the terminal's default configuration

1. Press or scan this bar code:

Enter Test and Service Mode



..

The Main Menu appears.

2. Choose System Menu and press . The System Menu appears.
3. Choose the Load Default Values command and press . The Load Default Values screen appears.

Load Default Values Screen

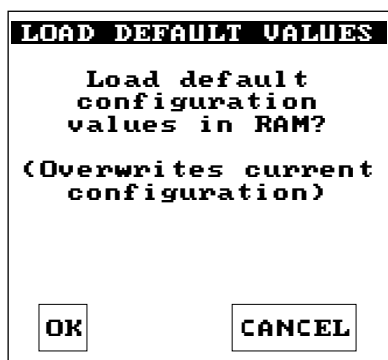

242XU.056

4. Choose OK and press to load the default configuration values. The default values will override the current runtime configuration on the terminal.

To exit without loading the default values, choose Cancel and press . The System Menu appears.

5. Press to exit the System Menu. The Main Menu appears.
6. Choose another menu from the Main Menu or press to exit the TRAKKER 2400 Menu System. For help exiting the menu system, see "Exiting the TRAKKER 2400 Menu System" earlier in this chapter.

Upgrading the Firmware

The terminal firmware includes these items:

- TRAKKER 2400 Menu System
- Terminal emulation or screen mapping application
- TE Configuration Menu
- Operating environment, firmware, and drivers

When a new release of the firmware is available, your local Intermecc service representative can upgrade the firmware on the TRAKKER 2425 terminal. For help, contact your local Intermecc service representative.

To upgrade the firmware

1. Press **[F] [T] [2] [M]** or scan this bar code:

Enter Test and Service Mode



..

The Main Menu appears.

2. Choose System Menu and press **[↓]**. The System Menu appears.

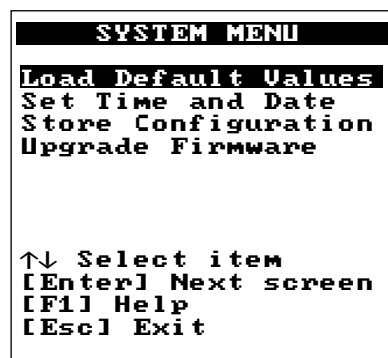

242XU.051



3. Choose the Upgrade Firmware command and press . The Upgrade Firmware screen appears.



242XU.074

4. To exit without upgrading, choose Cancel. The System Menu appears. Press  to exit the System Menu. The Main Menu appears.

If you are upgrading the firmware with your local Intermec service representative, choose OK to continue and upgrade the firmware. The terminal reboots and then displays the Loader Waiting screen. For help, see the Readme.txt file on the TRAKKER Antares Firmware disk.

Note: If you reach the Loader Waiting screen and cannot upgrade or continue, press  or  to exit without upgrading the firmware. The Boot Menu appears. Press  to boot the terminal and continue.

6. Choose another menu from the Main Menu or press  to exit the TRAKKER 2400 Menu System.

Recording Your Terminal's Configuration

These tables list all of the configuration parameters, their options, and where to find them in the Configuration Menu of the TRAKKER 2400 Menu System. The default setting for each parameter is identified in ***bold italics*** in these tables.

You should have an accurate record of the terminal's configuration settings in case the terminal's volatile memory and the configuration setup is lost. You can record the configuration on the following pages by circling the option you chose for each parameter or writing the value.

Bar Code Symbolologies Table

| Parameter (Syntax) | Options | Location in Configuration Menu |
|-------------------------|--|---|
| Codabar (CD) | <i>Disabled</i> ABC Standard Concatenated | Symbologies Menu, Codabar option |
| Start/Stop digit | Discard <i>Retain ABCD</i> Retain DC1-DC4 | |
| Code 11 (CG) | <i>Disabled</i> One check digit Two check digits | Symbologies Menu, Code 11 option |
| Code 16K (CP) | <i>Disabled</i> Standard Function code 1 | Symbologies Menu, Code 16K option |
| Code 2 of 5 (CC) | <i>Disabled</i> 3 bar start/stop, label length 2 bar start/stop, label length | Symbologies Menu, 2 of 5, I2 of 5 option |
| Code 39 (CB) | Disabled <i>No check digit</i> Check digit HIBC AIAG check digit | Symbologies Menu, Code 39 option |
| Check digit | Discard <i>Retain</i> | |

Bar Code Symbologies Table (continued)

| Parameter (Syntax) | Options | Location in Configuration Menu |
|-------------------------------------|--|---|
| Code 39 (continued) ASCII | Non-full ASCII Full ASCII Mixed-full ASCII | Symbologies Menu, Code 39 option |
| Code 49 (CJ) | Disabled Enabled | Symbologies Menu, Code 49 option |
| Function Code 1 (CK) | None (disabled) Any two ASCII characters | |
| Function Code 2 (CL) | \x0D\x0A (CR LF) Any four ASCII characters | |
| Function Code 3 (CM) | None (disabled) Any two ASCII characters | |
| Code 93 (CF) | Disabled Enabled | Symbologies Menu, Code 93 option |
| Code 128 (CH) | Disabled Standard UCC/EAN-128 | Symbologies Menu, Code 128 option |
| Interleaved 2 of 5 (CA) | Disabled Fixed length Variable length, no check digit Case Code, check digit Variable length, check digit | Symbologies Menu, 2 of 5, I2 of 5 option |
| MSI (CN) | Disabled No check digit 1 modulus 10 check digits 2 modulus 10 check digits | Symbologies Menu, MSI option |
| Check digits | Discard Retain | Symbologies Menu, MSI option |
| Plessey (CI) | Disabled Discard check digit Retain check digit | Symbologies Menu, Plessey option |

Bar Code Symbologies Table (continued)

| Parameter (Syntax) | Options | Location in Configuration Menu |
|-----------------------------|--|-------------------------------------|
| UPC/EAN (CE) | | Symbologies Menu, UPC/EAN option |
| UPC-A/EAN-13 (Version A) | Disabled Enabled UPC-A only | |
| UPC-E (Version E) | Disabled Enabled | |
| EAN-8 | Disabled Enabled | |
| Supplementals | Yes No | |
| Check digit | Discard Retain | |
| Number system digit | Discard Retain | |
| UPC-A leading zero | Discard Retain | |

Communications Table

| Parameter (Syntax) | Options | Location in Configuration Menu |
|------------------------------------|---|---|
| Controller IP Address (NC) | 0.0.0.0 The IP address field is four numbers separated by periods. | Communications Menu, Primary Network option |
| Default Router (NX) | 0.0.0.0 The Router field is four numbers separated by periods. | Communications Menu, Advanced Network option |
| Network Activate (NA) | Disabled 2.4 GHz RF (enabled) | Communications Menu, Primary Network option |
| Network Loopback (NL) | Disabled Enabled | Communications Menu, Advanced Network option |
| RF Domain (RW) | 0 0 - 15 | Communications Menu, RF Driver option |
| RF Security ID (RS) | None (no characters) Any 20 ASCII characters | Communications Menu, RF Driver option |
| RF Wakeup On Broadcast (RB) | No (disabled) Yes (enabled) | Communications Menu, RF Driver option |
| Subnet Mask (NS) | 255.255.255.0 The Subnet Mask field is four numbers separated by periods. Each number is from 0 to 255. | Communications Menu, Advanced Network option |
| Terminal IP Address (ND) | 0.0.0.0 The IP address field is four numbers separated by periods. | Communications Menu, Primary Network option |
| UDP Port (NG) | 05555 5001 - 65535 | Communications Menu, Advanced Network option |

Terminal Operations Table

| Parameter (Syntax) | Options | Location in Configuration Menu |
|---------------------------------------|---|---|
| Append Time (DE) | Disabled Enabled | Terminal Menu, Append Time option |
| Auto Shutoff (EZ) | 0 (disabled) 2 - 75 minutes | Terminal Menu, Power Management option |
| Beep Volume (BV) | Off Quiet Normal Loud Very loud | Terminal Menu, Beeper option |
| Decode Security (CS) | Low Moderate High | Terminal Menu, Scanner option |
| Display Backlight Timeout (DF) | Disabled (0) 1 - 60 seconds 10 seconds | Terminal Menu, Display option |
| Display Contrast (DJ) | 0 - 7 3 | Terminal Menu, Display option |
| Keypad Caps Lock (KA) | On Off | Terminal Menu, Keypad option |
| Keypad Clicker (KC) | Disabled Enabled | Terminal Menu, Keypad option |
| Postamble (AE) | None (no characters) Any 25 ASCII characters | Terminal Menu, Preamble/Postamble option |
| Preamble (AD) | None (no characters) Any 25 ASCII characters | Terminal Menu, Preamble/Postamble option |
| Reader Commands (DC) | Disable all reader commands Enable all reader commands Enable override Disable override | Terminal Menu, Reader Commands option |

Terminal Operations Table (continued)

| Parameter (Syntax) | Options | Location in Configuration Menu |
|---|--|--|
| Reader Commands (DC) Enable/Disable specific Reader Commands | Backlight Backspace Change Configuration Clear Default Configuration Enter Accumulate mode Exit Accumulate mode Multiple-Read Labels Reset Scanner Trigger Off Scanner Trigger On Test & Service Mode | Terminal Menu, Reader Commands option, Enable single commands option |
| Resume Execution (ER) | Not Allowed Allowed | Terminal Menu, Power Management option |
| Scan Ahead (SD) | Disabled Enabled | Terminal Menu, Scanner option |
| Scanner Mode (SB) | One-Shot mode Automatic (Auto-trigger) mode | Terminal Menu, Scanner option |
| Scanner Redundancy (SR) | None Normal High | Terminal Menu, Scanner option |
| Scanner Selection (SS) (See the Note below) | All compatible scanners 146x CCD scanners 155x laser scanners 151x laser scanners 1545 laser scanner Symbol scanners | Terminal Menu, Scanner option |
| Scanner Timeout (SA) | Disabled (0) 1-60 seconds | Terminal Menu, Scanner option |
| Scanner Trigger (SC) | Level Edge | Terminal Menu, Scanner option |
| Time in Seconds (DA) | Disabled Enabled | Terminal Menu, Append Time option |

Note: The Scanner Selection command is only used when you have a module for cabled scanners installed. If you have a standard range scan module, Scanner Selection shows the option "Integrated Scanner."

4

Operating the Terminal in a Network

This chapter describes the 2.4 GHz network and explains how the TRAKKER 2425 terminal fits in your network. It also explains how to install and configure the terminal, use RF communications, configure the terminal over the network, and provides technical details about network connectivity and protocols.

How the TRAKKER 2425 Fits Into Your Network

The TRAKKER 2425 terminal is a hand-held data collection terminal with network support. The T2425 terminal communicates with a host computer in the Intermec 2.4 GHz network through the Model 200 Controller across the Ethernet network. The 0100 Access Point acts as a bridge to allow communications between the Ethernet network and the wireless T2425 terminals.

TRAKKER 2425 Terminals in a 2.4 GHz Radio Frequency Data Collection Network

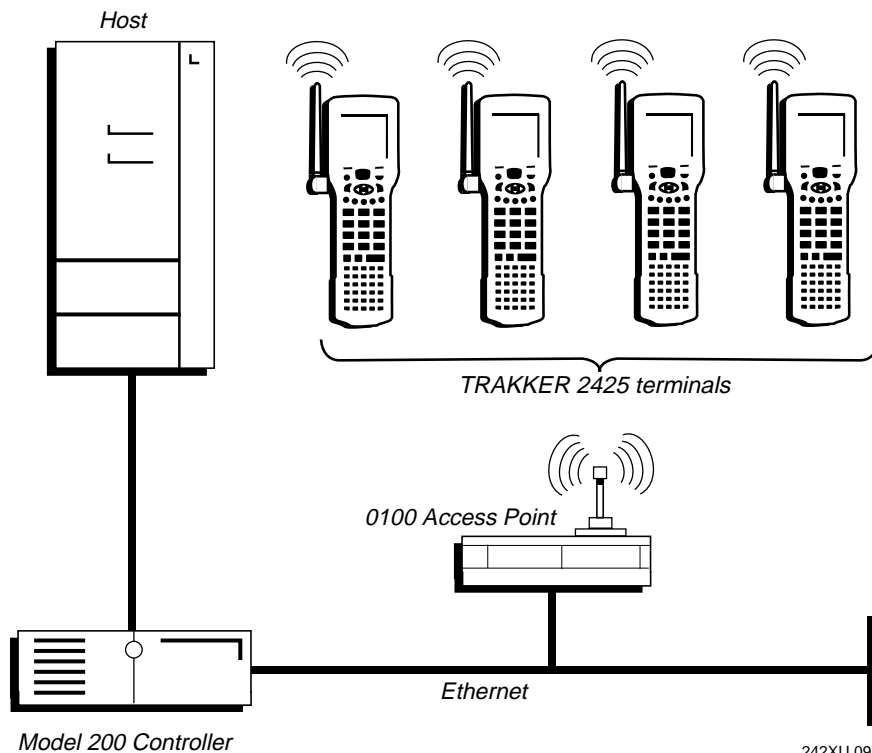

242XU.095

Installing TRAKKER 2425 Terminals in Multiple Subnetworks

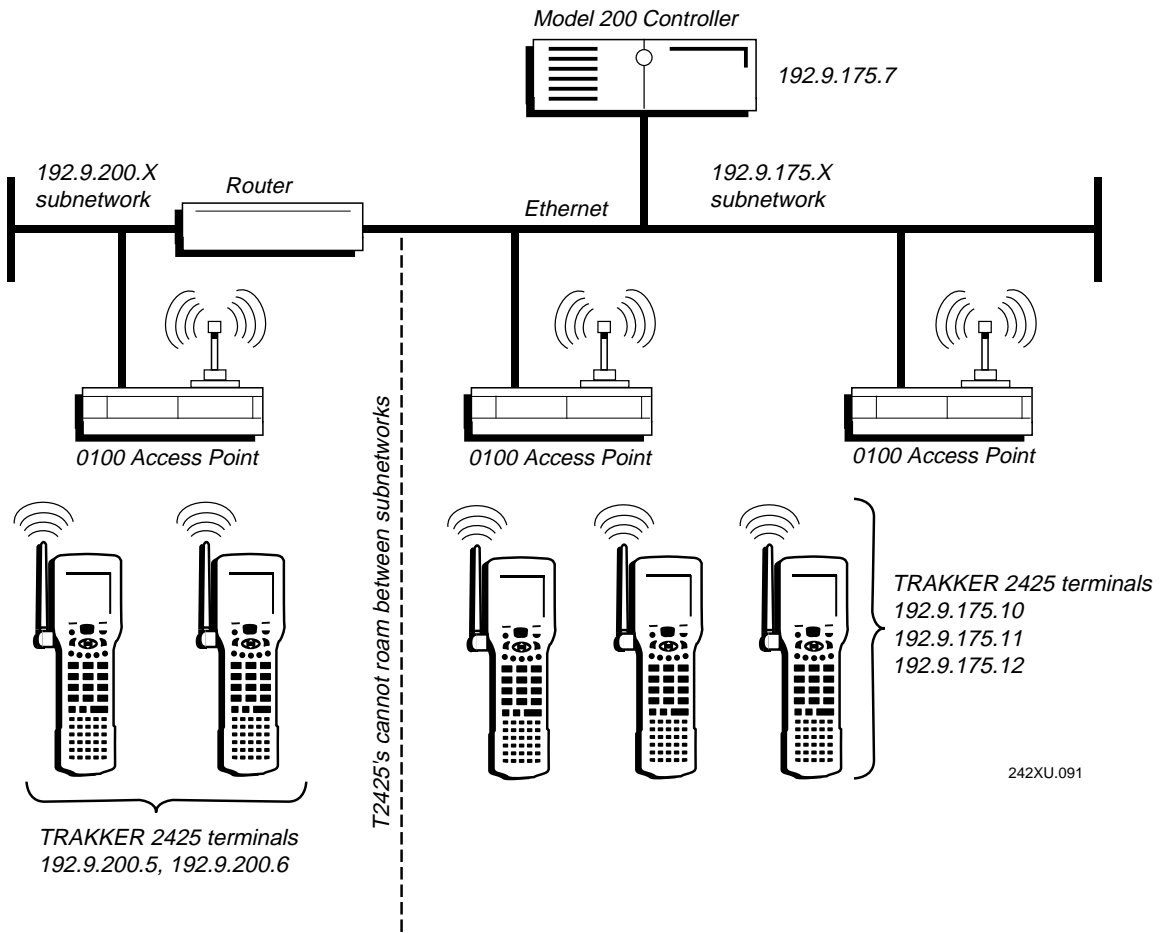

242XU.091

You can install the TRAKKER 2425 terminals, 0100 Access Points, and Model 200 Controller in your 2.4 GHz network as shown in the illustration above. The T2425 terminals may only communicate with the access points that are in the same IP subnetwork. All the terminals and access points in this illustration communicate with the controller at IP address 192.9.175.7.

TRAKKER 2425 Terminals Communicating Across Subnetworks

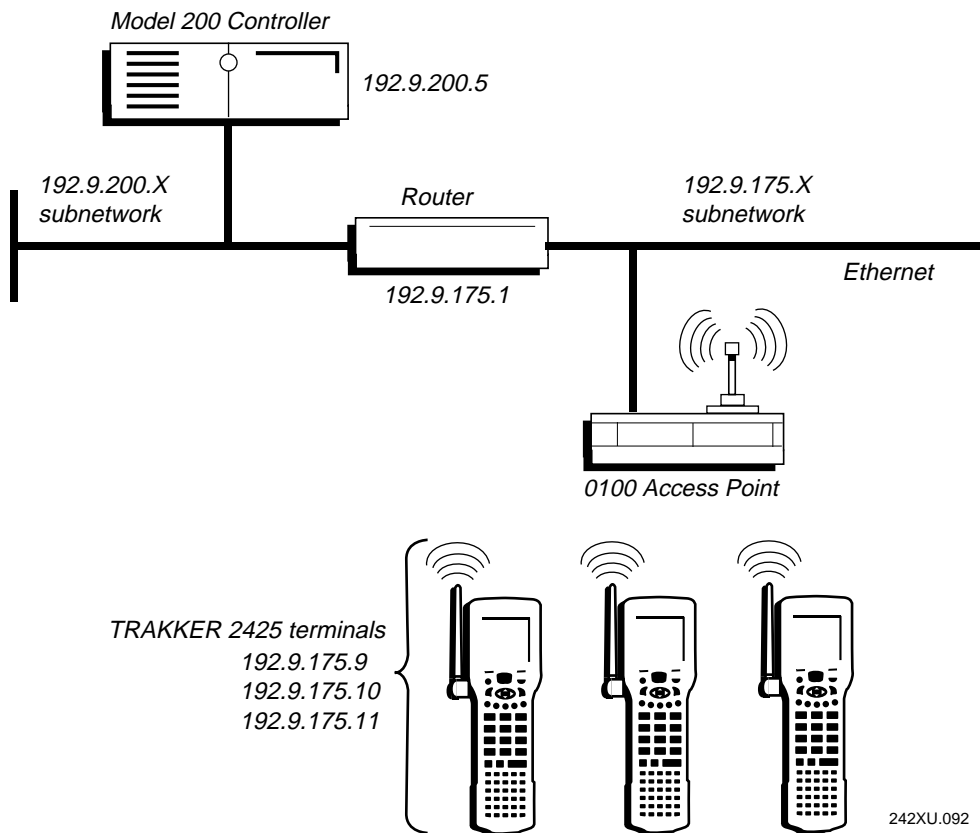

You can install the TRAKKER 2425 terminals and 0100 Access Points in one IP subnetwork and install the Model 200 Controller in another IP subnetwork as shown in the illustration. In this network, you must configure additional network parameters (default router and subnet mask) as described later in this chapter.

Note: All 0100 Access Points that the TRAKKER 2425 terminal may communicate with and roam between must be on the same IP subnetwork. The terminal cannot roam between IP subnetworks.

Installing and Configuring the Terminal

Before you can begin using the TRAKKER 2425 terminal to collect data, you need to install and configure each device in the 2.4 GHz network by performing these steps:

1. Plan and prepare your network. Make sure you have all the equipment required to use the terminal in the network. Make sure you have IP addresses for all devices in the network.
2. Configure the Model 200 Controller.
3. Configure the 0100 Access Point.
4. Configure each TRAKKER 2425 terminal.

Each step is described in detail in the next sections.

Planning the Network Connection

To use the TRAKKER 2425 terminal in the 2.4 GHz network, you need these minimum requirements:

- Model 200 Controller
- 0100 Access Point
- An Ethernet cable drop: 10Base2 (thin coax BNC) or 10BaseT (twisted pair)

When you first consider purchasing a wireless data collection system, an Intermec representative works with you to perform a site survey at your facility. The site survey analyzes the range of radio frequency devices in your facility and determines the placement of the access points. The site survey ensures that the coverage of each access point overlaps to provide uninterrupted wireless access at any location within the building. This manual assumes that a site survey is complete and the access points are installed in your facility.

You need to work with your network administrator to plan and assign the IP address for each device in the 2.4 GHz network. You must assign and set the IP address for the Model 200 Controller, each 0100 Access Point, and each TRAKKER 2425 terminal.

Configuring the Model 200 Controller

The Model 200 Controller supports communications with the 2.4 GHz network across the Ethernet network. When you install and configure the controller, you identify the host computer(s) and TRAKKER 2425 terminals in your network. The terminals communicate through the controller with your host computer. For help installing the controller, see the *Model 200 Controller System Manual* (Part No. 063439).

To have the T2425 terminal communicate with the controller, you must configure these parameters on the controller:

- Configure the UDP (User Datagram Protocol) Plus network.
- Assign an IP address to each TRAKKER 2425 terminal.
- Enable all T2425 terminals.
- Define the host environment parameters, which includes configuring for terminal emulation or screen mapping.
- Define the host communications parameters, which includes the physical connection (network adapter cards) to the host computer.

To use the screen mapping application on the T2425 terminal, you must also configure the following:

- Create the script file using the Script Builder tool on the controller.
- Generate the template to download to the T2425 terminal.

Configuring the 0100 Access Point

The 0100 Access Point acts as a wireless bridge to provide RF communications between the TRAKKER 2425 terminal and the Model 200 Controller. For help, see the *0100 Access Point User's Manual* (Part No. 062367).

Note: All access points that the TRAKKER 2425 terminal may communicate with and roam between must be in the same IP subnetwork.

To have the T2425 terminal communicate with the access point, you must know the value of these parameters on the access point:

- RF domain
- RF security identification (ID) (optional)

Configuring the Terminal

When you install the TRAKKER 2425 terminal in a network, you must configure a set of network parameters that control how the terminal communicates in the network.

There are two ways to configure the network parameters:

- Use the TRAKKER 2400 Menu System. For help on configuring the network parameters, see Chapter 1, "Getting Started." For help on the menu system, see Chapter 3, "Configuring the Terminal."
- Scan the configuration command from a Code 39 or Code 93 bar code label. The configuration commands are listed alphabetically by command name in Chapter 8, "Configuration Command Reference."

The set of network parameters you must configure depends on whether you install the terminal on the same IP subnetwork as the Model 200 Controller, or on a different subnetwork. This table lists the parameters you configure in each type of network:

| Network Parameters | Same IP Subnetwork? | Different IP Subnetwork? |
|-----------------------|---------------------|--------------------------|
| Time and date | X | X |
| Network activate | X | X |
| Controller IP address | X | X |
| Terminal IP address | X | X |
| RF domain | X | X |
| RF security ID | Optional | Optional |
| Default router | | X |
| Subnet mask | | X |

The network parameters are defined in the next section.

Defining the Network Parameters

This section defines the network parameters you configure when installing the TRAKKER 2425 terminal in a network. For each parameter's syntax and options, see Chapter 8, "Configuration Command Reference."

Time and Date When you turn on the terminal for the first time, you must set the current time and date. You also need to set the time and date any time you lose all power to the terminal. For help, see “Setting the Time and Date” in Chapter 1.

Network Activate Disables or enables RF communications in the 2.4 GHz network. If the Network Activate parameter is disabled, the network is disabled, no RF communications are provided, and the radio is turned off. When the Network Activate parameter is enabled, the TRAKKER 2425 terminal will attempt to connect to the Model 200 Controller.

Controller IP Address An IP address is a network level address you assign to each device in a TCP/IP network. The Controller IP Address identifies the IP address assigned to the Model 200 Controller.

Terminal IP Address An IP address is a network level address you assign to each device in a TCP/IP network. The Terminal IP Address identifies the IP address assigned to the T2425 terminal. The IP address you set on the terminal must match the address that is set on the controller.

RF Domain The domain defines a logical partition or subnetwork of the network. To establish communications, you must assign the same domain number to every RF device in a wireless network. The domain number you set on the terminal must match the domain that is set on each access point the terminal may communicate with. You can continue to collect data with the terminal as you roam in between access points as long as all the devices have the same domain number.

RF Security Identification (ID) This optional parameter defines the password you can set for secured transmission and receipt of data between devices in the wireless network. To communicate, each access point and terminal must have matching security IDs. If the security ID is set on the 0100 Access Point, you must also set the security ID on each terminal that may communicate with the access point.

Note: You can only set the RF security ID with the 2.4 GHz network enabled. The Network Activate command must be configured to 2.4 GHz RF Network before you can save any changes to the RF security ID parameter.

Default Router Provides a software and hardware connection between two or more networks that permits traffic to be routed from one network to another on the basis of the intended destinations of that traffic. When the Model 200 Controller is on a different subnetwork than the T2425 terminal, you need to set the IP address assigned to the default router. The terminal uses the router address to send packets across the network to the controller. The default router must have an IP address on the same subnetwork as the terminal. The default of 0.0.0.0 means there is no default router.

Subnet Mask The subnet mask is an internal TCP/IP protocol stack variable that is used in IP protocol to identify the subnetwork for an IP address. The IP protocol performs a bit-wise AND on the IP address and the subnet mask. Each address segment represents one byte, where 255 converts to FF hex. This computation is used to find out if the controller and terminal are on different subnetworks. If the terminal is on a different IP subnetwork than the controller, then you must set the subnet mask and default router.

For example, if the terminal IP address is 192.9.150.184 and the subnet mask is 255.255.255.0, the terminal is on the subnetwork 192.9.150.0.

Using RF Communications on the Terminal

Once you have configured the devices in the 2.4 GHz network, you can begin using the TRAKKER 2425 terminal application to collect and transmit data via RF communications. Each terminal is shipped with only one of these applications:

- 3270 terminal emulation
- 5250 terminal emulation
- VT100/220/320 or ANSI terminal emulation
- 3270 or 5250 screen mapping

To use the terminal

- Press Ⓜ to turn on the terminal. One of these login or application screens appear. For screen mapping, you may also see the template menu if a template has been downloaded from the controller.

3270/5250 Sign On Screen

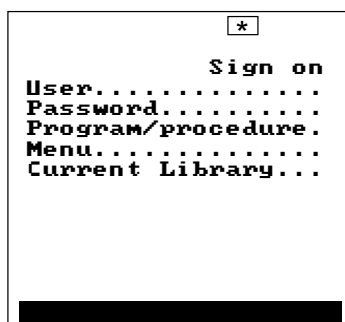

VTXXX/ANSI Login Screen

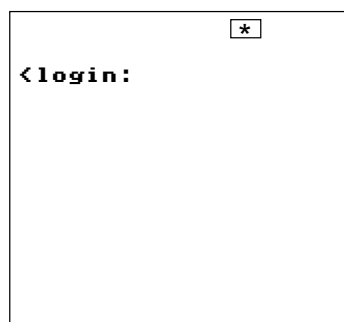

Screen Mapping Screen

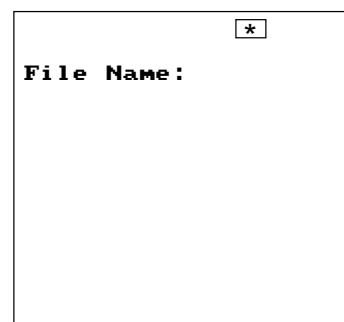

242XU.014

If the terminal is correctly configured and communicating with your host computer, the terminal will connect and begin running the default application. You can begin using the terminal to collect data. For help, see Chapter 5, “Running Applications.”



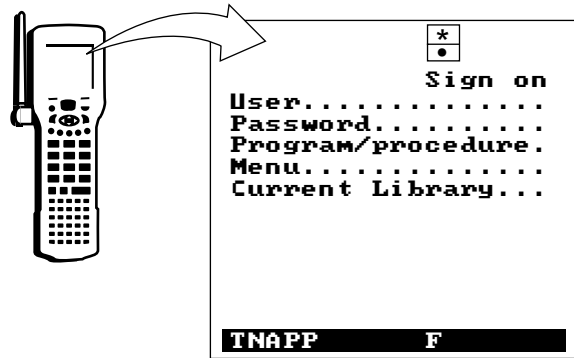

Using the Icons to Monitor Communications

As you use the TRAKKER 2425 terminal to collect data, icons are displayed to help you monitor RF and network communications on the terminal. Use the two icons shown in the illustration to monitor communications between the terminal and other devices in the 2.4 GHz network.



242XU.093

| You See These Icons | Status of Communications | What You Need to Do |
|--|--|---|
| <p>◆</p> <p>The Radio icon remains on.</p> | <p>No communications.</p> <p>The T2425 terminal is not connected to the 0100 Access Point. The Network Activate command is disabled, or there is a problem with the radio card and it is turned off.</p> | <p>You need to enable the Network Activate command. For help, see “Network Activate” in Chapter 8.</p> |
| <p>No icons appear.</p> | <p>No communications.</p> <p>The T2425 terminal is not connected to the 0100 Access Point.</p> | <p>Make sure the access point is turned on and operating. You may also be using the terminal out of the RF range of an access point. Try moving closer to an access point to re-establish communications.</p> <p>If the access point is on and you are in range, you may need to configure the terminal to communicate in the network. For help, see “Installing and Configuring the Terminal” earlier in this chapter.</p> |

| You See These Icons | Status of Communications | What You Need to Do |
|---|--|---|
|  The Connect icon blinks. | Partial communications. The T2425 terminal is trying to establish communications with the Model 200 Controller. | You may need to configure the terminal to communicate with the controller. For help, see “Installing and Configuring the Terminal” earlier in this chapter. If the terminal is configured, you may need to configure the controller. Make sure the terminal is configured correctly and enabled. Make sure the controller is turned on and data collection is started. |
|  The Connect icon remains on. | Normal communications. The T2425 terminal can communicate with the 0100 Access Point and the Model 200 Controller. | You can send and receive data between the terminal and the Model 200 Controller. |
|  The Connect icon remains on, and the Data icon blinks. | Normal communications. The T2425 terminal is sending data to or receiving data from the Model 200 Controller. | You can send and receive data between the terminal and the Model 200 Controller. <i>Note: You may not see the Data icon blink if communications are occurring instantaneously.</i> |
|  The Connect icon and Data icon remain on. | Normal communications. The T2425 terminal has received data for an application from the Model 200 Controller. The data is stored in the terminal’s radio buffer until the application is ready to process the data. | You can send and receive data between the terminal and the Model 200 Controller. |

Using the Terminal Between Access Points

The 0100 Access Point acts as a wireless bridge to provide communications between the TRAKKER 2425 terminal and the Ethernet network. You may have multiple access points in your 2.4 GHz network to provide uninterrupted wireless communication at any location within your facility.

To use the terminal between access points and continue sending and receiving data, you must follow these guidelines:

- The radio coverage of each access point must overlap to ensure that the roaming T2425 terminal will always have a connection available.
- You configure each access point with the same RF domain number and security ID.
- You configure the T2425 terminals with the same RF domain and security ID as the access points to which they may communicate.
- All access points that the T2425 terminals may communicate with and roam between must be installed in the same IP subnetwork. The T2425 terminal cannot roam between IP subnetworks.

Once the network is configured, you can collect data anywhere within range of the access points in the wireless network. When you move out of range of one access point, the terminal automatically polls the other access points in the same RF domain to continue the network connection.

If you are out of range of all access points in the network, the data is stored in the terminal's radio buffer. The Data icon appears on the display and the Connect icon starts flashing or turns off. You can continue to collect data until the radio buffer is full. When the buffer is full, the application displays a communication timeout status. When you move back into range and network communications are re-established, the data in the radio buffer is transmitted to the controller and you can once again transmit data.

Configuring the Terminal Over the Network

You can remotely configure the TRAKKER 2425 terminal by using one of these methods:

- Send a command from the Model 200 Controller.
- Send a command from an application on the host computer.

You cannot configure any of the network parameters, such as terminal IP address, over the network. Once the terminal is communicating, you can configure bar code symbologies and operating commands.

Note: You can configure the terminal locally by using the TRAKKER 2400 Menu System or by scanning a command from a Code 39 or Code 93 bar code label. For help, see Chapter 3, “Configuring the Terminal.”

Configuring the Terminal From the Controller

You can use the Model 200 Controller to configure one or more terminals in your 2.4 GHz network. You can also send reader commands such as Backlight On to one or more terminals.

This method is very fast and efficient if you need to change the same configuration parameters for several terminals in one area. For example, you may want to set the Beep Volume to very loud and turn on Keypad Caps Lock for all the terminals in one area.

Note: You can configure a terminal from the Model 200 Controller, but you cannot get configuration data from the terminal.

To send commands from the controller

1. Using the Download Server feature on the controller, select the terminal or group to which you want to download the configuration commands. For help on configuring a group of terminals, see the *Model 200 Controller System Manual*.

Note: You can continue running an application on the TRAKKER 2425 terminal while configuring the terminal from the controller.

2. Choose the option to enter a command.
3. Enter the reader or configuration command and choose Add. The command appears in the Files and Data box.

For example, enter this command to set the Beep Volume to very loud:

```
$+BV4
```

For a list of reader commands, see Chapter 7, "Reader Command Reference." For a list of configuration commands, see Chapter 8, "Configuration Command Reference."

Note: You can set the Postamble or Preamble command to use characters from the extended ASCII character set such as the Field Exit code for 5250 TE. For help, see "Auto-Advancing Through Fields on 5250 TE Screens" in Chapter 5.

4. Repeat Step 3 to add another reader or configuration command, or choose OK.
5. Choose Download to download the commands and change the runtime configuration of the terminals selected.

When you remotely configure the terminal, the commands change the terminal's runtime configuration. The configuration changes are not saved in flash memory. You must use the TRAKKER 2400 Menu System to save the configuration in flash memory. For help, see "Saving Configuration Changes in Flash Memory" in Chapter 3.

Configuring the Terminal From the Host Computer

You can use the host computer to configure one TRAKKER 2425 terminal in your 2.4 GHz network. For example, you may want to change the Beep Volume command and the Display Backlight Timeout command.

To send and receive configuration data, you need to write an application for the host computer that can communicate with the Model 200 Controller. For help, see the *Model 200 Controller Technical Reference Manual*. You use the Terminal Message Format (TMF) protocol in the 2.4 GHz network to send and receive transactions between the host application and the terminal.

When you remotely configure the terminal from a host application, the commands change the terminal's runtime configuration. The configuration changes are not saved in flash memory. You must use the TRAKKER 2400 Menu System to save the configuration in flash memory. For help, see "Saving Configuration Changes in Flash Memory" in Chapter 3.

Note: *You can continue running an application on the TRAKKER 2425 terminal while configuring the terminal from the host computer.*

To set up the Model 200 Controller

- Configure a destination name for the host application. Create a transaction ID, \$NGCFGRSP, that will be routed to this destination name. The controller uses the transaction ID to route responses from the terminal back to the host application. \$NGCFGRSP is a special transaction ID that the controller uses to forward configuration response data from a terminal.

All configuration responses will be routed with the \$NGCFGRSP transaction ID. The controller cannot keep track of multiple applications sending configuration commands. If you have two host applications sending configuration commands, they must both be configured to receive the \$NGCFGRSP transactions, and therefore both will receive all responses from all TRAKKER 2425 terminals.

To set up the host computer

- Verify that you can communicate with the Model 200 Controller.

To set up the application

- Prepare and write a host application that can communicate with the controller and send transactions to and receive transactions from the terminal in this format:

| | | |
|---------------------------|------------------|------------------------------|
| <i>transaction header</i> | <i>TMF field</i> | <i>configuration command</i> |
|---------------------------|------------------|------------------------------|

where:

transaction header is a 96-byte field containing the message number, date and time, source application ID, destinations application ID, transaction ID, and other information. You must set the system message (SYSSMSG) flag to E in the transaction header. For help, see the *Model 200 Controller Technical Reference Manual*.

TMF field is a 2-byte field containing one of these values:

| | |
|----|--|
| CG | Configuration Get request sent from the host application. |
| Cg | Configuration Get response sent from the terminal to the host. |

TMF field (continued)

| | |
|----|--|
| CS | Configuration Set request sent from the host application. |
| Cs | Configuration Set response sent from the terminal to the host. |

configuration command is the configuration command or commands you want to set on the terminal, or get the current value of from the terminal. For a list of configuration commands, see Chapter 8, "Configuration Command Reference."

Example 1

In the host application, you want to get the current values of three configuration commands from the terminal. Send this transaction from the host application:

```
CG$+NABVDF
```

Note: *The transaction header is not shown in this example.*

where:

- CG** is a TMF Configuration Get request.
- \$+** is the Change Configuration reader command.
- NA** is the Network Activate configuration command.
- BV** is the Beep Volume configuration command.
- DF** is the Display Backlight Timeout configuration command.

The terminal returns this transaction to the host application.

```
Cg$+NA1BV2DF60
```

where:

- Cg** is a TMF Configuration Get response.
- \$+** is the Change Configuration reader command.
- NA1** means the Network Activate configuration command is currently set to a value of 1, which means that the 2.4 GHz network is enabled.
- BV2** means the Beep Volume configuration command is currently set to a value of 2, which is a normal beep volume.
- DF60** means the Display Backlight Timeout configuration command is currently set to a value of 60 seconds.

Example 2

In the host application, you want to set the value for two configuration commands on the terminal. Send this transaction from the host application:

```
CS$+BV4DF30
```

Note: *The transaction header is not shown in this example.*

where:

- CS** is a TMF Configuration Set request.
- \$+** is the Change Configuration reader command.
- BV4** sets the Beep Volume configuration command to a value of 4, which is a very loud beep volume.
- DF30** sets the Display Backlight Timeout configuration command to a value of 30 seconds.

The terminal returns this transaction to the host application.

```
Cs$+BV4DF30
```

where:

- Cs** is a TMF Configuration Set response.
- \$+** is the Change Configuration reader command.
- BV4** means the Beep Volume configuration command has been changed to a value of 4, which is a very loud beep volume.
- DF30** means the Display Backlight Timeout configuration command has been changed to a value of 30 seconds.

About Network Connectivity and Protocols

The TRAKKER 2425 terminals are hand-held data collection terminals with network support. The T2425 terminal communicates with a host computer in the 2.4 GHz network through the Model 200 Controller across the Ethernet network. The 0100 Access Point acts as a bridge between the Ethernet network and the wireless 2.4 GHz network. The controller supports the terminals using Intermec's UDP Plus protocol.

The communications protocol stack for the TRAKKER 2425 terminal is fit to the Open Systems Interconnection (OSI) seven layer model. The illustration on the next page shows how the 2.4 GHz network maps into the OSI model.

The terminal applications including terminal emulation and screen mapping are on top of the protocol stack. Intermec provides a terminal communications API (application program interface) to interface to the protocol stack. The API provides a common interface to these Intermec value-added protocols:

- Terminal Message Format (TMF) is used to route data and network management messages between applications on the T2425 terminal and peer tasks on the controller or host computer.
- UDP Plus is an Intermec protocol built on top of User Datagram Protocol (UDP). It maximizes the performance of wireless (RF) and hardwired networks.
- Trivial File Transfer Protocol (TFTP) allows efficient file exchange between the T2425 terminal and the Model 200 Controller.
- Network management provides network access to the T2425 terminal configuration, status, and statistics. Network management uses the Terminal Message Format to receive and send messages.

The remaining layers in the protocol stack are a series of standard protocols that interface with the drivers and hardware needed to support the 2.4 GHz network.

TRAKKER 2425 Terminal Protocol Stack

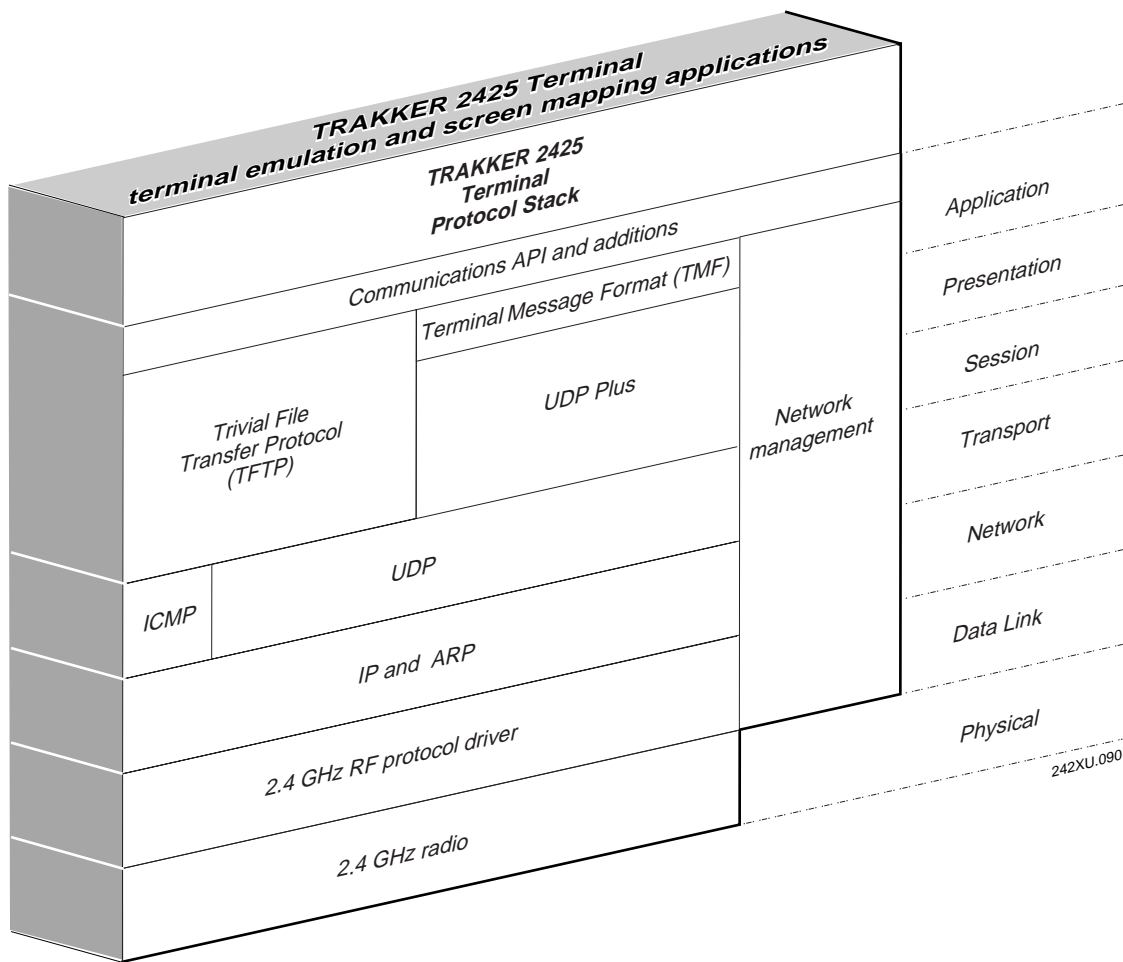

The TRAKKER 2425 terminal uses these protocols:

| Layer | Protocol | Description |
|------------------------------|----------------------------|--|
| Physical | 2.4 GHz radio | Provides spread spectrum radio signal control. |
| Data Link | 2.4 GHz RF protocol driver | Provides RF media access control. The default hardwired media access control (MAC) protocol used with TCP/IP supports the Ethernet II standard. |
| Network | IP and ARP | The Internet Protocol (IP) complies with the standard outlined in RFC 791. The Address Resolution Protocol (ARP) complies with the standard outlined in RFC 826. |
| Transport | UDP | The User Datagram Protocol (UDP) complies with the standard outlined in RFC 768. |
| | ICMP | The Internet Control Message Protocol (ICMP) complies with the standard outlined in RFC 792. |
| Session and Presentation | UDP Plus | UDP Plus is an Intermec proprietary session layer protocol built on the UDP protocol. The UDP Plus session layer provides these services: <ul style="list-style-type: none"> • guaranteed delivery • duplicated message removal • link connection and status management • network error recovery • congestion control • device error detection |
| | TFTP | Trivial File Transfer Protocol (TFTP) allows efficient file exchange between the terminal and the Model 200 Controller. TFTP complies with the standard outlined in RFC 1350. |
| Presentation and Application | TMF | Terminal Message Format is used to route data, configuration, and network management messages between applications on the T2425 terminal and peer tasks on the controller or host. |

5

Running Applications

This chapter provides information to configure and run applications on your TRAKKER 2425 hand-held terminal.

Learning About the Terminal Applications

Your TRAKKER 2425 terminal is configured and loaded with one of these applications:

- IBM 3270 terminal emulation (Telnet terminal type 3278-2)
- IBM 5250 terminal emulation (Telnet terminal type 3179-2)
- VT100/220/320 and ANSI terminal emulation
- 3270 or 5250 screen mapping

Terminal emulation (TE) and screen mapping run on the Intermec UDP Plus protocol that provides reliable data transfer between a host computer and the T2425 hand-held terminals.

TE allows the terminal to communicate through the Model 200 Controller to the host application as if it were directly connected to the host. The controller sends data to the terminal in a screen format that emulates the host session. You can use the viewporting capabilities on the terminal to view the host screen.

Screen mapping sends screen transactions from a terminal through the controller to a host application. On the controller, you create the terminal screens, group them into menus, and generate each menu into a terminal template that is downloaded to the terminal. Script files that you build on the controller allow the transaction fields from the terminal screens to be mapped to different host screen fields.

Starting Your Application

Make sure you have installed the terminal in your 2.4 GHz network. For help, see Chapter 1, "Getting Started." If you have already completed these tasks, you can start your application.

To start your application

1. Press the  key to turn on the terminal.
2. Wait a few seconds while the display clears and the application starts.

Once the display on the T2425 shows the sign on screen, you are ready to use your terminal. For screen mapping, you may also see the template menu if a template has been downloaded from the controller.

3270/5250 Sign On Screen

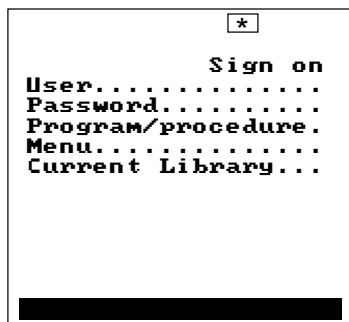

VTXXX/ANSI Login Screen

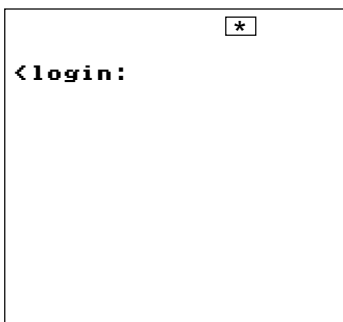

Screen Mapping Screen



242XU.014

Note: If your application does not start after a few seconds, you may not have configured the T2425 correctly. For help, see Chapter 1, "Getting Started."

Now that you have started your application, you need to learn how to use it. For help, turn to these sections:

- "Using 3270 and 5250 Terminal Emulation," on page 5-5.
- "Using VT100/220/320 or ANSI Terminal Emulation," on page 5-16.
- "Using 3270 and 5250 Screen Mapping," on page 5-26.

Using 3270 and 5250 Terminal Emulation

Your TRAKKER 2425 terminal contains a special keypad and firmware that provide most of the commands available to emulate an IBM 3270 or 5250 terminal.

You can use your T2425 terminal to:

- view host terminal screens on your T2425 display.
- enter data into the screens using the scan module or keypad.
- access host commands and perform host functions.
- automatically transmit the data to the host.

After you have installed the terminal in your system, you need to learn how to configure and use the terminal emulation application. The next sections cover these topics:

- Using the 3270 or 5250 keypad
- Configuring 3270 or 5250 TE parameters
- Understanding status line messages

Using the 3270 or 5250 Keypad

The TRAKKER 2425 terminal comes with a special keypad that contains most of the keys available on your 3270 or 5250 terminal keyboard.

Use the T2425 keypad to enter data in the TE screens. As on all terminal keyboards, the keys on the T2425 keypad have their main character or function marked directly on the key itself. To access that character or function, just press the key.

Your T2425 keypad provides access to TE commands and functions printed above the keys by pressing key combinations. Use the Function Left ($\square_{=f}$), Function Right ($\square_{=f}$), Shift (\square_{\uparrow}), and Control (\square_{\triangle}) keys to access those characters or functions that do not have an actual key on the keypad. Use this illustration to understand how the keypad works:

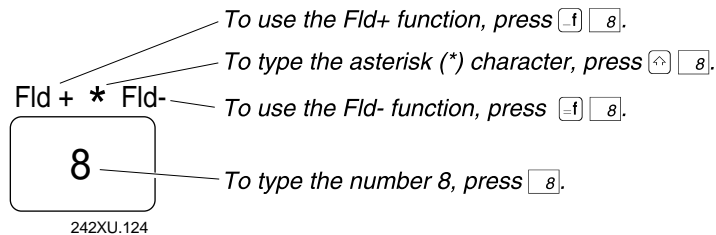

For help on how the keypad works, see "Using the Keypad" in Chapter 2.

Using the 3270 or 5250 Keypad

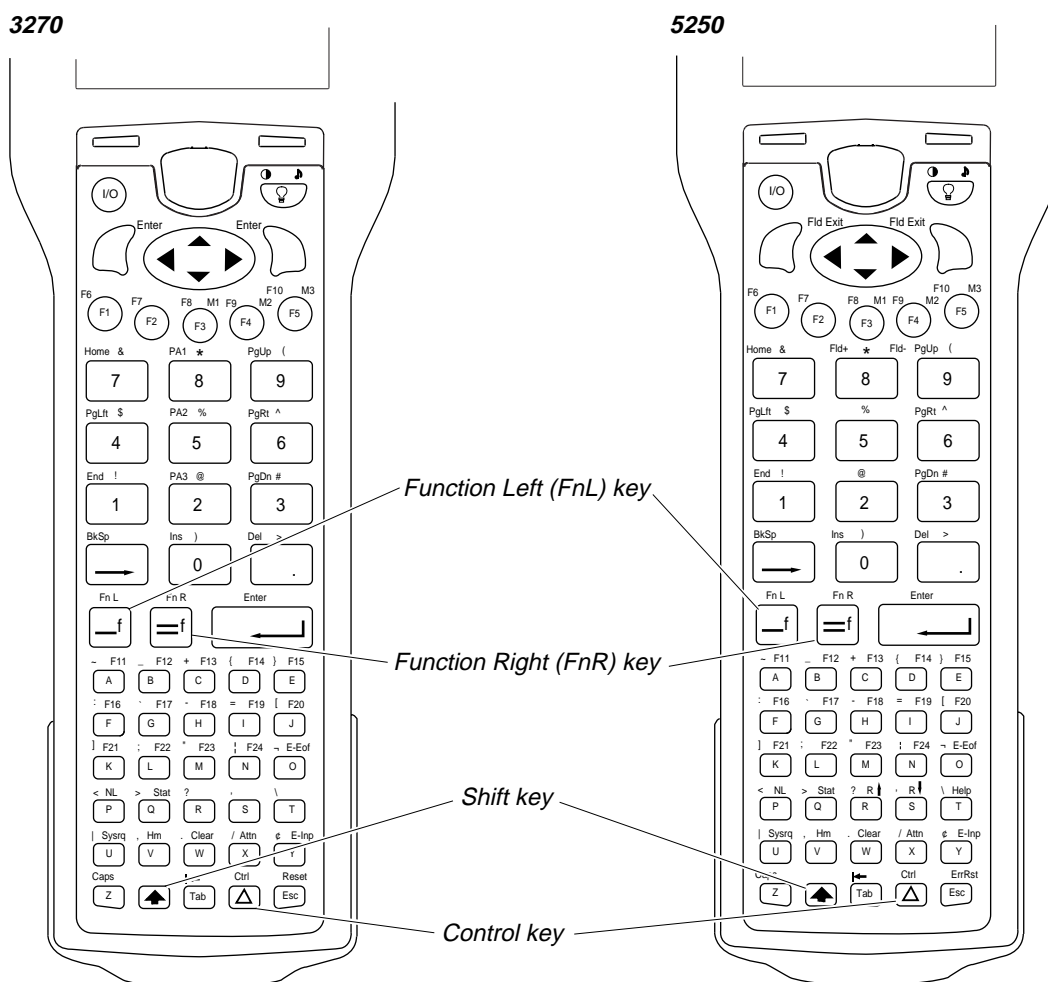

242XU.015

Configuring 3270 or 5250 TE Parameters

You can configure several parameters for 3270 and 5250 terminal emulation on the TRAKKER 2425 terminal. These are the TE parameters you can configure:

- Terminal
- Communications
- Viewport

Configuring Terminal Emulation Screens and Options

You can access the TE Configuration menu at any time during your terminal emulation session. Use this procedure to configure your 3270 or 5250 terminal emulation program.

To configure 3270 or 5250 TE options

1. Press **[F]** **(F1)** to access the Terminal Emulation menu. The Terminal Emulation menu appears.

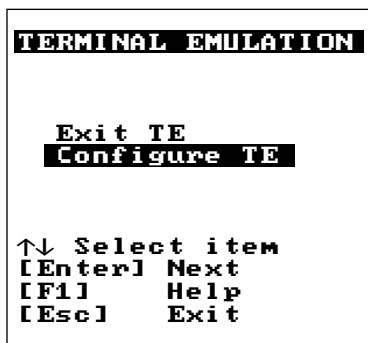

242XU.018

Note: Do not choose the Exit TE option, which exits the terminal emulation application. If you do accidentally exit TE, a warning screen appears and you will be prompted to return to the TE Configuration menu.

2. Choose Configure TE and press . The TE Configuration menu appears.

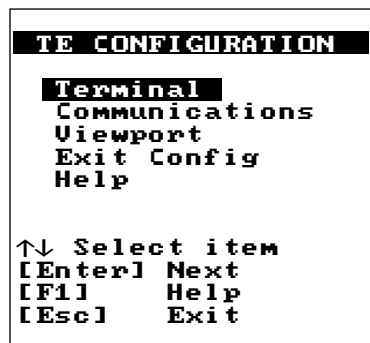

242XU.019

3. Press **▲** or **▼** to highlight the function you want to configure and press . To exit, see “Exiting the TE Configuration Menu” later in this chapter.

The Terminal screen contains this option:



242XU.020

Text Size Selects the size of text the T2425 terminal displays on the terminal screen. Options are regular height (normal characters) and double height (double high text).

The Communications screen contains this option:



242XU.021

Host Name Enter the name of the host to which you want the terminal to connect. You can enter a host name that is up to 13 characters long.

***Note:** If you have linked a terminal with a host name on the Model 200 Controller, you do not need to enter a host name in this screen. If you have not linked a terminal with a host name on the controller, you must enter a host name for this parameter. The host name in this screen must match a host name in the list of available hosts defined on the controller.*

The Viewport screen contains these options



242XU.022

Viewport Mode Select one of these viewport movement modes:

- Follow** Enables viewport Follow Cursor mode.
- Center** Enables viewport Center mode. The viewport always centers around the cursor.
- Disable** Disables viewport movement. You must manually move the cursor to each field in the screen.

You can set these parameters for Follow Cursor mode only:

Side Boundary The viewport moves when the cursor is this number of characters from the right or left side boundary. You can enter a number from 1 to 10.

Side Jump The number of characters the viewport moves right or left when you reach a horizontal boundary. You can enter a number from 1 to 10.

Vertical Boundary The viewport moves when the cursor is this number of characters from the top or bottom boundary. You can enter a number from 1 to 10.

Vertical Jump The number of characters the terminal moves up or down when you reach a vertical boundary. You can enter a number from 1 to 10.

Exiting the TE Configuration Menu

After entering all configuration parameters, you are prompted to save the new configuration and exit the Configuration menu. You can choose between several options when prompted to save the new configuration.

To exit the TE Configuration menu

1. From the TE Configuration menu, choose Exit Config and press . The Save new configuration screen appears.



242XU.023

2. Choose Yes and press if you want to save the TE configuration. Your terminal saves the configuration options to flash memory and the sign on screen appears.

Choose No and press if you do not want to save the TE configuration. You exit the TE Configuration menu and the sign on screen appears.

Choose Cancel and press to return to the TE Configuration menu. You can continue making changes to the TE configuration

Understanding Status Line Messages

TRAKKER 2425 terminals provide a status line when configured as 3270 or 5250 terminals. You will see the status messages on the status line or bottom line of the terminal display. The status messages report the operating status of both the T2425 terminal and the host system.

Use **[=f]** **[Q]** to toggle the status line on and off, or scan this bar code:

Status



%STAT

You will see screens similar to these:

TE Session Established

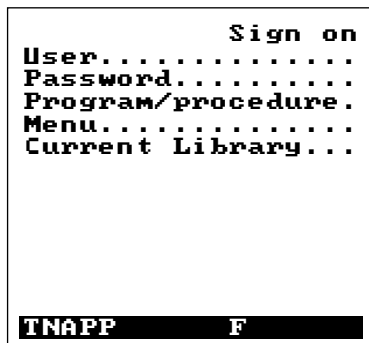

Host Processing Data

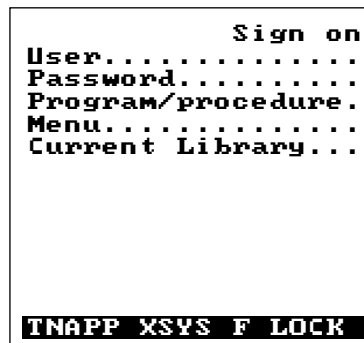

242XU.024

This table summarizes information you may see in the status line.

| Status Line Message | Description |
|---------------------|---|
| blank | No activity, ready for operator input. |
| ERR (5250 only) | The terminal operator pressed an AID key to transmit data to the host. The host did not accept the data and transmitted a Write Error command to the TE application indicating the field where the error occurred. Use the viewport to view the error message and corrective procedure. Press ErrRst to clear this message. |

Status Line Messages (continued)

| Status Line Message | Description |
|------------------------|--|
| INIT | Terminal is attempting to connect to the server. |
| INS | Terminal is in Insert mode. |
| LOCK | Keypad is locked by the host application. |
| MSGWAIT (5250 only) | A system message is waiting to be read. |
| PEND | The terminal is connected to the server and is waiting for an active host session. |
| TNAPP | Terminal is in session with a host application. |
| TNSVR | Terminal is connected to the server. |
| F, C, or D | Current Viewport mode of the T2425 terminal. One of these characters is displayed to indicate the Viewport mode status: F Viewport Follow mode is enabled C Viewport Center mode is enabled D Viewport movement is disabled |
| XSYS | Keypad is disabled and the TE application is waiting for a host response. |

Auto-Advancing Through Fields on 5250 TE Screens

You can set up your TRAKKER 2425 terminal so that when a user scans data into a field on a 5250 TE screen, a Field Exit command clears the rest of the field, advances to the next field, and triggers an auto-enter field to send an ENTER to the application and submit the data. The user can just scan data and never has to touch the keypad.

To set this up, you need to set the Postamble command to the 5250 Field Exit code. However, you cannot use the TRAKKER 2400 Menu System nor scan the value using the Postamble configuration command. These two configuration methods currently do not support the extended ASCII character set, which includes the ASCII equivalents for special 5250 keys such as Field Exit. However, the terminal does support the extended ASCII character set.

You must configure the postamble to the Field Exit's literal value using the download server on the Model 200 Controller. You can use the download server on the controller to configure one or more terminals in the network.

To configure and use Field Exit as a postamble

1. In the download server on the controller, select the terminal or group to which you want to download the Postamble (AE) configuration command. For help on configuring a group of terminals, see the *Model 200 Controller System Manual*.

Note: You can continue running the 5250 TE application on the T2425 while configuration a terminal from the controller.

2. Choose the option to enter a command.
3. Type the string \$+AE and then enter the ASCII code 154 by holding down the Alt key while typing 154 on the numeric keypad. You should see an Ü (umlaut) to represent the literal Field Exit code in the edit box, which now shows this command and value:

```
$+AEÜ
```

4. Choose Download to download the commands and change the runtime configuration of the terminals selected.

When you configure the terminal from the controller, the configuration changes are saved in RAM, but not in flash memory. You must use the TRAKKER 2400 Menu System to save the configuration in flash memory. For help, see "Saving Configuration Changes in Flash Memory" in Chapter 3.

You can set the postamble or preamble to any character from the extended ASCII character set using these instructions. Find the literal ASCII value and type that value in Step 3 instead of the Field Exit code. To set the preamble, use the syntax \$+AD instead of \$+AE.

Using VT100/220/320 or ANSI Terminal Emulation

Your TRAKKER 2425 terminal contains a special keypad and firmware that provide most of the commands available to emulate a VT100/220/320 or ANSI terminal.

You can use your T2425 terminal to:

- emulate VT100/220/320 and ANSI keyboards by using the scan module or the keypad.
- run host applications using the VT100/220/320 or ANSI terminal emulation features.

After you have installed the terminal in your system, you need to learn how to configure and use the terminal emulation application. The next sections cover these topics:

- Using the VTXXX/ANSI keypad
- Configuring VTXXX/ANSI TE parameters

Using the VTXXX/ANSI Keypad

The TRAKKER 2425 TE terminal comes with a special keypad that contains most of the keys available on your VT100/220/320 keyboard.

Use the T2425 keypad to enter data in the TE screens. As on all terminal keyboards, the keys on the T2425 keypad have their main character or function marked directly on the key itself. To access that character or function, just press the key.

Your TRAKKER 2425 terminal keypad provides access to TE commands and functions printed above the keys by pressing key combinations. Use the Function Left ($\boxed{=f}$), Function Right ($\boxed{=f}$), and Shift ($\boxed{\uparrow}$) keys to access those characters or functions that do not have an actual key on the keypad. Use this illustration to understand how the keypad works:

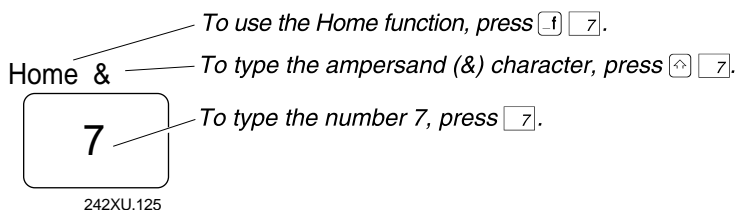

For help on how the keypad works, see “Using the Keypad” in Chapter 2.

Use this table to locate the VT220/320 editing key functions on the TRAKKER 2425 keypad.

| VT220/320 Editing Key | TRAKKER 2425 Key |
|-----------------------|--|
| Find | $\boxed{=f}$ \boxed{K} |
| Insert | $\boxed{=f}$ \boxed{L} or $\boxed{=f}$ \boxed{O} |
| Remove | $\boxed{=f}$ \boxed{M} |
| Select | $\boxed{=f}$ \boxed{P} |
| Previous screen | $\boxed{=f}$ \boxed{Q} |
| Next screen | $\boxed{=f}$ \boxed{R} |

TRAKKER Antares 2425 Hand-Held Terminal User's Manual

Using the VTXXX/ANSI Keypad

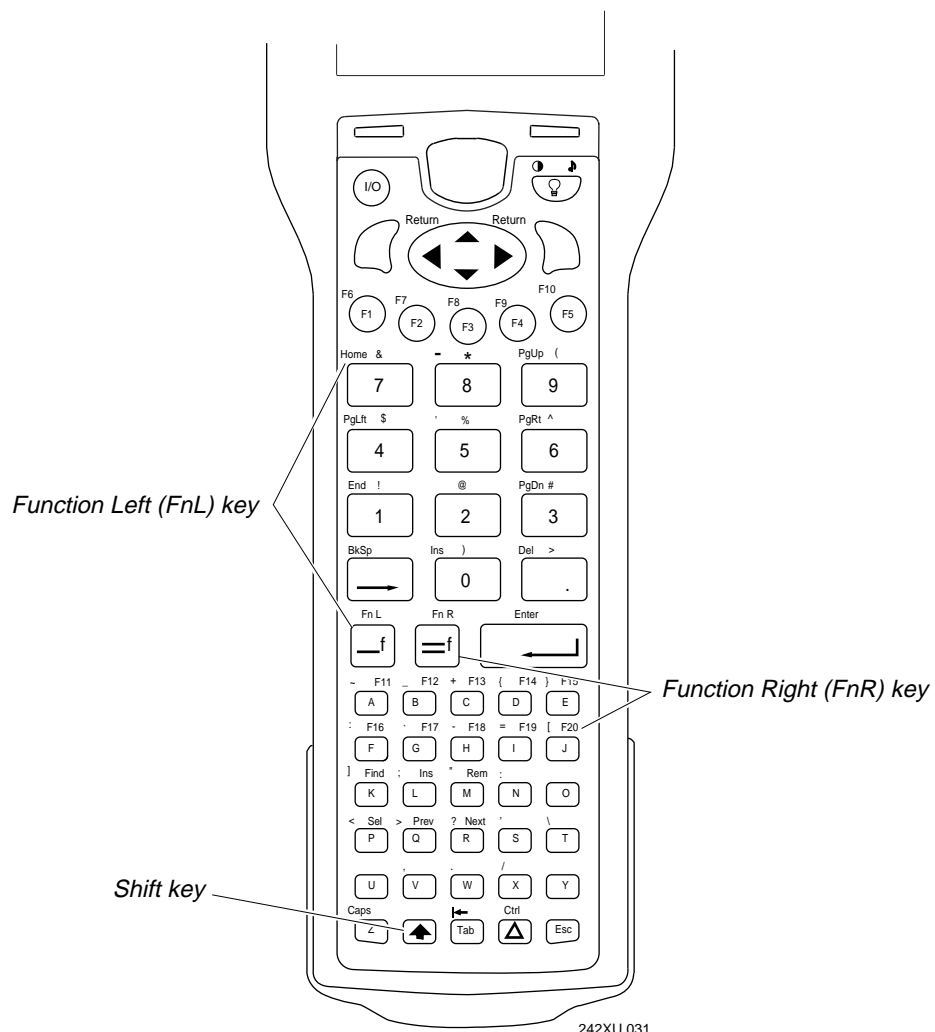

Configuring VTXXX/ANSI TE Parameters

You can configure several parameters for VTXXX/ANSI terminal emulation on the TRAKKER 2425 terminal. These are the TE parameters you can configure:

- Terminal
- Communications
- Viewport

Configuring Terminal Emulation Screens and Options

You can access the TE Configuration menu at any time during your terminal emulation session. Use this procedure to configure your VTXXX/ANSI terminal emulation program.

To configure VTXXX/ANSI TE options

1. Press **[F]** **(F1)** to access the TE Configuration menu. The Terminal Emulation menu appears.

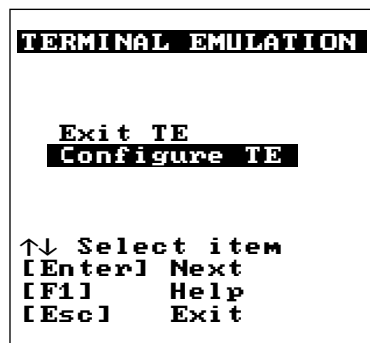



242XU.018

Note: Do not choose the Exit TE option, which exits the terminal emulation application. If you do accidentally exit TE, a warning screen appears and you will be prompted to return to the TE Configuration menu.

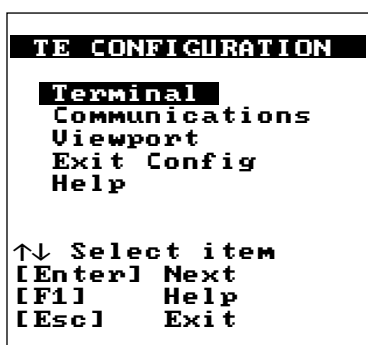
2. Choose Configure TE and press . The TE Configuration menu appears.



242XU.019

3. Press  or  to highlight the function you want to configure and press . To exit, see “Exiting the TE Configuration Menu” later in this chapter.

The Terminal screen contains these options:

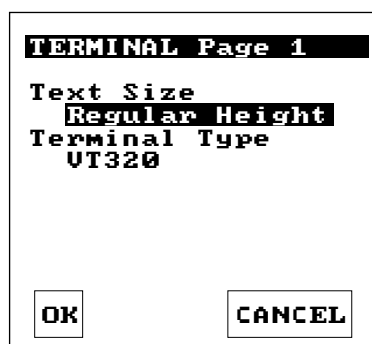

242XU.026

Text Size Select the size of text the T2425 displays on the terminal screen. Options are regular height (normal characters) or double height.

Terminal Type Select the terminal type of the host system. The supported terminal types are: VT100, VT220, VT320, RDRANSI and ANSI.

Note: If you select ANSI, RDRANSI, or VT100 as the terminal type, you will only see part of the options available on page two of the Terminal screens.

VT220 and VT320 Screen

```

TERMINAL Page 2
Terminal Mode
  VT320 7-Bit
User-Defined Key
  Unlock
Keypad Mode
  Numeric
Cursor Mode
  Cursor

```

ANSI and VT100 Screen

```

TERMINAL Page 2

Keypad Mode
  Numeric
Cursor Mode
  Cursor

```

242XU.027

Terminal Mode (VT220/320 only) Select the Terminal mode that corresponds to your terminal type. This field sets the mode VT-series terminals use to exchange escape sequences, control commands, and status reports with an application.

User-Defined Key (VT220/320 only) Select whether you want this parameter set to lock or unlock. When you select lock, you cannot reprogram user-defined keys. When you select unlock, you can program user-defined keys from the host application.

Keypad Mode Select Numeric or Application mode. These options generate different key codes.

If you select Numeric mode, you generate ANSI cursor control ESC sequences that correspond to what appears on the face of the keys.

If you select Application mode, you generate application ESC sequences for the key code. For help, see your VT manual.

Cursor Mode Select Cursor or Application mode. These two options generate different key codes.

If you select Cursor mode, you generate ANSI cursor control ESC sequences that correspond to what appears on the face of the cursor key.

If you select Application mode, you generate application ESC sequences for the key code. For help, see your VT manual.

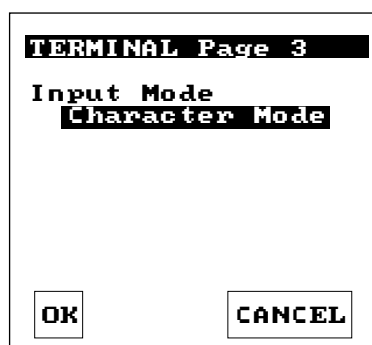

242XU.028

Input Mode Select Line mode or Character mode.

If you select Line mode, you can enter a line of characters on your T2425 terminal before transmitting data to the host. Press  to send each line of text to the host. In Line mode, communications overhead is reduced because input is sent one line at a time instead of one or a few characters at a time.

If you select Character mode, keypad input is immediately sent to the host.

The Communications screen contains this option:



242XU.032

Host Name Enter the name of the host to which you want the terminal to connect. You can enter a host name that is up to 13 characters long.

Note: If you have linked a terminal with a host name on the Model 200 Controller, you do not need to enter a host name in this screen. If you have not linked a terminal with a host name on the controller, you must enter a host name for this parameter. The host name in this screen must match a host name in the list of available hosts defined on the controller.

The Viewport screen contains these options:

```

VIEWPORT
Viewport Mode
Follow
Side Boundary
1
Side Jump
10
Vertical Boundary
1
Vertical Jump
8
OK          CANCEL
  
```

242XU.022

Viewport Mode Select one of these viewport movement modes:

- Follow** Enables viewport Follow Cursor mode.
- Center** Enables viewport Center mode. The viewport always centers around the cursor.
- Disable** Disables viewport movement. You must manually move the cursor to each field in the screen.

You can set these parameters for Follow Cursor mode only:

Side Boundary The viewport moves when the cursor is this number of characters from the right or left side boundary. You can enter a number from 1 to 10.

Side Jump The number of characters the viewport moves right or left when you reach a horizontal boundary. You can enter a number from 1 to 10.

Vertical Boundary The viewport moves when the cursor is this number of characters from the top or bottom boundary. You can enter a number from 1 to 10.

Vertical Jump The number of characters the terminal moves up or down when you reach a vertical boundary. You can enter a number from 1 to 10.

Exiting the TE Configuration Menu

After entering all configuration parameters, you are prompted to save the new configuration and exit the Configuration Menu. You can choose between several options when prompted to save the new configuration.

To exit the Configuration menu

1. From the TE Configuration menu, choose Exit Config and press . The Save new configuration screen appears.

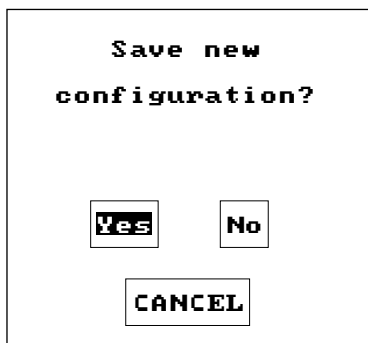

242XU.023

2. Choose Yes and press if you want to save the TE configuration. Your terminal saves the configuration options to flash memory and the sign on screen appears.

Choose No and press if you do not want to save the TE configuration. You exit the TE Configuration menu and the sign on screen appears.

Choose Cancel and press to return to the TE Configuration menu. You can continue making changes to the TE configuration.

Unsupported TE Functions

These functions are not supported for the current terminal emulation firmware version.

| Terminal Type | Unsupported Functions |
|------------------------|---|
| 3270 and 5250 | <p>3270 SFE (Start Field Extended) Order and Write Structured Field commands.</p> <p>5250 PRINT (X'F6) AID.</p> <p>5250 transparent data.</p> <p>5250 Write Control Character (WCC) supports error line adjustment field only.</p> <p>5250 write error code to window and write single structured field.</p> <p>5250 extended attributes.</p> <p>5250 I/O Feature Input Field accepts any character from all sources of input.</p> <p>AutoTab, Autorepeat, and Macro functions.</p> <p>Telnet 3270 Regime option (RfC1041).</p> |
| VT100/220/320 and ANSI | <p>VT100 does not support these edit keys: home, insert, delete, page up, and page down.</p> <p>VT52 mode, Column mode, Reverse Screen mode, and Interlace mode.</p> <p>Double height and double width characters.</p> <p>Programmable LEDs.</p> <p>Screen alignment test and self-tests.</p> <p>Report terminal parameters command. The terminal does not send a response.</p> <p>Identify terminal function.</p> <p>Select character protection attribute.</p> <p>National replacement and downloadable character sets.</p> <p>Autorepeat mode.</p> |
| All Types | Printing is not supported. |

Using 3270 and 5250 Screen Mapping

Make sure you have installed the terminal in your 2.4 GHz network. For help, see Chapter 1, "Getting Started." Before you can run screen mapping on your terminal, you need to generate a terminal template and script file on the Model 200 Controller. For help, see the *Model 200 Controller System Manual*. If you have already completed these tasks, you can start your screen mapping application.

Starting the Screen Mapping Application

There are two ways to load a template on the T2425 terminal:

- You can download the template to the T2425 terminal from the controller. For help, see the *Model 200 Controller System Manual*.
- You can have the terminal request a template from the controller.

To request a template from the controller

1. Press the  key to turn on the terminal. The T2425 terminal display prompts you to enter the name of the template you want to use:



242XU.060

2. Type a template name and press . The terminal displays your template menu.

Note: Make sure your template name has a .TPL file extension.

Running Screen Mapping on Your Terminal

Once you have selected a template, you need to select the screen where you want to enter data.

To enter data into a screen

1. From the template menu, use the ▲ or ▼ keys to highlight the screen you want to use.



242XU.061

2. Press **F2** to choose the screen. The screen you chose appears on the terminal display and the screen name is in the title bar.
3. Type or scan data into the fields. Use the ▲, ▼, or **↵** to accept the data for each field.
4. When you finish entering data into the fields:
 - Press **F1** to send the transaction to the controller.
 - Press **F8** to reset the screen and reposition the cursor to the first input field without sending the data.
 - Press **F6** to exit the screen without sending the data and return to the template screen menu.

Requesting a New Template

You can run one terminal template at a time on the TRAKKER 2425 terminal. If you want to change templates, you need to request a new one from the Model 200 Controller.

To request a new template from the controller

1. From the template screen menu, press **F4** to download a new template.
2. Type the name of the template you want to use when the screen prompts you to enter a file name.

Note: Make sure your template name has a *.TPL* file extension.

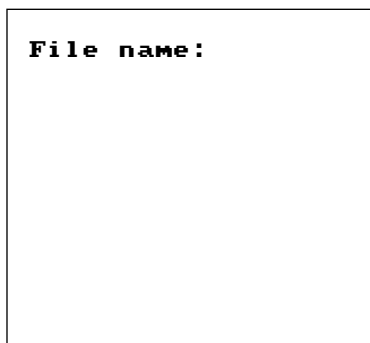
A rectangular box representing a terminal screen. Inside the box, the text "File name:" is displayed in a monospaced font. The rest of the box is empty, representing the input area for the file name.

242XU.060

3. Press **↵**. The new template menu appears on your terminal.

Loading a Validation File

Use a validation file to ensure that the information you enter in the input fields of your terminal screen is correct. There are two ways to load a validation file on the T2425 terminal:

- You can download the validation file to the T2425 terminal from the Model 200 Controller. For help, see the *Model 200 Controller System Manual*.
- You can have the T2425 terminal request a validation file from the Model 200 Controller.

To request a validation file from the controller

1. From the template screen menu, press F4 to download a new file.
2. Type the name of the validation file you want to use when the screen prompts you to enter a file name.

Note: Make sure that your filename contains a valid file extension. The filename cannot have the *.TPL* extension or the screen mapping application will try to load the validation file as a template.

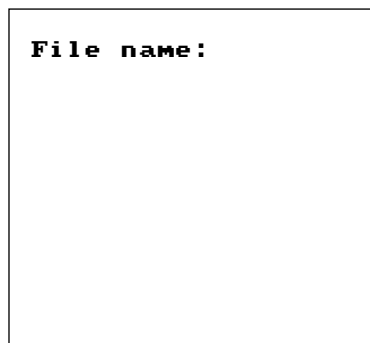

A screenshot of a terminal window with a black background and white text. The text reads "File name:" followed by a large empty space for input. The text is in a monospaced font.

242XU.060

3. Press Enter to download the validation file from the controller.

Using the Viewport

When you start your application, you see all or part of a host screen on the TRAKKER 2425 terminal display. This section describes how you view other parts of the host screen on the terminal display.

The 16 x 20 display screen of the T2425 terminal only shows part of each 25 x 80 screen that appears on a standard terminal screen. You can use the T2425 display as a viewport to access the full screen by using the paging keys described in this section.

Note: *There are several display exceptions for non-EBCDIC keypad characters when you are working in TE mode. Brackets [] display as parentheses (.). The ^ character cannot be used in TE mode.*

How the Viewport Works

The viewport lets you view screens and enter data by showing the part of the screen you are using. When you need to view part of a screen that does not appear on the display, you can move the viewport to show that part of the screen. The viewport acts as a window to the larger screen and it behaves as if it were “moving” across the screen.

There are two ways to move the viewport:

- Manually
- Automatically

To manually move the viewport, you use the viewport cursor keys and paging keys. In 5250 TE, you can also use the roll up or roll down keys. To automatically move the viewport, you use a 3270, 5250, or VTXXX/ANSI TE application and configure the Viewport mode. Even if the viewport automatically follows or centers the cursor in a TE screen, you can still manually move the viewport around the 25 x 80 TE screen to see other information.

Note: *To scan the bar code labels in this section, you must configure the terminal to use Code 39 in Full ASCII mode. For help, see “Code 39” in Chapter 8.*

Using the Viewport

16 x 20 terminal display

Full 25 x 80 screen

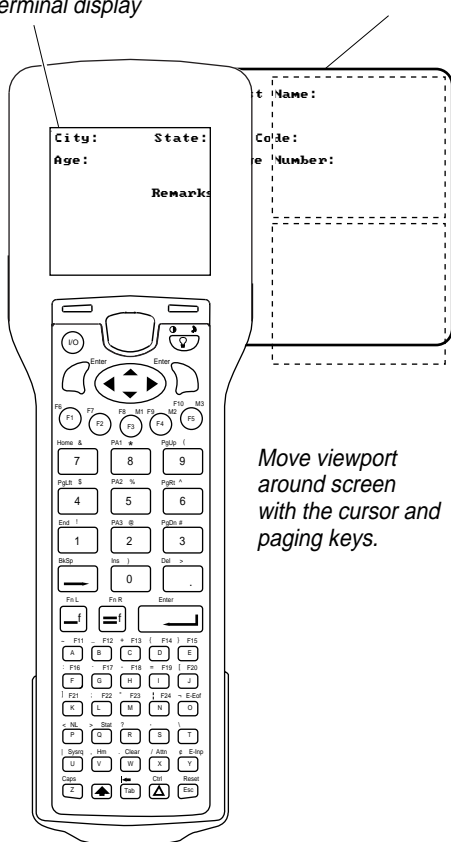

Move viewport around screen with the cursor and paging keys.

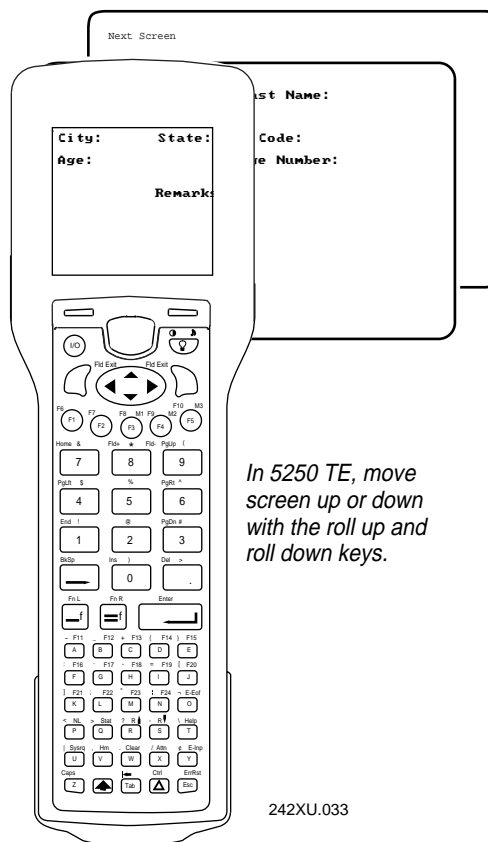

In 5250 TE, move screen up or down with the roll up and roll down keys.

242XU.033

Use the next sections to learn how to use these keys to move the viewport:



- Cursor keys
- Paging keys
- Roll keys (5250 only)

Using the Cursor Keys

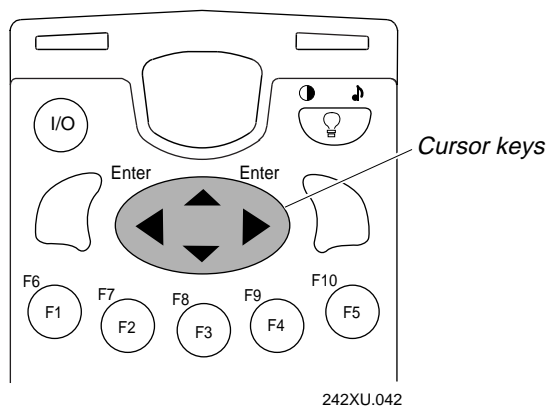
Use the cursor keys to move the cursor around the TE screen when you are running a program or entering data.



You can also use the cursor keys to move the viewport when you need to see the next line or column in a TE screen. When you move the viewport, the cursor does not move. Viewport commands are only sent to the terminal, not the host computer.

| To Enter | Press These Keys | Or Scan This Bar Code | Description |
|----------------|---|--|--|
| Viewport up |  |  *%UP* | Moves the viewport up one line or row. |
| Viewport down |  |  *%DN* | Moves the viewport down one line or row. |
| Viewport right |  |  *%RT* | Moves the viewport one character to the right. |
| Viewport left |  |  *%LF* | Moves the viewport one character to the left. |

Using the Paging Keys

You can use paging keys to move around a TE screen on the TRAKKER 2425 terminal. Paging keys move the terminal display to the next adjacent area or page on the TE screen. A page is 16 lines by 20 characters. These paging keys move the display as a viewport within the host TE screen; the screen itself does not advance or scroll.

The paging keys let you view the rest of the TE screen without entering data. When you page, you move only the viewport, not the cursor, and the cursor may disappear from the display. For help on the paging keys, see Chapter 9, “3270 and 5250 TE Command Reference,” or Chapter 10, “VT100/220/320 and ANSI TE Command Reference.”

3270 Example

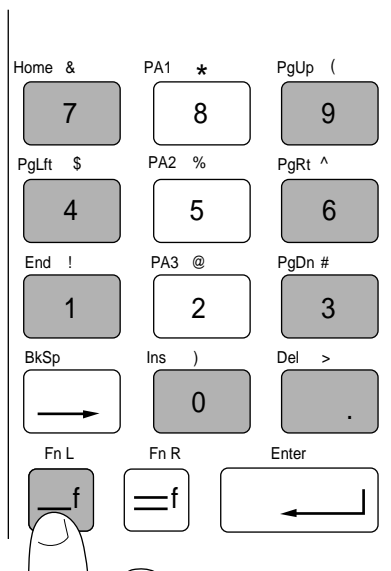

242XU.043

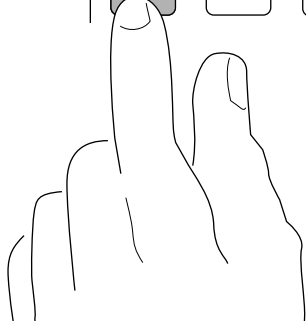

TRAKKER Antares 2425 Hand-Held Terminal User's Manual

| To Enter | Press These Keys | Or Scan This Bar Code | Description |
|------------|------------------|-----------------------|--|
| Home | | *%HOME* | Moves the viewport to the top left corner of the TE screen. |
| End | | *%END* | Moves the viewport to the end of the last line displayed on the TE screen. |
| Page up | | *%PGUP* | Moves the viewport up one page. |
| Page down | | *%PGDN* | Moves the viewport down one page. |
| Page right | | *%PGRT* | Moves the viewport right one page. |
| Page left | | *%PGLT* | Moves the viewport left one page. |
| Insert | | *%INS* | Each character you type is inserted after the cursor until you exit Insert mode by pressing again. Normally, you type text in Overwrite mode. Characters are typed over the existing characters on the screen. |
| Delete | | *%DEL* | Deletes or erases the character displayed above the cursor. |

Using the Roll Keys (5250 Only)

If you are running the 5250 TE application on the terminal, you can use the roll keys to request and display additional host screens.

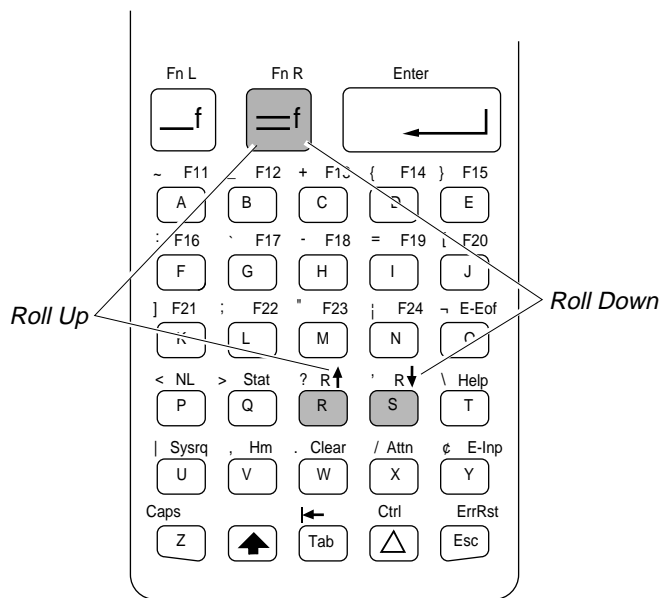

242XU.044

| To Enter | Press These Keys | Or Scan This Bar Code | Description |
|-----------|------------------|-----------------------|--|
| Roll up | | *%ROUP* | Causes the host to send down additional screens above what appears on the user screen. |
| Roll down | | *%RODN* | Causes the host to send down additional screens below what appears on the user screen. |

5250 terminals support the Roll command (Hex 23) received from a host application. Using this command, a host application can roll an area of the screen up or down. The direction of the roll and number of lines to roll are specified in the command.

The Roll command should not be confused with the Roll Up and Roll Down keys. The Roll keys cause the host to send down additional screens when you are at a Roll screen. A Roll screen typically has text in the lower right hand corner of the display indicating there are additional screens to view. For example, the text "More..." or "+" in the lower right hand corner of the display indicates that you can press a Roll Up key to view additional information.

- A Roll command received from a host application moves the screen, but not the viewport. You can see the screen scroll through the viewport when you roll up or down, but the viewport itself remains stationary.
- Paging keys (viewport page up, viewport page down, viewport page right, viewport page left) are used to move the viewport within one screen; they do not move the screen itself.

For help on the Roll keys and paging keys, see Chapter 9, "3270 and 5250 TE Command Reference." For help on the Roll command, see the *IBM 5494 Remote Control Unit Functions Reference*.

6

Troubleshooting

This chapter lists the problems you may have while using the terminal and gives some possible solutions. You will also find instructions that explain how to replace the antenna, clean parts of the terminal, and run diagnostic tests.

How to Use This Chapter

If you have any problems with the TRAKKER 2425 terminal, use this table as a guide to find the problem and solution in this chapter:

| Problem | See This Section to Find a Solution | Page |
|--|---|-------------|
| Display is blank | “Terminal Will Not Turn On” | 6-5 |
| Terminal locked up Message displayed | “Problems While Operating the Terminal” | 6-6 |
| Configuring the terminal | “Problems While Configuring the Terminal” | 6-10 |
| Communications error | “Terminal Will Not Communicate With Network Devices” | 6-13 |
| TE application error | “Problems Using Terminal Emulation Applications” | 6-15 |
| Screen mapping application error | “Problems Using the Screen Mapping Application” | 6-18 |
| Scanning labels | “Bar Code Labels Will Not Scan” | 6-23 |
| Battery management | “Guidelines for Managing Batteries” | 6-26 |
| Boot Menu appears or terminal locked up | “Booting and Resetting the Terminal” | 6-28 |
| Antenna is damaged | “Maintaining and Cleaning the Terminal” | 6-31 |
| Diagnostics and troubleshooting | “Running Diagnostics” | 6-35 |

Finding and Solving Problems

If you have a problem while configuring or using the terminal, use the tables in this section to find a solution. For easy reference, problems are grouped into these topics:

- Terminal Will Not Turn On
- Problems While Operating the Terminal
- Problems While Configuring the Terminal
- Terminal Will Not Communicate With Network Devices
- Problems Using Terminal Emulation Applications
- Problems Using the Screen Mapping Application
- Bar Code Labels Will Not Scan
- Guidelines for Managing Batteries



Caution

There are no user-serviceable parts inside the terminal. Opening the unit will void the warranty and may cause damage to the internal components.

Conseil

La terminal ne contient pas de pièces révisibles par l'utilisateur. Le fait d'ouvrir l'unité annule la garantie et peut endommager les pièces internes.

If you send the terminal in for service, it is your responsibility to save the terminal data and configuration. Intermec is responsible only for ensuring that the keypad and other hardware features match the original configuration when repairing or replacing your terminal.

Terminal Will Not Turn On

If you press  to turn on the TRAKKER 2425 terminal and nothing happens, check the terminal for these possible problems. For more help, see Chapter 1, “Getting Started.”

Problem

A scan module is not installed.

A main battery pack is not installed.
You see the Battery icon on the top line of the display.

The main battery pack is not charged.
You see the Battery icon on the top line of the display.

Solution

Make sure a scan module is installed correctly. You must install either a module for cabled scanners or a standard range scan module before you can turn on the terminal.

Remove the battery door on the terminal and make sure the main lithium-ion battery pack is installed correctly. Slide the battery pack toward the top of the terminal to lock the battery pack into the connectors.

The main battery pack may be discharged. Replace the battery pack with a spare charged battery pack, or charge the battery pack and try again.

Problems While Operating the Terminal

If you are operating the TRAKKER 2425 terminal and have trouble, check these possible problems and solutions:

Problem

You scan a reader command, such as Backlight On, and nothing happens.

Solution

The reader commands are disabled. Scan the Enable Override command shown here to temporarily enable all of the reader commands. You can also enable or disable reader commands with the TRAKKER 2400 Menu System. For help, see "Command Processing" in Chapter 8. When you are finished, remember to disable the override so that your data is not interpreted as a command.

Enable Override



\$+DC3

You scan a valid bar code label to enter data for your application. The data decoded by the scan module does not match the data encoded in the bar code label.

The terminal may have decoded the bar code label in a symbology other than the label's actual symbology. Try scanning the bar code label again. Make sure you scan the entire label.

To operate the terminal quickly and efficiently, you should enable only the bar code symbologies that you are going to scan. If you enable multiple symbologies, the terminal may on rare occasions decode a bar code according to the wrong symbology and produce erroneous results.

You want to set the terminal back to the default configuration to start over configuring the terminal.

Scan this bar code label:

Default Configuration



. +

Or, use the TRAKKER 2400 Menu System and follow the instructions in "Restoring the Terminal's Default Configuration" in Chapter 3.

Note: After you load the default configuration, you may need to set the primary network communications parameters to communicate with other devices in the 2.4 GHz network.

*Problems While Operating the Terminal (continued)***Problem**



You cannot scan bar code labels with the standard range scan module or the module for cabled scanners.

Solution

See “Bar Code Labels Will Not Scan” later in this chapter.





The terminal appears to be locked up and you cannot enter data.

Try these possible solutions:

- Wait at least 10 seconds and try again. If the terminal is still connecting to the controller, the terminal ignores any input from the keypad or scanner. Make sure the Connect icon appears and remains on before continuing.
- Scan any bar code label to see if the terminal responds.
- Press  to turn off the terminal. If it turns off, press  to turn on the terminal. You can continue working.
- If the terminal will not turn off, press these keys in sequence to reset the terminal:

 -  - 

The terminal turns off. Press  to turn on the terminal. It boots all the systems, clears RAM memory, and starts your application.

Note: *If the terminal does not boot when you press , you did not press the reset sequence correctly. Press and hold the  and  keys first, then press .*

- Remove the main battery pack and disconnect the backup battery. Let the terminal sit for 1 minute. Install the battery pack and connect the backup battery. Press  to turn on the terminal.
- If you keep returning to the Boot Menu, try loading the firmware. For help, see “Upgrading the Firmware” in Chapter 3.
- If the terminal will not boot or reset, contact your local Intermec service representative for help.



Problems While Operating the Terminal (continued)

Problem

The terminal is booting and you see a message that POST failed.



Solution

The screen displays the system that failed POST. Report the error message to your supervisor.

Press  to exit the error message. The Boot Menu appears. Press  to boot the terminal. Your application appears on the display. If the terminal still will not boot, contact your local Intermec service representative for help.

The terminal displays the Boot Menu.

You will see the Boot Menu in these two situations:

- You remove both batteries at the same time. Once you replace the batteries and turn on the terminal, the Boot Menu appears. Press  to boot the terminal and continue working.
- You just finished upgrading the firmware on the terminal and POST failed. Press  to boot the terminal. Report the problem to your supervisor.

For help on the Boot Menu, see “Booting and Resetting the Terminal” later in this chapter.

You insert a main battery pack. The terminal will not turn on and the Battery icon is not displayed.

The main battery is completely discharged of power. The terminal does not even register enough power to identify a main battery pack and display the Battery icon. Replace the main battery pack with a spare charged battery pack, or charge the battery pack.

You see both these symptoms:

- The Battery icon remains on solid.
- The terminal beeps once every 15 seconds.

The main battery pack charge is low. You have a few minutes of power left. Replace the main battery pack with a spare charged battery pack, or charge the battery pack.

Problems While Operating the Terminal (continued)

Problem

The Battery icon blinks on the top line of the terminal display.

Note: The terminal is not beeping.

Solution

The backup battery charge is low, or the backup battery is not connected. Make sure the backup battery wire connectors are firmly locked together. Check the wires leading into the backup battery and into the bottom case for any damage or loose connections.

Make sure a main battery pack is installed and connected. Turn off the terminal. Let the main battery pack charge the backup battery. The backup battery will be fully charged in approximately 18 hours. If you have been using the terminal in a cold temperature environment, move the terminal to a warmer environment to charge the backup battery.

If the backup battery will not charge, you may need to replace it. For help, contact your local Intermec service representative.

You see both these symptoms:

- The Battery icon blinks.
- The terminal beeps once every 15 seconds.

The main battery pack charge and the backup battery charge are both low. Immediately turn off the terminal.

Replace the main battery pack with a spare charged battery pack. Let the main battery pack charge the backup battery. The backup battery will be fully charged in approximately 18 hours. If you have been using the terminal in a cold temperature environment, move the terminal to a warmer environment to charge the backup battery.

If the backup battery will not charge, you may need to replace it. For help, contact your local Intermec service representative.

Problems While Configuring the Terminal

You can configure the terminal by using the TRAKKER 2400 Menu System or by scanning configuration commands. If you have problems configuring the terminal, check these possible problems and solutions.

Problem

You see this error message when exiting the Configuration Menu:

```
Communications Menu  
configuration error.
```

```
Configuration was not  
updated.
```

Solution

The 2.4 GHz network is enabled and there is a problem with the network configuration. There are four possible problems to check and fix in the Communications Menu:

- The terminal IP address or the controller IP address is set to 0.x.xx.x or 127.x.x.x. These are invalid addresses. Set a valid IP address for the terminal and/or controller.
- The terminal IP address and the controller IP address are both set to the same address. Set a valid IP address for the terminal and controller.
- The terminal and controller are on different networks, but the terminal IP address and the default router address are both set to the same address. Set a valid IP address for the terminal and the default router.
- The terminal and controller are on different networks, and the terminal is not on the same network as the default router. When the terminal is on a different IP subnetwork from the controller, you must set the Default Router and Subnet Mask commands. Set a valid IP address for terminal, controller, and default router.

For help, see "Installing and Configuring the Terminal" in Chapter 4. If you cannot fix the addressing problem, check with your network administrator to get the IP address assigned to the terminal and the controller.

You configure the RF security ID and the changes do not appear to be saved.

You can only set the RF security ID with the 2.4 GHz network enabled. The Network Activate configuration command must be configured to 2.4 GHz RF Network before you can save any changes to the RF security ID command.

Problems While Configuring the Terminal (continued)

Problem

You see this error message when exiting the Configuration Menu:

```
Commandname
command failed.
```

```
Remainder of configuration
not updated.
```

Solution

The two-character name (syntax) of the configuration command that failed is listed on the first line of the error message. For example, you may see this message:

```
SS
command failed.
```

There may be a problem with the configuration due to a change made with the Scanner Selection (SS) command. Check the command listed in the message. To find the command, use the “Configuration Commands by Syntax” table in Appendix A. Make sure the command is set correctly for the options and network you are using with the terminal. For help, see Chapter 8, “Configuration Command Reference.”

You scan a configuration command, such as Keypad Caps Lock, and you hear three low beeps.

If you are working in the TRAKKER 2400 Menu System, you cannot scan configuration commands. Use the Configuration Menu to change the terminal’s configuration, or exit the menu system to scan configuration commands.

You scan a configuration command, such as Keypad Caps Lock, and nothing happens.

There are two possible solutions:

- You may have one or more reader commands disabled, such as Change Configuration, so that you cannot change the configuration. Enable all of the reader commands and try again.
- The terminal may be waiting for another command to complete the configuration change. If you started by scanning the Enter Accumulate command, you must finish the command by scanning the Exit Accumulate command. For help, see Chapter 8, “Configuration Command Reference.”

Scan the Enable Override to temporarily enable all of the reader commands. When you are finished, remember to disable the override so that your data is not interpreted as a command.

Enable Override



\$+DC3

Problems While Configuring the Terminal (continued)

Problem

You scan a configuration command to set one of these parameters and hear three low beeps:

- Controller IP Address
- Terminal IP Address
- Default Router
- Network Activate

Solution

If the Network Activate command is enabled (2.4 GHz network enabled) and you are configuring the terminal, these addresses must define a valid network configuration. For example, an invalid network configuration would be a controller IP address set to 0.0.0.0 with the network enabled.

To set these four parameters, follow these steps:

1. Disable the Network Activate (NA) configuration command.
2. Set the terminal IP address and the controller IP address.
3. Set the default router address (if necessary).
4. Enable the Network Activate command.

You can change an IP address with the network enabled as long as it still defines a valid network configuration.

Terminal Will Not Communicate With Network Devices

If you cannot get the terminal to communicate with other devices in the 2.4 GHz network, check these possible problems:

Problem

The Radio icon on the terminal display remains on.



Solution

Either the Network Activate command is disabled or there is a problem with the radio card and it is turned off. Make sure the Network Activate command is enabled. Use the TRAKKER 2400 Menu System or scan the Network Activate command to enable the 2.4 GHz network and turn on the radio. For help, see “Network Activate” in Chapter 8.

If the network is enabled and the Radio icon remains on, there may be a problem with the radio card. For help, contact your local Intermec service representative.

The Connect icon is not lit on the terminal display.

The terminal is not connected to the 0100 Access Point. Make sure the access point is turned on and operating. You may also be using the terminal out of the RF range of an access point. Try moving closer to an access point to re-establish communications.

Make sure the terminal is configured correctly for your network. To communicate with the access point, the RF domain and RF security ID on the terminal must match the values set for all access points the terminal may communicate with. For help, see “Installing and Configuring the Terminal” in Chapter 4.

The Connect icon blinks on the terminal display.



The terminal is trying to establish communications with the Model 200 Controller. You may need to check the terminal configuration, or make sure the controller is running and data collection is started. Make sure the access point is still turned on. Each device in the 2.4 GHz network must have a valid IP address. The IP addresses set on the terminal must match the addresses configured on the controller. For help, see “Installing and Configuring the Terminal” in Chapter 4.

Terminal Will Not Communicate With Network Devices (continued)

Problem

The terminal is connected to the host computer and you move to a new site to collect data. The Connect icon was on and now begins to blink or turns off.



The Connect icon blinks on the terminal display and you see this message:

```
Unable to connect to  
controller. Error 102.
```

```
Unable to establish  
connection to host. Session  
ended.
```

The Connect icon remains on, but the host computer is not receiving any data from the terminal.



The Connect icon remains on, but you cannot establish a terminal emulation session with the host computer.



Solution

You may have gone out of range of an access point. Try moving closer to an access point or to a different location to re-establish communications. Once you are in range again, the Connect icon will appear and remain on. Any data you collected while you were out of range will be transmitted over the network.

The terminal is connected to the 0100 Access Point, but is trying to establish communications with the Model 200 Controller and the host computer. Make sure the terminal is correctly configured for your network. Make sure the controller is configured and running. Make sure the host computer is configured and running.

If you have configured the network correctly, try restarting the controller to establish communications. You can also try resetting the terminal. For help resetting the terminal, see "Booting and Resetting the Terminal" later in this chapter.

There may have a problem with the connection between the Model 200 Controller and the host computer. Check with your network administrator or use the *Model 200 Controller System Manual* to troubleshoot any potential problems on the controller.

There may be a problem with the host computer, or the connection between the Model 200 Controller and the host computer. Check with your network administrator to make sure the host computer is running and allowing users to login to the system.

Problems Using Terminal Emulation Applications

There are two types of error messages that you may see while running the 3270 or 5250 terminal emulation application on the terminal:

- Recoverable error
- Non-recoverable error

Recoverable errors display in the status line on the bottom line of the terminal display. If the status line option is not currently selected, the status line will appear if there is a recoverable error. A non-recoverable error appears directly on your display and your TE session ends. You must follow the instructions on the terminal display to continue with your session.

If the Model 200 Controller detects an error and ends the session, you will see a controller error message on the terminal display. Record this error message and pass it on to your network administrator or contact your local Intermec service representative.

The 3270, 5250, and VTXXX/ANSI terminal emulation applications have an error handling routine that detects local editing errors and command handling errors. If you have a problem while running your TE application, check these possible problems:

Note: Many of the error messages in the next table only apply when running the 5250 TE application.

| Error Message | Solution |
|---|--|
| Attn Not Processed (5250 error) | The host computer was unable to process your Attention request. Press <input type="button" value="f"/> <input type="button" value="Esc"/> to reset the terminal and try again later. |
| Digit Only (5250 error) | You have entered an invalid character in a digit only (numeric) field. Reenter a valid character for this type of field. |
| DUP Field Required (5250 error) | You have pressed a DUP key in a field that does not have the DUP bit enabled. Enter a valid command for this type of field. |
| Field minus invalid (5250 error) | You have pressed the Field- key in a non-numeric field. Use the Field Exit or Field+ key. |
| Field not in Field Format Table (5250 error) | The cursor is not positioned correctly in a data input field. Position the cursor correctly and try again. |

Problems Using Terminal Emulation Applications (continued)

| Error Message | Solution |
|--|---|
| FM Field Required (5250 error) | You have pressed a Field Mark key in a field that does not have the DUP bit enabled. Enter a valid command for this type of field. |
| Function not implemented (5250 error) | You have pressed an unsupported function key or entered an invalid key sequence. Try the function again using the correct key sequence. |
| Help Not Processed (5250 error) | The host computer was unable to process your Help request. Press [=f] [Esc] to reset the terminal and try again. |
| Invalid control sequence | You have pressed an unsupported function key or entered an invalid key sequence. Reenter a valid key sequence. |
| Mandatory field! (5250 error) | You have attempted to bypass a mandatory data entry field using a Field+, Field-, or Field Exit key. Enter data in the field. |
| Monocase Only (5250 error) | You have entered an invalid character in a monocase only field. Reenter a valid character for this type of field. |
| No more room for insert | You have entered more characters than allowed in a field. Press [=f] [Esc] to reset the terminal. Enter your data again using fewer characters. |
| Numeric Only | You have entered an invalid character in a numeric only field. Reenter a valid character for this type of field. |
| Parameter error. (5250 error) | The command received from the host computer contained an invalid parameter. Try to establish a host connection later by selecting Exit Config from the TE Configuration menu. |
| Protected Field | You are attempting to enter data in a protected region of the screen. Press [=f] [Esc] to reset the terminal. |
| Roll Down Not Processed (5250 error) | The host computer was unable to process your Roll Down request. Press [=f] [Esc] to reset the terminal and try again. |

Problems Using Terminal Emulation Applications (continued)

Error Message

Solution

Roll Up Not Processed
(5250 error)

The host computer was unable to process your Roll Up request. Press **[F] [Esc]** to reset the terminal and try again.

Session ended.

This message indicates a fatal error. Record the controller primary and secondary return codes and contact your network administrator. Wait a few minutes and try to connect again by selecting Exit Config from the TE Configuration menu.

Signed Numeric Only
(5250 error)

You have entered an invalid character in a signed numeric field. Reenter a valid character for this type of field.

SysRq Not Processed
(5250 error)

The host computer was unable to process your System Request. Press **[F] [Esc]** to reset the terminal and try again.

Problems Using the Screen Mapping Application

There are three types of errors that you may see while running the screen mapping application on the terminal:

- Initialization errors that occur while trying to start the screen mapping application, download the template, or loading a screen.
- Communications errors that occur while trying to communicate with the Model 200 Controller.
- Data entry errors that occur while entering data in the fields on a screen.

If you have a problem while using your screen mapping application, check these possible initialization, communications, or data entry problems.

Screen Mapping Initialization Errors

| Problem | Solution |
|---|--|
| Restart T2400. | The screen mapping application did not start correctly. Scan this bar code label to reset the firmware and restart the application: Reset Firmware  *-* |
| Error Reading Template File. | You are trying to download the template file from the Model 200 Controller and a file error occurred. Make sure you enter a valid template name that is currently stored on the correct directory on the controller. Try requesting or downloading the template again. For help, see the <i>Model 200 Controller System Manual</i> . |
| Screen must have one input field defined. | The screen you selected has not been defined correctly. An input screen must have at least one input field defined. You need to fix the template and the screen definition on the controller and download a new template. |
| Required Fields Not Complete. | You skipped at least one required field. You must enter data in each required field on the screen. Make sure you have entered data in every required field to continue. |

Screen Mapping Initialization Errors (continued)

| Problem | Solution |
|--|---|
| Error building list from template file. | The template file was downloaded from the controller, but there was a problem building the list of screens. The template file on the terminal is corrupted. Try requesting or downloading the template again. For help, see “Requesting a New Template” in Chapter 5. |
| No menu items defined in Template. | The template file was downloaded from the controller, but either no menu items were defined in the template or there is a problem reading the template. The template file on the terminal is corrupted. Try requesting or downloading the template again. For help, see “Requesting a New Template” in Chapter 5. |
| Template file error reading menu. | The template file was downloaded from the controller, but there was a problem reading the menu. The template file on the terminal is corrupted. Try requesting or downloading the template again. For help, see “Requesting a New Template” in Chapter 5. |
| Could not open Template file. | The template file was downloaded from the controller, but the terminal could not open the template file. The template file on the terminal is corrupted. Try requesting or downloading the template again. For help, see “Requesting a New Template” in Chapter 5. |
| There are no Screen items defined in Template. | The template file was downloaded from the controller, but no screen items are defined in the template. Check the template on the controller and make sure you have defined screens. The template file on the terminal is corrupted. Try requesting or downloading the template again. For help, see “Requesting a New Template” in Chapter 5. |
| Error reading Screens in Template file. | The template file was downloaded from the controller, but there was a problem reading the screens in the template. The template file on the terminal is corrupted. Try requesting or downloading the template again. For help, see “Requesting a New Template” in Chapter 5. |

Screen Mapping Initialization Errors (continued)

| Problem | Solution |
|-----------------------------------|---|
| Link List error, Program exiting. | The template file was downloaded from the controller, but there was a problem. The template file on the terminal is corrupted. Try requesting or downloading the template again. For help, see "Requesting a New Template" in Chapter 5. |
| Build screen error. | The template file was downloaded from the controller, but there was a problem building the screens. The template file on the terminal is corrupted. Try requesting or downloading the template again. For help, see "Requesting a New Template" in Chapter 5. |
| Error on read. | The template file was downloaded from the controller, but there was a problem reading the file. The template file on the terminal is corrupted. Try requesting or downloading the template again. For help, see "Requesting a New Template" in Chapter 5. |

Screen Mapping Communications Errors

| Problem | Solution |
|------------------------------|--|
| Transaction Buffer Full. | The buffer holding transactions to be sent to the controller is full. Stop collecting data with this terminal. Make sure the terminal is communicating with the Model 200 Controller and let the terminal send all the transactions in the buffer before you continue collecting data. |
| Sending Buffer Transactions. | This is an information message to tell you that buffered transactions are now being sent to the controller. You can begin collecting data again once the message clears. |
| Transaction Aborted. | The transaction just sent to the controller was not received. Try sending the transaction again. |

Screen Mapping Communications Errors (continued)

| Problem | Solution |
|---------------------------------|--|
| Transmit Error XX, press Enter. | There is an error transmitting data to the controller. XX represents the status code error. Note the error code listed in the message and contact your local Intermec service representative for help. Press <input type="button" value="↵"/> to continue. |
| Receive Error XX, press Enter. | There is an error receiving data from the controller. XX represents the status code error. Note the error code listed in the message and contact your local Intermec service representative for help. Press <input type="button" value="↵"/> to continue. |
| Shutting down. | The Model 200 Controller is shutting down. You may continue collecting data and buffer the transactions in the terminal until the controller starts again, or stop collecting data with the terminal. |
| Controller Shutdown. | The Model 200 Controller has shut down. You may continue collecting data and buffer the transactions in the terminal until the controller starts again, or stop collecting data with the terminal. |

Screen Mapping Data Entry Errors

| Problem | Solution |
|-------------------------|---|
| Minimum length error. | You entered too few characters in the field. Enter your data again using the required number of characters. |
| This field is required. | You cannot skip a required field. Enter data in the field to continue. |
| Prefix error. | The prefix character entered is incorrect. Enter your data again using a valid prefix. |
| Bad Data. | The data entered did not pass the input test defined for this field. Enter your data again. |

Screen Mapping Data Entry Errors (continued)

| Problem | Solution |
|--------------------------|--|
| Validation File Missing. | The validation file used for the screen is not stored on the terminal. You can download the validation file from the Model 200 Controller or request the file from the terminal. For help, see "Loading a Validation File" in Chapter 5. |
| Range Error. | The data entered is out of the range defined for this field. Enter your data again. |
| Bad Picture Match. | The data entered does not match the picture defined for this input field. Enter your data again. |
| Numeric Only. | The data entered was not numeric and this is a numeric field. Enter your data again using only numeric data. |
| Hour Greater Than 23. | You are entering data in a Time field and entered an invalid hour. Enter the time again using an hour from 0 to 23. |
| Minutes Greater Than 59. | You are entering data in a Time field and entered invalid minutes. Enter the time again using minutes from 0 to 59. |
| Seconds Greater Than 59. | You are entering data in a Time field and entered invalid seconds. Enter the time again using seconds from 0 to 59. |
| Days Error. | You are entering data in a Date field and entered an invalid day. Enter the date again using a valid day for the month. |
| Month Error. | You are entering data in a Date field and entered an invalid month. Enter the date again with a valid month from 1 to 12. |
| Year Error. | You are entering data in a Date field and entered an invalid year. Enter the date again with a valid year. |
| Input Length Error. | The data entered exceeded the length defined for this field. Enter your data again. |

Bar Code Labels Will Not Scan

If you cannot scan bar code labels or you are having problems with the scan module, check these possible problems:

Problem

A scan module is not installed.

The terminal is turned off.

You cannot see a red beam of light from the standard range scan module when you press the Scan button and aim the scanner at a bar code label.

Solution

Make sure a scan module is installed correctly. You must install either a module for cabled scanners or a standard range scan module before you can use the terminal.

Make sure the terminal is turned on. Press  to turn on the terminal.

There are two possible problems:

- You may be too far away from the bar code label. Try moving closer to the bar code label and scan it again.
- You may be scanning the bar code label “straight on.” Try changing the scanning angle until the laser beam is the brightest. This is the best scanning angle.

You can test the effective range of the scanner. Move within 2 feet of a wall and test the scanner. You need to be within the scanning range to scan bar code labels. For help on scanning distances, see “Physical and Environmental Specifications” in Appendix A.



Warning

Do not look directly into the window area or at a reflection of the laser beam while the laser is scanning. Long-term exposure to the laser beam can damage your vision.

Advertissement

Ne regardez pas directement la réflexion d'un rayon laser ou dans la fenêtre du laser lorsque celui-ci est en opération. Si vous regardez trop longtemps un rayon laser, cela peut endommager votre vue.

An input device is not attached to the module for cabled scanners.

Make sure an input device, such as a 1550 laser scanner, is attached correctly to the module for cabled scanners. You must install an input device before scanning bar code labels.

Bar Code Labels Will Not Scan (continued)

Problem

You have an input device attached to the module for cabled scanners and cannot read any bar code labels.

The scan module or input device will not read the bar code label.

Solution

You may not be using an input device that is supported with the module for cabled scanners. Make sure you are using one of the supported input devices:

- Intermec 126X and 127X wands
- Intermec 146X CCD scanners
- Intermec 151x, 1545, and 155x laser scanners
- JANUS™ 7010 hand-held imager
- Compatible Symbol scanners (reverse polarity enabled)

You must use an interface cable to connect the input device to the module. If you are using the J7010 imager, you need to use a wedge interface cable (P/N 062168) and set the Cable ID parameter on the J7010 to the "Force 97xx Wedge" option. For help, see the *TRAKKER 2400 Series Module for Cabled Scanners Instruction Sheet* (P/N 064219-001).

Try one of these solutions:

- Make sure you aim the scanner beam so it crosses the entire label in one pass.
- The angle you are scanning the bar code label may not be working well, or you may be scanning the label "straight on." Try scanning the bar code label again, but vary the scanning angle.
- The bar code label print quality may be poor or unreadable. To check the quality of the bar code label, try scanning a bar code label that you know scans. Compare the two bar code labels to see if the bar code quality is too low. You may need to replace the label that you cannot scan.
- Make sure the bar code symbology you are scanning is enabled. Use the TRAKKER 2400 Menu System to check the symbologies. On the Symbologies Menu, each symbology that is enabled has an asterisk (*) next to the name of the symbology. If your bar code symbology is disabled, enable it and then try scanning the bar code label again.

Bar Code Labels Will Not Scan (continued)**Problem**

The input device connected to the module for cabled scanners does not appear to work well or read bar code labels very quickly.

The standard range scan module does not read the bar code labels quickly, or the scanning beam seems to be faint or obscured.

When you press the Scan button, the scanner LEDs at the top of the keypad do not light up.

When you release the Scan button, the scanner LEDs at the top of the keypad do not turn off.

Solution

Try setting the Scanner Selection command to the specific input device you have attached. Check the bar code symbologies you have enabled on the terminal. Enable only the symbologies that you are using.

The standard range scan module window may be dirty. Clean the scanning window of the scan module with a solution of ammonia and water. Wipe dry. Do not allow abrasive material to touch the window.

Move within 2 feet of a wall and press the Scan button again. Make sure the scan module emits the red laser beam. If the LEDs do not light, there may be a problem with them. For help, contact your local Intermec service representative. If the laser beam does not turn on, check the other problems in this section for a possible solution.

The scanner LEDs will remain on if you configure the terminal to use edge triggering. If you configure the terminal for level triggering and the scanner LEDs remain on, there may be a problem with the LEDs. Press the Scan button again without scanning a bar code label. If the LEDs are still on, contact your local Intermec service representative.

Guidelines for Managing Batteries

Follow these guidelines to manage the terminal batteries, prevent problems, and preserve battery power:

- | | |
|-----------------------------|--|
| Main Battery Pack | <ul style="list-style-type: none">• ALWAYS turn off the terminal BEFORE you remove the main battery pack.• ALWAYS keep a charged or partially charged main battery pack in the terminal.• Keep a spare, charged battery pack on hand.• If the Battery icon appears and remains on solid, you have a low main battery pack, replace or charge the battery pack as soon as possible.• When you remove a low main battery pack from the terminal, recharge the battery pack you just removed.• If the terminal turns off due to a low main battery pack, do not turn on the terminal. Replace or charge the main battery pack before you continue using the terminal.• Use the battery charger to charge the main battery pack. Charge the main battery pack for a minimum of 2 hours to make sure the battery pack is fully charged. |
| Backup Battery | <ul style="list-style-type: none">• If you have a low backup battery, turn off the terminal. Insert a fully charged main battery pack. The main battery pack will fully charge the backup battery in approximately 18 hours.• ALWAYS turn off the terminal BEFORE you remove the backup battery. |
| Storing the Terminal | <ul style="list-style-type: none">• If you are going to store the terminal for less than 2 weeks, keep both batteries installed in the terminal. Insert a fully charged main battery pack before you store the terminal. |

Storing the Terminal
(continued)

- If you are going to store the terminal for more than 2 weeks, save your data and end your TE or screen mapping session to minimize the risk of data loss. Remove both the main battery pack and the backup battery from the terminal.

Cold Temperatures
(Using the terminal
in sub-freezing
environments)

- If you use the terminal in a cold temperature environment, battery life will be reduced. Battery life depends on temperature, battery model, input device, age of the battery pack, your usage, and duty cycle factors. If you use the terminal for extended periods of time in sub-freezing environments, you may need to change the battery pack more often.
- Do not store the terminal in a cold temperature environment. When you are not using the terminal, keep it in a warmer area to make sure the battery chargers will continue operating.
- If the Battery icon blinks, the backup battery charge is low. Move the terminal to a warmer environment to charge the backup battery. The backup battery charger operates between 32°F and 104°F (0°C and 40°C). If you are using the terminal in an area outside this temperature range, the backup battery will not charge.
- Store the battery chargers and spare batteries in a warm (office) environment to assure the most efficient operation.
- Charge the main battery pack in an area or room where the temperature is above freezing.
- If you have been using the terminal in a cold temperature environment and need to replace or charge either battery, let the batteries warm up for a half hour before you charge them.

Booting and Resetting the Terminal

You seldom need to boot or reset the TRAKKER 2425 terminal. When you boot the terminal, it runs through power-on self test (POST) to test each major subsystem. The terminal uses the configuration currently saved in flash memory. Once the terminal is finished booting, your TE application or screen mapping application appears on the display.



You only reset the terminal when the terminal or an application are locked up and will not respond to any key sequences. The terminal also boots and resets after a firmware upgrade or if you remove both batteries. The next instructions explain how you boot and reset the terminal.

Booting the Terminal

You can boot the terminal using these two methods:

- Configure the  key to boot the terminal when you turn on the terminal.
- Use the Boot Menu.

Booting the Terminal on Resume

When you press  to turn off the terminal, it turns off and goes into Suspend mode. When you press  to turn on the terminal, it resumes or boots depending on the terminal configuration.

There are two ways to configure the  key using the Resume Execution configuration command:

Resume Execution Not Allowed Configures the terminal to boot and restart your TE application or screen mapping application each time you press  to turn on the terminal. Use this option if you want to restart your application every time you turn on the terminal.

Resume Execution Allowed Configures the terminal to resume exactly where it was when you turned off the terminal. Use this option to resume working each time you turn on the terminal.

You can configure the Resume Execution command by using the TRAKKER 2400 Menu System or by scanning these bar code labels. For help, see Chapter 3, "Configuring the Terminal," or "Resume Execution" in Chapter 8.

Resume Execution Not Allowed



S+ER0

Resume Execution Allowed



S+ER1

Using the Boot Menu

The Boot menu appears after you:

- remove both batteries, install them again, and turn on the terminal.
- upgrade the firmware.
- reset the terminal.

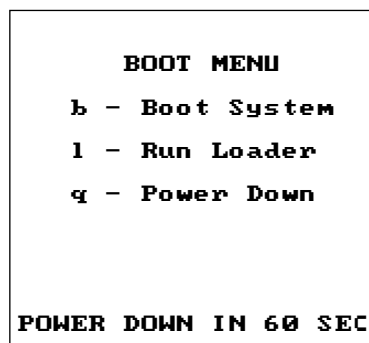

242XU.104

The Boot Menu contains these commands:

Boot System If you did remove the batteries, make sure you install a charged main battery pack or the terminal will not turn on. Press **[B]** to boot the terminal. Once the terminal is finished booting, your TE application or screen mapping application appears on the display.

Run Loader Press **[L]** to load the terminal firmware. To upgrade or load the firmware, you should use the Firmware Upgrade option in the TRAKKER 2400 Menu System. For help, see “Upgrading the Firmware” in Chapter 3.

Power Down Press **[Q]** to turn off the terminal. When you turn on the terminal, the Boot Menu screen appears if POST passes.

Resetting the Terminal

If the terminal or application is locked up and the terminal will not respond to any key sequences, you can reset the terminal. Before you reset the terminal, try the following in order:

- Press  to turn off the terminal.
- Scan the Reset Firmware label to restart the firmware and application.





Reset



-.



If the terminal or application still will not respond, reset the terminal.

To reset the terminal

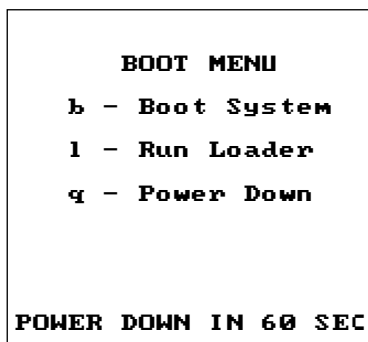
1. Press the  -  -  keys in sequence. The terminal turns off.
2. Press  to turn on the terminal. The Boot Menu appears.



242XU.104

Note: If the terminal returns to the exact same screen, the reset sequence did not work. Repeat Step 1. Make sure you press the  key just after the  and .

3. Press  to boot the terminal. Once the terminal has finished booting, your TE application or screen mapping application appears.

If the terminal still will not reset or boot, try loading the firmware. For help, contact your local Intermec service representative.

Maintaining and Cleaning the Terminal

The TRAKKER 2425 terminal is built for use in a rugged, industrial working environment. You may need to perform these minor maintenance tasks to keep the terminal in good working order:

- Replace the antenna
- Clean the display
- Clean the standard range scan module window

The antenna is one of the few exposed parts that may be damaged while you use the terminal. You can order and replace the antenna using the instructions in this section. If you do have problems with other mechanical parts, contact your local Intermec service representative for help.

Clean the scan module window and display as often as needed for the environment in which you are using the terminal. Each procedure is described in detail in this section.

To order replacement parts, contact your local Intermec service representative or contact Intermec at:

Intermec Corporation
6001 36th Ave. West
P.O. Box 4280
Everett, Washington 98203-9280

Telephone: 1-206-348-2600

Replacing the Antenna

If your antenna is damaged, you can replace it. To replace the antenna, you need these items:

- 2.4 GHz SMB antenna (Part No. 063825)
- Retaining ring (Part No. 064101)
- Small straight-slot screwdriver

To replace the antenna

1. Rotate the antenna to line up the alignment marks on the connector end of the antenna with the alignment marks on the terminal antenna connector.
2. Insert the straight-slot screwdriver into the retaining ring opening so that the screwdriver is in the retaining ring slot.

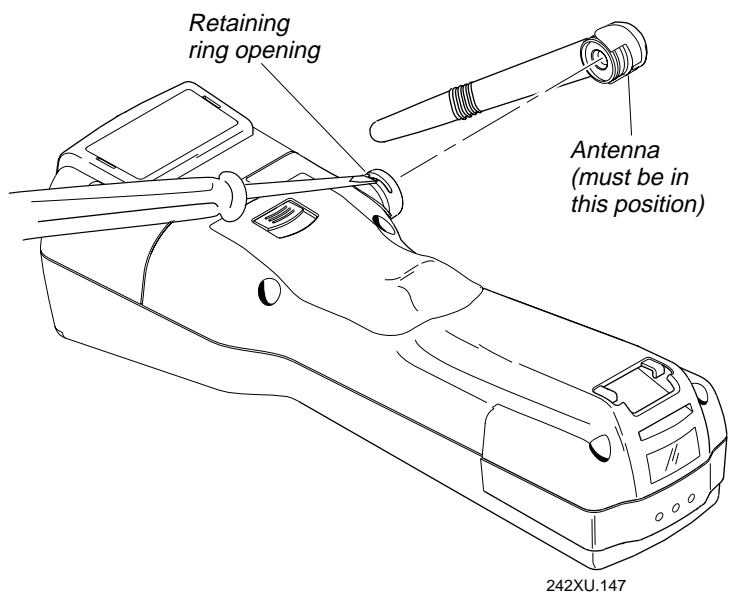

3. Pry the retaining ring up out of the opening and remove it.
4. Pull the antenna off the antenna connector on the terminal.

5. Line up the alignment marks on the connector end of the antenna with the alignment marks on the terminal antenna connector.

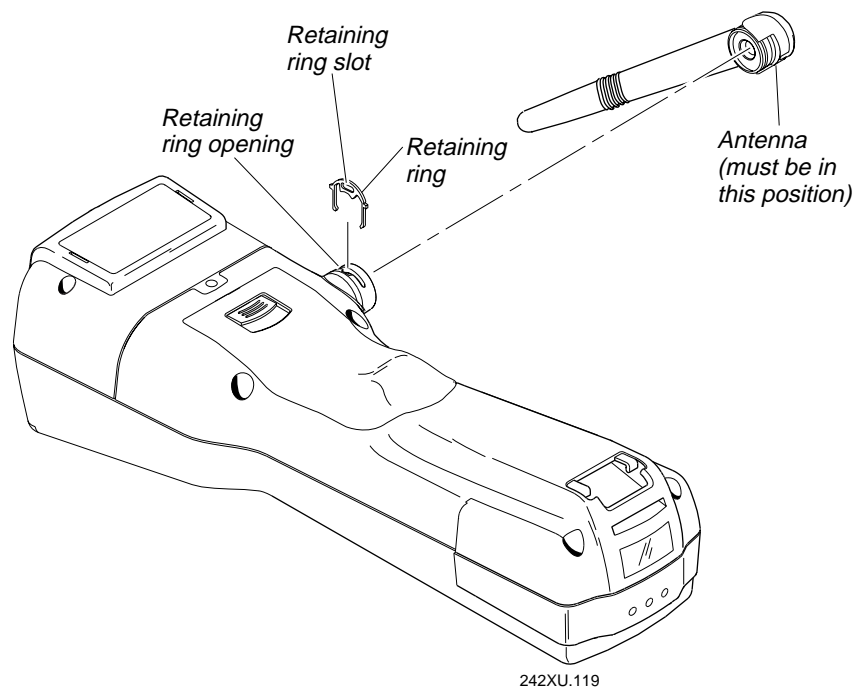

6. Push the new antenna onto the antenna connector until it fits flush and the opening for the retaining ring is visible.
7. Insert the retaining ring into the opening.
8. Push the retaining ring down until it is locked in place.
9. Turn the terminal over and adjust the angle of the antenna as needed.

Cleaning the Scan Module Window and Display

To keep the T2425 terminal in good working order, you need to clean the scan module window and terminal display. Clean these surfaces as often as needed or when they are dirty.

To clean the scan module window and display

1. Press  to turn off the terminal.
2. Use a solution of ammonia and water.
3. Dip a clean towel or rag in the ammonia solution and wring out the excess solution. Wipe off the scan module window and terminal display. Do not allow any abrasive material to touch these surfaces.
4. Wipe dry.

Running Diagnostics

You can run diagnostics on the terminal to help analyze and fix hardware and firmware problems, application problems, and to view system information. You use the TRAKKER 2400 Menu System to run diagnostics.

Use this table to determine the diagnostic you want to run on the terminal.

| Diagnostic Test | Description |
|------------------------|--|
| Access Point | Lists information about the 0100 Access Point the terminal is communicating with across the network. |
| Application Events | Shows the current status of each application event to help debug applications. |
| Battery Monitor | Shows the voltage, temperature, and charging status for the main battery pack. |
| Battery Status | Shows the power remaining in the main battery pack and the power status for the backup battery. |
| Beeper Test | Sounds a series of beeps to test the beeper by using a range of beep volumes and beep frequencies. |
| Clear Task Profiles | Clears the Task Status counters so that you can begin accumulating new task statistics for the Task Status screen. |
| Destructive RAM Test | Extensively tests the RAM. |
| Display Test | Tests and turns on the pixels on the display to make sure all areas of the display are working correctly. |
| Error Logger | Lists any errors that the firmware did not expect. |
| Hardware Configuration | Lists the type of the main hardware components used on the terminal. Also, shows the RF country code configured on the terminal. |
| Keypad Test | Shows the hexadecimal and decimal key code value for any key on the terminal keypad. |

Diagnostic Tests (continued)





| Diagnostic Test | Description |
|---------------------|---|
| Radio Test | Tests the radio to make sure it is working. |
| RS-232 Loop Back | Verifies that the hardware for the RS-232 port is functioning correctly. |
| Scanner Test | Tests the laser scanner to make sure it is working. |
| Subsystem Versions | Lists the version of each major software subsystem loaded on the terminal. |
| Suspend-Resume Test | Tests the terminal memory to make sure the memory is being preserved through a suspend and resume cycle. |
| Task Status | Shows the task base address, the percentage of time each subsystem has been running, and the stack usage. |

Note: There are two additional diagnostics available from the Software Diagnostics, Event Group Menu. The two diagnostics, Network Events and Network Applications, will be defined in a future release.

Running Diagnostics From the Menu System

The TRAKKER 2400 Menu System is a menu-driven application that lets you configure the terminal, view system information, and run diagnostics. You can access the TRAKKER 2400 Menu System and run diagnostics while running any application.

To run diagnostics from the TRAKKER 2400 Menu System

1. Press      or scan this bar code:

Note: You must press the  (Left Enter) key in this key sequence, not the  (Right Enter) or  keys.

Enter Test and Service Mode



...

The Main Menu appears.

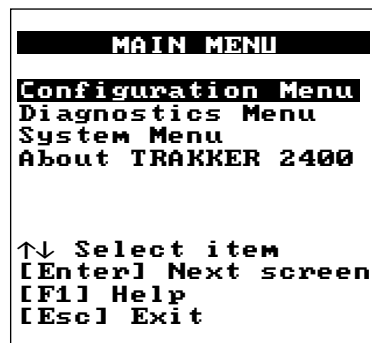

242XU.001

2. Press ▼ to choose the Diagnostics Menu and press . The Diagnostics Menu appears.

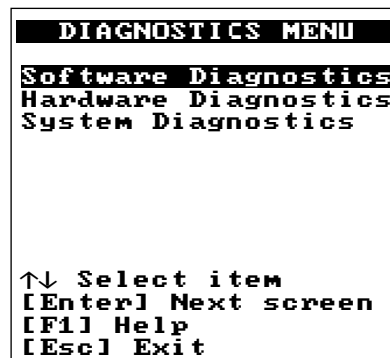

242XU.050

The Diagnostics Menu contains these commands:

Software Diagnostics Lets you run software diagnostics to help analyze and fix problems on the terminal. For example, you can view the Error Logger file to view system errors.

Hardware Diagnostics Lets you run hardware diagnostics to help analyze and fix problems on the terminal. For example, you can check the power remaining and the condition of the batteries.

System Diagnostics Lets you run system diagnostics to help analyze and fix problems on the terminal. For example, you can run diagnostics to check the communications between the terminal and the 0100 Access Point or the Model 200 Controller.

3. Press ▲ or ▼ to choose Software Diagnostics, Hardware Diagnostics, or System Diagnostics and press . One of these menus appear.

```
SOFTWARE DIAGNOSTICS
Error Logger
Event Group Menu
Task Status
Clear Task Profiles

↑↓ Select item
[Enter] Next screen
[F1] Help
[Esc] Exit
```

242XU.065

```
HARDWARE DIAGNOSTICS
Hardware Config
Battery Status
Display Test
Keypad Test
Main Board Menu
Radio Test
RS-232 Loop Back
Scanner Test



↑↓ Select item
[Enter] Next screen
[F1] Help
[Esc] Exit
```

242XU.067

```
SYSTEM DIAGNOSTICS
Subsystem Versions
Access Point
Suspend-Resume Test

↑↓ Select item
[Enter] Next screen
[F1] Help
[Esc] Exit
```

242XU.069

4. Press ▲ or ▼ to choose the diagnostic test you want to run and press . The diagnostic screen appears. Use the information on the screen or follow the instructions to run the diagnostic test. For help, see “Defining the Diagnostics Screens” later in this section.
5. Press  to exit each diagnostic screen and to exit the diagnostics menus.
6. Choose another menu from the Main Menu or press  to exit the TRAKKER 2400 Menu System. If you have made any changes, a screen prompts you to store the changes in flash memory. For help, see “Exiting the TRAKKER 2400 Menu System” in Chapter 3.

After you exit the menu system, the T2425 terminal will resume the application you were running when you started the menu system.

Defining the Diagnostics Screens

You can find the following information about each diagnostic test in this section:

- Description and purpose
- Menu where the diagnostic is available
- Sample diagnostic screen
- Definition and explanation of the diagnostic screen

The diagnostics are grouped into three categories:

- Software diagnostics
- Hardware diagnostics
- System diagnostics

Within each category, the diagnostics are listed alphabetically by name.

Defining the Software Diagnostics Screens

Each software diagnostic screen is defined in this section.

Application Events

Purpose: A programmer can use the current status of each event to help debug applications running on the terminal.

Where Available: Choose the Event Group Menu from the Software Diagnostics menu.

Note: There are two additional diagnostics available from the Software Diagnostics, Event Group Menu. The two diagnostics, Network Events and Network Applications, will be defined in a future release.

Sample Screen:

```
APPLICATION EVENTS
0:0 NO SELECT
1:0 COM1 SELECT
2:0 COM2 SELECT
3:0 RESERVED
4:0 NET SELECT
5:0 LABEL SELECT
6:0 KEYBOARD SELECT
7:0 COM1 TX SELECT

[Enter] Next screen
[Esc] Exit
```

```
APPLICATION EVENTS
8:0 COM2 TX SELECT
9:0 NET TX SELECT
10:0 TIME SELECT

[Enter] Next screen
[Esc] Exit
```

242XU.130

Definition: The TRAKKER 2425 terminal uses an event-driven architecture. All inputs to the terminal, such as keypad or from the network, arrive in the form of an event. You can check the status of each event using the Application Events screen. When an event is serviced by the application, the event is cleared.

0 means the event is cleared.

1 means the event has occurred (or is set).

Clear Task Profile

Purpose: Clears the task profile counters so that you can begin accumulating statistics on the firmware subsystem tasks from a known point in time.

Where Available: Software Diagnostics menu

Sample Screen:

```
CLEAR TASK PROFILES
Operating system
task profile
counters have been
cleared.

[Esc] Exit
```

242XU.132

Definition: When you select the Clear Task Profiles option, the terminal clears the %Time field on the Task Status screen.

Error Logger

Purpose: You can use the Error Logger screen to display any errors that the system could not fix while you were using the terminal. For help solving an error, contact your local Intermec service representative.

Where Available: Software Diagnostics menu

Sample Screen:

```
ERROR LOGGER
Current Time:231912
Time  Err#  Address
024401 0003  90000548
024359 0002  90000548
024358 0001  90000548

[Enter] Next screen
[Esc] Exit
```

242XU.134

Definition: The Error Logger screens shows the last 30 errors. Press  to see the next screen of errors. The first column displays the time in HHMMSS. The second column displays the error number. The third column displays the address or segment offset of the program call that was made to the error logger.

Task Status

Purpose: A programmer can use the Task Status screens to view the task base address and the percentage of time a task has been running.

Where Available: Software Diagnostics menu

Sample Screen:

| TASK STATUS | | |
|-------------|-----------|--------|
| SLOT | ADDRESS | %TIME |
| 0: | ---- | ---.-% |
| 1: | F002:0214 | 00.7% |
| 2: | A000:00DA | 00.0% |
| 3: | ---- | ---.-% |
| 4: | CE00:001E | ---.-% |
| 5: | 2000:0000 | 10.2% |
| 6: | DA07:0073 | ---.-% |
| 7: | DB06:0047 | 00.0% |
| 8: | E000:00E2 | 89.1% |
| 9: | ---- | ---.-% |
| 10: | ---- | ---.-% |

[Enter] Next screen
[Esc] Exit

| TASK STATUS | | |
|-------------|-----------|--------|
| SLOT | STACK | UNUSED |
| 0: | ---- | ---- |
| 1: | 1600:59F8 | 0201 |
| 2: | 1600:4F90 | 0797 |
| 3: | ---- | ---- |
| 4: | 1600:4800 | 0587 |
| 5: | 1600:4678 | 013D |
| 6: | 1600:4270 | 0391 |
| 7: | 1600:4068 | 013E |
| 8: | 1600:3C60 | 0292 |
| 9: | ---- | ---- |
| 10: | ---- | ---- |

[Enter] Next screen
[Esc] Exit

242XU.131

Definition: The %Time field measures the relative amount of time that a given software task or component is active. For example, Standby mode in the Power Management software is a component. The %Time that Standby mode is active is directly proportional to battery life.

To refresh the statistics and start from a known point in time, use the Clear Task Profile diagnostic option to clear the task status counters.

Defining the Hardware Diagnostics Screens

Each hardware diagnostic screen is defined in this section.

Battery Monitor

Purpose: Use the Battery Monitor screen to get information from the battery monitor processor about the main (lithium-ion) battery pack. You can use the temperature information to make sure you are using the terminal within the operating temperature range.

Where Available: Choose the Main Board Menu from the Hardware Diagnostics menu.

Sample Screen:

```
BATTERY MONITOR
Battery Volts
8.225 V (EA)
Battery Temperature
25C (A6)
Charging: NO
PIC Rev.: 7

[Esc] Exit
```

242XU.006

Definition: The screen displays the current volts, temperature, and the charging status (yes or no). The PIC Rev field is the firmware version that is running on the battery monitor processor. The number in parenthesis after the volts and temperature is the hexadecimal value returned from the processor. For more information about the power remaining in the battery pack, use the Battery Status diagnostic screen.

Battery Status

Purpose: Use the Battery Status screen to find out how much power you have remaining in the main (lithium-ion) battery pack, and to get the current power status for the backup (NiCad) battery.

Where Available: Hardware Diagnostics menu

Sample Screen:

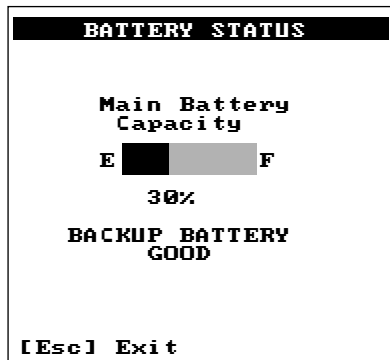

242XU.141

Definition: Main Battery Capacity tells you the percentage of battery power remaining in the battery pack. For example, there is 30% power remaining. You can continue using the battery pack until the Battery icon appears on the display to indicate a low battery.

The backup battery test shows that the backup battery power is either GOOD or LOW. If the status is LOW, turn off the terminal. Let the main battery pack charge the backup battery. The backup battery will be fully charged in approximately 18 hours.

Beeper Test

Purpose: You can test the terminal beeper to make sure the entire beep volume range and beep frequency range are available and working correctly. The Beeper Test can also help you distinguish the different beep volumes to choose a level that you can hear in your working environment.

Where Available: Choose the Main Board Menu from the Hardware Diagnostics menu.

Sample Screen:

```
BEEPER TEST

SELECT BEEP TEST:
(Hold down any key
to stop test)

1-Frequency Up/Down
2-Volume Up/Down
3-Club 39 Jam
4-K. 622

[Esc] Exit
```

242XU.145

Definition: Press 1 to test the beep frequency range. The terminal will sound a series of beeps starting from a low frequency beep through the range to a high frequency beep, and then back to a low frequency beep.

Press 2 to test the beep volume. The terminal sounds a series of beeps from a quiet beep to a very loud beep.

Tests 3 and 4 also test the beep volume and frequency by playing a short tune. If you do not hear any beeps during any of these tests, you may have a problem with the beeper or internal speakers. For help, contact your local Intermec service representative.

Destructive RAM Test

Purpose: Use the Destructive RAM Test if you are think the RAM may be bad.

Where Available: Choose the Main Board Menu from the Hardware Diagnostics menu.

Sample Screen:

```

DESTRUCTIVE RAM TEST

The following test
will cause the unit
to reboot, causing
loss of all RAM
resident data.

PROCEED?
PRESS 'Y' to
proceed...

[Esc] Exit
    
```

```

Memory Test Passed

Pass #: 00037

Press a key
to Reboot Unit
    
```

242XU.143

Definition:

Before you run this test, save your data and end your current TE session. Press Y to start the test. All data in RAM will be lost. The terminal starts the RAM test and clears the display. You hear a beep after a successful test of each 64K block of data. After 15 beeps, a test pass is complete and the results appear. The sample screen shows a successful test pass.

To run another test pass, do not press a key and the next test begins after a 5 second pause. You may let the test continue and test the RAM several times to get a test over time. To exit the test, press ← once a test pass is complete. The terminal reboots and restarts your default application.

If an error is found, the Destructive RAM Test stops and displays the error address, the data written to RAM, and the data read from RAM. Note this information and contact your local Intermec service representative.



Caution

If the Destructive RAM Test fails, stop using the terminal. Contact your local Intermec service representative.

Conseil

Si le test Destructive RAM échoue, veuillez ne plus utiliser le terminal. Contactez le représentant du service clientèle Intermec de votre région.

Display Test



Purpose: Use the Display Test screen to make sure that every pixel on the display is working correctly. For example, you may want to test the display if you are not seeing complete characters on the display.

Where Available: Hardware Diagnostics menu

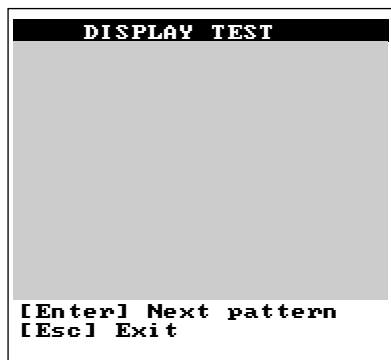
Sample Screen:



242XU.135

Definition: Press  to display each of the four patterns. After 5 seconds, the entire display is filled with the current test pattern. Press  to display the next pattern. The first two patterns appear as a shaded pattern and turn off every other pixel. The third pattern turns on every pixel and appears as a black square. The fourth pattern turns off every pixel and appears as a clear square.

If any of these patterns do not display correctly, you may have a problem with the display. For help, contact your local Intermec service representative.

Hardware Configuration

Purpose: If you are discussing a problem with Intermec, you can use the Hardware Configuration screen to tell the Intermec representative the exact version of hardware on the terminal. You can also use this screen to see the radio frequency and country code that are configured on the terminal.

Where Available: Hardware Diagnostics menu

Sample Screen:

```

HARDWARE CONFIG
Country Code:
USA      (80,01)

Display Type: 0
Display Rev.: 0
Display Cont: 32

Keypad Type : 0
Keypad Rev. : 0
Keypad Table: 0

[Enter] Next screen
[Esc] Exit
    
```

```

HARDWARE CONFIG
PCMCIA Type: 2
PCMCIA Rev.: 1

PCB Rev.   : 1

[Enter] Next screen
[Esc] Exit
    
```

242XU.142

Definition: Press  to display the next screen of hardware information. If you are having a specific problem with one system, such as the radio, note the hardware version on the terminal before contacting your local Intermec service representative.

The country code information on the Hardware Configuration screen is only valid when the radio (Network Activate command) is enabled. If the radio is disabled, the country code information is not valid. For help, see “Network Activate” in Chapter 8.

Keypad Test

Purpose: An application programmer can use the Keypad Test screen to quickly find out the hexadecimal and decimal key code values for any key on the keypad. You can also use the test to make sure the keypad is operating correctly.

Where Available: Hardware Diagnostics menu

Sample Screen:

| KEYPAD TEST | | |
|-------------|-----|---------|
| Key | Hex | Decimal |
| 'a' | 61 | 97 |
| 'b' | 62 | 98 |
| 'c' | 63 | 99 |
| 'd' | 64 | 100 |
| 'e' | 65 | 101 |
| 'f' | 66 | 102 |
| 'g' | 67 | 103 |
| 'h' | 68 | 104 |
| 'i' | 69 | 105 |
| 'j' | 6A | 106 |
| 'k' | 6B | 107 |
| 'l' | 6C | 108 |
| 'm' | 6D | 109 |
| [Esc] Exit | | |

242XU.133

Definition: Press any key on the keypad to display the hexadecimal and decimal value of the key. When you press `[Esc]`, the terminal pauses for a few seconds to display the hexadecimal and decimal values before you exit the screen.

Radio Test

Purpose: Use the Radio Test screen to verify that you have a working radio.

Where Available: Hardware Diagnostics menu

Sample Screen:

```
RADIO TEST

TESTING
Test: PASSED

[Enter] Execute test
[Esc] Exit
```

242XU.138

Definition:

Before you start the test, make sure the radio (Network Activate command) is enabled. If the radio is disabled, the test results on the Radio Test screen are not valid. For help, see “Network Activate” in Chapter 8.

Press  to start the radio test. The results of the test display on the screen once the test is complete. If SUCCESS or PASSED display, the radio is working correctly. If FAILED displays, note the error number. You may have a problem with the radio inside the terminal. For help, contact your local Intermec service representative.



Caution

If the Radio Test fails, stop using the terminal. Contact your local Intermec service representative.

Conseil

Si le test Radio échoue, veuillez ne plus utiliser le terminal. Contactez le représentant du service clientèle Intermec de votre région.

RS-232 Loop Back

Purpose: Use the RS-232 Loop Back test to verify that the hardware for the RS-232 port is functioning correctly.

Note: The RS-232 port will be available in a future model of the TRAKKER 2425 terminal.

Where Available: Hardware Diagnostics menu

Sample Screen:

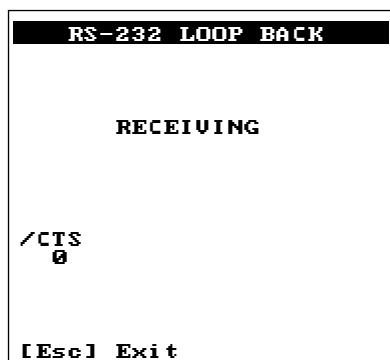

242XU.144

Definition: The RS-232 test begins immediately. If the RS-232 hardware is functioning correctly, the terminal displays WAITING and then RECEIVING. If there is a problem, an error message appears. The status information on the screen is updated every 500 ms.

Note: Once the RS-232 port is available on a future model on the T2425 terminal, you would contact your local Intermec service representative to report an error found during this test.

Scanner Test

Purpose: Use the Scanner Test to make sure the laser scanner, Scan button, or scanner trigger are operating correctly. You can test the standard range scan module or the scanner attached to the module for cabled scanners.

Where Available: Hardware Diagnostics menu

Sample Screen:

```
SCANNER TEST
Press ENTER to turn
the laser on for 3
seconds.

Or, scan a label to
test the laser.

[Enter] Execute test
[Esc] Exit
```

242XU.137

Definition: To start the test, press . If the laser scanner turns on, the scanner is working correctly. If the laser scanner does not turn on, you may have a problem with the scan module or the laser scanner attached to the module for cabled scanners. If you are using a module for cabled scanners, make sure you are using a laser scanner that is supported on the terminal. Also, check to make sure the laser scanner is attached to the module for cabled scanners.

If the laser scanner did turn on in the first test, try scanning a bar code label. To scan a label, press the Scan button on a standard range scan module or pull the trigger on a laser scanner attached to the module for cabled scanners. If the laser scanner turns on, the Scan button or laser scanner trigger is working correctly. If the laser scanner does not turn on, you may have a problem with the Scan button on the terminal or the laser scanner trigger on the attached laser scanner. For help with scanner problems, contact your local Intermec service representative.

Defining the System Diagnostics Screens

Each system diagnostic screen is defined in this section.

Access Point

Purpose: Use the Access Point screen to get version and address information about the 0100 Access Point the terminal is communicating with across the 2.4 GHz network.

Where Available: System Diagnostics menu

Sample Screen:

```
ACCESS POINT
Radio ROM Ver:
V1.6EB
Radio MAC Addr:
0020A6306510
Access Point Name:
SHIPPING
Access Point MAC:
0020A6301365
[Esc] Exit
```

242XU.139

Definition: The screen displays the radio ROM firmware version, radio MAC (machine) address, the access point name, and the access point MAC. If you have a problem with the radio or the connection to the access point, use the information on this screen to troubleshoot your network configuration.

Subsystem Versions

Purpose: If you are discussing a problem with Intermecc, you can use the Subsystem Versions screen to tell the Intermecc representative the exact version of software subsystems loaded on the terminal.

Where Available: System Diagnostics menu

Sample Screen:

| SUBSYSTEM VERSIONS | |
|---------------------|---------|
| Name | Version |
| Network | 000112 |
| RF Driver | 000112 |
| Decodes | 000111 |
| Scanner | 000111 |
| Rdr Cmd Proc | 000112 |
| Term Serv | 000109 |
| Label Task | 000112 |
| TE App | 000110 |
| Display | 000111 |
| Menu System | 000112 |
| [Enter] Next screen | |
| [Esc] Exit | |

242XU.136

Definition: Press  to display the next screen of subsystem information. If you are having a specific problem with one system, note the version loaded on the terminal before contacting your local Intermecc service representative.

Suspend-Resume Test

Purpose: Use the Suspend-Resume Test to test the terminal memory and make sure the memory is being preserved through a suspend and resume cycle.

Where Available: System Diagnostics menu

Sample Screen:

```
SUSPEND-RESUME TEST



Press ENTER to start
After first beep
press I/O.

The unit suspends.
Wait minimum 1 min.
Press I/O to resume.
Unit will beep.

Results are
displayed.

[Enter] Execute test
[Esc] Exit
```

242XU.140

Definition: Press  to start the test. The terminal performs a checksum for each 64K block of memory. After the terminal beeps, press  to suspend. Leave the terminal off for at least 1 minute. If you suspect that a suspend/resume is causing data loss, leave the terminal off for several minutes or even several hours. If there is a problem, the error is easier to detect if the terminal stays in Suspend mode for a longer time. Press  to resume. The terminal again creates a checksum for each 64K block of memory and compares the checksums. The results of the test appear on the screen.

If the CHECKSUMS MATCH message appears, suspend-resume is preserving the terminal memory and there are no problems. If there is a problem, the message CHECKSUM ERROR appears with the 64K block number and the checksum value before and after the test. If you do get an error, contact your local Intermec service representative.



Caution

If the Suspend-Resume Test fails, stop using the terminal. Contact your local Intermec service representative.

Conseil

Si le test Suspend-Resume échoue, veuillez ne plus utiliser le terminal. Contactez le représentant du service clientèle Intermec de votre région.

7

Reader Command Reference

This chapter describes the reader commands that you can use while operating the terminal. Reader commands, such as Backlight On, allow you to perform a task on the terminal.

Using Reader Commands

A reader command causes the terminal to perform a task. Some reader commands temporarily override the configuration settings and some actually change the configuration settings.

For example, you can turn the backlight on to easily view the TRAKKER 2425 terminal's display when you are working in a dimly lit environment. You can execute reader commands by:

- scanning a command from a Code 39 or Code 93 bar code label.
- pressing keys on the keypad or choosing a command from the TRAKKER 2400 Menu System.
- sending a command from a device on the 2.4 GHz network, such as the Model 200 Controller.

There are two general types of reader commands: Accumulate mode commands and operating commands. The reader commands are listed in alphabetical order within these two categories. You will find the purpose, syntax, and bar code labels for each reader command in this chapter.

Using Accumulate Mode

You can use Accumulate mode to collect data from a series of bar code labels and enter them as a single label. When you put the terminal in Accumulate mode, the terminal will collect all scanned bar code labels in the terminal's buffer until you scan either the Enter or Exit Accumulate mode command.

As you accumulate the data from bar code labels, the data is visible on the bottom line of the display. You can edit the accumulated data with the Backspace, Clear, and Enter commands.

Backspace This command deletes the last character from the current data record you are accumulating.

Clear This command deletes the entire data record you are accumulating.

Enter This command will enter data as a record and leaves the terminal in Accumulate mode.

Note: *If you are not in Accumulate mode, the Backspace, Clear, and Enter commands have no effect and you will hear an error beep.*

When you exit Accumulate mode, the accumulated data is "entered" as a data record. Up to 250 characters can be held in the buffer. If the data record count exceeds 250 characters, the data is truncated. If you reset the terminal (software or hardware reset), you exit Accumulate mode, the entire buffer is cleared, and all data accumulated is lost.

To use Accumulate mode

The syntax to use the Enter Accumulate command is:

+/data

where:

+/ is the syntax for the Enter Accumulate mode command.

data is the optional data you want to enter. *Data* can be a reader command that is executed when you exit Accumulate mode.

1. Scan this bar code label to Enter Accumulate mode:

Enter Accumulate Mode



+/

2. Scan the bar code label(s) for the data you want to enter. You can scan labels from the “Full ASCII Bar Code Chart” in Appendix B.

For example, scan this label to change the terminal’s configuration and set the preamble to the characters ABC.

Change Configuration / Set Preamble to ABC



\$+ADABC

Or, to edit the accumulated data, scan one of these bar code labels:

Backspace



-+

Clear



-_

Enter



**

Note: You can create one bar code label by combining Steps 1 and 2 above. Most of the examples in this manual use one bar code label.

3. Scan this bar code label to exit Accumulate mode and enter the data record.

Exit Accumulate Mode



-/

Enter Accumulate Mode

- Purpose:** Enters Accumulate mode. If you press any keys when using the Enter Accumulate command, the keystrokes are accumulated as data.
- From Network:** Not supported
- Keypad:** Not supported
- Scan:** Enter Accumulate Mode

+/

Backspace

- Purpose:** Deletes the last character from the current data record being accumulated. If there is no data in the buffer, the command has no effect.
- From Network:** Not supported
- Keypad:** Not supported
- Scan:** Backspace

-

Clear

- Purpose:** Deletes the entire data record you are accumulating. If there is no data in the buffer, the command has no effect.
- From Network:** Not supported
- Keypad:** Not supported
- Scan:** Clear

_

Enter

Purpose: Enters the current data record and remains in Accumulate mode. If no data exists, a null string is entered.

From Network: Not supported

Keypad: Not supported

Scan: Enter



**

Exit Accumulate Mode

Purpose: Exits Accumulate mode and transmits the current data record. If no data has been accumulated, an empty data record is entered.

From Network: Not supported

Keypad: Not supported

Scan: Exit Accumulate Mode



_/

Operating Reader Commands

The reader commands you can use to operate or change the terminal's configuration are listed in this section. The operating commands are listed in alphabetical order. You will find the purpose, syntax, and bar code labels for these reader commands in this section.

- Backlight On and Off
- Change Configuration
- Default Configuration
- Multiple-Read Labels
- Reset Firmware
- Scanner Trigger On and Off
- Test and Service Mode

Backlight On and Off

Purpose: Turns the backlight on to easily view the terminal display in dimly lit environments.

From Network: % . 1

Keypad: Press  to turn the backlight on or off.

Scan: Backlight On



%.1

Purpose: Turns the backlight off.

From Network: % . 0

Keypad: Press  to turn the backlight on or off.

Scan: Backlight Off



%.0

Note: You can use the command % . to toggle the backlight on and off.

Change Configuration

Purpose: This command must precede any configuration command parameter. If you enter a valid string, the terminal configuration parameters are modified and the terminal sounds a high beep. For help on the configuration commands, see Chapter 8, "Configuration Command Reference."

From Network: `$+command[command]...[command n]`
where *command* is a configuration command and the value you want to set.

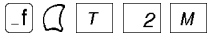
Keypad:  to access the TRAKKER 2400 Menu System. From the Main Menu, choose the Configuration Menu to change the terminal's configuration.

Example: Change Configuration / Turn Off Beep Volume



S+BVO

The change configuration command is followed by the configuration command to turn off the beep volume (BV0).

Default Configuration

Purpose: Sets the terminal to its default configuration, resets the firmware, boots the terminal, and starts your terminal emulation or screen mapping application. The default configuration for the terminal is listed in Appendix A. For help, see “Restoring the Terminal’s Default Configuration” in Chapter 3.

When you use the Default Configuration command, the default configuration is saved in RAM and flash memory. The runtime and boot configuration are changed to the default configuration.

***Note:** When you use the Default Configuration command, the Primary Network parameters are set to the default values. The terminal will no longer have a valid IP address and cannot communicate with other devices. You need to configure the terminal again. For help, see Chapter 4, “Operating the Terminal in a Network.”*

From Network: . +

Keypad: In the TRAKKER 2400 Menu System, choose System Menu and then choose Load Default Values.

Scan: Default Configuration



.+

***Note:** You will not hear a beep after scanning the Default Configuration label.*

Multiple-Read Labels

Purpose: A multiple-read label is a Code 39 or Code 93 bar code label that has a space as the first character after the start code. The terminal stores a multiple-read label in the buffer until you execute a command to transmit the label or scan a regular label. A regular bar code label is executed as soon as you scan it.

If you use a configuration command or the TRAKKER 2400 Menu System to disable multiple-read labels, the terminal processes the bar code label as a regular label and reads and decodes the space as data.

From Network: Not supported

Keypad: Not supported

Label Syntax: <Start Code><SP>*data*<Stop Code>

where <SP> is the ASCII space character and *data* is the content of the label.

Example: Multiple-read bar code label



* A*

After you scan a multiple-read bar code label, the accumulated data appears on the bottom line of the terminal display. You can use the Accumulate mode commands, such as Backspace or Clear, to accumulate data. Once you scan a non-multiple-read label, the data is entered.

Reset Firmware

Purpose: Resets all firmware on the terminal, resets the terminal emulation or screen mapping application, and starts the application. You can use the Reset command to restart your application if you are having problems.

Note: You can also try resetting the hardware if your application or terminal is locked up and the terminal will not respond to any other commands. For help, see “Booting and Resetting the Terminal” in Chapter 6.

From Network: - .

Keypad: Not supported

Scan: Reset Firmware



_

Scanner Trigger On and Off

The Scanner Trigger On and Off commands are the same as pushing and releasing the Scan button on the keypad. The Scan button and Scanner Trigger commands control the integrated scanner on a standard range scan module.

Note: *The Scanner Trigger On and Off commands do not activate the scanner device connected to the module for cabled scanners.*

After a Scanner Trigger On command, the scanner operates differently depending on the Scanner mode and scanner trigger configuration settings:

- If you configure the terminal to use One-Shot Scanner mode and level triggering, the scanner automatically turns off after a good read of a bar code label, or after the scanner timeout period elapses.
- If you configure the terminal to use Automatic Scanner mode and level triggering, the scanner remains on after a good read of a bar code label. You can use the Scanner Trigger Off command to turn off the scanner, or set the Scanner Timeout command to automatically turn off the scanner after it stays on for the period of time set.



For help on configuring the Scanner Mode or Scanner Trigger commands, see Chapter 8, "Configuration Command Reference."

Note: *Intermec does not recommend that you use a Scanner Trigger On or Off command with the Scanner Trigger command set to edge triggering.*

| | |
|----------------------|--|
| Purpose: | The Scanner Trigger On command is the same as pushing the Scan button. |
| From Network: | / . |
| Keypad: | Not supported |
| Scan: | Not supported |

| | |
|----------------------|---|
| Purpose: | The Scanner Trigger Off command is the same as releasing the Scan button. Its effect depends on the Scanner and Trigger mode configuration settings as described earlier. |
| From Network: | /% |
| Keypad: | Not supported |
| Scan: | Not supported |

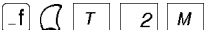
Test and Service Mode

| | |
|----------------------|---|
| Purpose: | Starts the TRAKKER 2400 Menu System. From the Main Menu, the Diagnostics Menu is the Test and Service mode you can use to run software, hardware, and system diagnostics on the terminal. For help, see “Running Diagnostics” in Chapter 6. |
| From Network: | ..-. |
| Keypad: |  |
| Scan: | Test and Service Mode  *..-.* |

Configuration Command Reference

This chapter is an alphabetical list of all the configuration commands supported on the terminal.

Using Configuration Commands

A configuration command changes the way the terminal operates. For example, you can change the Beep Volume and make the terminal beep very loud in a noisy environment. You can execute configuration commands by:

- scanning a command from a Code 39 or Code 93 bar code label.
- choosing a command from the TRAKKER 2400 Menu System.
- sending a command from a device on the 2.4 GHz network, such as the Model 200 Controller or a host computer.

Note: *If you are working in the TRAKKER 2400 Menu System, you cannot scan configuration commands. Exit the menu system to scan configuration commands.*

You can find the following information about each configuration command in this chapter:

- Command description and purpose
- Default setting
- Command syntax and options
- Bar code labels you can scan to set or change each command

The configuration commands are listed alphabetically by command name. For a list of bar code symbology, network communications, or operations commands, use the next table, “Configuration Commands Listed by Category.” If you want to look up a command by its syntax, see the “Configuration Commands by Syntax” list in Appendix A.

Note: *The Code 39 bar code labels in this chapter show an asterisk (*) at the beginning and end of the human-readable interpretation to represent the start and stop codes. If you are creating your own Code 39 bar code labels, your bar code printing utility may automatically supply the asterisks as the start/stop code.*

Configuration Commands Listed by Category

This chapter lists the configuration commands in alphabetical order. Use this next list to find the configuration commands you may need to set for bar code symbologies, network communications, and operations.

Bar Code Symbologies

Codabar, 8-10
Code 11, 8-12
Code 16K, 8-13
Code 2 of 5, 8-14
Code 39, 8-16
Code 49, 8-20
Code 93, 8-22
Code 128, 8-23
Interleaved 2 of 5, 8-37
MSI, 8-41
Plessey, 8-45
UPC/EAN, 8-70

Network Communications

Controller IP Address, 8-29
Default Router, 8-32
Network Activate, 8-43
Network Loopback, 8-44
RF Domain, 8-51
RF Security Identification, 8-52
RF Wakeup On Broadcast, 8-54
Subnet Mask, 8-62
Terminal IP Address, 8-64
UDP Port, 8-68

Operations

Append Time, 8-6
Automatic Shutoff, 8-7
Beep Volume, 8-8
Command Processing, 8-25
Decode Security, 8-31
Display Backlight Timeout, 8-34
Display Contrast, 8-36
Keypad Caps Lock, 8-39
Keypad Clicker, 8-40
Postamble, 8-46
Preamble, 8-48
Resume Execution, 8-50
Scan Ahead, 8-55
Scanner Mode, 8-56
Scanner Redundancy, 8-57
Scanner Selection, 8-59
Scanner Timeout, 8-60
Scanner Trigger, 8-61
Time and Date, 8-66
Time in Seconds, 8-67

Entering Variable Data in a Configuration Command

You can enter variable data for many of the configuration commands. For example, you can set a preamble that is up to 25 ASCII characters long. You need to follow these general instructions to enter variable data.

To enter variable data in a configuration command

1. Scan a bar code label with this syntax:

`+/$+command`

where:

`+/` is the syntax for the Enter Accumulate Mode command.

`+$` is the syntax for the Change Configuration command.

`command` is the syntax for the command you want to change.

For example, the command syntax for a preamble is `ADdata`. To change or set a preamble, scan this bar code:

Enter Accumulate Mode / Change Configuration / Set Preamble



`*+/$+AD*`

2. Scan a bar code label from the “Full ASCII Bar Code Chart” in Appendix B. To set the preamble to the character T, scan this label:

T



`*T*`

Note: To use the bar code labels in Appendix B, you must configure the terminal to use Code 39 in Full ASCII mode. For help, see “Code 39” later in this chapter.

Entering Variable Data in a Configuration Command (continued)

3. Scan the Exit Accumulate Mode bar code label to update the terminal's configuration:

Exit Accumulate Mode



_/

Append Time

Purpose: Appends the time to data records that are transmitted from the terminal. You can also use the Time in Seconds command to append the time in hours and minutes only, or hours, minutes, and seconds. The time is appended to each data record in the form HH:MM:SS. For help, see "Time in Seconds" later in this chapter.

Default: Disabled

Syntax: DE*data*

Acceptable values for *data* are:

0 Disabled

1 Enabled

Scan: One of these bar codes:

Disable Append Time



\$+DE0

Enable Append Time



\$+DE1

Automatic Shutoff

Purpose: Defines the maximum length of time the terminal remains on when there is no activity. When you do not use the terminal for the length of time set with this command, the terminal automatically turns off as if you had pressed ⓪ to turn it off.

When you press ⓪ to turn on the terminal, the terminal either resumes exactly where it was when you turned it off, or the terminal boots and restarts your application. Resume is controlled through the Resume Execution command. For help, see “Resume Execution” later in this chapter.

Power Management Tip: You should use the Automatic Shutoff feature to preserve the main battery pack’s power.

Default: 0 (disabled)

Syntax: EZdata

Acceptable values for *data* are:

| | |
|-------|-------------------------|
| 0 | Disabled (always on) |
| 02-75 | Shutoff time in minutes |

Scan: To disable automatic shutoff, scan this bar code:

Disable Automatic Shutoff



S+EZ0

Or: To set a timeout:

1. Scan this bar code:

Enter Accumulate Mode / Set Automatic Shutoff



+/\$+EZ

Automatic Shutoff (continued)

2. Scan a numeric value for *data* from these bar codes:



0



1



2



3



4



5



6



7



8



9

3. Scan this bar code:

Exit Accumulate Mode



./

Beep Volume

Purpose: Adjusts the volume of the terminal's audio signals. For a list of all the beep sounds and audio signals, see "Understanding the Terminal's Audio Signals" in Chapter 2. Set the beep volume according to operator preference and work environment.

Default: Normal

Syntax:

BV data

Acceptable values for *data* are:

- 0 Off
- 1 Quiet
- 2 Normal
- 3 Loud
- 4 Very loud
- 8 Lower volume
- 9 Raise volume

Scan:

One of these bar codes:

Off



S+BV0

Quiet



S+BV1

Normal



S+BV2

Loud



S+BV3

Very Loud



S+BV4

Or:

Scan one of these bar codes repeatedly to achieve the desired volume:

Raise Beep Volume



S+BV9

Lower Beep Volume



S+BV8

Codabar

Purpose: Enables or disables decoding of Codabar symbology. Codabar is a self-checking, discrete symbology. The American Blood Commission (ABC) Codabar requires that you retain and transmit the start/stop code digits when processing a Codabar symbol. As a result, configuration CD10 is an illegal configuration.

Default: Disabled

Syntax: *CDdata*

Acceptable values for *data* must be two digits, corresponding to:

| Digit | Value | Description |
|--------|-------|-----------------------------|
| First | 0 | Disabled |
| | 1 | ABC |
| | 2 | Standard |
| Second | 3 | Concatenated |
| | 0 | Discard Start/Stop |
| | 1 | Transmit ABCD Start/Stop |
| | 2 | Transmit DC1-DC4 Start/Stop |

Scan: One of these bar codes:

Disabled, Discard Start/Stop



\$+CD00

ABC, Transmit ABCD Start/Stop



\$+CD11

ABC, Transmit DC1-DC4 Start/Stop



\$+CD12

Standard, Discard Start/Stop



\$+CD20

Standard, Transmit ABCD Start/Stop



\$+CD21

Standard, Transmit DC1-DC4 Start/Stop



\$+CD22

Concatenated, Discard Start/Stop



S+CD30

Concatenated, Transmit ABCD Start/Stop



S+CD31

Concatenated, Transmit DC1-DC4 Start/Stop



S+CD32

Code 11

Purpose: Enables or disables decoding of Code 11 symbology. Code 11 is a very high density, discrete numeric bar code. It is most extensively used in labeling telecommunications components and equipment.

Default: Disabled

Syntax: *CGdata*

Acceptable values for *data* are:

- 0 Disabled
- 1 Code 11 enabled with one check digit
- 2 Code 11 enabled with two check digits

Scan: One of these bar codes:

Disable Code 11



S+CG0

Code 11 Enabled With One Check Digit



S+CG1

Code 11 Enabled With Two Check Digits



S+CG2

Code 16K

Purpose: Enables or disables decoding of Code 16K symbology. Code 16K is a two-dimensional (stacked rows), high density bar code. It is based on Code 128 and is used widely to label unit-dose packaging for the healthcare industry.

Default: Disabled

Syntax: *CPdata*

Acceptable values for *data* are:

- 0 Disabled
- 1 Standard Code 16K enabled
- 2 Code 16K enabled with Function Code 1

When you enable Code 16K with Function Code 1, the terminal decodes the bar code label and checks for a Function Code 1 in the first data character position. If a Function Code 1 is the first character, the terminal substitutes this Code 16K symbology identifier string for the Function Code 1 character.

]K1

Scan: One of these bar codes:

Disable Code 16K



S+CP0

Standard Code 16K Enabled



S+CP1

Code 16K Enabled With Function Code 1



S+CP2

Code 2 of 5

Purpose: Enables or disables decoding of Code 2 of 5 symbology. Code 2 of 5 uses the bars to encode information and the spaces to separate the individual bars. This code is discrete and self-checking. You can only enable Code 2 of 5 if the Interleaved 2 of 5 (I 2 of 5) code is disabled. If you enable I 2 of 5, Code 2 of 5 is automatically disabled.

Default: Disabled

Syntax: *CCdata*

where *data* consists of three digits as follows:

| | | |
|--------------------------|-------|-------------------------------|
| First digit: | 0 | Code 2 of 5, 3 Bar Start/Stop |
| | 1 | Code 2 of 5, 2 Bar Start/Stop |
| Second and third digits: | 00 | Disable Code 2 of 5 |
| | 01-32 | Label Length |

Scan: To disable Code 2 of 5, scan this bar code:

Disable Code 2 of 5



\$+CC00

Or: To enable Code 2 of 5:

1. Scan one of these bar codes:

Code 2 of 5, 3 Bar Start/Stop



+/\$+CC0

Code 2 of 5, 2 Bar Start/Stop



+/\$+CC1

2. Scan a two-digit numeric value to set the label length (01-32) from these bar codes.



0



1



2



3



4



5



6



7



8



9

3. Scan this bar code:

Exit Accumulate Mode



_./

Code 39

Purpose: Enables or disables decoding of Code 39 symbology. Code 39 is discrete, variable length, and self-checking. The character set is uppercase A to Z, 0 to 9, dollar sign (\$), period (.), slash (/), percent (%), space (), plus (+), and minus (-).

There are three types of ASCII the terminal decodes:

- Code 39 non-full ASCII
- Code 39 full ASCII
- Code 39 mixed-full ASCII

Code 39 non-full ASCII Non-full ASCII uses a one-character encoding scheme. For example, you encode the data "SAMPLE" as follows:



SAMPLE

This label decodes as *SAMPLE*.

Code 39 full ASCII Full ASCII uses a two-character encoding scheme to extend the character set to 128 characters. You use the dollar sign (\$), slash (/), percent (%), or plus (+) followed by an uppercase letter to represent one of the characters in the extended set. You must encode lowercase letters as a plus sign (+) followed by their uppercase equivalents. For a list of ASCII characters and their Code 39 representations, see the "Full ASCII Table" in Appendix B.

Use Code 39 full ASCII to enter ASCII control characters or lowercase characters as data. You should also enable Code 39 full ASCII to use ASCII command characters.

For example, you encode the data "sample" in Code 39 full ASCII as follows:



+S+A+M+P+L+E

In Code 39 non-full ASCII, this label decodes as *+S+A+M+P+L+E*. In Code 39 full ASCII, this label decodes as *sample*.

Code 39 mixed-full ASCII Use mixed-full ASCII when printers encode the same label two different ways. For example, if you have a bar code with the data \$%a, some printers encode the data as follows:



`*/D/E+A*`

In the Full ASCII Table in Appendix B, /D represents \$ and /E represents %. If you configure the terminal for Code 39 full ASCII, the terminal decodes the data as \$%a because there are three valid full ASCII character pairs to represent the data.

Other printers encode the data \$%a as:



`*$%+A*`

The \$ and % are valid Code 39 characters in the non-full ASCII character set. However, the terminal will not decode this label if it is configured for full ASCII, because the data is not represented by valid full ASCII character pairs. To decode the label correctly, you need to configure the terminal for mixed-full ASCII.

When you configure the terminal for Code 39 mixed-full ASCII, the terminal will decode both of the labels above as \$%a.

Mixed-full ASCII interprets any valid full ASCII character pairs that appear in the label, but does not require that all data be encoded with a valid full ASCII character pair. If you are uncertain how your labels are encoded, configure the terminal for mixed-full ASCII, which decodes all valid Code 39 labels.

If you configure the terminal for Code 39 full ASCII, you should check for Code 39 mixed-full ASCII. Mixed-full ASCII does not apply when you configure the terminal for non-full ASCII.

Note: *The interpretive text shown under bar code labels does not always accurately reflect the data that is encoded in the label. The interpretive text represents how the label should be decoded.*

Code 39 (continued)

Use this table to help configure your terminal.

| Code 39 Option | Bar Code Label | Decodes |
|------------------|-----------------|-------------------|
| Non-full ASCII | \$%+A /D/E+A | \$%+A /D/E+A |
| Full ASCII | \$%+A /D/E+A | No decode \$%a |
| Mixed-full ASCII | \$%+A /D/E+A | \$%a \$%a |

Default: Enable Code 39 Full ASCII with no check digit (111)

Syntax: *CBdata*

Acceptable values for *data* must be three digits, corresponding to:

| | | |
|---------------|---|---------------------------------|
| First digit: | 0 | Disabled |
| | 1 | Enabled with no check digit |
| | 2 | Enabled with check digit |
| | 3 | HIBC (Health Industry Bar Code) |
| | 4 | With AIAG check digit |
| Second digit: | 0 | Discard check digit |
| | 1 | Transmit check digit |
| Third digit: | 0 | Code 39 non-full ASCII |
| | 1 | Code 39 full ASCII |
| | 2 | Code 39 mixed-full ASCII |

Note: *Selecting HIBC Code 39 automatically sets the configuration to non-full ASCII with the check digit transmitted.*

Scan: To disable Code 39:

Disable Code 39



\$+CB0

Or:

To enable Code 39:

1. Scan this bar code:

Enter Accumulate Mode / Enable Code 39



+/\$+CB

2. Scan one of these bar codes to set the first digit:

Without a Check Digit



1

With a Check Digit



2

HIBC Code 39



3

With AIAG Check Digit



4

3. Scan one of these bar codes to set the second digit:

Discard Check Digit



0

Transmit Check Digit



1

4. Scan one of these bar codes to set the third digit:

Code 39 Non-Full ASCII



0

Code 39 Full ASCII



1

Code 39 Mixed-Full ASCII



2

5. Scan this bar code:

Exit Accumulate Mode



-/

Code 49

Purpose: Enables or disables decoding of Code 49 symbology. Code 49 is a multirow symbology for high data density. The last character in each row is used for row checking and the last two characters of the symbol are used for overall checking.

Function codes designate where to place the predefined data string in a Code 49 label. Whenever a terminal encounters a function code, it replaces the function code with the defined string before transmitting the data to the Model 200 Controller. A single Code 49 symbol may contain several different variable length data fields. Function Code 1 (F1) identifies a data system. Function Code 2 (F2) indicates the end of a data field.

Default: Disabled

Syntax:

| | |
|---------------|-----------------|
| <i>CJdata</i> | Code 49 |
| <i>CKdata</i> | Function Code 1 |
| <i>CLdata</i> | Function Code 2 |
| <i>CMdata</i> | Function Code 3 |

Acceptable values for *data* are:

| | | |
|----------|---|----------|
| Code 49: | 0 | Disabled |
| | 1 | Enabled |

Function Code 1: Any two ASCII characters.

Function Code 2: Any four ASCII characters

Function Code 3: Any two ASCII characters

Scan: One of these bar codes:

Disable Code 49



S+CJ0

Enable Code 49



S+CJ1

Scan: To disable any of the function codes, scan one of these bar codes:

Disable Function Code 1



S+CK

Disable Function Code 2



S+CL

Disable Function Code 3



S+CM

Or: To set one of the function codes to a character string:

1. Scan one of these bar codes:

Enter Accumulate Mode / Set Function Code 1



+/\$+CK

Enter Accumulate Mode / Set Function Code 2



+/\$+CL

Enter Accumulate Mode / Set Function Code 3



+/\$+CM

2. Scan any character from the “Full ASCII Bar Code Chart” in Appendix B. You can define two characters each for Function Codes 1 and 3, and four characters for Function Code 2.
3. Scan this bar code:

Exit Accumulate Mode



-/

Code 93

Purpose: Enables or disables decoding of Code 93 symbology. Code 93 is a variable length, continuous symbology that uses four element widths.

Default: Disabled

Syntax: *CFdata*

Acceptable values for *data* are:

- 0 Disabled
- 1 Enabled

Scan: One of these bar codes:

Disable Code 93



S+CF0

Enable Code 93



S+CF1

Code 128

Purpose: Enables or disables decoding of Code 128 symbology. Code 128 is a very high density alphanumeric symbology that supports the extended ASCII character set. It is a variable length, continuous code that uses multiple element widths.

Default: Standard

Syntax: CH*data*

Acceptable values for *data* are:

- 0 Disabled
- 1 Standard Code 128
- 2 UCC/EAN Code 128

Scan: One of these bar codes:

Disable Code 128



S+CH0

Enable Standard Code 128



S+CH1

Enable UCC/EAN Code 128



S+CH2

Code 128 (continued)

Notes:

If you configure Standard Code 128, the terminal will not decode Function Code 1 characters in the first position of a bar code label. Any subsequent Function Code 1 characters are translated to the ASCII GS character as a separator for variable length fields.

If you configure UCC/EAN Code 128, the terminal will decode a bar code label as Standard Code 128 unless one of the first two characters are a start character and a Function Code 1. In this case, the bar code label is processed as described next:

1. The Function Code 1 character is not transmitted.
2. The three symbology ID characters,]C1, are transmitted.
3. The remaining Code 128 characters are decoded as Standard Code 128.

Command Processing

Purpose: Command processing allows you to disable or enable reader commands. For example, you can disable the Backlight command. There are two ways to enable or disable reader commands:

- Use the Command Processing configuration command described here.
- Use the Reader Command Menu option in the Configuration Menu of the TRAKKER 2400 Menu System.

You may want to disable reader commands to prevent a user from accidentally entering a command, or to use data that would otherwise be treated as a command. Any Code 39 or Code 93 bar code label that contains the 2 to 4-character commands listed at the end of this section is treated as a reader command unless the command is disabled.

If you want to disable or enable several commands, it is easier to use the menu system. For help, see Chapter 3, “Configuring the Terminal.” For a description of each reader command that you can enable or disable with Command Processing, see Chapter 7, “Reader Command Reference.”

Default: All reader commands enabled

Syntax: `DCdata`

Acceptable values for *data* are:

| | |
|-----------------------|-----------------------------|
| 0 | Disable all reader commands |
| 1 | Enable all reader commands |
| 2 | Disable override |
| 3 | Enable override |
| <code>command0</code> | Disable reader command |
| <code>command1</code> | Enable reader command |

The override option is a temporary setting that allows you to enable all the reader commands for as long as you need them. When you want to return to the previous configuration, you disable the override.

Note: *The Enable Override option is the only bar code label you can scan to enable reader commands if you have disabled all reader commands (DC0). You can also enable reader commands in the TRAKKER 2400 Menu System.*

Command Processing (continued)

Scan: To enable all the reader commands or override the current settings, scan one of these bar codes:

Disable All Reader Commands



\$+DC0

Enable All Reader Commands



\$+DC1

Disable Override



\$+DC2

Enable Override



\$+DC3

Or: To disable or enable specific reader commands, perform these steps:

1. Scan this bar code:

Enter Accumulate Mode / Command Processing



+/\$+DC

2. Scan the bar code to disable or enable one reader command.

Note: If there are two bar codes for a reader command, you must scan them in order, left to right. Accumulate mode commands are separated into two bar codes so that the command can be accumulated rather than executed as a command.

Backspace



_

(continued)



+

Backlight



%.

Change Configuration



\$+

Clear



_

(continued)



_

Default Configuration



.

Enter Accumulate Mode



+

(continued)



/

Exit Accumulate Mode



_

(continued)



/

Reset



_

Scanner Trigger Off



/%

Scanner Trigger On



/

Test and Service Mode



..

3. Scan one of these bar codes:

Disable the Command



0

Enable the Command



1

4. Repeat Steps 2 and 3 to disable or enable another reader command.

Note: You can accumulate up to 250 characters in the buffer. If the data accumulated exceeds 250 characters, you will hear an error beep and the terminal will reject the last bar code read.

Command Processing (continued)

5. Scan this bar code:

Exit Accumulate Mode



-/

Or:

To disable or enable the ability to scan multiple-read labels, scan one of these bar codes:

Disable Multiple-Read Labels



\$+DC 0

Enable Multiple-Read Labels



\$+DC 1

Controller IP Address

Purpose: Defines the IP address assigned to the Model 200 Controller in your 2.4 GHz network. An IP address is a network level address you assign to each device in a TCP/IP network. The controller IP address you set on the TRAKKER 2425 terminal must match the address that is set on the controller.

Default: 0.0.0.0

Syntax: NC*n.n.n.n*

where each *n* address segment is a number from 0 to 255. The controller IP address field consists of four separate numbers, each separated by a period.

Note: *The network cannot be activated if the first address segment in the IP address is set to 0, 127, or a number greater than 223.*

Scan: To set the default controller IP address, scan this bar code:

Default Controller IP Address



\$+NC0.0.0.0

Or: To set the controller IP address:

1. Scan this bar code:

Enter Accumulate Mode / Set Controller IP Address



+/\$+NC

2. Scan a numeric value from 0 to 255 to set an *n* field of the controller IP address from these bar codes.



0



1

Controller IP Address (continued)



2



3



4



5



6



7



8



9

3. Scan this bar code:

. (Period)



.

4. Repeat Steps 2 and 3 to set the next two numbers in the controller IP address field. After you scan the last address segment, go to Step 5. Do **not** scan the period after the last address segment.

5. Scan this bar code:

Exit Accumulate Mode



-/

Decode Security

Purpose: Defines the security level to use when decoding bar codes. When you select a lower decode security level, the terminal can decode bar codes with poorer print quality.

Note: Only use the low parameter as a temporary solution until you can improve the bar code label print quality.

Default: Moderate

Syntax: *CSdata*

Acceptable values for *data* are:

- 0 Low
- 1 Moderate
- 2 High

Scan: One of these bar codes:

Low Decode Security



S+CS0

Moderate Decode Security



S+CS1

High Decode Security



S+CS2

Default Router

Purpose: Defines the IP address assigned to the default router in your 2.4 GHz network. The router provides a software and hardware connection between two or more networks that permits traffic to be routed from one network to another on the basis of the intended destinations of that traffic.

When the Model 200 Controller is on a different subnetwork than the T2425 terminal, you need to set the IP address assigned to the default router. The terminal uses the router address to send packets across the network to the controller. The default of 0.0.0.0 means there is no default router.

Default: 0.0.0.0

Syntax: NXn.n.n.n

where each *n* address segment is a number from 0 to 255. The default router address field consists of four separate numbers, each separated by a period.

Note: The network cannot be activated if the first address segment in the IP address is set to 0, 127, or a number greater than 223.

Scan: To set the default value for the default router, scan this bar code:

Default Router



\$+NX0.0.0.0

Or: To set the default router address:

1. Scan this bar code:

Enter Accumulate Mode / Set Default Router



+/\$+NX

- Scan a numeric value from 0 to 255 to set an *n* field of the default router address from these bar codes.



0



1



2



3



4



5



6



7



8



9

- Scan this bar code:

. (Period)



.

- Repeat Steps 2 and 3 to set the next two numbers in the default router address field. After you scan the last address segment, go to Step 5. Do **not** scan the period after the last address segment.

- Scan this bar code:

Exit Accumulate Mode



_/

Display Backlight Timeout

Purpose: Defines the amount of time the backlight remains on. The backlight timeout setting significantly affects the terminal's battery life. If you set a longer backlight timeout value, you will use the power in the main battery pack at a faster rate.

Default: 10 seconds

Syntax: DF*data*
Acceptable values for *data* are:

00 Disabled
01 - 60 Timeout in seconds

Scan: To disable the backlight timeout, scan this bar code:

Disable Backlight Timeout



S+DF00

Or: To set the backlight timeout:

1. Scan this bar code:

Enter Accumulate Mode / Set Backlight Timeout



+/\$+DF

2. Scan a two-digit numeric value for *data* from these bar codes.



0



1



2



3



4



5



6



7



8



9

3. Scan this bar code:

Exit Accumulate Mode



_/

Display Contrast

Purpose: Defines the contrast (light or dark) of the characters against the terminal display.

Default: 3

Syntax: *DJdata*
Acceptable values for *data* are 0 (light) to 7 (dark).

Scan: One of these bar codes:

0 - Light



S+DJ0

1



S+DJ1

2



S+DJ2

3 - Maximum Contrast



S+DJ3

4



S+DJ4

5



S+DJ5

6



S+DJ6

7 - Dark



S+DJ7

Lighter



S+DJ8

Darker



S+DJ9

Interleaved 2 of 5

Purpose: Enables or disables decoding of Interleaved 2 of 5 (I 2 of 5) symbology. I 2 of 5 is a high-density, self-checking, continuous numeric symbology. It is mainly used in inventory distribution and the automobile industry.

Enabling I 2 of 5 automatically disables Code 2 of 5.

Default: Disabled

Syntax: *CAdata*

Acceptable values for *data* are:

| | |
|------|--|
| 0 | Disabled |
| 2-32 | Fixed length (even number only) |
| 97 | Variable length without a check digit |
| 98 | Case code (6 or 14) with a check digit |
| 99 | Variable length with a check digit |



Caution

Using the variable length without a check digit configuration option can cause substitution errors.

Conseil

Des erreurs de substitution peuvent survenir si vous utilisez la longueur variable sans option de vérification de configuration de chiffres.

Scan: One of these bar codes:

Disable Interleaved 2 of 5



S+CA0

Enable Variable Length Without a Check Digit



S+CA97

Interleaved 2 of 5 (continued)

Enable Variable Length With a Check Digit



\$+CA99

Enable Interleaved 2 of 5, Case Code



\$+CA98

Or:

To set Interleaved 2 of 5 to a fixed length:

1. Scan this bar code:

Enter Accumulate Mode / Set Fixed Length



+/\$+CA

2. Scan a numeric value for *data* from these bar codes. (Use even numbers 2-32 only)



0



1



2



3



4



6



8

3. Scan this bar code:

Exit Accumulate Mode



-/

Keypad Caps Lock

Purpose: Turns the caps lock on and off. With the caps lock turned on, all alphabetic characters you type on the keypad will be uppercase or capital letters.

Default: Caps lock off

Syntax: *KAdata*

Acceptable values for *data* are:

- 0 Caps lock off
- 1 Caps lock on

Scan: One of these bar codes:

Caps Lock Off



S+KA0

Caps Lock On



S+KA1

Keypad Clicker

Purpose: Enables or disables the keypad clicks. The terminal sounds a click each time you press a key or decode a row of a two-dimensional symbology.

Default: Enabled

Syntax: *KCdata*
Acceptable values for *data* are:
0 Disable keypad clicker
1 Enable keypad clicker

Scan: One of these bar codes:

Disable Keypad Clicker



S+KC0

Enable Keypad Clicker



S+KC1

MSI

Purpose: Enables or disables decoding of MSI symbology. MSI code is similar to Plessey code. MSI code includes a start pattern, data characters, one or two check digits, and a stop pattern.

Default: Disabled

Syntax: *CNdata*

Acceptable values for *data* are:

| | | |
|---------------|---|--------------------------|
| First digit: | 0 | Disabled |
| | 1 | No check digits |
| | 2 | 1 modulus 10 check digit |
| | 3 | 2 modulus 10 check digit |
| Second digit: | 0 | Discard check digit |
| | 1 | Transmit check digit |

Scan: One of these bar codes:

Disable MSI



S+CN00

MSI Without Check Digits



S+CN10

MSI With 1 Modulus 10 Check Digit, Discard Check Digit



S+CN20

MSI With 1 Modulus 10 Check Digit, Transmit Check Digit



S+CN21

TRAKKER Antares 2425 Hand-Held Terminal User's Manual

MSI (continued)

MSI With 2 Modulus 10 Check Digits, Discard Check Digits



\$+CN30

MSI With 2 Modulus 10 Check Digits, Transmit Check Digits



\$+CN31

Network Activate

Purpose: Enables or disables network communications between the TRAKKER 2425 terminal and other devices in the 2.4 GHz network. When you enable this parameter, the terminal attempts to establish communications with the Model 200 Controller. When you disable this parameter, the network is disabled, no RF communications are provided, and the radio is turned off.

Note: You must enable the Network Activate parameter to use the terminal for data collection.

Default: Disabled

Syntax: `NAdata`

Acceptable values for *data* are:

| | |
|---|------------------------------|
| 0 | Disabled |
| 1 | 2.4 GHz RF network (enabled) |

Scan: One of these bar codes:

Disable Network Activate



S+NA0

Enable 2.4 GHz RF Network



S+NA1

Network Loopback

Purpose: Transmits all messages received from the Model 200 Controller back to the controller. Messages received by the radio are not passed on to the terminal applications unless they are configuration commands. Messages continue to be looped back to the controller as long as this feature is enabled. Messages originating from the terminal are still transmitted to the controller.

Use the Network Loopback parameter to troubleshoot RF communications problems.

Default: Disabled

Syntax: *NLdata*

Acceptable values for *data* are:

0 Disabled
1 Enabled

Scan: One of these bar codes:

Disable Network Loopback



S+NL0

Enable Network Loopback



S+NL1

Plessey

Purpose: Enables or disables decoding of Plessey symbology. Plessey code is pulse-width modulated like most other bar codes. It includes a start character, data characters, an eight-bit cyclic check digit, a termination bar, and usually a reverse start character. The code is continuous and not self-checking. You need to configure two parameters for Plessey code: Start Code and Check Digit.

Default: Disabled

Syntax: *CIdata*

Acceptable values for *data* are:

00 Disabled
 10 Plessey with reverse start code
 30 Transmit check digit
 31 Discard check digit

Scan: To disable Plessey:

Disable Plessey



\$+CI00

Or: To set Plessey, complete these steps:

1. Scan this bar code:

Plessey With Reverse Start Code



\$+CI10

2. Scan one of these bar codes to transmit or retain the check digit:

Transmit Check Digit



\$+CI30

Discard Check Digit



\$+CI31

Postamble

Purpose: Sets the postamble that is appended to any data you scan with the terminal. Common postambles include cursor controls such as tabs or carriage return line feeds. For help on using the TRAKKER 2400 Menu System to configure the Postamble, see “Entering ASCII Control Characters” in Chapter 3.

***Note:** You can set the postamble to use characters from the extended ASCII character set such as the Field Exit code for 5250 TE. For help, see “Auto-Advancing Through Fields on 5250 TE Screens” in Chapter 5.*

Default: No characters (disabled)

Syntax: AE*data*

Acceptable values for *data* are up to 25 ASCII characters. If you enter the AE command without *data*, the postamble is disabled. If you are entering quotation marks as data or grouping configuration commands, you need to enclose the *data* within quotation marks (see the example).

***Note:** To scan a bar code label that includes quotes, you must configure the terminal to use Code 39 in Full ASCII mode. For help, see “Code 39” earlier in this chapter.*

Scan: To disable the postamble, scan this bar code:

Disable Postamble



\$+AE

Or: To set the postamble to an ASCII character string:

1. Scan this bar code:

Enter Accumulate Mode / Set Postamble



+/\$+AE

2. Scan a value for *data* from the “Full ASCII Bar Code Chart” in Appendix B. The postamble can be from 1 to 25 characters.
3. Scan this bar code:

Exit Accumulate Mode



_/

Example:

You want to set a postamble that includes quotation marks. Enter the postamble by scanning this full ASCII bar code label:

Set Postamble to "B"



S+AE""B""

You must enclose the data within quotation marks and precede each quotation mark with another quotation mark so that the quotation marks are not treated as the end of the data.

Preamble

Purpose: Sets the preamble that precedes any data you scan with the terminal. Common preambles include a data location number or an operator number. For help on using the TRAKKER 2400 Menu System to configure the Preamble, see "Entering ASCII Control Characters" in Chapter 3.

Note: You can set the preamble to use characters from the extended ASCII character. For help, see "Auto-Advancing Through Fields on 5250 TE Screens" in Chapter 5.

Default: No characters (disabled)

Syntax: ADdata

Acceptable values for *data* are up to 25 ASCII characters. When you enter the AD command without *data*, the preamble is disabled. If you are entering quotation marks as data or grouping configuration commands, you need to enclose the *data* within quotation marks (see the example).

Note: To scan a bar code label that includes quotes, you must configure the terminal to use Code 39 in Full ASCII mode. For help, see "Code 39" earlier in this chapter.

Scan: To disable the preamble, scan this bar code:

Disable Preamble



\$+AD

Or: To set the preamble to an ASCII character string:

1. Scan this bar code:

Enter Accumulate Mode / Set Preamble



+/\$+AD

2. Scan a value for *data* from the “Full ASCII Bar Code Chart” in Appendix B. The preamble can be from 1 to 25 characters.
3. Scan this bar code:

Exit Accumulate Mode



_/

Example:

You want to set a preamble that includes quotation marks. Enter the preamble by scanning this full ASCII bar code label:

Set Preamble to "B"



\$+AD""B""

You must enclose the data within quotation marks and precede each quotation mark with another quotation mark so that the quotation marks are not treated as the end of the data.

Resume Execution

Purpose: Defines the way in which the terminal resumes when you press Ⓢ to turn on the terminal. If you set this parameter to resume not allowed and you press Ⓢ to turn on the terminal, the terminal will boot and restart the default application. If you set this parameter to resume allowed and press Ⓢ to turn on the terminal, the terminal resumes exactly where it was when you turned off the terminal.

Default: Allowed

Syntax: ERdata
Acceptable values for *data* are:
0 Not allowed
1 Allowed

Scan: One of these bar codes:

Resume Execution Not Allowed



S+ER0

Resume Execution Allowed



S+ER1

RF Domain

Purpose: Defines a logical partition or subnetwork of the network. To establish communications, you must assign the same domain number to every RF device in a wireless network. The domain number you set on the T2425 terminal must match the domain that is set on each access point the terminal may communicate with. You can continue to collect data with the terminal as you roam in between access points as long as all the devices have the same domain number.

Default: 0

Syntax: *RWdata*
Acceptable values for *data* are any number from 0 to 15.

Scan: 1. Scan this bar code:

Enter Accumulate Mode / Set RF Domain



+/\$+RW

2. Scan a numeric value for *data* from these bar codes:



0



1



2



3



4



5



6



7



8



9

RF Domain (continued)

3. Scan this bar code:

Exit Accumulate Mode



_/

RF Security Identification

Purpose: Defines the password you can set for secured transmission and receipt of data between devices in the network. To communicate, all 0100 Access Points and TRAKKER 2425 terminals in the subnetwork must have matching security IDs.

Default: No characters or blank (disabled)

Syntax: *RSdata*

Acceptable values for *data* are up to 20 ASCII characters. When you enter the RS command without *data*, the RF security ID is disabled or set to no characters (blank).

Note: You can only set the RF security ID with the 2.4 GHz network enabled. The Network Activate configuration command must be configured to 2.4 GHz RF Network before you can save any changes to the RF security ID command.

Scan: To disable or set the RF security ID to no characters, scan this full ASCII bar code label:

Disable RF Security ID



\$+RS

Or: To set the RF security ID to an ASCII character string:

1. Scan this bar code:

Enter Accumulate Mode / Set RF Security ID



+/\$+RS

2. Scan a value for *data* from the “Full ASCII Bar Code Chart” in Appendix B. The RF security ID can be from 1 to 20 characters.
3. Scan this bar code:

Exit Accumulate Mode



_/

Notes:

If you view the RF security ID in the TRAKKER 2400 Menu System, the actual security ID does not display on the screen. The words, (ID unchanged), indicate that the password has not been changed in the current menu session. If you change the security ID, you see the new password until you exit the Configuration Menu and update the runtime configuration.

Example:

You want to set the security ID to the letters ABC. Scan this bar code label:

Set RF Security ID to ABC



\$+RSABC

RF Wakeup On Broadcast

Purpose: Determines if the terminal can receive broadcast messages sent from the network. If the wakeup on broadcast is enabled, the terminal radio will turn on to receive broadcast messages. If this command is disabled, the terminal radio will ignore broadcast messages.

Power Management Tip: *If your network has many broadcast messages, you may want to disable the wakeup on broadcast command to preserve the main battery pack's power.*

Default: Disabled

Syntax: RBdata

Acceptable values for *data* are:

0 Disabled
1 Enabled

Scan: One of these bar codes:

Disable RF Wakeup On Broadcast



S+RB0

Enable RF Wakeup On Broadcast



S+RB1

Scan Ahead

Purpose: Enables or disables scan ahead. If you enable this parameter, you can scan a number of labels that are held in a stack until the terminal can process the data. If you disable this parameter, the terminal processes each label you scan before you can scan the next label.

Default: Disabled

Syntax: *SDdata*

Acceptable values for *data* are:

- 0 Disabled (scan one label at a time)
- 1 Enabled (scan many labels at a time)

Scan: One of these bar codes:

Disable Scan Ahead



S+SD0

Enable Scan Ahead



S+SD1

Scanner Mode

Purpose: Defines how the scanner operates when you press the Scan button or activate a cabled laser scanner. There are two types of modes:

- In One-Shot mode, you must press the Scan button or activate the cabled laser scanner each time you want to scan a bar code. Once you scan a bar code, the scanner turns off.
- In Automatic (Auto-trigger) mode, you press the Scan button once or activate the cabled laser scanner once to scan a series of bar codes. When you release the button or trigger, the scanner turns off. To scan the same bar code more than once, you must release the Scan button or trigger, or scan a different bar code before attempting a second scan.

Default: One-Shot mode

Syntax: *SBdata*

Acceptable values for *data* are:

0 One-Shot mode
1 Automatic mode

Scan: One of these bar codes:

Enable One-Shot Mode



S+SB0

Enable Automatic Mode



S+SB1

Scanner Redundancy

Purpose: Defines the number of scans (voting) the scanner takes of the same label that must decode correctly for a good read of the label. Voting requires the terminal to decode the same bar code multiple times during a single scanner event, and to compare the decoded information a specific number of times before signaling a good read. There are three options:

None Allows the terminal to accept the first good read, which speeds up terminal performance. This setting is recommended when scanning good quality bar codes.

Normal The terminal decodes the bar code a minimum number of times in each scanner event. The number of comparisons that are made depends on each bar code symbology.

High The terminal scans and decodes the bar code a maximum number of times in each scanner event. The specific number of comparisons depends on each bar code symbology. The high setting is recommended when scanning poor quality labels that may cause substitution errors.

For example, when you scan Code 39 labels and the scanner redundancy is set to normal, two successive matching decodes in a single scanner event are required. When scanner redundancy is set to high, three successive matching decodes in a single scanner event are required.

Default: Normal

Syntax: *SRdata*

Acceptable values for *data* are:

- 0 None
- 1 Normal
- 2 High

Scan: One of these bar codes:

None



S+SR0

Scanner Redundancy (continued)

Normal



\$+SR1

High



\$+SR2

Scanner Selection

Purpose: Identifies the type of scanner you have connected to the TRAKKER 2425 terminal module for cabled scanners. The terminal can optimize the scanning performance by using the scanner you define in this command.

Note: *The Scanner Selection configuration command is only used when a module for cabled scanners is installed on the TRAKKER 2425 terminal. When you select a specific scanner, other scanners may not function properly. Your terminal may not work if you connect an incompatible scanner.*

Default: All compatible scanners

Syntax: `SSdata`

Acceptable values for *data* are:

- 0 All compatible scanners (including wands)
- 1 146x CCD scanners
- 2 155x laser scanners
- 3 151x laser scanners
- 4 1545 laser scanner
- 5 Compatible Symbol scanners (with reverse polarity enabled)

Scan: One of these bar codes:

All Compatible Scanners



S+SS0

146x CCD Scanners



S+SS1

155x Laser Scanners



S+SS2

151x Laser Scanners



S+SS3

1545 Laser Scanner



S+SS4

Compatible Symbol Scanners



S+SS5

Scanner Timeout

Purpose: Defines the maximum length of time the scanner stays after you press the Scan button or activate a cabled laser scanner.

Default: Disabled (no timeout)

Syntax: *SAdata*
Acceptable values for *data* are:
0 Disabled
1-60 Shutoff time in seconds

Scan: 1. Scan this bar code:

Enter Accumulate Mode / Change Scanner Timeout



+/\$+SA

2. Scan a numeric value for *data* from these bar codes:



0



1



2



3



4



5



6



7



8



9

3. Scan this bar code:

Exit Accumulate Mode



_/

Scanner Trigger

Purpose: Scanner trigger allows you to set level triggering or edge triggering.

- With level triggering, you activate the scanner and the laser turns on and stays on until you release the button or the trigger on a cabled scanner.
- In edge triggering, you activate the scanner and the laser turns on and stays on. When you activate the scanner a second time, the laser turns off. Simply releasing the button or the trigger does not turn the laser off. If the laser is left on, the scanner timeout turns the laser off.

Default: Level triggering

Syntax: *SCdata*

Acceptable values for *data* are:

0 Level triggering

1 Edge triggering

Scan: One of these bar codes:

Enable Level Triggering



S+SC0

Enable Edge Triggering



S+SC1

Subnet Mask

Purpose: Defines the subnet mask, an internal TCP/IP protocol stack variable that is used to separate the subnetwork address from the local IP address. The TCP/IP protocol stack performs a bit-wise AND on the IP address and the subnet mask. Each address segment represents one byte, where 255 converts to FF hex. The default subnet mask 255.255.255.0 means the terminal uses a standard IP network mask.

For example, if the IP address is 192.009.150.184 and the subnet mask is 255.255.255.0, the subnetwork address is 192.009.150.X.

Default: 255.255.255.0

Syntax: NS*n.n.n.n*

where each *n* address segment is a number from 0 to 255. The subnet mask field consists of four separate numbers, each separated by a period.

Scan: To set the default subnet mask address, scan this bar code:

Default Subnet Mask



\$+NS255.255.255.0

Or: To set the subnet mask:

1. Scan this bar code:

Enter Accumulate Mode / Set Subnet Mask



+/\$+NS

- Scan a numeric value from 0 to 255 to set an *n* field of the subnet mask address from these bar codes.



0



1



2



3



4



5



6



7



8



9

- Scan this bar code:

. (Period)



.

- Repeat Steps 2 and 3 to set the next two numbers in the subnet mask address field. After you scan the last address segment, go to Step 5. Do **not** scan the period after the last address segment.

- Scan this bar code:

Exit Accumulate Mode



_/

Terminal IP Address

Purpose: Defines the IP address assigned to the TRAKKER 2425 terminal in your 2.4 GHz network. An IP address is a network level address you assign to each device in a TCP/IP network. The IP address you set on the T2425 terminal must match the address that is set on the controller.

Default: 0.0.0.0

Syntax: ND*n.n.n.n*

where each *n* address segment is a number from 0 to 255. The terminal IP address field consists of four separate numbers, each separated by a period.

Note: *The network cannot be activated if the first address segment in the IP address is set to 0, 127, or a number greater than 223.*

Scan: To set the default terminal IP address, scan this bar code:

Default Terminal IP Address



\$+ND0.0.0.0

Or: To set the terminal IP address:

1. Scan this bar code:

Enter Accumulate Mode / Set Terminal IP Address



+/\$+ND

- Scan a numeric value from 0 to 255 to set an *n* field of the terminal IP address from these bar codes.



0



1



2



3



4



5



6



7



8



9

- Scan this bar code:

. (Period)



.

- Repeat Steps 2 and 3 to set the next two numbers in the terminal IP address field. After you scan the last address segment, go to Step 5. Do **not** scan the period after the last address segment.

- Scan this bar code:

Exit Accumulate Mode



_/

Time and Date

Purpose: Sets the time and date on the terminal.

Default: 960101120000

Syntax: DB*data*

Acceptable values for *data* are 12 digits corresponding to:

| | | |
|-----------|-------|-------------------|
| <i>yy</i> | 00-99 | Year |
| <i>mm</i> | 01-12 | Month of the year |
| <i>dd</i> | 01-31 | Day of the month |
| <i>hh</i> | 01-12 | Hour |
| <i>mm</i> | 00-59 | Minutes |
| <i>ss</i> | 00-59 | Seconds |

Scan: To set the time and date:

1. Scan this bar code:

Enter Accumulate Mode / Set Time and Date



+/\$+DB

2. Scan a numeric value for each digit from these bar codes:



0



1



2



3



4



5



6



7



8



9

3. Scan this bar code:

Exit Accumulate Mode



_/

Time in Seconds

Purpose: If you enable the Append Time command, you can enable the Time in Seconds command to append the seconds to each transaction transmitted from the terminal. To append the time in hours and minutes, disable the Time in Seconds command.

Default: Disabled

Syntax: *DAdata*
 Acceptable values for *data* are:

0 Disabled
 1 Enabled

Scan: One of these bar codes:

Disable Time in Seconds



S+DA0

Enable Time in Seconds



S+DA1

UDP Port

Purpose: Defines the UDP port that the UDP Plus network protocol uses for communications in your 2.4 GHz network. The UDP port you set on the TRAKKER 2425 terminal must match the Network port that is set on the controller.

Default: 05555

Syntax: *NGdata*
Acceptable values for *data* are any number from 5001 to 65535.

Scan: To set the default UDP port, scan this bar code:

Default UDP Port



\$+NG5555

Or: To set the UDP port:

1. Scan this bar code:

Enter Accumulate Mode / Set UDP Port



+/\$+NG

2. Scan a numeric value for *data* from these bar codes:



0



1



2



3



4



5



6



7



8



9

3. Scan this bar code:

Exit Accumulate Mode



_/

UPC/EAN

Purpose: Enables or disables the decoding of Universal Product Code (UPC)/European Article Numbering (EAN) symbology. UPC/EAN are fixed length, numeric, continuous symbologies that use four element widths. A terminal that is configured to decode EAN bar codes can decode UPC, but the reverse is not true. UPC code is a subset of EAN code.

To define the UPC/EAN symbology, you set up to seven digits. The fifth, sixth, and seventh digits are optional. To set the sixth digit, you must set the fifth digit. To set the seventh digit, you must set all seven digits.

Default:

| | |
|-----------------------|-------------------------------|
| <i>First digit:</i> | UPC-A/EAN-13 enabled |
| <i>Second digit:</i> | UPC-E enabled |
| <i>Third digit:</i> | EAN-8 enabled |
| <i>Fourth digit:</i> | Supplementals allowed |
| <i>Fifth digit:</i> | Transmit check digit |
| <i>Sixth digit:</i> | Transmit number system digit |
| <i>Seventh digit:</i> | Retain leading zero for UPC-A |

Syntax: CEdata

where *data* must be 4 to 7 digits selected from this list:

| | | |
|-----------------------|---|------------------------------------|
| <i>First digit:</i> | 0 | UPC-A/EAN-13 disabled |
| | 1 | UPC-A/EAN-13 enabled |
| | 2 | UPC-A only enabled |
| <i>Second digit:</i> | 0 | UPC-E disabled |
| | 1 | UPC-E enabled |
| <i>Third digit:</i> | 0 | EAN-8 disabled |
| | 1 | EAN-8 enabled |
| <i>Fourth digit:</i> | 0 | Supplementals are not allowed |
| | 1 | Supplementals are allowed |
| <i>Fifth digit:</i> | 0 | Discard check digit |
| | 1 | Transmit check digit |
| <i>Sixth digit:</i> | 0 | Discard number system digit |
| | 1 | Transmit number system digit |
| <i>Seventh digit:</i> | 0 | Discard the leading zero for UPC-A |
| | 1 | Retain the leading zero for UPC-A |

Scan: To disable UPC/EAN, scan this bar code:

Disable UPC/EAN



\$+CE000000

Or: To enable UPC/EAN:

1. Scan this bar code:

Enter Accumulate Mode / Enable UPC/EAN



+/\$+CE

2. Scan one of these bar codes to set the first digit:

Disable UPC/EAN-13



0

Enable UPC/EAN-13



1

Enable UPC-A Only



2

3. Scan one of these bar codes to set the second digit:

Disable UPC-E



0

Enable UPC-E



1

4. Scan one of these bar codes to set the third digit:

Disable EAN-8



0

Enable EAN-8



1

UPC/EAN (continued)

5. Scan one of these bar codes to set the fourth digit:

Supplementals Not Allowed



0

Supplementals Allowed



1

6. (Optional) Scan one of these bar codes to set the fifth digit:

Discard Check Digit



0

Transmit Check Digit



1

7. (Optional) Scan one of these bar codes to set the sixth digit:

Discard Number System Digit



0

Transmit Number System Digit



1

Note: If you discard the number system digit, one leading digit is discarded from UPC-A, UPC-E, and EAN-8, and two leading digits are discarded from EAN-13.

8. (Optional) Scan one of these bar codes to set the seventh digit:

Discard Leading Zero for UPC-A



0

Transmit Leading Zero for UPC-A



1

Note: This option applies only when you enable UPC-A/EAN-13.

9. Scan this bar code:

Exit Accumulate Mode



_/

3270 and 5250 TE Command Reference

This chapter lists all of the terminal emulation commands you can use on a TRAKKER 2425 terminal that is running 3270 or 5250 terminal emulation.

Command Descriptions

This chapter contains an alphabetical listing of the 3270 and 5250 terminal emulation commands you can use on the TRAKKER 2425 terminal. Each command contains a description, key sequence, and bar code. You will also find program function and program attention keys listed with their bar codes, but no description because you program the keys differently for each application.

Note: *To scan the bar code labels in this chapter, you must configure the terminal to use Code 39 in Full ASCII mode. For help, see “Code 39” in Chapter 8.*

Attention

The Attention key contacts the host and asks permission to send data from the T2425 terminal display. The keypad locks automatically when you send this command or any other AID command. When the host computer grants permission to send data, the keypad unlocks. This key is useful for finding out if the host computer is free before you attempt to transmit data.

For 5250 terminals, this key sequence prompts the host system to display the Operational Assistant Menu.

Keypad: 

Scan: Attention

%ATTN

Backtab

Backtab moves the cursor back to the most recent first field position. If the cursor is in the middle of a field, Backtab moves it to the first position of the same field. If the cursor is at the first position of a field, Backtab moves it to the first position of the preceding input field.

Keypad: 

Scan: Backtab



%BTAB

Clear

This command clears the T2425 display and moves the cursor to the home position. This is an AID key.

For 5250 terminals, this command sends the clear AID (X'BD) function to the host computer which then clears the keyboard.

Keypad: 

Scan: Clear



%CLR

Cursor Home

Cursor Home is one of two home commands. Cursor Home moves the cursor to the first input position on the terminal screen and moves the viewport to that position. If you want to move the viewport to the upper left corner of the terminal screen without moving the cursor, use the Home command.

Keypad:  

Scan: Home



%Hm

Delete

This command deletes the character at the current cursor position. When you delete a character, all characters to the right of the cursor shift left one position. The cursor must be in an unprotected field when you use this key.

Keypad:  

Scan: Delete



%DEL

End

This command moves the viewport to the end of the last line displayed on the TE application screen. When you move the viewport, the cursor does not move.

Keypad:  

Scan: End



%END

Enter

This command sends all input to the host computer, including the cursor position. It lets the host know what data to expect next. Enter is an AID key.

3270 Keypad:  or  or 

5250 Keypad: 

Scan: Enter

<CR>

Enter TE Configuration Menu

This command lets you enter the TE configuration menu where you can make changes to 3270 or 5250 configuration settings.

Keypad:  

Scan: Not supported.

Erase Input

This command clears all input fields and moves the cursor to the first input position (the first input position on the terminal screen) on the display. This command will not erase protected fields. If you press this key when the display shows only protected fields, the cursor will return to the home position.

Keypad:  

Scan: Erase Input

%EINP

Erase to End of Field

3270 terminals only

This command erases all characters from the cursor to the end of the field. If the field is protected or the cursor is in a field attribute instead of an input position, then pressing this key will lock the keypad. Press Reset to unlock the keypad.

Keypad: 

Scan: Erase to End of Field

%EOF

Error Reset

5250 terminals only

Error Reset unlocks the keypad when it has locked due to a 5250 error condition. It also resets the Help, Insert, System Request, and Command keys. An error message appears when data entry occurs in S/3X or AS/400 applications.

Keypad: 

Scan: Error Reset

%ERR

Fast Cursor Right or Left

This command moves the cursor two positions to the right or left rather than one.

Keypad: Fast Cursor Right [=f] [=6]

Fast Cursor Left [=f] [=4]

Scan: Fast Cursor Right



%FCRT

Fast Cursor Left



%FCLT

Field+ and Field-

5250 terminals only

The Field+ command operates as a Field Exit key in all fields.

The Field- command operation can vary depending on the system. With most systems, the Field- command operates the same as the Field+ and Field Exit commands except that you can only use it in signed numeric and numeric only fields. Field- inserts a minus sign in the last position of a signed numeric field.

Keypad: Field+

Field-

Scan: Field+

%FLD+

Field-

%FLD-

Field Exit

5250 terminals only

This command exits an input field and moves the cursor to the beginning of the next input field. If you press this key while the cursor is between characters, then all characters to the right of the cursor will be erased.

Note: You can set the *Postamble* or *Preamble* command to use characters from the extended ASCII character set such as the *Field Exit* code for 5250 TE. For help, see “Auto-Advancing Through Fields on 5250 TE Screens” in Chapter 5.

Keypad:  or 

Scan: Field Exit

%FLDX

Help

5250 terminals only

Help causes the host system to display the Help Menu if a local processing error has not occurred. If a local processing error occurs, the error condition is handled automatically by the TE application. For help on TE application error messages, see Chapter 6, “Troubleshooting.”

Keypad:  

Scan: Help

%HELP

Home

Moves the viewport to the top left corner of the TE application screen. When you move the viewport, the cursor does not move.

Keypad:  

Scan: Home



%HOME

Insert

This command puts the keypad into Insert mode. Insert mode lets you insert characters between other characters in a field. If you insert characters after the field is full, enter data at a field attribute or in a protected field, the keypad locks up. If you press any key that initiates host communication (such as ), you turn off Insert mode and unlock the keypad. The status line indicates when the terminal is operating in Insert mode.

Keypad:  

Scan: Insert



%INS

New Line

Use this command to move the cursor to the first unprotected character position of the first line in the display. If the entire display is a protected field, the cursor returns to the home position.

Keypad:  

Scan: New Line











%NL

Paging Keys (Viewport)

Paging keys move the T2425 display to the next adjacent area on the screen. These keys move the display as a viewport within the host terminal screen; the screen itself does not advance or scroll.

The paging keys let you view the rest of the screen without entering data. When you page, you move only the viewport, not the cursor, and the cursor may disappear from the display. A page is 16 lines by 20 characters. The Cursor Home key will bring both the viewport and the cursor back to the first field position on the screen.

| | | |
|----------------|------------|--|
| Keypad: | Page Up |  |
| | Page Down |  |
| | Page Right |  |
| | Page Left |  |

| | | |
|--------------|------------|--|
| Scan: | Page Up |  |
| | | *%PGUP* |
| | Page Down |  |
| | | *%PGDN* |
| | Page Right |  |
| | | *%PGRT* |
| | Page Left |  |
| | | *%PGLT* |

Reset

3270 terminals only

Reset unlocks the keypad if it is locked due to an error and will clear the status line of most error messages. You cannot use the Reset command when the T2425 is communicating with the host computer.

Keypad: 

Scan: Reset



%RST

Roll Up and Roll Down

5250 terminals only

Roll up and roll down are AID keys that the T2425 sends to the host to request additional screens. The host transmits a new screen display in response to this command. The new screens allow you to view data either above or below what appears on the display.

Do not confuse the Roll Up and Roll Down AID keys with the Roll command (Hex 23) received from a host application. For help on the Roll command, see “Using the Roll Keys” in Chapter 5.

Keypad: Roll Up 

Roll Down 

Scan: Roll Up



%ROUP

Roll Down



%RODN

Scroll Viewport Keys

Use these commands to move the viewport one line or character up, down, right, or left. To select a specific cursor key, press one of the arrows on the edges of the oval-shaped cursor key.

Keypad:

| | |
|----------------|--|
| Viewport Up |  |
| Viewport Down |  |
| Viewport Left |  |
| Viewport Right |  |

Scan:

Viewport Up



%UP

Viewport Down



%DN

Viewport Left



%LF

Viewport Right



%RT

Status

This command toggles the T2425 display between the status line display and the normal field input display. Press this key once to bring up the status line, and press it again to remove the status line. If a local editing error occurs for any reason, the status line automatically appears, displaying an error message.

Keypad:  

Scan: Status

%STAT

System Request

The use of these AID keys depends on the system. Most systems use these commands to sign on or off, select alternate tasks, interrupt the present program to start a new task, or request permission to send data.

To cancel the System Request command, press the Error Reset (ErrRst) key. If you press any other key before pressing the  key, an error occurs.

For 5250 terminals, the System Request command prompts the host system to display the System Request Menu.

Keypad:  

Scan: System Request

%SYSR

Tab

The Tab key moves the cursor to the first position in the next input field.

Keypad: 

Scan: Tab

<HT>

Program Function Keys

When you press a program function key or scan its bar code, you send the data on the display to the host, and the function you specified is performed on this data. Each function is determined by the application you use with your system. See your application user's manual for details on the functions. Program function keys are AID keys, and the keypad remains locked while the terminal performs the function you chose.

| Function Key | Bar Code |
|---|--|
|  | F1  *%F1* |
|  | F2  *%F2* |
|  | F3  *%F3* |
|  | F4  *%F4* |
|  | F5  *%F5* |
|   | F6  *%F6* |

Program Function Keys (continued)

| Function Key | Bar Code |
|---|---|
|  | F7  *%F7* |
|  | F8  *%F8* |
|  | F9  *%F9* |
|  | F10  *%F10* |
|  | F11  *%F11* |
|  | F12  *%F12* |
|  | F13  *%F13* |

Program Function Keys (continued)



| Function Key | Bar Code |
|---|--|
|  | F14  *%F14* |
|  | F15  *%F15* |
|  | F16  *%F16* |
|  | F17  *%F17* |
|  | F18  *%F18* |
|  | F19  *%F19* |

Program Function Keys (continued)

| Function Key | Bar Code |
|---|---|
|   | F20  *%F20* |
|   | F21  *%F21* |
|   | F22  *%F22* |
|   | F23  *%F23* |
|   | F24  *%F24* |

Program Attention Keys for 3270 Terminals

You can use the program attention keys to send messages to the host. The specific application you use with your system defines these messages. See your application user's manual for details on the messages each program attention key sends. Program attention keys are AID keys.





| Program Attention Key | Bar Code |
|-----------------------|---|
| <code>_f 8</code> | PA1  *%PA1* |
| <code>_f 5</code> | PA2  *%PA2* |
| <code>_f 2</code> | PA3  *%PA3* |

Other Keys

You can also find these commands on the 3270 or 5250 TE keypad. These non-ASCII (EBCDIC) keys are not shown in the Full ASCII Table in Appendix B.

| Key | Bar Code |
|---|--|
|  | ¢ (cent sign)  *%CENT* |

These commands are only available on the 5250 TE keypad.

| Key | Bar Code |
|---|---|
|  | Duplicate  *%DUP* |
|  | Field Mark  *%FM* |

***VT100/220/320 and ANSI TE
Command Reference***

This chapter lists all of the terminal emulation commands you can use on a TRAKKER 2425 terminal that is running VT100/220/320 or ANSI terminal emulation.

Editing Key Commands for VT220/320 Terminals

The following Editing Key commands are listed in alphabetical order. Each command is listed with its corresponding key sequence and bar code. Program function keys are listed with their bar code, but no description is provided because you program the keys differently for each application.

The function of each editing key is determined by the software application you are using. Refer to your application user's manual for information about the editing key functions.

Note: To scan the bar code labels in this chapter, you must configure the terminal to use Code 39 in Full ASCII mode. For help, see "Code 39" in Chapter 8.

Backspace

Keypad: 

Scan: Backspace

%BKSP

Note: The Backspace editing key is available for VT100 and ANSI terminals.

End

Keypad: 

Scan: End

%END



Find

Keypad:  

Scan: Find

%FIND

Home:

Keypad:  

Scan: Home

%HOME

Insert

Keypad:   or  

Scan: Insert

%INS

Next Screen

Keypad:  

Scan: Next





%NEXT

Paging Keys (Viewport)

Paging keys move the T2425 display to the next adjacent area on the screen. These keys move the display as a viewport within the host terminal screen; the screen itself does not advance or scroll.

The paging keys let you view the rest of the screen without entering data. When you page, you move only the viewport, not the cursor, and the cursor disappears from the display.

Note: The Paging keys are available for VT100 and ANSI terminals.

| | | |
|----------------|------------|---|
| Keypad: | Page Up |  |
| | Page Down |  |
| | Page Right |  |
| | Page Left |  |

| | |
|--------------|---|
| Scan: | Page Up |
| |  |
| | *%PGUP* |
| | |

| | |
|--|---|
| | Page Down |
| |  |
| | *%PGDN* |
| | |

| | |
|--|---|
| | Page Right |
| |  |
| | *%PGRT* |
| | |

| | |
|--|---|
| | Page Left |
| |  |
| | *%PGLT* |
| | |

Previous Screen

Keypad: 

Scan: Previous Screen



%PREV

Remove

Keypad: 

Scan: Remove



%REM

Select

Keypad: 

Scan: Select



%SEL

Program Function Keys

When you press a program function key or scan its bar code, you send the data on the display to the host and the TRAKKER 2425 terminal performs the function you specified on this data. The software application you are using determines the function of each editing key. Refer to your application user's manual for information about the editing key functions.

Note: VT100 terminals only support function keys $\textcircled{F1}$ to $\textcircled{F6}$.

| Function Key | Bar Code |
|--------------------------------|--|
| $\textcircled{F1}$ | F1  *%F1* |
| $\textcircled{F2}$ | F2  *%F2* |
| $\textcircled{F3}$ | F3  *%F3* |
| $\textcircled{F4}$ | F4  *%F4* |
| $\textcircled{F5}$ | F5  *%F5* |
| $\boxed{_f} \textcircled{F1}$ | F6  *%F6* |

Program Function Keys (continued)

| Function Key | Bar Code |
|---|---|
|  | F7  *%F7* |
|  | F8  *%F8* |
|  | F9  *%F9* |
|  | F10  *%F10* |
|  | F11  *%F11* |
|  | F12  *%F12* |
|  | F13  *%F13* |

Program Function Keys (continued)

| Function Key | Bar Code |
|---|--|
|  | F14  *%F14* |
|  | F15  *%F15* |
|  | F16  *%F16* |
|  | F17  *%F17* |
|  | F18  *%F18* |
|  | F19  *%F19* |
|  | F20  *%F20* |

Additional Functions

You can use the key sequences and bar codes shown next to move the viewport movement and execute additional commands on VT100/220/320 and ANSI terminals.

Use these commands to move the viewport one line up, down, right, or left. When you move the viewport, the cursor does not move. To select a specific cursor key, press one of the arrows on the edges of the oval-shaped Cursor key.

| | | |
|----------------|----------------|--|
| Keypad: | Viewport Up |  |
| | Viewport Down |  |
| | Viewport Left |  |
| | Viewport Right |  |





| | |
|--------------|---|
| Scan: | Viewport Up |
| |  |
| | *%UP* |
| | |

| | |
|--|---|
| | Viewport Down |
| |  |
| | *%DN* |
| | |

| | |
|--|---|
| | Viewport Left |
| |  |
| | *%LF* |
| | |

| | |
|--|---|
| | Viewport Right |
| |  |
| | *%RT* |
| | |

Additional Functions (continued)

| Function Key | Bar Code | Description |
|---|---|---|
|  | Not supported | Accesses the TE Configuration menu. You can access the menu at any time during your terminal emulation session. |
|  | Exit TE  *%EXIT* | This command lets you exit the terminal emulation application. Note: Do not choose to exit the terminal emulation program. If you do accidentally exit TE, you may see an error message on the status line. Clear the error and continue. |
|  | Not supported | Changes the Input mode to Line mode. |
|  | Not supported | Changes the Input mode to Character mode. |



Terminal Specifications

This appendix lists the terminal's physical and environmental specifications, lists the default configuration, and provides a configuration command reference list in alphabetical order by command syntax.

Physical and Environmental Specifications

You can use the tables in this section to find technical information about these features and options:

- Terminal Dimensions
- Power Specifications
- Temperature Specifications
- Relative Humidity Specifications
- Display
- Keypad Options
- Application Options
- Memory
- Radio Frequency Communications
- Network Support
- Bar Code Symbologies
- Scan Module Options
- Standard Range Scan Module Optical Parameters

Terminal Dimensions

| | |
|--------|--|
| Length | 10.6 in (26.5 cm) |
| Height | 2.8 in (7.0 cm) |
| Width | 3.2 in (8.0 cm) |
| Weight | 27 oz (765.45 g) including the main battery and backup battery |

Power Specifications

| | |
|---------------|---|
| Operating | Rechargeable lithium-ion battery pack (1000 to 1350 mAh available) |
| Memory Backup | Rechargeable NiCad 110 mAh battery |

Temperature Specifications

You need to operate and store the terminal within the temperature ranges listed in this table.

Note: For information about using the terminal in cold temperature environments, see "Guidelines for Managing Batteries" in Chapter 6.

| Type of Operation | Fahrenheit Temperature Range | Celsius Temperature Range |
|---|---------------------------------|------------------------------|
| Charging the battery pack | +32°F to +104°F | 0°C to +40°C |
| Operating the terminal | -4°F to +122°F | -20°C to +50°C |
| Storing the terminal (with or without batteries installed) | -4°F to +140°F | -20°C to +60°C |

Relative Humidity Specifications

0% to 95% noncondensing humidity

Display

- CGA compatible
- 16 lines x 20 columns, backlit LCD
- 25 lines by 80 columns, virtual display with viewport feature

Keypad Options

- Full alphanumeric keypad with 55 keys available in English
- Terminal emulation keypads for IBM 3270, IBM 5250, and VTXXX/ANSI

Application Options

- IBM 3270 terminal emulation
- IBM 5250 terminal emulation
- Screen mapping to IBM 3270 or 5250 terminals
- VT100/220/320 and ANSI terminal emulation

Memory

- 2MB programmable flash memory
- 1MB battery-backed RAM

Radio Frequency Communications

- 2.4 GHz (to 2.4835 GHz) radio
- Frequency hopping spread spectrum radio
- 100 mW output power (maximum)
- 1.6 Mbits per second data speed
- Coverage \geq 240 feet (80 meters)

Network Support

- Host connectivity through 0100 Access Point and Model 200 Controller
- Ethernet network using UDP Plus protocol

Bar Code Symbologies

- | | |
|---------------------|----------------------|
| • Codabar | • Code 93 |
| • Code 1 (see Note) | • Code 128 |
| • Code 11 | • Interleaved 2 of 5 |
| • Code 16K | • MSI |
| • Code 2 of 5 | • PDF 417 (see Note) |
| • Code 39 | • Plessey |
| • Code 49 | • UPC/EAN |

Note: The Code 1 and PDF 417 symbologies are supported when you use the module for cabled scanners with the JANUS 7010 hand-held imager. You configure Code 1 and PDF 417 on the J7010 imager. For help, see the JANUS 7010 Hand-Held Imager User's Manual (P/N 060523).

Scan Module Options

There are two scan module accessory options:

- Standard range scan module with integrated visible laser diode (670 nm)
- Module for cabled scanners

Standard Range Scan Module Optical Parameters

The depth of field specifications are:

| Bar Code Specification | Depth of Field / Scanning Range |
|-------------------------------|---------------------------------|
| 5.0 mil code | 5 to 7 inches |
| 7.5 mil code | 5 to 11 inches |
| 10 mil code | 4 to 15 inches |
| 15 mil code | 4 to 21 inches |
| 20 mil code | 4 to 24 inches |
| 40 mil code | 5 to 28 inches |
| 55 mil code | 6 to 30 inches |
| 55 mil code, retroreflective | 2 to 7 inches |
| 100 mil code, retroreflective | 3 to 13 inches |

Input Devices for the Module for Cabled Scanners

You can attach these input devices to the module for cabled scanners:

- Intermec 146x CCD scanners
- Intermec 151x, 1545, and 155x laser scanners
- Intermec 126X and 127X wands
- JANUS 7010 hand-held imager
- Compatible Symbol scanners (with reverse polarity enabled)

You must use an interface cable to connect the input device to the module. For help, contact your local Intermec service representative.

If you are using the J7010 imager, you need to use a wedge interface cable (P/N 062168) and set the Cable ID parameter on the J7010 to the "Force 97xx Wedge" option. For help, see the *TRAKKER 2400 Series Module for Cabled Scanners Instruction Sheet* (P/N 064219-001).

Default Configuration

The next table shows the terminal's default configuration. You can use the TRAKKER 2400 Menu System to set the terminal to the default configuration. For help, see "Restoring the Terminal's Default Configuration" in Chapter 3.

Default Configuration for Bar Code Symbolologies

| Parameter | Default |
|--------------------|---|
| Codabar | Disabled |
| Code 11 | Disabled |
| Code 16K | Disabled |
| Code 2 of 5 | Disabled |
| Code 39 | Full ASCII Code 39 enabled with no check digit |
| Code 49 | Disabled |
| Code 93 | Disabled |
| Code 128 | Standard |
| Interleaved 2 of 5 | Disabled |
| MSI | Disabled |
| Plessey | Disabled |
| UPC/EAN | UPC-A/EAN-13 enabled, UPC-E and EAN-8 enabled, supplementals allowed, transmit check digit, transmit number system digit, and retain leading zero for UPC-A |

Default Configuration for Communications

| Parameter | Default |
|----------------------------|----------------|
| Controller IP Address | 0.0.0.0 |
| Default Router | 0.0.0.0 |
| Network Activate | Disabled |
| Network Loopback | Disabled |
| RF Domain | 0 |
| RF Security Identification | None |
| RF Wakeup On Broadcast | No (disabled) |
| Subnet Mask | 255.255.255.0 |
| Terminal IP Address | 0.0.0.0 |
| UDP Port | 05555 |

Default Configuration for Operations

| Parameter | Default |
|---------------------------|--|
| Append Time | Disabled |
| Automatic Shutoff | 0 minutes (disabled) |
| Beep Volume | Normal |
| Command Processing | All reader commands enabled |
| Decode Security | Moderate |
| Display Backlight Timeout | 10 seconds |
| Display Contrast | 3 (maximum contrast) |
| Keypad Caps Lock | Caps lock off |
| Keypad Clicker | Enabled |
| Postamble | No characters (disabled) |
| Preamble | No characters (disabled) |
| Resume Execution | Allowed |
| Scan Ahead | Disabled |
| Scanner Mode | One-Shot mode |
| Scanner Redundancy | Normal |
| Scanner Selection | All compatible scanners (see Note below) |
| Scanner Timeout | Disabled (no timeout) |
| Scanner Trigger | Level triggering |
| Time and Date | 9601011200000 |
| Time in Seconds | Disabled |

Note: The Scanner Selection configuration command is only used when a module for cabled scanners is installed on the TRAKKER 2425 terminal.

Configuration Commands by Syntax

The next table lists all of the configuration commands that are available on the TRAKKER 2425 terminal. The configuration commands are listed in alphabetic order by syntax.

| Syntax | Command | For Help, See Page |
|---------------|------------------------------------|---------------------------|
| <i>ADdata</i> | Preamble | 8-48 |
| <i>AEdata</i> | Postamble | 8-46 |
| <i>BVdata</i> | Beep Volume | 8-8 |
| <i>CAdata</i> | Interleaved 2 of 5 Code (1 2 of 5) | 8-37 |
| <i>CBdata</i> | Code 39 | 8-16 |
| <i>CCdata</i> | Code 2 of 5 (2 of 5) | 8-14 |
| <i>CDdata</i> | Codabar | 8-10 |
| <i>CEdata</i> | UPC/EAN | 8-70 |
| <i>CFdata</i> | Code 93 | 8-22 |
| <i>CGdata</i> | Code 11 | 8-12 |
| <i>CHdata</i> | Code 128 | 8-23 |
| <i>CIdata</i> | Plessey | 8-45 |
| <i>CJdata</i> | Code 49 | 8-20 |
| <i>CKdata</i> | Code 49 Function Code 1 | 8-20 |
| <i>CLdata</i> | Code 49 Function Code 2 | 8-20 |
| <i>CMdata</i> | Code 49 Function Code 3 | 8-20 |
| <i>CNdata</i> | MSI | 8-41 |
| <i>CPdata</i> | Code 16K | 8-13 |
| <i>CSdata</i> | Decode Security | 8-31 |
| <i>DAdata</i> | Time in Seconds | 8-67 |
| <i>DBdata</i> | Time and Date | 8-66 |
| <i>DCdata</i> | Command Processing | 8-25 |
| <i>DEdata</i> | Append Time | 8-6 |
| <i>DFdata</i> | Display Backlight Timeout | 8-34 |
| <i>DJdata</i> | Display Contrast | 8-36 |

Configuration Commands by Syntax (continued)

| Syntax | Command | For Help, See Page |
|---------------|----------------------------|---------------------------|
| <i>ERdata</i> | Resume Execution | 8-50 |
| <i>EZdata</i> | Automatic Shutoff | 8-7 |
| <i>KAdata</i> | Keypad Caps Lock | 8-39 |
| <i>KCdata</i> | Keypad Clicker | 8-40 |
| <i>NAdata</i> | Network Activate | 8-43 |
| <i>NCdata</i> | Controller IP Address | 8-29 |
| <i>NDdata</i> | Terminal IP Address | 8-64 |
| <i>NGdata</i> | UDP Port | 8-68 |
| <i>NLdata</i> | Network Loopback | 8-44 |
| <i>NSdata</i> | Subnet Mask | 8-62 |
| <i>NXdata</i> | Default Router | 8-32 |
| <i>RBdata</i> | RF Wakeup On Broadcast | 8-54 |
| <i>RSdata</i> | RF Security Identification | 8-52 |
| <i>RWdata</i> | RF Domain | 8-51 |
| <i>SAdata</i> | Scanner Timeout | 8-60 |
| <i>SBdata</i> | Scanner Mode | 8-56 |
| <i>SCdata</i> | Scanner Trigger | 8-61 |
| <i>SDdata</i> | Scan Ahead | 8-55 |
| <i>SRdata</i> | Scanner Redundancy | 8-57 |
| <i>SSdata</i> | Scanner Selection | 8-59 |



Full ASCII Charts

This appendix contains a full ASCII chart and charts of Code 39 bar code labels that you can scan with the TRAKKER 2425 terminal.

Full ASCII Table

This table lists the ASCII characters and their binary, hexadecimal, and Code 39 equivalents.

Full ASCII Table

| Binary ⁰ | Hex ¹ | Dec ² | C39 ³ | Char ⁴ | Binary ⁰ | Hex ¹ | Dec ² | C39 ³ | Char ⁴ |
|---------------------|------------------|------------------|------------------|-------------------|---------------------|------------------|------------------|------------------|-------------------|
| 00000000 | 00 | 00 | %U | NUL | 00100000 | 20 | 32 | SP | SP ⁵ |
| 00000001 | 01 | 01 | \$A | SOH | 00100001 | 21 | 33 | /A | ! |
| 00000010 | 02 | 02 | \$B | STX | 00100010 | 22 | 34 | /B | " |
| 00000011 | 03 | 03 | \$C | ETX | 00100011 | 23 | 35 | /C | # |
| 00000100 | 04 | 04 | \$D | EOT | 00100100 | 24 | 36 | /D | \$ |
| 00000101 | 05 | 05 | \$E | ENQ | 00100101 | 25 | 37 | /E | % |
| 00000110 | 06 | 06 | \$F | ACK | 00100110 | 26 | 38 | /F | & |
| 00000111 | 07 | 07 | \$G | BEL | 00100111 | 27 | 39 | /G | ' |
| 00001000 | 08 | 08 | \$H | BS | 00101000 | 28 | 40 | /H | (|
| 00001001 | 09 | 09 | \$I | HT | 00101001 | 29 | 41 | /I |) |
| 00001010 | 0A | 10 | \$J | LF | 00101010 | 2A | 42 | /J | * |
| 00001011 | 0B | 11 | \$K | VT | 00101011 | 2B | 43 | /K | + |
| 00001100 | 0C | 12 | \$L | FF | 00101100 | 2C | 44 | /L | , |
| 00001101 | 0D | 13 | \$M | CR | 00101101 | 2D | 45 | /M | - |
| 00001110 | 0E | 14 | \$N | SO | 00101110 | 2E | 46 | /N | . |
| 00001111 | 0F | 15 | \$O | SI | 00101111 | 2F | 47 | /O | / |
| 00010000 | 10 | 16 | \$P | DLE | 00110000 | 30 | 48 | /P ⁶ | 0 |
| 00010001 | 11 | 17 | \$Q | DC1 | 00110001 | 31 | 49 | /Q | 1 |
| 00010010 | 12 | 18 | \$R | DC2 | 00110010 | 32 | 50 | /R | 2 |
| 00010011 | 13 | 19 | \$S | DC3 | 00110011 | 33 | 51 | /S | 3 |
| 00010100 | 14 | 20 | \$T | DC4 | 00110100 | 34 | 52 | /T | 4 |
| 00010101 | 15 | 21 | \$U | NAK | 00110101 | 35 | 53 | /U | 5 |
| 00010110 | 16 | 22 | \$V | SYN | 00110110 | 36 | 54 | /V | 6 |
| 00010111 | 17 | 23 | \$W | ETB | 00110111 | 37 | 55 | /W | 7 |
| 00011000 | 18 | 24 | \$X | CAN | 00111000 | 38 | 56 | /X | 8 |
| 00011001 | 19 | 25 | \$Y | EM | 00111001 | 39 | 57 | /Y | 9 |
| 00011010 | 1A | 26 | \$Z | SUB | 00111010 | 3A | 58 | /Z | : |
| 00011011 | 1B | 27 | %A | ESC | 00111011 | 3B | 59 | %F | ; |
| 00011100 | 1C | 28 | %B | FS | 00111100 | 3C | 60 | %G | < |
| 00011101 | 1D | 29 | %C | GS | 00111101 | 3D | 61 | %H | = |
| 00011110 | 1E | 30 | %D | RS | 00111110 | 3E | 62 | %I | > |
| 00011111 | 1F | 31 | %E | US | 00111111 | 3F | 63 | %J | ? |

TRAKKER Antares 2425 Hand-Held Terminal User's Manual

Full ASCII Table (continued)

| Binary ⁰ | Hex ¹ | Dec ² | C39 ³ | Char ⁴ | Binary ⁰ | Hex ¹ | Dec ² | C39 ³ | Char ⁴ |
|---------------------|------------------|------------------|------------------|-------------------|---------------------|------------------|------------------|------------------|-------------------|
| 01000000 | 40 | 64 | %V | @ | 01100000 | 60 | 96 | %W | ` |
| 01000001 | 41 | 65 | A | A | 01100001 | 61 | 97 | +A | a |
| 01000010 | 42 | 66 | B | B | 01100010 | 62 | 98 | +B | b |
| 01000011 | 43 | 67 | C | C | 01100011 | 63 | 99 | +C | c |
| 01000100 | 44 | 68 | D | D | 01100100 | 64 | 100 | +D | d |
| 01000101 | 45 | 69 | E | E | 01100101 | 65 | 101 | +E | e |
| 01000110 | 46 | 70 | F | F | 01100110 | 66 | 102 | +F | f |
| 01000111 | 47 | 71 | G | G | 01100111 | 67 | 103 | +G | g |
| 01001000 | 48 | 72 | H | H | 01101000 | 68 | 104 | +H | h |
| 01001001 | 49 | 73 | I | I | 01101001 | 69 | 105 | +I | i |
| 01001010 | 4A | 74 | J | J | 01101010 | 6A | 106 | +J | j |
| 01001011 | 4B | 75 | K | K | 01101011 | 6B | 107 | +K | k |
| 01001100 | 4C | 76 | L | L | 01101100 | 6C | 108 | +L | l |
| 01001101 | 4D | 77 | M | M | 01101101 | 6D | 109 | +M | m |
| 01001110 | 4E | 78 | N | N | 01101110 | 6E | 110 | +N | n |
| 01001111 | 4F | 79 | O | O | 01101111 | 6F | 111 | +O | o |
| 01010000 | 50 | 80 | P | P | 01110000 | 70 | 112 | +P | p |
| 01010001 | 51 | 81 | Q | Q | 01110001 | 71 | 113 | +Q | q |
| 01010010 | 52 | 82 | R | R | 01110010 | 72 | 114 | +R | r |
| 01010011 | 53 | 83 | S | S | 01110011 | 73 | 115 | +S | s |
| 01010100 | 54 | 84 | T | T | 01110100 | 74 | 116 | +T | t |
| 01010101 | 55 | 85 | U | U | 01110101 | 75 | 117 | +U | u |
| 01010110 | 56 | 86 | V | V | 01110110 | 76 | 118 | +V | v |
| 01010111 | 57 | 87 | W | W | 01110111 | 77 | 119 | +W | w |
| 01011000 | 58 | 88 | X | X | 01111000 | 78 | 120 | +X | x |
| 01011001 | 59 | 89 | Y | Y | 01111001 | 79 | 121 | +Y | y |
| 01011010 | 5A | 90 | Z | Z | 01111010 | 7A | 122 | +Z | z |
| 01011011 | 5B | 91 | %K | [| 01111011 | 7B | 123 | %P | { |
| 01011100 | 5C | 92 | %L | \ | 01111100 | 7C | 124 | %Q | |
| 01011101 | 5D | 93 | %M |] | 01111101 | 7D | 125 | %R | } |
| 01011110 | 5E | 94 | %N | ^ | 01111110 | 7E | 126 | %S | ~ |
| 01011111 | 5F | 95 | %O | - | 01111111 | 7F | 127 | %T ⁷ | n ⁸ |

Notes for the Full ASCII Table:

- 0 Bit positions are 76543210.
- 1 Hexadecimal value
- 2 Decimal value
- 3 Code 39 character(s)
- 4 ASCII character
- 5 SP is the SPACE character.
- 6 The Code 39 characters /P through /Y may be interchanged with the numbers 0 through 9.
- 7 May be interchanged with %X or %Y or %Z.
- 8 n is the DELETE character.

Full ASCII Control Characters Table

| Control Character | Definition | Control Character | Definition |
|-------------------|---------------------|-------------------|-------------------------|
| NUL | Null, or all zeroes | DC1 | Device Control 1 (XON) |
| SOH | Start of Heading | DC2 | Device Control 2 |
| STX | Start of Text | DC3 | Device Control 3 (XOFF) |
| ETX | End of Text | DC4 | Device Control |
| EOT | End of Transmission | NAK | Negative Acknowledge |
| ENQ | Enquiry | SYN | Synchronous Idle |
| ACK | Acknowledgment | ETB | End Transmission Block |
| BEL | Bell | CAN | Cancel |
| BS | Backspace | EM | End of Medium |
| HT | Horizontal Tab | SUB | Substitute |
| LF | Line Feed | ESC | Escape |
| VT | Vertical Tab | FS | File Separator |
| FF | Form Feed | GS | Group Separator |
| CR | Carriage Return | RS | Record Separator |
| SO | Shift Out | US | Unit Separator |
| SI | Shift In | SP | Space |
| DLE | Data Link Escape | DEL | Delete |

Full ASCII Bar Code Chart

The charts in this section list the Code 39 bar code label for each ASCII character. To use these bar code labels, you must configure the TRAKKER 2425 terminal to use Code 39 in Full ASCII mode. For help, see "Code 39" in Chapter 8.

Control Characters

NUL



%U

SOH



%A

STX



\$B

ETX



\$C

EOT



\$D

ENQ



\$E

ACK



\$F

BEL



\$G

BS



\$H

HT



\$I

LF



\$J

VT



\$K

FF



\$L

CR



\$M

SO



\$N

SI



\$O

DLE



\$P

DC1



\$Q



Control Characters (continued)

DC2



\$R

DC3



\$S

DC4



\$T

NAK



\$U

SYN



\$V

ETB



\$W

CAN



\$X

EM



\$Y

SUB



\$Z

ESC



%A

FS



%B

GS



%C

RS



%D

US



%E

DEL



%T

Symbols and Punctuation Marks

! (exclamation point)



/A

" (quotation marks)



/B

#



/C

\$



/D

%



/E

&



/F

' (apostrophe)



/G

(



/H

)



/I

* (asterisk)



/J

+



/K

- (dash)



/M

/



/O

=



/%H

. (period)



/N

, (comma)



/L

: (colon)



/Z

; (semicolon)



/%F

?



/%J

<



/%G

>



/%I



Symbols and Punctuation Marks (continued)

@



%V

[



%K

]



%M

~ (tilde)



%S

^



%N

_ (underline)



%O

\



%L

` (left single quote)



%W

| (pipe)



%Q

{



%P

}



%R

Space



* *

Numbers

0



0

1



1

2



2

3



3

4



4

5



5

6



6

7



7

8



8

9



9

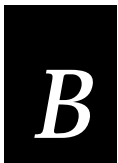

Uppercase Letters

A



A

B



B

C



C

D



D

E



E

F



F

G



G

H



H

I



I

J



J

K



K

L



L

M



M

N



N

O



O

P



P

Q



Q

R



R

S



S

T



T

U



U

Uppercase Letters (continued)

V

V

W

W

X

X

Y

Y

Z

Z

Lowercase Letters

a

+A

b

+B

c

+C

d

+D

e

+E

f

+F

g

+G

h

+H

i

+I

j

+J

k

+K

l

+L

m

+M

n

+N

o

+O



Lowercase Letters (continued)

p

+P

q

+Q

r

+R

s

+S

t

+T

u

+U

v

+V

w

+W

x

+X

y

+Y

z

+Z



Terminal Emulation Command Reference



This appendix provides a summary of available TE commands for all supported terminals. A keypad chart shows how to enter all characters on the TE keypad and lists bar codes for performing the same function. To scan the bar code labels in this appendix, you must configure the terminal to use Code 39 in Full ASCII mode. For help, see "Code 39" in Chapter 8.

3270 and 5250 TE Command Summary

These charts list the keypad sequences and the bar codes you can scan to perform 3270 and 5250 TE functions on the TRAKKER 2425 terminal.

3270 and 5250 TE Keypad

Use these keypads to enter terminal emulation functions for TRAKKER 2425 terminals running 3270 or 5250 terminal emulation.

TRAKKER Antares 2425 Hand-Held Terminal User's Manual

3270 and 5250 TE Keypads

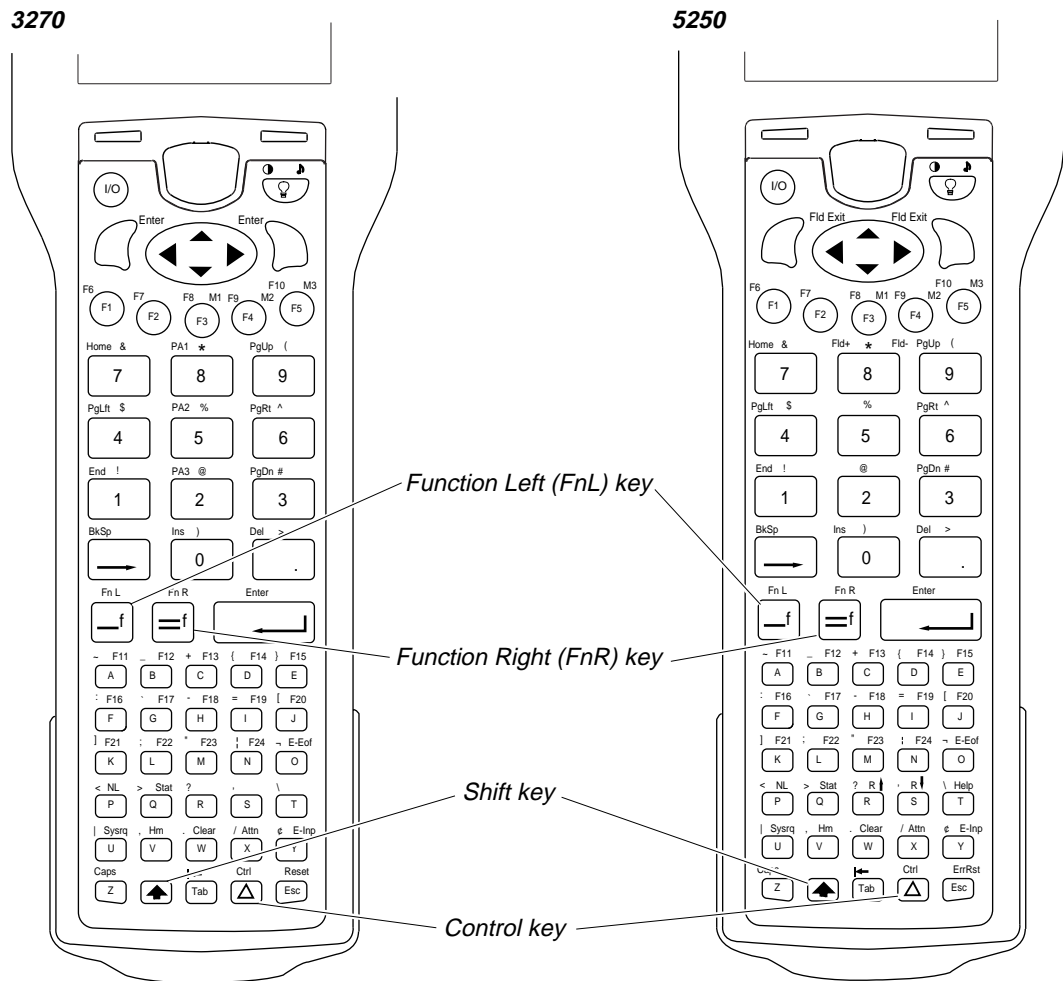

242XU.015



3270 and 5250 TE Command Summary

This chart lists the bar code labels for all 3270 and 5250 terminal emulation commands in alphabetical order.

3270 and 5250 Terminal Emulation Commands

| To Enter | Press the Key(s) | Or Scan This Bar Code |
|-----------------------------|---|--|
| Attention |   |  *%ATTN* |
| Backtab |   |  *%BTAB* |
| Clear |   |  *%CLR* |
| Cursor Home |   |  *%Hm* |
| Delete |   |  *%DEL* |
| End (viewport) |   |  *%END* |
| Enter (3270 Only) |  or  or  |  *<CR>* |
| Enter (5270 Only) |  |  *<CR>* |
| Enter TE Configuration Menu |   | Not supported. |

TRAKKER Antares 2425 Hand-Held Terminal User's Manual

3270 and 5250 Terminal Emulation Commands (continued)

| To Enter | Press the Key(s) | Or Scan This Bar Code |
|-----------------------------------|--|---|
| Erase Input |   |  *%EINP* |
| Erase to End of Field (3270 Only) |   |  *%EOF* |
| Error Reset (5250 Only) |   |  *%ERR* |
| Fast Cursor Left |   |  *%FCLT* |
| Fast Cursor Right |   |  *%FCRT* |
| Field+ (5250 Only) |   |  *%FLD+* |
| Field- (5250 Only) |   |  *%FLD-* |
| Field Exit (5250 Only) |  or  |  *%FLDX* |
| Help (5250 Only) |   |  *%HELP* |
| Home (viewport) |   |  *%HOME* |



3270 and 5250 Terminal Emulation Commands (continued)

| To Enter | Press the Key(s) | Or Scan This Bar Code |
|-----------------------|------------------|-----------------------|
| Insert | | *%INS* |
| New Line | | *%NL* |
| Page Down (viewport) | | *%PGDN* |
| Page Left (viewport) | | *%PGLT* |
| Page Right (viewport) | | *%PGRT* |
| Page Up (viewport) | | *%PGUP* |
| Reset (3270 Only) | | *%RST* |
| Roll Down (5250 Only) | | *%RODN* |
| Roll Up (5250 Only) | | *%ROUP* |
| Status | | *%STAT* |

3270 and 5250 Terminal Emulation Commands (continued)

| To Enter | Press the Key(s) | Or Scan This Bar Code |
|----------------------------|------------------|-----------------------|
| System Request | | *%SYSR* |
| Tab | | * <HT > * |
| Viewport Down 1 Line | | *%DN* |
| Viewport Left 1 Character | | *%LF* |
| Viewport Right 1 Character | | *%RT* |
| Viewport Up 1 Line | | *%UP* |





3270 and 5250 Additional Functions

These charts list the bar codes for additional 3270 and 5250 terminal emulation functions.



3270 and 5250 Additional Functions

| To Enter | Press the Keys | Or Scan This Bar Code |
|---------------|--|---|
| ¢ (cent sign) | <input type="text" value="_f"/> <input type="text" value="Y"/> |  *%CENT* |

5250 Only Additional Functions

| To Enter | Press the Keys | Or Scan This Bar Code |
|------------|--|--|
| Duplicate | <input type="text" value="_f"/> <input type="text" value="5"/> |  *%DUP* |
| Field Mark | <input type="text" value="_f"/> <input type="text" value="2"/> |  *%FM* |

3270 Only Additional Functions

| To Enter | Press the Keys | Or Scan This Bar Code |
|---------------------------|--|--|
| Program Attention Key PA1 | <input type="text" value="_f"/> <input type="text" value="8"/> |  *%PA1* |
| Program Attention Key PA2 | <input type="text" value="_f"/> <input type="text" value="5"/> |  *%PA2* |
| Program Attention Key PA3 | <input type="text" value="_f"/> <input type="text" value="2"/> |  *%PA3* |

VT100/220/320 and ANSI TE Command Summary

These charts list the keypad sequences and the bar codes you can scan to perform VTXXX/ANSI TE functions on the TRAKKER 2425 terminal.

VTXXX/ANSI TE Keypad

Use this keypad to enter terminal emulation functions for T2425 terminals running VTXXX/ANSI terminal emulation.

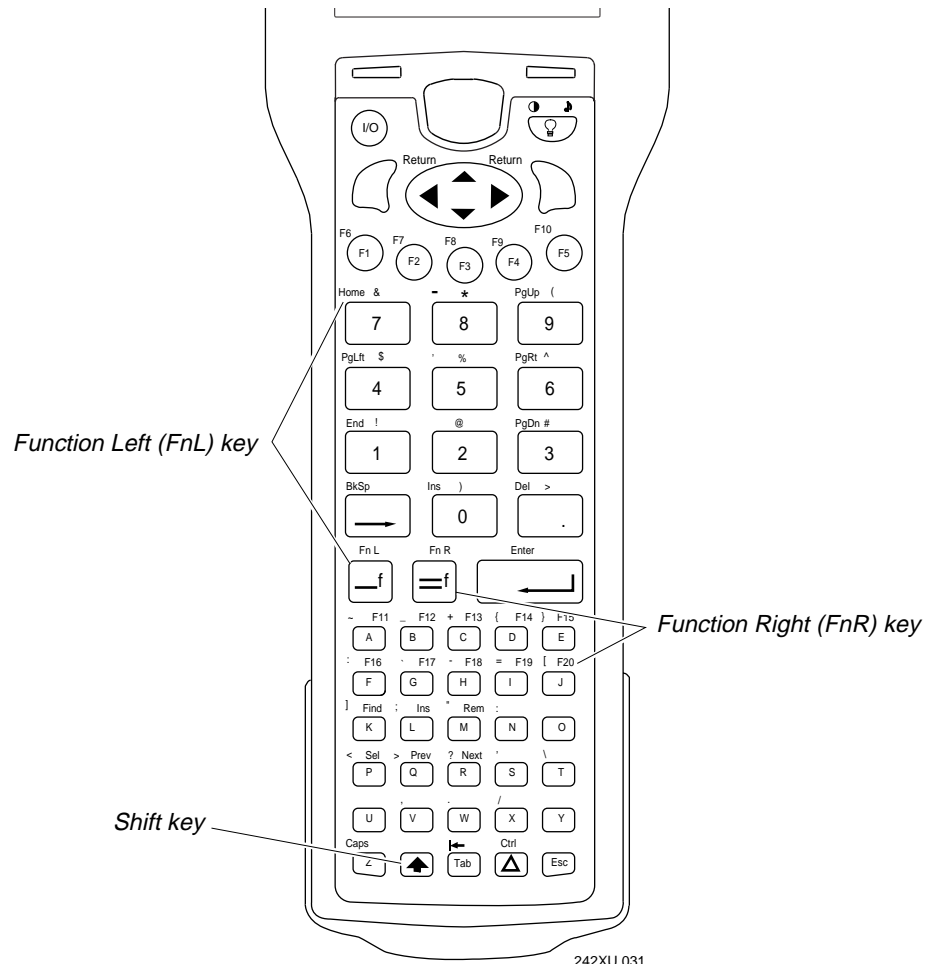



VTXXX/ANSI TE Command Summary

This chart lists the bar code labels for all VTXXX/ANSI terminal emulation commands in alphabetical order.

VTXXX and ANSI Terminal Emulation Commands

| To Enter | Press the Keys | Or Scan This Bar Code |
|-----------------------|----------------|-----------------------|
| Backspace | | *%BKSP* |
| End (viewport) | | *%END* |
| Find | | *%FIND* |
| Home (viewport) | | *%HOME* |
| Insert | or | *%INS* |
| Next Screen | | *%NEXT* |
| Page Down (viewport) | | *%PGDN* |
| Page Left (viewport) | | *%PGLT |
| Page Right (viewport) | | *%PGRT* |

VTXXX and ANSI Terminal Emulation Commands (continued)

| To Enter | Press the Keys | Or Scan This Bar Code |
|--------------------|---|--|
| Page Up (viewport) |   |  *%PGUP* |
| Previous Screen |   |  *%PREV* |
| Remove |   |  *%REM* |
| Select |   |  *%SEL* |



VTXXX/ANSI Additional Functions

This chart lists the bar codes for additional VTXXX/ANSI terminal emulation functions in alphabetical order.

VTXXX and ANSI Additional Functions

| To Enter | Press the Keys | Or Scan This Bar Code |
|--------------------------------|----------------|-----------------------|
| Accesses TE Configuration Menu | F1 | Not supported. |
| Exit TE (see Note below) | F2 | *%EXIT* |
| Changes to Character Mode | F4 | Not supported. |
| Changes to Line Mode | F8 | Not supported. |
| Viewport Down 1 Line | ▼ | *%DN* |
| Viewport Left 1 Character | ◀ | *%LP* |
| Viewport Right 1 Character | ▶ | *%RT* |
| Viewport Up 1 Line | ▲ | *%UP* |



















Note: Do not choose to exit the terminal emulation program. If you do accidentally exit TE, you may see an error message on the status line. Clear the error and continue.

Program Function Keys

These charts list the keypad sequences and the bar codes you can scan to execute function keys for 3270, 5250, and VTXXX/ANSI TE on the TRAKKER 2425 terminal.

Note: VT220/320 TE only supports function keys F1 through F20. VT100 only supports function keys F1 through F5.

Program Function Keys

| To Enter | Press the Key(s) | Or Scan This Bar Code |
|----------|---|--|
| F1 |  |  *%F1* |
| F2 |  |  *%F2* |
| F3 |  |  *%F3* |
| F4 |  |  *%F4* |
| F5 |  |  *%F5* |
| F6 |   |  *%F6* |
| F7 |   |  *%F7* |
| F8 |   |  *%F8* |



Program Function Keys (continued)

| To Enter | Press the Key(s) | Or Scan This Bar Code |
|----------|------------------|-----------------------|
| F9 | | *%F9* |
| F10 | | *%F10* |
| F11 | | *%F11* |
| F12 | | *%F12* |
| F13 | | *%F13* |
| F14 | | *%F14* |
| F15 | | *%F15* |
| F16 | | *%F16* |
| F17 | | *%F17* |
| F18 | | *%F18* |

Program Function Keys (continued)

| To Enter | Press the Key(s) | Or Scan This Bar Code |
|----------|---|---|
| F19 |   |  *%F19* |
| F20 |   |  *%F20* |
| F21 |   |  *%F21* |
| F22 |   |  *%F22* |
| F23 |   |  *%F23* |
| F24 |   |  *%F24* |



Glossary

0100 Access Point

A wireless bridge that allows RF packets to go from the Intermec 2.4 GHz RF network to the Ethernet network.

10BaseT, 10Base2, or 10Base5

An implementation of Ethernet IEEE (Institute of Electrical and Electronic Engineers) standards to describe the primary characteristics of the cabling system. The 10 signifies 10 Mbps. Base indicates that the type of signaling used is baseband. The T at the end means that twisted-pair cable is used. The number (2, 5, or 10) at the end indicates the maximum cable length in hundreds of meters.

3270 or 5250 terminal emulation

An application that allows Intermec devices to emulate an IBM 3270 or 5250 terminal.

Accumulate mode

Operating mode in which the terminal stores scanned information in the terminal's data buffer until the terminal receives an Enter command.

AID

Attention identifier. A character in a data stream indicating that the user has pressed a key, such as Enter, requesting an action by the system.

alphanumeric

Character set containing letters, numbers, and other characters, such as punctuation marks.

alphanumeric keypad

The alphanumeric keypad on the TRAKKER 2425 terminal has 56 keys to type alphabetic and numeric characters. Although the keypad is smaller than a desktop terminal keyboard, you use special keys on the terminal's keypad and press key combinations to access all the keys and functions.

ANSI

American National Standards Institute. A non-governmental organization responsible for establishing many standards, including a number of data communications and terminal standards.

API

Application programming interface. A well-defined interface to routines that an application can use to request and perform system-level tasks.

application

A software program or program package that makes calls to the operating system and manipulates data files allowing a user to perform a specific job.

ASCII

American Standard Code for Information Interchange. A standard 7-bit code usually transmitted with a parity bit for a total of 8 bits per character. Contrast with "EBCDIC."

ASCII control character

One of the first 32 characters (0 through 31 in decimal representation) in the ASCII character set. Each of these characters has a standard control function, such as backspace or carriage return.

audio signals

The terminal has a beeper and a clicker that produce audio signals to indicate terminal status. You can change the beep volume and enable or disable the keypad clicker with configuration commands.

Automatic mode

See Scanner mode.

automatic shutoff

A terminal configuration feature that defines the maximum time the terminal stays on when there is no activity. At automatic shutoff, the contents of terminal memory are saved and the terminal resumes when it is turned on again.

backlight

A light built into the terminal display to make it easier to view the display in dimly lit environments.

backup battery

See NiCad backup battery.

bandwidth

The size in hertz of the frequency range that a signal transmission occupies. Typical narrow band signals occupy a 25 KHz bandwidth. The 2.4 GHz radio frequency signal occupies a 1 MHz bandwidth.

bar code density

Number of data characters that can be represented in a linear unit of measure. Bar code density is often expressed in characters per inch.

bar code label

A label that contains a bar code symbol.

bar code symbology

A scheme for encoding data as bar code. Code 39, UPC/EAN, Interleaved 2 of 5, and Codabar are examples of different symbologies.

battery pack

See lithium-ion battery pack.

boot

Usually means to invoke a bootstrap process, which involves building up a system from some simple preliminary instructions or information. A boot invokes the BIOS boot sequence, clears all memory, and performs a complete power-on self test (POST) to ensure that the hardware and peripherals are operational. A boot initializes the system hardware for use by the system firmware and loads the default configuration currently stored in flash memory.

bridge

An internetworking device that incorporates the physical and data link layers of the OSI model and allows you to connect networks or subnetworks with similar architectures.

broadcast

A type of transmission in which a message sent from the host is received by many devices on the system.

cabled scanner

A wand, laser scanner, or other device that scans bar code information. A cabled scanner is connected to a bar code reader or terminal with a cable rather than being built into (integrated in) the reader or terminal.

CCD scanner

Charge-coupled device. A CCD scanner contains no moving parts and uses a light source to illuminate the entire symbol. A symbol is scanned electronically using the digitized image of a line through the symbol provided by the linear photodiode array.

CGA

Abbreviation for Color/Graphics Adapter. CGA is a video adapter board.

channel

The path for transmitting data from a device to the host computer. In RF networks, it is the frequency hopping sequence the radio card follows. The 2.4 GHz bandwidth can be divided into 15 channels.

check character

A character included within a message that performs a check to ensure the accuracy of the message.

check digit

A character included in a bar code whose value is used to do a mathematical check on the value of the decoded bar code to retain accuracy.

checksum

A calculated value that is used to test data integrity. Errors can occur when data is transmitted or when it is written to disk. One means of detecting such errors is the use of a checksum. A value is calculated for a given chunk of data by sequentially combining all the bytes of data with a series of arithmetic or logical operations. After the data is transmitted or stored, a new checksum is calculated and compared with the original one. If the checksums match, the transmission or storage was probably error free. If they do not match, an error occurred.

coaxial

A type of cable used to connect the Model 200 Controller directly to an IBM host. Coaxial cable consists of an outer layer of insulation, an outer conductor, another insulating layer, and a central conductor.

Codabar

A self-checking, discrete bar code symbology that has these 16 characters in its set: 0 to 9, dollar sign (\$), colon (:), slash (/), period (.), plus (+), and minus (-). Codabar is commonly used in libraries, blood banks, and air-parcel express applications. The American Blood Commission (ABC) Codabar requires that you retain the start/stop code digits when processing a Codabar symbol. The maximum density for a Codabar symbol is 12.8 characters per inch.

Code 11

A very high density, discrete, numeric bar code developed by Intermecc. The character set includes the numbers 0 through 9 and the dash character (-). Each character is represented by a standalone group of three bars with two included spaces. This code is not self-checking. One or two check digits provide data security. Code 11 is most extensively used in labeling telecommunications components and equipment. Its maximum density is 15 characters per inch.

Code 16K

A two-dimensional (stacked rows), ultra-high density bar code symbology. It is based on Code 128 and is used widely to label unit-dose packaging for the healthcare industry.

Code 2 of 5 (2 of 5)

A discrete, self-checking code for encoding numeric data only. The bars encode information and the spaces separate individual bars. It can achieve densities of 15 characters per inch.

Code 39

A discrete, variable length, and self-checking bar code symbology. The character set is uppercase A to Z, 0 to 9, dollar sign (\$), period (.), slash (/), percent (%), space (), plus (+), and minus (-). Code 39 can be extended to the full 128 ASCII character set by use of a two-character encoding scheme (see full ASCII). Its maximum density is 9.8 characters per inch.

Code 49

A multirow symbology for high data density. The last character in each row is used for row checking and the last two characters of the symbol are used for overall checking. The character set includes all 128 ASCII characters. Its maximum density is 93.3 alphanumeric characters per inch or 154.3 numeric characters per inch.

Code 93

A variable length, continuous bar code symbology using four element widths. It can be used interchangeably with Code 39 when higher density printing is required. The character set is the same as Code 39. Its maximum density is 14.8 characters per inch.

Code 128

A very high density alphanumeric symbology that supports the extended ASCII character set. It is a variable length, continuous code that uses multiple element widths. Code 128's high density makes it useful when printing data in a limited space. Its maximum density is 12.1 alphanumeric characters per inch or 24.2 numeric characters per inch.

Code One

A two-dimensional matrix symbology that is useful for applications such as small parts labels that do not have sufficient space for linear bar codes. In addition to data storage and error correction symbols, each Code One symbol contains a set of horizontal lines in the center, called a finder pattern, that helps bar code scanners quickly locate and identify each symbol. Code One symbols also contain vertical reference bars to help bar code scanners locate the relative positions of each data bit.

configuration

The selected parameters that determine the operating characteristics of an electronic device.

configuration command

A configuration command changes the way the terminal operates. You can enter a configuration command by typing on the keypad, by scanning a bar code label, or by sending a command from a device on the 2.4 GHz network.

controller IP address

Identifies the IP address assigned to the Model 200 Controller in the 2.4 GHz network.

data collection device

A device used with a scanner that collects data by scanning bar codes and sending this data to a host computer.

data transmission

An event in which a block of data is transmitted from one device to another.

default configuration

The values set for each configuration parameter when the terminal is shipped.

device

Any physical item that is attached to a computer. A terminal, a printer, a reader, and a controller are all devices.

direct sequencing

A radio frequency spread spectrum technique by which the transmitted signal is spread over a particular frequency range.

domain

The area within a LAN that defines a region administered by a controller or server. The domain is also called a subnetwork.

downline

A device that is at the terminal end of a connection to the computer is referred to as being downline. When devices are connected to a computer, they are connected in a "line." Downline is a direction relative to the computer. Contrast with "upline."

If more than one computer is connected in a line, the upline computers usually handle data processing and the downline computers usually handle data collection and sometimes data "preprocessing."

driver

Software or firmware that translates operating system requests (such as input/output requests) into a format that is recognizable by specific hardware, such as adapters.

EAN

European Article Numbering. International standard bar code for retail food packages corresponding to the Universal Product Code (UPC) in the United States. A terminal that is configured to decode EAN bar codes can decode UPC, but the reverse is not true. UPC code is a subset of EAN code.

EBCDIC

Extended Binary Coded Decimal Interchange Code. EBCDIC is a standard eight bit code developed by IBM. Contrast with "ASCII."

end device

The device in the data collection system that you use to collect and enter data.

edge triggering

A scanner trigger configuration that makes the laser turn on after you activate the scanner and stay on until you deactivate the scanner a second time. Simply releasing the Scan button or trigger on a cabled scanner does not turn the laser off. If the laser is left on, the scanner timeout turns the laser off. Contrast with "level triggering."

error message

A message from a device or program advising the user of an error that requires intervention to solve. For example, if you receive the error message "Unable to establish connection to host. Session ended." when you turn on the terminal, you may need to configure the terminal.

ESD

Electrostatic discharge. Transient, rapid transfer of charge between bodies at different electrostatic potentials:

- caused by direct contact.
- by arc-over of near proximity.
- induced by an electrostatic field.

Ethernet

A type of LAN that allows the transmission of computer data, audio data, and video data at 10 Mbps across a linear bus topology. Ethernet uses the access method known as Carrier Sense Multiple Access with Collision Detection (CSMA/CD). See the IEEE 802.3 standard for the specifications.

firmware

Software routines stored in read only memory (ROM). Unlike random access memory (RAM), ROM stays intact even without electrical power. The TRAKKER 2400 Menu System; terminal emulation or screen mapping application; TE Configuration Menu; and operating environment, firmware, and drivers are stored in firmware. Contrast with “software.”

fixed length

Characteristic of a bar code symbology in which the number of characters per symbol is predetermined. Opposite of variable length.

flash memory

A type of nonvolatile memory. Flash memory must be erased in blocks and is commonly used as a supplement to or replacement for hard disks in portable computers and data collection devices.



frequency hopping

A spread spectrum technique by which the band is divided into a number of channels and the transmissions hop from channel to channel in a predetermined sequence.



full ASCII

An operating mode that sets the terminal to properly decode Code 39 or Code 93 labels containing data that includes any of the 128 ASCII characters.

Function Left key

The Function Left key is a special key on the keypad. You use the  key to type characters or perform functions that are printed on the left side above the key. When you press , the key is held in a buffer and the Function Left key icon appears on the terminal's display. Once you press a key other than , the key combination is entered into the terminal and the icon disappears from the display.

Function Right key

The Function Right key is a special key on the keypad. You use the  key to type characters or perform functions that are printed on the right side above the key. When you press , the key is held in a buffer and the Function Right key icon appears on the terminal's display. Once you press a key other than , the key combination is entered into the terminal and the icon disappears from the display.

HIBC

Health Industry Bar Code standard. A modified version of Code 39 that has 43 characters, uses the modulus 43 check character, and reserves some character combinations for special usage.

home

The viewport's home position is the upper left corner of the TE or application screen.

host application

An application running remotely on a host computer.

host busy

The condition in which the host computer is processing a request and has not responded, or has not updated the screen. On a 3270 terminal, the OIA shows X-SYSTEM, X-CLOCK, or X-[]]. On a 5250 terminal, the OIA shows "II" (Input Inhibited).

host computer

If several computers are connected on a network, the controlling computer is the host computer. A host computer can be a desktop, laptop, or notebook PC.

human-readable

A character printed in a font that can be read by a human, as opposed to bar code symbology that can only be read by a machine.

input device

A wand, laser scanner, or other device that scans bar code information into the terminal.

Interleaved 2 of 5 code (I 2 of 5)

A high-density, self-checking, continuous numeric bar code symbology. A bar code developed by Intermec that encodes the digits 0 through 9. The name Interleaved 2 of 5 is derived from the method used to encode two characters. In this symbol, two characters are paired, using bars to represent the first character and interleaved spaces to represent the second character. Each character has two wide elements and three narrow elements for a total of five elements. Its maximum density is 7.8 characters per inch. I 2 of 5 is mainly used in inventory distribution and the automobile industry.

IP

Internet protocol. This is the protocol for the network layer in TCP/IP protocol. It acts as a router for frames and is also responsible for frame addressing. IP verifies it has all the frames to pass to the TCP layer and that they are in the correct order.

IP address

An internal TCP/IP protocol stack variable. This address is a network layer address that is assigned to each device in a TCP/IP network.

keypad buffer

An area of memory that saves a limited number of operator keystrokes.

keypad clicker

A feature that makes the terminal produce an audible click every time you press a key. This feature can be enabled or disabled with the Keypad Clicker configuration command.

LAN

Local area network. A group of intelligent workstations that are hooked together to allow them to share data, printers, and other devices. LANs are usually used over a small geographic area.

laser scanner

An optical bar code reading device that uses a low energy laser light beam to examine a spatial pattern, one part after another. It then generates analog or digital signals corresponding to the pattern. Laser scanners are often used in mark sensing, pattern recognition, character recognition, and bar code recognition. The laser scanner converts bar code symbols to electrical signals for input to a bar code reader decoder for processing and subsequent output through a data communications interface.

LCD

Liquid crystal display. A display comprised of groups of transparent anisotropic liquid segments that are switched between two transparent electrodes. Application of an electric field across a segment changes the reflectivity of the liquid and it becomes opaque.

LED

Light emitting diode. A semiconductor that produces light at a wavelength determined by its chemical composition. LEDs are often used as the light source in bar code readers and terminals.

level triggering

A scanner trigger configuration that makes the laser turn on after you activate the scanner and stay on until you release the Scan button or the trigger on a cabled scanner. Contrast with "edge triggering."

lithium-ion battery pack

Provides the main power source to operate the terminal. The lithium-ion battery pack is rechargeable and charges the backup battery when required.

local editing error

An error that occurs when a user performs an operation in a field that is not supported by the field's properties or definition. No data is sent when a local editing error occurs. For example, a local editing error occurs when a user enters characters in a numeric-only field.

logical partition

A logically distinct portion of memory or a storage device that functions as though it were a physically separate unit.

Model 200 Controller

A network controller that connects Intermecc's wired and wireless products to your local area network or directly to a host computer.

Modulus 43 check character

Check character derivation method for Code 39.

MSI code

MSI code includes a start pattern, data characters, one or two check digits, and a stop pattern. It is fixed length, continuous, and non self-checking. This code is used to mark retail shelves for inventory reordering. The character set is 0 to 9 plus additional symbols. Similar to "Plessey code."

multiple-read label

A bar code label that has a space as the first character after the start code. The terminal stores a multiple-read label in the buffer until you execute a command to transmit the label or scan a regular label. Contrast with "regular label."

NAU

Network addressable unit. A network address that allows a device to communicate with IBM hosts in a 3270 network.

network

A collection of devices that can store and manipulate electronic data, interconnected in such a way that their users can store, retrieve, and share information with each other.

network administrator

The person who is responsible for the installation, management, and control of a network.

network interface card (NIC)

An adapter card that is installed in the Model 200 Controller that allows it to connect to a network (for example, Ethernet, Token Ring, Twinaxial). The card contains both the hardware to accommodate the cables and the software to use the network's protocols. The NIC is also called a network adapter card.

network node

An end point in a network to which or from which data can be routed. Usually this is a workstation or host computer.

NiCad backup battery

The terminal contains a rechargeable NiCad backup battery that is designed to back up all memory and the real-time clock while you change the lithium-ion main battery pack. The NiCad battery will provide backup battery power for a maximum of 1 month if a fully-charged main battery pack is installed, or for a maximum of 3 days if a main battery pack is not installed.

null modem cable

A cable that connects two computers and allows transmission of data between them without requiring a modem.

One-Shot mode

See Scanner mode.

OSI model

Open Systems Interconnection reference model. A model for network communications consisting of seven layers that describe what happens when computers communicate with one another. The OSI model was developed by the International Standards Organization (ISO) to provide worldwide standards for computer communications.

packet

The unit of information that the network uses to communicate. A packet includes a single network message with its associated header, addressing information, data, and optional trailer. A packet can also be called a frame or datagram.

parameter

See configuration command.

partition

See logical partition.

PDF 417

A two-dimensional stacked symbology. Each row in the symbol includes start/stop characters, row identifiers, and symbol characters, which consist of four bars and four spaces each and contain the actual data. PDF 417 provides an extensive error detection and correction option that can recover up to 510 characters lost due to a damaged label or to an error in scanning.

peer-to-peer network

A type of LAN whose workstations are capable of being both clients and servers.

PIC

Peripheral interface controller. The PIC processor is an internal processor that manages the terminal's batteries.

pixel

Pixel element. One spot in a rectilinear grid of thousands of such spots that are individually "painted" to form an image produced on the screen by a computer or on paper by a printer. A pixel is the smallest element that display software can manipulate in creating letters, numbers, or graphics.

Plessey code

A fixed length, continuous, and non self-checking bar code symbology. Plessey code is pulse-width modulated. It includes a start character, data characters, an eight-bit cyclic check digit, a termination bar, and usually a reverse start character. Similar to "MSI code."

port

For hardware, a connecting component that allows a microprocessor to communicate with a peripheral device. For software, a memory address that identifies the physical circuit used to transfer information between a microprocessor and a peripheral device.

POST

Power-on self test. This test runs when you boot the terminal. The test ensures that the terminal's hardware and peripherals are operational.

postamble

A field of data that is sent after the data in a message. It is typically used to tag transactions from the bar code reader or terminal for rapid processing by the host, and it expands the data field (record) length. Similar to the "preamble."

power management

Software and procedures that extend the life of a terminal's lithium-ion main battery pack and NiCad backup battery.

preamble

Predefined data that is automatically appended to the beginning of entered data. Similar to the "postamble."

protected field

In word processing, preset data or an area that cannot be changed or overridden by an operator without altering the program. On a display device, a display field in which a user cannot enter, modify, or erase data. Contrast with "unprotected field."

protocol character

See ASCII control character.

protocol stack

A group of drivers that work together to span the layers in the network protocol hierarchy.

PSK

TRAKKER Antares Programmer's Software Kit. A library of software functions for creating applications on the TRAKKER Antares 2400 series terminals.

radio frequency (RF)

A frequency at which coherent electromagnetic radiation of energy is useful for communications purposes; roughly the range from 10 KHz to 300 GHz.

RAM

Random access memory. Memory that can be written into, or read, by locating any data address.

reader command

A reader command causes the terminal to perform a task. You can enter a reader command by typing on the keypad, by scanning a bar code label, or by sending a command from a device on the 2.4 GHz network.

regular label

A bar code label that takes the form of <start code data stop code>. A regular bar code label is executed when you scan it. Contrast with “multiple-read label.”

resume

When you press  to turn the terminal on, the terminal either resumes exactly where it was when you turned it off, or the terminal boots and restarts your application. Resume is controlled through the Resume Execution configuration command. Contrast with “Suspend mode.”

RF data collection system

Radio frequency data collection system in which the individual components communicate with each other by radio signals.

RF security identification (ID)

Defines the password for secured transmission and receipt of data between devices in the wireless network. To communicate, each 0100 Access Point and TRAKKER 2425 terminal must have matching security IDs.

ROM

Read only memory. Usually a small memory that contains often-used instructions, such as microprograms or system software. ROM is programmed during memory fabrication and cannot be reprogrammed.

router

A software and hardware connection between two or more subnetworks that permits traffic to be routed from one network to another based on the intended destinations of that traffic.

RS-232

Widely recognized protocol standard for serial binary data interchange. The standard covers the physical, electrical, and functional characteristics of the interface.

RS-232 is the standard American format for serial data transmission by cable (that is, from a computer terminal to a modem). RS-232 transmission uses a distinctive 25-pin connector, although in most cases not all the conductors are used. See serial.

scanner devices

Typically, a light-emitting device that reads a coded language. This type of device includes wands and laser scanners.

Scanner mode

Defines how the scanner operates when the trigger is pulled. There are two types of modes: One-Shot or Automatic. One-Shot mode requires you to activate the scanner each time you want to scan a bar code. Once you scan a bar code, the scanner turns off. Automatic mode allows you to activate the scanner once and scan a series of bar codes. When you release the Scan button or trigger on a cabled scanner, the scanner turns off. To scan the same bar code more than once, you must release the button or trigger, or scan a different bar code before attempting a second scan.

scanner timeout

Maximum time the scanner stays after you press the Scan button or activate a cabled laser scanner.

screen mapping

An application that allows you to map data fields from a smaller reader or terminal screen to larger 3270 or 5250 screens. This image can be stored in the host, in the Model 200 Controller, or on the local device.

script file

A file that provides instructions for navigating around host application screens. It also provides instructions for mapping transaction fields from the TRAKKER 2425 terminal to the host application screens.

serial

A communications scheme in which the bits of a byte are transferred one at a time. Often serial transmission is used to link host computers to terminals and PCs to printers.

server

A computer that is configured to provide services to the network.

session

A single runtime copy of a 3270 or 5250 terminal emulator, through which a host application can be accessed.

SNA (System Network Architecture)

The IBM architecture for supporting computer communications between dissimilar systems.

software

Coded instructions that direct the operation of a computer. A set of such instructions for accomplishing a particular task is referred to as a program. Contrast with “firmware.”

spread spectrum

A radio data transmission modulation technique by which the transmitted signal is spread over a bandwidth wider than the information bandwidth.

start/stop code (or character)

A special bar code character that provides the scanner with start and stop reading instructions as well as a scanning direction indicator. The start character is normally at the left hand end of a horizontally oriented symbol (bar code label). The stop character is normally at the right hand end of a horizontally oriented symbol. For Code 39, the asterisk (*) character is used.

store and forward

A method where messages are temporarily stored in the Model 200 Controller before they are transmitted to their destination. It is used when the upline network or host application is temporarily stopped.

subnet mask

An internal TCP/IP protocol stack variable. This mask is used in the IP protocol to separate the subnet address from the local IP address. The IP protocol performs a bit-wise AND on the IP address and the subnet mask. Each address segment represents one byte, where 255 converts to FF hex. This computation is used to find out if the Model 200 Controller and TRAKKER 2425 terminal are on different subnetworks.

For example, if the terminal IP address is 192.9.150.184 and the subnet mask is 255.255.255.0, the terminal is on the subnetwork 192.9.150.0.

subnetwork

See domain.

Suspend mode

The mode the TRAKKER 2425 terminal enters when you press $\text{\textcircled{I/O}}$ to turn off the terminal. In Suspend mode, the terminal saves all memory and turns off the power to most of the hardware. Contrast with "resume."

symbology

See bar code symbology.

TCP

Transmission control protocol. This is the protocol for the transport layer in the TCP/IP protocol. It provides a method for reliable, error-free, full-duplex communications between sender and receiver nodes. TCP takes long messages from higher layers and breaks them up before passing them to IP for transmission. TCP makes sure that the messages are in sequence when it receives them, and it retries failed transmissions.

TE Configuration Menu

A menu-driven application that lets you configure 3270, 5250, or VTXXX/ANSI terminal emulation parameters. You can access the TE Configuration Menu at any time during a terminal emulation session.

Telnet

The TCP/IP remote terminal protocol for connection to a login server.

terminal emulation (TE)

A device that is running terminal emulation looks like the terminal. For example, it uses no CPU, no RAM, and no hard disk. Two general classifications are devices running in Character mode and those running in Block mode. Character mode devices emulate VTXXX terminals where a character travels all the way from the host to a device and back. Block mode devices emulate 3270 or 5250 terminals where entire screens are sent to a device, the user fills in all the data fields on the device, and sends the entire screen back to the host.

terminal IP address

Identifies the IP address assigned to the TRAKKER 2425 terminal. The IP address you set on the terminal must match the address that is set on the Model 200 Controller.

terminal template

A file that contains a menu of screens for data collection devices. The template is downloaded to the terminal from the Model 200 Controller or you can use the screen mapping application on the terminal to request the template.

timeout

A defined time allowed for an event after which an alternate action is taken.

Token Ring

A type of LAN that transfers data at either 4 or 16 Mbps. It is a network transport technology in which a token is passed around a ring topology.

TRAKKER 2400 Menu System

A menu-driven application that lets you configure the terminal, view system information, and run diagnostics. You can access the TRAKKER 2400 Menu System while running any application.

transaction

A transaction is made up of a header and a group of fields. For example, a work order transaction might have a transaction type and three fields consisting of a work order number, part number, and due date.

twinaxial

A type of cable used to connect the Model 200 Controller directly to an IBM host. Twinaxial cables consist of an outer layer of insulation, an outer conductor, another insulating layer, and two side-by-side center conductors.

UDP

User datagram protocol. UDP protocol is an alternative to TCP. This protocol is the Internet standard for wireless devices. You can use UDP when you do not need a guaranteed delivery. You can also use UDP when you do not require all the services of TCP.

UDP Plus

This Intermec-designed protocol is based on UDP. UDP Plus improves the performance of devices in a mobile wireless environment. Intermec uses this protocol to communicate between the Model 200 Controller and TRAKKER 2425 terminals.

unprotected field

A displayed field in which a user can enter, modify, or delete data. Contrast with "protected field."

UPC/EAN code

A fixed length, numeric, continuous bar code symbology that uses four element widths. A terminal that is configured to decode EAN bar codes can decode UPC, but the reverse is not true. UPC code is a subset of EAN code. It is a numeric, 12-digit bar code symbology used extensively in retail, particularly the grocery industry. The character set is 0 to 9. Its maximum character density is 13.8 numeric characters per inch.

upline

A device that is at the computer end of a connection between a computer and a device is referred to as being upline. When devices are connected to a computer, they are connected in a "line." Upline is a direction relative to the device, in contrast to "downline."

If more than one computer is connected in a line, the upline computers usually handle data processing and the downline computers usually handle data collection and sometimes data "preprocessing."

***validation file***

An ASCII file that has one entry per line. A validation file is used to ensure that the information entered in the input fields of a screen mapping screen are correct. The file is read sequentially and the last line in the ASCII file must be <EOF>.

variable length

A type of symbology in which the number of characters per symbol is not restricted. Opposite of “fixed length.”

viewport

A method for viewing a full size terminal screen (25 lines x 80 characters) with the terminal's 16 x 20 display. You will only see 16 lines and 20 characters of data at one time. Use the terminal's display as a viewport to move around and see the entire screen.

volatile

Refers to memory that is not saved when power is lost or turned off.

VTXXX / ANSI terminal emulation

A straight-through terminal emulation that causes Intermec downline devices running terminal emulation to emulate a VT100, VT220, and VT320, or ANSI terminal.



Index

Symbols

- Ⓞ key
 - configuring to boot the terminal, 6-28
 - first time, turning on, 1-15
 - turning the terminal on and off, 1-29
- ☽ key, *See* backlight, key
- ◀, ▲, ▶, ▼ keys, *See* cursor, keys
- Ⓛ key, *See* Function Left key
- Ⓡ key, *See* Function Right key
- Ⓢ key, *See* Shift key
- ¢ (cent sign) command, 3270 and 5250, 9-22

Numbers

- 0100 Access Point
 - configuring, 4-7
 - diagnostic screen, defined, 6-54
 - roaming between, 4-14
 - verifying network communications, 1-27
- 10Base2 cable drop, 4-6
- 10BaseT cable drop, 4-6
- 2.4 GHz network
 - 0100 Access Point, configuring, 4-7
 - activating, 1-21, 8-43
 - equipment required, 4-6
 - illustrated, 1-14, 4-3 to 4-5
 - installing, overview, 1-14, 4-6
 - Model 200 Controller, configuring, 4-7
 - protocols, defined, 4-21 to 4-23
 - roaming between access points, 4-14
 - terminal, configuring, 4-8
- 3270 and 5250 screen mapping, *See* screen mapping
- 3270 and 5250 terminal emulation
 - auto-advancing through fields, 5-14
 - bar code labels for commands, C-5 to C-9
 - commands
 - ¢ (cent sign) command, 9-22
 - Attention, 9-3
 - Backtab, 9-4
 - Clear, 9-4
 - Cursor Home, 9-5
 - Delete, 9-5
 - Duplicate, 9-22

- End, 9-5
- Enter, 9-6
- Enter TE Configuration Menu, 9-6
- Erase Input, 9-6
- Erase to End of Field, 9-7
- Error Reset, 9-7
- Fast Cursor Left or Right, 9-8
- Field-, 9-9
- Field+, 9-9
- Field Exit, 9-10
- Field Mark, 9-22
- Help, 9-10
- Home, 9-11
- Insert, 9-11
- New Line, 9-11
- Paging Keys, 9-12
- Reset, 9-13
- Roll Down, 9-13
- Roll Up, 9-13
- Scroll Viewport, 9-14
- Status, 9-15
- System Request, 9-15
- Tab, 9-16
- functions, additional, 9-22, C-9
- keypads
 - chart, for entering characters, 2-10
 - illustrated, 5-7, C-3
 - using, 2-4 to 2-9, 5-6
- parameters, configuring, 5-8
- program function keys, 9-17, C-14
- roll keys, defined, 5-35
- starting, 1-25, 5-4
- TE Configuration menu, exiting, 5-12
- troubleshooting, 6-15 to 6-17
- unsupported functions, 5-25
- using, 5-5

A

- ABC Codabar, 8-10
- About TRAKKER 2400 screen, defined, 3-7
- access point, *See* 0100 Access Point
- Access Point screen, defined, 6-54
- accessories for the terminal, 1-4
- Accumulate mode, using reader commands, 7-4

TRAKKER Antares 2425 Hand-Held Terminal User's Manual

- additional TE functions
 - 3270 and 5250, 9-22, C-9
 - VTXXX/ANSI, 10-10, C-13
 - address
 - controller IP, configuring, 8-29
 - default router, configuring, 8-32
 - IP, defined, 4-9
 - terminal IP, configuring, 8-64
 - AIAG check digit, Code 39, 8-18
 - alphanumeric keypad, *See* keypad
 - American Blood Commission, *See* ABC Codabar
 - ANSI terminal emulation
 - keypad
 - illustrated, 5-18, C-10
 - using, 5-17
 - parameters, configuring, 5-19
 - terminal type, selecting, 5-20
 - using, 5-16
 - See also* VTXXX/ANSI terminal emulation
 - Antares, *See* TRAKKER 2425 terminal
 - antenna
 - ordering parts, 6-31
 - replacing, 6-32
 - Append Time command, 8-6
 - Application Events screen, defined, 6-40
 - Application mode, configuring, 5-21
 - applications
 - 3270 and 5250 screen mapping, 5-26
 - 3270 and 5250 terminal emulation, 5-5
 - host computer, developing, 4-17 to 4-20
 - options, described, 1-3, 5-3, A-4
 - restarting, 6-30, 7-13
 - starting, 1-25, 5-4
 - TRAKKER 2400 Menu System, using, 3-6 to 3-16
 - troubleshooting
 - 3270 and 5250, 6-15 to 6-17
 - screen mapping, 6-18 to 6-22
 - verifying network communications, 1-28
 - VTXXX/ANSI terminal emulation, 5-16
 - ARP, defined, 4-23
 - ASCII
 - bar code chart, B-6 to B-13
 - Code 39, full, 8-16
 - Code 39, mixed-full, 8-17
 - Code 39, non-full, 8-16
 - control characters
 - list of, B-5
 - postamble and preamble, entering, 3-12
 - table of character equivalents, B-3 to B-5
 - Attention command, 3270 and 5250, 9-3
 - audio signals
 - keypad clicks, enabling or disabling, 8-40
 - list of, 2-18
 - low battery, 2-34
 - testing, 6-46
 - volume, adjusting, 2-14, 8-8
 - auto-advancing through fields, configuring, 5-14
 - Automatic mode, configuring the scanner, 8-56
 - Automatic Shutoff command, 8-7
 - managing the battery power, 2-35
 - automatically turning the terminal off, 8-7
- ## **B**
- backlight
 - configuring the timeout, 8-34
 - key, using, 2-13
 - turning on and off, 2-13, 7-9
 - backspace
 - reader command, 7-6
 - VTXXX/ANSI command, 10-3
 - Backtab command, 3270 and 5250, 9-4
 - backup battery
 - charge status, 2-33, 6-45
 - charging, 1-13, 2-26
 - temperature range, A-4
 - cold temperatures, using in, 6-27
 - connecting, 1-6, 2-30
 - described, 2-19, 2-26
 - disposing of safely, 2-33
 - installing, 2-30
 - low battery charge, 2-34, 6-9
 - power specifications, A-3
 - power, managing, 6-26
 - removing, 2-27
 - temperature and volts, checking, 6-44
 - bar code labels
 - 3270 and 5250 commands, C-5 to C-9
 - ASCII chart, B-6 to B-13
 - bar code symbologies, enabling, 1-30

- bar code labels (*continued*)
 - conventions, defined, xx
 - creating, about start/stop codes, 8-3
 - decode security, configuring, 8-31
 - Multiple-Read labels, 7-12
 - quiet zone, defined, 2-41
 - reader commands, troubleshooting, 6-6, 6-11
 - regular labels, 7-12
 - rules for creating, 3-17
 - scanning
 - accumulating data, 7-4
 - configuring the terminal, 3-3, 3-17
 - learning to, 2-40
 - troubleshooting, 6-23 to 6-25
 - VTXXX/ANSI commands, C-11 to C-13
 - bar code symbolologies
 - choosing, 3-4
 - Codabar, configuring, 8-10
 - Code 1, configuring, A-5
 - Code 11, configuring, 8-12
 - Code 128, configuring, 8-23
 - Code 16K, configuring, 8-13
 - Code 2 of 5, configuring, 8-14
 - Code 39, configuring, 8-16
 - Code 49, configuring, 8-20
 - Code 93, configuring, 8-22
 - configuration commands, list of, 3-25, 8-4, A-7
 - enabling, quick reference, 1-30
 - list of, A-5
 - MSI, configuring, 8-41
 - PDF 417, configuring, A-5
 - Plessey, configuring, 8-45
 - troubleshooting bad decode, 6-6
 - UPC/EAN, configuring, 8-70
 - battery charger
 - charging the battery pack, 1-6, 2-25
 - cold temperatures, guidelines, 6-27
 - terminal accessory, described, 1-4
 - battery door, opening, 1-6, 2-20
 - Battery icon
 - blinks, low battery power, 6-9, 6-27
 - described, 2-17
 - low battery power, 2-34
 - remains on, low battery power, 6-8, 6-9
 - Battery Monitor screen, defined, 6-44
 - battery pack
 - charging, 1-6, 2-25
 - temperature range, A-4
 - cold temperatures, using in, 6-27
 - described, 2-19
 - installing, 1-9, 2-22
 - low battery charge, 2-34, 6-8
 - power
 - capacity remaining, 2-20, 2-33, 6-45
 - managing, 2-19, 2-35, 6-26
 - specifications, A-3
 - removing, 2-20
 - temperature and volts, checking, 6-44
 - terminal accessory, described, 1-4
 - Battery Status screen, defined, 6-45
 - beep
 - audio signals for status, 2-18
 - battery power low, 6-8, 6-9
 - Beep Volume command, 8-8
 - testing, using diagnostics, 6-46
 - three low beeps, troubleshooting, 6-11, 6-12
 - volume, adjusting from the keypad, 2-14
 - Beeper Test screen, defined, 6-46
 - belt clip, terminal accessory, 1-4
 - binary, table of ASCII characters, B-3 to B-5
 - blue keys, using, 2-6
 - Boot Menu
 - troubleshooting, 6-8
 - using, 6-29
 - booting the terminal, 6-28 to 6-30
 - configuration used, 3-19
 - configuring the $\text{\textcircled{C}}$ key, 6-28, 8-50
 - POST failed, error message, 6-8
 - turning on the terminal, 1-29
 - box, shipping, list of contents, 1-5
- ## C
- cabled scanners
 - configuring for scan module, 8-59
 - list for scan module, A-6
 - capitalizing characters
 - Keypad Caps Lock command, using, 8-39
 - keypad, using, 2-8
 - Caps Lock icon, described, 2-8, 2-15

TRAKKER Antares 2425 Hand-Held Terminal User's Manual

- cautions, defined, xvi
- CCD scanners
 - configuring for scan module, 8-59
 - list for scan module, A-6
- Center Viewport mode, configuring, 5-11, 5-23
- CGA-compatible display, described, 2-3, 2-11, A-4
- change configuration
 - configuration commands, using, 8-5
 - reader commands, using, 7-10
- Character mode, configuring for VTXXX/ANSI, 5-22
- characters, configuring
 - size for 3270 and 5250, 5-9
 - size for VTXXX/ANSI, 5-20
- charging batteries
 - backup battery, 1-13, 2-26
 - battery pack, 1-6, 2-25
 - cold temperatures, guidelines, 6-27
- check boxes in screens, 3-10
- clear
 - 3270 and 5250 command, 9-4
 - reader command, 7-6
- Clear Task Profiles screen, defined, 6-41
- Codabar command, 8-10
- Code 1, using, A-5
- Code 11 command, 8-12
- Code 128 command, 8-23
- Code 16K command, 8-13
- Code 2 of 5 command, 8-14
 - disabled with Interleaved 2 of 5, 8-37
- Code 39
 - configuration command, 8-16
 - creating bar code labels, 8-3
 - table of ASCII characters, B-3 to B-5
- Code 49 command, 8-20
- Code 93 command, 8-22
- cold temperatures, guidelines for using in, 2-11, 2-19, 2-26, 6-27
- Command Processing command, 8-25 to 8-28
- commands
 - 3270 and 5250 TE, 9-3, C-3
 - configuration commands, using, 8-3
 - conventions, defined, xxi
 - reader commands, using, 7-3
 - TRAKKER 2400 Menu System, selecting, 3-9
 - VTXXX/ANSI TE, 10-3, C-10
- communications
 - configuration commands, list of, 3-28, A-8
 - icons, using to monitor, 4-12
 - network protocols, defined, 4-21 to 4-23
 - network specifications, A-5
 - RF specifications, A-5
 - RF, using, 4-11
 - troubleshooting, 6-13
 - See also* network
- Communications screen, configuring
 - 3270 and 5250, 5-10
 - VTXXX/ANSI, 5-22
- computer, *See* host computer
- configuration commands
 - Append Time, 8-6
 - Automatic Shutoff, 8-7
 - Beep Volume, 8-8
 - category, listed by, 8-4
 - Codabar, 8-10
 - Code 11, 8-12
 - Code 128, 8-23
 - Code 16K, 8-13
 - Code 2 of 5, 8-14
 - Code 39, 8-16
 - Code 49, 8-20
 - Code 93, 8-22
 - Command Processing, 8-25 to 8-28
- configuring
 - from controller, 4-15
 - from host, 4-17 to 4-20
 - overview of, 3-3
- Controller IP Address, 8-29
- Decode Security, 8-31
- Default Router, 8-32
- default settings, list of, A-7 to A-9
- Display Backlight Timeout, 8-34
- Display Contrast, 8-36
- Interleaved 2 of 5, 8-37
- Keypad Caps Lock, 8-39
- Keypad Clicker, 8-40
- MSI, 8-41
- Network Activate, 8-43
- Network Loopback, 8-44

- configuration commands (*continued*)
 - Plessey, 8-45
 - Postamble, 8-46
 - Preamble, 8-48
 - recording the configuration, 3-25 to 3-30
 - Resume Execution, 8-50
 - RF Domain, 8-51
 - RF Security ID, 8-52
 - RF Wakeup On Broadcast, 8-54
 - Scan Ahead, 8-55
 - Scanner Mode, 8-56
 - Scanner Redundancy, 8-57
 - Scanner Selection, 8-59
 - Scanner Timeout, 8-60
 - Scanner Trigger, 8-61
 - scanning labels to configure the terminal, 3-17
 - Subnet Mask, 8-62
 - syntax, listed by, A-10
 - Terminal IP Address, 8-64
 - Time and Date, 8-66
 - Time in Seconds, 8-67
 - troubleshooting, 6-11, 6-12
 - UDP Port, 8-68
 - UPC/EAN, 8-70
 - using, 8-3
 - variable data, entering, 8-5
- configuration file not found screen, 1-16, 1-25
- Configuration Menu
 - exiting and saving changes, 3-14
 - options defined, 3-7
 - problems while exiting, 6-10, 6-11
 - terminal emulation, configuring, 5-8, 5-19
 - See also* TE Configuration menu
- configuring
 - 0100 Access Point, 4-7
 - 2.4 GHz network, overview, 1-14, 4-6
 - 3270 and 5250 parameters, 5-8
 - bar code symbologies, 1-30
 - choosing, 3-4
 - booting the terminal on resume, 6-28
 - Change Configuration command, using, 7-10
 - controller IP address, 1-21
 - Default Configuration command, using, 7-11
 - default configuration, restoring, 3-21, 6-6
 - default settings, list of, A-7 to A-9
 - firmware, upgrading, 3-23
 - Model 200 Controller, 4-7
 - network activate parameter, 1-21
 - network parameters, 1-17 to 1-24
 - defined, 4-8
 - operating parameters, described, 3-5
 - overview of configuration parameters, 3-3
 - recording the configuration, 3-25 to 3-30
 - remotely over the network, 4-15
 - RF domain, 1-23
 - RF security ID, 1-23
 - scanning bar code labels, 3-17
 - summary of methods, 3-3
 - terminal IP address, 1-22
 - terminal, from host, 4-17 to 4-20
 - terminal, from the controller, 4-15
 - time and date, 1-17
 - TRAKKER 2400 Menu System, using, 3-6 to 3-16
 - troubleshooting, 6-10 to 6-12
 - VTXXX/ANSI parameters, 5-19
 - Connect icon
 - blinks, troubleshooting, 1-27, 4-13, 6-13, 6-14
 - described, 2-16
 - not displayed, troubleshooting, 1-27, 4-12, 6-13
 - remains on for communications, 1-27, 4-13
 - connecting the backup battery, 1-6, 2-30
 - contrast, adjusting the display, 2-14, 8-36
 - control characters
 - bar code labels to scan, B-6
 - full ASCII, list of, B-5
 - controller, *See* Model 200 Controller
 - controller IP address
 - configuration command, 8-29
 - configuring, 1-21
 - defined, 4-9
 - conventions
 - bar codes, defined, xx
 - commands, defined, xxi
 - keypad, defined, xix
 - screens and messages, defined, xx
 - warnings and cautions, defined, xvi
 - country code, displayed, 6-49
 - Ctrl key icon, described, 2-15

cursor

- keys, using, 2-9, 5-32
 - mode, configuring for VTXXX/ANSI, 5-21
 - viewport modes, configuring, 5-11, 5-23
- Cursor Home command, 3270 and 5250, 9-5
- customizing the terminal, 3-3

D

Data icon

- blinks, data transmitting, 4-13
 - described, 2-17
 - remains on, data buffered, 4-13
- data, accumulating in commands, 7-4, 8-5
- decimal

- key code values, displaying, 6-50
- table of ASCII characters, B-3 to B-5

Decode Security command, 2-42, 8-31

default configuration

- list of, 3-25 to 3-30, A-7 to A-9
- reader command, 7-11
- restoring, 3-21, 6-6

default router

- 2.4 GHz network, illustrated, 4-5
- configuration command, 8-32
- defined, 4-10
- determining when to configure, 4-8

Delete command, 3270 and 5250, 9-5

density of bar code for scanning, A-6

depth of field, scan module, A-6

Destructive RAM Test screen, defined, 6-47

diagnostics

- Access Point screen, defined, 6-54
- Application Events screen, defined, 6-40
- Battery Monitor screen, defined, 6-44
- Battery Status screen, defined, 6-45
- Beeper Test screen, defined, 6-46
- Clear Task Profiles screen, defined, 6-41
- Destructive RAM Test screen, defined, 6-47
- Diagnostics Menu, using, 6-37
- Display Test screen, defined, 6-48
- Error Logger screen, defined, 6-42
- Hardware Configuration screen, defined, 6-49
- Keypad Test screen, defined, 6-50
- Radio Test screen, defined, 6-51
- RS-232 Loop Back screen, defined, 6-52

Scanner Test screen, defined, 6-53

Subsystem Versions screen, defined, 6-55

summary of, 6-35

Suspend-Resume screen, defined, 6-56

Task Status screen, defined, 6-43

tests and screens, defined, 6-39 to 6-56

TRAKKER 2400 Menu System, using, 6-36

dimensions, of the terminal, A-3

display

- adjusting from the keypad, 2-13
- backlight on and off, 7-9
- backlight timeout, configuring, 8-34
- contrast, adjusting, 2-14, 8-36
- conventions, defined, xx
- EBCDIC exceptions, 5-30

icons

- Battery, 2-17, 2-34
- Caps Lock, 2-15
- Connect, 2-16
- Ctrl, 2-15
- Data, 2-17
- Function Left, 2-15
- Function Right, 2-15
- Radio, 2-16
- Shift, 2-15
- Viewport, 2-17

overview of using, 2-11

specifications, A-4

status line, described, 5-13

text size, configuring

- 3270 and 5250, 5-9
- VTXXX/ANSI, 5-20

troubleshooting, 6-48

viewport, using, 2-12, 5-30

Display Backlight Timeout command, 8-34

Display Contrast command, 8-36

Display Test screen, defined, 6-48

disposing, NiCad backup battery, 2-33

documentation

- bar code conventions, defined, xx
- command conventions, defined, xxi
- guide to learning tasks, 1-32
- keypad conventions, defined, xix
- manuals, list for reference, xxii
- screen and message conventions, defined, xx

- documentation (*continued*)
 - shipping box, list of contents, 1-5
 - summary of each chapter, xvii
 - warnings and cautions, defined, xvi
- domain, *See* RF domain
- double high text, configuring
 - 3270 and 5250, 5-9
 - VTXXX/ANSI, 5-20
- Duplicate command, 5250 TE, 9-22
- E**
- EAN-8, enabling, 8-70
- EBCDIC
 - display exceptions, 5-30
 - keys, 3270 and 5250, 9-22
- edge triggering, configuring the scanner, 8-61
- editing keys, VTXXX/ANSI
 - keypad, finding on, 5-17
 - list of, 10-3 to 10-6
- End command
 - 3270 and 5250, 9-5
 - VTXXX/ANSI, 10-3
- Enter
 - 3270 and 5250 command, 9-6
 - reader command, using, 7-7
- Enter Accumulate mode
 - configuration commands, using, 8-5
 - reader commands, using, 7-6
- Enter TE Configuration Menu command, 9-6
- entering data
 - chart of key sequences, 2-10
 - configuration commands, using, 8-5
 - keypad, using, 2-6
 - reader commands, using, 7-4
 - roaming between access points, 4-14
 - scan module, using, 2-37
 - terminal locked up, 6-7, 6-30
 - TRAKKER 2400 Menu System, using, 3-10
- environmental specifications, A-3 to A-6
- equipment, required for network, 4-6
- Erase Input command, 3270 and 5250, 9-6
- Erase to End of Field command, 3270 TE, 9-7
- Error Logger screen, defined, 6-42
- error messages
 - 3270 and 5250 TE, 6-15 to 6-17
 - audio signals, list of, 2-18
 - Communications Menu configuration
 - error, 6-10
 - POST failed, 6-8
 - screen mapping, 6-18 to 6-22
 - Unable to connect to controller, 6-14
 - Error Reset command, 5250 TE, 9-7
 - escape characters, entering in screens, 3-13
 - ethernet
 - cabling requirements, 4-6
 - network, illustrated, 4-3 to 4-5
 - European Article Numbering, *See* UPC/EAN command
 - Event Group Menu, using, 6-40
 - examples, remotely configuring the
 - terminal, 4-19, 4-20
 - Exit Accumulate mode
 - configuration commands, using, 8-5
 - reader commands, using, 7-7
 - exiting
 - Configuration Menu, 3-14
 - screens, 3-14
 - TE Configuration menu, 5-12, 5-24
 - TRAKKER 2400 Menu System, 3-15
- F**
- Fast Cursor Right or Left command, 3270 and 5250, 9-8
- features, described, 1-3, 2-3
- Field- command, 5250 TE, 9-9
- Field+ command, 5250 TE, 9-9
- Field Exit command, 5250 TE, 9-10
 - configuring to auto-advance, 5-14
- Field Mark command, 5250 TE, 9-22
- Find command, VTXXX/ANSI, 10-4
- firmware
 - applications, restarting, 6-30, 7-13
 - upgrading
 - Boot Menu, using, 6-29
 - TRAKKER 2400 Menu System, using, 3-23
 - versions, listed, 6-55

TRAKKER Antares 2425 Hand-Held Terminal User's Manual

flash memory
 default configuration, saving, 7-11
 described, 2-36
 saving configuration changes, 3-15, 3-19
 specifications, A-5

Follow Cursor mode, configuring, 5-11, 5-23

full ASCII
 bar code chart of characters, B-6 to B-13
 Code 39, described, 8-16
 table of characters, B-3 to B-5

Function Code 1
 Code 128, using with, 8-24
 Code 16K, enable with, 8-13
 Code 49, enable with, 8-20

Function Code 2, Code 49, 8-20

Function Code 3, Code 49, 8-20

Function keys
 3270 and 5250, list of, 9-17, C-14
 VTXXX/ANSI, list of, 10-7, C-14

Function Left key
 icon, described, 2-15
 using, 2-7

Function Right key
 icon, described, 2-15
 using, 2-7

functions, unsupported for TE, 5-25

G, H

green keys, using, 2-6

handstrap, terminal accessory, 1-4

Hardware Configuration screen, defined, 6-49

Hardware Diagnostics menu
 diagnostic tests, defined, 6-44
 using, 6-38

hardware features, illustrated, 1-3, 2-3

Health Industry Bar Code, *See* HIBC, Code 39

height of text, configuring
 3270 and 5250, 5-9
 VTXXX/ANSI, 5-20

help
 5250 TE command, 9-10
 TRAKKER 2400 Menu System, using, 3-9

hexadecimal
 key code values, displaying, 6-50
 table of ASCII characters, B-3 to B-5

HIBC, Code 39, 8-18

holster, terminal accessory, 1-4

Home command
 3270 and 5250, 9-11
 VTXXX/ANSI, 10-4

horizontal reading angle for scanning, 2-42

host application, developing, 4-17 to 4-20

host computer
 not receiving data, troubleshooting, 6-14
 using to configure terminal, 4-17 to 4-20

host name, configuring
 3270 and 5250, 5-10
 VTXXX/ANSI, 5-23

humidity, operating and storage range, A-4

I

IBM 3270 terminal emulation, using, 5-5
 See also 3270 and 5250 terminal emulation

IBM 5250 terminal emulation, using, 5-5
 See also 3270 and 5250 terminal emulation

ICMP, defined, 4-23

icons, terminal display
 Battery, 2-17, 2-34
 Caps Lock, 2-8, 2-15
 communications, using to monitor, 4-12
 Connect, 2-16
 Ctrl, 2-15
 Data, 2-17
 Function Left, 2-7, 2-15
 Function Right, 2-7, 2-15
 Radio, 2-16
 Shift, 2-7, 2-15
 troubleshooting, 1-26, 6-13
 Viewport, 2-12, 2-17

input devices
 configuring for scan module, 8-59
 list for scan module, A-6
 troubleshooting, 6-23 to 6-25

Input mode, configuring for VTXXX/ANSI,
 5-22, 10-11

Insert command
 3270 and 5250, 9-11
 VTXXX/ANSI, 10-4

installing

- 0100 Access Point, 4-7
- 2.4 GHz network, overview, 1-14, 4-3 to 4-5
- backup battery, 1-6, 2-30
- battery pack, 1-9, 2-22
- Model 200 Controller, 4-7
- network, overview, 4-6
- scan module, 2-38

interface cable, connecting to scan module, 6-24

Interleaved 2 of 5 command, 8-37

- disabled with Code 2 of 5, 8-14

Intermec support services, xv

IP address, *See* address

J, K

JANUS 7010 imager, configuring for scan module, 6-24, A-6

key

, using, 2-13

, using, 2-7

, using, 2-7

, using, 2-7

conventions, defined, xix

cursor, using, 2-9, 5-32

paging, using, 5-33

- 3270 and 5250, list of, 9-12

VTXXX/ANSI, list of, 10-5

program attention for 3270 TE, 9-21

program function, list of, C-14

- 3270 and 5250, 9-17

VTXXX/ANSI, 10-7

roll, using for 5250 TE, 5-35

Scan button, using, 2-40

special keys, finding, 2-4

user-defined, configuring for

VTXXX/ANSI, 5-21

keypad

 key described, 1-29

 key, using, 2-13

 key, using, 2-7

 key, using, 2-7

 key, using, 2-7

3270 and 5250

- illustrated, 5-7, C-3

using, 5-6

characters, capitalizing, 2-8

chart, for entering characters, 2-10

conventions, defined, xix

cursor keys, using, 2-9

key code values, displaying, 6-50

options, described, 2-4, A-4

Scan button, using, 2-40

screen mapping, illustrated, 2-5

special keys, finding, 2-4

typing characters, 2-6

using, 2-4 to 2-9

VTXXX/ANSI

illustrated, 5-18, C-10

using, 5-17

Keypad Caps Lock command, 8-39

Keypad Clicker command, 8-40

Keypad mode, VTXXX/ANSI, 5-21

Keypad Test screen, defined, 6-50

L

labels, *See* bar code labels

laser scanner, *See* scan module

LEDs

scanning bar code labels, 2-40

troubleshooting, 6-25

letters, bar code labels to scan, B-11, B-12

level triggering, configuring the scanner, 8-61

lights, *See* LEDs

Line mode, configuring for VTXXX/ANSI, 5-22, 10-11

Load Default Values screen, using, 3-22

Loader Waiting screen, troubleshooting, 3-24

loader, using the Boot Menu, 6-29

lock up, troubleshooting, 6-7, 6-30

Login screen, illustrated, 1-26, 5-4

lowercase letters, bar code labels to scan, B-12

M

Main Board Menu, using, 6-44, 6-46, 6-47

Main Menu, options defined, 3-6

manual

audience and purpose, described, xvii

guide to learning tasks, 1-32

summary of each chapter, xvii

terminology, defined, xviii

TRAKKER Antares 2425 Hand-Held Terminal User's Manual

manuals, list for reference, xxii

memory

- described, 2-36

- flash, saving configuration changes, 3-15

- RAM, saving configuration changes, 3-14

- saving configuration changes, 3-19

- specifications, A-5

- suspend-resume, testing, 6-56

- troubleshooting, 6-47

Menu System, *See* TRAKKER 2400 Menu System

menus

- Configuration Menu, defined, 3-7

- Diagnostics Menu, defined, 6-38

- Main Menu, defined, 3-6

- System Menu, defined, 3-8

- TE Configuration, using, 5-9, 5-20

- TRAKKER 2400 Menu System, selecting, 3-9

messages

- conventions, defined, xx

- status line, described, 5-13

mixed-full ASCII, Code 39, 8-17

Model 200 Controller

- configuring, 4-7

- host name, configuring for terminal, 5-10, 5-23

- transaction ID, creating, 4-17

- using to configure terminal, 4-15

- verifying network communications, 1-27

module for cabled scanners

- input devices

 - configuring, 8-59

 - list of, A-6

- installing, 2-38

- specifications, A-6

- terminal accessory, described, 1-4

- troubleshooting, 6-23 to 6-25, 6-53

- using, 2-37

- See also* scan module or scanning

moving the viewport, modes described,

- 5-11, 5-23

MSI command, 8-41

Multiple-Read Labels reader command, 7-12

N

network

- communications

 - activating the 2.4 GHz network, 1-21, 8-43

 - configuration commands, list of, 8-4

 - controller IP address, configuring, 8-29

 - default router, configuring, 8-32

 - RF domain, configuring, 8-51

 - RF security ID, configuring, 8-52

 - subnet mask, configuring, 8-62

 - terminal IP address, configuring, 8-64

 - troubleshooting, 1-26, 6-13

 - UDP port, configuring, 8-68

- equipment required for 2.4 GHz, 4-6

- illustrated, 4-3 to 4-5

- installing, overview, 1-14, 4-6

- parameters, defined, 4-8

- protocols, defined, 4-21 to 4-23

- specifications, A-5

network activate

- configuration command, 8-43

- configuring, 1-21

- defined, 4-9

- enabled, verifying, 1-26

Network Applications screen, 6-40

Network Events screen, 6-40

Network Loopback command, 8-44

New Line command, 3270 and 5250, 9-11

Next Screen command, VTXXX/ANSI, 10-4

NiCad backup battery, *See* backup battery

non-full ASCII, Code 39, 8-16

non-recoverable errors, 3270 and 5250 TE, 6-15

notes, defined, xvi

numbers, bar code labels to scan, B-10

Numeric mode, configuring, 5-21

O

One-Shot mode, configuring the scanner, 8-56

operating the terminal

- configuration commands

 - list of, 3-29, 8-4, A-9

 - using, 8-3

operating the terminal (*continued*)
 configuration options, described, 3-5
 humidity range, A-4
 reader commands
 enabling or disabling, 8-25 to 8-28
 using, 7-3, 7-8
 temperature range, A-4
 troubleshooting, 6-6 to 6-9
 verifying network communications, 1-26
 Operational Assistant Menu, 5250 TE, 9-3
 optical parameters, standard range scan
 module, A-6
 orange keys, using, 2-6
 ordering replacement parts, 6-31
 OSI model, defining network protocols,
 4-21 to 4-23
 other keys, 3270 and 5250, 9-22, C-9

P

paging keys
 3270 and 5250, list of, 9-12
 using, 5-33
 VTXXX/ANSI, list of, 10-5
 parameters
 3270 and 5250, configuring, 5-8
 configuration, overview of, 3-3
 VTXXX/ANSI, configuring, 5-19
 PDF 417, using, A-5
 physical specifications, A-3 to A-6
 Plessey command, 8-45
 POST failed, error message, 6-8
 postamble
 ASCII control characters, entering, 3-12
 Field Exit, configuring to auto-advance, 5-14
 Postamble command, 8-46
 power management
 automatic shutoff, using, 8-7
 backup battery, using, 2-26
 battery capacity remaining, 2-33, 6-45
 battery pack, using, 2-19
 guidelines for, 2-35, 6-26
 low Battery icon, 2-17, 2-34
 resume, suspend, and boot, 8-50
 RF Wakeup On Broadcast, disabling, 8-54
 power, battery specifications, A-3

preamble
 ASCII control characters, entering, 3-12
 Field Exit, configuring to auto-advance, 5-14
 Preamble command, 8-48
 Preamble/Postamble screen, using, 3-12
 Previous Screen command, VTXXX/ANSI, 10-6
 print quality, bar code, 8-31, 8-57
 program attention keys, 3270 TE, 9-21, C-9
 program function keys
 3270 and 5250, 9-17, C-14
 VTXXX/ANSI, 10-7, C-14
 protocol stack, defined, 4-21 to 4-23
 punctuation marks, bar code labels to scan, B-8

Q

quiet zone, bar code labels, 2-41
 quotation marks in commands, using, 3-18,
 8-46, 8-48

R

radio
 country code, displayed, 6-49
 troubleshooting, 6-51
 Radio icon
 described, 2-16
 remains on, troubleshooting, 1-26, 4-12, 6-13
 Radio Test screen, defined, 6-51
 RAM
 default configuration, saving, 7-11
 described, 2-36
 saving configuration changes, 3-14, 3-19
 specifications, A-5
 troubleshooting, 6-47
 RDRANSI terminal type, selecting, 5-20
 Reader Command Menu, using, 3-11
 reader commands
 Accumulate mode, using, 7-4
 Backlight On and Off, 7-9
 Backspace, 7-6
 Change Configuration, 7-10
 Clear, 7-6
 configuring
 from controller, 4-15
 from host, 4-17 to 4-20
 Default Configuration, 7-11

- reader commands (*continued*)
 - enabling or disabling, 8-25 to 8-28
 - Enter, 7-7
 - Enter Accumulate mode, 7-6
 - Exit Accumulate mode, 7-7
 - Multiple-Read Labels, 7-12
 - operating commands, 7-8
 - Reset, 7-13
 - Scanner Trigger Off, 7-15
 - Scanner Trigger On, 7-14
 - Test and Service Mode, 7-15
 - troubleshooting, 6-6, 6-11
 - using, 7-3
- recoverable errors, 3270 and 5250 TE, 6-15
- Remove command, VTXXX/ANSI, 10-6
- removing
 - backup battery, 2-27
 - battery pack, 2-20
 - scan module, 2-38
- replacement parts, ordering, 6-31
- reset
 - 3270 command, 9-13
 - reader command, 7-13
- resetting the terminal, 6-28 to 6-30, 7-13
 - default configuration, restoring, 3-21
 - firmware and hardware, 6-30
 - firmware, upgrading, 3-23
- resume
 - booting the terminal on, 6-28
 - described, 1-29
 - Resume Execution command, 8-50
- retaining ring, replacing on antenna, 6-32
- RF communications
 - 2.4 GHz network, illustrated, 1-14, 4-3 to 4-5
 - applications, using, 4-11
 - battery power, managing, 2-35
 - icons, using to monitor, 2-16, 4-12
 - roaming between access points, 4-14
 - site survey, planning, 4-6
 - specifications, A-5
 - See also* network
- RF domain
 - configuration command, 8-51
 - configuring, 1-23
 - defined, 4-9

- RF security ID
 - configuration command, 8-52
 - configuring, 1-23
 - defined, 4-9
 - not being saved, 6-10
- RF Wakeup On Broadcast command, 8-54
- roaming between access points, 4-14
- Roll Down command, 5250 TE, 5-35, 9-13
- Roll Up command, 5250 TE, 5-35, 9-13
- router, *See* default router
- RS-232 Loop Back screen, defined, 6-52
- runtime configuration, defined, 3-14, 3-19

S

- safety procedures, xv
 - disposing of the NiCad backup battery, 2-33
 - laser compliance and precaution information, 2-40
- saving configuration changes
 - Configuration Menu, exiting, 3-14
 - exiting screens, 3-14
 - flash memory, 3-19
 - TE Configuration menu, exiting, 5-12, 5-24
 - TRAKKER 2400 Menu System, exiting, 3-15
- Scan Ahead command, 2-42, 8-55
- Scan button, using, 2-40
- scan module
 - input devices
 - configuring, 8-59
 - list of, A-6
 - installing, 2-38
 - options, described, 2-37, A-6
 - troubleshooting, 6-23 to 6-25
 - using, 2-37
 - window, cleaning, 6-34
- Scanner LEDs, *See* LEDs
- Scanner Mode command, 2-42, 8-56
- Scanner Redundancy command, 2-42, 8-57
- Scanner Selection command, 2-43, 8-59
- Scanner Test screen, defined, 6-53
- Scanner Timeout command, 2-43, 8-60
- Scanner Trigger
 - configuration command, 2-43, 8-61
 - Off, reader command, 7-15
 - On, reader command, 7-14

- scanning
 - ASCII characters, list of labels, B-6 to B-13
 - bar code labels
 - 3270 and 5250 commands, C-5 to C-9
 - scan module, using, 2-40
 - VTXXX/ANSI commands, C-11 to C-13
 - button/trigger operation, configuring, 8-56
 - options, defined, 2-42
 - reader commands, using, 7-14
 - safety information, 2-40
 - Scan Ahead command, configuring, 8-55
 - standard range scan module, using, 2-40
 - timeout, configuring, 8-60
 - troubleshooting, 6-23 to 6-25
- screen, *See* display
- screen mapping
 - communications errors, 6-20
 - data entry errors, 6-21
 - downloading a template, 5-26
 - entering data in a screen, 5-27
 - initialization errors, 6-18
 - keypad
 - chart, for entering characters, 2-10
 - illustrated, 2-5
 - using, 2-4 to 2-9
 - Model 200 Controller, preparing, 4-7
 - requesting new template, 5-28
 - starting, 1-25, 5-4, 5-26
 - troubleshooting, 6-18 to 6-22
 - validating input, 5-29
- Scroll Viewport commands
 - 3270 and 5250, 9-14
 - VTXXX/ANSI, 10-10
- security ID, *See* RF security ID
- Select command, VTXXX/ANSI, 10-6
- Shift key
 - icon, described, 2-15
 - using, 2-7
- shipping box, list of contents, 1-5
- side boundary, configuring the viewport
 - 3270 and 5250, 5-11
 - VTXXX/ANSI, 5-23
- side jump, configuring the viewport
 - 3270 and 5250, 5-11
 - VTXXX/ANSI, 5-23
- Sign On screen, illustrated, 1-26, 5-4
- site survey, planning, 4-6
- Software Diagnostics menu
 - diagnostic tests, defined, 6-40
 - using, 6-38
- special keys, finding, 2-4
- specifications, physical and environmental,
 - A-3 to A-6
- standard alphanumeric keypad, 2-4
- standard range scan module
 - installing, 2-38
 - optical parameters, A-6
 - specifications, A-6
 - terminal accessory, described, 1-4
 - troubleshooting, 6-23 to 6-25, 6-53
 - using, 2-37, 2-40
 - window, cleaning, 6-34
 - See also* scan module or scanning
- start/stop codes
 - conventions, defined, xx
 - creating bar code labels, 8-3
- starting
 - applications, 1-25, 5-4, 5-26
 - configuring the terminal, 1-17 to 1-24
 - steps for using the terminal, 1-5
 - TE Configuration menu, 5-8, 5-19
 - TRAKKER 2400 Menu System, 3-6
 - turning on the terminal, 1-15
- Status command, 3270 and 5250, 9-15
- status line, turning on or off, 5-13
- Store Configuration screen, using, 3-20
- storing the terminal
 - batteries, managing, 2-26, 6-26
 - cold temperatures, guidelines, 6-27
 - humidity range, A-4
 - temperature range, A-4
- subnet mask
 - 2.4 GHz network, illustrated, 4-5
 - configuration command, 8-62
 - defined, 4-10
 - determining when to configure, 4-8
- subnetworks
 - terminal, using across, 4-4, 4-5
 - See also* network
- Subsystem Versions screen, defined, 6-55

Suspend mode

- automatic shutoff, using, 8-7
- battery power, managing, 2-35
- described, 1-29

Suspend-Resume screen, defined, 6-56

symbolologies, *See* bar code symbolologies

symbols, bar code labels to scan, B-8

syntax, configuration commands listed by, A-10

System Diagnostics menu

- diagnostic tests, defined, 6-54
- using, 6-38

System Menu, options defined, 3-8

system message flag, defined, 4-18

System Request

- command, 3270 and 5250, 9-15
- Menu, 5250 TE, 9-15

T

Tab command, 3270 and 5250, 9-16

Task Status screen, defined, 6-43

TE, *See* terminal emulation

TE Configuration menu

- 3270 and 5250
 - Communications screen, defined, 5-10
 - Terminal screen, defined, 5-9
 - Viewport screen, defined, 5-10
- exiting, 5-12, 5-24
- key sequence for starting, 5-8, 5-19
- VTXXX/ANSI
 - Communications screen, defined, 5-22
 - Terminal screen, defined, 5-20
 - Viewport screen, defined, 5-23

Telnet terminal types, listed, 5-3

temperature

- batteries, checking, 6-44
- operating and storage range, A-4
- terminal, using in cold areas, 6-27

template, screen mapping

- downloading from the controller, 5-26
- entering data in a screen, 5-27
- requesting new, 5-28

terminal, *See* TRAKKER 2425 terminal

terminal display, *See* display

terminal emulation

- application options, 5-3, A-4
- commands, list of
 - 3270 and 5250, 9-3 to 9-16, C-5 to C-9
 - VTXXX/ANSI, 10-3 to 10-6, C-11 to C-13
- display exceptions, 5-30
- icons, using to monitor, 4-12
- keypad options, 2-4, A-4
- RF communications, using, 4-11
- session, problems establishing, 6-14
- starting, 1-25, 5-4
- TE Configuration menu, using, 5-8, 5-19
- troubleshooting applications, 6-15 to 6-17, 6-18 to 6-22
- unsupported functions, 5-25
- verifying network communications, 1-26, 1-28
- viewport, using, 2-12, 5-30
- See also* 3270 and 5250 terminal emulation
- See also* screen mapping
- See also* VTXXX/ANSI terminal emulation

terminal IP address

- configuration command, 8-64
- configuring, 1-22
- defined, 4-9

Terminal mode, VT220/320, 5-21

Terminal screen, configuring

- 3270 and 5250, 5-9
- VTXXX/ANSI, 5-20

terminal type, VTXXX or ANSI, selecting, 5-20

terminology, defined, xviii

Test and Service Mode reader command, 7-15

text size, configuring

- 3270 and 5250, 5-9
- VTXXX/ANSI, 5-20

TFTP, defined, 4-21 to 4-23

time and date

- configuration command, 8-66
- configuring, 1-17
- defined, 4-9

Time in Seconds command, 8-67

timeout

- display backlight, configuring, 8-34
- scanner, configuring, 8-60

- TMF protocol
 - defined, 4-21 to 4-23
 - fields, defined, 4-18
 - terminal, remotely configuring, 4-17 to 4-20
- TPL file, requesting a template, 5-28
- TRAKKER 2400 Menu System
 - ASCII control characters, entering, 3-12
 - configuring the terminal, 3-6 to 3-16
 - default configuration, restoring, 3-21
 - Diagnostics Menu, using, 6-36
 - exiting, 3-15
 - firmware, upgrading, 3-23
 - flash memory, saving changes, 3-19
 - menus and commands, selecting, 3-9
 - network parameters, configuring, 1-17 to 1-24
 - screens, using, 3-10
 - starting, 3-6
 - Test and Service Mode, using, 7-15
- TRAKKER 2425 terminal
 - 2.4 GHz network, illustrated, 1-14, 4-3 to 4-5
 - accessories, list of, 1-4
 - bar code symbologies, enabling, 1-30
 - batteries, learning about, 2-19
 - booting and resetting, 6-28 to 6-30
 - configuring
 - from controller, 4-15
 - from host, 4-17 to 4-20
 - overview, 1-14
 - summary of methods, 3-3
 - default configuration, list of, A-7 to A-9
 - diagnostics, using, 6-35 to 6-56
 - dimensions, A-3
 - features, described, 1-3, 2-3
 - getting started, list of steps, 1-5
 - installing, overview, 4-6
 - keypad options, described, 2-4
 - manual, audience and purpose, xvii
 - memory, described, 2-36
 - network parameters, configuring, 4-8
 - network protocols, defined, 4-21 to 4-23
 - operating, troubleshooting, 6-6 to 6-9
 - physical and environmental specifications, A-3 to A-6
 - power, managing, 2-35, 6-26
 - recording the configuration, 3-25 to 3-30
 - resetting firmware and hardware, 6-30
 - terminology, defined, xviii
 - troubleshooting, guide to, 6-3, 6-4
 - turning on the terminal, 1-15
 - troubleshooting, 6-5
 - TRAKKER Antares screen, 1-15
 - transaction header, defined, 4-18
 - transaction ID, creating, 4-17
 - troubleshooting
 - 3270 and 5250 TE, 6-15 to 6-17
 - antenna, replacing, 6-32
 - audio signals, list of, 2-18
 - bar code symbologies, 1-30, 6-6, 6-24
 - batteries, 6-26
 - Boot Menu, using, 6-29
 - cleaning the terminal, 6-34
 - configuring the terminal, 6-10 to 6-12
 - diagnostics, using, 6-35 to 6-56
 - guide to finding problems, 6-3, 6-4
 - Intermec support services, xv
 - network communications, 1-26, 6-13
 - network loopback, using, 8-44
 - operating the terminal, 6-6 to 6-9
 - preventive maintenance, 6-31
 - scanning bar code labels, 6-23 to 6-25
 - screen mapping, 6-18 to 6-22
 - status line messages, 5-13
 - terminal locked up, 6-7, 6-30
 - terminal will not turn on, 6-5, 6-8
 - turning on the terminal
 - Ⓞ key described, 1-29
 - first time, getting started, 1-15
 - troubleshooting, 6-5, 6-8
 - typing characters on the keypad, 2-6, 2-10

U

- UCC/EAN Code 128, enabling, 8-23
- UDP Plus, defined, 4-21 to 4-23
- UDP Port command, 8-68
- Universal Product Code, *See* UPC/EAN command
- unpacking the terminal, 1-5
- UPC/EAN command, 8-70
- UPC-A/EAN-13, enabling, 8-70
- UPC-E, enabling, 8-70

- upgrading the firmware
 - Boot Menu, using, 6-29
 - Upgrade Firmware screen, using, 3-24
- uppercase letters, bar code labels to scan, B-11
- user-defined key, VTXXX/ANSI, 5-21

V

- validation file, downloading, 5-29
- variable data, entering in commands, 7-4, 8-5
- vehicle-mount holder, terminal accessory, 1-4
- vertical boundary, configuring the viewport
 - 3270 and 5250, 5-11
 - VTXXX/ANSI, 5-24
- vertical jump, configuring the viewport
 - 3270 and 5250, 5-11
 - VTXXX/ANSI, 5-24
- vertical reading angle for scanning, 2-42
- viewport
 - cursor keys, using, 5-32
 - described, 5-30
 - Follow Cursor mode, configuring the boundaries, 5-11, 5-23
 - icon, described, 2-17
 - illustration, using, 5-31
 - mode, configuring
 - 3270 and 5250, 5-11
 - VTXXX/ANSI, 5-23
 - movement keys, list of, 5-31, 9-14, 10-10
 - paging keys, using, 5-33
 - 3270 and 5250, 9-12
 - VTXXX/ANSI, 10-5
 - screen, configuring
 - 3270 and 5250, 5-10
 - VTXXX/ANSI, 5-23
 - using, 2-12, 5-30
- volume, adjusting the beep, 2-14, 8-8
- voting, Scanner Redundancy command, 8-57

- VTXXX/ANSI terminal emulation
 - additional functions, list of, 10-10, C-13
 - editing keys
 - Backspace, 10-3
 - End, 10-3
 - Find, 10-4
 - Home, 10-4
 - Insert Here, 10-4
 - keypad, finding on, 5-17
 - Next Screen, 10-4
 - Paging Keys, 10-5
 - Previous Screen, 10-6
 - Remove, 10-6
 - Select, 10-6
 - summary of commands, C-11 to C-13
 - keypad
 - chart, for entering characters, 2-10
 - illustrated, 5-18, C-10
 - using, 2-4 to 2-9, 5-17
 - parameters, configuring, 5-19
 - program function keys, list of, 10-7, C-14
 - starting, 1-25, 5-4
 - TE Configuration menu, exiting, 5-24
 - terminal mode, configuring, 5-21
 - unsupported functions, 5-25
 - using, 5-16
 - viewport, scroll commands, 10-10

W

- wands
 - configuring for scan module, 8-59
 - list for scan module, A-6
- warnings, defined, xvi
- warranty information, xv
- weight, of the terminal, A-3
- white keys, using, 2-6