



Parts for Trucks - Trailers &
Light Duty Vehicles

ANTI-VIBRATION COMPONENTS

*Proven, reliable and
always innovative.*

TRP provides aftermarket Anti-vibration parts for all brands of commercial equipment — including trucks, trailers, buses, engines and light duty vehicles — that surpass expectations for quality, dependability and value. Regardless of the age, make or application of your equipment, you can rely on TRP for a full line of replacement parts.



ANTI-VIBRATION FOR TRUCKS & TRAILERS

TRP IS THE ALL-MAKES ANSWER



Tested. Reliable. Proven.

Anti-vibration Components

Choosing the right replacement part or service for your vehicle—whether you own one, or a fleet—is one of the most important decisions you can make for your business. With tested TRP parts, it’s an easy decision.

TRP offers you a single aftermarket source for all your parts needs. TRP parts are manufactured and tested to exceed your expectations with a level of quality, value and reliability that is second to none.

TRP Catalog Disclaimers

Information and images have been provided by our network of suppliers and may not be reproduced in any manner without written permission. For further information on a product please contact customer service. TRP disclaims all responsibility for any loss, injury, liability or damage of any kind resulting from, arising out of or in any way related to errors or omissions from this publication, including but not limited to typographical errors.

The cross-reference information in this catalog is based upon data provided by several industry sources and our partners. While every attempt is made to ensure the information presented is accurate, we bear no liability due to incorrect or incomplete information.

Product Availability

Due to export restrictions and market demands, not all products are always available in every location. Check for availability in your area with your local TRP distributor.

No part of this marketing material may be reproduced in any manner without written permission from TRP North America.

TABLE OF CONTENTS

ANTI-VIBRATION COMPONENTS

CHALMERS ANTI-VIBRATION COMPONENTS

- [Rubber Spring](#) 1-6
- [Torque Rod Bush](#) 1-6
- [Torque Rod Bush](#) 1-7
- [Torque Rod Bush](#) 1-7
- [Torque Rod Bush](#) 1-8

FORD ANTI-VIBRATION COMPONENTS

- [Motor Mount](#) 1-9

FREIGHTLINER ANTI-VIBRATION COMPONENTS

- [Bolster Spring](#) 1-10
- [Bolster Spring Seat](#) 1-10
- [Cabin Mount](#) 1-11
- [Cabin Mount](#) 1-11
- [Engine Mount](#) 1-12
- [Engine Mount](#) 1-12
- [Engine Mount](#) 1-13
- [Equalizer Bushing](#) 1-13

TRP® North America

750 Houser Way N.
Renton, WA 98057

www.TRPParts.com

TRP IS THE ALL-MAKES ANSWER

Hood Cone 1-14

Hood Latch Kit, Left 1-14

Hood Latch Kit, Right 1-15

Hood Latch Kit, Right 1-15

Hood Latch Kit, Right/Left 1-16

Hook 1-16

Hook 1-17

Lower Pad, Spring Insulator 1-17

Motor Mount 1-18

Torque Rod Assembly 1-18

Torque Rod Bush 1-19

Upper Pad, Spring Insulator 1-19

FRUEHAUF ANTI-VIBRATION COMPONENTS

Equalizer Bush 1-20

Equalizer Shaft & Bushing Kit 1-20

Torque Arm Bushing Kit 1-21

HENDRICKSON ANTI-VIBRATION COMPONENTS

Beam End Bush 1-22

Beam End Bush 1-22

Bolster Spring Kit 1-23

Center Bushing 1-23

Center Bushing 1-24

Center Bushing 1-24

Load Cushion 1-25

Pivot Bush 1-25

Pivot Bush 1-26

Torque Rod Bush 1-26

Torque Rod Bush 1-27

Torque Rod Bush Assembly 1-27

Torque Rod Bush 1-28

Torque Rod Bush 1-28

Torque Rod Bush 1-29

Torque Rod Bush 1-29

Torque Rod Bush 1-30

Torque Rod Bush 1-30

HUTCHENS ANTI-VIBRATION COMPONENTS

Equalizer Bushing 1-31

Equalizer Bushing 1-31

Torque Rod Bush 1-32

INTERNATIONAL NAVISTAR ANTI-VIBRATION COMPONENTS

Cabin Mount 1-33

Cabin Mount Bush 1-33

Equalizer Bush 1-34

Hood Latch 1-34

Insulator 1-35

Motor Mount 1-35

Motor Mount 1-36

Motor Mount 1-36

Motor Mount 1-37

Mount Insulator 1-37

KENWORTH ANTI-VIBRATION COMPONENTS

[Cabin Mount](#) 1-38

[Cabin Mount Bush](#). 1-38

[Cabin Mount Bush](#). 1-39

[Hood Latch Assly](#). 1-39

[Hood Latch Kit, Right/Left](#) 1-40

[Hood Pin](#) 1-40

[Motor Mount](#) 1-41

[Motor Mount](#) 1-41

[Motor Mount](#) 1-42

[Motor Mount](#) 1-42

[Motor Mount](#) 1-43

[Radiator Mount](#) 1-43

[Shifter Boot](#) 1-44

[Shifter Boot](#) 1-44

[Shifter Boot](#) 1-45

[Stabilizer Bushing](#) 1-45

[Stabilizer Bushing](#) 1-46

[Thrust Bushing](#) 1-46

[Torque Rod Bush](#). 1-47

[Torque Rod Bush](#). 1-47

[Torque Rod Bush](#). 1-48

MACK ANTI-VIBRATION COMPONENTS

[Cabin Mount Bush](#). 1-49

[Hood Pin](#) 1-49

[Motor Mount](#) 1-50

[Motor Mount](#) 1-50

[Transmission Mount](#) 1-51

MERITOR ANTI-VIBRATION COMPONENTS

[Transmission Mount](#) 1-52

NEWAY ANTI-VIBRATION COMPONENTS

[Beam End Bushing](#) 1-53

[Beam End Bushing](#) 1-53

[Spring End Boot](#) 1-54

PETERBILT ANTI-VIBRATION COMPONENTS

[Bushing](#) 1-55

[Bushing](#) 1-55

[Hood Latch](#) 1-56

[Hood Latch](#) 1-56

[Hood Latch](#) 1-57

[Hood Latch](#) 1-57

REYCO ANTI-VIBRATION COMPONENTS

[Equalizer Bush](#) 1-58

[Equalizer Bush](#) 1-58

[Equalizer Bush](#) 1-59

[Equalizer Bush](#) 1-59

[Equalizer Bushing Assembly](#). 1-60

[Torque Arm Bushing](#) 1-60

[Torque Arm Bushing](#) 1-61

[Torque Arm Bushing](#) 1-61

[Torque Arm Bushing](#) 1-62

[Torque Arm Bushing](#) 1-62

SAF HOLLAND ANTI-VIBRATION COMPONENTS

[Beam End Bushing](#) 1-63

[Hood Latch Kit, Right/Left](#) 1-64

[Load Cushion](#) 1-64

[Torque Rod Bush.](#) 1-65

CHALMERS ANTI-VIBRATION COMPONENTS

RUBBER SPRING

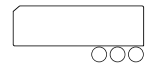
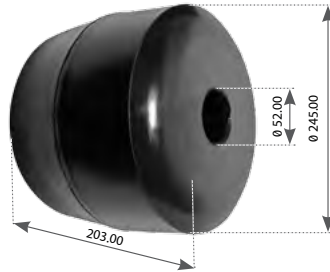

Table 1-1: Rubber - Rubber Spring

Part No.	Description	Application	Brand	SPQ	OEM
MLC110	Rubber spring	Chalmers- 300, 500, 600, 700, 800, 1100, series 40k lbs to 58k lbs suspension	Chalmers	1	15002

TORQUE ROD BUSH



Table 1-2: Rubber - Torque Rod Bush

Part No.	Description	Application	Brand	SPQ	OEM
TRB68440	Torque rod bush	Chalmers - rear: 800 truck - suspension	Chalmers	1	800010

TORQUE ROD BUSH

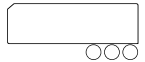

Table 1-4: Rubber - Torque Rod Bush

Part No.	Description	Application	Brand	SPQ	OEM
TRB86450	Torque rod bush	Chalmers: rear: 800 truck-suspension	Chalmers	1	800009

TORQUE ROD BUSH

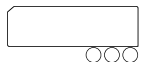

Table 1-5: Rubber - Torque Rod Bush

Part No.	Description	Application	Brand	SPQ	OEM
TRB63280	Torque rod bush	Chalmers- standard 300, 500, 600, 700, 800, 1000, series suspension	Chalmers	1	22082 22128

TORQUE ROD BUSH

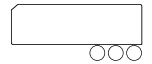

Table 1-6: Rubber - Torque Rod Bush

Part No.	Description	Application	Brand	SPQ	OEM
TRB63270	Torque rod bush	Chalmers: 300, 500, 600, 700, 800, 1000, series for high mileage units	Chalmers	1	22129

FORD ANTI-VIBRATION COMPONENTS

MOTOR MOUNT

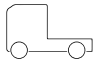
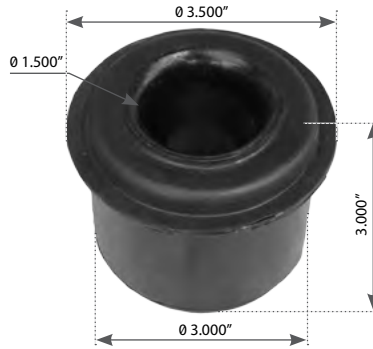

Table 1-7: Rubber - Motor Mount

Part No.	Description	Application	Brand	SPQ	OEM
M203040	Motor mount		Ford	1	DOHZ6068B

FREIGHTLINER ANTI-VIBRATION COMPONENTS

BOLSTER SPRING

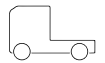
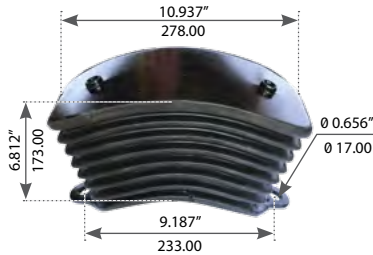

Table 1-8: Rubber - Bolster Spring

Part No.	Description	Application	Brand	SPQ	OEM
MLC90	Bolster Spring	Freightliner Tuftrac 46K Freightliner Rear Tuftrac 40K, 46K, 52K	Freightliner	1	1614508000 1614508001 1615010000

BOLSTER SPRING SEAT

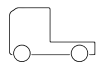
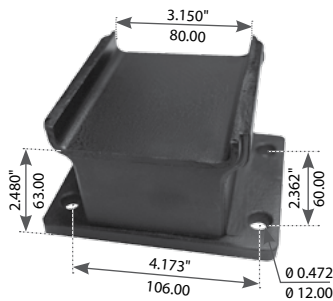

Table 1-9: Rubber - Bolster Spring Seat

Part No.	Description	Application	Brand	SPQ	OEM
MFL48950	Bolster Spring Seat	Freightliner Rear Tuftrac 40K, 46K, 52K-Suspension	Freightliner	1	1119581000

CABIN MOUNT

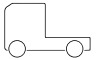
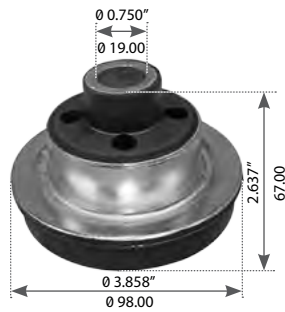

Table 1-10: Rubber - Cabin Mount

Part No.	Description	Application	Brand	SPQ	OEM
M173370	Cabin Mount	LORSB-33310017B	Freightliner	1	6818900001, LORDB3331007B

CABIN MOUNT

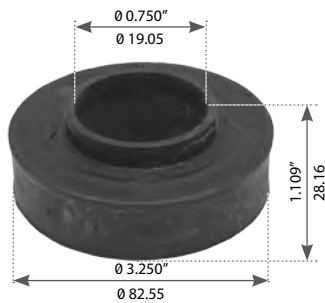

Table 1-11: Rubber - Cabin Mount

Part No.	Description	Application	Brand	SPQ	OEM
M173340	Cabin Mount		Freightliner	1	SSB3310018

ENGINE MOUNT

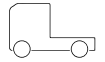
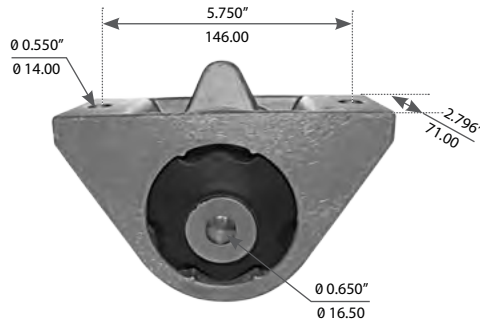

Table 1-12: Rubber - Engine Mount

Part No.	Description	Application	Brand	SPQ	OEM
M174190	Engine Mount		Freightliner	1	1845384000, A1844009000

ENGINE MOUNT

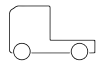
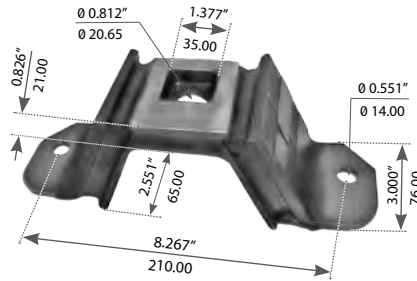

Table 1-13: Rubber - Engine Mount

Part No.	Description	Application	Brand	SPQ	OEM
M173950	Engine Mount	Freightliner Columbia & Century Trucks	Freightliner	1	BCD273301

ENGINE MOUNT

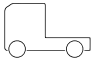
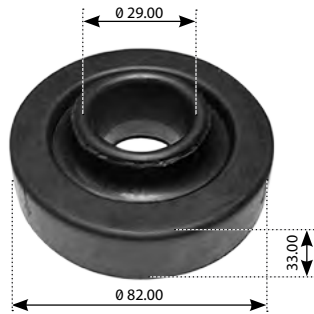

Table 1-14: Rubber - Engine Mount

Part No.	Description	Application	Brand	SPQ	OEM
M173350	Engine Mount		Freightliner	1	6816910001 LORSSB3310017 SSB3310017A

EQUALIZER BUSHING

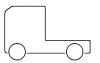
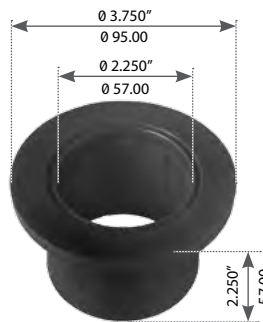

Table 1-15: Rubber - Equalizer Bushing

Part No.	Description	Application	Brand	SPQ	OEM
TRB59060	Equalizer Bushing	Freightliner Rear Fh34a, -38A, -44A, 4" Spring Freightliner Fr34, Fh36-40, Ftl	Freightliner	1	1613568000 A1610549000 A1613570000 E1610512000

HOOD CONE

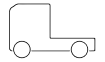
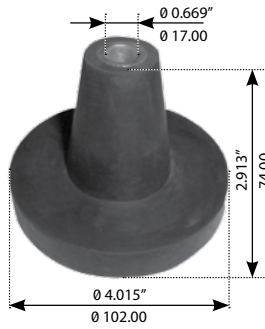

Table 1-16: Rubber - Hood Cone

Part No.	Description	Application	Brand	SPQ	OEM
M173310	Hood Cone		Freightliner	1	A1710464001

HOOD LATCH KIT, LEFT

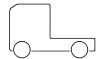
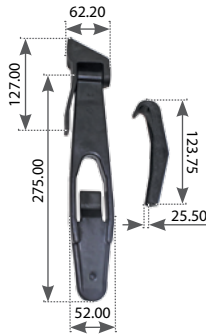

Table 1-17: Rubber - Hood Latch Kit, Left

Part No.	Description	Application	Brand	SPQ	OEM
HLK10110	Hood Latch Kit, Left	Freightliner Offset Axle For L.H.	Freightliner	1	1712435000

HOOD LATCH KIT, RIGHT

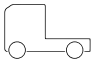
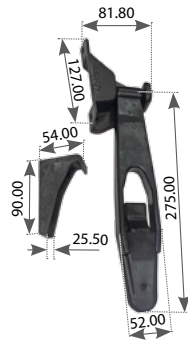

Table 1-18: Rubber - Hood Latch Kit, Right

Part No.	Description	Application	Brand	SPQ	OEM
HLK10200	Hood Latch Kit, Right	Freightliner Columbia	Freightliner	1	A1715553001

HOOD LATCH KIT, RIGHT

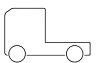
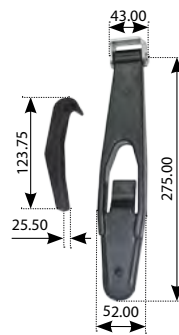

Table 1-19: Rubber - Hood Latch Kit, Right

Part No.	Description	Application	Brand	SPQ	OEM
HLK0147	Hood Latch Kit, Right	Freightliner Fld 120, Classic Straight Front Axle	Freightliner	1	1712348000

HOOD LATCH KIT, RIGHT/LEFT

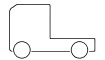

Table 1-20: Rubber - Hood Latch Kit, Right/Left

Part No.	Description	Application	Brand	SPQ	OEM
HLK1019K0	Hood Latch Kit, Right/Left	Freightliner Offset Axle For R.H.	Freightliner	1	1712435001

Hook

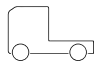

Table 1-21: Rubber - Hook

Part No.	Description	Application	Brand	SPQ	OEM
HH0135	Hook		Freightliner	1	

Hook

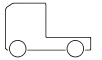

Table 1-22: Rubber - Hook

Part No.	Description	Application	Brand	SPQ	OEM
HH0136	Hook		Freightliner	1	1712434000

LOWER PAD, SPRING INSULATOR

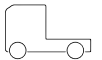
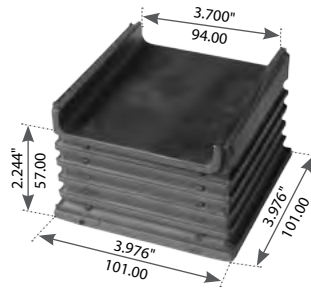

Table 1-23: Rubber - Lower Pad, Spring Insulator

Part No.	Description	Application	Brand	SPQ	OEM
MFL48910	Lower Pad, Spring Insulator	Freighliner Tufrac 40K, 46K, 52K Suspension	Freightliner	1	1120807000

MOTOR MOUNT

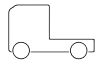
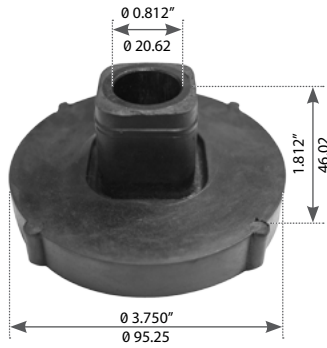

Table 1-24: Rubber - Motor Mount

Part No.	Description	Application	Brand	SPQ	OEM
M173970	Motor Mount		Freightliner	1	BCD274772

TORQUE ROD ASSEMBLY

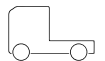
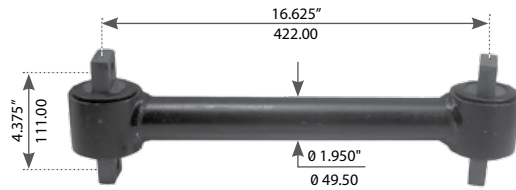

Table 1-25: Rubber - Torque Rod Assembly

Part No.	Description	Application	Brand	SPQ	OEM
TMR30540	Torque Rod Assembly	Freightliner Rear Fh36-40 3" Spring	Freightliner	1	1613054000 ,6813266216

TORQUE ROD BUSH

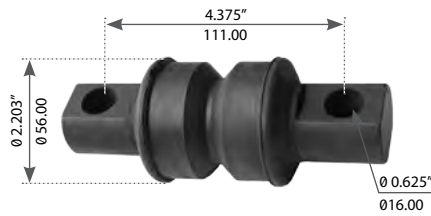

Table 1-26: Rubber - Torque Rod Bush

Part No.	Description	Application	Brand	SPQ	OEM
TRB61890	Torque Rod Bush	Freightliner Rear Fas Airliner II - Suspension	Freightliner	1	81897

UPPER PAD, SPRING INSULATOR

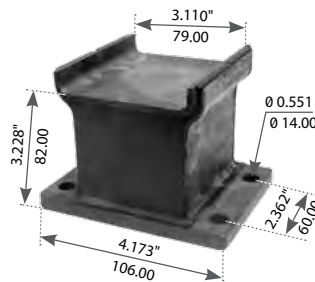

Table 1-27: Rubber - Upper Pad, Spring Insulator

Part No.	Description	Application	Brand	SPQ	OEM
MFL48930	Upper Pad, Spring Insulator	Freightliner Tuftrac 40K, 46K, 52K Series -Suspension	Freightliner	1	1120808000

FRUEHAUF ANTI-VIBRATION COMPONENTS

EQUALIZER BUSH

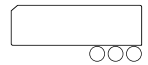
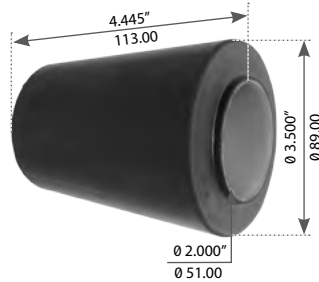

Table 1-28: Rubber - Equalizer Bush

Part No.	Description	Application	Brand	SPQ	OEM
TRB53840	Equalizer Bush	Fruehauf T1 Series W24t1&2, W27t1&2- Trailer J Series-Suspensions	Fruehauf	1	431708, UJA0030001, UXA0004

EQUALIZER SHAFT & BUSHING KIT

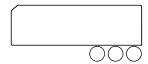

Table 1-29: Rubber - Equalizer Shaft & Bushing Kit

Part No.	Description	Application	Brand	SPQ	OEM
TRK5384HD0	Equalizer Shaft & Bushing Kit	Fruehauf - All Nf-Ft Series - Suspension	Fruehauf	1	UXA000004900

TORQUE ARM BUSHING KIT

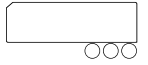
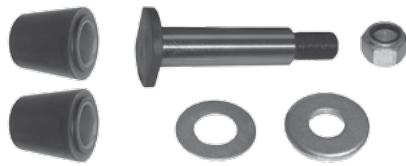

Table 1-30: Rubber - Torque Arm Bushing Kit

Part No.	Description	Application	Brand	SPQ	OEM
TRK63000	Torque Arm Bushing Kit	Fruehauf - All Nf-Ft Series - Suspension	Fruehauf	1	UXA000011900

HENDRICKSON ANTI-VIBRATION COMPONENTS

BEAM END BUSH

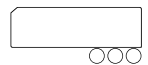
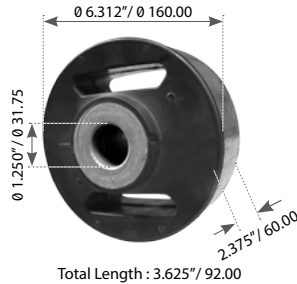

Table 1-31: Rubber - Beam End Bush

Part No.	Description	Application	Brand	SPQ	OEM
TRB59140	Beam End Bush	Hendrickson Intraax, Hkant40k, 46K, 50K, Hka180-200-250, Aa23k, 25K, 30K, Aant23k, Aaedt30k Trailer Suspension	Hendrickson	1	D22845, D25364

BEAM END BUSH

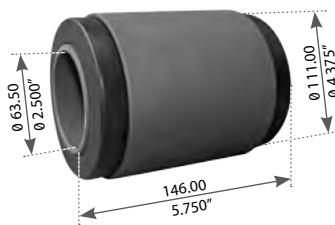

Table 1-32: Rubber - Beam End Bush

Part No.	Description	Application	Brand	SPQ	OEM
M19700	Beam End Bush	Hendrickson Ar2 400/460/520, Hn, Rs, Rt/Rte2 340/380/520, Ru/Rue, U/Ue 340/380, Sr 340, Vr 340/380 Suspension	Hendrickson	1	1117564B001,45900000,5010130652,AL800072

BOLSTER SPRING KIT

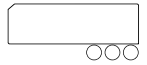

Table 1-33: Rubber - Bolster Spring Kit

Part No.	Description	Application	Brand	SPQ	OEM
MLC50	Bolster Spring Kit	Hendrickson Rear Haulmax Series Suspension	Hendrickson	1	64179037

CENTER BUSHING

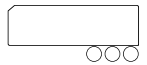
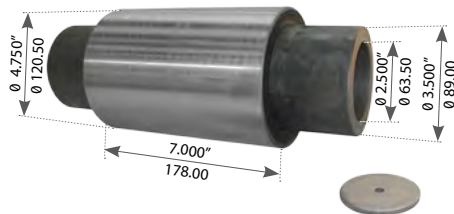

Table 1-34: Rubber - Center Bushing

Part No.	Description	Application	Brand	SPQ	OEM
M19800	Center Bushing	Hendrickson Ar 340/380, Rs, Rt/ Rte, Rt2/Rte2 380/520, Sr 340, V4 340/380,	Hendrickson	1	22282000

Antivibration Components

CENTER BUSHING

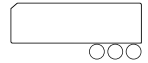

Table 1-35: Rubber - Center Bushing

Part No.	Description	Application	Brand	SPQ	OEM
M19720	Center Bushing	Hendrickson Ar 340/380, Rs, Rt/Hendrickson Ar 340/380, R 400/460/480/520, Rs, Rt/Rte, Rt2/Rte2 380/520, Sr 340, V4 340/380 Series	Hendrickson	1	5919000

CENTER BUSHING



Table 1-36: Rubber - Center Bushing

Part No.	Description	Application	Brand	SPQ	OEM
M19720	Center Bushing	Hendrickson Ar 340/380, Rs, Rt/Hendrickson Ar 340/380, R 400/460/480/520, Rs, Rt/Rte, Rt2/Rte2 380/520, Sr 340, V4 340/380 Series	Hendrickson	1	5919000

LOAD CUSHION

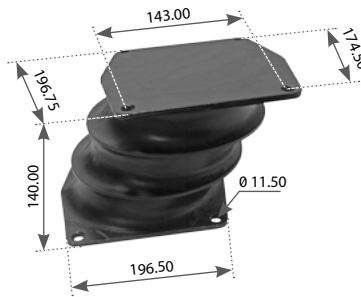

Table 1-37: Rubber - Load Cushion

Part No.	Description	Application	Brand	SPQ	OEM
MLC10	Load Cushion	Hendrickson Hn 402/462/522 & 400/460 11/88 -2/96 Series Suspensions	Hendrickson	1	49377000 ,60879000L ,NM1009

PIVOT BUSH

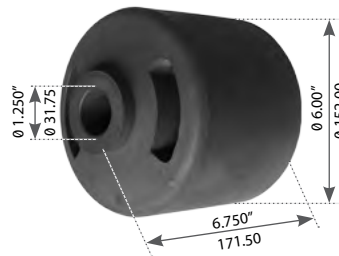

Table 1-38: Rubber - Pivot Bush

Part No.	Description	Application	Brand	SPQ	OEM
TRB59120	Pivot Bush	Hendrickson - Trailer - Intraax : Hkant40k,46K,50K, Hka180-200-250, Aa23k,25K,30K,Aant23k, Aaedt30k	Hendrickson	1	C-21824 C3558 S21824

PIVOT BUSH

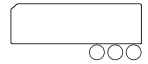
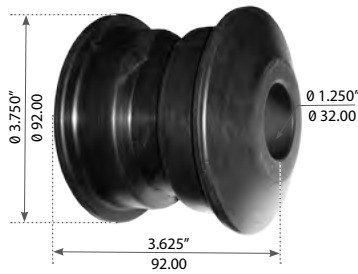

Table 1-39: Rubber - Pivot Bush

Part No.	Description	Application	Brand	SPQ	OEM
TRB50310	Pivot Bush	Hendrickson - Trailer - Intraax : Hkant40k,46K,50K, Hka180-200-250, Aa23k,25K,30K,Aant23k, Aaedt30k	Hendrickson	1	58648000

TORQUE ROD BUSH

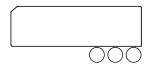
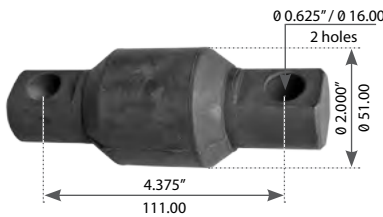

Table 1-40: Rubber - Torque Rod Bush

Part No.	Description	Application	Brand	SPQ	OEM
TRB61850	Torque Rod Bush	Hendrickson; Rear Haulmaax, Primaax, Firemaax, Hfs 360/400/40Lh Series Suspension	Hendrickson	1	47691000

TORQUE ROD BUSH

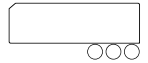
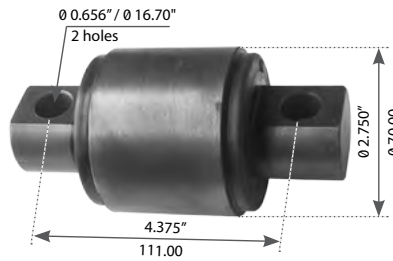

Table 1-41: Rubber - Torque Rod Bush

Part No.	Description	Application	Brand	SPQ	OEM
TRB68200	Torque Rod Bush	Hendrickson Rear Ha Series Suspension	Hendrickson	1	44695000

TORQUE ROD BUSH ASSEMBLY

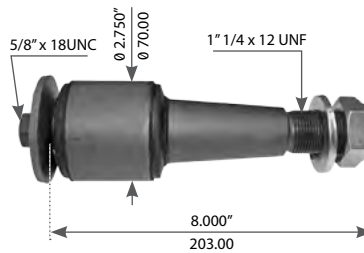

Table 1-42: Rubber - Torque Rod Bush Assembly

Part No.	Description	Application	Brand	SPQ	OEM
TRB61120	Torque Rod Bush Assembly	Hendrickson: 380-440 Series Suspension	Hendrickson	1	44697

TORQUE ROD BUSH

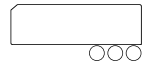
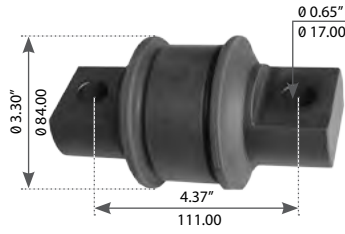

Table 1-43: Rubber - Torque Rod Bush

Part No.	Description	Application	Brand	SPQ	OEM
TRB50330	Torque Rod Bush	Hendrickson 700 Series	Hendrickson	1	64400002 64400002L

TORQUE ROD BUSH

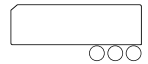
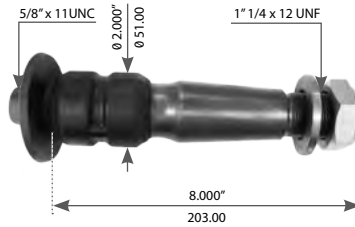

Table 1-44: Rubber - Torque Rod Bush

Part No.	Description	Application	Brand	SPQ	OEM
TRB61790	Torque Rod Bush	Hendrickson Rear: Haulmaax	Hendrickson	1	64697000

TORQUE ROD BUSH

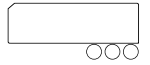
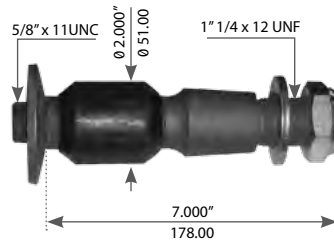

Table 1-45: Rubber - Torque Rod Bush

Part No.	Description	Application	Brand	SPQ	OEM
TRB61830	Torque Rod Bush	Hendrickson Ultra Rod - Suspension	Hendrickson	1	66735000

TORQUE ROD BUSH

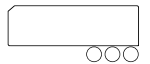
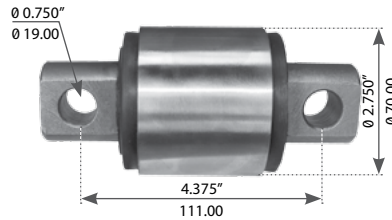

Table 1-46: Rubber - Torque Rod Bush

Part No.	Description	Application	Brand	SPQ	OEM
TRB68220	Torque Rod Bush	Hendrickson 340 / 520 Series Suspension	Hendrickson	1	49210000

TORQUE ROD BUSH

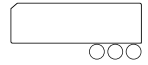
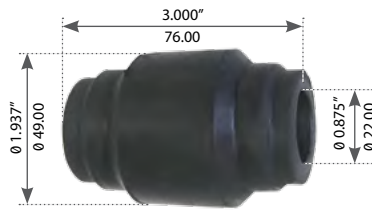

Table 1-47: Rubber - Torque Rod Bush

Part No.	Description	Application	Brand	SPQ	OEM
TRB60040	Torque Rod Bush	Hendrickson Q Series	Hendrickson	1	90008243 A1712 PP005402

TORQUE ROD BUSH

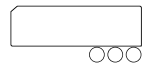
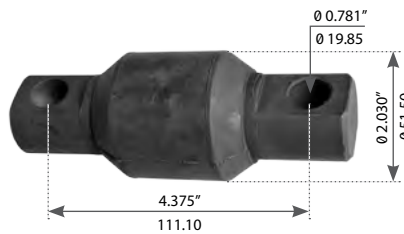

Table 1-48: Rubber - Torque Rod Bush

Part No.	Description	Application	Brand	SPQ	OEM
TRB61750	Torque Rod Bush		Hendrickson	1	69210000

HUTCHENS ANTI-VIBRATION COMPONENTS

EQUALIZER BUSHING

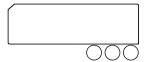
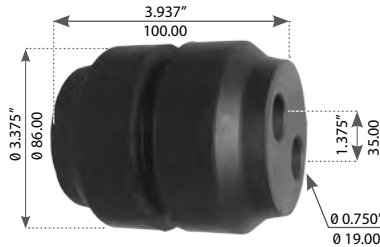

Table 1-49: Rubber - Equalizer Bushing

Part No.	Description	Application	Brand	SPQ	OEM
TRB55410	Equalizer Bushing	Hutch Trailer H Ch76/7700 - Suspension	Hutchens	1	701000

EQUALIZER BUSHING

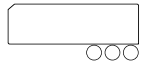
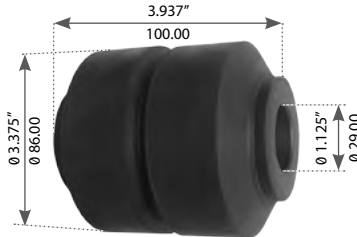

Table 1-50: Rubber - Equalizer Bushing

Part No.	Description	Application	Brand	SPQ	OEM
TRB55420	Equalizer Bushing	Hutch : Ch96/9700 Trailer Suspension	Hutchens	1	1614601, 1872301

Antivibration Components

TORQUE ROD BUSH

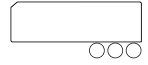
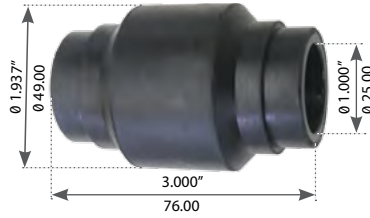

Table 1-51: Rubber - Torque Rod Bush

Part No.	Description	Application	Brand	SPQ	OEM
TRB63260	Torque Rod Bush	Hutch-Trailer: H & Ch 7700, 9700 Tws, Us Widespread-Suspension	Hutchens	1	72200

INTERNATIONAL NAVISTAR ANTI-VIBRATION COMPONENTS

CABIN MOUNT

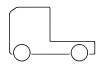
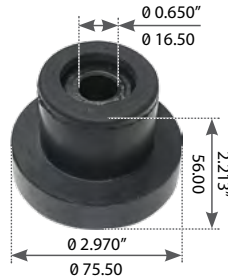

Table 1-52: Rubber - Cabin Mount

Part No.	Description	Application	Brand	SPQ	OEM
M203050	Cabin Mount	International Navistar Truck	International Navistar	1	753997C93

CABIN MOUNT BUSH

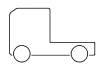

Table 1-53: Rubber - Cabin Mount Bush

Part No.	Description	Application	Brand	SPQ	OEM
M2030110	Cabin Mount Bush	International Navistar Cab Over Engine Model	International Navistar	1	503359C1

Antivibration Components

EQUALIZER BUSH

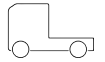
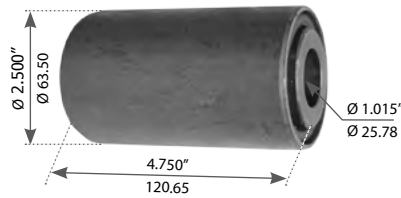

Table 1-54: Rubber - Equalizer Bush

Part No.	Description	Application	Brand	SPQ	OEM
TRB51690	Equalizer Bush	International Navistar 3-1/2" Single & Tandem Axle Suspension	International Navistar	1	497501C2

HOOD LATCH

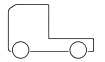
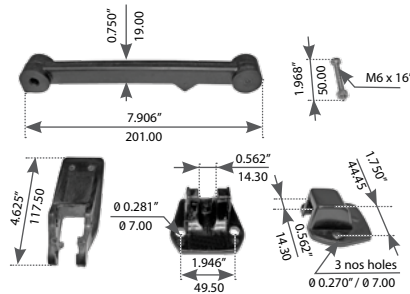

Table 1-55: Rubber - Hood Latch

Part No.	Description	Application	Brand	SPQ	OEM
HL0048	Hood Latch	International Truck, 12" Old Style Hood Latch	International Navistar	1	16899930C91

INSULATOR

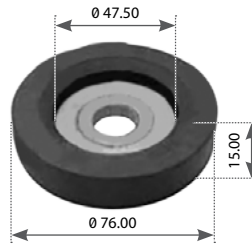

Table 1-56: Rubber - Insulator

Part No.	Description	Application	Brand	SPQ	OEM
M174490	Insulator	International Navistar 360/ 408/ 466 8Cyl/ T444e Series Suspension	International Navistar	1	1664726C2

MOTOR MOUNT

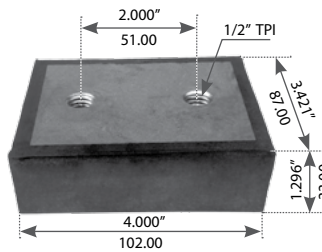

Table 1-57: Rubber - Motor Mount

Part No.	Description	Application	Brand	SPQ	OEM
M173290	Motor Mount		International Navistar	1	EP166

MOTOR MOUNT

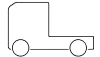
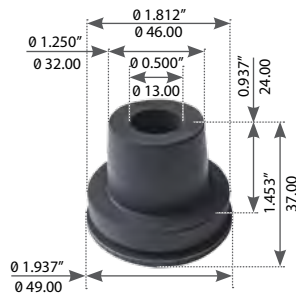

Table 1-58: Rubber - Motor Mount

Part No.	Description	Application	Brand	SPQ	OEM
M2030470	Motor Mount		International Navistar	1	503401C1

MOTOR MOUNT

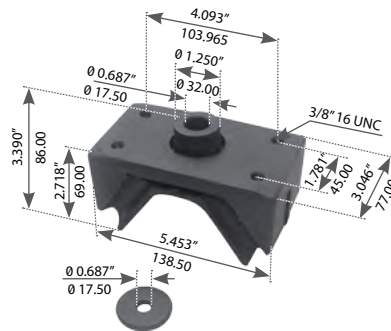

Table 1-59: Rubber - Motor Mount

Part No.	Description	Application	Brand	SPQ	OEM
M174370	Motor Mount	International Navistar / IHC 6 Cyl 360/408/466 Series Rear Suspension	International Navistar	1	1664728C1

MOTOR MOUNT

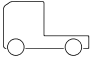

Table 1-60: Rubber - Motor Mount

Part No.	Description	Application	Brand	SPQ	OEM
M203070	Motor Mount	International Navistar Truck	International Navistar	1	479237C1

MOUNT INSULATOR

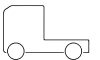
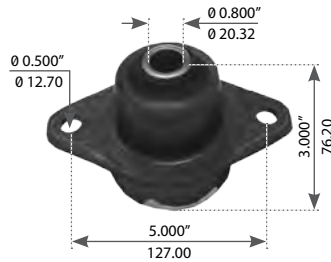

Table 1-61: Rubber - Mount Insulator

Part No.	Description	Application	Brand	SPQ	OEM
M2030530	Mount Insulator	International Navistar Truck	International Navistar	1	3515345C1

KENWORTH ANTI-VIBRATION COMPONENTS

CABIN MOUNT

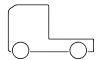
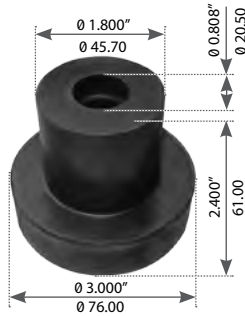

Table 1-62: Rubber - Cabin Mount

Part No.	Description	Application	Brand	SPQ	OEM
M174690	Cabin Mount	Kenworth T800	Kenworth	1	0514794 K066176

CABIN MOUNT BUSH

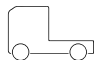
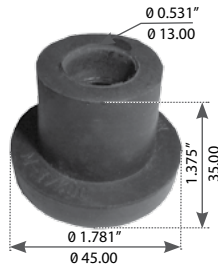

Table 1-63: Rubber - Cabin Mount Bush

Part No.	Description	Application	Brand	SPQ	OEM
M174000	Cabin Mount Bush	Kenworth Airglide 200 Trucks	Kenworth	1	K066218 M30070NR

CABIN MOUNT BUSH

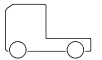
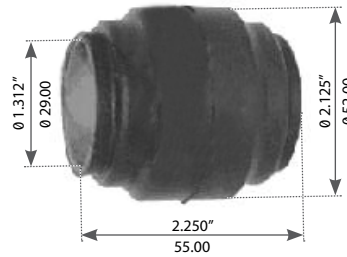

Table 1-64: Rubber - Cabin Mount Bush

Part No.	Description	Application	Brand	SPQ	OEM
M173330	Cabin Mount Bush	Kenworth Trucks	Kenworth	1	66D608 K066178

HOOD LATCH ASSLY

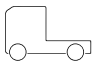

Table 1-65: Rubber - Hood Latch Assly

Part No.	Description	Application	Brand	SPQ	OEM
HLK10000	Hood Latch Assly	Kenworth Trucks	Kenworth	1	K147106

HOOD LATCH KIT, RIGHT/LEFT

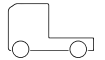

Table 1-66: Rubber - Hood Latch Kit, Right/Left

Part No.	Description	Application	Brand	SPQ	OEM
HLK10350	Hood Latch Kit, Right/Left	Kenworth W900, T600, T300, T800 Series	Kenworth	1	L560001

HOOD PIN

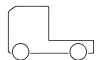
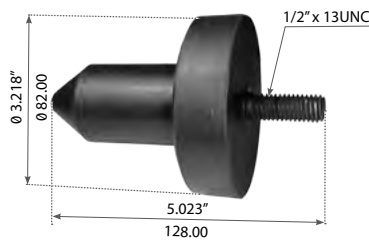

Table 1-67: Rubber - Hood Pin

Part No.	Description	Application	Brand	SPQ	OEM
M174020	Hood Pin	Kenworth-H/Ch Series	Kenworth	1	K179528 K179D450

MOTOR MOUNT

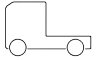
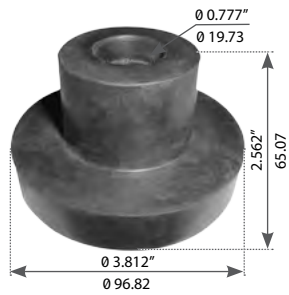

Table 1-68: Rubber - Motor Mount

Part No.	Description	Application	Brand	SPQ	OEM
M174060	Motor Mount	Kenworth	Kenworth	1	516401 K066229

MOTOR MOUNT

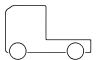
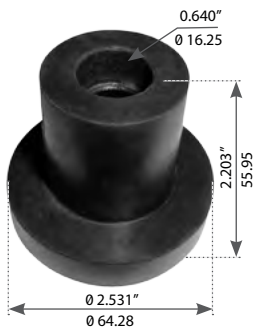

Table 1-69: Rubber - Motor Mount

Part No.	Description	Application	Brand	SPQ	OEM
M174100	Motor Mount	Kenworth	Kenworth	1	M50070NR

MOTOR MOUNT

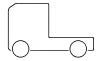
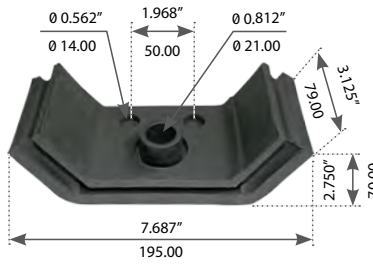

Table 1-70: Rubber - Motor Mount

Part No.	Description	Application	Brand	SPQ	OEM
M174110	Motor Mount	Kenworth T600 Rear Motor Mount	Kenworth	1	K066377

MOTOR MOUNT

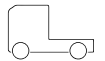
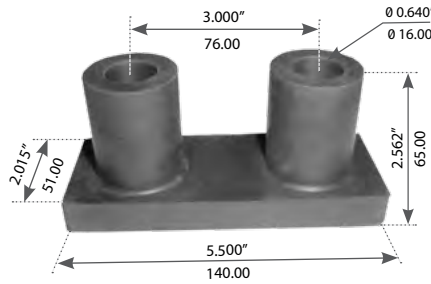

Table 1-71: Rubber - Motor Mount

Part No.	Description	Application	Brand	SPQ	OEM
M174050	Motor Mount		Kenworth	1	K066282

MOTOR MOUNT

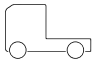
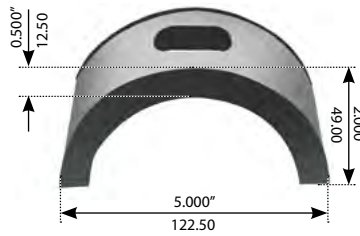

Table 1-72: Rubber - Motor Mount

Part No.	Description	Application	Brand	SPQ	OEM
M174080	Motor Mount		Kenworth	1	K174555 K174B456

RADIATOR MOUNT

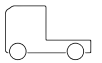
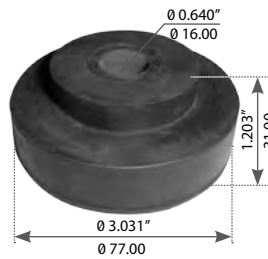

Table 1-73: Rubber - Radiator Mount

Part No.	Description	Application	Brand	SPQ	OEM
M174120	Radiator Mount		Kenworth	1	K066228

SHIFTER BOOT

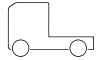
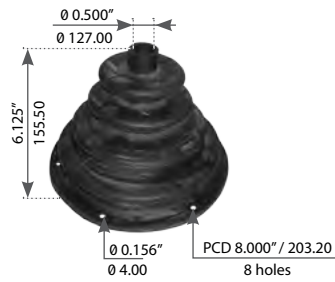

Table 1-74: Rubber - Shifter Boot

Part No.	Description	Application	Brand	SPQ	OEM
562.75910	Shifter Boot		Kenworth	1	K04245

SHIFTER BOOT

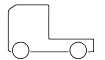
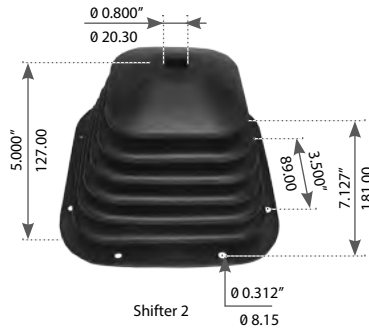

Table 1-75: Rubber - Shifter Boot

Part No.	Description	Application	Brand	SPQ	OEM
562.75920	Shifter Boot		Kenworth	1	K04279

SHIFTER BOOT

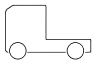
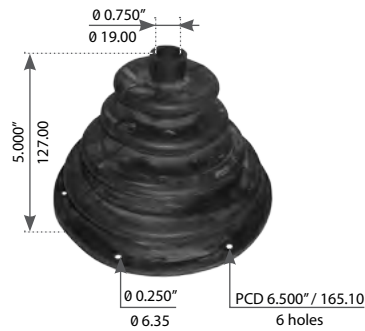

Table 1-76: Rubber - Shifter Boot

Part No.	Description	Application	Brand	SPQ	OEM
562.75930	Shifter Boot		Kenworth	1	K042702

STABILIZER BUSHING

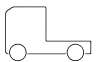
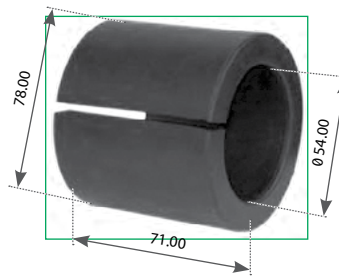

Table 1-77: Rubber - Stabilizer Bushing

Part No.	Description	Application	Brand	SPQ	OEM
KB4500	Stabilizer Bushing	Kenworth - Rear: Ag200 / 230/ 400/ 460 Airglide - Suspension	Kenworth	1	K066450

STABILIZER BUSHING

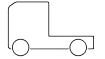
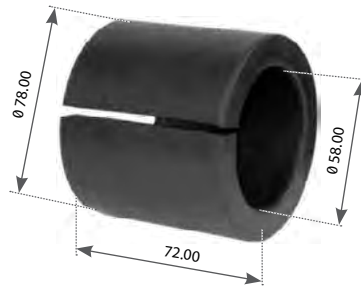

Table 1-78: Rubber - Stabilizer Bushing

Part No.	Description	Application	Brand	SPQ	OEM
KB4600	Stabilizer Bushing	Kenworth - Rear: Ag200/ 230/ 400/ 460 Airglide - Suspension	Kenworth	1	K066460

THRUST BUSHING

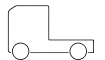
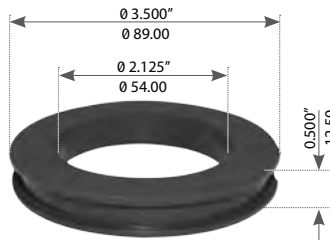

Table 1-79: Rubber - Thrust Bushing

Part No.	Description	Application	Brand	SPQ	OEM
KB4510	Thrust Bushing	Kenworth - Rear: Ag200/ 230/ 400/ 460 Airglide - Suspension	Kenworth	1	K066454 K0665021

TORQUE ROD BUSH

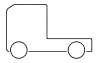
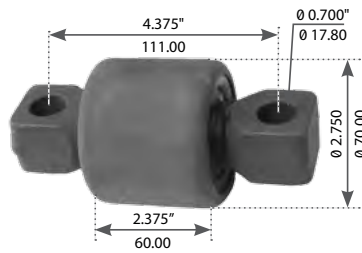

Table 1-80: Rubber - Torque Rod Bush

Part No.	Description	Application	Brand	SPQ	OEM
TRB68250	Torque Rod Bush	Kenworth Rear: Ag200/ 230/ 400/ 460 Airglide - Suspension	Kenworth	1	836940 839310 90008265

TORQUE ROD BUSH

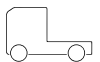
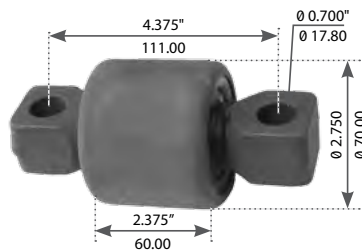

Table 1-81: Rubber - Torque Rod Bush

Part No.	Description	Application	Brand	SPQ	OEM
TRB68250	Torque Rod Bush	Kenworth Rear: Ag200/ 230/ 400/ 460 Airglide - Suspension	Kenworth	1	836940 839310 90008265

TORQUE ROD BUSH

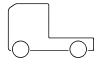
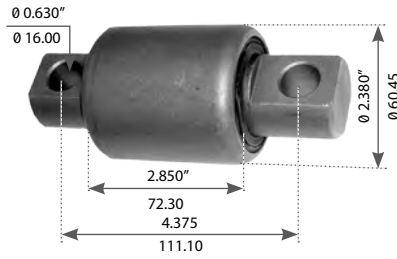

Table 1-82: Rubber - Torque Rod Bush

Part No.	Description	Application	Brand	SPQ	OEM
MR8280	Torque Rod Bush	Kenworth - Rear: Ag 380 Airglide - Suspension	Kenworth	1	C136001

MACK ANTI-VIBRATION COMPONENTS

CABIN MOUNT BUSH

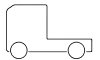
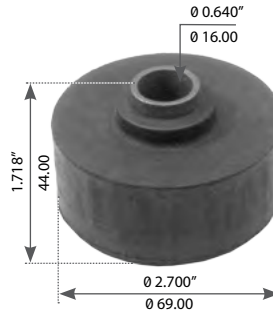

Table 1-83: Rubber - Cabin Mount Bush

Part No.	Description	Application	Brand	SPQ	OEM
M175290	Cabin Mount Bush	Mack Trucks	Mack	1	20QL250

HOOD PIN

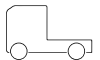
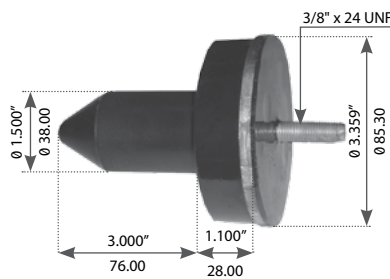

Table 1-84: Rubber - Hood Pin

Part No.	Description	Application	Brand	SPQ	OEM
M175270	Hood Pin	Mack W900, T600, T800 Series	Mack	1	25QM31

MOTOR MOUNT

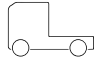

Table 1-85: Rubber - Motor Mount

Part No.	Description	Application	Brand	SPQ	OEM
M30	Motor Mount	Mack Qeb 1590	Mack	1	20QL1166 20QL1171

MOTOR MOUNT

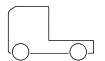
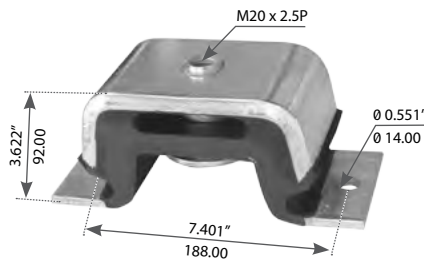

Table 1-86: Rubber - Motor Mount

Part No.	Description	Application	Brand	SPQ	OEM
M175280	Motor Mount	Mack Ch, Rh & Br Series	Mack	1	20QL338M

TRANSMISSION MOUNT

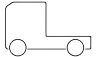
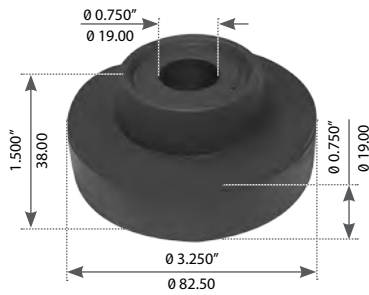

Table 1-87: Rubber - Transmission Mount

Part No.	Description	Application	Brand	SPQ	OEM
M10T	Transmission Mount	Mack Rear Single Axle Suspension	Mack	1	20QL1118A 20QL1175

MERITOR ANTI-VIBRATION COMPONENTS

TRANSMISSION MOUNT

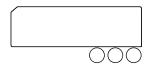
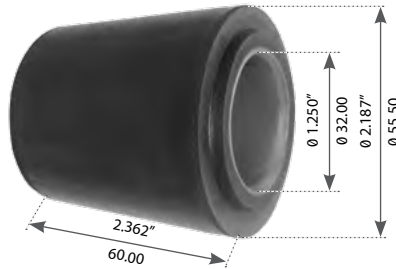

Table 1-88: Rubber - Transmission Mount

Part No.	Description	Application	Brand	SPQ	OEM
TRB63000	Torque Rod Bush	Meritor M, Sm, Smt Series Mechanical Suspensions	Meritor	1	21202104

NEWAY ANTI-VIBRATION COMPONENTS

BEAM END BUSHING

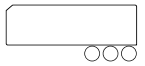
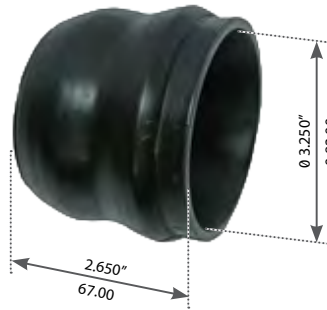

Table 1-89: Rubber - Beam End Bushing

Part No.	Description	Application	Brand	SPQ	OEM
TRB57020	Beam End Bushing	Neway/Holland - Rear: Ad160,Ad200 Drive Air - Suspension	Neway	1	90008113

BEAM END BUSHING

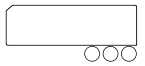
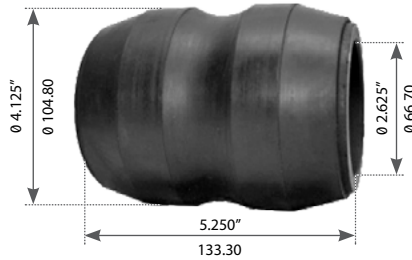

Table 1-90: Rubber - Beam End Bushing

Part No.	Description	Application	Brand	SPQ	OEM
TRB57180	Beam End Bushing	Neway/ Holland - Rear: Ad123-246-369, Ad126-252-378, Ad130-260-390, Drive Air (Single - Tandem - Triaxle - Suspension	Neway	1	90008135

SPRING END BOOT

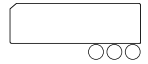
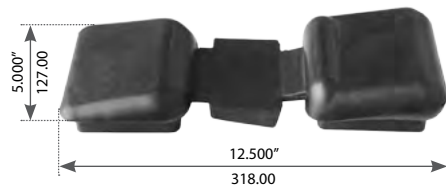

Table 1-91: Rubber - Spring End Boot

Part No.	Description	Application	Brand	SPQ	OEM
M1108320	Spring End Boot	Neway/ Holland - Trailer: SI & TI Series - Suspension	Neway	1	91008032

PETERBILT ANTI-VIBRATION COMPONENTS

BUSHING

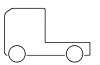
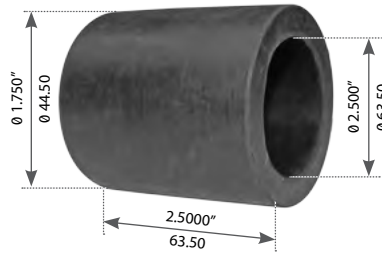

Table 1-92: Rubber - Bushing

Part No.	Description	Application	Brand	SPQ	OEM
TRB59040	Bushing	Peterbilt - Rear: Low Mount Air Leaf - Suspension	Peterbilt	1	0305101 0307015 0308799

BUSHING

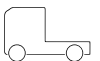
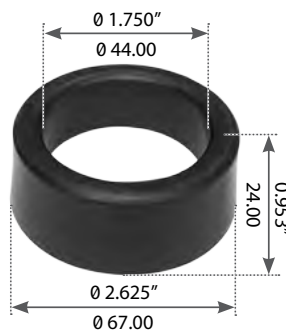

Table 1-93: Rubber - Bushing

Part No.	Description	Application	Brand	SPQ	OEM
TRB59070	Bushing	Peterbilt - Rear: Air Leaf - Suspension	Peterbilt	1	0301675

HOOD LATCH

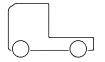
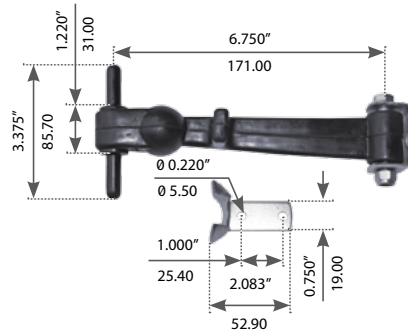

Table 1-94: Rubber - Hood Latch

Part No.	Description	Application	Brand	SPQ	OEM
HLK10060	Hood Latch	Peterbilt Trucks	Peterbilt	1	2900322

HOOD LATCH

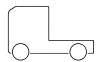
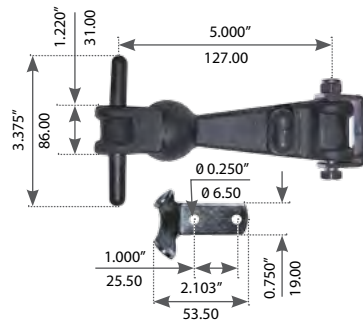

Table 1-95: Rubber - Hood Latch

Part No.	Description	Application	Brand	SPQ	OEM
HLK10070	Hood Latch	Peterbilt Trucks	Peterbilt	1	2900215

HOOD LATCH

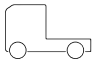
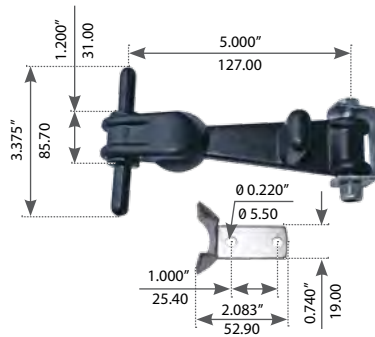

Table 1-96: Rubber - Hood Latch

Part No.	Description	Application	Brand	SPQ	OEM
HLK10080	Hood Latch	Peterbilt Trucks	Peterbilt	1	36576K

HOOD LATCH

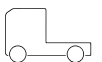
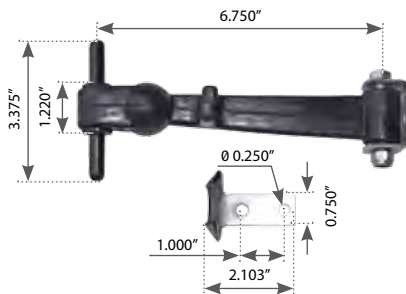

Table 1-97: Rubber - Hood Latch

Part No.	Description	Application	Brand	SPQ	OEM
HK10040	Hood Latch	Peterbilt Trucks	Peterbilt	1	2900314

REYCO ANTI-VIBRATION COMPONENTS

EQUALIZER BUSH

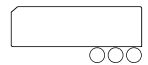

Table 1-98: Rubber - Equalizer Bush

Part No.	Description	Application	Brand	SPQ	OEM
TRB50240	Equalizer Bush	Reyco/ Transpro Rear 101, 101A, 102, 102W, 25 Series - Suspension	Reyco	1	0836301

EQUALIZER BUSH

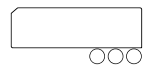
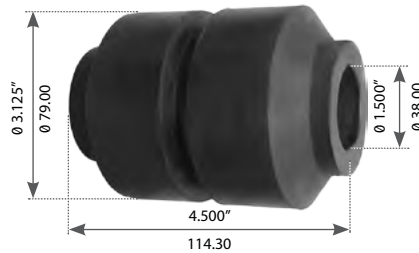

Table 1-99: Rubber - Equalizer Bush

Part No.	Description	Application	Brand	SPQ	OEM
TRB50290	Equalizer Bush	Reyco/ Transpro - Rear: 101, 101A, 102, 102W Series - Suspension	Reyco	1	1471301

EQUALIZER BUSH

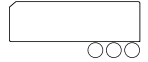
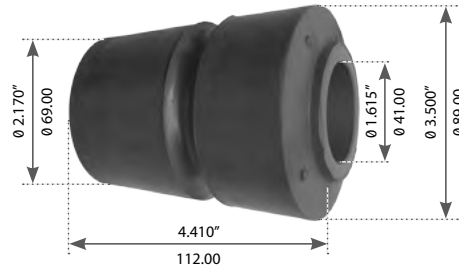

Table 1-100: Rubber - Equalizer Bush

Part No.	Description	Application	Brand	SPQ	OEM
TRB50660	Equalizer Bush	Reyco/ Transpro - Trailer: 21B Cast And Fabricated Suspension	Reyco	1	T5524

EQUALIZER BUSH



Table 1-101: Rubber - Equalizer Bush

Part No.	Description	Application	Brand	SPQ	OEM
TRB55440	Equalizer Bush	Reyco/ Transpro Trailer 86, 88, 88Hd Series - Suspension	Reyco	1	64902

EQUALIZER BUSHING ASSEMBLY

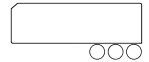

Table 1-102: Rubber - Equalizer Bushing Assembly

Part No.	Description	Application	Brand	SPQ	OEM
TRK50660	Equalizer Bushing Assembly	Reyco Trailer: 21Ar, 74Ar, 86Ar Air Ride - Suspension	Reyco	1	TK18998

TORQUE ARM BUSHING

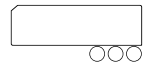
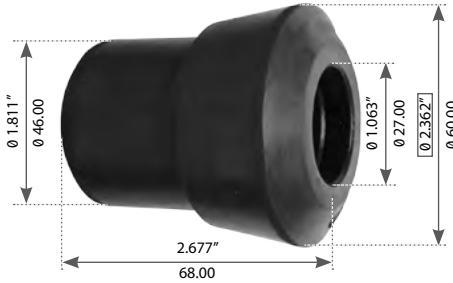

Table 1-103: Rubber - Torque Arm Bushing

Part No.	Description	Application	Brand	SPQ	OEM
TRB60000	Torque Arm Bushing	Reyco Rear: 102cc Single Axle Drive - Suspension	Reyco	1	T2242

TORQUE ARM BUSHING

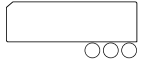
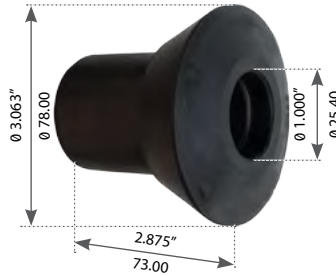

Table 1-104: Rubber - Equalizer Bushing Assembly

Part No.	Description	Application	Brand	SPQ	OEM
TRB60020	Torque Arm Bushing	Reyco Rear: 102Ar, 140Ar, 240Ar Air Ride - Suspension	Reyco	1	T1842

TORQUE ARM BUSHING

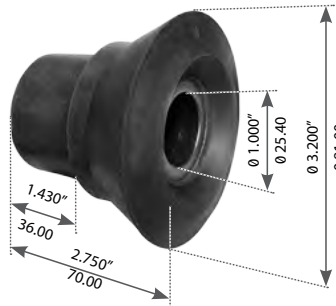

Table 1-105: Rubber - Equalizer Bushing Assembly

Part No.	Description	Application	Brand	SPQ	OEM
TRB60030	Torque Arm Bushing	Reyco/ Transpro Rear 101, 101A, 102, 102W, 102Ar, 240Ar Air Glide, 102Cc Single Axle Drive	Reyco	1	2123801

TORQUE ARM BUSHING

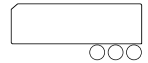

Table 1-106: Rubber - Equalizer Bushing Assembly

Part No.	Description	Application	Brand	SPQ	OEM
TRB60050	Torque Arm Bushing	Reyco 73, 83 Series Trailer Spring Suspensions	Reyco	1	1005101

TORQUE ARM BUSHING

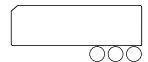
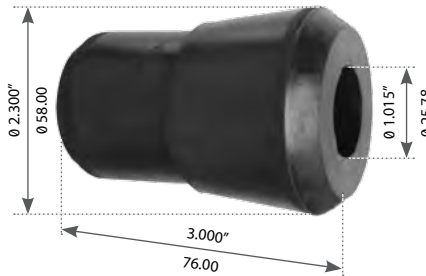

Table 1-107: Rubber - Equalizer Bushing Assembly

Part No.	Description	Application	Brand	SPQ	OEM
TRB60080	Torque Arm Bushing	Reyco Trailer: 21Ar, 74Ar, 86Ar Air Ride - Suspension	Reyco	1	T5493

SAF HOLLAND ANTI-VIBRATION COMPONENTS

BEAM END BUSHING

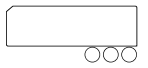
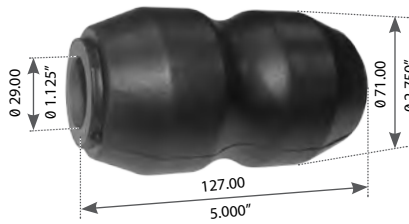

Table 1-108: Rubber - Beam End Bushing

Part No.	Description	Application	Brand	SPQ	OEM
TRB57030	Beam End Bushing	Madras Saf Holland	Saf Holland	1	90008277

HOOD LATCH KIT, RIGHT/LEFT

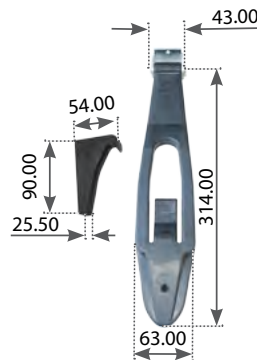

Table 1-109: Rubber - Hood Latch Kit, Right/Left

Part No.	Description	Application	Brand	SPQ	OEM
HLK10280	Hood Latch Kit, Right/Left	Volvo Ac, Wa, Wc, Wg, Wi Series	VOLVO	1	8174018

LOAD CUSHION

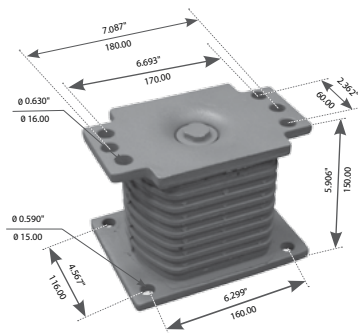

Table 1-110: Rubber - Load Cushion

Part No.	Description	Application	Brand	SPQ	OEM
MVT40	Load Cushion	Volvo Fh12, Fh16, FI10, FI12, FI6, FI7, Fm10, Fm12, Fm7, Fm9 Series, T-Ride Suspension	VOLVO	1	016229825 1089501 10895019 1629553 20390836

TORQUE ROD BUSH

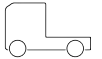
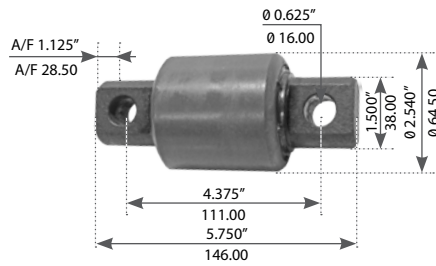

Table 1-111: Rubber - Torque Rod Bush

Part No.	Description	Application	Brand	SPQ	OEM
TRB61640	Torque Rod Bush	Volvo Rear: 4 Spring Tandem Suspension Volvo Rear: Corporate Air Ride, Single Spring Tandem Suspension	VOLVO	1	3503300088 227710 350333201



*For information, updates, or corrections,
please contact us at feedback@TRPParts.com*

*No part of this marketing material may be
reproduced in any manner without written
permission from TRP North America.*

TRP® North America

750 Houser Way N.
Renton, WA 98057

www.TRPParts.com