



FIRE AND RESCUE DEPARTMENTS
OF NORTHERN VIRGINIA
FIREFIGHTING AND EMERGENCY
OPERATIONS MANUAL

**TRUCK COMPANY
OPERATIONS**

BOOK 1 – First Edition

Issued: June 2016

ACKNOWLEDGMENTS

This document was developed through a cooperative effort of the following Northern Virginia fire departments:

- City of Alexandria
- Arlington County
- City of Fairfax
- Fairfax County
- Fauquier County
- Fort Belvoir
- Fort Myer
- Loudoun County
- City of Manassas
- Marine Corps Base Quantico
- Metropolitan Washington Airports Authority (MWAA)
- Prince William County
- Stafford County

The following personnel assisted in the development of the first edition of this manual:

City of Alexandria: Lieutenant Dave Bogoz, Lieutenant Matthew Craig

City of Manassas: Battalion Chief Mark Nary

Arlington County: Lieutenant David Santini

Fairfax City: Captain Gregory Thuot, Captain Joseph Schumacher

Fairfax County: Battalion Chief Dan Shaw, Captain David Barlow, Captain Rex Strickland, Lieutenant Scott Kraut

Fort Myer: Captain William Long

Loudoun County: Lieutenant Scott Lantz, Lieutenant Marc Nicholson

MWAA: Captain Chris Gavurnik, Captain Tim Legore

Prince William County: Lieutenant Bryan Ross

The committee would like to thank the following individuals and organizations for their help in the development of this manual:

AAW Publication Services: Andrea A. Walter (editing and layout)

TABLE OF CONTENTS

PREFACE.....	1
DEFINITIONS	2
PLANNING AND PREPARATION	5
APPARATUS TYPE.....	6
Rear-mount Aerial	6
Tower/Ladder Towers.....	6
Tractor Drawn Aerials	7
Quints	7
RESPONDING.....	9
Alarm Responses	9
First-due Truck Company	9
Second-due Truck Company.....	9
Response to Fire Alarms	10
Safety	10
APPARATUS POSITIONING	11
General Positioning Issues	11
Tractor drawn/Tiller Trucks.....	13
Stokes Basket Operations	14
General Truck Positioning	14
Scrub Area	17
Potential Hazards to Consider in Positioning	19
Collapse Zone	19
Overhead Electrical Wires	19
Weight Restrictions.....	20
Ground Support Devices.....	20
Outriggers	21
Short Jacking.....	22
Apparatus Placement Specific to Occupancy Type	22
Using Alleyways.....	22
Townhouse/ Rowhouse Positioning.....	23
Strip Shopping Center.....	25
Garden Apartment.....	25
High-rise	26
Storage Facilities.....	27
Ventilation.....	31
Tactical Operations	31
Staffing.....	31
Strategy	32
Tactics	32
Tasks	32
General Duties When Paired with Engine Companies	35
RAPID KEY ENTRY SYSTEMS.....	36
UTILITY CONTROL	37
SALVAGE	38

OVERHAUL	39
BUILDING CONSTRUCTION.....	42
Conventional Wood Roof Construction.....	42
Lightweight Roof Construction	42
Truss Floor Construction	43
ROOF CONSTRUCTION AND TYPES.....	45
Conventional A-Frame Gable Style Roof Using Dimensional Lumber	45
Type III – Ordinary Construction	45
Type V – Wood Frame	45
Lightweight A-frame	45
Lightweight Truss Roofing System	46
One-piece Laminated Arch	47
Multiple-section Laminated Arches.....	48
Metal Roof Deck.....	49
Poured-in-place Concrete Roof.....	50
Lightweight Pre-cast Concrete Roof.....	50
Flat Concrete Roof/Pre-cast or Poured-in-place with Concrete Columns	51
Pre-cast Lightweight Concrete Roof/Tilt-up Construction.....	52
Heavy Timber Roof	53
ROOF STYLES.....	55
Gable Roof	55
Cape Cod.....	55
Barn Roof.....	57
Hip Roof.....	57
Cross Gable roof	58
Bridge Truss Roof.....	58
Trussed Arch Roof.....	59
Bowstring Truss Roof.....	60
Sawtooth Roof	62
Flat Roofs.....	63
Inverted Roof	64
Rain Roof	65
ROOF HAZARDS	66
Façade Hazards	66
GREEN BUILDINGS.....	68
Access	68
Vegetation.....	68
Roof Systems	68
Roof Materials	68
Windows	69
Power	69
Thermal Systems.....	69
Photovoltaic Systems (PV)	70
Hazards in Green Power Systems.....	70
Water.....	70

TABLE OF FIGURES

Figure 1: Rear-mount aerial.....	6
Figure 2: Rear-mount tower.....	6
Figure 3: Mid-mount tower.....	7
Figure 4: Tractor-drawn aerial devices, or tiller trucks, are referred to as truck companies.	7
Figure 5: A quint provides the features of both an engine and a tower.	8
Figure 6: Obstacles like waterways can drastically affect truck company positioning. When discovered, these obstacles must be reported to the command post.	12
Figure 7: Multiple aerial devices positioned on the same side.	12
Figure 8: Proper positioning of the apparatus is essential to ensure that the hydraulic ladder can be operated below grade.	13
Figure 9: Typical Stokes basket operations.	14
Figure 10: The length of the bedded ladder section along with the correct apparatus positioning is paramount for successful use of the ladder.	15
Figure 11: Portable ladders are inaccessible when other apparatus is positioned too close.	16
Figure 12: Aerial apparatus operators must be well versed in positioning on uneven terrain.	16
Figure 13: An example of a manufacturer’s specifications that can affect positioning.	17
Figure 14: Scrub area.	17
Figure 15: Positioning on the corner of the building allows the truck company to scrub two sides of this building.	18
Figure 16: On rear mount aerial devices, backing in and placing the turntable closest to the building will often prove advantageous by increasing the scrub area and allowing for maximum extension of the ladder.	18
Figure 17: The collapse zone is 1.5 times the height of the building.	19
Figure 18: This photograph of an apparent sidewalk that terminates into a wall is actually a concrete pad placed at the corner of this high-rise building to provide support for a Truck’s stabilizer.	20
Figure 19: The area where this firefighter is standing is actually designed for fire department vehicle access. The compacted soil and tile blocks are hidden beneath the grass. These kinds of hidden vehicle access points need to be readily displayed on maps and preplans.	21
Figure 20: Jack plates should be centered over the outriggers.	21
Figure 21: Use of the aerial is permitted on the non-short jacked side of the apparatus.	22
Figure 22: When present, the use of an alley or parallel street on the opposite side of the 1st arriving truck can provide an excellent tactical position for both trucks.	23
Figure 23: Example of townhouse/rowhouse positioning.	24
Figure 24: Another example of townhouse/rowhouse positioning.	24
Figure 25: An example of optimal truck company positioning for a fire in a strip shopping center.	25
Figure 26: A properly positioned truck company can accomplish two tasks, if needed.	26
Figure 27: Example of high-rise positioning.	27
Figure 28: Storage facility positioning example.	28
Figure 29: Truck companies should use the reach of the hydraulic ladder during advanced fires by positioning on a parallel alley and projecting the master stream over and into the involved unit(s).	28

Figure 30: The location and control of utilities is an important function of the truck company. .	37
Figure 31: Grease fires often extend upward into the roofing materials.	41
Figure 32: Truss connectors before and after partial collapse.	43
Figure 33: Plywood I-beam, also known as a Ply-I.	44
Figure 34: Plywood I-beam subjected to fire conditions and has disintegrated.	44
Figure 35: Example of conventional A-frame gable style roof on a masonry structure.	45
Figure 36: Example of an A-frame gable style roof on a wood frame structure.	46
Figure 37: Example of a lightweight A-frame gable style roof on a wood frame structure.	46
Figure 38: Example of a lightweight truss roof on a wood frame structure.	47
Figure 39: An example of a laminated arch.	48
Figure 40: Laminated arch roof, common in old grocery stores.	48
Figure 41: An example of a laminated arch with a gusset plate connector.	49
Figure 42: A detailed view of the components of a metal deck roof.	49
Figure 43: Early recognition of a concrete roof is essential and an assessment of the cables will provide information on potential collapse.	50
Figure 44: In the precast concrete roof, the concrete holds the cables in place and can fail if the fire causes spalling.	51
Figure 45: The flat concrete roof benefits from the support of the concrete columns.	52
Figure 46: In tilt-up construction the roof is supported by the tilt-up walls.	52
Figure 47: Note the metal connector connecting the roof and exterior, tilt up wall.	53
Figure 48: Heavy timber will provide large surface areas that are moderately resistant to fire travel but will collapse catastrophically if under fire for an extended period of time.	54
Figure 49: Gable roof.	55
Figure 50: The presence of a dormer is prevalent in the Cape Cod-style homes.	56
Figure 51: Cape Cod structure with an addition on the rear.	56
Figure 52: The barn roof, or gambrel, can present similar void spaces to a Cape Cod.	57
Figure 53: Hip roof.	57
Figure 54: Cross gable roof section.	58
Figure 55: Firefighters should be aware of fire conditions above them in cross gable roofs.	58
Figure 56: An example of a bridge truss roof.	59
Figure 57: An example of a trussed arch roof.	59
Figure 58: An example of a metal trussed arch roof.	60
Figure 59: The gusset plate on the bottom chord of the truss is very susceptible to failure. Any insult to the plate could cause the entire collapse of the roof.	60
Figure 60: The presence of a steel cable and turnbuckle can be good indicators of a bowstring truss roof.	61
Figure 61: Ceiling tiles can hide what would normally be an easy visual clue of a bowstring truss roof. Prior knowledge of these buildings is essential when firefighting fire.	61
Figure 62: Firefighters should maintain situational awareness and report if they observe a cable and/or plate on the exterior wall. This can be an indicator of bowstring truss or a repaired roof structure.	62
Figure 63: The sawtooth roof is easy to recognize and can vented easily, if needed.	63
Figure 64: Open web bar joists.	64
Figure 65: Rain roof.	65
Figure 66: Column connector.	66
Figure 67: Example of a facade.	66

Figure 68: Addition of a Façade to an existing structure..... 67
Figure 69: Typical Solar arrays for residential application. 69

TABLE OF TABLES

Table 1: Interior and Exterior Tasks and Personnel Complement..... 33

PREFACE

Success on any fireground hinges on the skills and abilities of all personnel operating; this manual focuses on the skills and abilities specific to members assigned to a truck company.

After arriving and forcing entry, the truck company generally works in close proximity to and above the fire. This is often without the protection of a hoseline and the actions are aimed at locating the fire, containing it if necessary and feasible, and searching for occupants. Other members remain outside to place portable ladders, ventilate, control utilities, and possibly raise the aerial to the structure. The truck company also responds to calls ranging from lockouts, stalled elevators, ice rescues, automatic fire alarms, to medical emergencies. Members assigned to the truck company must be well-versed in fire behavior, use of portable ground ladders to rescue occupants, forcible entry to create ingress/egress routes for firefighters, ventilation techniques, and other special services such as ice and trench rescue. The truck company's tasks are numerous and the survivability of civilians and other firefighters is increased when the truck company executes assigned duties effectively.

Personnel assigned to truck companies must demonstrate the ability to maintain, deploy, and operate a large cache of ground ladders and equipment. Many truck companies also play a role in special operations, such as hazardous materials or technical rescue, demonstrating the diverse capabilities of truck companies across the region.

This manual is designed for use as a resource and reference for all fire department and emergency service communications personnel in Northern Virginia for the purposes of standardizing truck company operations across the region.

The objectives of this manual are:

- To provide guidelines and general information regarding truck company operations.
- To describe the duties and responsibilities of the truck company.
- To identify tactical and strategic considerations for truck company operations.
- To define the truck company officer's roles and responsibilities.
- To establish guidelines for apparatus positioning on the fire ground.

DEFINITIONS

Aerial Ladder: A power-operated ladder that allows firefighters to easily climb and descend between the turntable and the tip of the ladder.

Collapse Zone: The area around a building, at least one and one-half times the height of the building involved, that should be considered as a danger area for potential collapse.

Conventional Wood Floor/Roof Construction: Construction methods using dimensional lumber for structural members that depend on mass for strength.

Coordinated Ventilation-- The controlled removal of smoke, heat, and gases and the replacement with fresh air in concert with deployment and application of a properly functioning hoseline on the seat of the fire.

Elevated Master Stream: A fire stream in excess of 350 GPM that is deployed from the tip of an aerial device.

Flying Standpipe: The use of the pre-piped master stream or laying a larger line (2.5-inch or 3-inch) up the aerial to serve as a standpipe to deploy a handline.

Forcible Entry: The act of gaining access into a structure or occupancy via door, window, or wall by use of force.

Green Building: A structure or occupancy designed to be environmentally responsible and resource efficient throughout the building's life. A green building makes efficient use of resources, such as water and energy, and, in doing so, lessens the building's impact on the environment.

Ground Ladder: A portable ladder designed to rest on the ground that may be found in varying lengths throughout the region. The most popular sizes are 16-foot and 20-foot straight or roof ladders and extension ladders from 24-foot to 40-foot.

Ground Support Device: Also called stabilizers or outriggers, these are deployed to stabilize the truck when the aerial device is in operation.

Horizontal Ventilation: Any technique by which heat, smoke, and other products of combustion are channeled horizontally out of a structure by way of existing or created horizontal openings such as windows, doors, or other holes in walls.

Inspection Cut: A small cut used to determine conditions under the roof such as: nature of the smoke (i.e., color, volume, temperature, pushing under pressure); volume of fire; the location of fire; direction of fire travel; the type, size, roof thickness, rafter spacing, and run of the structural elements; and the fire's extension.

Ladder Tower: An aerial device that contains a full-size climbing (tubular truss beam construction) ladder that also has a basket/bucket for firefighting operations attached to the tip.

Lightweight Roof Construction: This lightweight truss construction does not derive strength from mass, instead strength is obtained from multiple members that are in compression and tension. The strength of the individual structural member is dependent on the total sum of the other members; therefore, if one member fails, others may fail.

LIP: Acronym for **L**ife safety, **I**ncident stabilization, and **P**roperty conservation, which serve as the primary incident priorities.

Mid-mount Aerial: An aerial ladder that has the turntable mounting on the chassis in the middle of the vehicle, usually behind the cab.

Negative Pressure Ventilation: Using smoke ejectors to develop artificial circulation and to pull smoke out of a structure. Smoke ejectors are placed in windows, doors, or roof vent holes to pull the smoke, heat, and gases from inside the building and eject them to the exterior.

Parapet: A wall-like barrier at the edge of a roof, terrace, balcony, or other structure.

Positive Pressure Ventilation: The use of fans to pressurize a structure or compartment in conjunction with the opening and closing of doors and windows to effectively create a flow path to remove smoke from a structure.

Overhaul: The practice of opening up walls, ceilings, floors, or any void area where fire may have entered during the firefight. These areas must be aggressively opened up, inspected, and extinguished to avoid rekindle.

Quint: Fire apparatus that is equipped with a fire pump, water tank, ground ladders, fire hose, and an aerial device.

Rapid Key Entry System: A secure device with a lock operable only by a fire department master key, and containing building entry keys and other keys that may be required for access in an emergency.

Rear-mount Aerial: An aerial ladder that has the turntable mounted at the rear of the chassis.

RECEO-VS: Acronym for **R**escue, **E**xposure, **C**onfine, **E**xtinguish, **O**verhaul, **V**entilate, and **S**alvage.

Roof Pitch: A numerical measure whereby the rise (vertical distance) and the run (horizontal distance) determine the steepness of the roof.

Salvage: The protection of buildings and their contents from unnecessary damage due to water, smoke, heat, and other products of the fire.

Scrub Area: The area of the building that the aerial tip or elevated platform can effectively reach.

Short Jacking: A method by which the ground support devices, stabilizers, or outriggers aren't deployed the full distance as a result of an obstruction or topography.

SLICERS: Acronym utilized by first-arriving officer while conducting a lap to aid in tactical decision making. The acronym is defined as **S**ize up, **L**ocate the fire, **I**dentify the flow path, **C**ool the space from the safest location, **E**xtinguish the fire. The last two letters define actions of opportunities that be applied at anytime – **R**escue and **S**alvage.

Tower Ladder: An aerial device with a basket (box and beam construction) attached to the end of a boom that also contains a small ladder attached to the boom that can be used for escape.

Tractor Drawn Aerial: A tractor-trailer aerial apparatus, also known as a tiller truck, that is equipped with steerable rear wheels on the trailer.

Turntable: A rotational structural component of the aerial device allowing continuous rotation on the horizontal plane.

Utility Control: The act of shutting off the gas, electricity, and/or water to the structure or occupancy.

Vent for Search: Situation where firefighters create openings, or break windows, to gain access from an exterior position to carry out a primary search in a high-risk area of the structure.

Vent for Extinguishment: Improving interior conditions for firefighters by reducing heat levels and improving visibility.

Ventilate Enter Isolate Search (VEIS): The specific tactic employed through the use of ground ladders as a means of access to the structure when using the interior, as a means of ingress, is hampered or not possible due to untenable conditions.

Vertical Ventilation: Ventilating at the highest point of a building through existing or created openings and channeling the contaminated atmosphere vertically within the structure and out the top.

PLANNING AND PREPARATION

Planning and preparation starts the moment the members assigned to the truck company arrive at work. Members should check for any pertinent information such as street closings, equipment that is out of service, etc.

It is recommended the officer conduct a briefing at the beginning of the shift to disseminate any information that may affect response or operations. This should include road conditions, any weather/wind advisories, neighboring companies that are out of service, or any special situations that may alter the way in which the aerial apparatus responds or operates. The officer also has an obligation to ensure that those members riding for the day fully understand and are trained on the duties assigned to them (i.e., outside vent, portable ladders, or forcible entry).

All company first and second due street maps should be reviewed regularly to assure that buildings are shown accurately, especially in garden and high-rise apartment complexes.

APPARATUS TYPE

Fire apparatus manufacturers have developed three basic types of aerial devices: rear mount, midmount, and tractor drawn. Within each type are straight tip aerial ladders, termed *trucks*, and those with an elevated platform (or bucket) on the end of the ladder, known as *towers*.

Rear-mount Aerial

Truck companies in this region typically have an rear-mount aerial device that can reach 105 feet, Figure 1.



Figure 1: Rear-mount aerial.

Tower/Ladder Towers

The main difference between a tower ladder and a ladder tower is the size of the ladder leading from the turntable to the basket. A tower ladder has a narrow ladder that is capable of only emergency egress while a ladder tower has a wide walkway that can be used ascending and descending, and for victim removal operations, Figure 2. In the region, both the tower ladder and the ladder tower are referred to as towers regardless of the type of ladder.



Figure 2: Rear-mount tower.

The aerial device's turntable on a Midmount Tower is located in the middle of the apparatus as the name implies, Figure 3.



Figure 3: Mid-mount tower.

Tractor Drawn Aerials

Tractor drawn aerial devices require two operators, a tractor operator and a tiller operator, Figure 4. Even though it is tractor-drawn it is still referred to as a truck company.



Figure 4: Tractor-drawn aerial devices, or tiller trucks, are referred to as truck companies.

Quints

A quint is a vehicle that combines the features of an engine company and a truck company, Figure 5. It has a water tank, pump, and hose, in addition to an aerial device. While not numerous, there are several in use among the Northern Virginia jurisdictions, both as front line apparatus as well as in reserve status.



Figure 5: A quint provides the features of both an engine and a tower.

RESPONDING

Alarm Responses

The respective building occupancy operations manual (such as *Single-family Dwellings, Fires in Residential and Commercial Townhouse and Rowhouses*, etc.) will dictate the truck company's responsibilities by the dispatched assignment. Companies shall follow the dispatch order assignment unless there is a significant delay in the unit arrival sequence. Any anticipated significant delay in arrival should be voiced over the radio by that unit and the first due battalion chief should reassign units depending on their new arrival order.

First-due Truck Company

The first-due truck company will generally do the following:

- The truck company officer will ensure a 360° lap of the structure has been completed prior to entry.
- Position for turntable placement, force entry, ventilate accordingly and in concert with interior operating companies, search for and communicate the location of the fire, search for occupants, place portable ladders, assist with salvage/overhaul, and provide lighting.
- If staffing permits and if approved by command, the truck company may split the crew so that there is an interior team to force entry and search for fire and victims and an exterior person(s) to place portable ladders, perform coordinated ventilation, and raise the aerial ladder.
- Typically, the truck company will report with the first-due engine company to the fire floor to assist with forcible entry, primary search, and coordinated ventilation.
- Give a radio report announcing the final position taken if it differs from the operations manual corresponding to the type of dwelling at which the incident is located.
- Place portable ladders and announce their location via radio to all units operating on the fireground.
- Identify and control the flow path to the fire by controlling the door(s) until the engine company advances a charged hoseline to the seat of the fire.

Second-due Truck Company

The second due truck company will generally do the following:

- The truck company officer will ensure a 360° lap of the structure has been completed prior to entry.
- Position opposite the first-arriving truck or at the next best strategic position.
- Coordinate ventilation of the structure with the engine company and/or interior crew(s).
- Assists the first truck company with their assigned tasks, as needed.
- Typically report to the floor above the fire floor to assist with forcible entry, primary search, and ventilation.
- Place portable ladders and announce their location via radio to all units operating on the fireground.

Response to Fire Alarms

The fire service has experienced unfortunate situations in the recent past where a routine fire alarm incident has escalated to a working fire and ultimately resulted in a line of duty death. A key element to avoiding these types of unfortunate outcomes is eliminating complacency in incident operations. In an effort to eliminate complacent behaviors, personnel should expect the building to be on fire when they arrive and not assume it is a false alarm. Companies must treat every call as the most significant incident of their career until determined otherwise. All personnel shall wear all PPE, including SCBA, and bring a handlight and tools.

Personnel should gather information from evacuating occupants and/or the building representative as to the exact location and nature of the alarm. If present, personnel should obtain Knox box keys prior to entering the structure, as they may be needed to obtain access to remote areas of the structure. Personnel shall ascertain the location of the fire control room and/or annunciator panel and verify the location, type, and number of alarms activated.

Safety

The Commonwealth of Virginia's driving laws as well as department regulations must be followed during every response. The turnout time and response must be carried out with due regard to safety and in accordance with Commonwealth law. The knowledge of all members regarding the area and routes of travel is of the utmost importance.

Personnel should remain aware of environmental conditions when operating as a member of a truck company. Wind conditions not only affect fire behavior but also the ability to use the hydraulic ladder (refer to manufacturers limits). Rain, sleet, and snow can also affect the usage of the ladder.

APPARATUS POSITIONING

The officer and driver shall decide where to position the apparatus based on many variables. Incident priorities, occupancy type, and arrival sequence are a few of the immediate and uncontrollable circumstances that dictate the decision. Other factors will affect this decision as well, such as:

- Location of victim(s),
- Location and extent of the fire,
- Incident Strategy (offensive, defensive, transitional),
- Wind direction,
- Truck type,
- Access and/or set back,
- Potential for collapse,
- Topography,
- Water supply operations and FDC locations,
- Exposures, and
- Obstructions (e.g., electrical wires, trees).

Approaching the incident scene the truck company should proceed deliberately, keeping in mind the need to properly spot the turntable. Additionally, it will provide for the best access to portable ladders and other equipment based on arrival order. A deliberate approach also gives all members extra time to assess the building and develop a plan of action. At this point, the foundation is being established for efficient fireground operations

The most important factor in positioning is to determine the intended target/task and then spot the turntable for incident priorities:

- Immediate victim rescue that is beyond the reach of portable ladders.
- Master stream operations.

General Positioning Issues

The first-due truck company should position on the side of the structure where the fire is located or suspected. The second-due truck company should position on the opposite side, when possible. This normally is not possible on a typical house fire due to limited vehicle access on side Charlie or when the first due truck positions directly in front of the structure. When this occurs, the next option is to position the second due truck near the first due truck in front of the structure, ideally bumper to bumper allowing for portable ladder access from both apparatus. Consideration for placement at the next best strategic location should be a guiding factor in placement of the second arriving truck.

Often, due to topography, other structures, or any number of obstacles the rear may not be accessible, Figure 6. If unable to position opposite the first truck, then position to reduce the distance required to carry portable ladders and equipment for operations in the rear, or sides, of the structure. When there is limited or restricted access to the sides of the structure, the truck company should position at the best location available and communicate their position.

When a specific target has been identified for placement of the aerial ladder or platform, the turntable should be positioned in line with the target.



Figure 6: Obstacles like waterways can drastically affect truck company positioning. When discovered, these obstacles must be reported the command post.

The decision whether to back in a rear-mounted aerial or nose-in a midmount aerial, is dependent on the incident dynamics and jurisdiction preference. Each operator and officer must work together to position the apparatus in the most advantageous position keeping in mind manufacturer specifications. Observe smoke conditions and direction and position the turntable slightly upwind.

When multiple locations are identified, position the turntable to reach as many of the locations as possible. A priority must be assigned to life safety of civilians and fire department personnel. Reaching all the locations in a timely manner may require multiple truck companies to position on the same side, Figure 7.



Figure 7: Multiple aerial devices positioned on the same side.

If the aerial will be used, the driver and OIC shall scan the scene for obstructions. Any object that may interfere with the positioning of the apparatus such as wires, trees, utility poles, and signs. In rescue situations, rapid placement of the ladder by pushing through tree branches, limbs, or signs may be necessary. When feasible, and if a tactical position is deemed necessary, tree limbs should be trimmed to facilitate the aerial with reaching its target.

The horizontal distance from the building to the turntable, known as setback, is critical to consider and may include things like parking areas, common grounds, sidewalks, and landscaping. Anything that takes up the space from the aerial turntable and the structure will ultimately have to be accounted for when determining positioning for the use of the aerial. If the aerial is needed but the turntable is too close to the building, the aerial cannot be rotated from the bedded position to the building. Optimally, towers should be able to place their bucket on the ground and/or below grade in front of the fire building, Figure 8.

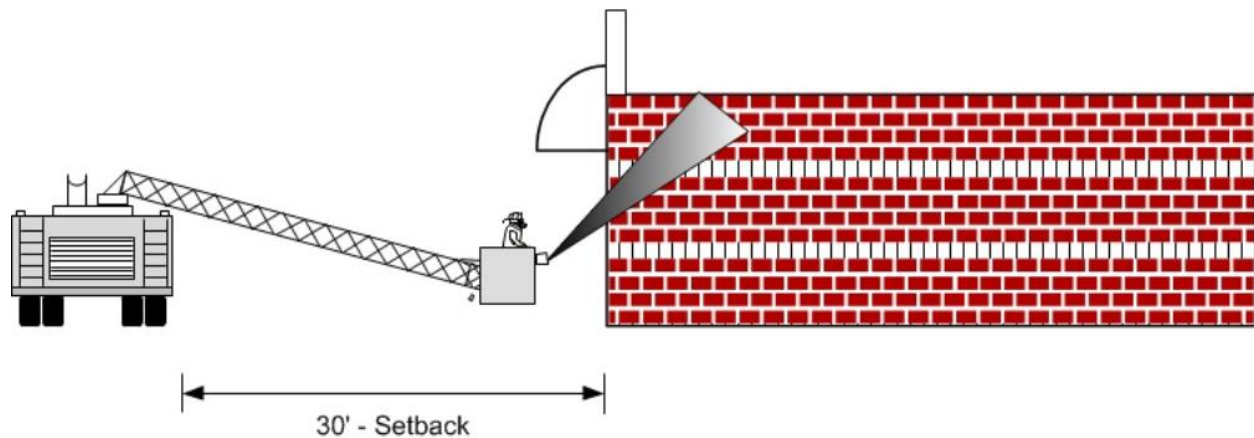

Figure 8: Proper positioning of the apparatus is essential to ensure that the hydraulic ladder can be operated below grade.

Tractor drawn/Tiller Trucks

Tiller operator considerations for placement will vary depending on the type of incident to which the tiller truck is responding. When arriving at a single-family dwelling or townhouse, portable ladders may be needed therefore the area behind the ladder bed must remain clear. The tiller operator should consider positioning the trailer at an angle that prevents the ladder bed from being blocked by other fire apparatus or vehicles. All portable ladders must remain accessible during all emergency incidents. If the tiller truck responds to an apartment complex or other large commercial building, the aerial device could be used to access the roof. The location of the turntable on the tiller truck chassis is similar to that of the mid-mount aerial apparatus turntable, so placement on a structure fire is similar. The overall length of the vehicle and the ability to jack knife the vehicle for placement will demand greater attention and awareness of the tiller truck driver.

Because of the length of the tiller apparatus, the incident street should be accessible for other apparatus, if possible. If it is required to block the entire roadway, verbalize this action over the radio so other responding units can make adjustments prior to arrival.

Stokes Basket Operations

The truck company is primarily responsible for the set up and operation of a stokes basket operation, Figure 9. Regardless of the type of system used to lace the patient to the basket and the rigging system used to secure the device to the aerial, truck company personnel should be familiar with the operation of not only their set up but also mutual aide truck company stokes operations.

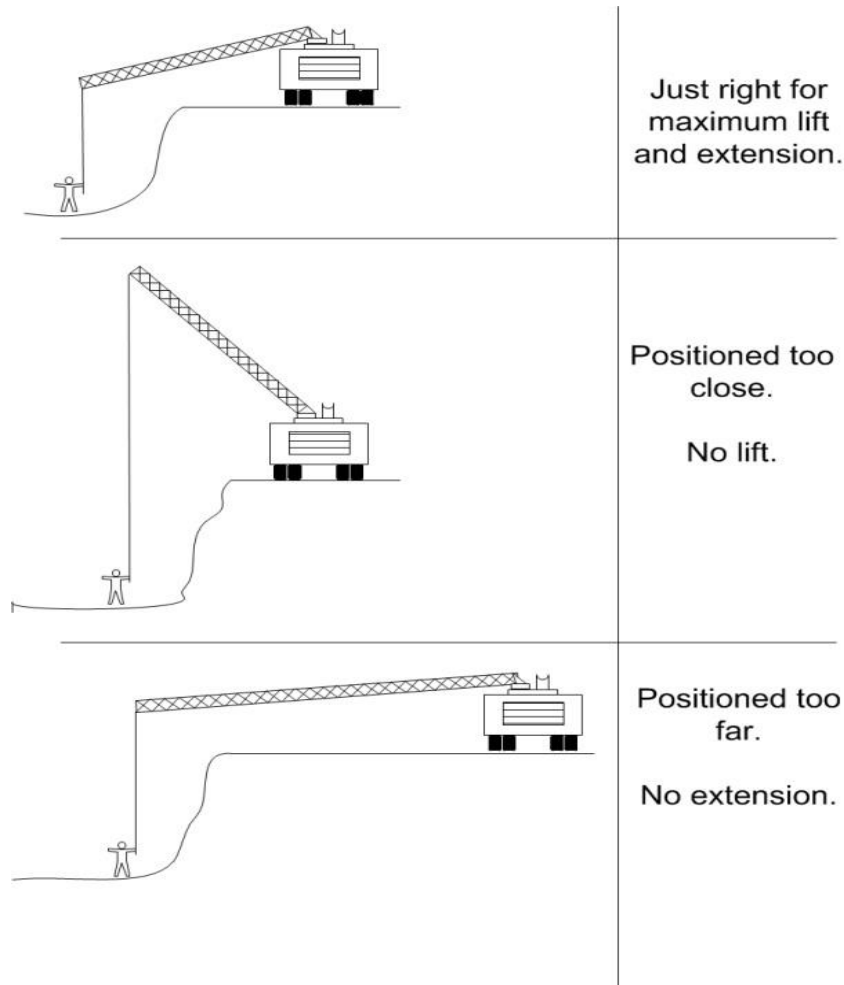

Figure 9: Typical stokes basket operations.

General Truck Positioning

Truck company personnel should train often on the most efficient and effective use of their hydraulics ladders on buildings in their response area. The proper positioning of the turntable in relation of the fire building is essential for effective use of the hydraulic ladder, Figure 10.

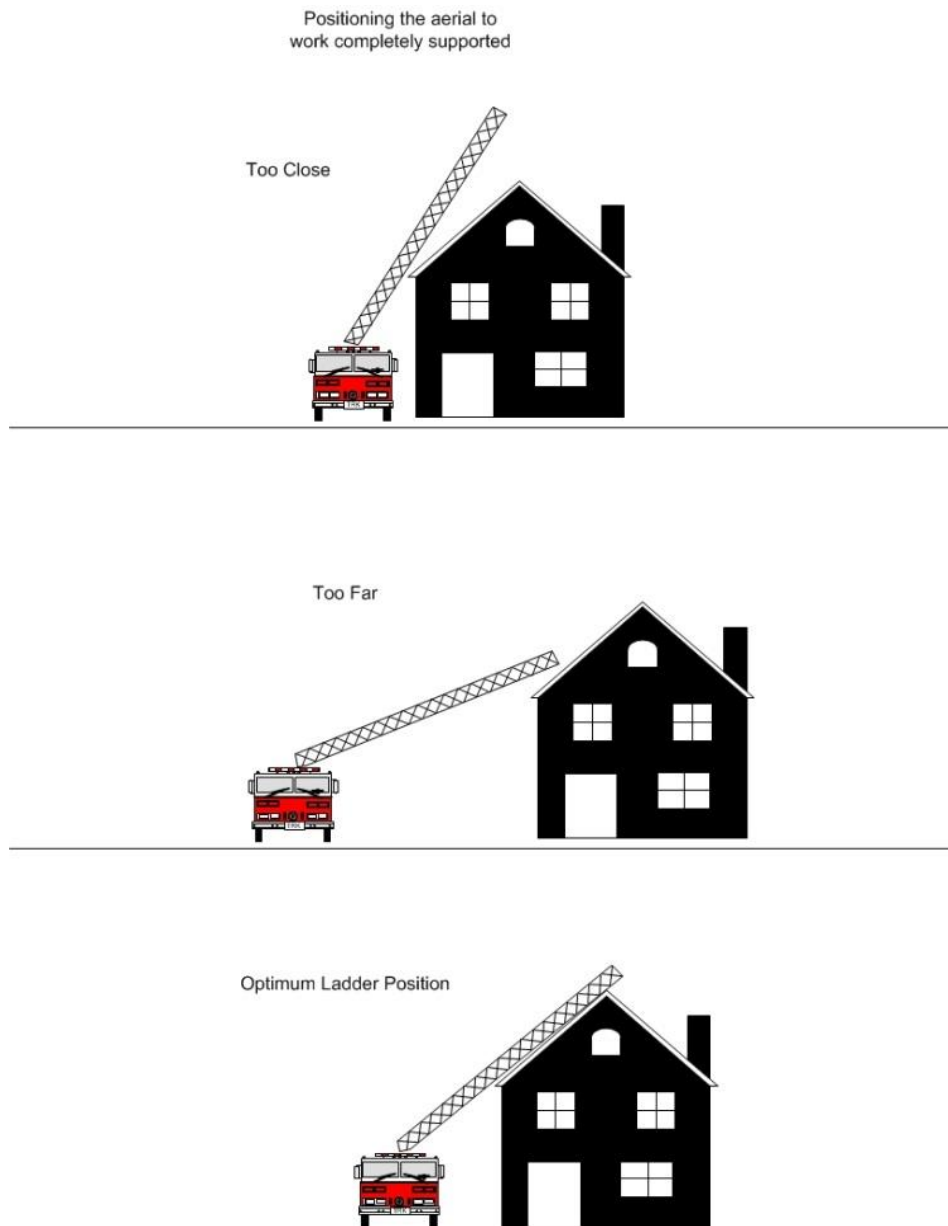

Figure 10: The length of the bedded ladder section along with the correct apparatus positioning is paramount for successful use of the ladder.

Apparatus that is positioning on the fire ground must keep sufficient space to the rear of the truck clear to allow for access to the portable ladder bed, Figure 11.



Figure 11: Portable ladders are inaccessible when other apparatus position too close.

The aerial device can be positioned one of two ways on uneven terrain: laterally (side-to-side) and longitudinally (front-to-rear), Figure 12. When considering both of these types of placement, personnel should reference the manufacturer’s specifications with regard to the apparatus capabilities and capacity, Figure 13.

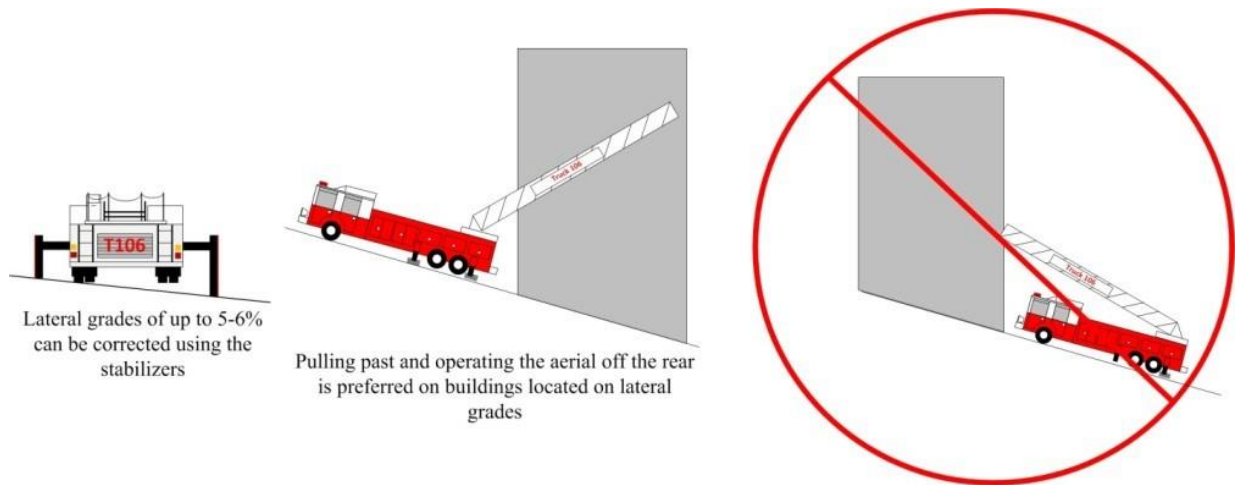

Figure 12: Aerial apparatus operators must be well versed in positioning on uneven terrain.

Safe Operating Limits: Pierce Aerial Devices		
Aerial Capacity Based on Side-to-Side Setup Slope		
Ground Slope	Truck Slope	Capacity
10°	0 to 5°	Full
13°	5.1 to 8°	Half
>13°	>8°	Zone
Aerial Capacity Based on Front-to-Rear Setup Grade		
Ground Slope	Truck Slope	Capacity
7°	0 to 5°	Full
10°	5.1 to 8°	Half
>10°	>8	Zero

Figure 13: An example of a manufacturer's specifications that can affect positioning.

Scrub Area

The scrub area is the portion of the building that can be reached by the tip of the aerial or the bucket of the tower. Examples of scrub area are shown in Figure 14, Figure 15, and Figure 16. Many variables will affect the scrub area, including the setback from the structure, the collapse zone, and overhead obstructions. When positioning, the tactical assignment will dictate whether the scrub surface coverage is needed for only one side of the building or multiple sides. Positioning on a corner allows for coverage on two sides of the building, Figure 15.

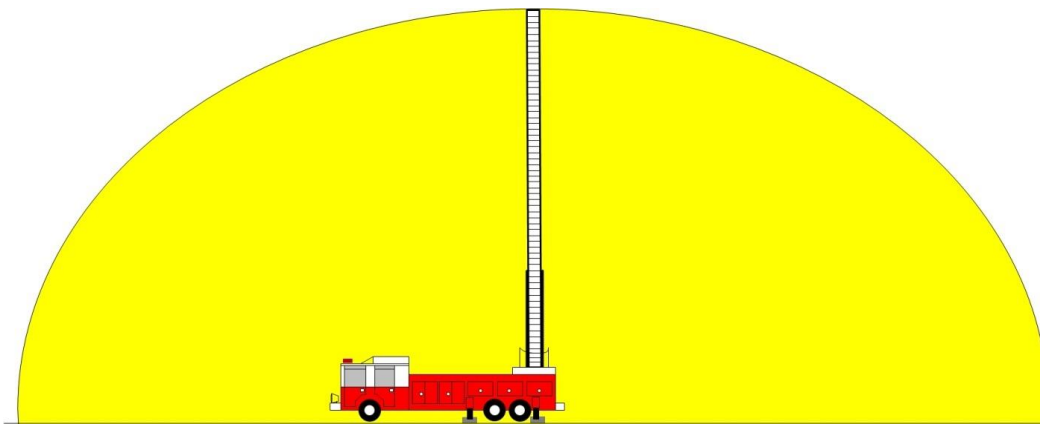

Figure 14: Scrub area.

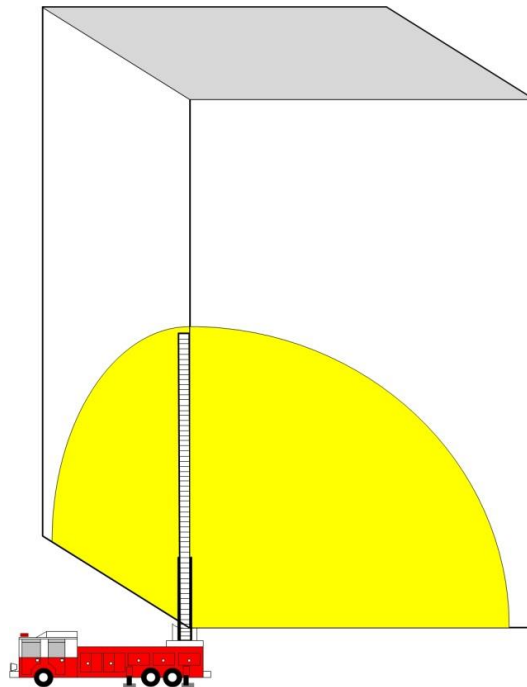

Figure 15: Positioning on the corner of the building allows the truck company to scrub two sides of this building.

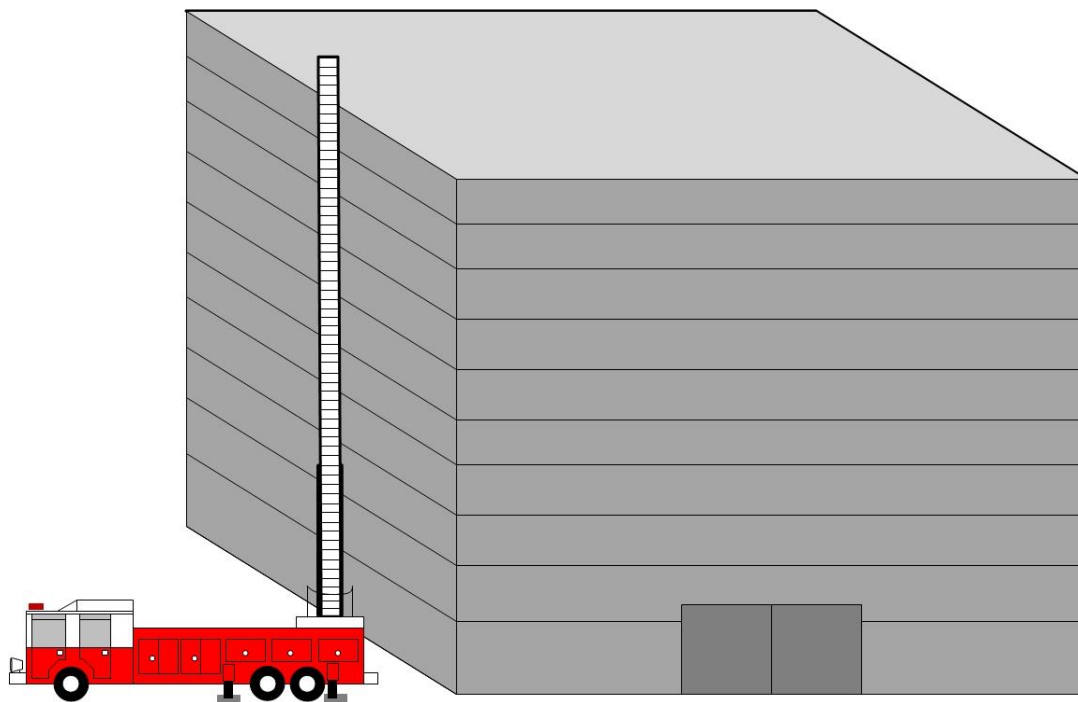

Figure 16: On rear mount aerial devices, backing in and placing the turntable closest to the building will often prove advantageous by increasing the scrub area and allowing for maximum extension of the ladder.

Potential Hazards to Consider in Positioning

Collapse Zone

Officers and truck drivers must remain cognizant of the collapse zone of the building when positioning. As a rule, consider the collapse zone as one and one-half times the height of the building. For a 100-foot building, a collapse zone of 150 feet would need to be established Figure 17. When collapse is a factor, position the vehicle outside the collapse zone. Note that the corners of the building provide safer working areas.

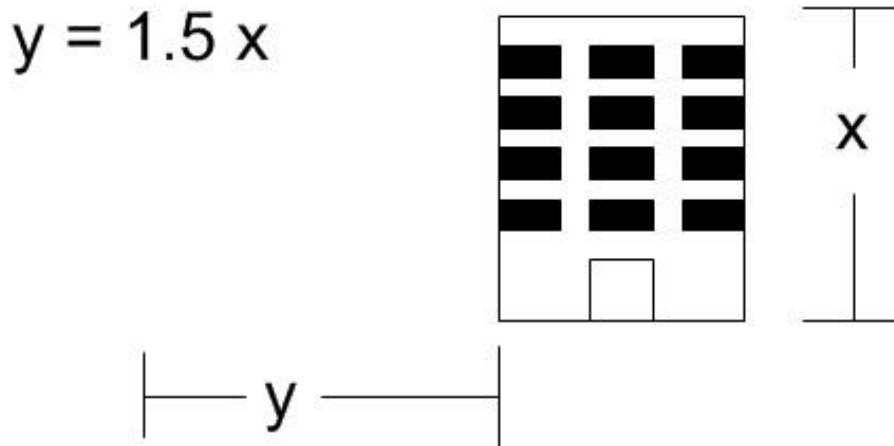

Figure 17: The collapse zone is 1.5 times the height of the building.

Personnel must take into consideration that if a hydraulic ladder must be used for master streams or to perform a victim rescue, the truck company may be within the collapse zone despite the collapse zone rule (1.5x the height of the building); in these cases, when the task is complete, the unit should be relocated outside of the collapse zone.

Overhead Electrical Wires

Firefighters must remain aware of the electrical hazard when an aerial is extended. The following basic rules should be followed anywhere and anytime the aerial device is operating:

- Firefighters should not sit or lean against a truck/tower.
- Firefighters should look up at the aerial ladder's location and make eye-to-eye contact with the operator before touching the truck.
- Firefighters should be in the habit of touching a truck with the back of their hand before grabbing door handles, tools, or ground ladders when the aerial is in operation.
- Personnel are discouraged of using the truck for command or rehabilitation operations if the aerial is being used near wires as these functions encourage personnel to make frequent or prolonged contact with the vehicle.

Caution must be exercised when operating around energized wires. No matter the circumstances, **a minimum distance of 10 feet shall be maintained between the aerial device and the wires at all times.**

Weight Restrictions

Personnel should be aware of weight restrictions for buildings and surfaces when planning to use a truck company. Weight restrictions are commonly found in parking garages and parking facilities. A posted weight restriction may allow for the operations of a truck company driving on the roadway due to the disbursement of the vehicle weight on the axles of the truck. However, when a truck company deploys the outriggers, the disbursement of weight changes and is focused on a singular spot, which may exceed the restriction. For instance, a truck company with an outrigger deployed can concentrate a weight of more than 40,000 lbs. on the spot where the outrigger contacts the roadway, exceeding 400 pounds per square inch. The usage of a jack plate can decrease the weight to the singular outrigger to 25,000 lbs. or less than 35 pounds per square inch.

Ground Support Devices

Ground support devices intended specifically for public safety operations may be present in buildings and road surfaces in this region. Preplans should indicate any special truck placement information, such as placement of reinforced ground support or pads for outriggers, Figure 18, or special access points with ground support, Figure 19.

Note: Personnel should also check the effectiveness of truck company positioning preplans when a new vehicle is purchased.



Figure 18: This photograph of an apparent sidewalk that terminates into a wall is actually a concrete pad placed at the corner of this high-rise building to provide support for a Truck's stabilizer.



Figure 19: The area where this firefighter is standing is actually designed for fire department vehicle access. The compacted soil and tile blocks are hidden beneath the grass. These kinds of hidden vehicle access points need to be readily displayed on maps and preplans.

Outriggers

The ground on which the outriggers rest must be firm and level. Outriggers shall never be placed on manhole covers, storm sewer boxes, underground vaults, or curbs not supported by a sidewalk. Be aware that these obstacles are often found in the courtyards of apartment complexes. The truck driver must frequently check the jack plates to ensure that stability has not been compromised, Figure 20. Master steams, when flowing for extended periods of time, may affect the stability of the ground due to large influx of water and erosion of the ground.



Figure 20: Jack plates should be centered over the outriggers.

Short Jacking

Before parking and positioning the aerial device operators should ensure that no obstructions such as vehicles, curbs, or other objects will prevent the outriggers from extending fully. However, there are times when the aerial device must be positioned in a specific location but obstructions or narrow alleyways prevent the full deployment of the outriggers. If this scenario occurs, the aerial device can still be raised by short jacking one set of the outriggers. Most aerial devices will not permit the use of the ladder on the short-jacked side, as safety limiters prevent this operation, Figure 21. Personnel should consult the specific manufacturer's recommendations with regard to short jacking.

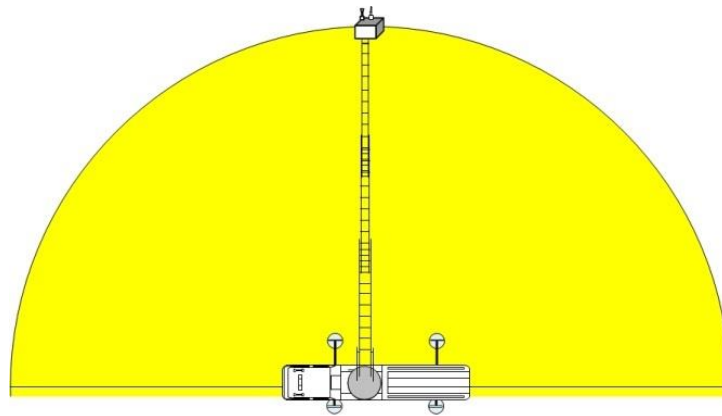

Figure 21: Use of the aerial is permitted on the non-short jacked side of the apparatus.

Apparatus Placement Specific to Occupancy Type

Using Alleyways

Proper prepanning will identify structures with the presence of an alleyway that will provide for placement of a truck company opposite of the first arriving truck. An alleyway can provide access for the arriving truck companies to be able to ladder the fire building and the most threatened exposures simultaneously. On many streets this does not occur due to the placement of engine companies and/or the presence of a dead-end street or court. Figure 22 provides an example of single family dwelling and townhouse/rowhouse positioning that takes advantage of alleyways in the rear of the affected structure.

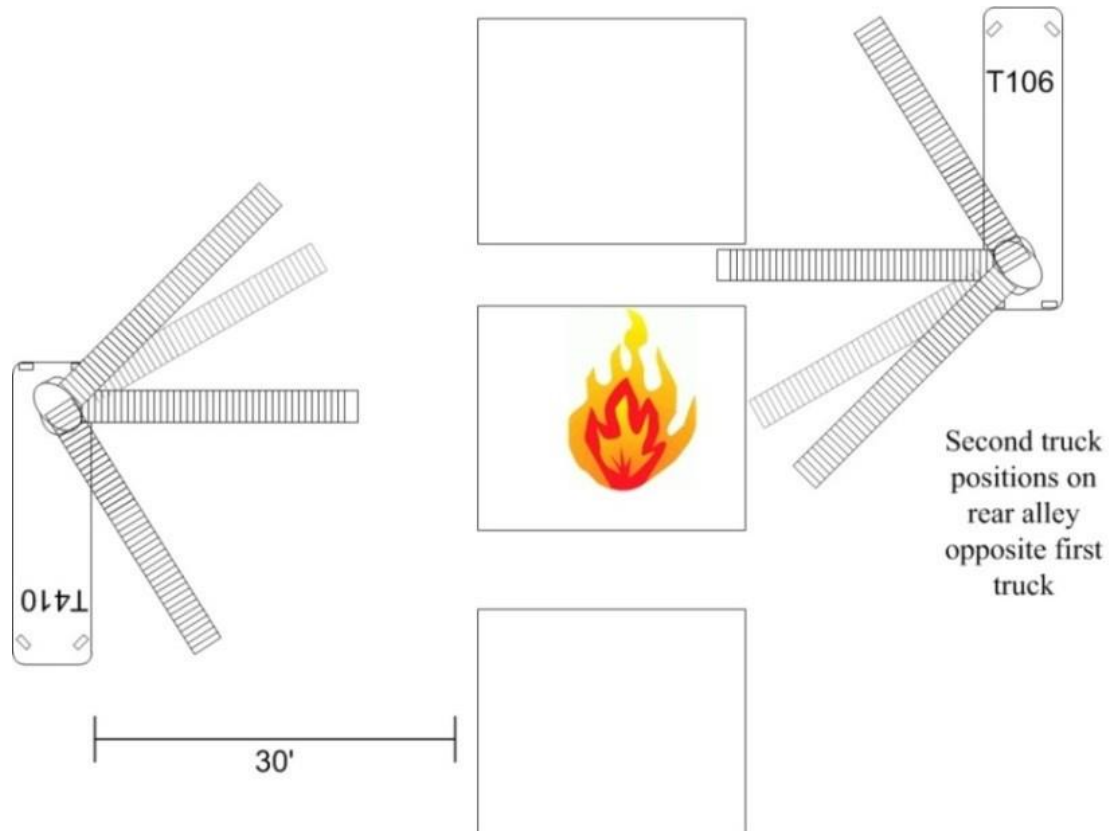

Figure 22: When present, the use of an alley or parallel street on the opposite side of the 1st arriving truck can provide an excellent tactical position for both trucks.

Townhouse/ Rowhouse Positioning

The configuration of a townhouse/rowhouse development can be difficult for truck company positioning. The rapid confirmation of the address and knowledge of the layout of the development can assist greatly in proper truck placement. Engine company personnel should be aware of the most effective truck position available and position their apparatus accordingly if the truck is arriving after the unit is positioned. If the fire is confirmed in the end unit, the truck company can position to access the fire unit, the Bravo exposure and the Alpha exposures, Figure 23. If the fire is confirmed to be in a middle unit, the truck can position in front of an exposure to access multiple floors of the fire unit and the exposures, Figure 24.

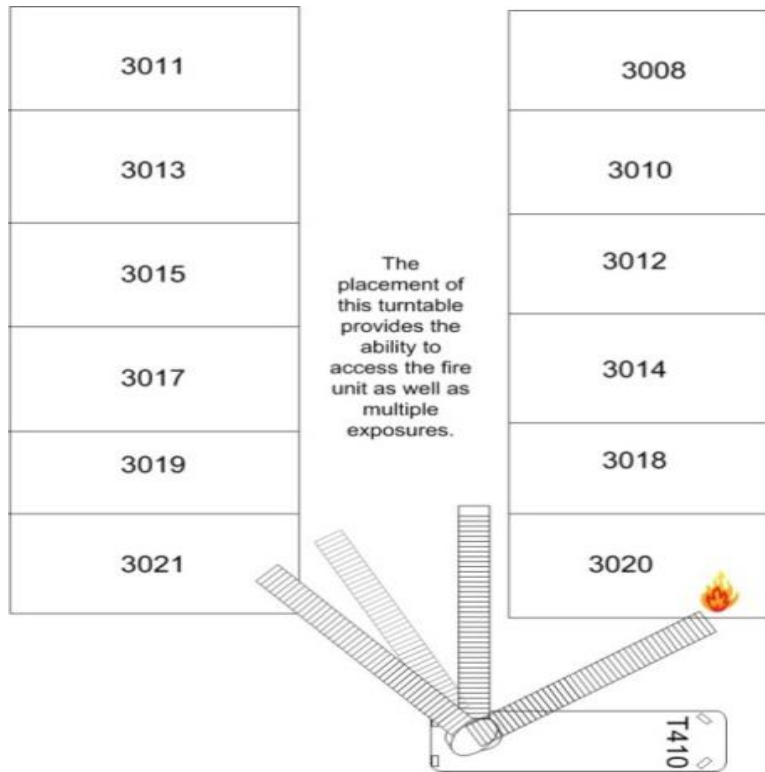

Figure 23: Example of townhouse/rowhouse positioning.

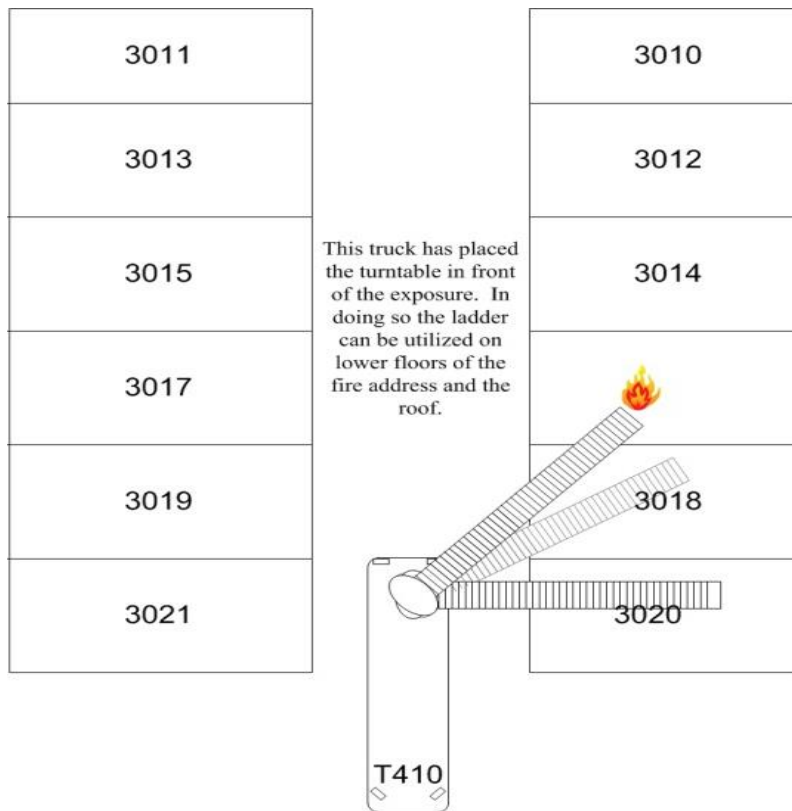

Figure 24: Another example of townhouse/rowhouse positioning.

Strip Shopping Center

Truck companies reporting to the rear of strip center buildings must be aware of low wires, narrow access, and vehicles blocking access. It is common to use ground ladders in the rear of strip centers due to these hazards and obstacles. If heavy fire conditions are encountered requiring either an offensive exterior attack or defensive operations, the Incident Commander (IC) should use a tower ladder (or more than one if necessary) on side Alpha for mobile ground-level heavy caliber streams, Figure 25.

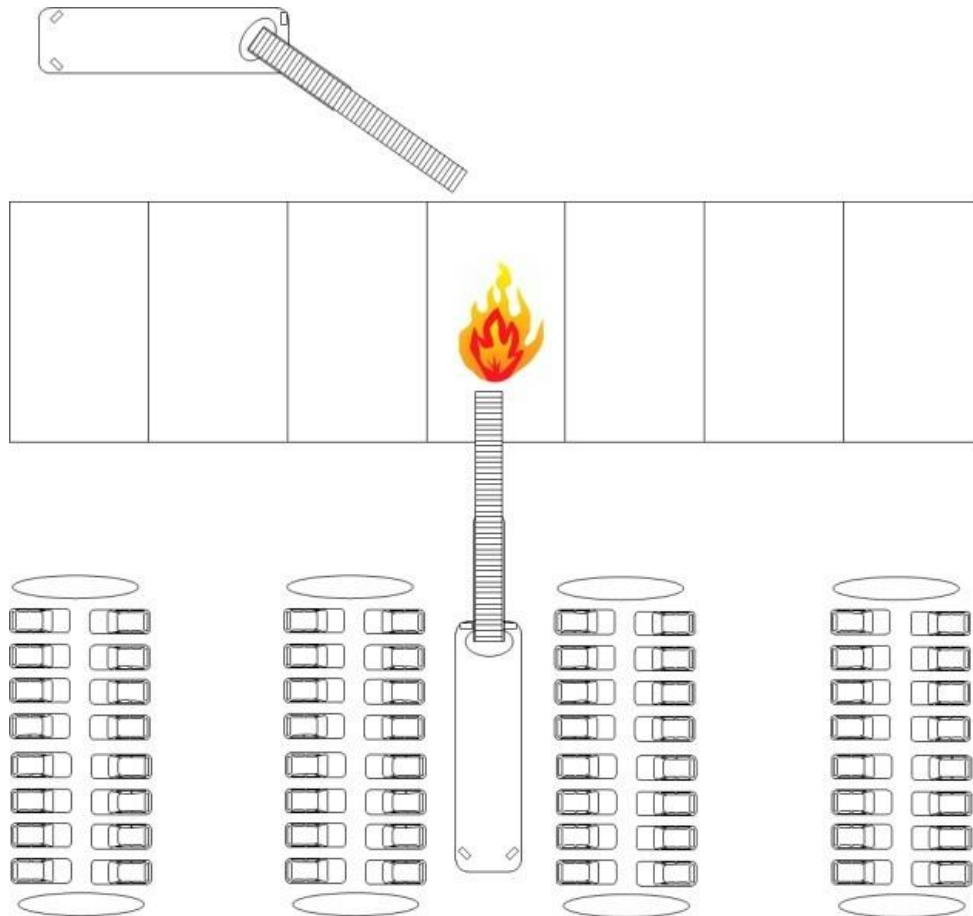

Figure 25: An example of optimal truck company positioning for a fire in a strip shopping center.

Garden Apartment

The truck company can be simultaneously tasked with extinguishment and exposure protection. The truck alternates the stream between extinguishment and exposure protection by going over the rooftop, Figure 26.

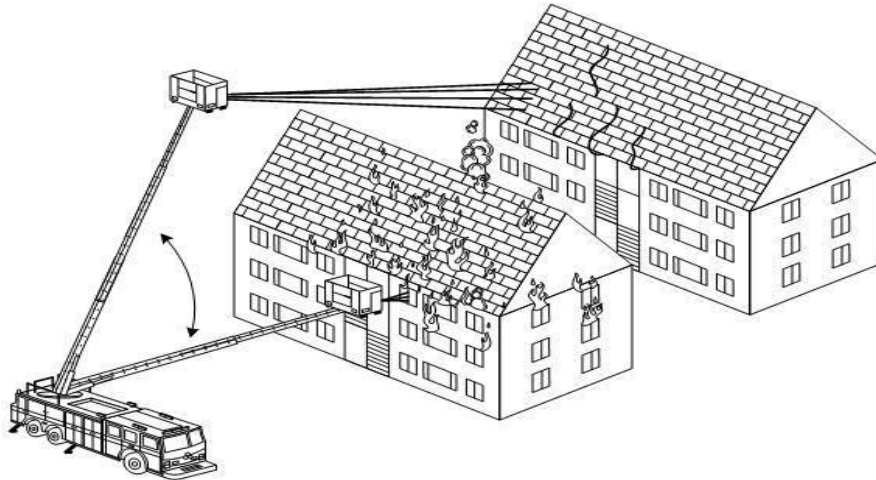

Figure 26: A properly positioned truck company can accomplish two tasks, if needed.

When confronted with fires that are moving vertically, the stream should work its way from the

High-rise

The first-due truck on a high-rise should park on side Alpha unless fire location can be readily identified. If so, the truck should then park on the fire side of the building if it is accessible. If feasible, based upon the location of the fire and if the hydraulic ladder is to be used, the responding trucks can be placed at the corners of the building to ensure two-sided scrub area. Positioning at a corner of the building places the aerial apparatus in the safest location should a collapse occur, as the corners are the safest location during a collapse. This also affords the truck company the ability to access two sides of the structure with one ladder, Figure 27.

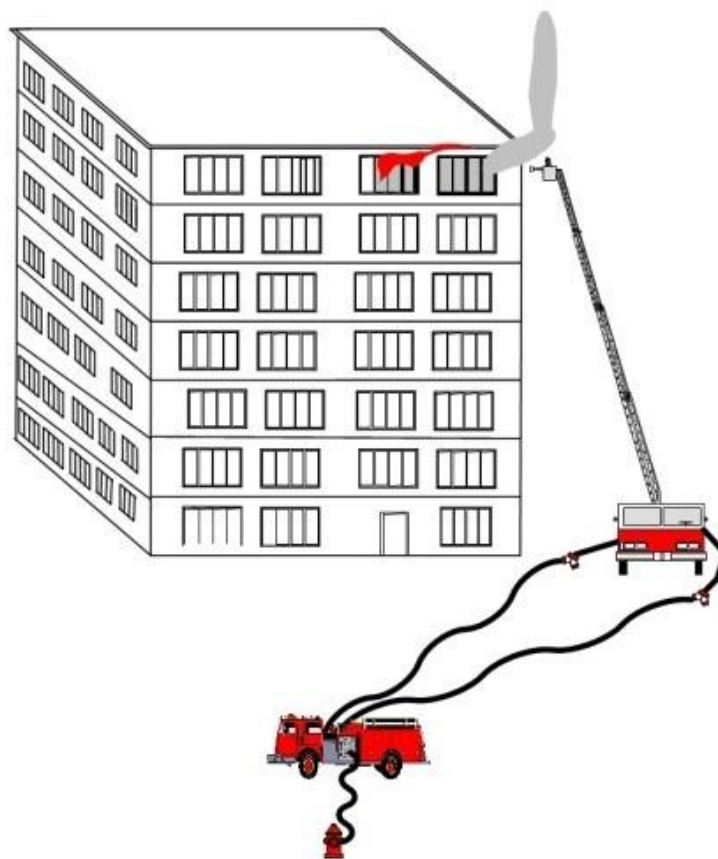

Figure 27: Example of high-rise positioning.

Storage Facilities

During advanced fires at outdoor self-storage facilities, consider positioning the aerial device down a parallel alley and use the aerial master stream **over** the exposure, Figure 28. This allows for a master stream attack but prevents positioning within the collapse zone and away from radiant heat, Figure 29.

U-Storage Outdoor-Type Facility

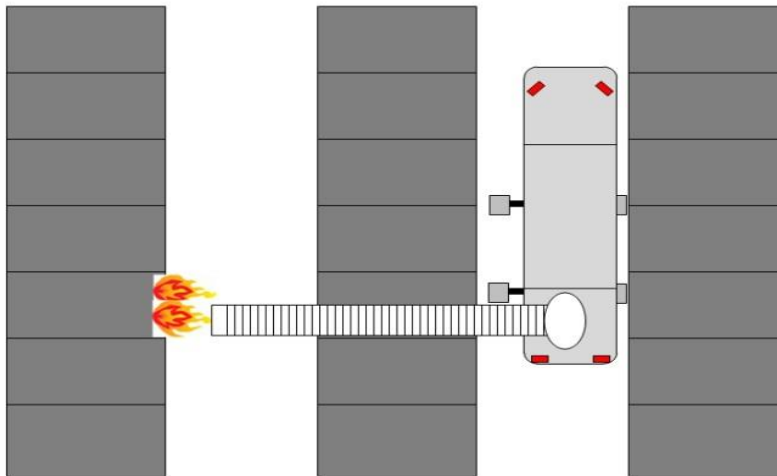

Figure 28: Storage facility positioning example.



Figure 29: Truck companies should use the reach of the hydraulic ladder during advanced fires by positioning on a parallel alley and projecting the master stream over and into the involved unit(s).

OBJECTIVES

In 1953, Lloyd Layman published the book *Fundamentals of Fire Fighting Tactics*¹ which offered his detailed synopsis of the basic divisions of firefighting tactics that firefighters could apply to the most complicated situations they would mitigate. This synopsis became the acronym that has been a guiding force in firefighting tactics at structure fires and is recounted in various fire service textbooks: RECEO-VS.

Firefighting tactics first consisted of size up, which enabled the officer to determine the appropriate course of action based upon an initial mental evaluation. The **sequential** order of the firefighting tactics that Layman offered is expressed in the historical acronym that is still used today. This bulleted list is verbatim from Lloyd Layman's text and clearly defines the purpose and intention of his division of firefighting tactics:

- **Rescue** – Remove human beings (or valued livestock) from the involved building and convey to a place of safety.
- **Exposures** – Actions required preventing a fire from extending to uninvolved buildings or separate units.
- **Confinement** – Actions required preventing the fire from extending into uninvolved sections of the building.
- **Extinguishment** – Actions required in attacking and extinguishing the main body of the fire.
- **Overhaul** – Actions required to complete extinguishment of any remaining fire, preventing rekindling, and to place the building in a safe condition.
- **Ventilation** – Actions required displacing a heated and contaminated atmosphere by replacing with air from the outside atmosphere.
- **Salvage** – Actions required protecting buildings and contents from preventable damage due to water.

Over the course of time, the fire service has evolved this list to adapt to our ever-changing firefighting environment. This evolution has led to fewer adherences to the strict sequential order of the tactics. Realistically, it became more of a checklist of objectives to complete that will bring an incident to closure, oftentimes, in varying order.

An example of this may occur when an engine company arrives at a working fire with reports of people trapped and makes the tactical decision to deploy water quickly on the seat of the fire instead of initially focusing on the tactic of a primary search. This tactical deviation would address the rescue by implementing extinguishment first, as it is understood through experience that putting the fire out may be the greatest lifesaving tactic we can employ.

The example stated above is just one of many examples at fire incidents in which Lloyd Layman's acronym may be modified. RECEO – VS, in today's fire environment, still has its place with command officers using it as an objective list to be completed prior to the termination

¹ http://books.google.com/books/about/Fundamentals_of_Fire_Fighting_Tactics.html?id=1ZIBAAAIAAJ

of an incident. However, it no longer serves as a mandated chronological template the company officer operating in a fire attack mode must use in a sequential order.

This knowledge must be coupled with empirical data recently offered from Underwriters Laboratory (UL) and National Institute of Standards and Technology (NIST). There is a strong need for the fire service to conduct a considerable evaluation of this material and its associated impact on our tactics. The fire service knows that our fires are absolutely behaving differently than fires experienced in 1953. These factors include the modern home furnishings, home layout and size, and construction features such as energy efficient measures.

These factors have led to the creation of a new tactical decision-making model for fire department personnel who are initially operating at a fire and must make tactical decisions in the modern firefighting environment.

SLICE-RS is a recently introduced tactical decision model that incorporates the proven methodology learned from Lloyd Layman and pairs it with the vitally important data from UL and NIST in an attempt to provide a comprehensive tactical checklist for initially arriving officers operating in a fire attack mode.²

- **Size up** – A tactical plan for a fire must be developed, communicated, and implemented. First-arriving officers/incident commanders are responsible for obtaining a 360° view of the structure involved.
- **Locate the fire** – The location and extent of the fire in the building must be determined and communicated. Officers should use all means available to make this determination. Thermal imagers can prove valuable during the initial 360° lap of the structure. The location of the fire and current conditions will dictate the best location to attack the fire.
- **Identify the flow path** – Identify the presence and/or location of the flow path. Flow path evaluations should include openings acting as intakes and discharges as well as smoke indicators of color, volume and velocity of the flow path. Efforts should be taken to control ventilation and the flow path to protect potential building occupants and limit fire growth. If a flow path is visible, consider closing doors and windows to limit air flow. When closing doors and windows, firefighters should be aware of any potential rescues readily accessible via doors/windows. This would be the opportunity for the officers to identify areas available for Vent Enter Isolate Search, or VEIS.
- **Cool the space from the safest location** – Given information obtained during the size up, locating the fire, and identifying the flow path steps, the officer will determine if high heat/untenable conditions exist inside the structure. When these conditions are present, the officer will determine the safest and most direct way to apply water to the superheated space, or directly on the fire when available. The primary goal in this step is to reduce the thermal threat to firefighters and potential occupants as soon as reasonably possible.
 - **Note:** This does not mean every fire must be hit from the exterior prior to entry. Rather, it means that the officer must make an educated and informed decision on

² <http://modernfirebehavior.com/s-l-i-c-e-r-s/>

the quickest and most efficient deployment of water to the seat of the fire with the greatest outcome.

- **Extinguish the fire** – Once the thermal threats have been controlled, the fire should be extinguished in the most direct manner possible. This may mean hitting the fire from the exterior initially with a short blast of water to knock down or reset the fire, followed by the rapid deployment of a hose line to the seat of the fire via the interior to fully extinguish the fire.

Actions of Opportunity – Can be employed at any time.

- **Rescue** – The officer should consider the potential for rescues at all times. Firefighters should be prepared to remove occupants. It should be reinforced that many times the best action the initial units can take is to suppress the fire. The first-arriving officer must make a rapid and informed choice on the priority and sequence of suppression activities versus occupant removal. **As life safety is the highest tactical priority, rescue shall always take precedence.** The IC must determine the best course of action to ensure the best outcome for occupants based on the conditions at that time.
- **Salvage** – Firefighters should use compartmentalization to control fire spread and smoke whenever possible and protect occupant possessions in the best available means once fire has been extinguished.

Ventilation

Noticeably absent from this tactical list is ventilation. Fire department personnel should manage, and control the openings (doors, windows) to the structure to limit fire growth and spread and to control the flow path of inlet air and fire gases during tactical operations.

All ventilation must be coordinated with suppression activities. Uncontrolled ventilation allows additional oxygen into the structure which may result in a rapid increase in the size and hazards associated with a quickly expanding fire, due to increased heat release rates. Ventilation occurs with many of our actions, even if it is not intended, such as when we perform forcible entry. This action is necessary to gain access to the seat of the fire but without the proper application of water this form of ventilation can be detrimental to life safety, incident stabilization, and property conservation.

Tactical Operations

To be successful in our future operations we must be vigilant in our observation of past practices and exercise careful deliberation when evaluating new practices and information. As such, the NOVA region will adapt the following into our tactical operations:

Staffing

Minimum staffing for truck companies in Northern Virginia includes an officer, driver, and one firefighter. When truck companies are staffed with extra personnel, officers should have a plan for this additional staffing. A split concept plan for staffing on truck companies (interior team and exterior team) should be well established and, most importantly, trained on before it is used on any incident. (See Tasks below for an example of the split concept.)

The officer may consider splitting the crew based on the size up. If the officer determines the driver alone cannot complete laddering, exterior ventilation, and all other assigned exterior tasks in a safe and timely fashion, then the crew should work together. If the officer decides the driver can complete the outside duties alone, then the remaining personnel can complete other assignments, including interior duties, together. The size-up of the incident and assigned tasks will be the determining factors when officers are considering dividing their crews. The officer and crew must adhere to the two-in/two-out rule, notify command, and have the splitting of the crews approved forming an X-ray crew. In addition, they must communicate the location in which they plan to operate and the task they will be completing.

Strategy

Strategy is the general plan or course of action decided upon to reach the objectives. Generally, this is indicated by the mode of operation (offensive or defensive) and should be based upon a solid risk assessment of the incident scene. The factors that influence strategy are the incident priorities often expressed in the acronym LIP:

- Life safety,
- Incident stabilization, and
- Property conservation.

Tactics

Tactics are the operations that accomplish the incident priorities and support the strategy that the incident commander has defined to mitigate the incident.

It is incumbent upon the officer to ensure that all personnel understand the strategies, tactics, and their respective assignments.

All tactical operations should be based upon SLICE-RS.

Tasks

Tasks are the jobs performed to accomplish the tactics. Company tasks include:

- Search and rescue.
- Ventilate, enter, isolate, and search (VEIS).
- Coordinated ventilation.
- Portable laddering.
- Aerial laddering.
- Forcible entry.
- Checking for extension.
- Utility control.
- Overhaul.
- Salvage.
- Elevated master stream operations/flying standpipes.

- Advancing handlines via the aerial device. (Consideration should be given to securing the handline to another object and removing it from the ladder bed so the truck company can be used for other tasks.)

Tools carried into the structure should be able to execute the assigned task. The generic complement of tools and equipment carried by all crews are:

- Set of irons (flathead axe/Halligan bar) or a Halligan paired with a striking tool.
- Hydraulic forcible entry tool.
- Hook appropriate for the occupancy. (Consider ceiling heights when choosing the hook, i.e., a 4-foot hook will do you no good in a grocery store and conversely a 12-foot hook will be cumbersome in a residential apartment building.)
- Thermal imager.
- Hand lights.
- Door chocks.
- Pressurized water extinguisher.
- Portable radio.

Depending on the occupancy and the tasks assigned to the crew, other tools that are commonly used include:

- Lock removal tool (K tool).
- Sledge hammers or mauls.
- Tagline.
- Markers, chalk, or signage to assist in identifying stairwells and search status.

When the tactical decision has been made by the truck company officer to split their crew due to staffing, fire conditions, or access, and is approved by Command, consideration should be given to establishing an interior and exterior crew. An example of an established breakdown of personnel and responsibilities is as follows:

Table 1: Interior and Exterior Tasks and Personnel Complement

Firefighters	Interior Team	Exterior Team
3 Personnel	Officer, Forcible Entry	Driver
4 Personnel	Officer, Forcible Entry	Driver, Outside Vent
5 Personnel	Officer, Forcible Entry, Pressurized Water Can	Driver, Outside Vent
6 Personnel	Officer, Forcible Entry, Pressurized Water Can	Driver, Outside Vent, Roof Operations

Primary Tasks of the Interior Crew

The interior crew will initially force entry into the structure, simultaneously search for victims and fire, communicate the location and path to the fire, perform interior ventilation (coordinated with attack), and control utilities.

Primary Tasks of the Exterior Crew

The exterior crew shall be responsible for horizontal and vertical ventilation. Ventilation can be either natural or forced (PPV). All ventilation activities shall be coordinated with the fire attack completed by interior personnel.

Placement of portable ladders is also the responsibility of the outside crew. Portable ladders should be placed at any windowsill where the access or egress of firefighters is needed and to locations where victims are present or suspected. **Placement of the portable ladders does not authorize a firefighter to remove a window without confirmation from interior personnel.** Personnel should also identify and control outside utilities and, once completed, report this information to command.

Exterior crews shall exercise situational awareness while completing their assigned tasks and maintain a vigilant watch of the fire conditions and the fire building. Any change in the flow path, volume of fire evident, or rapid spread of fire should be communicated to interior crews.

Crew Responsibilities

Aerial apparatus drivers often operate independently of the officer and crew. He or she needs to know the incident's goals as well as the tasks that the unit must accomplish. They will often need to make multiple decisions independently, without direct guidance. Some questions that an operator should consider are:

- Is this a defensive fire in which master stream preparation is a priority?
- Is a crew searching directly over a fire and require ladder placement to the windows?
- Is there a victim on a balcony?

The well-trained aerial apparatus driver preplans these questions in his or her mind and works to accomplish these tasks.

The officer and driver should be able to recognize tasks to be completed, prioritize them, and then determine the proper turntable placement upon arrival at the scene.

- Are there obvious victims?
- Is there an exposure that will require elevated master stream protection?
- Will we need to travel to the roof and perform vertical ventilation or will horizontal ventilation be more appropriate?

Upon approaching the scene, the aerial apparatus should deliberately approach and observe both the building and conditions present prior to committing the apparatus, allowing for the correct apparatus placement the first time.

General Duties When Paired with Engine Companies

When paired with engine companies, the Truck can perform many tasks:

1. Advance down the hallway with the engine and force entry into the fire compartment/building.
2. Control entry doorways that have been forced to limit flow path.
3. Primary search of the fire compartment/building.
4. Determine if need for vent for search or vent for extinguishment is appropriate.
5. Force an adjoining door for any area of refuge.
6. Check for extension within the fire building.

RAPID KEY ENTRY SYSTEMS

Rapid entry key systems are the preferred method of entering the building in all cases. There are several brands of rapid key entry systems used in Northern Virginia:

- Knox Box system,
- Supra Key system, and
- Lock-Box system.

All truck companies within the Northern Virginia region should carry rapid entry keys. Some building key systems contain keys to the building and elevators. Other building key systems may contain an entrance key and a key to the fire control room.

Inside the fire control room may be an additional key box containing multiple sets of building and elevator keys as stipulated by building code. The key boxes housed in the fire control room allows building maintenance members to keep keys up to date without having to call a fire department unit to open the rapid entry box.

UTILITY CONTROL

Control of utilities (gas, electric, and/or water) is a duty of the truck company. There are times when it is necessary to shut down utilities before an incident can be controlled. Incidents have been encountered where a fire could not be extinguished because it involved an inside gas meter or electric panel. Truck companies should shut off gas and electric as soon as possible, Figure 30.

Additional utility control considerations are discussed at greater length in current version of *Utility Emergencies*, Fire and Rescue Departments of Northern Virginia.



Figure 30: The location and control of utilities is an important function of the truck company.

SALVAGE

Salvage is property conservation and is an important, and often overlooked, part of our operation on the fireground. Salvage is meant to limit the damage caused by fire or the fire control efforts and is often done in conjunction with firefighting efforts. While it is understood that firefighting efforts shouldn't be delayed in order to conduct salvage operations there are ways that we can perform our duty to reduce loss and conserve property while engaged in firefighting, such as:

- Crew discipline. This means things like removing only those windows that are needed for immediate ventilation while opening others and limiting damage to furniture and not displacing it unnecessarily. Another example is the use of the thermal imager to assist in overhaul, thereby lessening undue damage while searching for hidden fire.
- Placing photographs in desk drawers or under bed sheets to eliminate the smoke/water damage.
- Placing jewelry in drawers for security.
- Move items into another room not affected by fire prior to beginning overhaul operations.
- Using water chutes.

Most damage that is caused after the fire has been knocked down is done so unnecessarily simply because we don't take the time to salvage properly. By remaining professional and applying the resources at our disposal (thermal imaging devices, salvage covers, lighting, etc.) we can perform our job and protect citizens' property.

All personnel operating on the fireground are responsible for loss control and property conservation efforts; however, the OIC should ensure specific actions and tasks are performed in such a way to minimize damage.

OVERHAUL

Overhaul is a thorough and deliberate check for fire extension. The fire area is essentially stripped to its frame and contents are removed. Overhaul operations should be planned and systematic as time and speed are not as critical. It is mandatory that the condition and stability of the structure be evaluated before overhaul begins. Although utility control is normally already completed by this stage in the operation, confirm that it has been done prior to initiating overhaul.

It is important to note that overhaul may be delayed in the area of fire origin until an investigator can survey the scene. At some incidents, especially if they involve a fatality or appear to be suspicious, overhaul may be delayed until the investigation is complete.

Companies will often be required to remain on scene after other units have cleared to assist the investigators and provide manpower, lights, tools, and ventilation.

Many firefighters have suffered injury or even death during the non-emergency phase of overhaul due to the compromised structural components of the building. In an effort to reduce these incidents, firefighters must consider performing a safety inspection prior to overhaul. For basic contents fires, the company officer is typically capable of completing this task. For larger fires involving structural members, the safety officer, building inspector, or a technical rescue member familiar with building construction should be assigned to complete the inspection.

A report shall be made to the IC following the pre-overhaul safety inspection. Based on the report, the intensity of the task, and the staffing required to carry it out an overhaul strategy should be developed for the event. Prior to committing personnel, a decision by the IC must be made balancing the risk involved with manual overhaul. If the risk is high, hydraulic and mechanical overhaul should be considered.

The IC should take the following checklist into consideration when developing an overhaul plan:

- Scene integrity for investigators.
- Current and pending weather conditions.
- Resources required for completing the task – tower, crane, backhoe, foam, etc.
- Required staffing and/or possible rotation of personnel.
- Ensure all safety precautions are maintained (e.g., ladders, R.I.T., etc.)
- Support services (Light & Air, Canteen).

During overhaul operations, personnel should use caution when working around high rack storage as found in big box hardware stores, as it has been known to collapse due to its weight during a working fire. The same is true when dealing with materials that can hold large volumes of water (e.g., large paper rolls, boat storage and tire storage, landfill/recycle plant piles). The extra water weight may cause these items to collapse.

During overhaul, personnel must wear SCBA until the air is monitored and deemed safe by the IC or designee. Sprinkler activation may create cold smoke regardless of the size of the fire. Although cold smoke is typically translucent, it may obscure vision to the floor and contain toxic

gases along with high CO levels. Vigilance with regard to air management shall be exercised in overhaul the same as it is during an extinguishment or search operation.

Overhaul can be challenging at high-rise fires. Personnel should not throw burning materials from windows or the balconies of upper floors. Personnel should not ride down in elevators with smoldering debris. It is often best to remove smoldering materials to the balcony and soak them down. For fires on lower floors, the debris can be carried down the steps or thrown out of windows as long as the area in the path is clear. Large items, such as a couch, may need to be cut apart and moved in sections.

Consider using Class A or B foam at 1% to penetrate deep-seated fires, like those found in cardboard storage facilities, during overhaul operations.

A safety inspection should begin on the exterior of the building to include:

- Incomplete glass removal.
- Proper ladder placement.
- Cracks (significant) in the walls and or foundation.
- Swimming pools/hot tubs.
- Open wells/holes.
- Collapse hazards (chimney, soffit, dangerous overhangs, cantilever balconies).
- Utility control when required.
- Indicators of a weak building prior to the fire (wall plates or stars, bowstring truss construction).
- Proper exterior lighting.
- Slip hazards (ice, broken glass).
- Dangerous topography (sharp drop off in yard).
- Safe removal overhaul area developed and identified.
- Deployment of fire line or danger tape to identify hazards.

An interior overhaul safety inspection should include the following:

- The weight of standing water within the structure from firefighting and increased weight of furniture if it is saturated from firefighting.
- Building structural members affected by the fire (weak roof or floor truss assembly).
- A building that has undergone significant remodeling that may have removed bearing walls and or columns.
- Suspended hazards – chandeliers, large decorative fixture.
- Any interior collapse hazards (rack storage, large wet paper roll).
- Cracks in floors, walls, or ceilings.
- Four-gas meter readings (percentage of LEL, parts per million of carbon monoxide).
- Proper PPE for task assigned.
- Rested/fresh crew. (Crew rotation in place for long-term operations.)
- Proper interior lighting.
- Proper ventilation.
- Deployment of fire line or danger tape to identify hazards.

Overhaul is vital during grease duct fires, common in restaurants. Grease duct fires may easily extend to combustible roofing materials, Figure 31. A thorough check should be completed from both below and above the roofline.



Figure 31: Grease fires often extend upward into the roofing materials.

BUILDING CONSTRUCTION

An understanding of building construction is an essential and fundamental skill for every member in the fire service. There are certain aspects, however, that those operating on the truck company should pay special attention to due to the scope of their duties. It is imperative that companies get out in their first-due response areas while buildings are being constructed in order to truly know with what they will be dealing on an incident. This text will provide a basic overview in the area of building construction, but understanding the basics of roof and floor construction and how those components will react when exposed to fire will enhance the ability to make sound decisions on the fireground.

Conventional Wood Roof Construction

Conventional roof construction uses dimensional lumber that relies on its mass for strength. The minimum size for support members in this construction is 2" x 6". The greater the span required of the structural member, the larger the dimension of the lumber. Conventional roof construction does not typically depend on the total sum of all the structural components to support a given load. The individual support member depends on its mass for the strength to support the load.

Lightweight Roof Construction

Unlike conventional construction, lightweight construction does not derive its strength from the shear mass of the lumber, but is the result of geometry and individual, lighter-weight members that are in compression and tension. These structures are commonly referred to as trusses. According to Francis Brannigan, a truss is defined as, "a framed structure consisting of a triangle or group of triangles arranged in a single plane in such a manner that loads applied at the points of intersections of the members will cause only direct stresses (tension and compression) in the members. Loads applied between these points cause flexural or bending stresses."³

The strength of the entire truss system is dependent on each component. Should one of these components fail, it is likely that the entire truss system will fail and, subsequently, each truss system after that.

A common lightweight construction practice uses 2" x 3" or 2" x 4" wood structural members held together by metal truss connectors, Figure 32. In three-story structures and larger, the first floor will be constructed using 2" x 6". It should be noted that all lumber is measured prior to milling and will reduce the size of the material by 1/2". A 2" x 3" is actually 1 1/2" x 2 1/2" and a 2" x 4" is actually 1 1/2" x 3 1/2".

Metal truss connectors will vary in size, thickness, and depth of penetration. Truss connectors used 35 years ago were commonly heavy gauge steel with 1/2-inch prongs that penetrated the wood. The modern type of truss connector today is a stamped out, light gauge aluminum with 3/8-inch or less prongs.

³ Brannigan, F. & Corbett, G. (2013). *Building Construction for the Fire Service, 5th Edition* (465). Burlington, MA: Jones and Bartlett.



Figure 32: Truss connectors before and after partial collapse.

The use of lightweight trusses equals low mass and short burn time, early failure, and collapse. Trusses are under tension and compression. When the bottom chord or webbing fails due to the truss connector, de-lamination or failure due to fire, the entire truss can fail.

In structures where the trusses span large areas, there is the potential for catastrophic collapse under fire conditions. Members should not be on the roof of a structure where fire is suspected or confirmed in the truss area without being independently supported. The IC and truck officer must take these construction methods into account in their overall operation at structure fires.

Using experience and training, the ability to accurately estimate the amount of time that the roof can be considered structurally strong is dependent upon answering the following:

- What is the type of construction and its condition?
- Has the fire entered or taken possession of the cockloft/attic area?
- How long the fire has been burning and its extent?

Truss Floor Construction

The truss and plywood I-beams, Figure 33, have become more common than dimensional floor joists or roof rafters, which are found in older conventional construction. The same truss construction concept may be found in floor joist assemblies as well. Another type worth noting is the plywood I-beam, which is constructed using 2"x4"s for the top and bottom cords and the webbing or center core area is accomplished using oriented strand board (OSB). Again, as an engineered lumber, it makes for a relatively sound construction component, but when exposed to fire it will fail more quickly than sawn lumber. In addition to the lighter mass of the plywood I-beam, contractors will often decrease this mass even further by drilling through the OSB in order to pass wires, conduit, and pipes for plumbing.



Figure 33: Plywood I-beam, also known as a Ply-I.

When under fire conditions, the center chord of the ply-I will burn away quickly, while the plywood floor that is supported by the ply-I sustains little or no damage, Figure 34. Wood joists made with dimensional lumber provide higher fire resistance as compared to engineered floor joists. In this test program, traditional lumber joists failed at about 16 minutes, while engineered floor joists failed at about six minutes under ASTM E-119 fire exposure.⁴ A firefighter standing on this floor can fall abruptly into the basement of this structure.



Figure 34: Plywood I-beam subjected to fire conditions and has disintegrated.

⁴ *Basement Fires: Understanding Collapse Hazards and Fire Dynamics to Increase Firefighter Safety*. UL Web-based Training, 7 March 2013.
<http://lms.ulknowledgeservices.com/catalog/display.resource.aspx?resourceid=356711>

ROOF CONSTRUCTION AND TYPES

Conventional A-Frame Gable Style Roof Using Dimensional Lumber

Type III – Ordinary Construction

The conventional A-frame Gable style roof using dimensional lumber/Type-III ordinary construction roofing system has moderate resistance to failure under fire conditions, Figure 35. The use of dimensional lumber and nails enables this roof to resist the effects of fire for a moderate amount of time. These roofing systems tend to burn away rather than collapse into the building. A chain saw is the standard tool of choice for rapid vertical ventilation.

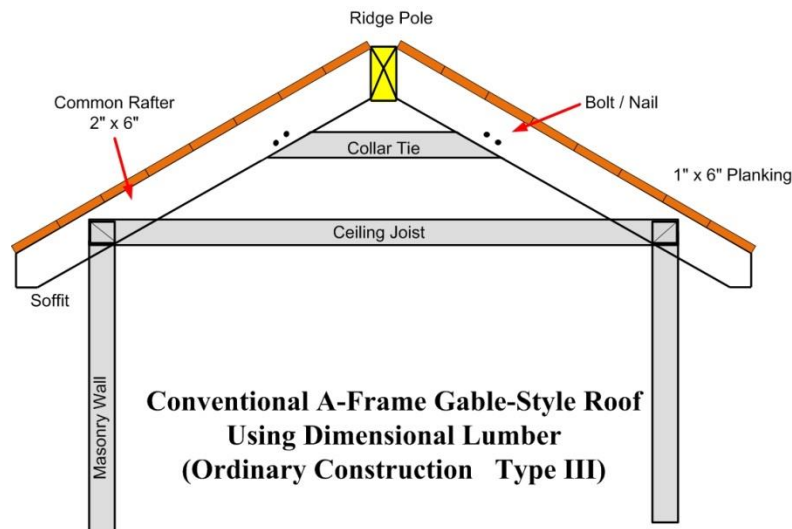

Figure 35: Example of conventional A-frame gable style roof on a masonry structure.

Type V – Wood Frame

The conventional A-frame Gable style roof using dimensional lumber/Type-V ordinary construction roofing system has moderate resistance to failure under fire conditions, Figure 36. The use of dimensional lumber and nails enable this roof to resist the effects of fire for a moderate amount of time. Firefighters must evaluate the conditions of the wood bearing walls prior to committing crews to the roof. These roofing systems tend to burn away rather than collapse into the building. A chain saw is the tool of choice for rapid vertical ventilation.

Lightweight A-frame

The lightweight A-frame type roofing system is vulnerable to rapid failure under fire conditions, Figure 37. The use of lightweight 2" x 4" joist, truss plates, and plywood reduce the structural mass and create rapid failure. These roofs tend to burn away rather than collapse into the building. Firefighters must not work on these roofs directly over the fire. Unless positioned well ahead of the fire, firefighters should work independently of the roofing system (aerial ladder/tower bucket). A chain saw is the tool of choice for rapid vertical ventilation.

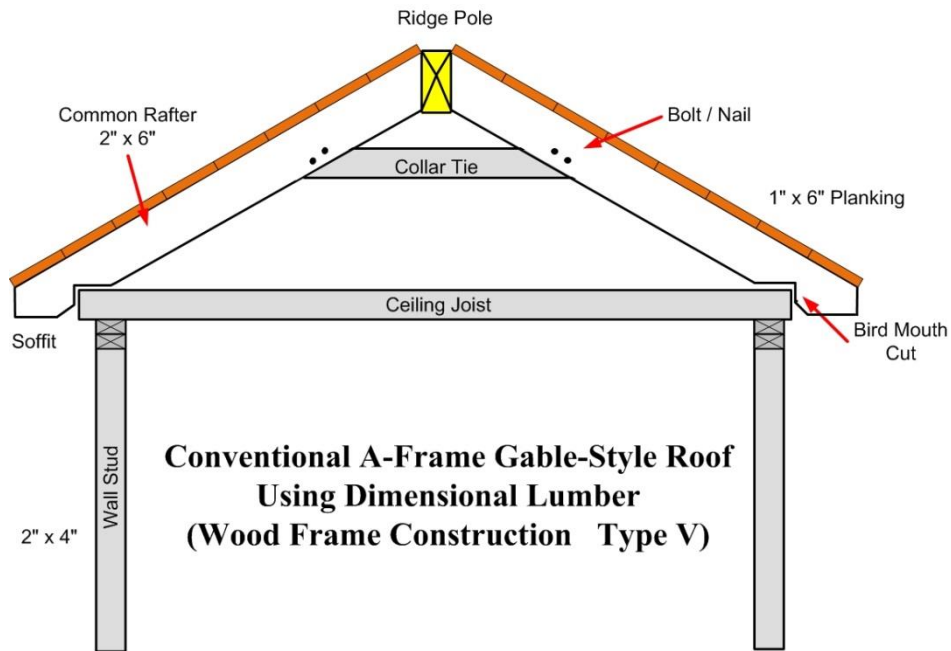

Figure 36: Example of an A-frame gable style roof on a wood frame structure.

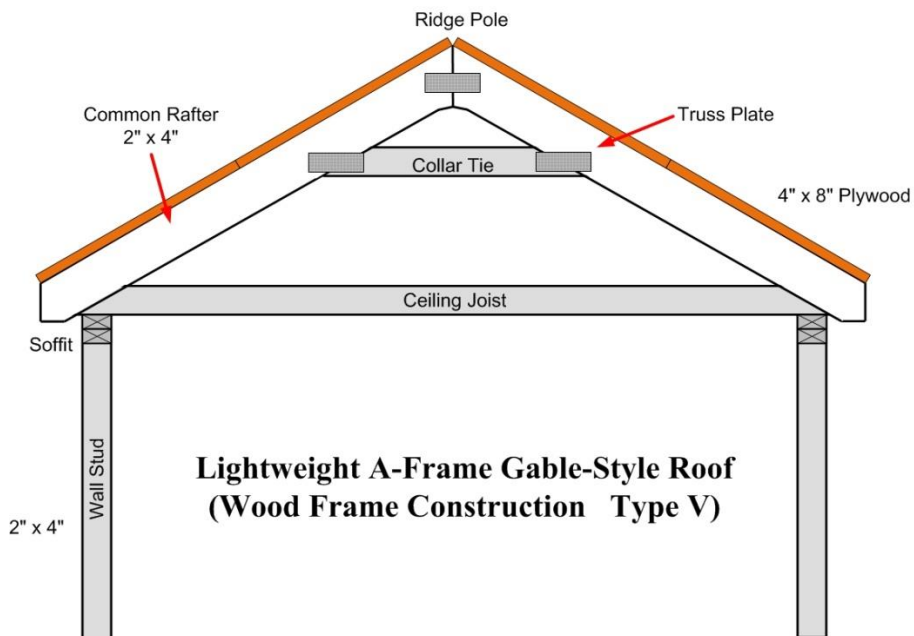

Figure 37: Example of a lightweight A-frame gable style roof on a wood frame structure.

Lightweight Truss Roofing System

The lightweight truss roofing system is vulnerable to rapid failure under fire conditions, Figure 38. The use of lightweight 2" x 4" joist, truss plates and plywood reduce the structural mass and create rapid failure. These roofs tend to burn away rather than collapse into the building. Firefighters must not work on these roofs directly over the fire. While working under these roof systems firefighters should attempt to operate in smaller compartments due to large spans and

concentrated loads. Unless positioned well ahead of the fire, firefighters shall work independently of the roofing system (aerial ladder/tower bucket). A chain saw is the tool of choice for rapid vertical ventilation.

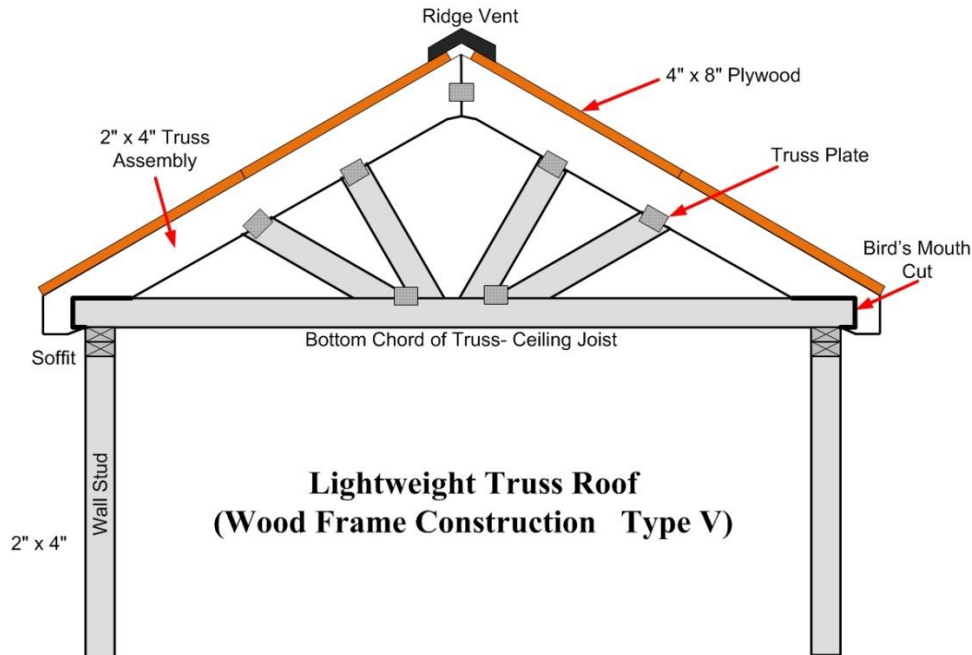

Figure 38: Example of a lightweight truss roof on a wood frame structure.

One-piece Laminated Arch

The one-piece laminated arch roofing system is moderately resistant to failure under fire conditions, Figure 39 and Figure 40. The use of large wooden structural members provides significant mass. Unlike heavy timber construction, these large mass timbers are multiple layers of wood and are glued together. Extended exposure to heat will cause the glue to decompose and the arch to lose its structural integrity. This roofing design tends to kick out at the base and collapse violently into the structure upon failure. They typically fail suddenly and without warning. Firefighters should operate independently from an aerial or tower bucket. The choice of ventilation tool will vary upon the roof deck material. Wood planking and metal are common decking materials.

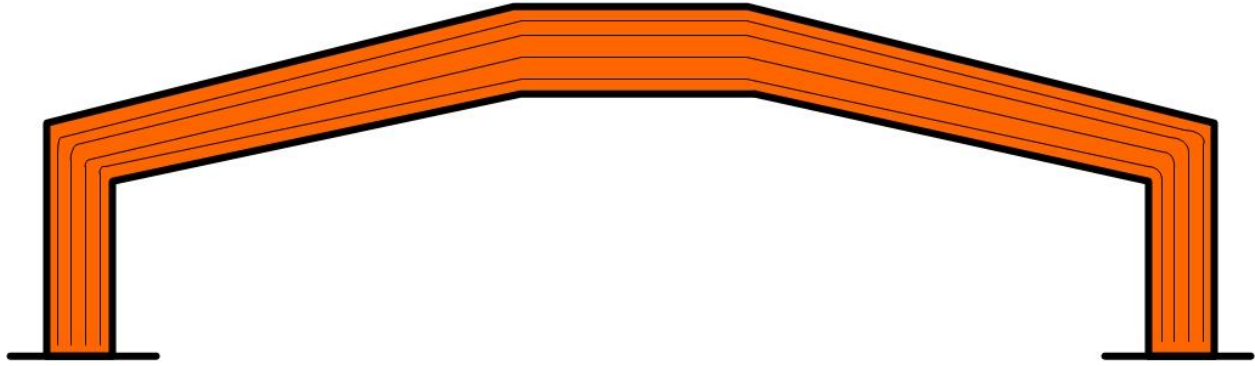

Figure 39: An example of a laminated arch.



Figure 40: Laminated arch roof, common in old grocery stores.

Multiple-section Laminated Arches

The multiple-section laminated arches roofing system is subject to failure faster than the one piece laminated arch. The use of large wooden structural members provides significant mass. Unlike heavy timber construction, these large mass timbers are multiple layers of wood that are glued together. Extended exposure to heat will cause the glue to decompose and the arch to lose its integrity. Unlike the one-piece laminated arch, the multi-section laminated arch is typically bolted together with metal gusset plates, Figure 41. The metal gusset plates absorb heat at a rate much higher rate than wood. When the metal gusset plate fails, the entire arch will fail. This roofing design tends to kick out at the base and collapse violently into the structure upon failure. They typically fail suddenly and without warning. Firefighters should operate independently from an aerial or tower bucket. The choice of ventilation tool will vary upon the roof deck material. Wood planking and metal are common decking materials.

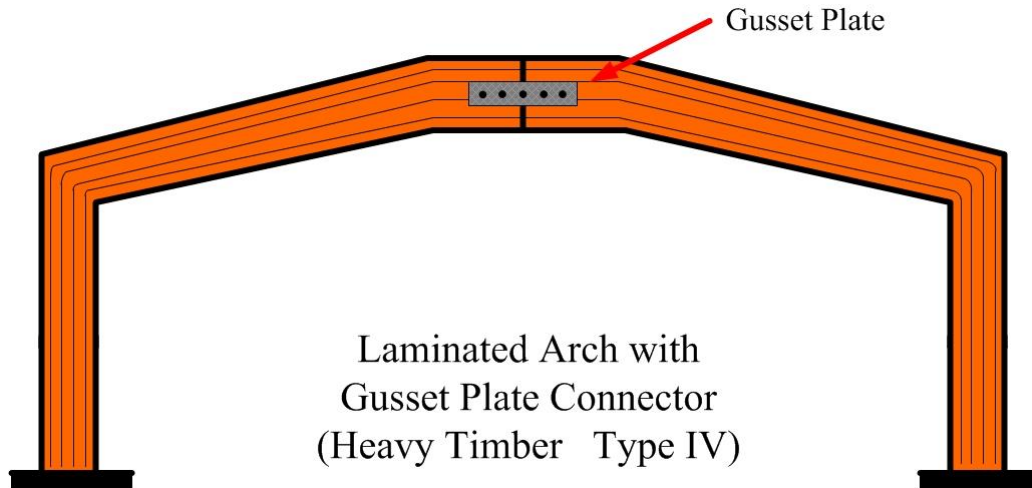

Figure 41: An example of a laminated arch with a gusset plate connector.

Metal Roof Deck

The metal roof deck roofing system's ability to resist the effects of fire depends on the supporting system, Figure 42. These types of roofs are typically supported by metal bar joist. Unprotected metal bar joist are subject to rapid failure under fire conditions. Although subject to rather rapid deterioration, this roofing system typically provides warning signs of pending failure. However, should you have a failure of the steel support girder system that supports the metal deck there may be no warning at all, dropping the entire roof system at once. Hot bubbling melting tar, white smoke issuing from the deck, and a soft feeling under foot are all signs of pending failure. The collapse pattern will depend on the supporting system's failure. If multiple supporting metal trusses fail simultaneously, the entire roof system may violently collapse into the building. Firefighters should not work directly over the fire on the hot slippery tar. Rotary disk saws are the tools of choice for rapid ventilation.

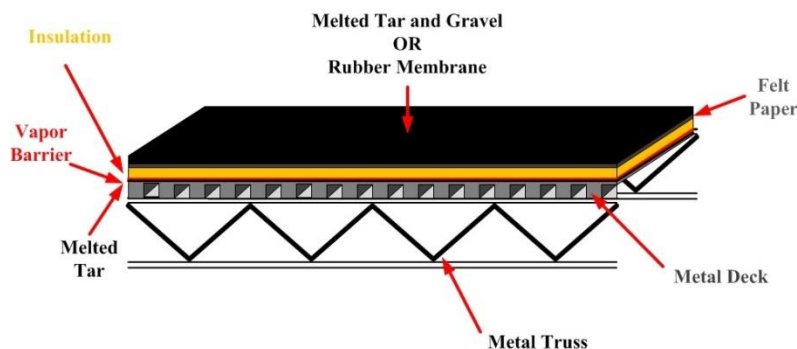

Figure 42: A detailed view of the components of a metal deck roof.

This type of roofing system was initially designed to resist the effects of fire and was used exclusively in non-combustible buildings. Following several large fires in buildings with this roofing system, engineers discovered that the roofing system actually contributed to the fire spread. As heat is applied to the underside of the metal deck, the asphalt becomes hot and emits

combustible vapors. The vapors are pushed downward through the metal deck seams and contribute to the extension of the fire.

Poured-in-place Concrete Roof

The poured-in-place concrete roof's ability to resist the effects of fire depends on the supporting system, Figure 43. These type roofs are typically supported by metal bar joist. Unprotected metal bar joists are subject to rapid failure under fire conditions. Unlike the metal roof deck, a flat concrete roof may give little, if any, warning of pending failure. If multiple supporting metal trusses fail simultaneously, the entire roof system may violently collapse into the building.

Concrete has satisfactory compression strength but minimal tensile strength. A steel cable runs in hollow tubes and is pulled tight as the concrete is drying; this is known as post tensioning and is performed to provide tensile strength. Metal anchors hold tension on the cable. As concrete is heated, the moisture content may expand and cause spalling. Spalling refers to sections of concrete breaking and popping off. Spalling may expose the metal tensioning cables. If the heat causes the metal tensioning cable(s) to fail, that portion of the concrete roof will fail. If multiple cables fail, expect a large collapse. These roofs tend to collapse violently into the building, often collapsing other walls as they fail. The rotary disk saw is the tool of choice for rapid ventilation. DO NOT cut the cables. Personnel should be aware that the cables might be encased in PVC or other materials. If the presence of PVC bits is noticed discharging from the saw this is good indication that you may have begun to cut into a cable and the cutting operation should stop until an inspection can be made. A sledgehammer may be used to knock the concrete off the cables. Many rescue companies carry concrete cutting wet saws.

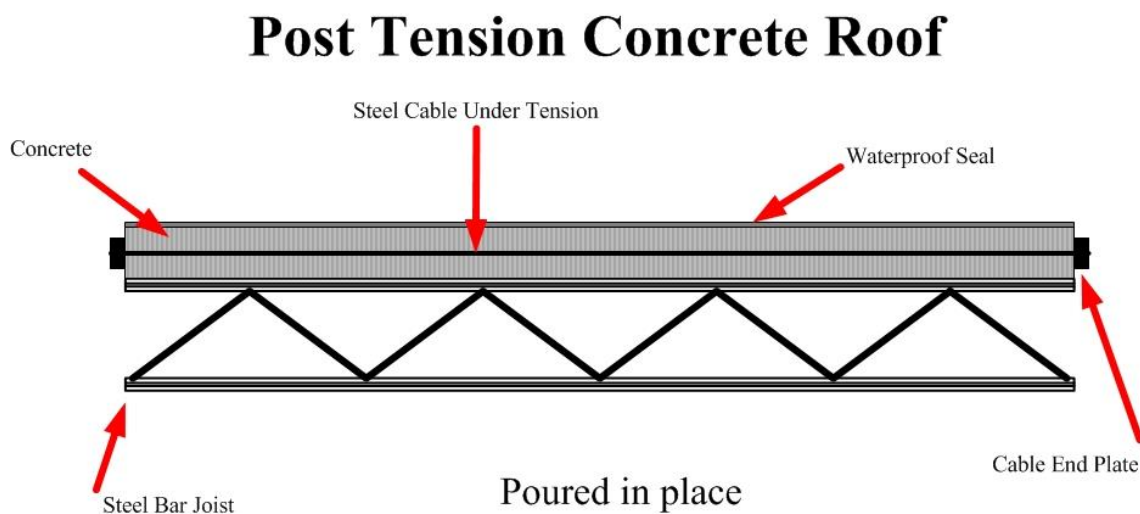

Figure 43: Early recognition of a concrete roof is essential and an assessment of the cables will provide information on potential collapse.

Lightweight Pre-cast Concrete Roof

A lightweight pre-cast concrete roof's ability to resist the effects of fire is limited when compared to solid concrete, Figure 44. The pre-cast panels are typically poured off site. Concrete is poured over pre-tensioned cables. After the concrete is dry, the concrete panels are cut to the

desired size and shipped to the construction site. There are no anchors, as found in post-tensioned concrete. The concrete itself holds the cable in place. As concrete is heated, the moisture content may expand and cause spalling. These roofs tend to collapse violently into the building, often collapsing other walls as they fail.

Lightweight concrete is also aerated. Air is injected into the concrete and many lightweight concrete slabs have hollow holes through the concrete. Both of these engineering techniques are used to make the concrete lighter. As with most materials, less mass equals less resistance to fire. If the heat causes the metal tensioning cable(s) to fail, that portion of the concrete roof will fail. If multiple cables fail, expect a large collapse. DO NOT cut the cables.

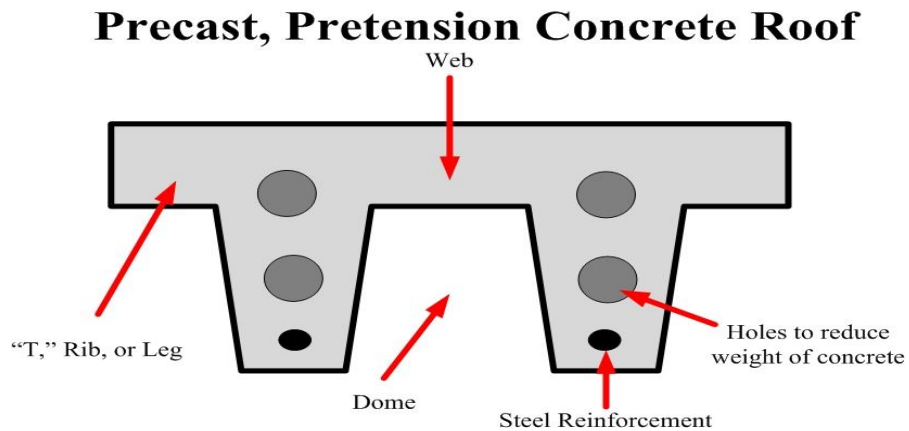

Figure 44: In the precast concrete roof, the concrete holds the cables in place and can fail if the fire causes spalling.

Flat Concrete Roof/Pre-cast or Poured-in-place with Concrete Columns

Of all the concrete roofing systems, this one has the greatest resistance to fire, not because of the specific roof, but because of the large concrete columns that support it, Figure 45. Although collapse is never eliminated under fire conditions, a total catastrophic collapse would be unlikely.

Flat Slab Concrete Roof

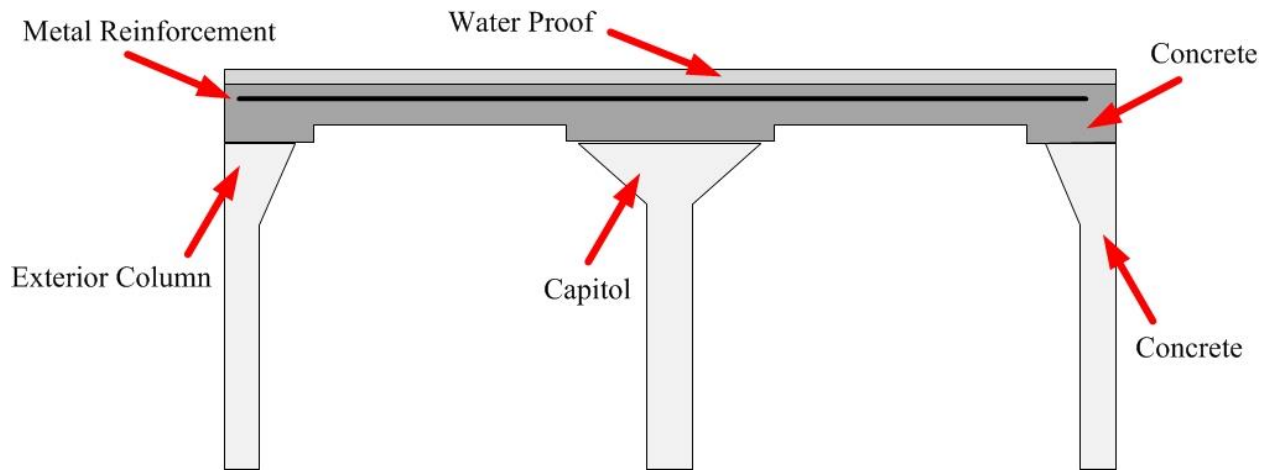

Figure 45: The flat concrete roof benefits from the support of the concrete columns.

Pre-cast Lightweight Concrete Roof/Tilt-up Construction

This roof is subjected to limited failure under fire conditions but it can create a total building collapse potential if exposed for an extended period of time. In tilt-up construction, the roofing system is connected to the tilt-up walls with metal plates. The walls and roof work to support each other in place, Figure 46. As the metal connector absorbs heat and fails, the entire roof and connected walls may fail catastrophically, Figure 47. Tilt-up constructed roofs generally have lightweight precast roof panels which have their own hazards.

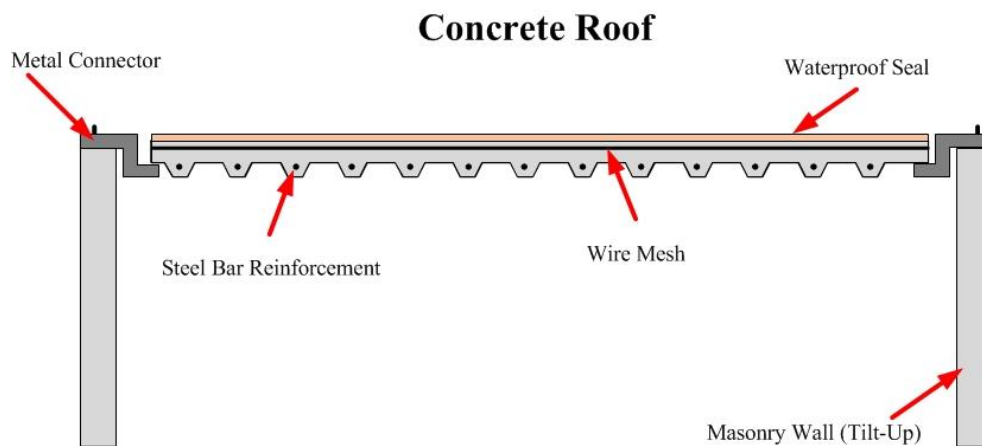

Figure 46: In tilt-up construction the roof is supported by the tilt-up walls.

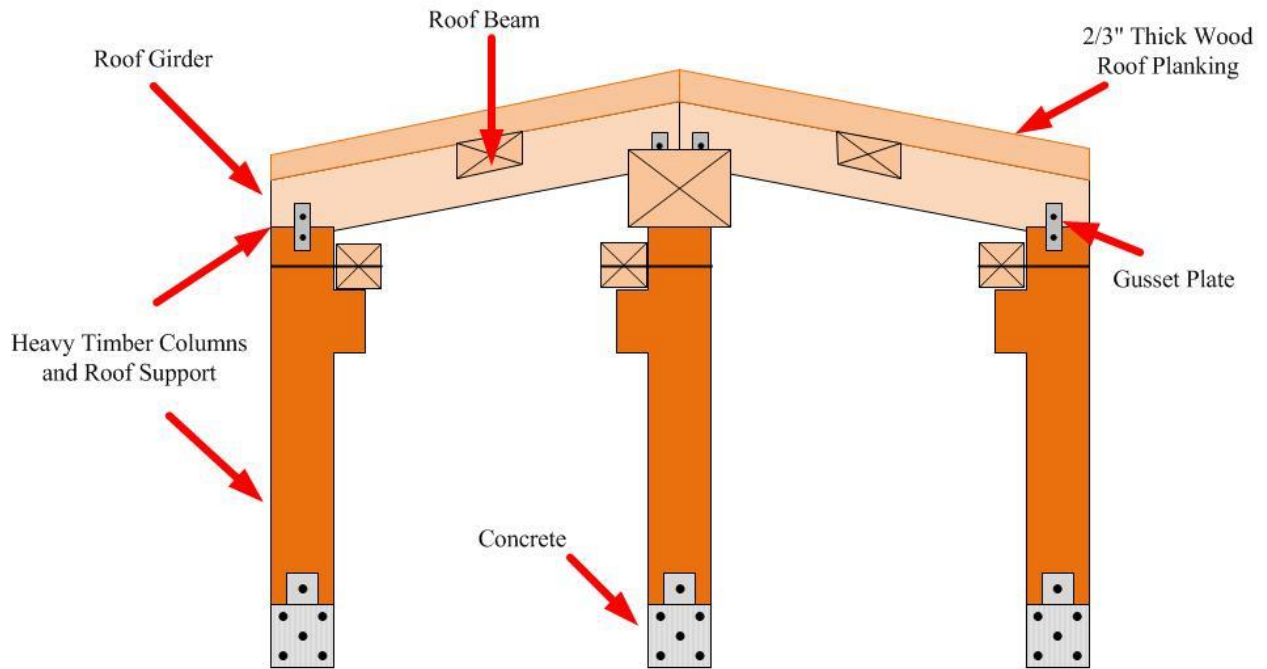

Figure 47: Note the metal connector connecting the roof and exterior, tilt up wall.

Heavy Timber Roof

A heavy timber roof and its supporting system are moderately resistant to failure under fire conditions, Figure 48. The roofing material is generally 2” to 3” thick wooden planks with a weatherproof seal. The supporting wood timbers are, at their minimum dimension, 8” and may withstand several hours of fire exposure. If the structure is true mill construction, it will be deliberately constructed with very few void spaces and fire streams may be more effective in reaching the fire. The main concern with this type of roof construction lies in the connections used to tie the roof system to the rest of the structure. Some of these connections were chosen to allow the roof to burn away without affecting the supporting walls (cast-iron beam boxes were built into the walls to support the beams without compromising the walls). The tool of choice for ventilation will depend upon the roof deck material. These buildings were constructed during the mid-1800s to 1900s and are rare in the Northern Virginia area. Typically, they are concentrated in the *Old Town* districts of each jurisdiction. Being over 100 years old, most have been extensively remodeled multiple times for various occupancy types. Remodeling often creates unexpected void spaces.

Heavy Timber (Type IV)



Very few void spaces Resistant to early collapse

Figure 48: Heavy timber will provide large surface areas that are moderately resistant to fire travel but will collapse catastrophically if under fire for an extended period of time.

ROOF STYLES

Gable Roof

The gable roof is typically an A-frame type that consists of a ridgepole and rafters that extend down to a beam that rests on the outside walls in ordinary or conventional construction, Figure 49.

Rafters or trusses will run perpendicular to the roofline. The ridgepole and rafters are usually 2"x6" dimensional lumber or larger.



Figure 49: Gable roof.

Rafters are typically 16 to 24 inches on center and attached to the ceiling joists where they meet at the exterior walls. The spacing of trusses will also be 16 to 24 inches on center. The decking can be 1"x4" or 1"x6" boards or 4'x8' plywood sheathing of 3/4-inch thickness or less. Plywood and chipboard decking will delaminate, fail, and burn at a faster rate than the 1-inch boards used in the past.

In lightweight construction using an A-frame truss, there will not be a continuous ridgepole. A small section of 2" x 4"s may be nailed between each truss as a spacer. A ridgepole is not used in lightweight construction using plywood I-beams or parallel chord trusses as roof rafters.

In truss construction, it is common for a 2-3 inch gap covered with aluminum or vinyl manufactured vent to be present at the ridgeline. This is referred to as a ridge vent. If there is no vent, then this gap will simply be closed with roofing material.

Cape Cod

When British colonists came to the New World they brought with them the Cape Cod-style home, which was meant to be practical with steep pitched roofs to slough off the snow, low ceilings, and a central chimney to keep the home warm during the winter. The Cape Cod style home has weathered the ages, but has been improved upon to accommodate the larger family, thus creating larger floor plans with living quarters upstairs, the chimney has been moved to the side from center, and dormers have been added to create more space in the upstairs, Figure 50. The Cape Cod-style gable roofs with dormer windows and knee walls create inherent voids that, if left unchecked, will aide in fire spread and extension.

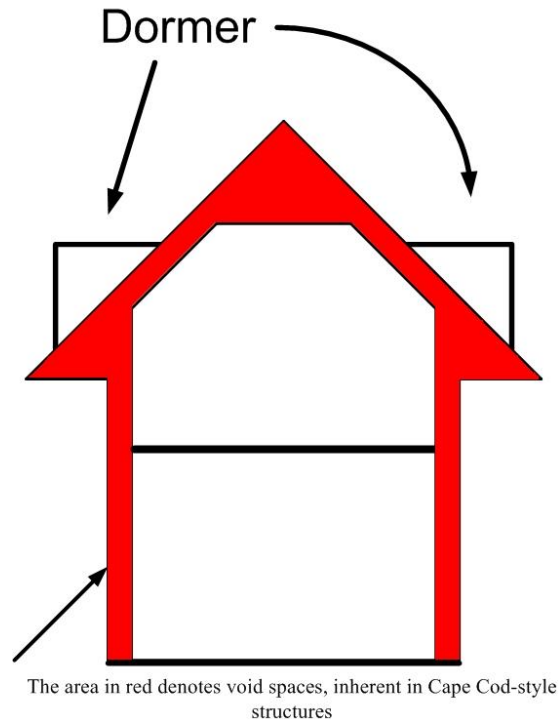

Figure 50: The presence of a dormer is prevalent in the Cape Cod-style homes.

Many Cape Cod-style homes have had additional living or storage space added over the years, Figure 51. The added section of structure's roof construction will typically depend upon when the addition was constructed. With many Cape Cods being situated on narrow deep lots, the addition may run directly off the rear of the dwelling. This area is easily overlooked without a proper size up.



Figure 51: Cape Cod structure with an addition on the rear

Barn Roof

Similar to the Cape Cod-style roof, the barn roof, also known as a gambrel, contains voids that must be opened early into the incident to check for fire extension, Figure 52.

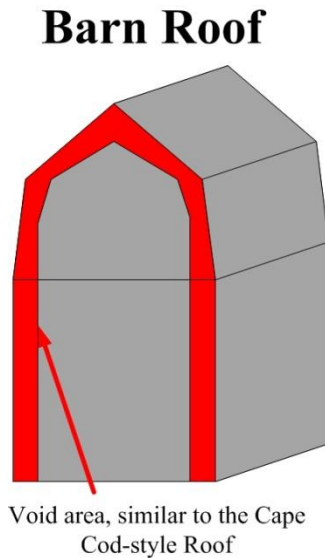

Figure 52: The barn roof, or gambrel, can present similar void spaces to a Cape Cod.

Hip Roof

A hip roof is constructed similar to the gable roof, with the exception that all exterior walls are load bearing, Figure 53. Conventional or ordinary construction will consist of a ridgepole and hip rafters will extend from the ridgepole to the outside walls. Valley rafters are used where the two rooflines meet. Jack (or short rafters) and common rafters (extends from the plate of the roof to the ridge board at right angles to both members, and to which roofing is attached) complete the structural members. Decking in conventional or lightweight construction will be the same as for the gable roof.



Figure 53: Hip roof.

Cross Gable roof

A cross gable roof (indicated in red) is an architectural projection, similar to a dormer, giving aesthetics to the structure, but also an increased dead load on the roof, Figure 54. Under fire conditions, cross gable roof sections are known to collapse.

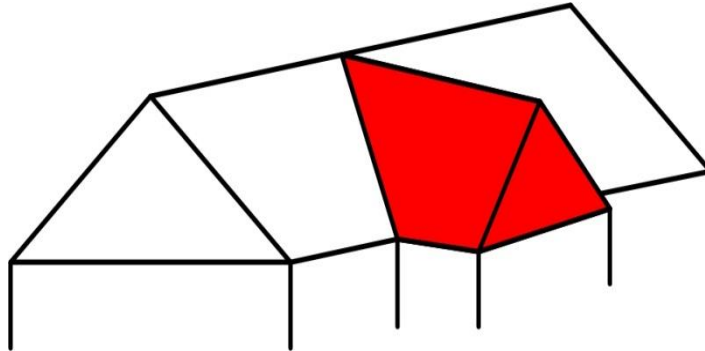

Figure 54: Cross gable roof section.

Cross gable roofs are far more dangerous for firefighters for several reasons. They use lightweight/low mass lumber in a truss configuration, which is held together with truss plates. More importantly, when the larger supporting roof burns away, it is common to see the cross gable section actually collapse into the top floor. Firefighters should not work directly under heavily-involved cross gable attic fires, Figure 55.



Figure 55: Firefighters should be aware of fire conditions above them in cross gable roofs.

Bridge Truss Roof

Bridge truss roofs are primarily used on commercial and warehouse buildings, Figure 56. Older roofs are usually constructed with heavy grade construction materials. Wooden top and bottom chords are constructed of 2"x12" lumber.

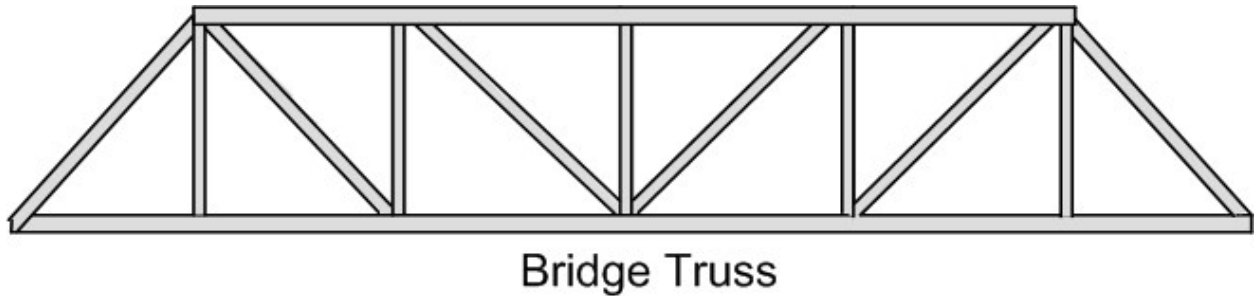

Figure 56: An example of a bridge truss roof.

Metal tie rods are used for vertical support and the compression members are 1”x6” or larger. A bridge truss roof built in recent years may also contain lightweight materials. The underside of the roof is normally exposed in warehouse settings.

Like any truss, these can fail as a complete unit. However, due to larger dimensional lumber, collapse should not be as early as one would encounter in lightweight construction. Collapse should be expected if fire has entered the truss space.

Trussed Arch Roof

The Trussed Arch Roof is seen in many small and large commercial buildings built in the 1930s, 1940s, and 1950s, Figure 57 and Figure 58. The trussed arch is constructed of 2”x12” or 2”x14” lumber. The underside of the roof may be exposed, depending on the occupancy, lending itself to immediate exposure to fire, Figure 59. It is paramount that the location and extent of the fire is identified as soon as possible. The collapse potential is great and crews should not be placed on top of or below this roof when fire has directly exposed or taken possession of the roof assembly.

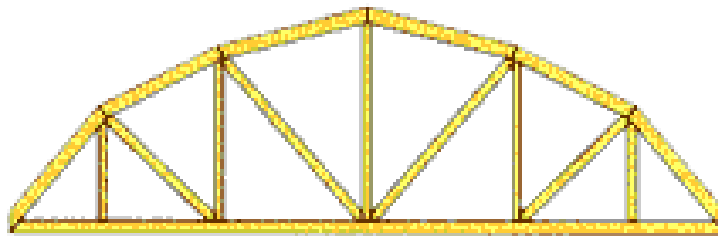

Figure 57: An example of a trussed arch roof.



Figure 58: An example of a metal trussed arch roof.

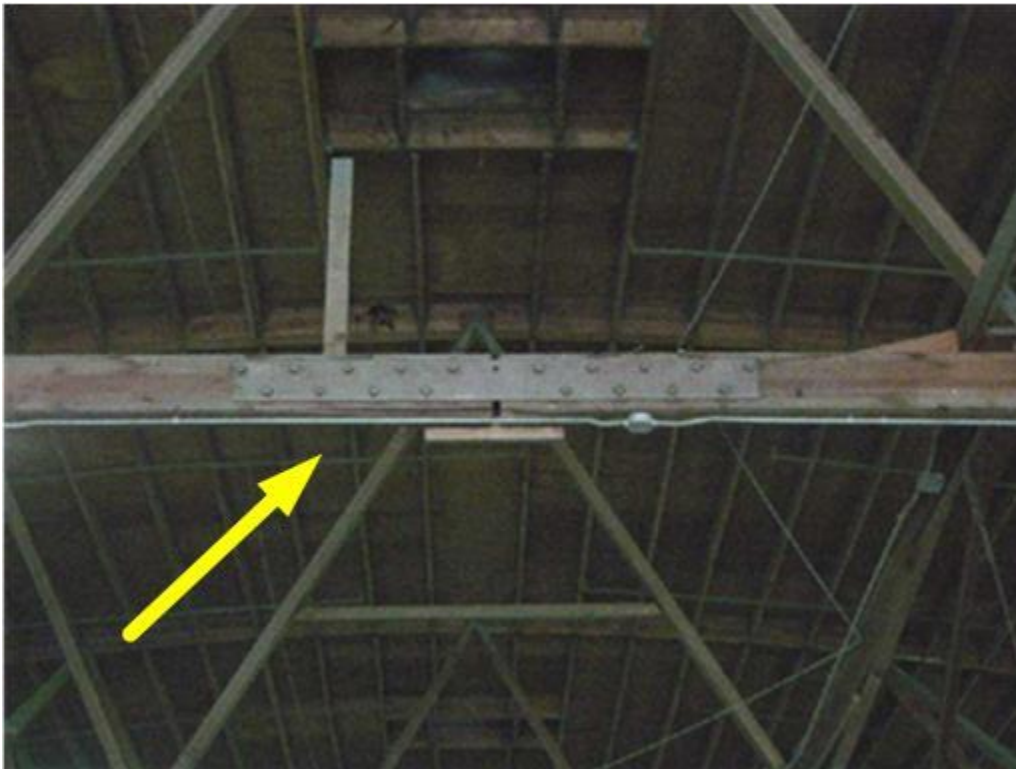

Figure 59: The gusset plate on the bottom chord of the truss is very susceptible to failure. Any insult to the plate could cause the entire collapse of the roof.

Bowstring Truss Roof

This roof is significantly different from the trussed arch because the bowstring truss uses metal tie rods and turnbuckles to provide lateral support for the walls of the building, Figure 60. Tie

rods are used below each arched member to ensure the arch roof does not push the exterior walls outward. The presence of the steel cable and turnbuckle can be clues to firefighters that a structure has a bowstring truss roof.

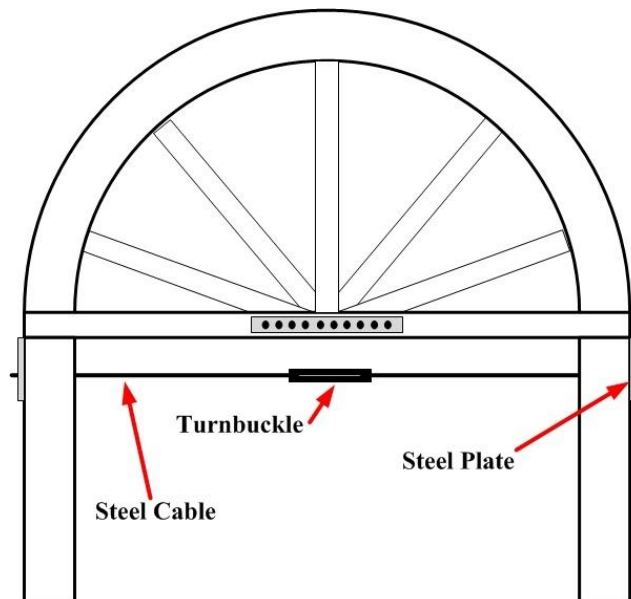

Figure 60: The presence of a steel cable and turnbuckle can be good indicators of a bowstring truss roof.



Figure 61: Ceiling tiles can hide what would normally be an easy visual clue of a bowstring truss roof. Prior knowledge of these buildings is essential when firefighting fire.

Tie rods may pass through exterior walls to outside plates. These may serve as a means of identifying this type roof. Top chords of the arch may utilize laminated 2" x 12" or larger, and 2" x 10" rafters that are covered by 1" X 6" sheathing and composition. A steel cable and turnbuckle, often hidden from plain view by a drop ceiling, support the bottom chord of any bowstring truss roof, Figure 61.

The primary hazard associated with this style of roof is the early failure of the tie rods and turnbuckles as a result of exposure to the fire conditions, Figure 62. There have been cases of large-scale collapses in structures with this type roof.

The bowstring truss roof is very dangerous under fire conditions. The steel cable is typically exposed to high heat levels. The steel cable holds the walls in place, which support the roof. When the cables fail, the walls and roof will collapse violently. The walls typically fall outward and the roof pancake collapses to the floor. Many firefighters have lost their lives working in this type building.



Figure 62: Firefighters should maintain situational awareness and report if they observe a cable and/or plate on the exterior wall. This can be an indicator of bowstring truss or a repaired roof structure.

***Note:** It will be difficult to distinguish between a trussed arch and a bowstring truss arch at the time of a fire. Tactics should reflect the possibility of a collapse causing the exterior walls to fall outward. Members who are assigned to roof top operations shall be supported independently of the roof.*

Sawtooth Roof

Sawtooth roofs are used in manufacturing type commercial buildings, Figure 63. They provide natural light to the areas below due to the presence of glass in the walls. These are typically well constructed, using conventional construction techniques. Rafters with 2"x8" or larger components and wood or metal bracing are common. The sloping portion is covered with 1"x6" sheathing or ½-inch plywood. The undersides of these roofs are typically exposed to the interior.

Ventilating this structure is not difficult due to the large glass facades on the majority of the structure.

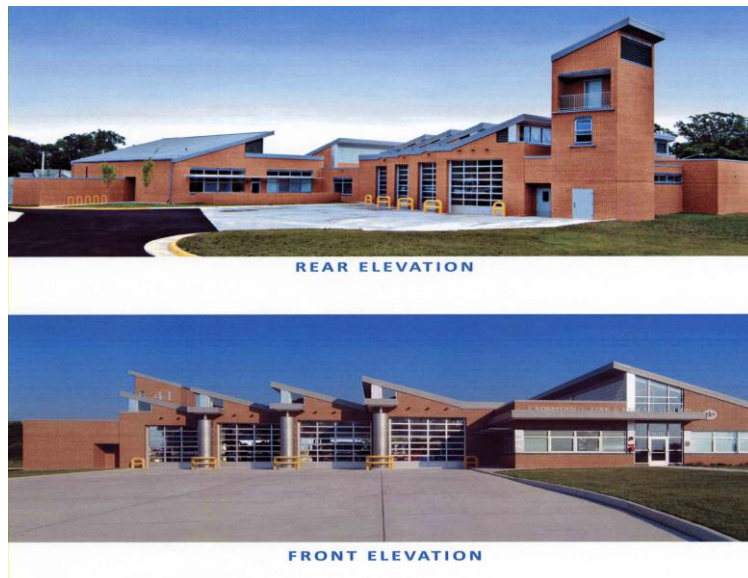

Figure 63: The sawtooth roof is easy to recognize and can vented easily, if needed.

Flat Roofs

Conventional wood flat roofs contain rafters starting at 2”x6” and larger which are laid across the outside and inside bearing walls. Rafters are covered with either 1”x6” sheathing or plywood and a composite roofing material.

Roofs covered with plywood rather than 1”x6” sheathing pose a significant problem to firefighters. Decking ranges in thickness from $\frac{3}{8}$ -inch to $\frac{1}{2}$ -inch and offer minimal structural integrity when exposed to fire conditions.

The plywood deck may be burned out from underneath without showing signs of weakness from on top. Truck crews must check the roof for stability before stepping onto the roof.

Flat roofs are also constructed of lightweight materials using wooden I beams and open web trusses. Vulnerability to fire conditions is dependent on the size of the rafters, the spacing of the structural members, and the type of decking used.

The hazards of flat roofs of lightweight construction are numerous. The components offer minimal resistance to fire. The use of 2”x4” trusses with metal truss connectors equals short burn time, early failure, and ultimately the collapse of the roof.

Open web bar joist construction uses metal in a wide variety of buildings, Figure 64. Top and bottom chords are constructed of $\frac{1}{8}$ -inch steel and the web supports are solid $\frac{5}{8}$ -inch steel bars. These are incredibly strong and can span great distances.



Figure 64: Open web bar joists.

Corrugated metal covered by alternating layers of tar and tarpaper is a common decking for flat roofs of steel bar joist construction. These layers may include an insulating material of composition board or another form of insulation. There may be some instances of wood joists of 2"x4" and plywood decking with a composite covering placed over the bar joist or wooden beams.

There are instances where wood spacers are used with wooden joists. The spacers may vary in dimension but will typically be 2" x 4". When this is done, the spacers run perpendicular to the joists to provide airflow on the underside of the roof deck. This will also allow fire to spread in all directions.

Another type of roofing material that truck crews may encounter is corrugated metal decking with a lightweight concrete top layer. This consists of an air-entrained mix of sand, cement, and often pea gravel to a thickness of three to six inches. A composite roofing material is added for moisture protection. This concrete roof material provides extra insulating properties to the structure.

Roof loading must be taken into consideration when crews are working above and below. Heavy loading may be from HVAC systems or heavy snow loads.

Inverted Roof

The insulation for an inverted roof is above the waterproofing membrane, which is the opposite in flat roofs. This keeps the ultra violet sunray and ozone damage to a minimum. Usually, the insulation is held in place by a layer of rocks. These roofs are inherently spongy giving firefighters a false reading of conditions below. This type of roof construction is found on flat roofs or roofs with a slight pitch.

The roof surface is inherently spongier due to lightweight construction, and the fact that the roof surface is not attached directly to the larger roof joists. Cutting the inverted roof is essentially the same as the flat roof. Before cutting an inverted roof, the rock layer must be removed to expose the insulation and roof membrane.

Rain Roof

The rain roof is becoming more common as buildings age and experience chronic problems with leaking water, Figure 65. The rain roof is essentially a second roof, either flat or gabled, of lightweight construction built over the original roof of the building. The presence of this addition is problematic for several reasons. It creates an added dead load for which the building was not originally designed to sustain and undermines the ability to access the original roof surface and effectively perform vertical ventilation. District familiarization activities will help in identifying these structures prior to a working fire.

Alternatives for ventilating the roofs in these structures include breaching the gable vent to attack fire within the rain roof's void space as well as attacking fire through the cockloft vents. In most instances where there has been a rain roof added, vertical ventilation will not be a viable tactic, unless the fire is located under the rain roof and above the original flat roof.



Figure 65: Rain roof.

ROOF HAZARDS

In roof systems where there are connectors through the column present, as seen in Figure 66, the failure of this connector could lead to collapse of the column and roof assembly supported by the column.



Figure 66: Column connector.

Façade Hazards

A façade is an architectural projection that provides weather protection, occupancy identity, decoration, and is supported by the building to which it is attached, Figure 67. A façade is used to conceal equipment and machinery on flat roofs. They enhance the exterior of a square building, especially those with a flat roof.



Figure 67: Example of a facade.

Façades can be used on any kind of building, new or old, commercial or residential. Many of the older strip shopping centers, commercial buildings, and malls have been renovated in recent years with large façades to identify the structure and attract new customers, Figure 68. Façades pose a danger to fire department operations due to the large void space inside. If unchecked, fire can burn inside this space unnoticed, leading to collapse of the façade, injuries to firefighters underneath, the rendering of hoselines underneath ineffective, and blocked egress paths.



Figure 68: Addition of a Façade to an existing structure.

Many times, the façade is open or common to the attic/cockloft area of the entire building and not separated at each address. Crews must anticipate fire extension into this area. These façades are a means for fire to extend to the attic or cockloft where fire has vented from a storefront or out a window and is exposing the underside of the façade.

Façades normally hide or conceal the roofline. If the roofline cannot be visualized while laddering a façade, the height above the roof must be determined. The best means of accessing the roof in most cases will be via the rear of the structure due to the typical absence of façades. Where a façade surrounds the entire roof, members must provide ladders from the roof level to the top of the façade. First-due companies should preplan this in advance so that the need for multiple ladders to access the roof is identified early.

The distance from the top of the façade to the roof deck will vary greatly. Going to the roof for the first time in smoke and darkness is no time to discover that a 10-foot drop from the parapet or façade to the roof level exists. When sizing up a façade, look for scuppers from the street to determine the height of the façade. Scuppers are located at or slightly below the roofline of the building.

GREEN BUILDINGS

Green Building, also known as Green Construction or Sustainable Building, is the practice of creating structures and using processes that are environmentally responsible and resource-efficient throughout a building's life-cycle: design, construction, operation, and maintenance.

Access

Road surfaces may NOT be able to support the weight of aerial apparatus. Truck companies must identify on street maps and pre-plans the different types of road surfaces in and around green buildings.

Vegetation

Personnel must complete pre-plans and inspections due to plant growth. Plant growth around the structure may interfere with access to fire department connections and the placement of portable ladders to the exterior of the building.

Roof Systems

There are three types of roof systems: Extensive, Intensive, and Simple Intensive.

1. Extensive Roof Systems have a growth soil of less than six inches. Vegetation consists of low-growing plants such as grasses and moss. Minimal care and maintenance is needed with this system. This is the most common type of green roofing system.
2. Intensive Roof Systems have eight inches or more of a growth soil. Regular care and maintenance is needed on this roofing system.
3. Simple Intensive Roof Systems are a combination of both systems. Builders may take different aspects from both systems to make a hybrid system.

The two major concerns with green roofs are the added dead weight present on the roof and the impact the design will have on vertical ventilation, if it is needed. Due to the increased load from the several inches of soil on the roof, personnel should quickly recognize the presence of the load and communicate it to the IC. If vertical ventilation is determined to be necessary, personnel will have to remove up to 12 inches of soil just to reach roofing materials to begin ventilation. These features may negate performing vertical ventilation and operating underneath the green roof if the fire is attacking the structure components.

Roof Materials

There are many types of roofing components for this kind of building. Knowledge of the roofing material is attained through pre-planning and building inspections. To avoid loss of growth, a parapet may run along the perimeter of the building. This parapet is constructed to prevent the loss of soil, and or the safety of anyone or anything below. Foam façades may be mistaken for stone or other solid material and the truck company should be aware that this foam material is not constructed to support the weight of apparatus or equipment.

Windows

Due to the energy efficient nature of these structures, window systems in green buildings may be extremely difficult to break for ventilation or egress purposes. Additionally, these windows will also take much longer to fail in fire conditions which can mask fire conditions inside and provide ventilation limited fire conditions.

Power

Solar panels are becoming more popular in the residential setting due to the decrease in cost of the panel systems and the demand to save money and be more energy efficient, Figure 69. There are several hazards associated with these systems that all personnel should be made aware of. If possible those structures in your first-due area should be preplanned accordingly and made aware to other responding companies.



Figure 69: Typical Solar arrays for residential application.

While the intricacies surrounding the science and application of solar power are varied there is information that we should be cognizant of and guidelines to follow to ensure safer operations on the fireground when solar panels are encountered. For the purpose of fire operations solar power can be broken down into two categories, each with their own set of challenges and concerns:

- Thermal systems – systems used to convert sunlight to heat.
- Photovoltaic systems (PV) – systems used to convert sunlight to electricity.

Thermal Systems

Relatively speaking thermal systems will present less danger to fire operations because they aren't creating electricity, but generating heat using water or other fluids to transport the solar energy to be used. Thermal systems are considered passive in that gravity is used to circulate the water or active when a series of pumps will be used to circulate the water or fluid. Active systems will be found to heat swimming pools as the pumps are already in place. Thermal systems may present structural dead load concerns if they include a roof-mounted fluid storage unit and caution should be exercised as the fluid running through these systems will be full of scalding fluid.

Photovoltaic Systems (PV)

Caution must be exercised when encountering a photovoltaic (PV) system as it is generating electricity as long as the sun is shining and potentially at night as a result of our emergency lighting on apparatus. The primary concern with PV systems is the electrical components and associated circuitry that pose an electrical shock hazard. The basic components of a photovoltaic system include the photovoltaic unit that captures the sun's energy, an inverter that converts the electrical power from DC to AC, electrical conduit and other electrical system components, and, in some cases, a storage battery. The storage battery will be used to store excess energy to be used after daylight hours and will not only pose an electrical shock hazard, but, if on fire, may leak, thereby causing a potential hazmat emergency and definitely an inhalation hazard. Some systems will be equipped with a roof-top disconnect as a means to perform routine maintenance, but should never be considered by fire department personnel as a means to shut down the system as the inverter and conduit will continue to be energized. Tactics to be used for PV systems should coincide with those for any energized electrical equipment, in that securing the power should be the first tactic employed followed by extinguishment with the appropriate medium for the system and its components.

Hazards in Green Power Systems

The hazards that may be posed by these two power systems include the following:

Thermal solar panel systems

Trip/slip hazards
Structural collapse due to added roof weight
Contribute to flame spread
Inhalation exposure due to material
Hot fluid scalding

Photovoltaic solar panel systems

Trip/slip hazards
Structural collapse due to added roof weight
Contribute to flame spread
Inhalation exposure due to material
Electrical shock
Battery hazards

It is important to note that standard building and electrical codes, as well as standard fire tests, haven't fully explored the relatively new trend in solar panels, which makes it even more important that our first-due areas are pre-planned accordingly so, at a minimum, we note structures that are using solar power. Although limited due to the relatively new technology used for solar power, the statistical data indicates that the solar power industry has a good record when it comes to their equipment and components contributing to the source of ignition. However, we must remain diligent in our tasks on the fireground and under no circumstance should solar panels be damaged or compromised when performing ventilation and always consider these systems energized.

Water

Truck company personnel need to be aware of underground cistern, and or rain water caverns, often present around these structures. This could create a collapse hazard for apparatus parking or while driving over these areas.