

BMW

HIGHLIGHTS



BMW

Turbo charger



Engine:
M47, N47
Type:
E46, 60, 61, 83, 87, 90, 91

Turbo charger



Engine:
M57
Type:
E38, 39, 46

Repair set, crankcase breather



Engine:
M52, 54
Type:
E36, 38, 39, 46, 53, 60, 61,
65 - 67, 83, 85

Repair set, crankcase breather



Engine:
N42, 43, 46
Type:
E46, 83, 85, 87, 90, 91

Repair set, crankcase breather



Engine:
N54, 62, 63, 73, 74; S63
Type:
E53, 60, 61, 63 - 67,
70 - 72; F01 - 04, 06, 07,
10 - 13, 15, 18, 85

Water pump



Engine:
N52
Type:
E60, 61, 64 - 67, 81,
83 - 85, 89, 70, 87, 90 - 93
F10, 18

Control valve, coolant



Engine:
M47, 54, 57, 67
N43, 46, 47, 52 - 54, 62, 73
Type:
E53, 60, 61, 63 - 67

Thermostat, oil cooling



Engine:
M43, 52, 54
N42, 46, 52
Type:
E46, 53, 83, 85, 86

All stated genuine numbers serve only for comparison purpose and may not be used as original reference.



BMW

HIGHLIGHTS



BMW

Master cylinder, clutch

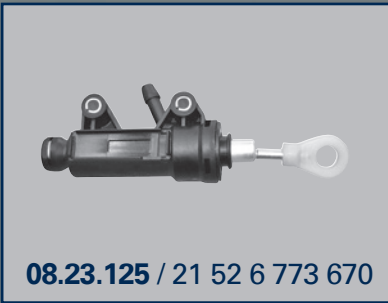

Type:
E39, 46, 52, 53, 81 – 85,
87 – 93; F20, 21, 30 – 33,
35, 36, 80, 82, 83

Plug housing, automatic transmission control unit



Type:
E60, 61, 63 – 67, 70 – 72,
81 – 86, 88 – 93; F01 – 04
Gearbox:
6HP19, 6HP26

Oil seal, automatic transmission



Type:
E60, 61, 63 – 67, 70 – 72,
81 – 86, 88 – 93; F01 – 04
Gearbox:
6HP19, 6HP21

Oil seal, automatic transmission



Type:
E60, 61, 63 – 67, 70 – 72,
83, 90 – 93; F01 – 04
Gearbox:
6HP26, 6HP28, 6HP32

Tensioner, timing chain



Engine:
B47, M47, N47, 57
Type:
E60, 61, 70 – 72, 81 – 84,
87, 88, 90 – 93
F01 – 04, 06, 07, 10 – 13,
15, 16, 18, 20 – 22, 25, 26,
30 – 36, 45, 55, 56, 80, 82,
83, 85 – 87
R55 – 61

Sender unit, interior temperature



Type:
E46, 65 – 67, 81, 82, 84, 87,
88, 90 – 93

Mounting, propshaft



Type:
E63, 64, 81, 82, 84, 87, 88,
90 – 93; F30, 35, 80

Mounting, propshaft



Type:
E81, 82, 87, 88, 90 – 93
F30, 35, 80

All stated genuine numbers serve only for comparison purpose and may not be used as original reference.



ENGINE BLOCK BREATHER

CRANKCASE BREATHER



BMW

Valve, engine block breather



08.10.072
11 61 7 501 566

Type:
3er (E46), 5er (E39 / E60 / E61), 7er (E38 / E65 / E66), X3 (E83), X5 (E53), Z3, Z4 (E85)

Valve, engine block breather



08.10.134
11 61 7 503 520

Type:
1er (E87), 3er (E46 / E90 / E91), X3 (E83), Z4 (E85)

Valve, engine block breather



08.10.135
11 15 1 703 484

Type:
3er (E36), 5er (E39), 7er (E38), Z3

Valve, engine block breather

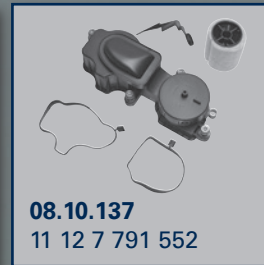

08.10.137
11 12 7 791 552

Type:
3er (E46), 5er (E39)

Valve, engine block breather

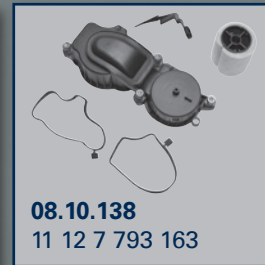

08.10.138
11 12 7 793 163

Type:
3er (E46), 5er (E39), 7er (E38), X5 (E53)

Valve, engine block breather

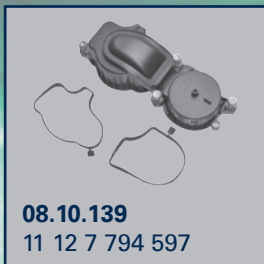

08.10.139
11 12 7 794 597

Type:
3er (E90/E90 - 93), 5er (E60 / E61), 7er (E65/E66), X3 (E83), X5 (E70), X6 (E71)

Valve, engine block breather



08.10.140
11 12 7 799 224

Type:
1er (E87), 3er (E46 / E90 / E91), 5er (E60 / E61), X3 (E83)

Valve, engine block breather

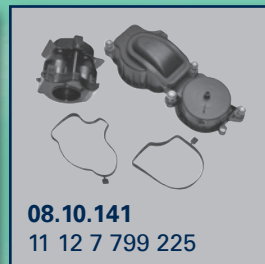

08.10.141
11 12 7 799 225

Type:
3er (E46), 5er (E60/E61), 7er (E65), X3 (E83), X5 (E53)

Oil Trap, crankcase breather



08.10.142
11 12 7 799 367

Type:
1er (E81/E87), 3er (E46 / E90/E91), 5er (E60/E61), X3 (E83)

Oil Trap, crankcase breather

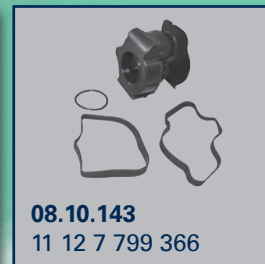

08.10.143
11 12 7 799 366

Type:
3er (E46), 5er (E60/E61), 7er (E65/E66), X3 (E83), X5 (E53)

Filter, crankcase breather

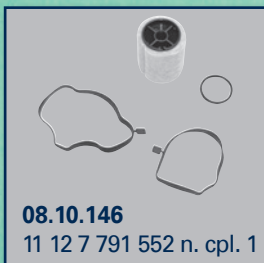

08.10.146
11 12 7 791 552 n. cpl. 1

Type:
3er (E46), 5er (E39)

Filter, crankcase breather



08.10.147
11 12 7 793 163 n. cpl. 1

Type:
3er (E46), 5er (E39), 7er (E38), X5 (E53)

Valve, engine block breather



08.10.149
11 12 7 547 058

Type:
5er (E60/E60N/E61/E61N), 6er (E63/E63N/E64/E64N), 7er (E65/E66/E67), X5 (E53/E70)

Valve, engine block breather, Cold climate version



08.10.152
11 61 7 533 400

Type:
3er (E46), 5er (E39/E60 / E61), 7er (E38/E65/E66), X3 (E83), X5 (E53), Z3, Z4 (E85)

Valve, engine block breather, Cold climate version



08.10.153
11 61 7 516 007

Type:
1er (E87), 3er (E46 / E90 / E91), X3 (E83), Z4 (E85)

All stated genuine numbers serve only for comparison purpose and may not be used as original reference.



ENGINE BLOCK BREATHER

CRANKCASE BREATHER



BMW

Housing, engine block breather – cold climate version



08.10.155
11 61 7 533 400 n.cpl.1

Type:
3er (E46), 5er (E39/E60/E61),
7er (E38/E65/E66), X3 (E83),
X5 (E53), Z3, Z4 (E85)

Housing, engine block breather – cold climate version



08.10.156
11 61 7 516 007 n.cpl.1

Engine:
1er (E87), 3er (E46/E90/
E91), X3 (E83), Z4 (E85)

Valve, engine block breather



08.10.133
11 15 7 501 567

Type:
3er (E36/46), 5er (34)

Valve, engine block breather



02.10.133
611 016 0334

Type:
OM611, OM612, OM613,
OM646, OM648

Valve, engine block breather



02.10.158
611 016 0134

Type:
OM611, OM612, OM646

Repair set, crankcase breather



08.10.182
11 15 1 703 484 cpl.1

Type:
3er (E36), 5er (E39), 7er
(E38), Z3271

Repair set, crankcase breather



08.10.180
11 61 7 501 566

Type:
3er (E46), 5er (E39/E60/
E61), 7er (E38/E65/E66),
X3 (E83), X5 (E53), Z3,
Z4 (E85)

Repair set, crankcase breather



08.10.183
11 15 7 501 567 cpl.1

Type:
3er (E36/46), 5er (34)

Valve engine, block breather



02.10.139
271 018 0329

Type:
M271

Oil Trap, block breather



02.10.159
646 010 1562

Type:
OM646

Repair set, crankcase breather



08.10.181
11 61 7 503 520 cpl.1

Type:
1er (E87), 3er (E46/E90/E91),
X3 (E83), Z4 (E85)

Oil Trap, crankcase breather



02.10.030
646 010 0762

Type:
OM611, OM646

Valve engine, block breather



02.10.169
646 010 1462

Type:
OM611, OM646

All stated genuine numbers serve only for comparison purpose and may not be used as original reference.



MERCEDES TRUCK

HIGHLIGHTS



Mercedes

Fitting, injection



Engine:
OM 457, 501, 502,
904, 906, 924

Wet Sump



Engine:
OM 501
Details:
included gasket

Repair Kit, constant throttle



Engine:
OM 442, 442, 457, 501, 502

Crankshaft, air compressor



Engine:
OM 401, 402, 421, 441,
441, 442, 442A, 442, 443,
447, 501, 502

Charger, charging system



Engine:
OM 501

Starter



Engine:
OM 501, 502
Details:
IE 85 straight, 6,2 KW

Alternator



Engine:
OM 457, 501, 502, 904,
906, 924
Details:
80 A

Clutch Booster



Type:
W 374, 375, 405, 437,
634, 930, 932-934, 940,
942 - 944, 958

All stated genuine numbers serve only for comparison purpose and may not be used as original reference.



MERCEDES TRUCK

HIGHLIGHTS



Mercedes

Clutch Kit



Type:
W 930, 932, 934, 940, 942,
943, 950, 952 – 954, 958

Gear Level Actuator



Type:
W 375, 930, 932 – 934,
943, 944, 954, 958, 970

Details:
Mineral oil

Solenoid Valve, shift cylinder



Type:
W 374, 375, 930, 932 – 934,
940, 942 – 944, 949, 950,
952 – 954, 957, 958, 970,
972, 974, 976

Details:
2 holes

Door Lock, driver cab



Type:
W 930, 932 – 934, 950,
952 – 954, 967

Brake Caliper



Engine:
W 374, 375, 382, 628, 930,
932 – 934, 940, 942 – 944,
950, 952 – 954, 957, 958,
963, 964

Expansion Tank, coolant



Type:
W 375, 958, 970, 972,
974 – 976

Electric Motor, interior blower

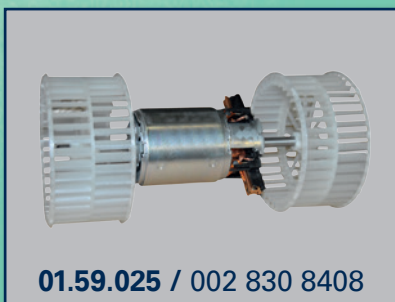

Type:
W 930, 932 – 934

Evaporator, air conditioning



Type:
W 930, 932 – 934
Details:
Pins 11,5 mm
and 17,5 mm

All stated genuine numbers serve only for comparison purpose and may not be used as original reference.



SCANIA

HIGHLIGHTS



SCANIA



04.18.009 | 133 31 83

**Oil cooler,
engine oil**

Engine:
D9A, D9B, D11A, D11B,
D11C, D16C, D16E, D16G



04.27.001 | 175 49 43

**Slave cylinder,
clutch**

Type:
Serie 4

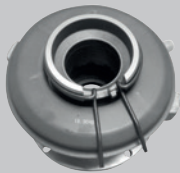

04.23.003 | 112 32 96

**Central slave cylinder,
clutch**

Type:
Serie 4



04.31.005 | 207 529 18

Wheel bearing kit

Type:
Serie 3 / 4,
P-, G-, R-, T-Serie



04.30.024 | 134 98 40 cpl.1

**Shock absorber,
cab suspension**

Type:
Serie 4,
P-, G-, R-, T-Serie



04.42.018 | 184 61 37

**Sender unit,
fuel tank**

Type:
Serie 4,
P-, G-, R-, T-Serie



04.58.001 | 144 22 92

**Electric motor,
window winder**

Type:
Serie 4



04.44.011 | 151 73 24

**Tilt cylinder,
driver cab**

Type:
Serie 4,
P-, G-, R-, T-Serie

All stated genuine numbers serve only for comparison purpose and may not be used as original reference.



SCANIA

HIGHLIGHTS



SCANIA



04.11.020 | 140 17 29

Connecting rod

Engine:
DC 9 / 11, DSC 12



04.14.005 | 142 10 22

Air filter

Engine:
DSC 9 / 11, DC 9 / 11/12,
DSC 11, DT 12



04.12.007 | 177 40 36

Rocker, tappet

Engine:
DC 11 / 12, DSC 12



04.38.006 | 194 86 65

**Water trap,
fuel system**

Type:
Serie 4



04.14.020 | 152 51 45

Charger intake hose

Type:
Serie 4



04.19.020 | 143 87 43

**Belt tensioner,
v-ribbed belt**

Engine:
DC 16

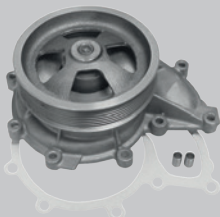

04.19.001 | 150 85 33

Water pump

Engine:
D 9 / 12, DC 9 / 19 / 20 / 21,
DSC 11 / 12



04.42.013 | 153 55 21

**Sender unit,
oil pressure**

Engine:
DC 12, DT 12

All stated genuine numbers serve only for comparison purpose and may not be used as original reference.



STEERING PARTS MERCEDES

Highlights



Track control arm
Rear axle, triangular arm
Length: 622 mm
OD: 48 mm

W 375, 930, 932, 934,
940, 944, 950, 952, 954,
958, 963, 964

Actros MP 1, MP 2, MP 3;
Atego 1, Axor 2, Econic



Track control arm
Rear axle, triangular arm
Length: 622 mm
OD: 60 mm

W 374, 930, 932, 933,
934, 940, 942, 943, 944, 950,
952, 953, 954, 958, 964

Actros MP 1, MP 2, MP 3;
Axor 2



Track control arm
Rear axle, triangular arm
Length: 622 mm
OD: 56 mm

W 375, 930, 932, 933,
934, 940, 942, 943, 944,
950, 952, 953, 954, 958

Actros MP 1, MP 2, MP 3;
Atego 1, 2; Axor 2



Track control arm
Rear axle, triangular arm
Length: 667 mm
OD: 60 mm

W 930, 932, 933, 934,
942, 943, 950, 952,
953, 954

Actros MP 1, MP 2, MP 3;
Axor 2

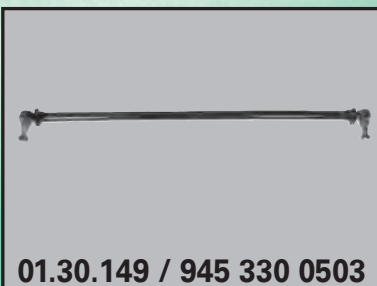

Rod assembly
Front axle
Length: 1465 mm

W 930, 934, 950, 957

Actros MP1, MP2, MP3;
Atego 1, Axor 1, Econic

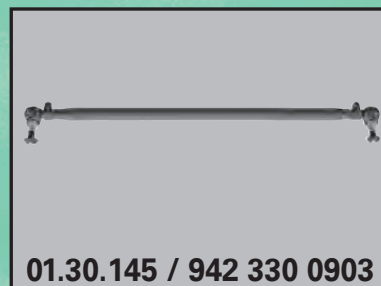

Rod assembly
Front axle
Length: 1565 mm

W 932, 933, 934, 942, 943,
950, 952, 953, 954

Actros MP 1, MP 2, MP 3;
Atego 1, Axor 2, SK, MK, NG



Drag link end
Front axle
Length: 115 mm

W 940, 941, 942, 944,
946, 948, 949

Actros MP1, MP2, MP3;
Atego 1, Axor 1, 2



Drag link end
Front axle
Length: 145 mm

W 940, 941, 942, 944, 950,
952, 953, 954

Actros MP1, MP2, MP3;
Atego 1, Axor 2



STEERING PARTS

VOLVO/MAN/SCANIA

Highlights

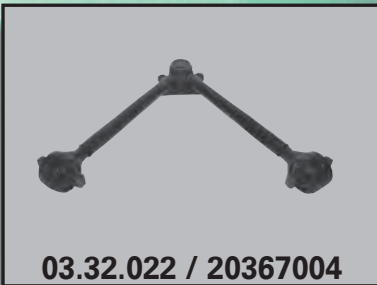

Track control arm
Rear axle, triangular arm

Length: 663 mm

VOLVO
FE, FH 12, 16
FM, FM 12
Econic



Track control arm
Rear axle, triangular arm

Length: 627 mm

MAN
TGA, TGX



Track control arm
Rear axle, triangular arm

Length: 671 mm

VOLVO
FH, FH 12, FH 16, FL 6,
FM, FM 9, FM 12



Track control arm
Rear axle, triangular arm

Length: 627 mm

MAN
TGA, TGS, TGX,
E 2000, F 2000

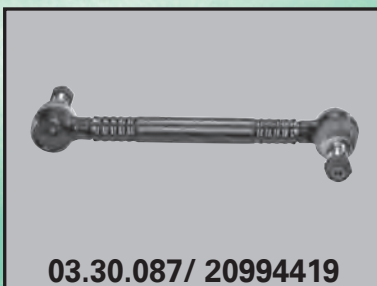

Rod / strut, stabiliser
Rear axle, coupling rod

Length: 380 mm

VOLVO
FH, FH 12, FH 16, FL 6, FM,
FM 9, FM 12

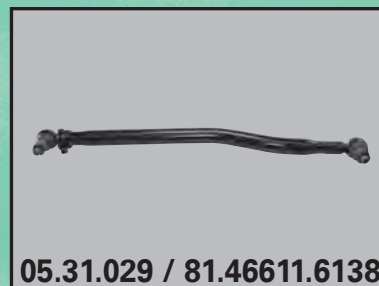

Centre rod assembly
Front axle, push rod

Length: 1021 mm

MAN
TGA, TGS



Track control arm
Rear axle, left and right

Length: 568 mm
ID: 17 mm

SCANIA
4 - Series,
P, G, R, T - Series



Track control arm
Rear axle, left and right

Length: 568 mm
ID: 19 mm

SCANIA
4 - Series,
P, G, R, T - Series



EGR VALVE



Audi

EGR Valve



07.14.040
036 131 503 T

Type:
A2 (8Z0)

EGR Valve



07.16.007
038 131 501 AF

Type:
A3 (8P1, 8PA)

EGR Valve



07.16.009
038 131 501 E

Type:
A2 (8Z0), A3 (8L1, 8P1),
A4 (8D2, B5)

EGR Valve



07.16.011
045 131 501 D

Type:
A2 (8Z0)

EGR Valve



07.16.012
045 131 501 F

Type:
A2 (8Z0)

EGR Valve



07.16.018
070 128 070 E

Type:
T5

EGR Valve



07.16.020
074 129 463 A

Type:
LT /T4

EGR Valve



07.16.021
07Z 131 501 A

Type:
Touareg

EGR Valve



07.16.022
074 129 463 B

Type:
T4

All stated genuine numbers serve only for comparison purpose and may not be used as original reference.



Audi

EGR Valve



07.16.029
038 131 501 AL

Type:
A4 (8E2, 8E5, B6),
A6 (4B5, C5)

Throttle body



07.14.191
038 128 063 M

Type:
A3 (8P1/ 8PA)

Throttle body



07.14.192
03G 128 063 J

Type:
A4 (8E2, 8E5, 8H7, B6/ 8HE, 8EC, 8ED,
B7), A6 (4F2, 4F5, C6)

Throttle body



07.14.193
4E0 145 950 H

Type:
A4 (8K2, 8K5, 8KH, B8), A5 (8T3/ 8F7/
8TA), A6 (4F2, 4F5, C6), A8 (4E_), Q5
(8R), Q7 (4L)

Throttle body



07.14.194
059 128 063 E

Type:
A4 (8E2, 8E5, 8H7, B6/ 8HE, 8EC, 8ED,
B7), A6 (4B2, 4B5, C5)

Throttle body



07.14.195
03L 128 063 E

Type:
A3 (8P1/ 8PA/ 8P7), A4 (8K2, 8K5, 8KH,
B8), A5 (8T3/ 8F7/ 8TA), A6 (4F2, 4F5,
C6), Q5 (8R), TT (8J3/ 8J9)

Throttle body



07.14.196
058 133 063 P

Type:
A4 (8E2, 8E5, 8H7, B6/ 8HE, 8EC, 8ED,
B7), A6 (4B2, 4B5, C5)

BMW

EGR Valve



08.16.008
11 71 7 810 871

Engine:
B 47, M 47, 57, N 47, 57

EGR Valve



08.16.009
11 71 7 563 241

Engine:
N 43, 45, 46

All stated genuine numbers serve only for comparison purpose and may not be used as original reference.



EGR VALVE



Mercedes

EGR Valve



02.16.028
002 140 2660

Engine:
OM601, 602

EGR Valve



02.16.029
611 090 0254

Engine:
OM611

EGR Valve



02.16.030
611 090 0354

Engine:
OM611

EGR Valve



02.16.031
612 098 0417

Engine:
OM612

EGR Valve



02.16.032
642 140 1760

Engine:
OM642

EGR Valve



02.16.033
646 140 0860

Engine:
OM612, 646 – 648

EGR Valve



02.16.034
646 140 0960

Engine:
OM646

EGR Valve



02.16.035
646 142 0119

Engine:
OM646, 647

EGR Valve



02.16.036
628 140 0060

Engine:
OM628

All stated genuine numbers serve only for comparison purpose and may not be used as original reference.



EGR VALVE



Mercedes

EGR Valve



02.16.037
640 140 0760

Engine:
OM640

EGR Valve



02.16.038
646 140 0760

Engine:
OM646

EGR Valve

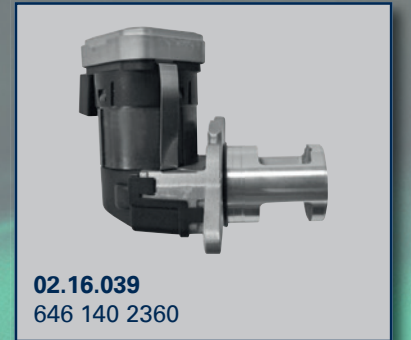

02.16.039
646 140 2360

Engine:
OM646

EGR Valve



02.16.040
668 090 0154

Engine:
OM686

EGR Valve



02.16.042
642 140 0160

Engine:
OM642

EGR Valve



02.16.043
642 140 1860

Engine:
OM642

EGR Valve



02.16.044
629 140 1560

Engine:
OM629

EGR Valve



02.16.045
629 140 1260

Engine:
OM629

Throttle body

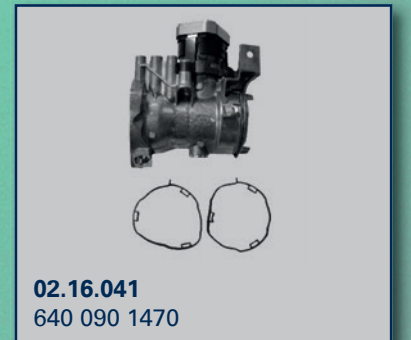

02.16.041
640 090 1470

Engine:
OM640



WATER PUMPS MERCEDES

Highlights

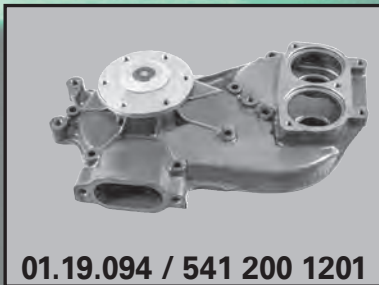

**OM 501 LA,
OM 502 LA**

Impeller Ø 125 mm
Retarder: no

w/o fastening eyes
for axial fan

01.19.094 / 541 200 1201

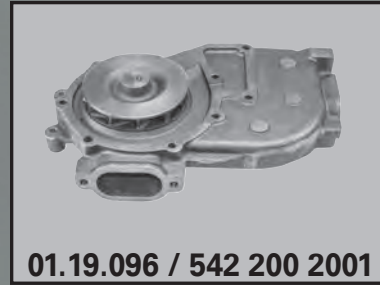

**OM 501 LA,
OM 502 A / LA**

Impeller Ø 125 mm
Retarder: yes

w/o fastening eyes
for axial fan

01.19.096 / 542 200 2001



**OM 501 LA,
OM 502 LA**

Impeller Ø 125 mm
Retarder: no

with fastening eyes
for axial fan

01.19.168 / 542 200 2501

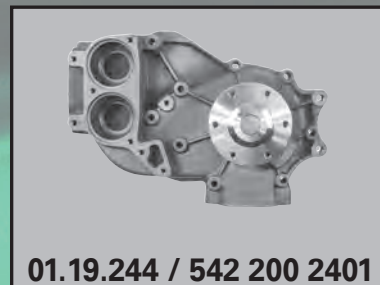

**OM 501 LA,
OM 502 LA**

Impeller Ø 125 mm
Retarder: yes

with fastening eyes
for axial fan

01.19.244 / 542 200 2401

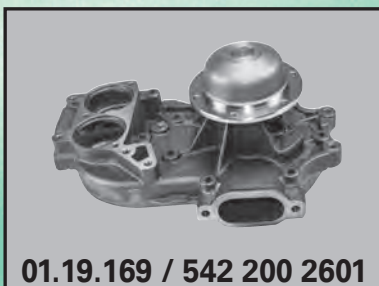

**OM 501 LA,
OM 502 LA**

Impeller Ø 125 mm
Retarder: yes

with fastening eyes
for axial fan

01.19.169 / 542 200 2601



**OM 904 LA,
906 LA, 924 LA,
926 LA**

Impeller Ø 112 mm
Retarder: no

incl. bore hole for cooling
water return line

01.19.190 / 904 200 4701



**OM 904 LA / HLA,
906 LA / HLA,
924 LA, 926 LA**

Impeller Ø 112 mm
Retarder: no

w/o bore hole for cooling
water return line

01.19.143 / 904 200 4901



**OM 470 LA,
471 LA, 472 LA,
473 LA**

Impeller Ø 130 mm
Qty. of wings: 6

01.19.191 / 472 200 0101



WATER PUMPS VOLVO/MAN/SCANIA

Highlights



VOLVO
B 12, FH 12, FL 10, FL 12,
NH 12
Impeller Ø 120 mm
Qty. of wings: 9

03.19.010 / 8 149 941

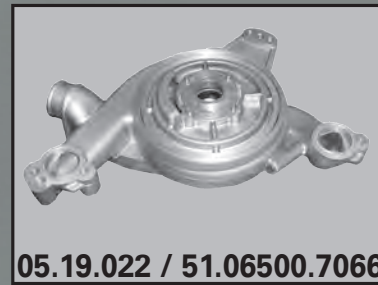

MAN
TGA, F 2000
Impeller Ø 209 mm
Qty. of wings: 8

05.19.022 / 51.06500.7066



VOLVO
B 9 L / S / TL / R, FH, FH 9,
FH 16, FM
Impeller Ø 130 mm
Qty. of wings: 16

03.19.033 / 20 744 939

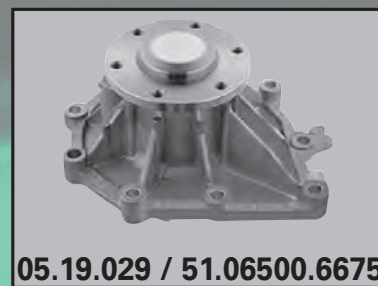

MAN
TGA, TGS, TGX,
M 2000 L / M, L 2000,
M 90
Impeller Ø 135 mm
Qty. of wings: 8

05.19.029 / 51.06500.6675



VOLVO
FH, FM
Impeller Ø 130 mm
Qty. of wings: 16
incl. deferrable OEM-
magnetic clutch

03.19.042 / 21 030 340

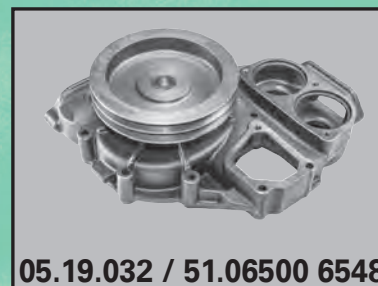

MAN
TGA, TGS, TGX,
E 2000, F 90
Impeller Ø 135 mm
Qty. of wings: 12

05.19.032 / 51.06500 6548



SCANIA
114, 124, Serie 4
Impeller Ø 105 mm
with v-ribbed belt
pulley

04.19.001 / 1 508 533



SCANIA
Serie 4
Impeller Ø 112 mm
with v-ribbed belt
pulley

04.19.025 / 1 546 188



VOLVO

HIGHLIGHTS



VOLVO



**Air Dryer Cartridge,
compressed-air system**

Type:
A-Series, B 6, B 7, B 10,
B 12, FH 12, FH 16, FL 10,
FL 12, FM 9, FM 12

Details:
M 10 x 1,5 mm



Fuel filter

Type:
B 6, B 7, B 10, B 12, FH 12,
FH 16, FL, FL 6, FM 7,
FM 10, FM 12, NH 12



**Brake Pad Set,
disc brake**

Type:
B 12, FE, FH 12, FH 16,
FM, FM 7, FM 9, FM 12



**Pump,
fuel pre-supply**

Engine:
D 7 A, D 7 B, D 7 D,
DH 10 A, TD 123,
THD 103



Wheel Bearing Kit

Type:
B 7, B 9, B 12, FE, FH,
FH 12, FH 16, FL 6, FM,
FM 7, FM 9, FM 10,
FM 12, NH 12

Details:
Front axle, Ø 68 mm,
Ø 125 mm, Height 115 mm



**Sender Unit,
oil pressure**

Type:
B 6, B 9, B 12, FH, FH 12,
FL 6, FM, FM 9, FM 12,
VHD, VN, VT, NH 12



**Pressure control valve,
lifting system**

Type:
B 6, B 7, B 9, B 10, B 12,
FE, FH, FH 12, FH 16, FL,
FM, FM 7, FM 9, FM 10,
FM 12, NH 12



**Hydraulic Filter,
steering system**

Type:
B 6, B 10, B 12, F 10, F 12,
FE, FH, FH 12, FH 16,
FL 6, FL 7, FL 10, FL 12,
FLC, FM, FM 7, FM 12,
FMX, NH 12

All stated genuine numbers serve only for comparison purpose and may not be used as original reference.



VOLVO

HIGHLIGHTS



VOLVO



03.32.035 | 184794

Wheel Bearing

Type:
B 7, B 9, B 10, B 12, B 58,
F 7, F 10, F 12, F 16, FE 6, FE
7, FH 12, FH 16, FL, FL 6, FL
7, FL 10, FL 12, FS 7, N 10, N
12, NH 12, NL 10, NL 12

Details:
Rear axle, Ø 82,55 mm,
Ø 145 mm, Height 43 mm



03.18.005 | 478736

Oil filter

Engine:
D 12 A, TD 71, TD 73,
TD 122



03.31.028 | 8151816

Wheel Bearing

Type:
B 10, B 12, F 7, F 10, F 12,
F 16, FE 7, FL, FL 6, FL 7,
FL 10, FL 12, FS 7, N 10,
N 12, NL 10, NL 12

Details:
Front axle, Ø 70 mm,
Ø 130 mm, height 43 mm



03.42.048 | 20528661

Sensor, wheel speed

Type:
FH
Details:
2.730 mm



03.33.005 | 20515515

Wheel Stud

Type:
B 6, B 7, B 9, B 12, FH,
FH 12, FH 16, FM, FM 9,
FM 12



03.42.043 | 20490824

Sensor, wheel speed

Type:
B 7, B 10, B 58, F 10, F 12,
F 16, FH 12, FH 16, FL 6,
FL 7, FL 10, FL 12, FM 7,
FM 10, FM 12, NH 12,
NL 10, NL 12
Details:
2.265 mm



03.35.017 | 72 782C

Brake Adjuster

Type:
B 7, B 10, B 12
Details:
Automatic



03.37.012 | 1585013

Hydraulic Pump, steering system

Type:
B 10, F 10, FM 10, N 10,
NL 10

All stated genuine numbers serve only for comparison purpose and may not be used as original reference.



Buy quality replacement engine parts in our online store.