



TrueSeal™ Fittings

Parker's TrueSeal Fittings are lightweight, field attachable and connect to tubing without the use of tools. These all plastic push-to-connect fittings are manufactured from FDA compliant materials.

Product Features:

- Available in Acetal, Polypropylene and Kynar materials
- EPDM seal in acetal and polypropylene, Fluorocarbon in Kynar
- Gripping ring with stainless steel bite edge or with an engineered thermoplastic bite edge
- FDA compliant, NSF-51 and gray acetal fittings are NSF-61

Markets:

- Food
- Potable Water
- Chemical
- Filtration

Applications:

- Air
- Water
- Soft Drinks
- Beer
- Wine
- Dyes

Specifications:

Pressure Range

Acetal and Kynar: 1/4", 5/16", 3/8" Vacuum to 300 psi
1/2" Vacuum to 250 psi

Polypropylene: 1/4", 3/8", 1/2" Vacuum to 150 psi

*Vacuum rating to 28 inches of Hg at room temperature

Temperature Range

Acetal: -20° to +180°F

Polypropylene: 0° to +225°F

Kynar: 0° to +275°F

Compatible Tubing:

- Polyethylene
- Polypropylene
- Nylon
- Vinyl
- Fluoropolymer
- Polyurethane
- Kynar® is a registered trademark of The Arkema Group

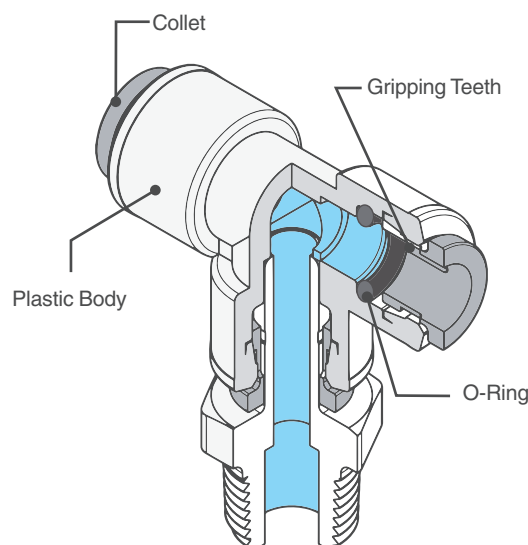

Assembly Instructions

1. Cut tubing square and clean. (Use a Parker plastic tube cutter, Part No. PTC.)
2. Mark from end of tube length of insertion (see table right).
3. Push tube into the fitting until it bottoms out.
4. To remove, depress collet and pull tubing out.

TUBE SIZE	O. D. TOLERANCE	INSERTION DEPTH
5/32	±.005	9/16
1/4	±.005	11/16
5/16	±.005	13/16
3/8	±.005	3/4
1/2	±.005	7/8



Tube to NPTF	MC Male Connector  p. C19	MES Male Elbow Swivel  p. C20	MRS Male Run Tee Swivel  p. C20	MTS Male Branch Tee Swivel  p. C20	TMC Male Standpipe  p. C21	ME Male Elbow  p. C23
	FA Faucet Adapter  p. C21	Tube to Female NPTF	FC Female Connector  p. C21	FE Female Elbow  p. C22	Tube to Straight Thread	ST Straight Thread  p. C23
FF 45° Female Flare  p. C21	EU Union Elbow  p. C19		TU Union Tee  p. C19	WY Union Y  p. C19		UC Union  p. C20
CU Cross  p. C21	Bulkhead Union	BU Bulkhead Union  p. C22	Plug-ins	TEU Tube Elbow Union  p. C22	RD Tube Reducer  p. C22	
VC Check Valve  p. C25		MCVC Kynar Check Valve  p. C25		Auxiliary Components	CAP Cap  p. C22	TCB Barbed Connector  p. C23
TPL Plug  p. C23	TFA Faucet Adapter  p. C21	TAF Faucet Adapter  p. C21	SC Safety Clip  p. C28		TS Tube Support  p. C28	AGRT Release Tool  p. C28
Ball Valves	VME Male Elbow  p. C26	VFE Female Elbow  p. C26	VUC Union Connector  p. C27	VEU Elbow Union  p. C27	VMC Male Connector  p. C27	VFC Female Connector  p. C27
	VTEU Elbow Union  p. C27					

MC - Male Connector

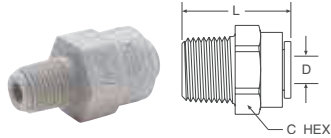

Tube-to-Pipe

GRAY ACETAL EPDM SEAL	WHITE PPL EPDM SEAL	NATURAL KYNAR FCB SEAL	NOM TUBE O.D.	NPTF THD SIZE	C HEX	L OVERALL LENGTH	D THRU HOLE MIN.
A4MC2-MG	PP4MC2	F4MC2	1/4	1/8	11/16	1.28	.175
A4MC4-MG	PP4MC4	F4MC4	1/4	1/4	11/16	1.14	.175
A4MC6-MG	PP4MC6	F4MC6	1/4	3/8	11/16	1.18	.175
A5MC2-MG		F5MC2	5/16	1/8	13/16	1.46	.175
A5MC4-MG		F5MC4	5/16	1/4	13/16	1.41	.188
A5MC6-MG			5/16	3/8	13/16	1.27	.188
A6MC2-MG		F6MC2	3/8	1/8	13/16	1.46	.175
A6MC4-MG	PP6MC4	F6MC4	3/8	1/4	13/16	1.41	.250
A6MC6-MG	PP6MC6	F6MC6	3/8	3/8	13/16	1.27	.250
A6MC8-MG		F6MC8	3/8	1/2	15/16	1.45	.250
A8MC6-MG	PP8MC6	F8MC6	1/2	3/8	15/16	1.65	.360
A8MC8-MG	PP8MC8	F8MC8	1/2	1/2	15/16	1.46	.375

For nonstandard plastic collet, remove -MG suffix.

TU - Tee Union

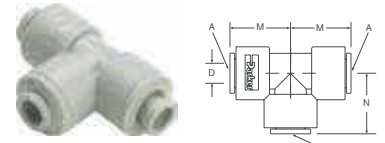

Tube-to-Tube

GRAY ACETAL EPDM SEAL	WHITE PPL EPDM SEAL	NATURAL KYNAR FCB SEAL	NOM. TUBE O.D.		M	N	D THRU HOLE MIN.
			TUBE A RUN	TUBE B STEM			
A4TU4-MG	PP4TU4	F4TU4	1/4	1/4	.81	0.85	.175
A5TU5-MG		F5TU5	5/16	5/16	1.02	1.02	.188
A6TU4-MG	PP6TU4	F6TU4	3/8	1/4	1.02	1.03	.175
A6TU6-MG	PP6TU6	F6TU6	3/8	3/8	1.02	1.02	.290
A8TU8-MG	PP8TU8	F8TU8	1/2	1/2	1.20	1.20	.375

For nonstandard plastic collet, remove -MG suffix.

EU - Elbow Union

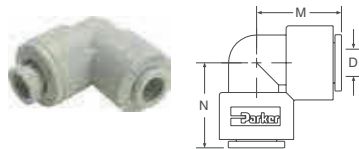

Tube-to-Tube

GRAY ACETAL EPDM SEAL	WHITE PPL EPDM SEAL	NATURAL KYNAR FCB SEAL	NOM. TUBE O.D.	M	N	D THRU HOLE MIN.
A4EU4-MG	PP4EU4	F4EU4	1/4	0.87	.87	.175
A5EU4-MG			5/16-1/4	1.052	.90	.175
A5EU5-MG		F5EU5	5/16	1.02	1.02	.188
A6EU4-MG	PP6EU4	F6EU4	3/8-1/4	1.02	.90	.212
A6EU5-MG			3/8-5/16	1.02	1.02	.175
A6EU6-MG	PP6EU6	F6EU6	3/8	1.02	1.02	.250
A8EU6-MG			1/2-3/8	1.20	1.20	.250
A8EU8-MG	PP8EU8	F8EU8	1/2	1.20	1.20	.375

For nonstandard plastic collet, remove -MG suffix.

WY - "Y" Union

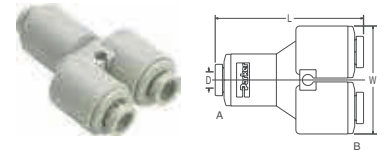

Tube-to-Tube

GRAY ACETAL EPDM SEAL	WHITE PPL EPDM SEAL	NATURAL KYNAR FCB SEAL	NOM. TUBE O.D.		L	W	D THRU HOLE MIN.
			INLET TUBE A RUN	OUTLET TUBE B STEM			
A5WY5-MG			5/16	5/16	2.250	1.75	0.190
A6WY4-MG			3/8	1/4	2.100	1.43	0.190
A6WY5-MG			3/8	5/16	2.200	1.75	0.190
A6WY6-MG			3/8	3/8	2.175	1.75	0.250



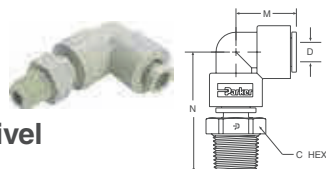

MES - Male Elbow Swivel

Tube-to-Pipe

GRAY ACETAL EPDM SEAL	WHITE PPL EPDM SEAL	NATURAL KYNAR FCB SEAL	NOM. TUBE O.D.	NPTF THD SIZE	C HEX	M	N	D THRU HOLE MIN.
A4MES2-MG	PP4MES2	F4MES2	1/4	1/8	9/16	.87	1.60	.175
A4MES4-MG	PP4MES4	F4MES4	1/4	1/4	11/16	.87	1.71	.175
A4MES6-MG	PP4MES6	F4MES6	1/4	3/8	13/16	.90	1.91	.212
A5MES2-MG			5/16	1/8	9/16	1.02	1.78	.188
A5MES4-MG			5/16	1/4	11/16	1.02	1.90	.188
A5MES6-MG			5/16	3/8	13/16	1.02	1.90	.188
A6MES2-MG		F6MES2	3/8	1/8	9/16	1.02	1.65	.175
A6MES4-MG	PP6MES4	F6MES4	3/8	1/4	13/16	1.02	1.90	.250
A6MES6-MG	PP6MES6	F6MES6	3/8	3/8	13/16	1.02	1.90	.250
A8MES4-MG			1/2	1/4	13/16	1.20	2.10	.240
A8MES6-MG	PP8MES6		1/2	3/8	13/16	1.20	2.10	.375
A8MES8-MG	PP8MES8		1/2	1/2	1	1.20	2.32	.375

* Part consists of elbow union and tube stem adaptor.
 Note: Assemblies with metal gripper collets are permanent.
 Assemblies with plastic collets can be taken apart.

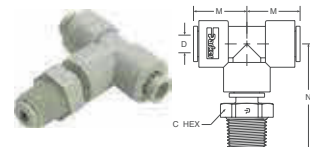

MTS - Male Tee Swivel

Tube-to-Pipe

GRAY ACETAL EPDM SEAL	WHITE PPL EPDM SEAL	NATURAL KYNAR FCB SEAL	NOM. TUBE O.D.	NPTF THD SIZE	C HEX	M	N	D THRU HOLE MIN.
A4MTS2-MG	PP4MTS2	F4MTS2	1/4	1/8	9/16	.81	1.60	.175
A4MTS4-MG	PP4MTS4	F4MTS4	1/4	1/4	11/16	.81	1.71	.175
A5MTS2-MG			5/16	1/8	9/16	1.02	1.78	.188
A5MTS4-MG			5/16	1/4	11/16	1.02	1.90	.188
A5MTS6-MG			5/16	3/8	13/16	1.02	1.90	.188
A6MTS2-MG		F6MTS2	3/8	1/8	9/16	1.02	1.75	.175
A6MTS4-MG	PP6MTS4	F6MTS4	3/8	1/4	13/16	1.02	1.90	.250
A6MTS6-MG	PP6MTS6	F6MTS6	3/8	3/8	13/16	1.02	1.90	.250
A8MTS4-MG			1/2	1/4	13/16	1.20	2.10	.240
A8MTS6-MG	PP8MTS6		1/2	3/8	13/16	1.20	2.10	.375
A8MTS8-MG	PP8MTS8		1/2	1/2	1	1.20	2.32	.375

* Part consists of tee union and tube stem adaptor.
 Note: Assemblies with metal gripper collets are permanent.
 Assemblies with plastic collets can be taken apart.

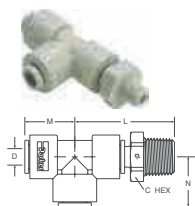

MRS - Male Run Tee Swivel

Tube-to-Pipe

GRAY ACETAL EPDM SEAL	WHITE PPL EPDM SEAL	NATURAL KYNAR FCB SEAL	NOM. TUBE O.D.	NPTF THD SIZE	C HEX	L	M	N	D THRU HOLE MIN.
A4MRS2-MG	PP4MRS2	F4MRS2	1/4	1/8	9/16	1.55	0.81	0.85	.175
A4MRS4-MG	PP4MRS4	F4MRS4	1/4	1/4	11/16	1.67	0.81	0.85	.175
A5MRS2-MG			5/16	1/8	9/16	1.78	1.02	1.02	.188
A5MRS4-MG			5/16	1/4	11/16	1.90	1.02	1.02	.188
A5MRS6-MG			5/16	3/8	13/16	1.90	1.02	1.02	.188
A6MRS4-MG	PP6MRS4	F6MRS4	3/8	1/4	13/16	1.90	1.02	1.02	.250
A6MRS6-MG	PP6MRS6	F6MRS6	3/8	3/8	13/16	1.90	1.02	1.02	.250
A8MRS4-MG			1/2	1/4	13/16	2.10	1.20	1.20	.240
A8MRS6-MG	PP8MRS6		1/2	3/8	13/16	2.10	1.20	1.20	.375
A8MRS8-MG	PP8MRS8		1/2	1/2	1	2.32	1.20	1.20	.375

* Part consists of tee union and tube stem adaptor.
 Note: Assemblies with metal gripper collets are permanent.
 Assemblies with plastic collets can be taken apart.

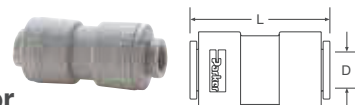

UC - Union Connector

Tube-to-Tube

GRAY ACETAL EPDM SEAL	WHITE PPL EPDM SEAL	NATURAL KYNAR FCB SEAL	NOM. TUBE O.D.	L OVERALL LENGTH	D THRU HOLE MIN.
A4UC4-MG	PP4UC4	F4UC4	1/4	1.49	.175
A5UC4-MG			5/16-1/4	1.70	.175
A5UC5-MG		F5UC5	5/16	1.70	.188
A6UC4-MG	PP6UC4	F6UC4	3/8-1/4	1.70	.175
A6UC5-MG			3/8-5/16	1.70	.188
A6UC6-MG	PP6UC6	F6UC6	3/8	1.70	.250
A8UC5-MG			1/2-5/16	1.90	.188
A8UC6-MG	PP8UC6		1/2-3/8	1.90	.250
A8UC8-MG	PP8UC8	F8UC8	1/2	1.91	.375

For nonstandard plastic collet, remove -MG suffix.



CU - Cross Union

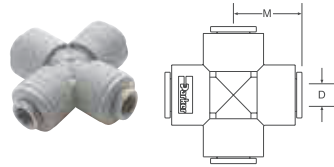

Tube-to-Tube

GRAY ACETAL EPDM SEAL	WHITE PPL EPDM SEAL	NATURAL KYNAR FCB SEAL	NOM. TUBE O.D.	M	D THRU HOLE MIN.
A4CU4-MG			1/4	.91	.175
A6CU6-MG			3/8	1.08	.250

For nonstandard plastic collet, remove -MG suffix.

FA - Faucet Adapter

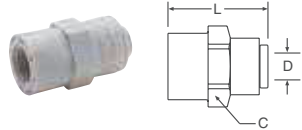

Tube-to-Faucet

GRAY ACETAL EPDM SEAL	WHITE PPL EPDM SEAL	NATURAL KYNAR FCB SEAL	NOM. TUBE O.D.	UNS-2B THREAD SIZE	C HEX	L OVERALL LENGTH	D THRU HOLE MIN.
A4FA7-MG	PP4FA7	F4FA7	1/4	7/16-24	23/32	1.32	.190
A5FA7-MG			5/16	7/16-24	13/16	1.41	.190
A6FA7-MG	PP6FA7	F6FA7	3/8	7/16-24	13/16	1.41	.190

For nonstandard plastic collet, remove -MG suffix.

FC - Female Connector

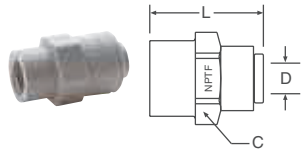

Tube-to-Pipe

GRAY ACETAL EPDM SEAL	WHITE PPL EPDM SEAL	NATURAL KYNAR FCB SEAL	NOM. TUBE O.D.	NPTF THREAD SIZE	C HEX	L OVERALL LENGTH	D THRU HOLE MIN.
A4FC2-MG	PP4FC2	F4FC2	1/4	1/8	11/16	1.20	.175
A4FC4-MG	PP4FC4	F4FC4	1/4	1/4	23/32	1.32	.175
A5FC4-MG		F5FC4	5/16	1/4	13/16	1.41	.188
A5FC6-MG			5/16	3/8	1	1.50	.188
A6FC4-MG	PP6FC4	F6FC4	3/8	1/4	13/16	1.41	.250
A6FC6-MG	PP6FC6	F6FC6	3/8	3/8	1	1.50	.250
A6FC8-MG			3/8	1/2	1-1/8	1.52	.250
A8FC6-MG	PP8FC6	F8FC6	1/2	3/8	1-1/8	1.60	.375
A8FC8-MG	PP8FC8	F8FC8	1/2	1/2	1-1/8	1.75	.375

For nonstandard plastic collet, remove -MG suffix.

FF - 45° Female Flare

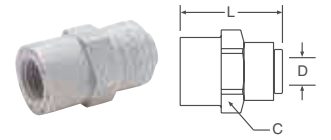

Tube-to-Flare

GRAY ACETAL EPDM SEAL	WHITE PPL EPDM SEAL	NATURAL KYNAR FCB SEAL	NOM. TUBE O.D.	UNF-2B THREAD SIZE	C HEX	L OVERALL LENGTH	D THRU HOLE MIN.
A4FF4-MG	PP4FF4	F4FF4	1/4	7/16-20	23/32	1.32	.190
A6FF4-MG		F6FF4	3/8	7/16-20	13/16	1.41	.190
A6FF6-MG	PP6FF6	F6FF6	3/8	5/8-18	1	1.50	.250

For nonstandard plastic collet, remove -MG suffix.

TMC - Tube Stem Adapter

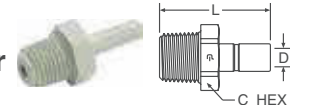

Tube Stem-to-Pipe

GRAY ACETAL EPDM SEAL	WHITE PPL EPDM SEAL	NATURAL KYNAR FCB SEAL	NOM. TUBE O.D.	NPTF THREAD SIZE	C HEX	L OVERALL LENGTH	D THRU HOLE MIN.
A4TMC2	PP4TMC2	F4TMC2	1/4	1/8	9/16	1.44	.175
A4TMC4	PP4TMC4	F4TMC4	1/4	1/4	11/16	1.56	.175
A5TMC2			5/16	1/8	9/16	1.5	.188
A5TMC4		F5TMC4	5/16	1/4	11/16	1.67	.188
A5TMC6			5/16	3/8	13/16	1.67	.188
A6TMC4	PP6TMC4	F6TMC4	3/8	1/4	13/16	1.70	.250
A6TMC6	PP6TMC6	F6TMC6	3/8	3/8	13/16	1.70	.250
A8TMC4			1/2	1/4	13/16	1.82	.240
A8TMC6	PP8TMC6		1/2	3/8	13/16	1.82	.375
A8TMC8	PP8TMC8		1/2	1/2	1	2.04	.375

TFA - Tube Faucet Adapter



(Female Thread)

WHITE ACETAL	TUBE STEM O.D.	THREAD SIZE	A	C HEX	D MIN.
AW6TFA7-MG	3/8	7/16-24	1.25	.69	.17
AW6TFA8-MG	3/8	1/2-14 NPSM	1.45	1.06	.22
AW6TFA9-MG	3/8	9/16-24	1.25	.75	.22

TAF - Tube Faucet Adapter

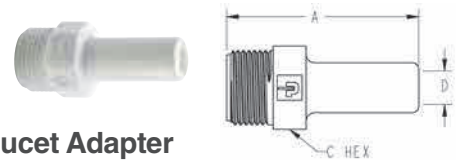

(Male Thread)

WHITE ACETAL	TUBE STEM O.D.	THREAD SIZE	A	C HEX	D MIN.
AW6TAF7-MG	3/8	7/16-24	1.41	.50	.22
AW6TAF8-MG	3/8	1/2-14 NPSM	1.65	.88	.22
AW6TAF9-MG	3/8	9/16-24	1.45	.63	.22

BU - Bulkhead Union

Tube-to-Tube

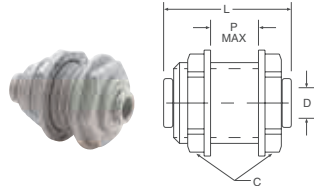

GRAY ACETAL EPDM SEAL	WHITE PPL EPDM SEAL	NATURAL KYNAR FCB SEAL	NOM. TUBE O.D.	C1 HEX	C2 HEX	L OVERALL LENGTH	P MAX. WALL THK.	D THRU HOLE MIN.	BKHD HOLE DRILL SIZE
A4BU4-MG	PP4BU4	F4BU4	1/4	15/16	15/16	1.50	.50	.175	7/8
A5BU5-MG		F5BU5	5/16	1-1/16	1-1/16	1.75	.62	.188	1
A6BU4-MG	PP6BU4		3/8-1/4	1-1/16	1-1/16	1.75	.62	.175	1
A6BU6-MG	PP6BU6	F6BU6	3/8	1-1/16	1-1/16	1.75	.62	.250	1
A8BU8-MG		F8BU8	1/2	1-1/4	1-1/4	2.04	.70	.375	1-1/8

For nonstandard plastic collet, remove -MG suffix.

RD - Tube Reducer

Tube-to-Tube Stem

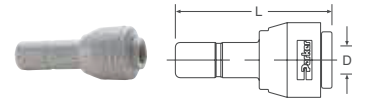

GRAY ACETAL EPDM SEAL	WHITE PPL EPDM SEAL	NATURAL KYNAR FCB SEAL	NOM. TUBE O.D.	TUBE STEM O.D.	L	D THRU HOLE MIN.
A4RD5-MG	PP4RD5		1/4	5/16	1.62	.18
A4RD6-MG	PP4RD6		1/4	3/8	1.62	.18
A5RD6-MG			5/16	3/8	1.78	.25
A5RD8-MG			5/16	1/2	1.90	.25
A6RD8-MG			3/8	1/2	1.90	.25

For nonstandard plastic collet, remove -MG suffix.

TEU - Tube Elbow Union

Tube-to-Tube Stem

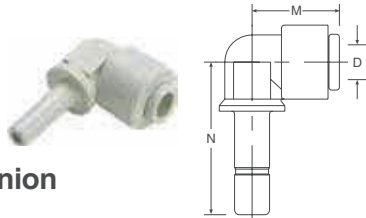

GRAY ACETAL EPDM SEAL	WHITE PPL EPDM SEAL	NATURAL KYNAR FCB SEAL	NOM. TUBE O.D.	TUBE STEM O.D.	M	N	D THRU HOLE MIN.
A4TEU4-MG	PP4TEU4	F4TEU4	1/4	1/4	.84	1.21	.125
A4TEU6-MG		F4TEU6	1/4	3/8	.84	1.35	.125
A5TEU5-MG		F5TEU5	5/16	5/16	1.03	1.40	.188
A6TEU4-MG		F6TEU4	3/8	1/4	1.03	1.29	.125
A6TEU6-MG	PP6TEU6	F6TEU6	3/8	3/8	1.03	1.64	.250
A8TEU8-MG	PP8TEU8	F8TEU8	1/2	1/2	1.21	1.64	.380

For nonstandard plastic collet, remove -MG suffix.

CAP - Tube Cap

GRAY ACETAL EPDM SEAL	WHITE PPL EPDM SEAL	NATURAL KYNAR FCB SEAL	NOM. TUBE O.D.	L OVERALL LENGTH
A4CAP-MG	PP4CAP	F4CAP	1/4	.77
A6CAP-MG	PP6CAP		3/8	0.88

For nonstandard plastic collet, remove -MG suffix.

FE - Female Elbow

Tube-to-Pipe

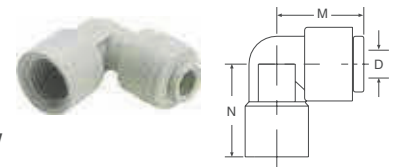

GRAY ACETAL EPDM SEAL	WHITE PPL EPDM SEAL	NATURAL KYNAR FCB SEAL	NOM. TUBE O.D.	NPTF THREAD SIZE	M	N	D THRU HOLE MIN.
A4FE4-MG			1/4	1/4	0.84	1.00	.18
A6FE4-MG			3/8	1/4	1.03	1.00	.25
A6FE6-MG			3/8	3/8	1.03	1.00	.25

For nonstandard plastic collet, remove -MG suffix.



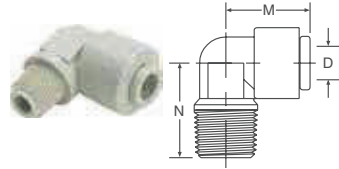

ME - Male Elbow

Tube-to-Pipe

GRAY ACETAL EPDM SEAL	WHITE PPL EPDM SEAL	NATURAL KYNAR FCB SEAL	NOM. TUBE O. D.	NPTF THD SIZE	M	N	D THRU HOLE MIN.
A4ME2-MG	PP4ME2	F4ME2	1/4	1/8	.84	.94	.175
A4ME4-MG	PP4ME4	F4ME4	1/4	1/4	.84	.94	.175
A4ME6-MG	PP4ME6	F4ME6	1/4	3/8	.84	1.04	.175
A5ME4-MG		F5ME4	5/16	1/4	1.03	1.08	.175
A5ME6-MG			5/16	3/8	1.03	1.06	.188
A6ME4-MG	PP6ME4	F6ME4	3/8	1/4	1.03	1.08	.250
A6ME6-MG	PP6ME6	F6ME6	3/8	3/8	1.03	1.06	.250

For nonstandard plastic collet, remove -MG suffix.

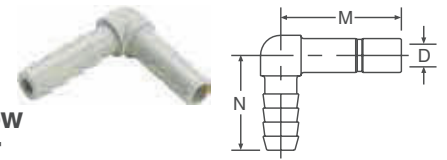

TEB - Tube Elbow Barb Connector

GRAY ACETAL	WHITE PPL	NATURAL KYNAR	TUBE STEM O. D.	TUBE I. D.	M	N	D THRU HOLE MIN.
A4TEB4	PP4TEB4	F4TEB4	1/4	1/4	.89	1.00	.140
A6TEB4	PP6TEB4	F6TEB4	3/8	1/4	1.335	1.055	.375
A6TEB6	PP6TEB6	F6TEB6	3/8	3/8	1.34	1.21	.250
A8TEB8			1/2	1/2	1.30	1.30	.390



ST - Straight Thread

Tube-to-Male O-Ring Boss

GRAY ACETAL EPDM SEAL	WHITE PPL EPDM SEAL	NATURAL KYNAR FCB SEAL	NOM. TUBE O. D.	UNF-2B THD SIZE	C HEX	L OVERALL LENGTH	D THRU HOLE MIN.
A6ST9-MG		F6ST9 (+)	3/8	9/16-18	13/16	1.39	.250

For nonstandard plastic collet, remove -MG suffix.

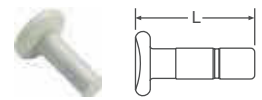

TPL - Plug

GRAY ACETAL	WHITE PPL	NATURAL KYNAR	FITTING SIZE	L OVERALL LENGTH
A4TPL	PP4TPL	F4TPL	1/4	0.88
A6TPL	PP6TPL	F6TPL	3/8	1.45
A8TPL	PP8TPL		1/2	1.50



TCB - Tube-to-Barb Connector

GRAY ACETAL	WHITE PPL	NATURAL KYNAR	TUBE STEM O. D.	TUBE I. D.	L OVERALL LENGTH	D THRU HOLE MIN.
A4TCB4	PP4TCB4	F4TCB4	1/4	1/4	1.67	.140
A6TCB4		F6TCB4	3/8	1/4	1.82	.140
A6TCB6	PP6TCB6	F6TCB6	3/8	3/8	1.98	.250
A8TCB6			1/2	3/8	2.10	.250
A8TCB8		F8TCB8	1/2	1/2	2.10	.375



TSC - Cartridge Insert

PART NUMBER WITH EPDM SEAL	NOM. TUBE O.D.	A* DIAMETER ±002	B DIAMETER ±003	C DIAMETER ±003	D DIAMETER MAXIMUM	E DEPTH ±002	F DEPTH ±002	G DEPTH ±002	H* CENTERLINE OF PORTS MINIMUM
ATSC4-MG	1/4	.528	.421	.260	.19	.230	.435	.600	.670
ATSC6-MG	3/8	.632	.545	.385	.31	.280	.455	.705	.790
ATSC8-MG	1/2	.774	.668	.510	.41	.315	.510	.810	1.250

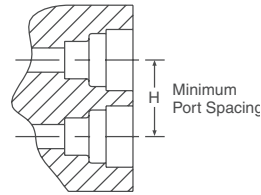
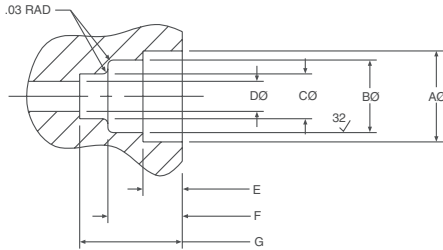

Parker TrueSeal™ Cartridge Inserts:

Allow you to machine or mold a tube connection into your equipment or components. By using cartridge inserts, you will reduce your material and assembly costs, reduce potential leak paths, and give your equipment a new, clean profile by eliminating the need for threaded connections. TSC Cartridge Inserts consist of 1 o-ring, 1 cartridge, and 1 collet.

*Cartridge inserts are rated at 150 psi in ports dimensioned as above and having Noryl as the receiving material. Other materials may have different ratings and require different port dimensions. Consult the Fluid System Connectors Division when using polypropylene, unfilled polypropylene, ABS or Nylon.

Assembly Instructions:

1. Machine or mold the receiving orifice as per the above dimensions.
2. Place the cartridge insert squarely onto the prepared port opening making sure that the barbs of the cartridge are going into the hole and the lettering on the face of the cartridge is visible.
3. Using a rubber mallet or press, insert the cartridge into the first gland orifice until its face is flush with the top surface of the port.
4. Insert the o-ring into the cartridge and seat it evenly into the second gland orifice.
5. Insert the collet into the cartridge opening.
6. Insert tubing.



TrueSeal Check Valves

Push-to-Connect check valves that ensures protection against reversal of flow. The valves have an arrow molded into the body to indicate the direction of flow. Valves are designed for connection with either thermoplastic or soft metal tubing and are intended for use with liquids only.

Materials of Construction

Body	Acetal
O-ring	EPDM
Metal Grip Edge	300 Stainless
Working Pressure	Up to 150 PSI depending on tubing being used
Temperature Range	+34°F (1° C) to +150°F (65°C)
Cracking Pressure	1/3 PSI

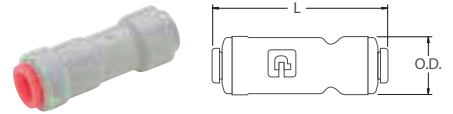

VC – Check Valve

PART NO.	TUBE SIZE	L	O.D.
A4VC4-MG	1/4	2.00	.66
A5VC5-MG	5/16	2.10	.70
A6VC6-MG	3/8	2.15	.80
A8VC8-MG	1/2	2.68	.91

NORYL® is a registered trademark of the General Electric Co.

PVDF Check Valves

Materials of Construction

Body	Kynar®
O-ring	Fluorocarbon
Metal Grip Edge	Stainless Steel
Working Pressure	Up to 300 PSI
Temperature Range	0°F to 250°F



MCVC Kynar® Check Valves

PART NUMBER	TUBE O.D.	NPTF THREAD	L	C HEX	CRACKING PRESSURE PSI
FB6MCVC4-HBLK-05	3/8	1/4	1.40	13/16	0.5
FB6MCVC4-HBLU-15	3/8	1/4	1.40	13/16	1.5
FB6MCVC4-HRED-30	3/8	1/4	1.40	13/16	3.0
FB6MCVC4-HGRN-40	3/8	1/4	1.40	13/16	4.0

Note: For check valve to function properly tubing needs to be installed

Polypropylene Ball Valves

For proven leak-free performance, specify Polypropylene Ball Valves. Their corrosion-resistant, all-plastic design makes them ideal for water filtration units, coffee and beverage machines and a wide variety of other fluid applications. Polypropylene material meets all FDA and NSF-51 requirements for food contact.

Features/Benefits:

- Precision molded, all-plastic design is leak free and corrosion resistant.
- Polypropylene material offers a wider chemical acceptance range, as well as a wide temperature range.
- Bi-directional flow maximizes productivity.
- Full flow design reduces pressure drop across the valve.
- Special o-ring seal ensures a reliable leak-tight connection.
- TrueSeal™ connection reduces potential leaks.

Specifications:

- Temperature range: 0°F to 225°F (-18°C to 107°C).
- O-ring seal material: EPDM.
- NSF-51 listed.
- Pressure rated to 150 PSI with a 600 PSI burst pressure. Actual working pressures will be lower at elevated temperatures

Advantages:

- Reduce costs—Built-in TrueSeal™ connection eliminates the need for a secondary fitting.
- Save space—Low-profile design allows for easy assembly and access where space is at a premium.

Assembly Instructions:

1. Inspect the mating threads for debris or damage. Remove any old fluoropolymer tape or sealant on previously used threads. If threads are damaged, replace with new adapter before proceeding.
2. Apply 2 to 3 wraps of fluoropolymer tape, or an NSF/FDA approved silicon sealant. Do not use Plumbers Putty or Pipe Dope. These chemically react with plastic materials and could cause a failure.
3. Align ball valve to mating thread to ensure cross threading does not occur.
4. Screw ball valve onto mating thread 3 to 5 turns. This should be sufficient to properly seal the threads.
5. Pressurize system and check for leaks.

VME - Valve Male Elbow

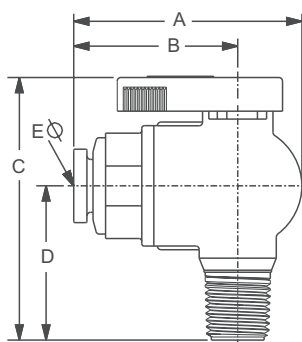

PART NUMBER	NOM. TUBE O.D.	NPTF THREAD SIZE	A	B	C	D	ØE THRU HOLE MIN.
PP4VME2-MG (+)	1/4	1/8	1.74	1.21	2.00	1.10	.19
PP4VME4-MG	1/4	1/4	1.74	1.21	2.18	1.28	.19
PP4VME6-MG	1/4	3/8	1.74	1.21	2.18	1.28	.19
PP4VME8-MG (+)	1/4	1/2	1.74	1.21	2.37	1.47	.19
PP6VME2-MG (+)	3/8	1/8	1.85	1.32	2.00	1.10	.25
PP6VME4-MG	3/8	1/4	1.85	1.32	2.18	1.28	.25
PP6VME6-MG	3/8	3/8	1.85	1.32	2.18	1.28	.25
PP6VME8-MG	3/8	1/2	1.85	1.32	2.37	1.47	.25

VFE - Valve Female Elbow

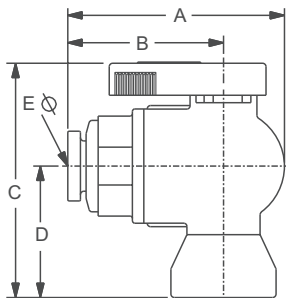

PART NUMBER	NOM. TUBE O.D.	NPTF THREAD SIZE	A	B	C	D	ØE THRU HOLE MIN.
PP4VFE2-MG (+)	1/4	1/8	1.74	1.21	1.82	.92	.19
PP4VFE4-MG	1/4	1/4	1.74	1.21	2.05	1.15	.19
PP4VFE6-MG	1/4	3/8	1.74	1.21	2.18	1.28	.19
PP6VFE2-MG (+)	3/8	1/8	1.85	1.32	1.82	.92	.25
PP6VFE4-MG	3/8	1/4	1.85	1.32	2.05	1.15	.25
PP6VFE6-MG	3/8	3/8	1.85	1.32	2.18	1.28	.25

(+) Non Standard.



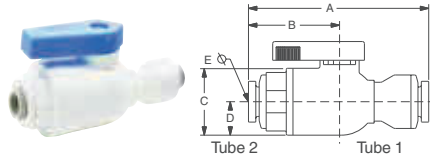

VUC - Valve Union Connector

PART NUMBER	1 TUBE SIZE	2 TUBE SIZE	A	B	C	D	ØE THRU HOLE MIN.
PP4VUC4-MG	1/4	1/4	2.55	1.22	1.0	.5	.19
PP4VUC6-MG	1/4	3/8	2.55	1.22	1.0	.5	.19
PP6VUC4-MG	3/8	1/4	2.57	1.30	1.0	.5	.19
PP6VUC6-MG	3/8	3/8	2.67	1.32	1.4	.5	.25

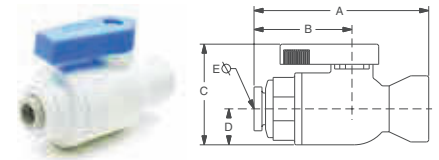

VFC - Valve Female Connector

PART NUMBER	NOM. TUBE O.D.	NPTF THREAD SIZE	A	B	C	D	ØE THRU HOLE MIN.
PP4VFC2-MG	1/4	1/8	2.04	1.21	1.4	.5	.19
PP4VFC4-MG	1/4	1/4	2.27	1.21	1.4	.5	.19
PP4VFC6-MG	1/4	3/8	2.40	1.21	1.4	.5	.19
PP6VFC2-MG	3/8	1/8	2.15	1.32	1.4	.5	.25
PP6VFC4-MG	3/8	1/4	2.38	1.32	1.4	.5	.25
PP6VFC6-MG	3/8	3/8	2.51	1.32	1.4	.5	.25

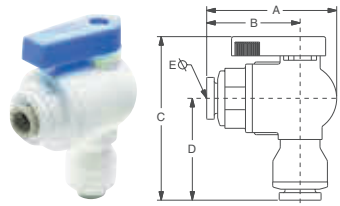

VEU - Valve Elbow Union

PART NUMBER	1 TUBE SIZE	2 TUBE SIZE	A	B	C	D	ØE THRU HOLE MIN.
PP4VEU4-MG	1/4	1/4	1.75	1.22	2.33	1.42	.19
PP4VEU6-MG	1/4	3/8	1.75	1.22	2.33	1.42	.11
PP6VEU4-MG	3/8	1/4	1.83	1.30	2.32	1.40	.19
PP6VEU6-MG	3/8	3/8	1.85	1.32	2.34	1.44	.25

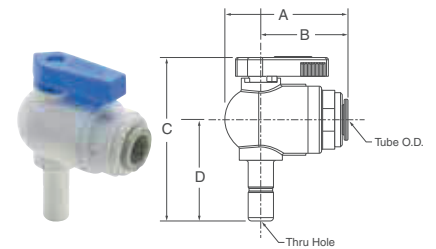

VTEU - Valve Tube Elbow Union

PART NUMBER	NOM. TUBE O.D.	STEM	A	B	C	D	ØE THRU HOLE MIN.
PP4VTEU6-MG	1/4	3/8	1.75	1.22	2.43	1.50	.17
PP6VTEU6-MG	3/8	3/8	1.83	1.30	2.43	1.50	.25

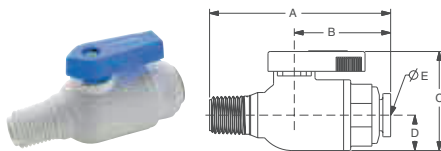

VMC - Valve Male Connector

PART NUMBER	NOM. TUBE O.D.	NPTF THREAD SIZE	A	B	C	D	ØE THRU HOLE MIN.
PP4VMC2-MG (+)	1/4	1/8	2.22	1.21	1.4	.5	.19
PP4VMC4-MG	1/4	1/4	2.40	1.21	1.4	.5	.19
PP4VMC6-MG	1/4	3/8	2.40	1.21	1.4	.5	.19
PP4VMC8-MG (+)	1/4	1/2	2.59	1.21	1.4	.5	.19
PP6VMC2-MG (+)	3/8	1/8	2.33	1.32	1.4	.5	.25
PP6VMC4-MG	3/8	1/4	2.51	1.32	1.4	.5	.25
PP6VMC6-MG	3/8	3/8	2.51	1.32	1.4	.5	.25
PP6VMC8-MG (+)	3/8	1/2	2.70	1.32	1.4	.5	.25

SC - Safety Clip

(Patent No. 6,065,779)



PART NUMBER	PART NUMBER	FOR NOMINAL TUBE O.D.
SC-4	SC-4-B	1/4
SC-5	SC-5-B	5/16
SC-6	SC-6-B	3/8
SC-8	SC-8-B	1/2

TS - Tube Supports



NYLON PART NUMBER	PPL PART NUMBER
N4TS3	P4TS3
N5TS3	P5TS3
N6TS4	P6TS4
N8TS6	P8TS6

To be used with soft durometer tubing.

AQRT - Quick Release Tool

Makes disconnection of tube adapters and tubing a breeze.

