



Engineering

Technical Standard

TS 0370 Fire Detection and Emergency Evacuation Systems

Version: 1.0

Date: 18 Oct 2018

Status: FINAL

Document ID: SAWS-ENG-0370

© 2018 SA Water Corporation. All rights reserved. This document may contain confidential information of SA Water Corporation. Disclosure or dissemination to unauthorised individuals is strictly prohibited. Uncontrolled when printed or downloaded.



Copyright

This Technical Standard remains intellectual property of the South Australian Water Corporation. It is copyright and all rights are reserved by SA Water. No part may be reproduced, copied or transmitted in any form or by any means without the express written permission of SA Water.

The information contained in this Standard is strictly for the private use of the intended recipient in relation to works or projects of SA Water.

This Standard has been prepared for SA Water's own internal use and SA Water makes no representation as to the quality, accuracy or suitability of the information for any other purpose.

Application and Interpretation of this Document

It is the responsibility of the users of this Standard to ensure that the application of information is appropriate and that any designs based on this Standard are fit for SA Water's purposes and comply with all relevant Australian Standards, Acts and regulations.

Users of this Standard accept sole responsibility for interpretation and use of the information contained in this Standard. Users should independently verify the accuracy, fitness for purpose and application of information contained in this Standard.

Only the current revision of this Standard should be used which is available for download from the SA Water website.

Significant/Major Changes Incorporated in This Edition

This is the first revision of this Technical Standard.



Document Controls

Revision History

Revision	Date	Author	Comments
0.1	10 July 2018	Justin Hamra	First Draft
0.2	21 August 2018	Justin Hamra	Issued for internal comment
0.3	28 August 2018	Justin Hamra	Issued for Independent Peer Review (External)
0.4	3 October 2018	Justin Hamra	Changes incorporated from Independent Peer Review (External)
1.0	18 October 2018	Justin Hamra	New document TS 0370

Template: Technical Standard Version 6.00, 10/05/2016

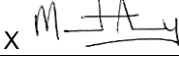
Approvers

Role	Signature and Date
Principal Electrical Engineer Justin Hamra	18/10/2018 X  Justin Hamra Signed by: HA003627
Manager Engineering Technical Services Murat Aksoy	19/10/2018 X  Murat Aksoy Signed by: AK003305
Senior Manager Engineering Services Richard Gray	19/10/2018 X  Richard Gray Signed by: GR001964

Reviewers

Role	Name	Revision	Review Date
Senior Electrical Engineer	Jonathan Nicholls	0.1	26/7/18
Senior Electrical Engineer	Sachin Pandey	0.1	26/7/18
Graduate Electrical Engineer	Reuben Sugars	0.1	26/7/18
Director – J ² Consulting Engineers	James Sunjaya (BPB Accredited Fire Engineer Grade C10)	0.2	28/8/18

Contents

1	Introduction	6
1.1	Purpose	6
1.2	Acronyms and Abbreviations	6
1.3	Definitions	7
1.4	References	8
1.4.1	Australian and International Standards.....	8
1.4.2	SA Water Documents.....	9
2	Scope	10
2.1	Approval to Deviate From This Standard	10
2.2	Design Criteria.....	10
3	Categorisation and Planning	12
3.1	Planning and Design Considerations	12
3.2	Site Categorisation.....	12
4	Fire Detection and Alarm Systems	14
4.1	General Requirements	14
4.2	Automatic Fire Detection Systems	15
4.2.1	Air-Handling System Shutdown.....	16
4.2.2	Occupant Warning	16
4.2.3	Visual/Audible Alarm Devices	16
4.2.4	Smoke/Heat Alarms.....	17
4.2.5	Point-Type Smoke and Heat Detectors	17
4.2.6	Multi-point Aspirated Smoke Detection (MASD)	17
4.2.7	Linear Heat Detection (LHD)	18
4.2.8	Fire Indicator Panels	18
4.3	Emergency Warning Systems	19
4.3.1	General.....	19
4.3.2	Emergency Control Panels.....	20
4.3.3	Audible Warning Devices	20
4.3.4	Visual Warning Devices	21
4.3.5	Remote Paging Console(s)	21
4.3.6	Manual Call Points.....	21
4.4	Exit and Emergency Lighting	22
4.5	Exit Doors.....	23
4.6	Gas Detection Systems.....	23
4.7	SCADA	23
5	Fire Detection and Emergency Warning System Installation	25
5.1	Cabling	25
5.2	Electrical Installation for Hazardous Areas.....	25
5.3	Labelling and Marking.....	25
5.4	Documentation	26

5.4.1	Coloured Zone Block Plan	26
5.4.2	Fire Indicator Panel Configuration Data	26
5.4.3	Log Books.....	26
5.5	Testing and Commissioning	26
5.6	Operator Training	27
Appendix A	– Coloured Zone Block Plan Examples	28
Appendix B	– Fire and Evacuation Drawing Examples	33

List of Figures

Figure 4-1 – Control System Boundaries.....	24
Figure 5-1 - Block Plan Example (1 of 9).....	28
Figure 5-2 - Block Plan Example (2 of 9).....	29
Figure 5-3 - Block Plan Example (3 of 9).....	29
Figure 5-4 - Block Plan Example (4 of 9).....	30
Figure 5-5 - Block Plan Example (5 of 9).....	30
Figure 5-6 - Block Plan Example (6 of 9).....	31
Figure 5-7 - Block Plan Example (7 of 9).....	31
Figure 5-8 - Block Plan Example (8 of 9).....	32
Figure 5-9 - Block Plan Example (9 of 9).....	32
Figure 5-10 - Site Plan Example	33
Figure 5-11 – Legend and Symbols Example	33
Figure 5-12 – Specific Location Arrangement Example	34
Figure 5-13 – External Speaker and Strobe Light Locations and Coverage Example	34
Figure 5-14 – Network Block Diagram Example.....	35
Figure 5-15 – Cabling Routes Example	35

List of Tables

Table 1 - Table of Definitions Used in this Technical Standard	7
Table 2 – Standards Referred to in this Technical Standard	8
Table 3 –Referenced Internal Standards.....	9
Table 4 - Site Category Definitions	12

1 Introduction

SA Water is responsible for operation and maintenance of an extensive amount of engineering infrastructure.

This Technical Standard has been developed to assist in the design, maintenance, construction, and management of this infrastructure.

1.1 Purpose

The purpose of this standard is to detail minimum requirements to ensure that assets covered by the scope of this standard are constructed and maintained to consistent standards and attain the required asset life.

1.2 Acronyms and Abbreviations

The following acronyms and abbreviations are used in this document:

Term	Description
AAD	Audible Alarm Device
AS	Australian Standards
ASE	Alarm Signalling Equipment
AWD	Audible Warning Device
BCA	Building Code of Australia (National Construction Code)
CFS	Country Fire Service
CIE	Control and Indicating Equipment
DGP	Data Gathering Panel
ELV	Extra-low Voltage
EWCIE	Emergency Warning Control and Indicating Equipment
EWIS	Emergency Warning and Intercom System
EWS	Emergency Warning System
FACP	Fire Alarm Control Panel
FD&EE	Fire Detection and Emergency Evacuation
FDCIE	Fire Detection Control and Indicating Equipment
FIP	Fire Indicator Panel
HLI	High Level Interface
LED	Light Emitting Diode
LHD	Linear Heat Detection (Cable)
LV	Low Voltage
MASD	Multi-Point Aspirating Smoke Detection
MCP	Manual Call Point
MECP	Master Emergency Control Panel
MFS	Metropolitan Fire Service
OWS	Occupant Warning System
PA	Public Address
PLC	Programmable Logic Controller
RFID	Radio Frequency Identification

Term	Description
RPC	Remote Paging Console
RTU	Remote Telemetry Unit
SAMFS	South Australian Metropolitan Fire Service
SAW	SA Water
SCADA	Supervisory Control and Data Acquisition
SECP	Secondary Emergency Control Panel
SIP/SFIP	Sub-fire Indicator Panel
VAD	Visual Alarm Device
VWD	Visual Warning Device
WHS	Work Health and Safety

1.3 Definitions

The following definitions are applicable to this document:

Table 1 - Table of Definitions Used in this Technical Standard

Term	Description
Contractor	A person or firm that undertakes a contract to provide materials or labour to perform a service or do a job.
Corrosive Environments	Any environment where there is a presence of destructive chemicals in which the electrical assets are subject to deleterious effects. Examples of destructive chemicals are: Hydrogen Sulfide; Ammonia; Chlorine; Sodium Chloride; etc. Any installation located close (within 1 km of the ocean) or in high ground water environments (exhibiting salinity) shall be considered as a corrosive environment for the purposes of this Technical Standard.
Customer Cabling	A line that is used, installed ready for use or intended for use on the customer side of the boundary of a telecommunications network. (Refer AS/CA S009)
SA Water's Representative (The Principal)	The SA Water nominated representative with delegated authority under a Contract or engagement, including (as applicable): <ul style="list-style-type: none"> • Superintendent's Representative • SA Water Project Manager • SA Water nominated contact person
Site Schedule	The schedule of information that should be completed at the project definition phase.
Standard	Reference to a SA Water Technical Standard.
Switchboard	An assembly of circuit protective devices, with or without switchgear, instruments or connecting devices, suitably arranged and mounted for distribution to, and protection of, one or more submains or final subcircuits or a combination of both.
Voltage	(a) Extra-low voltage: Not exceeding 50 V a.c. or 120 V ripple-free d.c. (b) Low voltage: Exceeding extra-low voltage, but not exceeding 1,000 V a.c. or 1,500 V d.c. (c) High voltage: Exceeding low voltage.

1.4 References

1.4.1 Australian and International Standards

Any Standard referred to in this Specification shall be of the latest edition (including amendments) of that Standard at the date of calling of tenders.

The following table identifies Australian and International standards and other similar documents referenced in this document:

Table 2 – Standards Referred to in this Technical Standard

Standard	Title
AS 1603.5	Automatic Fire Detection and Alarm Systems – Manual Call Points
AS 1603.11	Automatic Fire Detection and Alarm Systems – Visual Warning Devices
AS/NZS 1668.1	The use of ventilation and air-conditioning in buildings - Part 1: Fire and smoke control in multi-compartment buildings.
AS 1670.1	Fire detection, warning, control and intercom systems - System design, installation and commissioning Part 1: Fire
AS 1670.4	Fire detection, warning, control and intercom systems - System design, installation and commissioning - Part 4: Sound systems and intercom systems for emergency purposes
AS 1851	Routine service of fire protection systems and equipment
AS/NZS 2220.1	Emergency warning and intercommunication systems in buildings – Part 1: Equipment design and manufacture
AS/NZS 2293.1	Emergency escape lighting and exit signs for buildings - Part 1: System design, installation and operation
AS/NZS 2293.3	Emergency escape lighting and exit signs for buildings - Part 3: Emergency escape luminaires and exit signs
AS/NZS 3000	Wiring Rules
AS/NZS 3013	Electrical installations – Classification of the fire and mechanical performance of wiring system elements
AS 3786	Smoke alarms using scattered light, transmitted light or ionization
AS 4428.3	Fire detection, warning, control and intercom systems - Control and indicating equipment Part 0: Fire Brigade Panel
AS 4428.16	Fire detection and alarm systems - Part 16: Emergency warning control and indicating equipment.
AS/NZS 60079.14	Explosive atmospheres - Electrical installations design, selection and erection
AS/NZS 60598.2.22	Luminaires Particular requirements - Luminaires for emergency lighting
AS 60849	Sound systems for emergency purposes (IEC 60849:1998 MOD)
AS/NZS IEC 61347.2.13	Lamp controlgear Particular requirements for d.c. or a.c. supplied electronic controlgear for LED modules
AS 7240.2	Fire detection and alarm systems - Part 2: Control and indicating Equipment
AS ISO 7240.3	Fire detection and alarm systems - Part 3: Audible alarm devices
AS 7240.4	Fire detection and alarm systems - Part 4: Power supply equipment
AS 7240.5	Fire detection and alarm systems - Part 5: Point type heat detectors
AS 7240.7	Fire detection and alarm systems - Part 7: Point type heat detectors using scattered light, transmitted light or ionization

Standard	Title
AS 7240.20	Automatic fire detection and alarm systems - Part 20: Aspirating smoke detectors
AS ISO 7240.23	Fire detection and alarm systems - Part 23: Visual alarm devices
AS/CA S009	Installation Requirements for Customer Cabling (Wiring Rules)
AS CISPR 15	Limits and methods of measurement of radio disturbance characteristics of electrical lighting and similar equipment
SAMFS Policy 037	BUILT ENVIRONS SECTION POLICY 037 Fire Alarm Conditions of Connection (Schedule 1)

1.4.2 SA Water Documents

1.4.2.1 Standard Documents

The following table identifies the SA Water standards and other similar documents referenced in this document:

Table 3 –Referenced Internal Standards

Number	Title
TS 0132	Operating and Maintenance Manuals
TS 0300	Supply and Installation of Low Voltage Electrical Equipment

2 Scope

This Technical Standard Specification covers the design, supply and installation of Fire Detection and Emergency Evacuation (FD&EE) systems for SA Water assets.

This Technical Standard Specification shall be read in conjunction with the associated project specification, drawings and any documents annexed to the project specification. The provisions of this Technical Specification shall apply unless they are specifically deleted or amended in the project specification or drawings which shall then take precedence. The currency of this Standard should be checked prior to use.

2.1 Approval to Deviate From This Standard

Approval may ultimately be granted by the SA Water Principal Electrical Engineer, to deviate from the requirements as stipulated in this Standard, if the functional requirements (e.g. asset life, ease of use, maintainability, etc.) for the asset differs from those stated in the Standard, but is assessed as still being acceptable. Any approval to deviate from the stated requirements of this Standard shall not be seen as creating a precedent for future like projects. Any request to deviate from this Standard must be carried out on a project by project basis, where each alternative proposal will be individually assessed on its own merit. No action should be taken until a written reply to such a request has been received.

SA Water encourages and welcomes suggestions as to the improvement of this standard for future releases. These suggestions should be passed through to the SA Water Principal Electrical Engineer.

2.2 Design Criteria

The design criteria must be ascertained and agreed with SA Water or its representative during all stages of investigation, concept design and detailed design in order to achieve a value-for-money installation that is fit for purpose and with minimum or negligible risks to SA Water. The design criteria should consider the following aspects:

1. Safety Considerations

The installations are to be designed with the safety and welfare of construction, operation and maintenance personnel and the general public in mind, complying with statutory regulations. Wherever possible, electrical equipment and wiring should not be located in areas classified as hazardous.

2. Life Cycle Costs

Designs should be innovative and incorporate the appropriate techniques and technology, in conjunction with the selection of appropriate equipment, to minimise the life cycle costs, while satisfying operation and maintenance requirements. Energy consumption must be given particular attention in this respect.

3. Security of Operation

Designs should take into account the failure of a single item of equipment or a fault in a particular area of an installation is confined to the associated part of the installation and does not affect the continuous operation of the remaining parts of the installation, where possible.

4. Reliability

The installations are to be designed to minimise the likelihood of a failure, taking into consideration the electricity supply characteristics, ambient conditions, load characteristics and operation and maintenance requirements.

5. Upgradability

The installations are to be designed to facilitate future upgrades where applicable.

6. Interchangeability

The installations are to be designed to maximise the interchangeability of components and assemblies as far as practical to improve flexibility and reduce the spare parts inventory.

7. Operation, Maintenance and Fault-Finding Facilities

The installations are to be provided with suitable and adequate facilities to allow ease of operation, maintenance and fault finding.

8. Environmental Considerations

The installations are to be designed and suitable equipment selected to avoid or minimise unacceptable impact on the environment as far as possible.

3 Categorisation and Planning

Fire Detection and Emergency Evacuation (FD&EE) systems are required to ensure the safe and rapid evacuation of personnel in the event of an emergency, in accordance with WHS Regulations 2012. FD&EE systems are critical to maintaining the safety of personnel, and to ensure the rapid response of emergency services in the event of a fire.

This Technical Standard covers the following aspects of Fire Detection and Emergency Evacuation:

- Fire detection systems;
- Emergency evacuation systems; and
- Exit and emergency lighting systems.

Other systems such as gaseous and wet (deluge) extinguishing systems and smoke hazard management systems are not covered by this Technical Standard.

3.1 Planning and Design Considerations

Assessment of each plant/installation should be confirmed through consultation with the asset owner and using risk assessment tools based on the following criteria:

- a. Frequency that site is manned (hours per day/ days per week);
- b. Number of personnel on site, when manned (excluding Contractors and others);
- c. Facility size;
- d. Criticality of asset;
- e. Chemicals on site with some form of leak detection;
- f. Electrical requirements, such as HV switchroom monitoring;
- g. Other fire hazards; and
- h. BCA and WHS regulations.

3.2 Site Categorisation

The type of fire and evacuation system may be classed by one of the following SA Water defined categories. As such, these categories may be used when defining the nature of fire detection and emergency evacuation system for an SA Water facility. The assessed categorisation of a site should be confirmed through consultation with the asset owner.

Table 4 - Site Category Definitions

Category	Description
Category 1	Fully compliant fire system to AS 1670.1 monitored by the local fire service (MFS/CFS) with an Emergency Warning System (EWS) in accordance with AS 1670.4.
Category 2A	Fully compliant fire system to AS 1670.1 monitored by the local fire service (MFS/CFS) with an Occupant Warning System (OWS) via an Amplified Sound System i.e. speakers.
Category 2B	Fully compliant fire system to AS 1670.1 monitored by the local fire service (MFS/CFS) with an Occupant Warning System (OWS) via Audible and/or Visual alarm devices.
Category 3	Local fire system (non-brigade monitored*) monitored through SCADA with an Occupant Warning System (OWS) via Audible and/or Visual alarm devices in accordance with AS 1670.1.
Category 4	Local smoke alarms monitored through SCADA.
Category 5	No fire detection or emergency warning requirement.

* Note: Fire Detection and Alarm systems shall comply fully with this specification and the requirements of AS1670.1 and the SAMFS conditions of connection to allow for future connection to the fire service, if this becomes a requirement.

4 Fire Detection and Alarm Systems

4.1 General Requirements

Fire detection and alarm systems shall be independent of any other building/plant monitoring and control system, with the Control and Indicating Equipment (CIE) contained within its own enclosure. Alarm and fault signals shall be displayed independently of the plant monitoring and control (SCADA) system, however, interface of alarm, fault or isolation signals required under Australian Standards is limited to status monitoring only.

Controls and indicators that form part of any associated systems shall also be contained within the same CIE enclosure, such as monitoring and control of:

- a. Air handling systems (air-conditioning shutdowns);
- b. Occupant Warning Systems (To alert occupants of a fire-alarm condition, or for emergency purposes); and
- c. Fire fan controls.

Depending on the Site Category (defined in section 3.2) new fire detection systems to be installed shall comprise:

1. A Main Fire Indicator Panel (Main FIP) to monitor all aspirated smoke detection systems, smoke/heat point type detection, other forms of fire detection, manual call points (MCPs), Sub-Fire Indicator Panels (SFIP), where installed, via a networked system (where applicable) covering other areas of site.
 2. Either of the following:
 - a. A Master Emergency Control Panel (MECP) or Emergency Warning Control and Indicating Equipment (EWCIE) to operate speakers located throughout all buildings where fire detection is provided and various locations outside in plant areas to alert occupants of either an emergency or automatic fire alarm. Red/Amber strobes shall be strategically located to give visual indication in areas where ambient sound levels are too high to hear the evacuation or alert tones clearly. Public Address (PA) functionality is also to be available for site-wide emergency announcements.
 - b. An Occupant Warning Control Panel (OWCP) to operate speakers located throughout all buildings where fire detection is provided, and various locations outside in plant areas to alert occupants of either an emergency or automatic fire alarm. Red/Amber strobes shall be strategically located to give visual indication in areas where ambient sound levels are too high to hear the evacuation or alert tones clearly. Public Address (PA) functionality is also to be available for site-wide emergency announcements.
 - c. Integral sounders, sounder bases or strobe lights driven from the FIP's addressable loop or dedicated 24V DC feed, located throughout all buildings where fire detection is provided and various locations outside in plant areas, to alert occupants of either an emergency or automatic fire alarm.
- Note: For nominated sites (namely, local fire detection systems monitored by SCADA only), Audible Alarm Devices (AAD) and Visual Alarm Devices (VAD) are to be provided for occupant warning in lieu of the above.
3. Alarm Signalling Equipment (ASE) located in the Main Fire Indicator Panel that is utilised to call the fire brigade (where nominated) on the initiation of a fire alarm signal.

The exception to the above are buildings outside the main plant boundary or for nominated buildings on selective plants where fire detection and warning is to be provided by local smoke alarms connected to SCADA, as specified.

For fire service appliances to access the site in the event of a fire alarm (or emergency response) facilities and protocol shall be determined for each site instance through the SA Water Security Department.

A Main FIP and MECP/EWCIE shall generally be located within the main entry foyer of an SA Water nominated building on site and must remain clearly visible and readily accessible to the firefighting service. The only exception is where the site is provided with a fire control room. Notwithstanding this, the location of the Main FIP and MECP/EWCIE shall comply with the requirements of the BCA, relevant Australian Standards and in agreement with the relevant fire authority. Wherever other Fire Indicator Panels are provided on site, they must also be in a similar location within the building (unless agreed otherwise with the fire service) and shall be identifiable by red strobe light placed on the outside of the building to assist fire services locating the designated building entry point.

Contained within each FIP, Zone Block Plans of the installation shall be provided, which contain the following information:

- a. The layout of the building in which the fire system is installed;
- b. The area covered by each zone;
- c. Detector locations;
- d. Fire brigade panel (normally within Main FIP);
- e. The location of the FIP, sub-indicator panels (SIP), mimics, data gathering panels and repeaters; and
- f. The location of any other CIE, including any sound systems for emergency purposes.

4.2 Automatic Fire Detection Systems

Building automatic fire detection systems shall be provided at each site in accordance with AS 1670.1, unless nominated for local smoke alarms only. Where required, each system may include, among other items, any of the following items:

- Master Fire Indicator Panel (or Main FIP)
- Data Gathering Fire Panels (DGPs)
- Sub Fire Indicator Panels (Sub FIP)
- Smoke and Heat Detection (to AS 7240.7 and AS 7240.5)
- Optical Beam Smoke Detection (to AS 7240.7)
- Other forms of fire detection not listed above
- Manual call points (MCP)
- Remote Indicators for concealed space detection (where not addressable)
- Multi-point aspirated smoke detectors (MASD)
- Linear Heat Detection (LHD) devices
- External Visual Alarm Indicators
- Automatic Signalling Equipment (ASE) where nominated for fire bridge monitoring
- Interfaces to third party equipment (i.e.) Gas Detection Systems, SCADA, etc.
- Building Automatic Air-Handling System shutdown (to AS 1668.1)

Where systems are monitored by the fire bridge they shall comply with the relevant authority (South Australian Metropolitan or County Fire Service) fire alarm conditions of connection.

4.2.1 Air-Handling System Shutdown

In specially nominated cases, the fire detection system shall provide an appropriate shutdown signal in the event of a fire to air handling systems, such as air conditioning or exhaust fans, via interface relays. These relays (where required) shall be installed adjacent to, or inside each switchboard related to the item to be shut down. Project specifications shall more fully define these requirements on a case-by-case basis.

Operation of a 'plant isolate' function shall inhibit air handling system shutdown. The cabling to air handling system shutdown relays shall be supervised for 'open circuit' condition and shall raise a fault if disconnected.

4.2.2 Occupant Warning

Where an automatic fire detection system is deemed necessary to be installed at a given site, at least one of the following shall be provided to alert occupants of a fire alarm situation depending on the category of system defined in section 3.2, whether manned / unmanned and other associated risks on site:

- a. An Emergency Warning System in accordance with AS 1670.4 (i.e. larger sites); or
- b. An Amplified Sound System (single zone OWS) or EWCIE (AS4428.16 Grade 3) complying with AS1670.1 (b) (i.e. medium sized sites); or
- c. Audible/Visual Alarm Devices complying with AS 1670.1 (b) (i.e. small/unmanned sites).

The operation of an Occupant Warning System (OWS) shall be automatic other than when the user interface for manual operation is used (in the case of a user-initiated evacuation event (MCP activation), testing or isolation of equipment).

All distributed and independent fire detection systems (Sub-FIPs) connected to a site's main FIP shall, as a minimum, initiate a local building/area evacuation through the emergency/occupant warning system, but shall also be configurable to activate a site-wide evacuation, as determined with stakeholders during detailed design.

For consistency of emergency evacuation tones, both the **ALERT** and **EVACUATION** signals generated by any of the above systems and/or audible alarm devices shall be the same across all sites.

4.2.3 Visual/Audible Alarm Devices

Where Audible Alarm Devices (AAD) and Visual Alarm Devices (VAD) are solely being provided in lieu of an emergency warning system, an amplified sound system (single zone OWS) or EWCIE (AS 4428.16 Grade 3), these shall comply with AS ISO 7240.3 and AS ISO 7240.23 respectively.

Audible Alarm Devices provided shall be able to be configurable for staged evacuation purposes with the functionality to generate both the 'ALERT' and 'EVACUATE' tones compliant with AS 1670.14. However, for occupant warning (Fire Alarm) the evacuation signal shall not be subject to any time delay after an automatic alarm condition has occurred i.e. alert time set to zero seconds.

Tones generated from AADs shall be synchronized so that signals generated from different sounders do not merge into one signal and be mistaken for a different alarm.

Visual Alarm Devices shall be provided to reinforce the evacuation signal in areas of high ambient noise levels and be coloured RED. VADs shall be labelled with the word "EVACUATE".

Where specified for Audible Alarm Devices (AADs) and/or Visual Alarm Devices (VADs), either sounders, beacons, sounder beacons and sounder beacon bases for use in conjunction with both conventional and addressable detectors can be installed, provided they meet the requirements of AS 1670.1.

4.2.4 Smoke/Heat Alarms

Where specified, local smoke/heat alarms within a building shall be inter-connectable mains-powered (with either a 10 year rated rechargeable lithium battery or permanently mounted 10 year rated lithium non-rechargeable battery), with one unit fitted with a relay base for a single "fire alarm" connection to SCADA. Smoke/heat Alarms provided shall comply with the requirement of AS 3786.

4.2.5 Point-Type Smoke and Heat Detectors

Point-type smoke and heat detectors installed in new installations shall be of addressable type, unless specified otherwise. When upgrading an existing fire detection system, direction is to be sought as to the extent of replacement of conventional detectors with addressable type.

Where detection is located within Hazardous Zones, detectors shall be intrinsically safe (I.S.) and wired through an I.S. Protocol Translator/ Galvanic Barrier installed in a suitable enclosure located outside the zone (safe area) to ensure system integrity.

Marine Grade detectors (or similar type) shall be provided in environments considered harsh for standard detectors. (e.g. in locations within 1 km of the ocean or atmospheres subject to corrosive gases such as Hydrogen Sulfide.)

Remote indicators shall be fitted as required and comply with the requirements of AS 1603.15. Where existing conventional detectors are being replaced with addressable type, remote indicators are to be retained where already installed.

4.2.6 Multi-point Aspirated Smoke Detection (MASD)

4.2.6.1 General

Where specified, a MASD based on 'absolute' smoke detection technology shall provide coverage in accordance with the spacing and location requirements of AS 1670.1.

A detailed design of the proposed layout shall be prepared, and approval sought from the Principal prior to installation. Initial alarm threshold sensitivity and delay settings shall be determined at design stage, following preliminary system modelling using the detection system supplier's proprietary software to confirm system operation.

Final alarm threshold sensitivity and delay settings shall be determined on site, based on the conditions within the detection area. A minimum of two (2) weeks MASD event history shall be extracted and viewed to confirm final configurations.

4.2.6.2 Detectors

Detectors shall comply with AS 7240.20 and be modular, with key field replaceable components such as:

- a. Aspirator;
- b. Detection Chamber;
- c. Filters; and
- d. Circuit boards.

Detectors shall incorporate ultrasonic flow monitoring and provide staged airflow faults and have the capability for in-field smoke chamber cleaning via a purpose-built internal aspirator to ensure and maintain absolute smoke detection.

4.2.6.3 Sampling Pipe

All sampling pipe shall be smooth bore. Typically, pipe with an outside diameter of 25mm and internal diameter of 21mm should be used.

The sampling pipe material shall be either PVC, ABS or HFT, and suitable for the environment in which it is to be installed, or be of the material as required by the Site Schedule.

All joints in the sampling pipe network must be air-tight and glued/secured using solvent cement suitable for the pipe selected. Pipe entry locations at the detector are not to be glued.

Pipe marking, including sample points, shall be identified in accordance with the requirements of AS 1670.1. All pipes should be suitably supported at 1.5m centres.

Expansion joints are to be accommodated within the pipe network where building expansion and contraction situations exist. Each pipe and branch pipe shall be fitted with an end-cap (test point) and made air-tight by using appropriate solvent cement installed at an accessible level, not requiring scissor and/or boom lifts.

The locations of sampling holes shall be determined at the design stage giving consideration to the environmental conditions and overall system configuration. Intervals may vary per modelling calculations. The maximum allowable separation distance should not exceed that as set down in local codes and standards.

Each sample hole shall be sized and countersunk (If required) in accordance with the manufacturer's instructions.

Capillary sampling devices shall be used for room space protection at ceiling level where a main sampling pipe can be concealed above. Ceiling spaces and under-floor voids shall use standard sampling methods. Capillary tube length is recommended to be a maximum of 500mm per tube. Capillary tube is to be clearly marked "Fire Detection System – Do Not Paint".

Air conditioning units shall have sampling points installed across the return air grilles. Sampling points shall be fitted facing downwards to avoid the ingress of dust or debris.

The sensitivity of each sampling point shall be not less than 2.5% obs/m.

Purge Valves shall be fitted to all pipework to allow for sampling points to be cleaned and units tested for future serving and maintenance.

4.2.7 Linear Heat Detection (LHD)

Where specified, Linear Heat Detection (LHD) cable may be installed where maintenance access is limited or where environmental conditions limit the use of other detection equipment.

LHD cable chosen shall be listed with Factory Mutual (FM) or Underwriters Laboratories (UL), temperature-selected to suit ambient conditions. For normal operation, fixed temperature LHD 68 °C shall be used. Concealed spaces and the like shall make use of 88 °C cable.

LHD cable shall be installed in accordance with manufacturer's recommendations.

LHD cable shall be affixed between 15 and 100 mm from the ceiling or roof structure using the manufacturer's recommended fixings. LHD shall be fixed at intervals no more than one metre apart. Catenary supports and fixings may be provided but care should be taken to ensure the maximum approved distance to the ceiling is not exceeded.

Connection to the fire detection system shall be via a suitable junction box within the protected area. When interfacing to an addressable system, a zone input module shall be used. LHD cable shall be terminated within the protected zone, without passing through other zones.

A 2 metre test loop shall be provided at the end of the circuit, adjacent the end-of-line junction box to allow testing in accordance with AS 1851.

4.2.8 Fire Indicator Panels

Fire Indicator Panels shall be of an analogue addressable type, networkable and conform to AS 7240.2, AS 7240.4 and AS 4428.3 (fire brigade panel), unless specified otherwise. For networkable systems, local Fire Detecting Control and Indicating Equipment (FDCIE) shall also be provided on all Sub Fire Indicator Panels in addition to that provided on the Main (Master)

Fire Indicator Panel. Data Gathering Fire Panels used for the purposes of cable junctions only, are not required to be provided with a FDCIE, and no controls shall be provided at the DGP.

Power Sources for all Fire Indicator Panels shall be as per AS 1670.1 Clause 3.16.

Alarm zone limitations and addressable circuits shall comply with AS 1670.1 Clause 2.3 with any networked or distributed FDCIE complying with AS 1670.1 Clauses 2.4 and 2.5 respectively. Any Fire Detection Panel and any detection loops shall be designed with a minimum of 25% spare capacity.

The Main FIP on site, were required to be monitored by the fire service, shall be directly connected to either the Metropolitan Fire Service (MFS) or Country Fire Service (CFS) via automatic Alarm Signalling Equipment (ASE). Existing fire detection system(s) shall be upgraded to comply fully with all current conditions of connection requirements for the respective fire service authority.

Regardless if being monitored by the fire service or a local system, the Main Fire Indicator at each site shall provide the following hardwired output signals to SCADA:

- Common fire alarm;
- Common fault; and
- Common isolation.

In addition to hardwired signals, for larger sites, a High-Level Interface (HLI) shall also provide the following output signals to SCADA:

- Individual fire alarm zone activation;
- Individual fire alarm zone fault; and
- Individual fire alarm zone isolation.

All fire indicator panels shall be installed within 6 metres of a door entrance, unless otherwise agreed with the fire service. External alarm indication shall be provided for all FDCIE or DGPs regardless if containing the fire brigade panel (i.e. Main FIP).

4.3 Emergency Warning Systems

4.3.1 General

An Emergency Warning System (EWS) in accordance with AS 1670.4 shall be a standalone installation. Control and Indicating Equipment (CIE), however, may be housed within the same enclosure as the FIP. For an amplified sound system (single zone OWS) or EWCIE (AS1670.16 Grade 3) these can be incorporated as part of Fire Detection Alarm System.

Where required, equipment shall include, but not be limited to the following:

- a. Master Emergency Control Panel (MECP);
- b. Emergency Warning Control and Indicating Equipment (EWCIE);
- c. Secondary Emergency Control Panel (SECP) (where required);
- d. Manual Emergency Call Points (ECP);
- e. Audible Warning Devices (AWD); and
- f. Visual Warning Devices (VWD).

The emergency warning system (EWS) or occupant warning system (OWS) facilitates both building occupant warning (fire alarm) and site-wide emergency evacuation/public announcement (PA) purposes. The system shall be capable of generating two different sounds over loudspeakers. The first tone being the **ALERT** signal (BEEP BEEP), which is a warning to people that there is a site-wide emergency (non-fire related), but to stay where they are and listen to any announcements for further instructions. The second tone being the **EVACUATION**

signal (WOOP WOOP), which is notification to people to evacuate the area and move to the designated muster point(s).

Unless otherwise agreed with stakeholders the EWS is to be configured to progress straight to the **EVACUATION** tone upon receipt of a Fire Alarm to effect a local building/area evacuation.

For building occupants warning, the EWS or OWS shall be initiated automatically by the fire alarm system. For other emergency situations and site-wide evacuations the system shall be capable of being initiated manually (through operator action) or be initiated automatically through activating a 'White' Emergency Call Point (ECP), where provided. The emergency warning system shall operate continuously during emergency conditions.

Provision of automated pre-recorded voice messaging on the installed warning system shall be provided to assist occupants in understanding the various fire alarm/emergency warning tones. It is important to note that SA Water intends on standardising the pre-recorded voice messages at all of its site assets across the state, to avoid confusion. Consult the Principal if there is any uncertainty on this aspect.

4.3.2 Emergency Control Panels

Emergency control panel(s) shall be installed in approved locations and shall comply with AS 4428.16 Grade 1 (or AS 2220.1 and AS 60849 until these standards are withdrawn) for AS 1670.4 systems. The MECP shall have full control of all zones across the whole site with CIE also to be provided for each SECP installed for control of local zones.

For Amplified Sound Systems (single zone OWS) or EWCIE (AS 4428.16 Grade 3) control panels shall comply with the requirements of AS 1670.1 and be provided with a hand-held microphone for Public Address (PA) annunciation.

The Main Emergency Control Panel (MECP) or Emergency Warning Control and Indicating Equipment (EWCIE) shall be integrated into the Main FIP, unless specified otherwise. Equipment racks may, however, be located remotely from the main operator console, if required. Secondary Emergency Control Panels (SECPs) shall be provided, where required.

Amplifier(s) shall be provided for each zone and be rated to suit the required load with a minimum of 30% spare power capacity. Failure of an amplifier or a fault on one line should not result in the failure of any other amplifier or loudspeaker circuit. Additionally, for AS 1670.4 systems, emergency control panels shall be fitted with 20% spare zone capacity.

For AS 1670.4 systems, the Main Emergency Control Panel (MECP) shall provide the following output signals to SCADA:

- Emergency evacuation system activated;
- Manual emergency call point activated;
- Emergency evacuation system fault;
- Emergency evacuation system isolated; and
- Mains power supply failure.

For Amplified Sound Systems (single zone OWS) or EWCIE (AS 4428.16 Grade 3) combined within the Fire Alarm Control Panel (FACP), the emergency warning system may activate 'Common' SCADA signals through the Main FIP instead. Where such equipment is in a standalone cabinet then separate SCADA signals shall be provided as indicated above for the MECP.

Power to Emergency Control Panels shall be as per AS 1670.4 Section 3 or AS 1670.1 Clause 3.16, where applicable, for the respective system being installed.

4.3.3 Audible Warning Devices

Audible warning devices consist of loudspeakers connected to dedicated amplifiers.

Audible alert and evacuation signals shall comply with AS 1670.4 or AS 1670.1 if used as a standalone occupant warning system. Other signals types may be more appropriate for use where the ambient noise may mask the audible signal.

Loudspeakers provided shall be suitable for EWIS (fire and evacuation) installation and those located in internal situations shall be cone/horn speakers rated IP51 as a minimum, and if exposed to water or harsh environments, rated not less than IP56. All external loudspeakers shall be of 12W Weatherproof IP67 rated. Loudspeakers shall be monitored for fault conditions.

Loudspeakers shall be subject to sound pressure level testing to confirm compliance to AS 1670.4 or AS 1670.1 which requires the sound pressure level to be exceeded by a minimum of 10dB the ambient sound pressure level and shall not be less than 65dB and not more than 105dB. Where more than one SPL measurement is required within the evacuation zone, the difference between the minimum and maximum shall not exceed 15dB.

The exception to the above sound pressure level requirement will be for loudspeakers indicated for outside areas, where satisfactory levels will be determined via testing, in conjunction with both the Principal and site stakeholders. Noise generation from audible alarms must take into consideration any impact on the local community.

The temporal patterns and pre-recorded voice messages output from loudspeakers shall be synchronized throughout an emergency zone and adjacent area except where the sound pressure level from an adjacent area is at least 30 dB lower.

4.3.4 Visual Warning Devices

Unless otherwise specified, visual warning devices shall consist of dual amber/red strobe lights (ideally LED beacons). Visual warning devices shall comply with AS 1603.11.

Internal warning devices shall be rated IP43 as a minimum and if exposed to water or harsh environments, rated at not less than IP56. All external warning devices shall be rated IP65 (Weatherproof).

Visual warning devices (generally for areas of high ambient noise levels) reinforcing the alert and evacuate signals shall have a label on or next to the device with the words ALERT and EVACUATE in letters not less than 25 mm height in a contrasting colour to the background. For outside visual warning devices, larger signage shall be provided, as appropriate to the site.

4.3.5 Remote Paging Console(s)

Where either an emergency warning system (EWS) or an Amplified Sound System (single zone OWS) or EWCIE (AS 4428.16 Grade 3) is being provided at any given site, equipment shall have the functionality for connection of Remote Paging Consoles (RPCs) for the provision of general PA announcement purposes.

4.3.6 Manual Call Points

SA Water defines 'break glass' pushbutton call points as either a:

1. **Manual call point** (MCP) – interconnected with the **Fire Alarm** and fire brigade notification system. (**RED** in colour); or
2. **Manual emergency call point** – interconnected with the **Emergency Warning** System (EWS) only. (**WHITE** in colour).

Where Manual Call Points or Manual Emergency Call Points are subject to outdoor or harsh environments (i.e. H2S gases) they shall be a weatherproof type, of rating at, or above, IP67.

Manual call points are for the initiation of a fire condition and shall be installed in clearly visible and accessible locations (i.e. building exit points). If not indicated, one shall be provided inside the main entrance area of each building and may be located on the FDCIE if positioned within that area.

Manual call points (MCPs) shall be provided which comply with AS 1603.5, coloured RED and be clearly labelled "FIRE ALARM".

Manual emergency call points are for local (non-fire brigade call) site-wide emergency evacuation purposes, generally provided for larger sites in key locations only (i.e. within main

control rooms). Where specified, they shall be interconnected with the emergency evacuation system (EWS), Amplified Sound System (single zone OWS) or EWIS (AS 4428.16 Grade 3) and shall indicate the area/zone originating the call and activate the ALERT tone and AMBER strobe lights, however, they shall not call the MFS/CFS.

Manual emergency call points (ECPs) shall also comply with AS 1603.5 with the exception that they are coloured WHITE and are clearly labelled "EMERGENCY ALARM". An engraved multi-layered Phenolic plastic sheet, such as Gravoply, Rowmark, or approved equivalent label shall be installed above the unit indicating "LOCAL EMERGENCY ALARM" in black letters not less than 25 mm height, on a white background.

4.4 Exit and Emergency Lighting

Exit and Emergency lighting shall be installed throughout all buildings locations as specified in compliance with BCA requirements, AS/NZS 2293.1 and AS/NZS 2293.3.

Upon failure of the electrical supply to the normal lighting in an area, irrespective of whether or not it is illuminated, each relevant emergency escape luminaire and exit sign shall be energized from its emergency supply in accordance with AS/NZS 2293.3.

Where new lighting sub-circuits are required to be installed, 90-minute discharge timers with test facility shall be fitted to distribution switchboards where not currently installed. An Emergency Test Switch is an emergency test timer (90-minute discharge) as well as a circuit monitoring device which complies to AS 2293.1:2005 Sensing of supply failure (2.3.3).

Where Exit and Emergency lighting do not have a dedicated sub-circuit, fittings shall be supplied that comply with AS/NZS 2293.3 clause 4.5. This clause applies to emergency escape luminaires and exit signs which are provided with self-contained, automatic facilities for discharge testing (i.e.) fully stand-alone systems.

Where externally located, exposed to water or for any harsh environment, an IP65 weatherproof case shall be fitted to any standard exit lighting or an alternative unit, suitably rated, is to be sourced. Unless located in an office environment, all internally located emergency lighting is to be rated IP65, unless indicated otherwise.

All emergency luminaires shall:

1. Be of the self-contained type.
2. Provide a green charge indicator LED (Light Emitting Diode).
3. Provide a status indicator LED which shall provide battery and lamp feedback.
4. Be rated for a ten (10) year design life (including electronics and LED).
5. Incorporate Lithium batteries with a design life of ten (10) years when operated in accordance with manufacturer's directions and specification.
6. Be tested to comply with a mutually recognised testing laboratory to the relevant scope of AS CISPR 15, AS/NZS 60598.2.22 and AS/NZS IEC 61347.2.13.

All exit luminaires shall:

1. Be of the self-contained type.
2. Provide a green charge indicator LED (Light Emitting Diode).
3. Provide a status indicator LED which shall provide battery and lamp feedback.
4. The emergency exit sign (pictorial 'running man' type) shall be designed for a ten (10) year design life, including the electronics and LEDs.
5. Incorporate Lithium batteries with a design life of ten (10) years when operated in accordance with manufacturer's directions and specification.

6. Incorporate a soft-start charger function.
7. Be the permanently maintained type, utilising LEDs with expected lifetime of 100,000 hours to L70/B50.
8. Incorporate green and white pictograph and directional arrows, as required (or green letters on black background when used in areas of low illumination).
9. Be tested to comply with a mutually recognised testing laboratory to the relevant scope of AS CISPR 15, AS/NZS 60598.2.22 and AS/NZS IEC 61347.2.13.

Battery Specific Requirements:

1. Batteries for single point emergency luminaries shall be of a Lithium ion Phosphate type with a maximum cell temperature not less than 60 °C.
2. The design life of the batteries and their application in the emergency and exit luminaire shall be designed for ten (10) years at a cell temperature of 45°C.
3. Battery packs must incorporate battery protection (for over voltage in charge, low voltage protection and over current in discharge) and shall be labelled with date of manufacture, amp hour (Ah) rating and replacement part number.

4.5 Exit Doors

All exit doors relating to the intended emergency exit paths from a facility shall be designed (or if existing, modified/altered) such that they are in accordance with the Building Code of Australia, or if not practical, a performance solution be provided by a qualified fire engineer that demonstrates compliance with the relevant performance requirements. All doorhandle hardware requiring locking is to be fitted with new barrels supplied from an SA Water nominated locksmith. Key type shall be determined with site stakeholders.

4.6 Gas Detection Systems

Where specified by the Site Schedule, fire/emergency warning systems shall provide a connection point to existing site Gas Detection Systems (i.e. Chlorine, Oxygen, Methane and H₂S alarm systems), where provided. As a minimum, a single alarm output shall be provided from the Gas Detection System to activate the EWS warning signal 'ALERT' tone and 'AMBER' strobe lights within the affected area of the plant. The fire system shall NOT be configured to call the Metropolitan Fire Service (MFS) or Country Fire Service (CFS), but act as a local alarm indication only.

Subject to a risk assessment, additional trigger levels (i.e. high-level gas leak) shall also be provided from the Gas Detection System to escalate the EWS to a site-wide evacuation ('EVACUATION' tone and 'RED' strobe lights), and, if required, send a primary alarm (separate indication to Fire) through the ASE for emergency service attendance (i.e. HAZMAT).

4.7 SCADA

As a minimum, output signals shall be hardwired from the Main Fire Indicator Panel and the Main Emergency Control Panel (MECP) to the plant PLC and/or RTU, for integration of alarms to SCADA.

For larger sites 'Individual Zone Indication' is also required, and these signals may be obtained via providing a High-Level Interface (HLI) from the site Main Fire Indicator Panel (or from a Data Gathering Panel, if system is networked). Critical 'Common Alarm' signals, however, must be hardwired for redundancy. Where there are Main and Sub panel HLIs, and hardwired signals, logic must be implemented to avoid multiple alarms in SCADA for the one zone fault.

The recommended HLI communication is Modbus (either serial or TCP/IP) via a suitable Protocol Converter fitted between both PLC/SCADA and FIP. The preference for the protocol converter is for it to be mounted in the FIP.

The SCADA System modifications shall comply with the latest SA Water SCADA System Technical Standards and manuals, and be undertaken by an authorised SA Water Systems Integrator.

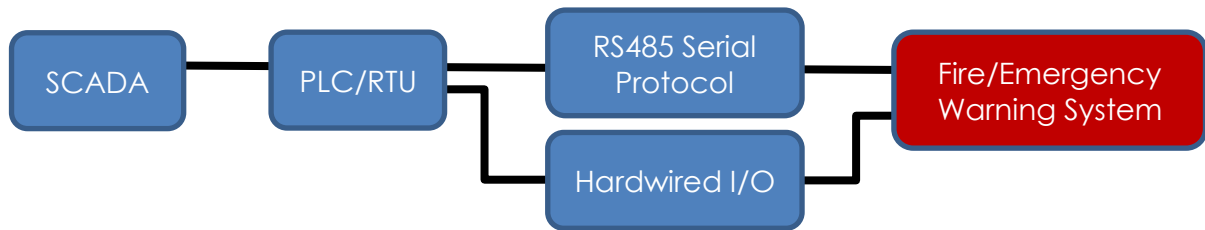

Figure 4-1 – Control System Boundaries

No control shall be directed through SCADA. Functionality shall only be conducted through the CIE of both the Fire Detection and Emergency Warning Systems. Fire alarms are, however, to escalate through the existing SCADA network. Screen(s) shall be configured, where required, to display the following information:

1. Fire/Emergency Warning System Overview

General system status for both the Fire Alarm System and Emergency Warning System. For larger sites, a visual site overview of the plant showing each building alarm state (RED - Fire / GREY – Normal) shall be displayed. Consideration should be given to replicating Block Plans on SCADA screens to maintain consistency throughout the entire SA Water SCADA system.

2. Fire System Zone Status

For larger sites, a detailed status of each fire zone from the FIP indicating if it is in ALARM, FAULT or has been ISOLATED, shall be displayed.

As a general rule:

- a. Indications should always open a tag popup BDF and/or perform navigation to an alarms display page, in a similar fashion to other SCADA device indications like pumps as an example.
- b. SCADA tags should have an defined syntax, and descriptions.
- c. The links to the fire/evacuation system pages should be located on the individual plant main menu page.

5 Fire Detection and Emergency Warning System Installation

The construction and installation of fire detection systems and sound and intercom systems shall comply with the requirements of TS 0300, SAMFS Policy 037, AS/NZS 3000, AS/NZS 3013, AS 1670.1 and AS 1670.4 and the following additional requirements.

Minimum qualifications of installation contractors should be as follows:

- Cabling licence
- Registered with SAMFS as competent fire safety technician
- Ideal qualifications are as follows:
 - FPA registration number
 - NFIA registration number

5.1 Cabling

All network cabling shall have a rating of WS52XW (fire rated 120min and resistance to water) with mechanical protection in accordance with and AS 1670.1-Appendix B and AS 1670.4-Appendix C. Mechanical rating to be upgraded dependent upon the hazard, as defined in AS/NZS 3013, and additionally, if exposed to damage from vermin (namely within underground conduits and pits) cabling shall be steel wired armoured for protection.

Customer cabling, including extra-low voltage power supply wiring of the fire detection and alarm system, shall be kept separate and distinct from all other systems and shall be in accordance with the requirements of AS/CA S009.

The wiring of amplified sound systems is deemed to be 'customer cabling' and shall meet the requirements of AS/CA S009 and requires separation from either low voltage (LV) or extra-low voltage (ELV) circuits, depending on their operating voltage, in accordance with this standard and AS 1670.1.

5.2 Electrical Installation for Hazardous Areas

Electrical equipment installed in Hazardous Areas shall be appropriately rated for the area in which they are installed and the protection technique of the associated equipment. Installations shall comply with the requirements of AS/NZS 60079.14 Explosive atmospheres - Electrical installations design, selection and erection and TS 0300.

5.3 Labelling and Marking

All detectors shall be marked with permanent labels indicating Alarm Zone (or Circuit/Zone number), device number and type of detector for each installed device. Labels shall be of the printed type. An example being:

AZ1 - L2 - 004P - Alarm zone one, loop two, device four and photo optical smoke detector.

Note: Identification on the detector is to be consistent with the information displayed at the FIP. The Block Plan legend and the device number shall read the same as the display on the FIP.

All break glass units shall be labelled with zone, loop and address number on permanently printed labels.

Loop powered strobes shall be labelled as appropriate. Supply air detectors shall be provided with permanent engraved labels stating the zone in addition to the loop and address detail.

All air handling shutdown and interface relays shall be labelled accordingly. Where provided inside mechanical services switchboards, relays shall be labelled within and on the cabinet door stating: 'Fire Alarm Relay within'.

All 230 V AC supplies and labelling shall comply with AS/NZS 3000 and be marked accordingly so that they are easily distinguished from ELV circuits. The 230 V supply breaker at the main switchboard shall be marked with a permanently engraved label stating: 'FIRE ALARM' in text 10 mm high (minimum). An origin of supply label shall be fitted to the fire panel.

Cable labelling for fire system components shall be as per AS1670 standards. Any cables interfacing from external systems to fire systems shall follow the conventions of TS 0300.

5.4 Documentation

5.4.1 Coloured Zone Block Plan

A zone block plan is required to be provided as per AS 1670.1. The block plan is required to be A3 or A4 sized, as appropriate.

The plan is to identify each zone protected via individual shades of colours that are not similar to adjacent colours. The main fire indicator panel, sub-indicator panels, mimics and repeater panels are to be shown on the plan. The plan is also to show any warning systems and intercom systems. Refer to 5.6 Appendix A for an example of what is expected.

The block plan shall be clearly legible without the need to 'interpret' the information within and should display room names or areas to clearly identify where the alarm is located.

The block plan is to be displayed in the correct orientation of the building from the point it is being viewed.

Emergency telephone numbers shall be included on the plan.

For more detail on the requirements of Block Plans, refer to SAMFS Policy 037.

All main switchboard locations shall be shown.

A3 or A4 sub-plans shall be supplied at FIPs, with details including detector location, address and zone information.

Any proprietary drawings supplied must either be converted onto an SA Water drawing template or, if not available in CAD format, be mapped onto an SA Water drawing template to allow an assigned drawing number to be referenced in the SA Water drawing systems.

5.4.2 Fire Indicator Panel Configuration Data

A copy of any software configuration files shall be included in electronic format within each Operator Handbook/Maintenance Manual. An additional copy of the software shall be provided for storage by the Principal.

A scanned copy of all device tests shall be obtained from the site monitoring system and shall be included in final commissioning documents. This shall show all devices tested and necessary commissioning tests, as required by AS 1670 series standards.

5.4.3 Log Books

Log books shall be supplied with all new systems. These shall meet with the requirements stated in AS 1851.

5.5 Testing and Commissioning

The Contractor shall test and commission all systems and equipment in accordance with the requirements of the applicable Australian Standards to ensure correct operation. Further testing shall be carried out where required by official bodies having jurisdiction. Note that all detectors, sampling points, speakers, devices, inputs, outputs, relays and hardware shall be fully tested.

The following data and compliance certifications should be provided, as a minimum, at the completion of commissioning:

- Commissioning results of sound pressure level testing;
- Certification that the cabling complies with AS/CA S009;
- Completed AS1670.1 Appendix E; and
- Form 2 associated with the installation.

5.6 Operator Training

Every new FD&EE system installed shall be accompanied with sufficient operator training for nominated SA Water specified representatives.

Training courses shall be of suitable duration for explanation and understanding of the installed systems and are to be conducted within one week of the system being commissioned when it is in full operation.

The training shall include Operator Handbooks to all trainees, per TS 0132, detailing all essential information, including all necessary drawings, charts, notes and support information.

Appendix A – Coloured Zone Block Plan Examples

The following figures in this appendix provide an example of what is expected in a Block Plan.

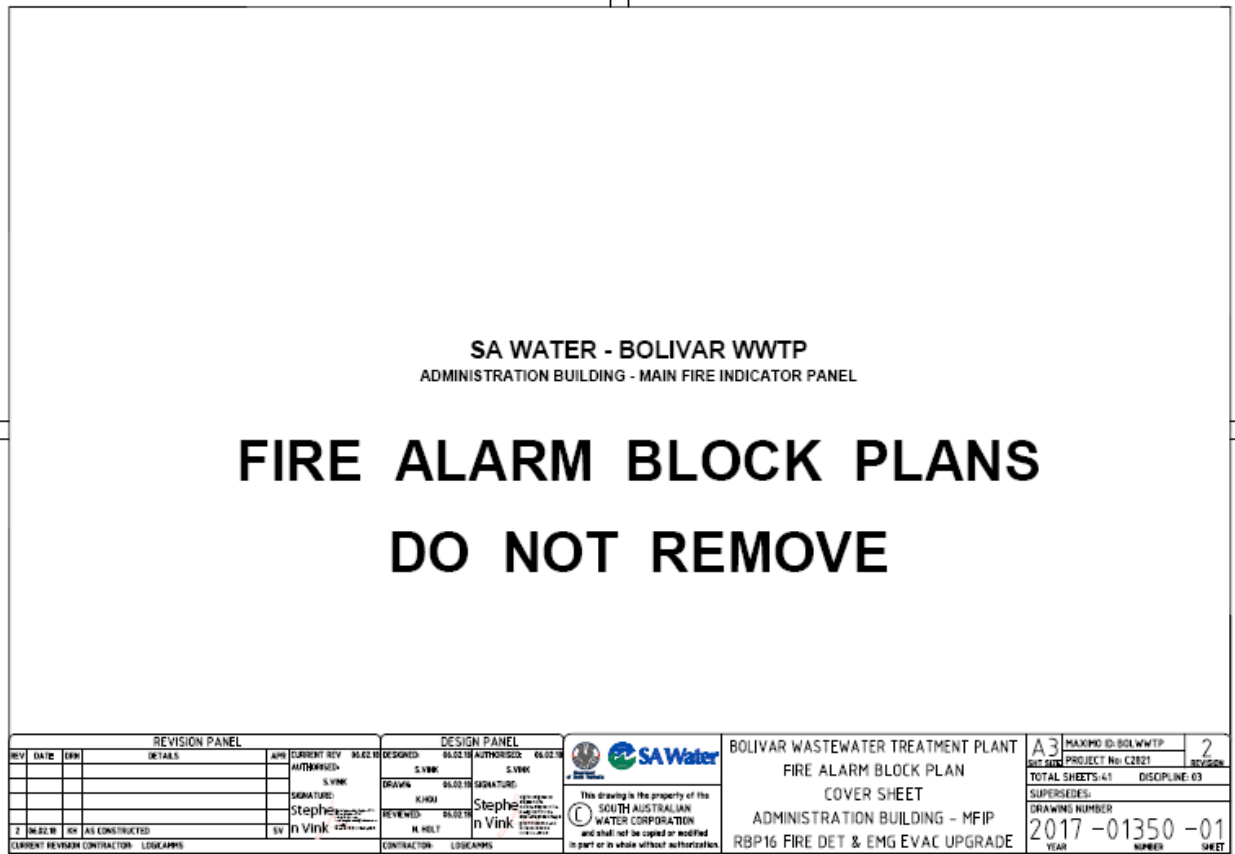

Figure 5-1 - Block Plan Example (1 of 9)

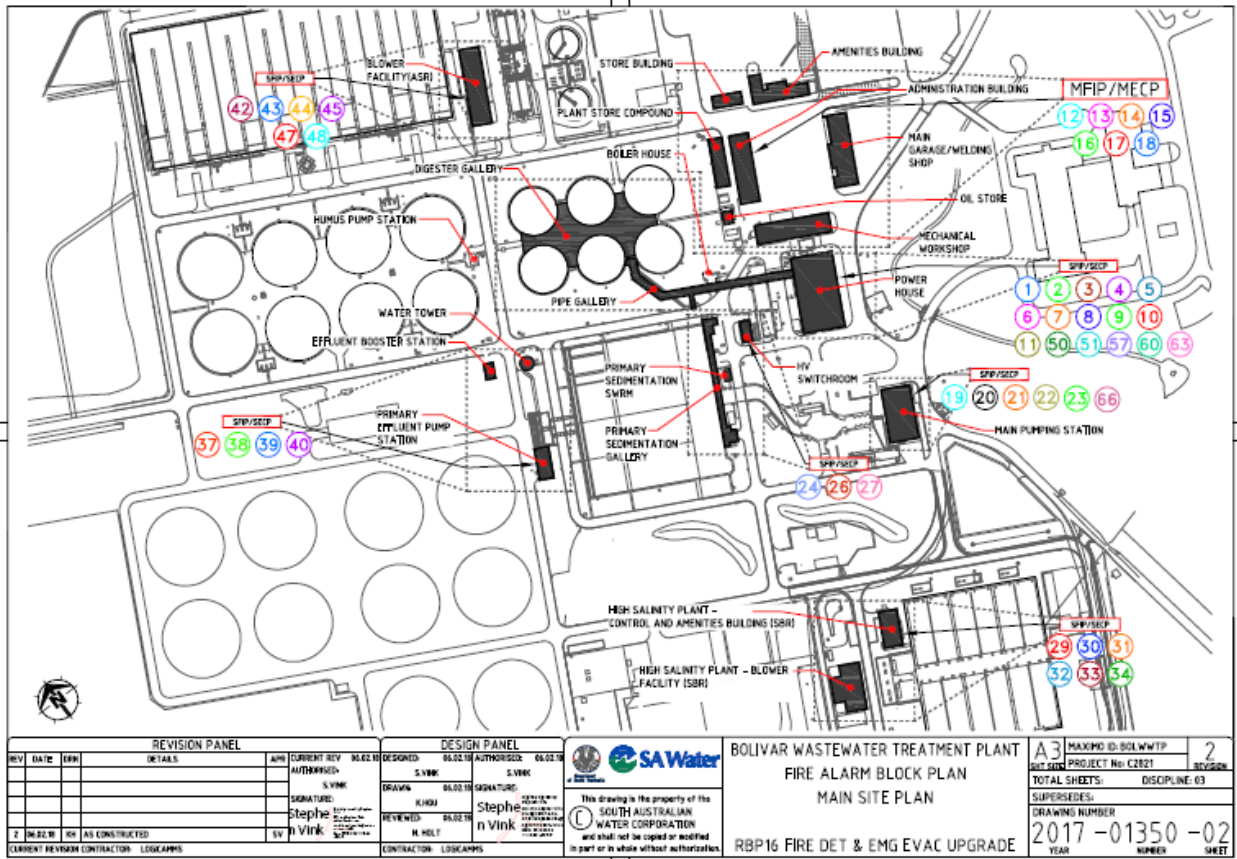

Figure 5-2 - Block Plan Example (2 of 9)

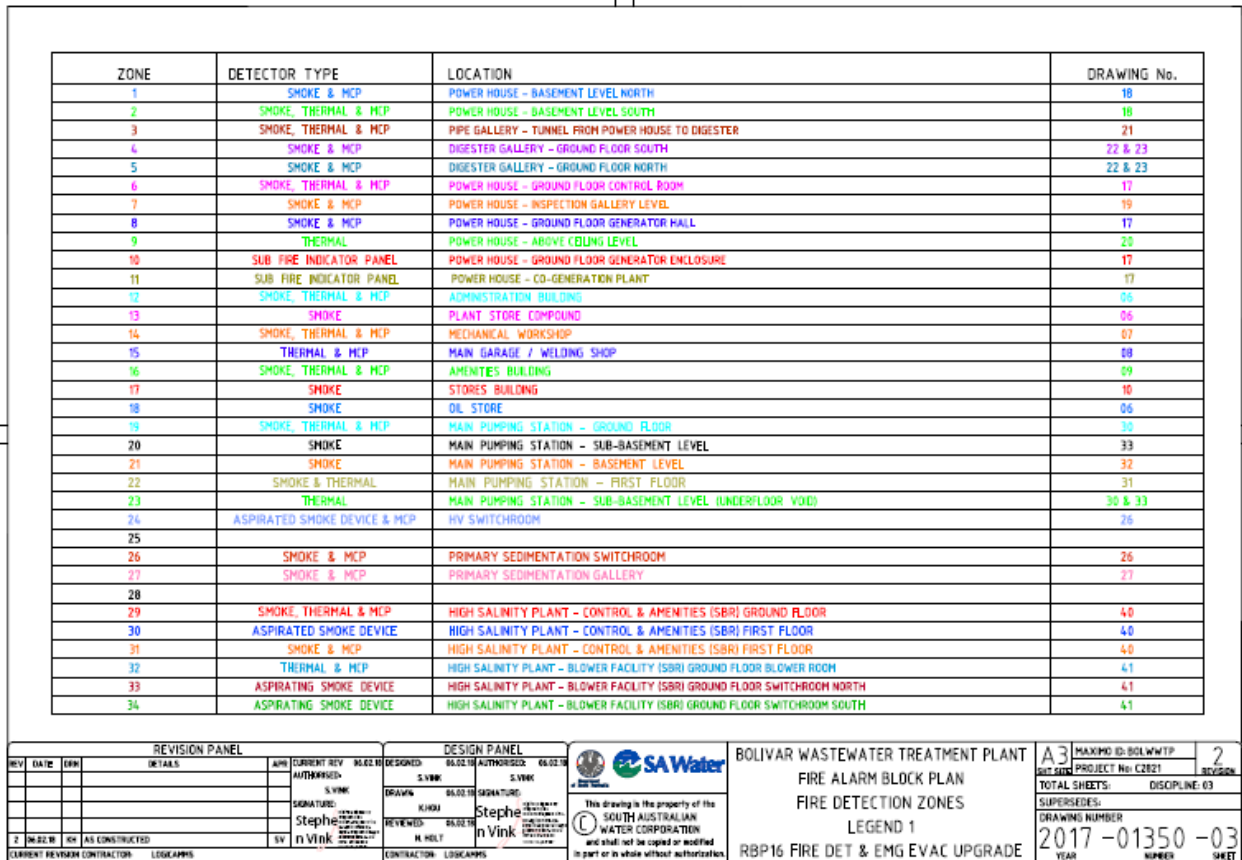

Figure 5-3 - Block Plan Example (3 of 9)

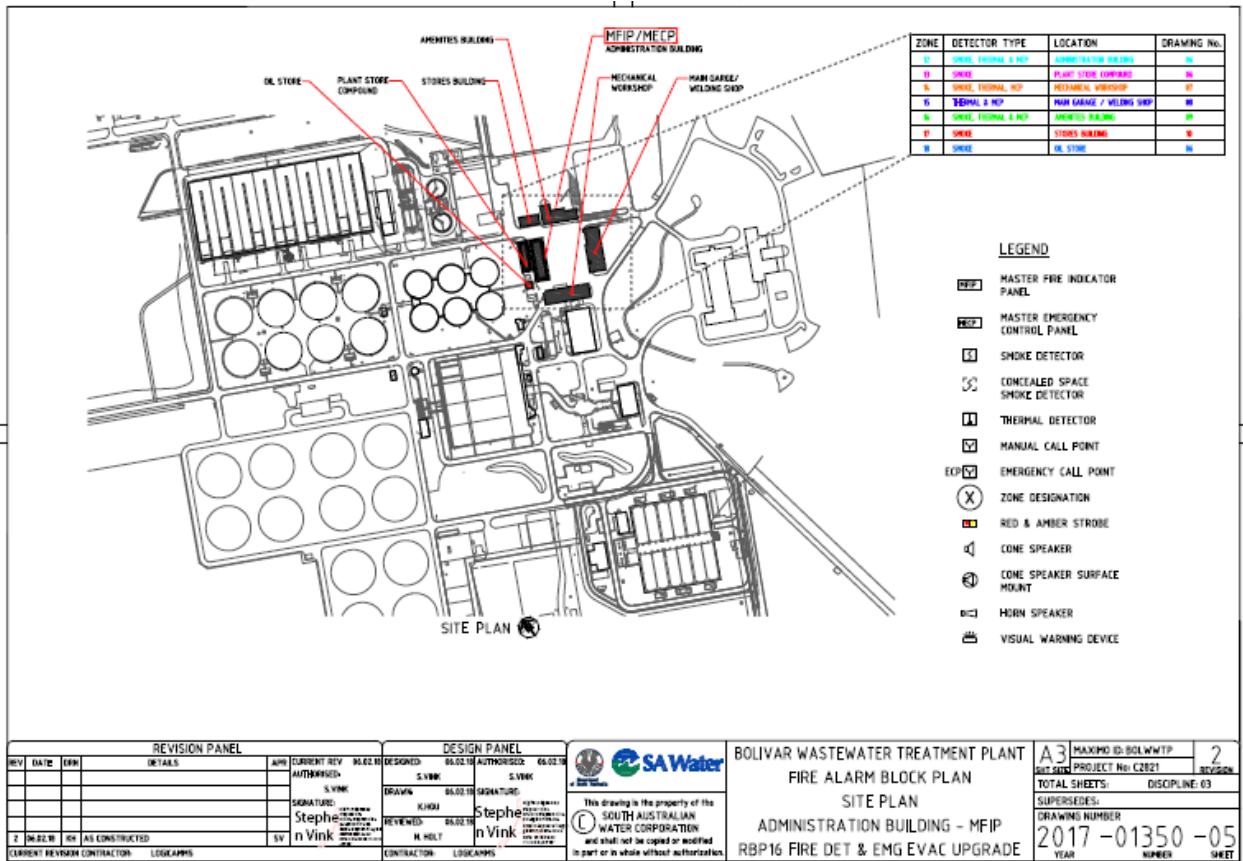

Figure 5-4 - Block Plan Example (4 of 9)



Figure 5-5 - Block Plan Example (5 of 9)

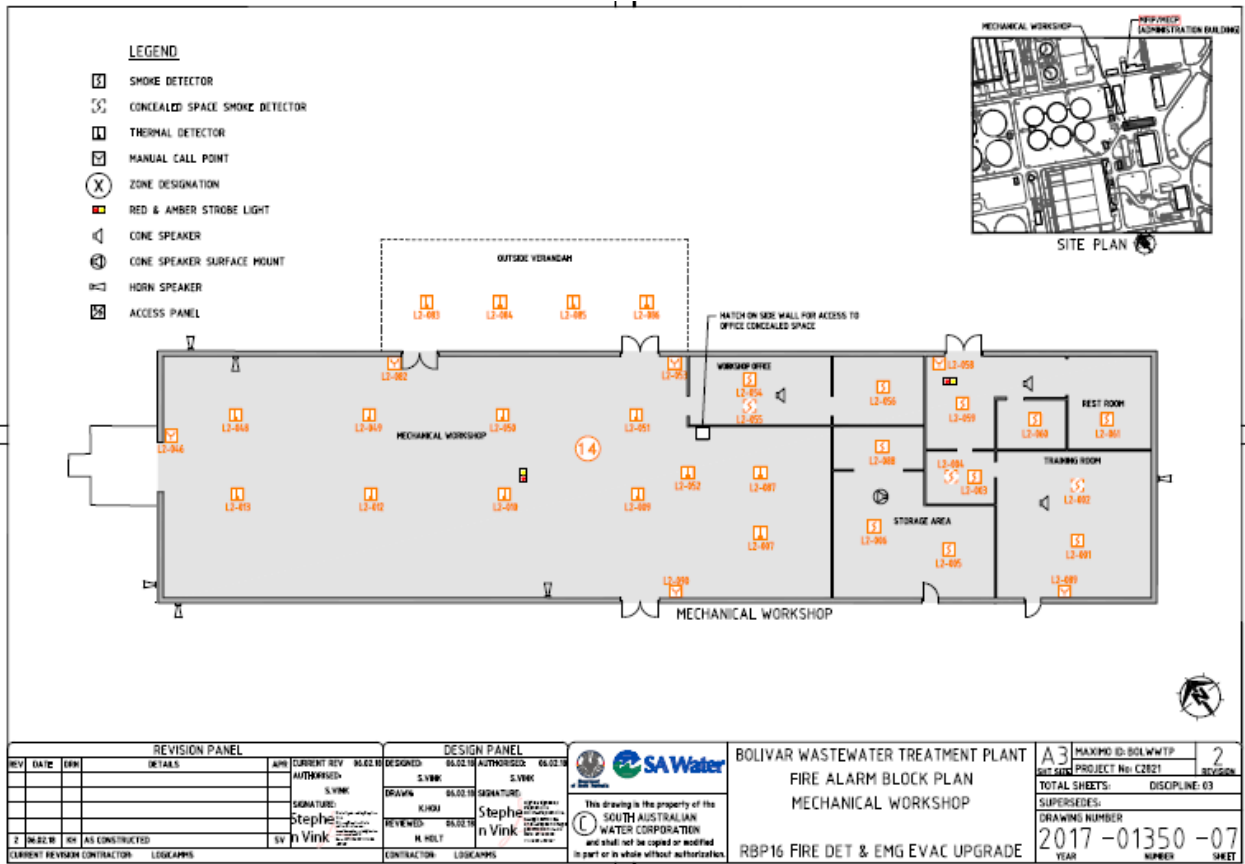

Figure 5-6 - Block Plan Example (6 of 9)

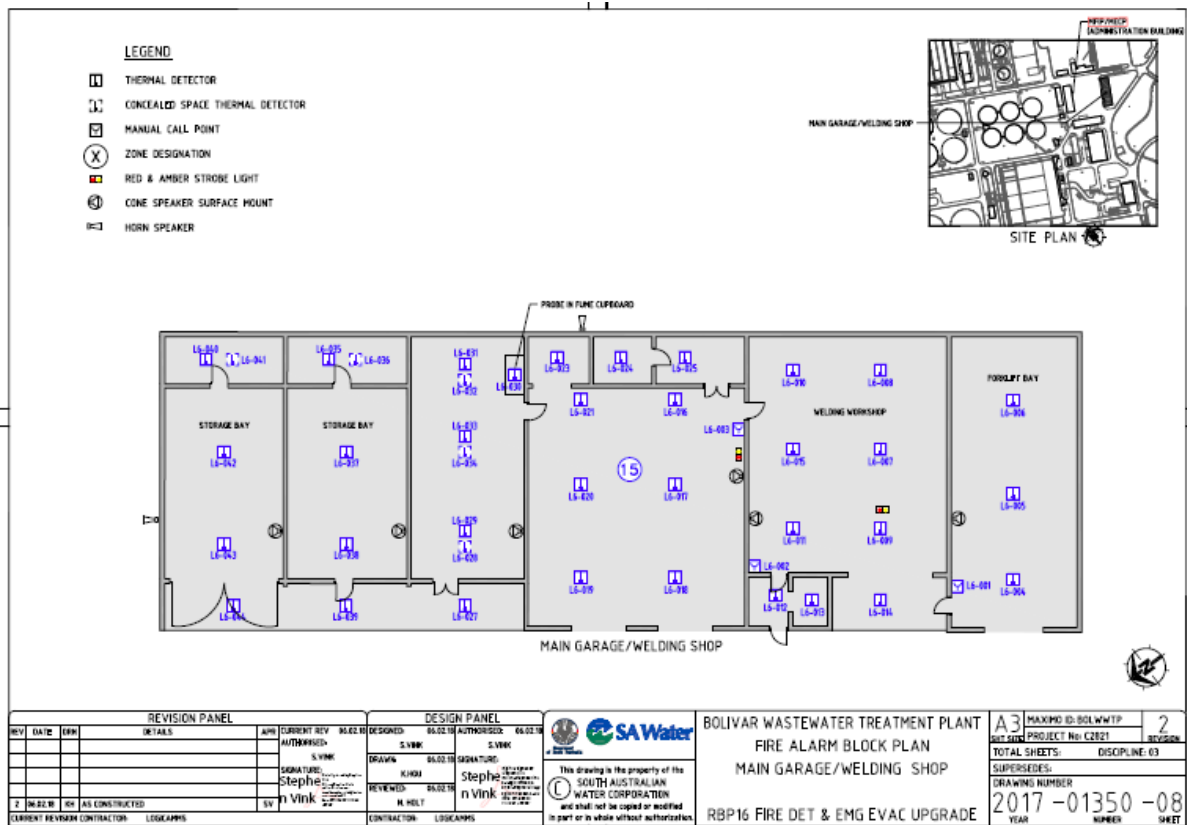

Figure 5-7 - Block Plan Example (7 of 9)

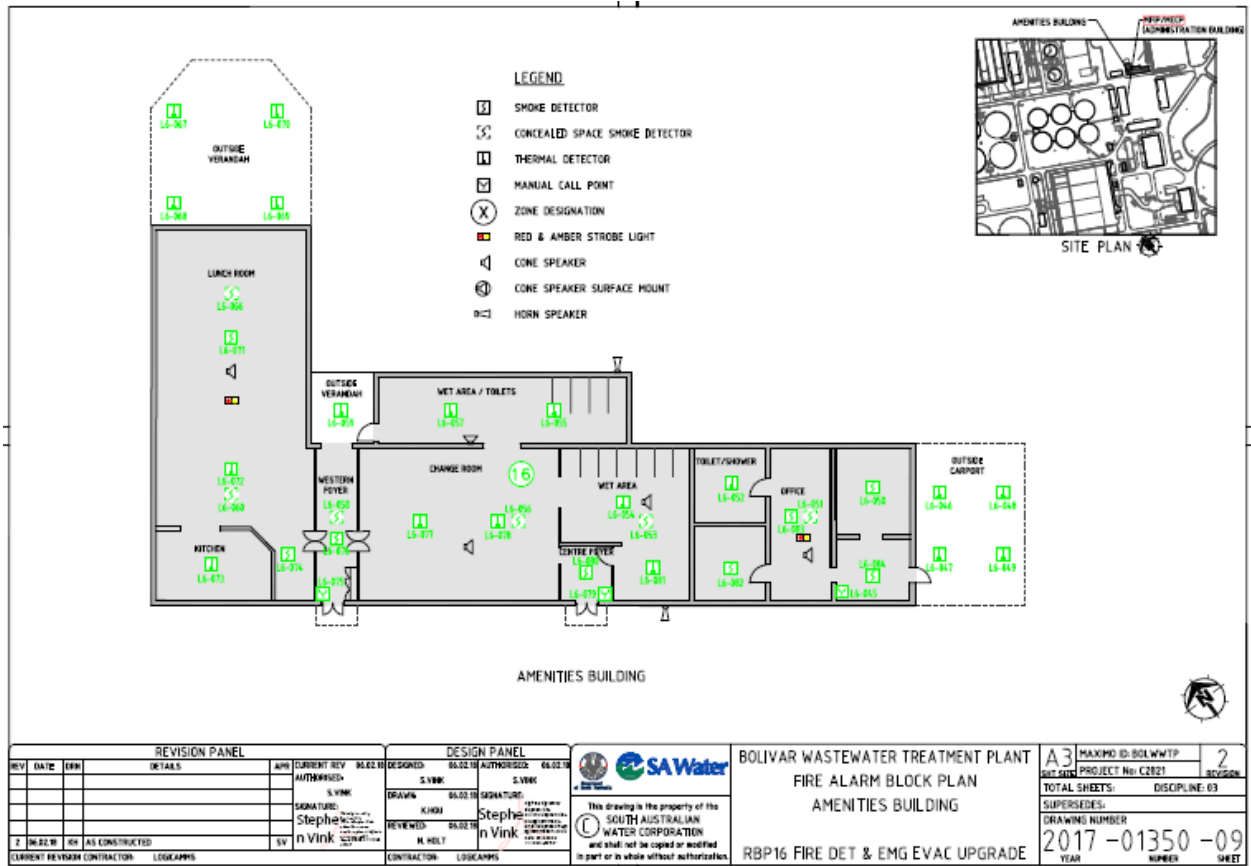

Figure 5-8 - Block Plan Example (8 of 9)

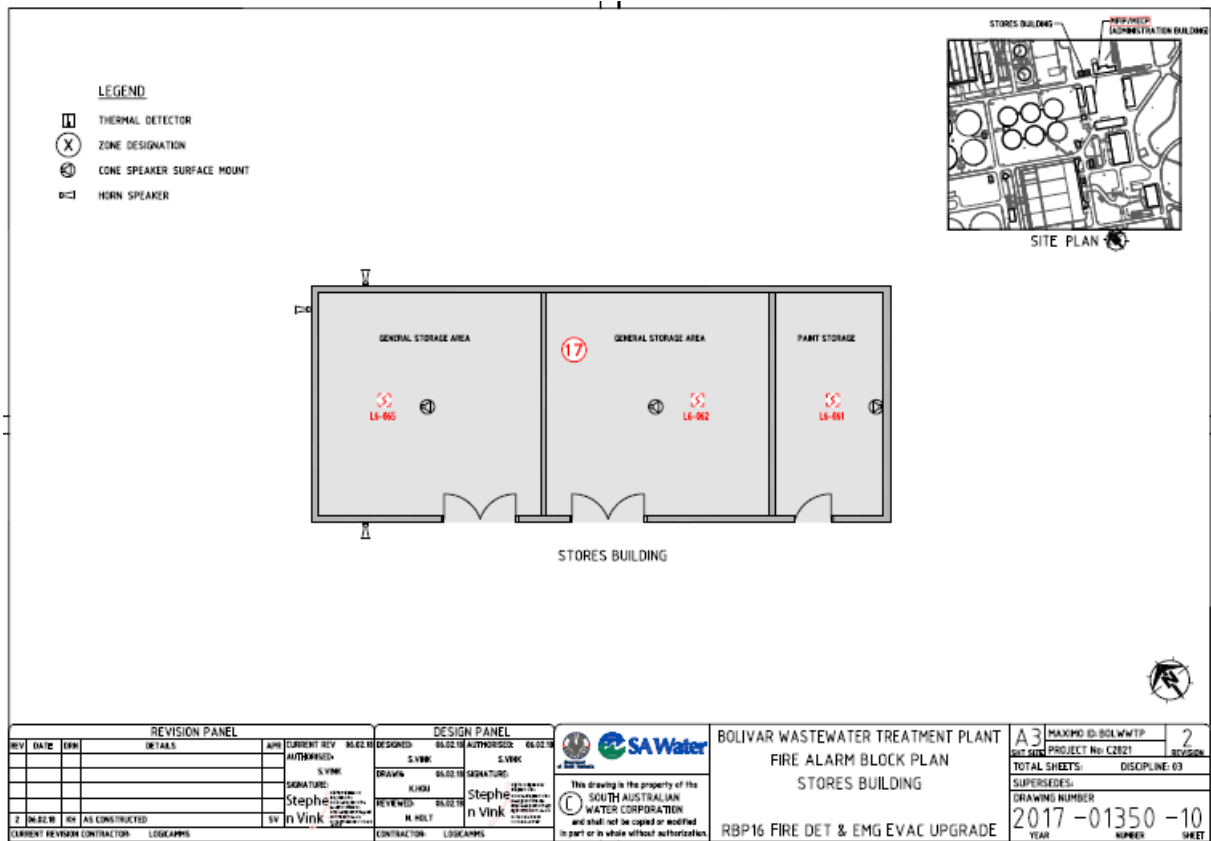

Figure 5-9 - Block Plan Example (9 of 9)

Appendix B – Fire and Evacuation Drawing Examples

The following figures in this appendix provide a sample of what might be expected for Fire Detection and Emergency Evacuation Electrical Drawings.

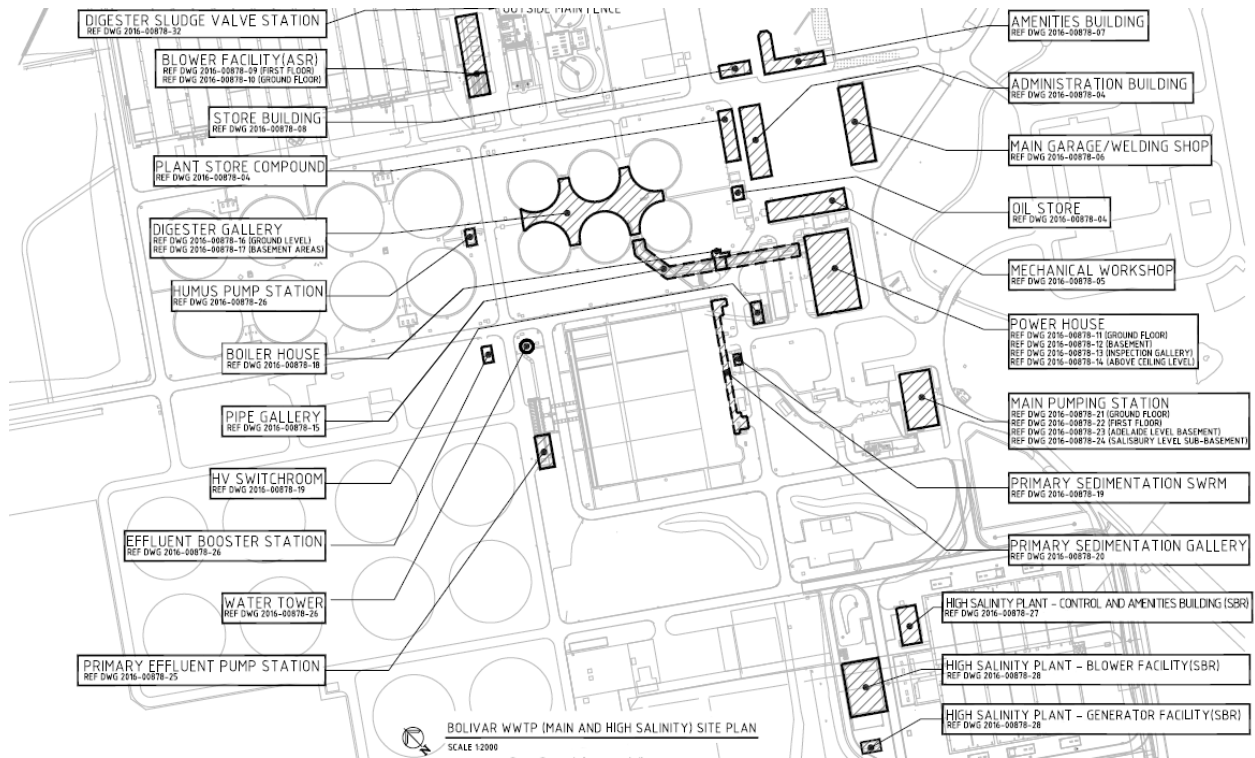

Figure 5-10 - Site Plan Example

FIRE & EVACUATION LEGEND	
[Symbol]	HEAT DETECTOR
[Symbol]	HEAT DETECTOR IN CONCEALED SPACE
[Symbol]	HEAT DETECTOR WITH AUDIBLE ALARM
[Symbol]	CONCEALED HEAT DETECTOR WITH REMOTE INDICATOR
[Symbol]	SMOKE DETECTOR
[Symbol]	SMOKE DETECTOR IN CONCEALED SPACE
[Symbol]	SMOKE DETECTOR WITH AUDIBLE ALARM
[Symbol]	CONCEALED SMOKE DETECTOR WITH REMOTE INDICATOR
[Symbol]	OPTICAL BEAM TYPE SMOKE TRANSMITTER
[Symbol]	OPTICAL BEAM TYPE SMOKE RECEIVER
[Symbol]	SMOKE DETECTOR DUCT PROBE
[Symbol]	FLAME DETECTOR
[Symbol]	OCCUPANT WARNING CONE SPEAKER
[Symbol]	OCCUPANT WARNING CONE SPEAKER IN SURFACE MOUNTED BOX
[Symbol]	AUDIBLE ALARM DEVICE
[Symbol]	OCCUPANT WARNING HORN SPEAKER
[Symbol]	WARNING SIREN/SOUNDER
[Symbol]	FIRE VISUAL WARNING DEVICE
[Symbol]	WARNING BEACON/STROBE
[Symbol]	STROBE LIGHT - ALARM SOUNDER COMBINED
[Symbol]	FIRE ALARM BELL
[Symbol]	MANUAL CALL POINT (IP65)
[Symbol]	WHITE EVACUATION CALL POINT (EMERGENCY)
[Symbol]	GREEN EMERGENCY DOOR RELEASE
[Symbol]	OLD EMERGENCY EVACUATION CALL POINT
[Symbol]	OLD WHOLE SITE EVACUATION PUSH BUTTON
[Symbol]	WARDEN INTERCOMMUNICATION POINT (WIP)
[Symbol]	RED & AMBER STROBE LIGHT (EMERGENCY WARNING SYSTEM)
[Symbol]	ASPIRATED SMOKE DETECTOR SAMPLING POINT
[Symbol]	EXISTING TELEMETRY INTERFACE
[Symbol]	REMOTE SIREN
[Symbol]	DISTRIBUTION BOARD
[Symbol]	ZONE MONITOR FOR CONVENTIONAL DETECTION
[Symbol]	REMOTE PAGING CONSOLE
[Symbol]	ASPIRATED SMOKE DETECTOR
[Symbol]	DATA GATHERING PANEL
[Symbol]	END OF LINE DEVICE
[Symbol]	EMERGENCY WARNING CONTROL & INDICATING EQUIPMENT
[Symbol]	FIRE BRIGADE PANEL
[Symbol]	FIRE DETECTION CONTROL & INDICATING EQUIPMENT
[Symbol]	GAS DETECTION PANEL
[Symbol]	INPUT/OUTPUT UNIT
[Symbol]	INTRINSICALLY SAFE BARRIER
[Symbol]	ALARM SIGNALLING EQUIPMENT

FIRE & EVACUATION LEGEND	
[Symbol]	MASTER EMERGENCY CONTROL PANEL
[Symbol]	MAIN DISTRIBUTION FRAME
[Symbol]	MAIN FIRE INDICATOR PANEL
[Symbol]	FIRE ALARM MIMIC PANEL
[Symbol]	RS485 PROTOCOL CONVERTER
[Symbol]	SECONDARY EMERGENCY CONTROL PANEL
[Symbol]	SUB-FIRE INDICATOR PANEL
[Symbol]	SHORT CIRCUIT ISOLATOR
[Symbol]	ZONE MONITOR
[Symbol]	MAINS POWERED SMOKE ALARM

EMERGENCY LIGHTING LEGEND	
[Symbol]	MAINTAINED EMERGENCY EXIT LIGHT WITH RUNNING MAIN FITTING, LED TYPE C/W SELF TESTING CAPABILITY. LINE ON ONE OR BOTH SIDES DENOTES SINGLE OR DOUBLE SIDED
[Symbol]	AS ABOVE, ARROW DENOTES DIRECTION OF TRAVEL
[Symbol]	EXISTING EXIT LIGHT (OLD STYLE)
[Symbol]	NON-MAINTAINED RECESSED EMERGENCY LUMINAIRE, LED TYPE C/W SELF TESTING CAPABILITY.
[Symbol]	NON-MAINTAINED SURFACE MOUNTED EMERGENCY LUMINAIRE, LED TYPE C/W SELF TESTING CAPABILITY.
[Symbol]	TWINSPOUT 4.3W LED (2x20W HALOGEN EQUIVALENT) NON-MAINTAINED EMERGENCY LUMINAIRE, C/W SELF TESTING CAPABILITY, IP65 WEATHERPROOF ENCLOSURE.
[Symbol]	10x16W T5 LINEAR FLUORESCENT SURFACE MOUNTED EMERGENCY IP65 WEATHER PROOF BATTEN WITH EMERGENCY LUMINAIRE (LED TYPE), GRP BODY WITH STAINLESS STEEL CLIPS.
[Symbol]	1x28W T5 LINEAR FLUORESCENT SURFACE MOUNTED EMERGENCY IP65 WEATHER PROOF BATTEN WITH EMERGENCY LUMINAIRE (LED TYPE), GRP BODY WITH STAINLESS STEEL CLIPS.
[Symbol]	2x4W TWIN LED 600mm SURFACE MOUNTED IP65 WEATHERPROOF BATTEN WITH EMERGENCY LUMINAIRE (LED TYPE WITH SELF TESTING CAPABILITY), GRP BODY WITH STAINLESS STEEL CLIPS.
[Symbol]	4x8W TWIN LED 1200mm SURFACE MOUNTED IP65 WEATHERPROOF BATTEN WITH EMERGENCY LUMINAIRE (LED TYPE WITH SELF TESTING CAPABILITY), GRP BODY WITH STAINLESS STEEL CLIPS.
[Symbol]	EXPLOSION PROOF (EMERGENCY) FLUORESCENT LIGHT FITTING (CAT. No. CZ0866)

ABBREVIATIONS	
S	SURFACE MOUNTED
WP	WATER PROOF ENCLOSURE
IS	INTRINSICALLY SAFE
MF	MAINTAINED FITTING

- GENERAL NOTES:
1. DETECTION DEVICES LABELLED TO MEET CURRENT MFS/CFPS CONDITIONS OF CONNECTION REQUIREMENTS.
 2. ALL NEW CABLE PENETRATIONS THROUGH SWITCHROOMS OR TRANSFORMER ROOMS HAVE BEEN SEALED (FIRE RATED).
 3. AUTOMATIC AIR-CONDITIONING SHUTDOWNS INCORPORATED INTO NEW FIRE SYSTEMS) WHERE EXISTING.
 4. ALL FIRE DETECTION AND SPEAKER CABLES INSTALLED HAVE BEEN SEGREGATED AS REQUIRED BY AS/ACF 5009 AND AS1670.1.

CABLE SPECIFICATION	
[Symbol]	2 CORE TWISTED SCREENED PAIR 0.75mm ² , CABLE RATING OF W53/W (2hr FIRE RATED AND RESISTANCE TO WATER)
[Symbol]	2 CORE CABLE 15mm ² (MAX LOOP RESISTANCE 50ohms)
[Symbol]	2 CORE CABLE 1.5mm ²
[Symbol]	2 CORE-E CABLE 2.5mm ²
[Symbol]	2 CORE CABLE 1.5mm ² RADDX (FIRE RATED)
[Symbol]	2x2 CORE TWISTED SCREENED PAIR 0.75mm ²
[Symbol]	8 CORE 0.75mm ² INSTRUMENTATION CABLE
[Symbol]	2 CORE TWISTED SCREENED PAIR 0.75mm ²
[Symbol]	2 CORE CABLE 0.75mm ²
[Symbol]	2 CORE CABLE 1.5mm ²
[Symbol]	2 CORE CABLE 0.75mm ²
[Symbol]	2 CORE CABLE 2.5mm ²
[Symbol]	FIRE-RESISTANT 4 PAIR INSTRUMENTATION CABLE INDIVIDUALLY AND OVERALL SCREENED, CABLE RATING OF W53/W (2 HR FIRE RATED & RESISTANCE TO WATER) AND STEEL WIRE ARMoured FOR VERMIN PROTECTION.
[Symbol]	CAT 5/6 ETHERNET CABLE
[Symbol]	INTERNAL WIRING

Figure 5-11 – Legend and Symbols Example

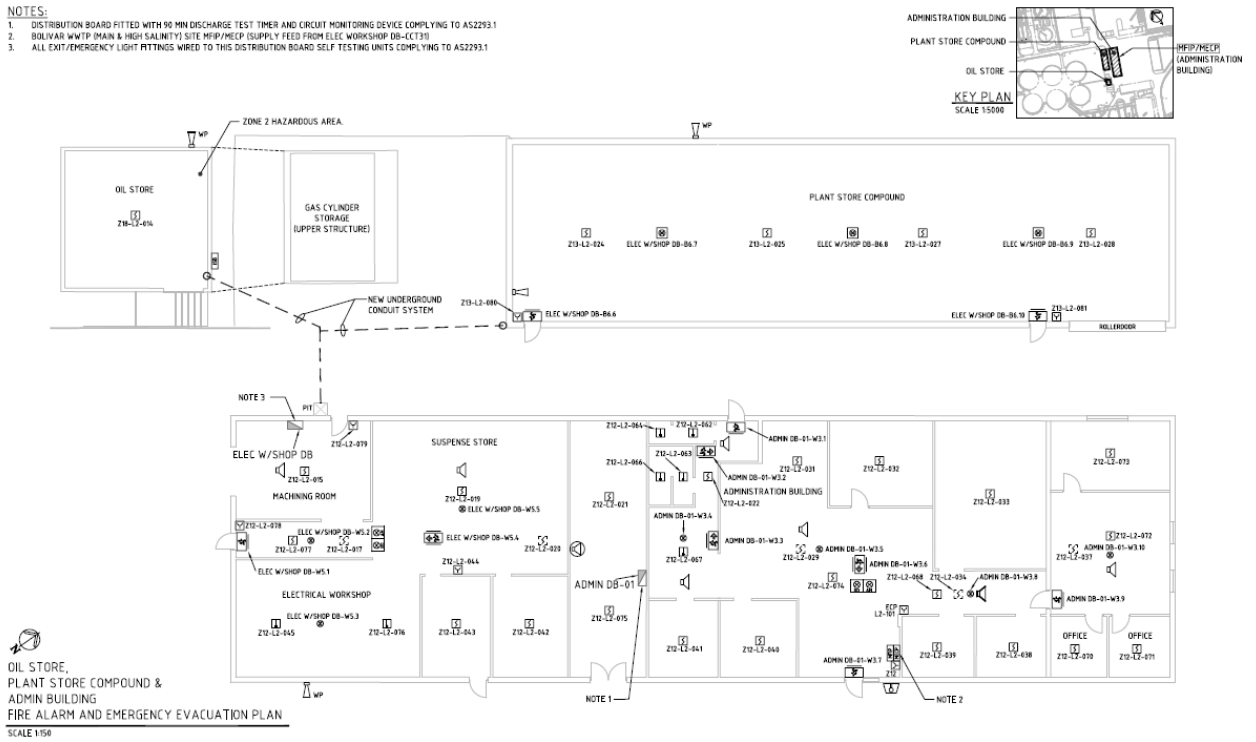

Figure 5-12 – Specific Location Arrangement Example

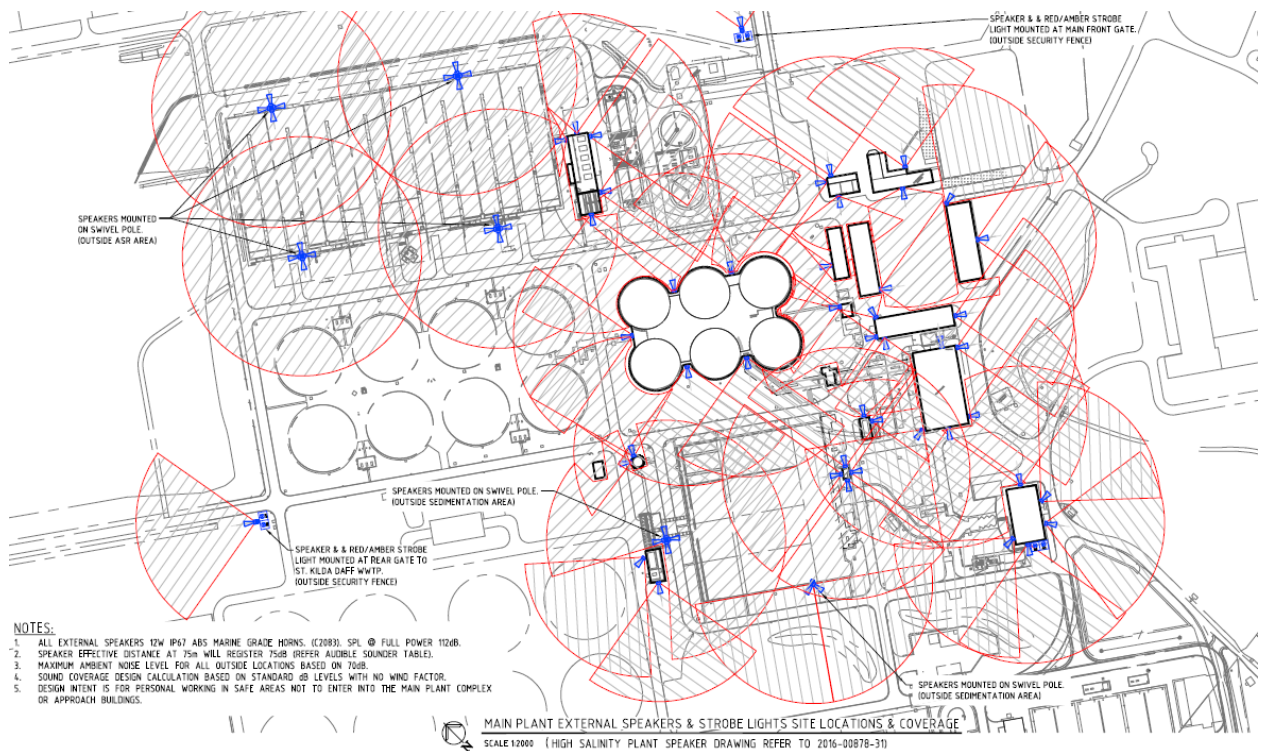

Figure 5-13 – External Speaker and Strobe Light Locations and Coverage Example

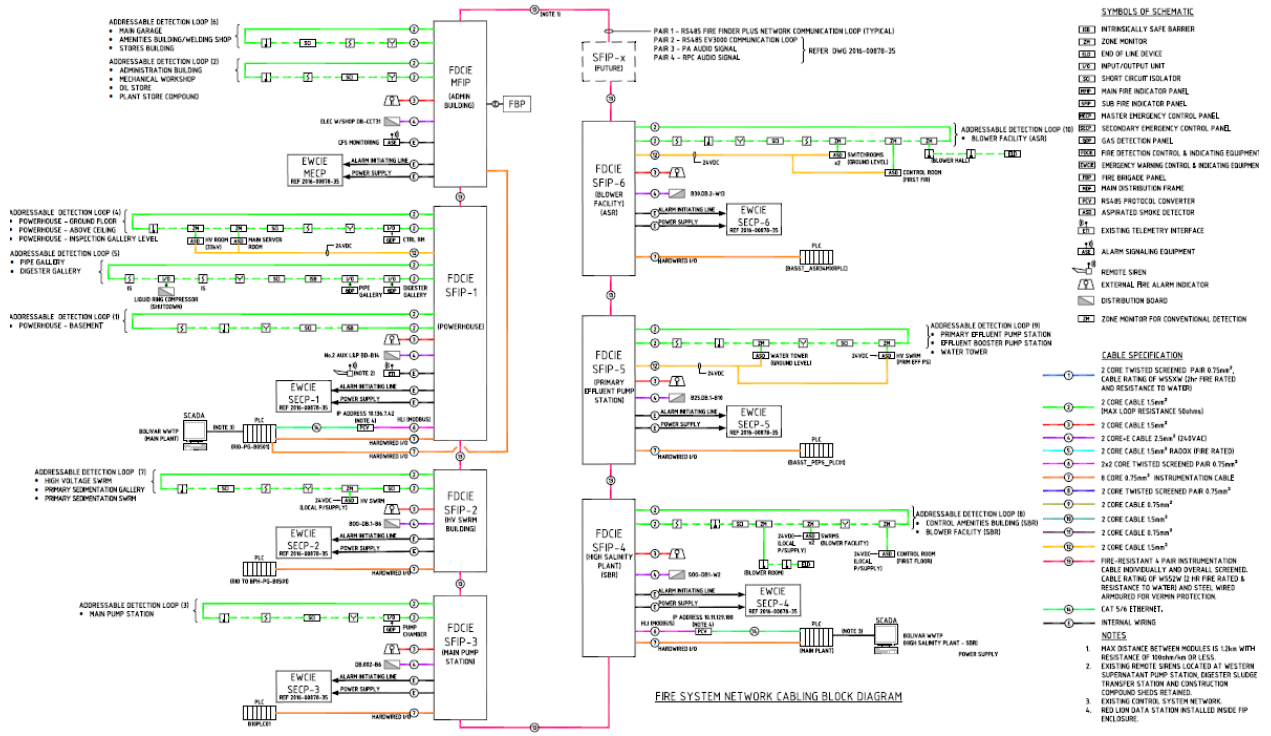

Figure 5-14 – Network Block Diagram Example

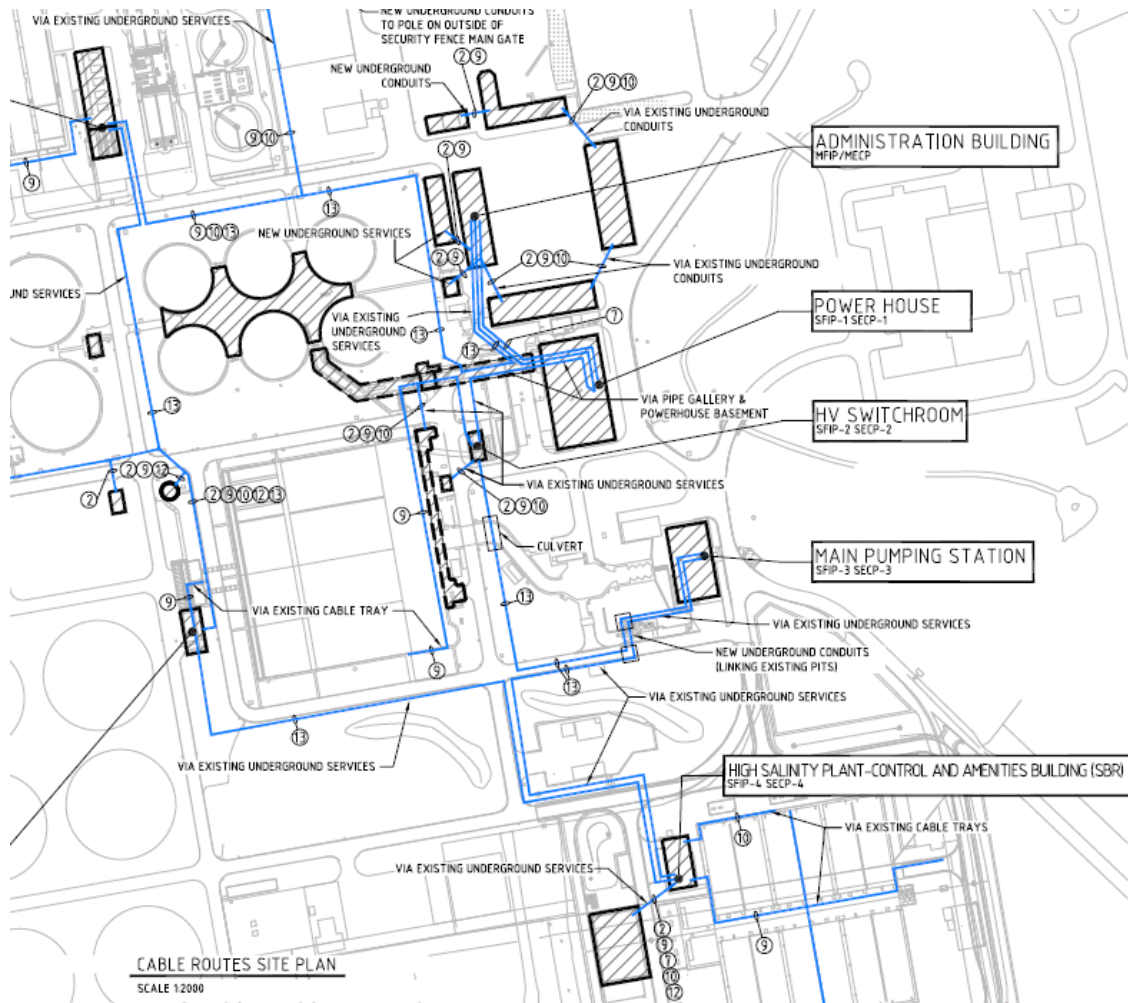

Figure 5-15 – Cabling Routes Example