

TENNESSEE MOTORCYCLE OPERATOR MANUAL



IMPORTANT INFORMATION ABOUT THIS MANUAL

This **Motorcycle Operator Manual** has been developed to assist you in becoming a better motorcycle rider. This manual does not give a complete statement of all Tennessee traffic laws and may not reflect the most recent changes in state law and regulations. For additional and the most current information in state law, you should review Tennessee Code Annotated, Title 55.

Every possible effort has been made to have all current and accurate information included in this publication as of the print date. Misprints or outdated information that may appear within these pages will not override or supersede changes that have occurred in the law, promulgated rules and regulations or policy that has been initiated since the printing date.

This Motorcycle Operator Manual supplements the **Tennessee Comprehensive Driver Manual** which can be obtained at any Department of Safety and Homeland Security Driver Service Center located throughout the state of Tennessee.

This publication is also available on-line at the Tennessee Department of Safety and Homeland Security website: **tn.gov/safety**

Service Locations to Receive and Renew Your License:

The Department of Safety and Homeland Security has Driver Service Centers located throughout the state. For exact locations, days and hours of operation of the driver service centers, that best fit your needs go to our website at: **tn.gov/safety**

TDD assistance for the hearing impaired can be provided by dialing (615)532-2281 (Telecommunication Device for the Hearing Impaired).

MOTORCYCLE LICENSE REQUIREMENTS

MOTORCYCLE ONLY: (Class-M) (126 cc or more). Any two or three-wheel vehicle of more than 125 cubic centimeters (125 cc). A motorcycle license allows the holder 16 years of age or older the privilege of operating a motorcycle. The driver examination will include a vision screening, knowledge test and an on-cycle ability skills test. (See Identification and Application Requirements for additional details). Note: if the applicant does not already have a valid driver license for a passenger vehicle, the knowledge test for Class D is also required.

MOTORCYCLE-SECONDARY: (Class-M) Motorcycle is added in the secondary position on a valid type or class of license. The addition of a motorcycle license allows the holder the privilege of operating a motorcycle in addition to the other vehicles. The driver examination will include a vision screening, written test and an on-cycle ability skills test. The motorcycle license expires when the primary license expires.

MOTOR-DRIVEN CYCLE (SCOOTER): (Class M-Limited) (from 51-125cc). Any two or three wheel vehicle with a motor that produces not to exceed five brake horsepower or a motor with a cylinder capacity no more than 125 cubic centimeters. The license issued to a person 15 years of age will be valid only between the hours of 4:00 a.m. and 8:00 p.m. and within a seven (7) mile radius of the motor-driven cycle driver's home. The license issued to a person 16 and over will only be restricted as deemed necessary by the Department of Safety and Homeland Security.

MOTORIZED BICYCLE: (under 50 cc) The motorized bicycle does not have to be registered, nor does a certificate of title need to be obtained. An owner may register the vehicle under regulations issued by the Commissioner of Revenue.

No endorsement is required on a driver license in order to operate a motorized bicycle; thus the motorized bicycle may be operated by anyone with a valid driver license.

Goggles, windshields and other special equipment required for motorcycles and motor-driven cycles are not required for operation of a motorized bicycle. However, crash helmets are required regardless of the operator's age.

Minors between the ages of 15 and 16 may apply for a restricted license to operate a motorized bicycle, just as they would to operate a motor-driven cycle. For instance, the applicant must take a written test, vision screening and demonstrate the ability to operate the motorized bicycle. The license issued will be restricted to a motorized bicycle only. The license will be valid only between the hours of 4:00 a.m. and 8:00 p.m. and within a seven (7) mile radius of the motor-driven cycle driver's home.

Applicants less than eighteen (18) along with the parent or legal guardian must complete a Minor/Teenage Affidavit and Cancellation form making the parent or legal guardian financially liable for the applicant's action.

MOTORCYCLE LEARNER PERMIT: (Class-PDPM) A special permit allowing minors fifteen (15) years of age to operate a motorcycle after completing the requirement established for a motorcycle license with the following restrictions:

1. Must complete a Minor/Teenage Affidavit and Cancellation Form.
2. Must be limited to a motorcycle with a maximum cylinder size of 650 cubic centimeters (650cc).
3. Must not carry passengers.
4. Must be restricted from use on interstate highways or roadways otherwise marked.
5. Operation during daylight hours only.
6. Must be limited to a twenty (20) mile radius of the driver's home.
7. At the age of sixteen (16), the holder of a motorcycle learner permit (Class P-M) may return to a Driver Service Center and exchange their permit for a motorcycle license to retain the privilege to operate a motorcycle. Note: No tests are required for exchange. After exchange all restriction and size limits are removed.
8. Permits are valid for one (1) year from date of issuance.

SPECIAL BENEFITS: All applicants who hold a valid Tennessee driver license, that bring a certificate of completion from a Tennessee Certified Motorcycle Rider Education Program (MREP) shall be exempt from taking the motorcycle knowledge and ability skills test at the Driver Service Center.

If an applicant does not currently hold a valid Tennessee driver license, they must also take a knowledge test based on the **Tennessee Comprehensive Driver Manual**. Applicants who have completed a Motorcycle Safety Foundation (MSF) course in any state may present the certificate of completion or MSF wallet card and have the ability skills test waived. The course must have been completed within three (3) years of the application date. MSF course completion does NOT waive the knowledge test(s).

All qualified applicants who have successfully completed a state Certified Motorcycle Rider Education Course, and successfully complete the vision screening, by law will be granted a ten percent (10%) discount on liability insurance for motorcycles.¹

The premium reduction shall remain in effect for the qualifying insured persons for a period of three (3) years from the date of successful completion of an approved course, except that the insurer may elect to apply the premium reduction beginning at the next renewal date of the policy and continuing for a period of three (3) years. Applicants should contact their insurance company for more information about this program.

EXAMINATIONS

Examinations are administered by the Department of Safety and Homeland Security at Driver Service Centers in locations throughout the state of Tennessee. Pick up a regular **Comprehensive Driver Manual** at these locations. For exact locations, days and hours of operation, visit our website at: tn.gov/safety

¹ Tenn. Code Ann. §55-51-106

IDENTIFICATION AND APPLICATION REQUIREMENTS

Tennessee has identification and application requirements for all applicants including new and returning residents as well as Tennesseans needing to renew an existing license.

Please be sure to review this information to become familiar with the documentation requirements you will need to bring to the Driver Service Center to assist you in making application for your motorcycle license or permit. Because documentation requirements for proof of identity, proof of U.S. citizenship or lawful permanent resident status, and proof of Tennessee residency are very specific, it is very important that you read through these requirements carefully to avoid unnecessary trips to a Driver Service Center. All documents are subject to further verification with the issuing agency or source. Documents subject to verification may delay the issuance of your permit or driver license.

You must provide positive proof of your full name and date of birth at the time of application. Such positive proof of identity may be an original or certified birth certificate and a social security card. The original or certified birth certificate must have an official seal and be issued by an authorized government agency such as the Bureau of Vital Statistics or State Board of Health. ***Hospital issued certificates (mother's copy) are not acceptable.***

All documents must be original or certified and no photocopies can be accepted.

PROOF OF IDENTITY

Applicants will need to provide the Department with

Two (2) acceptable identification documents for proof of identity. *All documents must have full name and date of birth*

Examples of Acceptable Primary Identification Documents include but not limited to:

U.S. photo driver license or photo ID card, License from another country

- May also include photo learner permits.
- U.S. Department of State Driver's License also acceptable.

Original or Certified Birth Certificate

Must be original or certified, have an official seal and be issued by an authorized government agency such as the Bureau of Vital Statistics or State Board of Health.

IMPORTANT: Puerto Rican birth certificates issued **before** July 1, 2010 will not be recognized as proof of Lawful U.S. Citizenship beginning **November 1, 2010.**

Additional information on obtaining a replacement birth certificate can be obtained online from the government of Puerto Rico at: **www.prfaa.com**

Foreign birth certificates, not issued in English, must be translated and accompanied by a Certificate of Accurate Translation.

NOTE: Hospital issued certificates (mother's copy) are not acceptable.

Military Identification

- Active Duty, Retiree or Reservist military ID card (DD Form 2 or 2A)
- Discharge papers (DD-214)
- Military Dependent ID card (for spouse or children of Active Duty Military personnel)

Valid United States Passport

Valid Foreign Passport

- Foreign passports must contain a Valid United States Visa or I-94 to be used as a primary proof of identification.
- Foreign passports, not issued in English, must be translated and accompanied by a Certificate of Accurate Translation. Passports are not acceptable if expired.

United States Citizenship and Immigration Service Documentation

- Certificate of Naturalization N-550, N-570, N-578
- Certificate of Citizenship N-560, N-561, N-645
- Employment Authorization card (I-766)
- Northern Mariana Card
- American Department of Indian Affairs Tribal Card
- U.S. Citizen Identification Card (I-179, I-197)
- Temporary Resident Identification Card (I-688)
- Travel Documents Record of Arrival and Departure (I-94)
- Border Crossing Identification (I-586)
- Nonimmigrant Visa/Border Crossing Card (DSP-150)
- U.S. Re-entry Permit (I-327)
- Refugee I-94 Record of Arrival and Departure stamped "Refugee"
- Refugee Travel Document (I-571)
- Canadian Immigration Record and Visa or Record of Landing (IMM 100)
- Canadian Department of Indian Affairs issued ID card.

Marriage License/Certificate

- Must include the applicant's full name and date of birth. The certificate must be the original or certified copy that is registered AFTER the marriage; NOT just the "license" authorizing the union.

Federal Census Record

- Must include the applicant's full name and date of birth (age).

Applicant's Own Child's Birth Certificate

- Must include the applicant's (i.e parent's) full name and date of birth not just "age" of parent at the time of the child's birth.

IMPORTANT: Puerto Rican birth certificates issued **before** July 1, 2010 will not be recognized as proof of Lawful U.S. Citizenship beginning **November 1, 2010**.

Additional information on obtaining a replacement birth certificate can be obtained online from the government of Puerto Rico at: www.prfaa.com

Adoptive Decree

- Must include the applicant's full name and date of birth.

Legal Change of Name (Marriage, Divorce, etc.)

- As recorded in court decree with judge's original signature and/or official court seal.

NOTE: Copy of court document with copied seal/signature is not acceptable. Copy of court document with an original signature/seal that is affixed to copy is acceptable.

Any confirmation of date of birth in a court of law

- As recorded in court document(s) with judge's original signature and/or official court seal.

NOTE: Copy of court document with copied seal/signature is not acceptable. Copy of court document with an original signature/seal that is affixed to copy is acceptable.

Any other documentary evidence which confirms to the satisfaction of the Department the true identity and date of birth of the applicant.

Examples of Acceptable Secondary Identification Documents:

Computerized Check Stubs

- Must include the applicant's full name pre-printed on the stub.

Union Membership Cards

- Must include the applicant's full name preferably with photo and/or Social Security number.

Work IDs

- Preferably with photo and/or Social Security number.

Financial Institution Documents

- Computer printouts of bank statements, savings account statements, loan documents, etc. (Internet bank statements are acceptable only if taken to the local bank, stamped and dated by teller as an active account. Checks and checkbook information are not acceptable)

Social Security Documents

- Social Security Card (original only not metal or plastic replicas)
- Printout or benefits statements, etc.
- Social Security Check or Direct Deposit Verification of Social Security Check

Health Insurance Card

- TennCare, Medicaid, Medicare, etc.
- Health Insurance Card
- Insurance Policies or Payment statements

IRS/state tax form

- Current W2 Forms, Property tax receipts, etc. within the past 12 months.

Military Records

- Assignment orders, selective service cards, Leave & Earnings Statement, etc.
- United States or Foreign

School Records

- Transcript of grades
- Elementary Immunization or "Shot" Records
- Diploma or G.E.D.

Vehicle Documents

- Vehicle Registration or title
- Bill of Sale or purchase contract

PROOF OF U.S. CITIZENSHIP OR LAWFUL PERMANENT RESIDENT STATUS

If this is your first Tennessee license or if you are exchanging a license from another state you are required to provide proof of United States citizenship or lawful permanent resident status.

- **Acceptable Documents include, but are not limited to, for proof of U.S. Citizenship:** Official Birth Certificate issued by a U.S. state, jurisdiction or territory (Puerto Rico, U.S. Virgin Islands, Northern Mariana Islands, American Samoa, Swain's Island, Guam)

IMPORTANT: Puerto Rican birth certificates issued **before** July 1, 2010 will not be recognized as proof of Lawful U.S. Citizenship beginning **November 1, 2010**.

Additional information on obtaining a replacement birth certificate can be obtained online from the government of Puerto Rico at: www.prfaa.com

- (Must be original or certified, have an official seal and be issued by an authorized government agency such as the Bureau of Vital Statistics or State Board of Health.

Hospital issued certificates (mother's copy) are not acceptable.

- U.S. Government-issued Certified Birth Certificate
- U.S. Certificate of Birth Abroad (DS-1350 or FS-545)
- Report of Birth Abroad of a Citizen of the U.S. (FS-240)
- Valid, unexpired U.S. Passport
- Certificate of Citizenship (N560 or N561)
- Certificate of Naturalization (N550, N570 or N578)
- U.S. Citizen Identification Card (I-197, I-179)

Acceptable Documents include, but not limited to, for proof of Lawful Permanent Resident Status:

- Permanent Resident Alien Card (I-551)
- Foreign passport stamped by the U.S. Government indicating that the holder has been "Processed for I-551"
- Permanent resident Re-entry Permit (I-327)
- Arrival Departure Form I-94 with "Temporary I-551" stamp and holder's photograph affixed
- Travel Document issued to Permanent Residents (I-327)
- Travel Document issued to Refugees (I-571)
- Form I-94 stamped with one of the following statuses: Asylee, Parolee or Parole, Refugee, Asylum, HP-humanitarian parolee or PIP-public interest parolee

If you are not a U.S. Citizen or Lawful Permanent Resident you may be eligible to qualify for a Temporary Driver License.

PROOF OF TENNESSEE RESIDENCY

If you do not already have a Tennessee Driver License or learner permit, you will also be required to provide two documents with your Tennessee residence address as proof of residency. A Post Office box or mail drop address is not acceptable as proof of residency.

Examples of acceptable documents for proof of residency include:

- Current utility bill including landline telephone, electric, water, gas, cable, etc. (Wireless telephone bills cannot be accepted)
- Current bank statement (Internet bank statements are acceptable only if taken to the local bank, stamped and dated by teller as an active account. Checks and checkbook information are not acceptable)
- Current rental/Mortgage contract or receipt including deed of sale for property.
- Current employer verification of residence address or letter from employer as long as it is on company letterhead with original signature. If employer does not have letterhead then signature of employer must be notarized.
- Current paycheck/check stub, work ID or badge, if address is included.
- Current automobile, life or health insurance policy (Wallet Cards cannot be accepted)
- Current driver license/ID issued by the Tennessee Department of Safety to a parent, legal guardian or spouse of applicant
- Current Tennessee motor vehicle registration or title
- Current Tennessee voter registration
- Current Internal Revenue Service tax reporting W-2 form with last 12 months
- Receipt for personal property or real estate taxes paid within past last year
- In case of a student enrolled in public or private school in this state, student may provide a photo student ID and acceptable documentation from the Dean or Bursar Office that the student lives on campus.
- Individual Taxpayer Identification Number (ITIN) issued by the Internal Revenue Service

Both items may NOT be from the same source. For example an applicant could NOT use:

- Vehicle registration and vehicle title for same vehicle or documentation for multiple vehicles
- Water and Gas bill from the same utility
- Cable and Telephone bills from the same company

All items are required to be current documents within the past four (4) months. Internal Revenue Service documents must be from the past twelve (12) months.

TEMPORARY DRIVER LICENSE

You may be eligible to obtain a Temporary Driver License for the operation of a motorcycle, motor scooter or motor driven cycle (Class XM). The Temporary Driver License is issued to persons whose presence in the United States has been authorized by the federal government for a specific purpose and for a specific period of time. Qualifying applicants who obtain a Temporary Driver License for the operation of a motorcycle, motor scooter or motor driven cycle (Class XM) will be issued a photo license document valid for both driving and identification purposes.

In order to qualify for the Temporary Driver License, the applicant will be required to provide the Department with proof of temporary legal presence and authorized stay in the United States. Such proof must indicate the applicant's length of authorized stay in the United States.

To prove temporary legal presence and authorized stay in the United States, applicants must provide one of the following:

- Conditional Resident Alien Card (I-551)
- Valid Foreign Passport with Valid Visa and I-94 attached
(Note: The passport must have an English translation)
- Valid Foreign Passport with I-94W attached
 - Holders of F1, F2, M1, or M2 status should also present a valid SEVIS I-20
 - Holders of J1 or J2 status should also present a valid DS-2019
- Temporary Resident Identification Card (I-688)
- Employment Authorization Card (I-766)

The applicant for the Temporary Driver License will also need to provide:

- Legal proof of name change (i.e. certified marriage certificate, certified final divorce decree, etc.) will be required if the name on the identification documents does not match the federal document used for proof of temporary legal presence.
- If the applicant wishes to have the Temporary Driver License issued in a name different that what appears on the federal documents, proof will need to be provided confirming that the name change has already been submitted to the federal agency will also be required.
- Two (2) proofs of Tennessee residency.
- Proof of social security number (or sworn affidavit if no social security number has been issued).

The applicant will also have to successfully pass the required vision screening, knowledge test(s) and skills tests where applicable.

Minor/Teenage Affidavit

Applicants under eighteen (18) years of age must complete a Minor/Teenage Affidavit and Cancellation Form available at all driver license service centers. This form confirms that the adult signing the form joins in the application for the license and will be responsible for the actions of the minor driver. This includes assuming financial responsibility for the actions of the minor driver. It must be signed by a parent, step-parent, foster -parent living at the same address as the applicant, legal guardian, or a grandparent authorized by the parent, step-parent or guardian.

If adults cannot accompany the minor to the driver license station to sign the form, it may be completed ahead of time and signed before a notary public.

If a grandparent is assuming financial responsibility for the youth, the grandparent must bring a notarized statement authorizing this, signed by the parent, a step-parent, custodian or guardian, as appropriate.

Additionally, if applicants under 18 do not already have a Class D or PD license, they will be required to provide proof of school attendance as detailed in the regular driver handbook on our website at tn.gov/safety.

If you already have a valid Class D or PD license, your motorcycle examination will consist of:

- Vision screening
- Motorcycle rules of the road knowledge test
- Motorcycle pre-trip inspection
- Motorcycle skills/road test

If you do NOT already have a Class D or PD license, your examination will also include:

Regular Rules of the Road knowledge test. (You will need to study the regular **Tennessee Comprehensive Driver Manual**, if this test is required.)

Motorcycle licenses are issued under the same renewal cycle as regular driver licenses. As of January 1, 2016, Tennessee licenses for persons over the age of 21 expire every eight years from the date of issuance. Exception: Class M-Limited issued to applicants age 15 will be calculated to expire on the 16th birthday.

IMPORTANT INFORMATION ABOUT DRUGS AND ALCOHOL

PLEASE NOTE: Tennessee is serious about educating the public on the tragedies of driving under the influence of drugs or alcohol. To underscore this, the law requires at least 25% of the knowledge test to consist of questions dealing with this topic. Driving Under the Influence (DUI) includes not only alcohol, but any intoxicant, narcotic drug, or other drug producing central nervous system effects including prescription drugs.

The main points of Tennessee's DUI laws are summarized below. However, to be fully prepared for your motorcycle knowledge test you must also study Section B. Chapter 7 **-Alcohol, Other Drugs and Driving** in the regular **Tennessee Comprehensive Driver Manual**.

You may pick up a copy of this manual at any Driver Service Center throughout Tennessee or you can review the manual online at <http://www.tn.gov/safety/topic/classm>

Drinking and Driving

Alcohol and You

Researchers estimate that between the hours of 10:00 p.m. and 2:00 a.m., one of every 10 drivers is intoxicated. More than one-third of these drivers have been drinking at someone else's home. Nearly 50 percent of the drivers arrested for driving under the influence (DUI) are social to moderate drinkers. Don't think that it won't happen to you. In your lifetime, there's a high probability that you'll be involved in an alcohol-related crash.

An Overview of the Effects of Alcohol

Before you can fully understand why drinking and driving result in fatalities on the highways, you first need a better understanding of the effects of alcohol on the body.

How Does Alcohol Affect the Body?

Alcohol begins to be absorbed into the bloodstream within one to two minutes after an alcoholic beverage is consumed. As you consume alcohol, it accumulates in your blood. Intoxication occurs when you drink alcohol faster than the liver can oxidize it. As the percentage of alcohol in your blood increases, you become more intoxicated.

Once in the bloodstream, the alcohol is distributed to all parts of the body, including the brain and liver. Upon reaching the liver, the alcohol immediately begins to be oxidized. However, the liver can only oxidize about one drink per hour. Contrary to popular belief, this rate cannot be increased by drinking coffee, exercising, taking a cold shower or anything else. Only time can sober a person that has been drinking. And remember, it is a slow process.

What Is Blood Alcohol Concentration (BAC)?

Blood Alcohol Concentration (BAC) is a measurement of the percentage of alcohol in the blood. The higher the BAC number, the more impaired a person is. In most states, including Tennessee, .08 is the level of intoxication which is always illegal. This means that for every 10,000 drops of blood in a person's body, there are eight drops of alcohol. BAC changes with body weight, time spent drinking, and the amount of alcohol that is consumed.

Amount of Alcohol Consumption.

Each drink consumed within an hour increases the BAC level. The more you drink in a fixed amount of time, the higher your BAC will register. This happens no matter what you weigh — or what kind of alcoholic beverage you drink.

Rate of Alcoholic Consumption.

Drinking three drinks in one hour will affect you more than drinking three drinks in three hours. Spacing the drinks over a longer period of time will slow the rate at which you become intoxicated and indicates responsible drinking habits.

Body Weight and Fat.

The heavier the person, the more alcohol it takes to raise the BAC. Be aware of your size when drinking with others. If you are smaller than your friends and try to drink as much as they do, your judgment and inhibitions will probably be affected before theirs are.

Body fat also affects how quickly you are affected by alcohol. Alcohol is able to be absorbed in water, not fat. This simply means that people with less body fat have more water in which to dilute the alcohol. So, drink for drink, if people weigh the same, the one with more body fat will show signs of intoxication first.

Amount of Food in the Stomach.

All the alcohol consumed eventually gets into the blood whether you have eaten or not. Food in the stomach causes alcohol to be absorbed more slowly, slowing down the rate and the amount of intoxication.

Overall Condition of the Body

Heavy and chronic drinking can harm virtually every organ and system in the body. The liver is particularly vulnerable to alcohol's harmful effects since it oxidizes approximately 90 percent of the alcohol in the body. If the liver is damaged or diseased, the rate of oxidation is reduced, causing the alcohol to stay in the body longer and the BAC to be higher for a longer time. Further, the effects of alcohol on the liver can lead to such diseases as hepatitis and cirrhosis.

Relationship of Alcohol to Traffic Crashes

Driving after drinking is a widespread problem. It is estimated that two in every five Americans (or 40%) will be involved in an alcohol-related crash at some time in their lives.

Each drink drastically increases your risk of having a traffic crash.

With a BAC of .10 percent, you are seven times more likely to cause a crash than if you were sober.

As your BAC increases to .15 percent, your chances of causing a traffic crash increase to 25 times.

At .17 percent BAC, you are 50 times more likely to cause a crash.

Behavior at each BAC level may differ somewhat with the individual. ALL people at the .10 percent level are definitely too impaired to drive safely. Research has proven that driving skills, good judgment and vision are greatly impaired at BAC levels as low as .03 and .04 percent, especially for young drinkers.

Alcohol's Effects on Driving Ability

Driving involves multiple tasks, and the demands can change continually. To drive safely, you must maintain alertness, make decisions based on ever-changing information present in the environment and execute maneuvers based on these decisions. Drinking alcohol impairs a wide range of skills necessary for carrying out these tasks. Fatal injuries, resulting from alcohol-related

traffic crashes, represent a tremendous loss of human life. In 2008, 15,438 deaths nationwide (41% of all traffic fatalities) were alcohol-related. In Tennessee, 39 percent of all traffic fatalities (404 deaths) were alcohol-related.

The plain and simple fact is that you cannot drive safely when you are impaired by alcohol. The two abilities most important to the driving task are judgment and vision—both of which are affected by small amounts of alcohol. Your ability to judge speed, time and distance are altered after only one drink. Each extra drink greatly affects your driving ability. In addition, your reaction time and coordination begin to deteriorate, while your alertness and concentration fade. All of this adds up to a deadly combination.

Judgment:

Ability to Think Clearly and Make Quick Decisions

Good judgment decreases with the use of alcohol. The concern for physical well being also lessens. People under the influence of alcohol take unnecessary and dangerous risks. Examples are driving too fast, passing cars without enough clear distance and speeding around curves. Showing off is another example of impaired judgment.

Vision:

Ability to See Clearly Straight Ahead, to the Side and at Night

Alcohol decreases clearness of vision. It reduces the ability to see clearly at night by more than half. Glare vision is poor because of relaxed eye muscles. Glare recovery is also slowed by alcohol. Side vision is reduced by about 30 percent at .05 percent BAC. Judging depth or distance is affected because alcohol causes each eye to get a slightly different picture. These vision impairments greatly increase the chances of a head-on or rear-end collision. Eye muscles are relaxed by alcohol and cannot focus properly. Because the eyes provide almost 90 percent of the information used in driving, any restriction in vision can cause disastrous results.

Reaction Time and Coordination

This is the ability to react quickly and safely to an emergency or hazardous situation—being able to keep eyes, hands and feet working together.

Reaction and coordination are impaired by alcohol consumption as low as .02 percent BAC. It takes longer to react. Coordination skills to control the car with hands, feet and eyes in response to other vehicles and the road are drastically reduced as alcohol intake increases.

Alertness and Concentration

Being ready to react to changing driving conditions or situations, keeping your mind on driving and paying attention to the task at hand.

Alcohol, in any concentration, is a depressant, not a stimulant. Alcohol slows all nerve impulses and body functions. The false feeling of stimulation that comes with small doses of alcohol is caused by the lessening of inhibitions. That's because the particular portion of the brain controlling this part of behavior is being relaxed. In reality, alcohol has the effect of limiting a driver's ability to be alert and to concentrate.

“Every Day” Drugs

One of the most common and most dangerous instances of drug abuse occurs when people mix alcohol with prescription and over-the-counter drugs. For example, when alcohol is combined with another depressant, like tranquilizers or sedatives, etc., the results are not just added together. They are multiplied. Even some over-the-counter medicines can affect driving. The effects are much stronger, much more dangerous and can affect your driving skills.

If your doctor prescribes a tranquilizer or sedative, make a point to discuss how the drug will affect your ability to drive safely. Just because a drug is prescribed is — by law — this is NO defense for driving under the influence of it.

Non-prescription drugs, such as cold tablets, cough syrups, allergy remedies, etc., purchased over-the-counter may contain antihistamines, alcohol, codeine and other compounds that can be especially dangerous for drivers. Read labels and pay attention to warnings (e.g., “may cause drowsiness,” “do not operate machinery,” “caution against engaging in operations requiring alertness”).

If you have questions about a particular drug or combination of drugs, check with your doctor or pharmacist.

Driving Under the Influence of Drugs or Alcohol (The “DUI” Law)

Studies indicate that marijuana and other drugs also affect judgment and motor functions. This makes driving under the influence of drugs other than alcohol dangerous as well. In Tennessee, it is unlawful for any person to drive or be in physical control of an automobile or other motor-driven vehicle on any public street, highway, road or alley, or while on the premises of any shopping center, trailer park or any apartment house complex, or any place frequented by the public while:

1. Under the influence of any intoxicant, marijuana, narcotic drug or drugs producing stimulating effects on the central nervous system; or
2. While the alcohol concentration of the operator’s blood or breath is .08 percent or higher.

The defendant’s ability to drive when using drugs may be sufficiently impaired to constitute a DUI violation. A driver can register a BAC of .00 percent and still be convicted of a DUI. The level of BAC does not clear a driver when it is below .08 percent. If a law enforcement officer observes things, such as erratic driving behavior, or maintaining an inappropriate speed (too fast or too slow), it would be sufficient cause for stopping the vehicle to investigate. Further sobriety checks could lead to the conclusion that the driver was indeed “Driving Under the Influence” of an intoxicant, narcotic drug or other drug producing stimulating effects on the central nervous system, including prescription drugs. If you have any doubt about your ability to drive, don’t get behind the wheel.

Implied Consent Law

By law, when you drive in Tennessee, you have given your consent to be tested to determine the alcohol or drug content of your blood. This test must be administered at the request of a law

enforcement officer who has reasonable grounds to believe you have been driving under the influence of an intoxicant or drug.

If you are placed under arrest and a law enforcement officer asks you to take the test and you refuse, the test will not be given. The court will send notification of action to the Department of Safety and Homeland Security and your driver license will be suspended for twelve (12) months.

Consequences of a DUI Arrest

Drinking and driving poses several problems. One is the probability of an accident, and another is being arrested for DUI. The penalties for a DUI arrest are the same whether the driver was drinking alcohol or taking drugs (even prescription or over-the-counter drugs). If you are arrested for DUI, the consequences can be severe.

DUI Penalties

	Jail Time	Fines	License Revocation Period	Vehicle Seizure
1st Conviction	48 hours (7 days if BAC is 0.20% or more)	\$350-\$1500	1 Year	Does Not Apply
2nd Conviction	45 days-11 months, 29 days	\$600-\$3,500	2 Years	Vehicle is subject to seizure and forfeiture
3rd Conviction	120 days-11 months, 29 days	\$1,100-\$10,000	3-10 Years	Vehicle is subject to seizure and forfeiture
4th or subsequent Conviction (is a Class E felony)	150 days -maximum allowable for Class E felony	\$3,000-\$15,000	5 Years (to indefinite)	Vehicle is subject to seizure and forfeiture

Penalties Applying to Any DUI Conviction

Regardless of whether the conviction for driving under the influence is a driver’s first or not, several other laws apply:

- IDs with “DUI Offender:” If a person with a license revoked for DUI applies for a photo identification license to carry during the period before his or her license can be restored, the department is required to indicate on the ID that the person is a DUI offender.
- Litter Removal: A DUI conviction also requires as a condition of probation, Litter pick-up for three eight-hour shifts. While removing litter, the offender has to wear a vest or other clothing displaying the message, “I am a DRUNK DRIVER.” If the offender is a Tennessee resident, the litter pick-up is done in his/her home county.

- **Vehicle Seizure:** A vehicle can be seized if a driver is charged with driving on a revoked license when his/her driving privileges are already revoked as a result of a DUI conviction (first or subsequent).
- **Vehicular Homicide:** If you are operating a motor vehicle under the influence of a drug or alcohol, and you are involved in a crash resulting in the death of another person(s), you may be charged with vehicular homicide. If convicted, you may be fined and sentenced to prison. It is possible to be imprisoned for many years.
- **Aggravated Assault:** If you are operating a vehicle under the influence of a drug or alcohol, and you are involved in a motor vehicle crash that results in the injury of another person, you may be charged with aggravated assault. If convicted, you may be fined and sentenced to prison.
- **Child Endangerment:** Known as the Drunk Driving Child Protection Act, there are added penalties for people who violate DUI laws when accompanied by a child under 18 years old. There is a mandatory minimum jail sentence of 30 days, and a mandatory minimum fine of \$1,000. Both of these child-related penalties are added onto any other incarceration, penalty and fines. If the child suffers serious bodily injury, the violation is a Class D felony, and if the child dies, it is a Class C felony of especially aggravated child endangerment.

Additional DUI Penalties

In addition to the minimum penalties above, the judge will also require the following of the DUI offender:

- To undergo a drug and treatment assessment and receive treatment, as appropriate, for those who have had a prior DUI in the five years prior to the current DUI.
- Participation in an alcohol safety DUI school program, if available; or
- Participation in a program of alcohol or drug rehabilitation at a treatment facility, if available, for second and subsequent convictions; and
- The payment of restitution to any person suffering physical injury or personal losses as a result of the DUI, if the offender is economically capable of making restitution.
- The driver's vehicle will be seized if he/she has two DUI convictions within five years AND both events happened after January 1997.

Courts may also limit the DUI offender to driving only a motor vehicle equipped with a functioning ignition interlock device (which keeps a car from starting if the driver's BAC is too high). This restriction can be up to six months for a first offense, up to three years for a second offense and up to 10 years for third and subsequent offenses.

PLEASE NOTE: A person with 2 DUIs in a five year period MUST operate a motor vehicle with the ignition block device for six months after reinstatement of driving privileges.

Remember, driving while under the influence of drugs—even prescription drugs—carries the same penalties as for alcohol.

DUI's Are Expensive!

Besides being extremely dangerous and against the law, DUI's are costly. In addition to the fines and court costs, a person charged with DUI can be faced with posting bond to get released from jail, attorney fees, loss of time from work to attend court hearings, loss of time from work to serve time in jail, fees for alcohol safety courses and possible treatment, increased insurance premiums, and other expenses. This can add up to several thousand dollars.

A single DUI (Driving Under the Influence) conviction could cost you as much as \$5,000 or more after all fines and fees have been paid. A first offense DUI charge could easily add up to such a staggering cost!

Potential costs of a DUI conviction include:

- Court Costs & Fines
- Bail
- Towing and Vehicle Storage Fees
- Attorney Fees
- Alcohol Education Program Enrollment
- Driver License Reinstatement Fees
- Ignition Interlock Program Costs
- Higher Insurance Premiums and SR-22 Form

Young Driver Risks and Laws

Not Just Driving—Riding With Others!

Young people remain especially vulnerable to the threat of alcohol and other drugs. This is not only from their own impaired driving, but also from getting in the car or on a motorcycle with other drivers who are not sober. **TRAFFIC CRASHES ARE THE LEADING KILLER OF YOUNG PEOPLE, AND NEARLY HALF ARE ALCOHOL RELATED.** In a national survey, nearly half of 10th graders and a third of eighth graders reported having ridden during the past month with a driver who had used alcohol or other drugs before taking the wheel.

Crash records indicate that young drivers under the influence of small amounts of alcohol appear to have more driving problems than older drivers. Most teenagers are intoxicated at low BAC levels. The young driver's chance of a crash is much greater with BAC between .01-.08 percent than older drivers. This is due to low tolerance of alcohol and limited driving experience.

THE DECISION IS YOURS. BE RESPONSIBLE AND SMART--HELP YOURSELF AND YOUR FRIENDS!

Under 21 Laws

In addition to the standard penalties for driving under the influence of drugs or alcohol discussed previously, there are three special laws that apply to people under the age of 21:

- **18-20 Alcohol Violations:** If you are 18, 19 or 20 years old and are convicted of purchasing, attempting to purchase, or possessing any alcoholic beverage, you will lose your privilege to drive for one year. If it happens a second time you will lose your license

for two years. The law applies to any alcohol-related conviction, whether or not you were driving or even in a vehicle.

- **Juvenile Offenders:** If you are between the ages of 13 and 17 and are found to have possessed, consumed or sold either alcohol or drugs, your driving privilege will be suspended for one year or until age 17, whichever is longer. Even if you have never been licensed, you could lose your privilege to drive until you reach age 17. If you have a second conviction, the suspension is for two years or until age 18, whichever is longer.
- **Under 21 BAC:** A person who is at least 16, but is not yet 21 years old, and who is found: (1) driving with a BAC of .02 percent; (2) under the influence of alcohol; or (3) under the influence of any other intoxicant, will be convicted of underage driving while impaired. Penalties for this conviction are: losing your license for one year, a fine of \$250 and sometimes, includes public service work.

CONSEQUENCES OF UNDERAGE DRIVING WHILE IMPAIRED

The delinquent act of underage driving while impaired for a person age sixteen (16) or over but under the age of eighteen (18) is punishable by a driver license suspension of one (1) year and a fine of two hundred fifty dollars (\$250). As additional punishment, the court may impose public service work.

Prevention of Drinking and Driving

The best advice, of course, is simply to not drink when you know you are going to drive. One of the most successful programs in recent years has been the designated driver concept, where friends agree ahead of time which person will remain strictly sober. Many night clubs offer the designated driver free non-alcoholic beverages for the evening. Young people, who do not want to drink in the first place, are finding it more socially acceptable to offer to be the designated driver.

Avoiding the Risks

Alcohol-related crashes are not accidents. They can be prevented. If you are planning a night on the town, decide before you start drinking that you are not going to drive. Remember, alcohol affects your judgment. It's a lot more difficult to make the decision not to drive after one or two drinks.

DID YOU KNOW?

1. The amount of alcohol in one (12 ounce) bottle of beer is about equal to that in a (1 ounce) shot of whiskey.
2. When alcohol is consumed, it quickly reaches the brain where it, in effect, short-circuits the parts that control judgment, emotions and confidence.
3. The first thing affected after drinking alcohol is a person's judgment.
4. Reliable research studies show that two or three drinks of alcohol in three hours or less impair the driving ability of most individuals.
5. It takes about one hour to cancel the effects of one drink. It takes about three hours to cancel the intoxicating effects of three drinks.

6. Alcohol-related vehicle crashes are the number one killer of persons under the age of 40.
7. Many drugs, even legal over-the-counter drugs, can impair your ability to drive. If you are taking them for a cold, they make you feel well enough to drive, but they can also affect alertness, judgment, coordination and vision.
8. The combined use of alcohol and other depressant drugs, such as antihistamines, may be more dangerous to health and highway safety than the effects of either the alcohol or drugs alone.

We Are Doing Better

Over the past few years, Tennessee has seen a progressive decrease in the percentage of fatal crashes involving alcohol. Prior to 1990, it was common for half of all fatal crashes to involve alcohol. Since then, there has been a decline. In 2009, the percentage was less than 31 percent. This is an improvement over 20 years, but only safe driving and adhering to laws that prohibit drinking and driving will move this percentage down even further.

NOTE: Portions of the above information was written in consultation with the Tennessee Association of Alcohol, Drug and Other Addiction Services (TAADAS).

EQUIPMENT REQUIREMENTS

Tennessee law requires you to have the following safety equipment on your motorcycle. Exceptions to the law are noted.

Motorcycle operators and passengers must ride only on permanent seats attached for that purpose. You are not allowed to carry a person on a motorcycle not built to carry passengers.

You must ride astride your motorcycle, facing forward with one leg on each side of the motorcycle.

It is against the law to carry a package or other articles that prevent you from keeping both hands on the handlebars.

HEADLIGHT

The headlights of a motorcycle must be on at all times during operation.

CRASH HELMETS

A person riding a motorcycle will be required to wear a crash helmet meeting federal standard **49 CFR 571.218**. A driver or passenger who is twenty one (21) years of age or older may wear a helmet that meets federal safety standard 218, but does not have to meet the helmet penetration standards, the continuous contour standard and the labeling standard of **49 CFR 571.218**. Helmets that are exempt from these standards need to have a label affixed to the helmet signifying that it complies with the American Society for Testing Materials (ASTM), the Consumer Product Safety Commission (CSPM) or the Snell Foundation.

The helmet must be either DOT, ASTM, CSPM or Snell labeled before the examiner can administer the road test.

Any person under twenty one (21) years of age, must wear a DOT approved helmet while operating a motorcycle or motor-driven cycle.

Any person eighteen (18) years of age or older is exempt from wearing a helmet on a motorcycle if it is being ridden in a parade at a speed not exceeding thirty (30) miles per hour.

WINDSHIELD OR SAFETY GOGGLES

Every motorcycle or motor-driven cycle operated on a public road must be equipped with a windshield that meets U.S. Department of Transportation requirements, or as an alternative, operators and passengers must wear safety goggles or glasses containing impact resistant lenses or a helmet with a face shield.

REARVIEW MIRRORS AND FOOTRESTS

All motorcycles or motor-driving cycles must be equipped with a rearview mirror, mounted on the left handlebar in an upright position. They must also be equipped with footrests for the driver and passenger.

TAIL LIGHTS

Motorcycles and motor-driven cycles must have at least one red tail light and one red stop light. When the service or foot brakes are applied, the light should be visible and distinguishable from a distance of one hundred feet (100'). The stop light may be incorporated in the tail light.

Continuous flashing brake light systems for motorcycles are permissible where the brake lamp pulses rapidly for no more than five (5) seconds when the brake is applied and then converts to a continuous light as a normal brake lamp until such time as the brake is released.

MUFFLERS

It is illegal for you to operate your motorcycle on any road unless it is equipped with a muffler in good working order and in constant operation to prevent excessive noise or annoying smoke. "Straight pipes" are illegal in Tennessee.

VIOLATING THE LAW

Parents and guardians who knowingly permits a minor to operate a motorcycle or a motor-driven cycle in violation of the law can be convicted of a misdemeanor and could be fined up to \$100 for each violation.

OPERATION IN ROADWAY LANES

- A. All motorcycles are entitled to the full use of a lane and no motor vehicle shall be driven in such a way as to deprive a motorcycle such use.

- B. The operator of a motorcycle shall not overtake and pass in the same lane occupied by the vehicle being overtaken.
- C. No person shall operate a motorcycle between lanes of traffic or between adjacent lanes or rows of vehicles.
- D. Motorcycles shall not be operated more than two (2) side by side in a single lane.
- E. Motorcycles may be operated in designated high occupancy vehicle (H.O.V.) lanes.

Section B and C shall not apply to police officers in the performance of official duties.

SHARING THE ROAD SAFELY

Among all motor vehicles, motorcycles are the most vulnerable on the road. Because motorcycles do not have seat belts, you can be thrown off your seat in a crash, which can result in serious injury or even death. Imagine your chance for survival if a truck strikes you, or if you strike it. Hitting a truck is like hitting a steel wall. However, your chance for survival will be increased if you wear a helmet and follow the safety tips below when riding your motorcycle.

WATCH THE NO-ZONES

Never hang out in a truck's blind spot or "No-Zone." Trucks have large No-Zones on both sides, the front and behind the truck. Truck drivers cannot see you when you ride in these blind spots, which allows for a greater chance of a crash. The front blind spot is particularly dangerous if you need to stop quickly. Because of their lightweight and braking system, motorcycles can stop much faster than trucks. A truck may not be able to stop as quickly as you do, so you need to take special precautions to avoid crashes before they happen.

ALWAYS WEAR A HELMET

Make sure to always wear a helmet. Beware of helmets that do not meet U.S. Department of Transportation (DOT) standards. Check for the DOT label inside your helmet. Helmets are the most important piece of equipment you can wear when riding your motorcycle. A helmet could be your only source of protection in a serious crash.

DRIVE TO SURVIVE

Motorcycles are the smallest vehicles on the road. Unfortunately they provide virtually no protection in a crash. Other drivers may not see you on your motorcycle, so you must be aware of everything on the road. Be extra cautious, paying attention to the signals and brake lights of other vehicles, especially trucks. However, you still need to be prepared in the event their signals or lights don't work. Ride with caution and drive defensively. Even though your motorcycle may be small, you must adhere to the laws of the road. Never ride in between lanes in traffic or share a lane with another vehicle. Don't instigate aggressive driving with other motorists; you will only increase your chance of a crash.

CHECK YOURSELF AND YOUR BIKE

Conduct a safety inspection of your motorcycle before each ride, and wear protective clothing including gloves, boots and a jacket. Proper maintenance and protective clothing will help reduce your chance of a crash or the severity of injury if you are involved in a crash, especially with a large truck or bus.

WATCH YOUR SPEED

Of all vehicles, motorcycles accelerate the fastest, while trucks and buses are the slowest. Please watch your speed around trucks, especially in bad weather or at night. Colliding with the back of a truck will end your riding days.

SHARING THE ROAD WITH LARGE TRUCKS AND BUSES

You will always be sharing the road with trucks because they haul more freight more miles than any other form of transportation. Trucks are the sole method of delivery and pickup for approximately seventy-seven percent (77%) of America's communities.

A typical tractor-trailer combination, a power unit pulling a loaded semi-trailer hinged to its rear end, may weigh up to 80,000 pounds. Depending on the trailer length, the total length of the combination may exceed 70 feet. On the busiest intercity routes, a driver may encounter double or even triple-trailer combinations sometimes exceeding 100 feet in length.

The number of trucks that were involved in fatal accidents nationally has decreased by 35% percent from 2005 to 2009. When driving on a highway you are at a serious disadvantage if involved with a larger vehicle. In crashes involving large trucks, the occupants of a car, usually the drivers sustain 78% of the fatalities.

Many truck-car crashes could be avoided if drivers know about truck (and bus) limitations and how to steer clear of unsafe situations involving large vehicles. Seems obvious, doesn't it? But the fact is that while most people realize it is more difficult to drive a truck than a car, many don't know exactly what a truck's limitations are in terms of maneuverability, stopping distances, and blind-spots. Remember: Large trucks, recreational vehicles and buses are not simply big cars. The bigger they are:

1. The bigger their blind spots. Trucks have deep blind spots in front, behind and on both sides. Make sure you position your motorcycle so that the driver of the truck can see you in the side mirrors of his truck.
2. The longer it takes trucks to stop. A car traveling at 55 MPH can stop in 240 feet however a truck traveling at the same speed of 55 MPH, takes about 450+ feet to stop.
3. The more room they need to maneuver, such as making right turns. Trucks must swing wide to the left to safely negotiate a right turn. They cannot see motorcycles or cars behind or beside them.
4. The longer it takes an automobile or motorcycle to pass them.
5. As stated above, the more likely you are to be the "loser" in a collision.

- Truck drivers are always watching for smaller vehicles and motorcycles and working to avoid collisions. There are some techniques that you can use to help them and yourself share the road safely and reduce the likelihood of a collision with a large vehicle.
- Do NOT enter a roadway in front of a large vehicle. A truck or bus cannot slow down or stop as quickly as an automobile. By pulling out in front of these vehicles, you could easily cause a rear-end collision.
- Do NOT drive directly behind a truck or bus. Keep a reasonable distance between your motorcycle and the large vehicle ahead. This gives you a better view of the road to anticipate problems, and you will give yourself room for an emergency “out”.
- Do NOT cut abruptly in front of a large vehicle. If you are exiting, it will only take a few extra seconds to slow down and exit behind the truck. Cutting off a large vehicle on the interstate is particularly dangerous because of the high speeds being traveled.
- When passing a large vehicle, do NOT pull back over into the lane in front of the truck unless you can see the whole front of the vehicle in your rearview mirror. Complete your pass as quickly as possible and don’t stay alongside the truck. Do NOT slow down once you are in front of the truck.
- Position your vehicle so you are outside the truck driver’s “blind spots”, and be sure the truck driver can see YOU in the side rearview mirror. **If you can’t see the truck’s mirror, the driver cannot see YOU.** A truck’s blind spots are immediate in front, on either side of the care and up to 200 feet in the rear. A trucker may not be able to see the road directly in front of the cab. If the tractor has a long hood, the trucker may not be able to see the first 10-20 feet in front of the bumper-plenty of room for a motorcycle or car to slip unnoticed into a dangerous position.
- If you are stopped behind a truck on an uphill grade, stay to the left in your lane so the driver can see you. When stopped in a traffic lane, leave extra space in front of your car in case the truck rolls back when it starts to move.
- Pay close attention to the large vehicle’s turn signals. Trucks make wide right turns that require them to swing to the left before turning right. Always make sure you know which way the vehicle is turning before trying to pass.
- Do not linger beside a large vehicle because you may not be visible to the driver in the wide area the truck needs for maneuvering a turn.
- When you are near a Commercial Vehicle Weigh Station, avoid driving in the right lane so slow-moving trucks can easily merge back onto the roadway.
- Dim your lights at night. Bright lights reflected in the mirrors can blind the driver.
- Never underestimate the size and speed of approaching trucks and buses. Because of their large size they often appear to be traveling more slowly than their actual speed.

Risky Situations with Large Vehicles

Passing a Large Vehicle: A tractor-trailer or other combination vehicles take a longer time and requires more space to get around than a car.

- On a two-way road, leave yourself more time and space when passing these large vehicles. Check to your front and rear and move into the passing lane only if it is clear and you are in a legal passing zone.
- If the truck or bus driver blink their vehicle headlights after you pass, it's a signal that you are cleared to pull back in front of their vehicle. Move back only when you can see the front of the truck in your rearview mirror.
- Remember that on an upgrade or steep hill, a large vehicle usually loses speed.
- Because of their weight, trucks travel faster downhill and you may have to increase your speed to pass a truck on a downhill grade. Complete your pass as quickly as possible and don't stay alongside the truck. After you pass, maintain your speed. Don't pass a truck, then slow down, making the truck driver brake while traveling downhill.
- When a truck passes you, you can help the driver by keeping to the far side of your lane and reducing your speed slightly. NEVER SPEED UP AS A TRUCK OR BUS IS PASSING.
- When you meet a truck/bus coming from the opposite direction, keep as far as possible to the right of the road to avoid being sideswiped and to reduce wind turbulence between vehicles. The turbulence PUSHES vehicles APART. It does NOT suck them together.

The "Right Turn Squeeze": Trucks make wide right turns and often must leave an open space on the right side. Do NOT move into that space or try to pass a truck if it might be making a right turn. If you are between the truck and the curb, the driver may not be able to see you and your car can be crushed or sideswiped by the truck's trailer.

A Truck Backing Up: When a truck is trying to back into a loading dock, there may be no choice except to block the roadway for a short time. Never try to cross behind a truck when it is preparing to back up. This is a high-collision situation because you will be in the driver's blind spots. Give the driver plenty of room and wait patiently for the few minutes it takes to complete the maneuver.

Maintaining a Safety Cushion with Large Vehicles: As stated previously, trucks and buses need more maneuvering room and stopping distance than small vehicles. A good safety strategy is to leave plenty of space between your motorcycle and the larger vehicle, especially in these situations:

If you are driving in front of a truck, keep your speed up so you maintain a safe distance in front of the truck. Always indicate your intention to turn or change lanes early enough for the driver of the truck or bust to prepare for your maneuver. Avoid sudden moves, slow downs or stops.

Don't cut in front of a truck or bus, or you remove the driver's cushion of safety.

When following a truck or bus, it is a good idea to add more following distance.

If rain or water is standing on the road, spray from a truck passing you, or the truck you are trying to pass, will seriously reduce your vision. You should move as far away from the truck as you can, while staying in your lane.

Don't drive too close to trucks that are transporting hazardous materials, since they make frequent stops, such as railroad crossings.

Hills or Mountain Roads: Beware of dangers caused by slower moving trucks or buses on steep hills, inclines, or mountain roads. Watch for slow moving trucks or buses going both up and down hills. Heavy vehicles cannot maintain speed when climbing hills and must go slowly down hills to stay under control.

Watch for trucks or buses that may be in trouble. Smoking wheels or a high speed can be a sign of brake loss. If you encounter this situation, fall back and DO NOT pass.

Runaway Truck Ramps: These ramps are designed to stop out-of-control trucks or buses going down steep downgrades. Vehicles should never stop or park in these areas.

Learn the “NO-ZONES” for large vehicles:

Many motorists falsely assume that trucks and buses can see the road better because they sit twice as high as the driver of a small vehicle. While trucks and buses do enjoy a better forward view and have bigger mirrors, they have serious blind spots into which a small vehicle can disappear from view.

The **NO-ZONE** represents danger areas around trucks and buses where crashes are more likely to occur.

1. The area approximately up to 20 feet directly in front of a large vehicle is considered a **NO-ZONE**. When small vehicles cut in too soon after passing or changing lanes, then abruptly slow down, trucks and buses are forced to compensate with very little room or time to spare.
2. Unlike small vehicles, trucks and buses have deep blind spots directly behind them. Avoid following too closely in this **NO-ZONE**. If you stay in the rear blind spot of a large vehicle, you increase the possibility of a traffic crash. The driver of the bus or truck cannot see your motorcycle or car and your view of the traffic ahead will be severely reduced.
3. Large vehicles have much larger blind spots on both sides than cars do. When you drive in these blind spots for any length of time, the vehicle's driver cannot see you. When passing, even if the vehicle's driver knows you are there, remaining alongside a large vehicle too long makes it impossible for the driver to take evasive action if an obstacle appears in the roadway ahead.
4. Truck and bus drivers often cannot see vehicles directly behind or beside them when they are attempting to safely negotiate a right turn. If you cut in between the truck or bus and

the curb or shoulder to the right, it greatly increases the possibility of a crash in this “right turn squeeze”.

OVERHEAD VIEW OF “NO-ZONE” AREAS

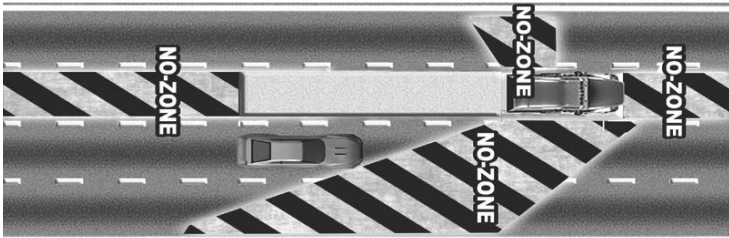

For more information and details on operating commercial vehicles, trucks or buses, pick up a copy of the Tennessee Commercial Driver License Manual at any Department of Safety and Homeland Security Driver License Service Center located throughout the state. Also, more safety information is available through the Federal Motor Carrier Safety Administration at the following web sites:

www.sharetheroadsafely.org

www.nozone.org

www.fmcsa.dot.gov

OR –

Tennessee Trucking Association
4531 Trousdale Drive
Nashville, TN 37204
615-777-2882
Fax: 615-777-2024

SHARING THE ROAD WITH SLOW MOVING VEHICLES AND EQUIPMENT

Certain slow-moving farm vehicles, construction equipment and vehicles drawn by animals may share our roadways. Use caution and prepare to slow down when approaching and passing slow-moving vehicles from the rear.

Closing Speeds

Normal speeds for slow-moving vehicles may range from 5 to 20 mph. When a vehicle traveling at normal highway speed approaches a slow-moving vehicle from the rear, the speed differential will dramatically shorten the time it takes to reach the slow-moving vehicle.

Turns and Passing

Slow-moving vehicles may make wide turns and may turn right or left at any time into unmarked entrances. When approaching from the rear, stay a safe distance behind the vehicle until it is safe to pass, then be certain the driver has seen you and is aware of your intent to pass before you begin.

When lights are required for these slow moving vehicles, a self-luminous red lamp on the rear of the vehicle is normally visible for 500 feet to the rear. Other devices to identify slow-moving vehicles may include slow moving emblem reflectors, as well as rotating or oscillating red or amber lights. You may see this on slow-moving vehicles such as farm tractors, machinery, construction equipment or horse-drawn vehicles.

Lane Usage

Slower traffic must drive in the right-hand lane. The left lane is for passing and turning. Slow-moving vehicles may be wider than the lane width. It may be necessary for these wide vehicles to temporarily move into an adjoining lane to avoid roadside obstructions.



SHARING THE ROAD WITH BICYCLES

On most roadways, bicyclists have the same rights and responsibilities as other roadway users. Bicyclists are prohibited on limited-access highways, expressways and certain other marked roadways.

Information and safety tips motorcyclists should know about sharing the road with bicyclists:

- When passing and overtaking a bicyclist proceeding in the same direction, do so slowly and leave at least a distance between you and the bicycle of not less than 3 feet. **It's the law in Tennessee!** Also be sure to maintain this clearance until safely past the overtaken bicycle.

- Bicyclists are required to travel in the same direction as vehicles.
- Bicyclists should travel just to the right of faster moving traffic. However, certain hazards, such as rough surfaces, debris, drainage grates or a narrow traffic lane, may require bike riders to move toward the center of the lane.
- Drivers must yield the right-of-way to a bicyclist just as they would to another vehicle.
- A motorcycle should not park or drive in marked bike lanes. When following bicyclists, give them plenty of room and be prepared to stop quickly. Use extra caution during rainy and icy weather. At night do not use high beams when you see an oncoming bicycle rider.
- When you are turning left on your motorcycle and there is a bicyclist entering the intersection from the opposite direction, the motorcyclist should wait for the bicyclist to pass before making the turn. Also, if your motorcycle is sharing the left turn lane with a bicyclist, stay behind them until they have safely completed their turn.
- If you are turning right on your motorcycle and a bicyclist is approaching on the right, let the bicyclist go through the intersection first before making a right turn. Remember to always signal your turns.

SHARING THE ROAD WITH PEDESTRIANS

As a driver you must recognize the special safety needs of pedestrians. **Any person afoot or using a motorized or non-motorized wheelchair are considered a pedestrian by state law.** You should be especially alert for young, elderly, disabled and intoxicated pedestrians. They are the most frequent victims in pedestrian related collisions.

Generally, pedestrians have the right-of-way at all intersections. There is a crosswalk at every intersection, even if painted lines and boundaries do not mark the crossing. Crosswalks are intended to encourage people to cross only at certain locations. As you know, some people will cross at locations other than cross walks. As the person controlling the potentially dangerous machine, it's your job to "play it safe" where pedestrians are concerned and protect them when you see they may be in danger. Regardless of the rules of the road or right-of-way, the law specifically requires YOU, as a driver, to exercise great care and extreme caution to avoid striking pedestrians.

Without a vehicle or protective equipment, pedestrians are most at risk in traffic. Drivers and pedestrians are both responsible for traffic safety. A simple rule is that motorcyclists and drivers should always be prepared to yield the right-of way to pedestrians.

Crossing a Road

When traffic-control signals are not in place or in operation, motorcyclists shall yield the right-of-way, slowing down or stopping if need be, to yield to a pedestrian crossing the roadway within a crosswalk when the pedestrian is upon the half of roadway upon which the vehicle is traveling, or when the pedestrian is approaching so closely as to be in danger.

Roadways

Motorcyclists should exercise due care to avoid colliding with any pedestrian, jogger or runner. Motorcyclists should give warning by sounding the horn when necessary and shall exercise precaution upon observing any child or any confused or incapacitated person upon a roadway. Pedestrians must not walk on a roadway unless there is no sidewalk or shoulder next to it. Under these conditions, pedestrians should always walk as close to the outside edge of the road as possible. In two-way traffic, pedestrians should walk facing oncoming traffic. If a highway does not have a sidewalk but has a shoulder, pedestrians should always walk on the shoulder as far from the roadway as possible. Pedestrians should not walk on a highway when under the influence of alcohol or other drugs.

Welcome to the Seventeenth Edition of the MSF Motorcycle Operator Manual (MOM). Operating a motorcycle safely in traffic requires special skills and knowledge. The Motorcycle Safety Foundation (MSF) has made this manual available to help novice motorcyclists reduce their risk of having a crash. The manual conveys essential safe riding information and has been designed for use in licensing programs. While designed for the novice, all motorcyclists can benefit from the information this manual contains.

The original Motorcycle Operator Manual was developed by the National Public Services Research Institute (NPSRI) under contract to the National Highway Traffic Safety Administration (NHTSA) and within the terms of a cooperative agreement between NHTSA and the MSF. The manual and related tests were used in a multi-year study of improved motorcycle operator licensing procedures, conducted by the California Department of Motor Vehicles under contract to NHTSA.

The purpose of this manual is to educate riders and to help them avoid crashes while safely operating either a standard two-wheel motorcycle or a three-wheel motorcycle.

This latest edition has undergone significant improvements, and contains new, more in-depth information, designed to:

- Guide riders in preparing to ride safely
- Develop effective street strategies
- Give riders more comprehensive understanding of safe group riding practices
- Describe in detail best practices for carrying passengers and cargo

In promoting improved licensing programs, the MSF works closely with state licensing agencies. The Foundation has helped more than half the states in the nation adopt the Motorcycle Operator Manual for use in their licensing systems.

Improved licensing, along with high quality motorcycle rider education and increased public awareness, has the potential to reduce crashes. Staff at the Foundation are available to assist governmental and private agencies in efforts to improve motorcycle safety.



Tim Buche
President,
Motorcycle Safety Foundation



CONTENTS

THE RIDER AND THE MOTORCYCLE	4	BEING IN SHAPE TO RIDE	
PREPARING TO RIDE		Why This Information Is Important	42
Wear the Right Gear	5	Alcohol and Other Drugs in Motorcycle Operation	42
Know Your Motorcycle	7	Alcohol in the Body	42
Know Your Responsibilities	10	Alcohol and the Law	44
RIDE WITHIN YOUR ABILITIES		Minimize the Risks	44
Basic Vehicle Control	11	Step in to Protect Friends	45
Keeping Your Distance	15	Marijuana and Motorcycle Operation	45
SEE	20	Fatigue	46
Intersections	21	EARNING YOUR LICENSE	47
Increasing Conspicuity	24	THREE-WHEEL SUPPLEMENT	
Crash Avoidance	27	Supplementary Information for Three-Wheel Motorcycles.....	49
Handling Dangerous Surfaces	30	Know Your Vehicle	49
Mechanical Problems	33	Basic Vehicle Control	51
Animals	34	Carrying Passengers and Cargo.....	54
Flying Objects	35	HAND SIGNALS	55
Getting Off the Road	35	T-CLOCS PRE-RIDE CHECKLIST	57
Carrying Passengers and Cargo	35		
Group Riding	38		

4 THE RIDER AND THE MOTORCYCLE

Motorcycling is a unique experience. Compared to a car, you don't sit in a motorcycle, you become part of it. Not as a passive driver, but as an active rider arcing into a string of smooth corners, playing along with the rhythm of the road; shifting, accelerating, and braking with precision. Whether you ride to and from work or prefer the camaraderie of a group ride on the weekend, motorcycling engages all your senses and creates an invigorating sense of freedom.

Along with that freedom comes responsibility. All states require some form of license endorsement demonstrating you possess a minimum level of skill and knowledge. This booklet and other motorcycle publications can help prepare you to be successful. You might also consider taking a formal hands-on training course, even if your state doesn't require that you complete one. You'll learn how to improve your riding skills and mental strategies, so you can be a safer, more alert rider.

The diagram above illustrates the complex environment that awaits

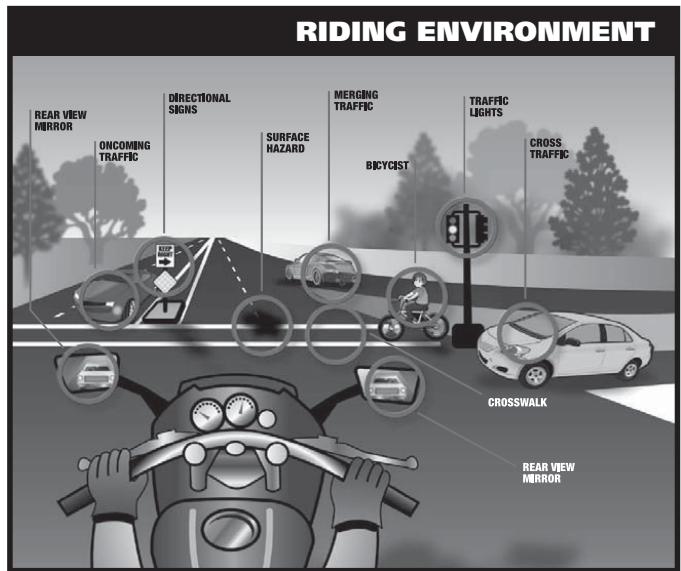

you, and supports the concept that, as the Motorcycle Safety Foundation says, "Safe riding depends as much on the mental skills of awareness and judgment as it does on a physical skill of maneuvering the machine."

Successfully piloting a motorcycle is a much more involved task than driving a car. Motorcycling requires a fine sense of balance and a heightened sense of awareness and position amidst other roadway users. A motorcycle responds more quickly to rider inputs than a car, but is also more sensitive to outside forces, like irregular road surfaces or crosswinds. A motorcycle is also less visible than a car due to its narrower profile, and offers far less protection by exposing its rider to other traffic and the elements. All these risks can be managed through study, training, and practice.

What you do before you start a trip goes a long way toward determining whether or not you'll get where you want to go safely. Before taking off on any trip, a safe rider makes a point to:

1. **Wear the right gear.**
2. **Become familiar with the motorcycle.**
3. **Check the motorcycle equipment.**
4. **Be a responsible rider.**

WEAR THE RIGHT GEAR

When you ride, your gear is "right" if it protects you. In any crash, you have a far better chance of avoiding serious injury if you wear:

- **A DOT-compliant helmet.**
- **Face or eye protection.**
- **Protective clothing.**

Helmet Use

Crashes can occur — particularly among untrained, beginning riders. And one out of every five motorcycle crashes results in head or neck injuries. Head injuries are just as severe as neck injuries — and far more common. Crash analyses show that head and neck injuries account for a majority of serious and fatal injuries to motorcyclists. Research also shows that, with few exceptions, head and neck injuries are reduced by properly wearing a quality helmet.

Some riders don't wear helmets because they think helmets will limit their view to the sides. Others wear helmets only on long trips or when riding at high speeds. But, here are some facts to consider:

- **A DOT-compliant helmet** lets you see as far to the sides as necessary. A study of more than 900 motorcycle crashes, where 40% of the riders wore helmets, did not find even one case in which

a helmet kept a rider from spotting danger.

- **Most crashes happen** on short trips (less than five miles long), just a few minutes after starting out.
- **Most riders** are riding slower than 30 mph when a crash occurs. At these speeds, helmets can cut both the number and the severity of head injuries by half.

No matter what the speed, helmeted riders are three times more likely to survive head injuries than those not wearing helmets at the time of the crash. The single most important thing you can do to improve your chances of surviving a crash is to wear a securely-fastened, quality helmet.

Helmet Selection

There are two primary types of helmets, providing two different levels of coverage: three-quarter and full face.

Whichever style you choose, you can get the most protection by making sure that the helmet:

- **Is designed to meet U.S.** Department of Transportation (DOT) and state standards. Helmets with a label from the Snell Memorial Foundation also give you an assurance of quality.
- **Fits snugly**, all the way around.
- **Has no obvious defects** such as cracks, loose padding or frayed straps.

Whatever helmet you decide on, keep it securely fastened on your head when you ride. Otherwise, if you are involved in a crash, it's likely to fly off your head before it gets a chance to protect you.

Eye and Face Protection

A plastic impact-resistant faceshield can help protect your whole face in a crash. It also protects you from wind, dust, dirt, rain, insects and pebbles thrown up from cars ahead. These problems are distracting and can be painful. If you have to deal with them, you can't devote your full attention to the road.

Goggles protect your eyes, though they won't protect the rest of your face like a faceshield does. A windshield is not a substitute for a faceshield or goggles. Most windshields will not protect your eyes from the wind. Neither will eyeglasses or sunglasses. Glasses won't keep your eyes from watering, and they might blow off when you turn your head while riding.

To be effective, eye or faceshield protection must:

- **Be free** of scratches.
- **Be resistant** to penetration.
- **Give a clear view** to either side.
- **Fasten securely**, so it does not blow off.
- **Permit air** to pass through, to reduce fogging.
- **Permit enough room** for eyeglasses or sunglasses, if needed.

Tinted eye protection should not be worn when little light is available.

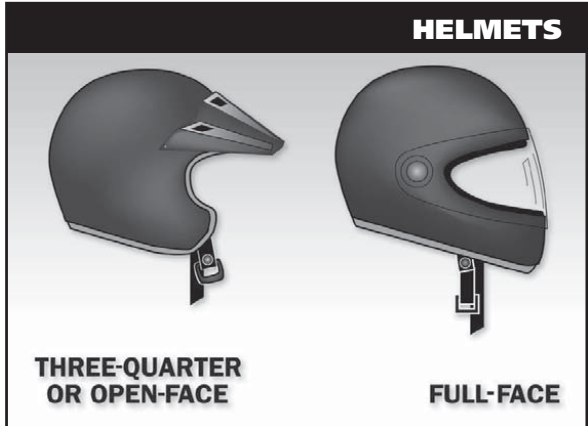

Clothing

The right clothing protects you in a collision. It also provides comfort, as well as protection from heat, cold, debris and hot and moving parts of the motorcycle. It can also make you more visible to others.

- **Jacket and pants** should cover arms and legs completely. They should fit snugly enough to keep from flapping in the wind, yet loosely enough to move freely. Leather offers the most protection. Sturdy synthetic material provides a lot of protection as well. Wear a jacket even in warm weather to prevent dehydration. Many are designed to protect without getting you overheated, even on summer days. Some riders choose jackets and pants with rigid "body armor" inserts in critical areas for additional protection.
- **Boots or shoes** should be high and sturdy enough to cover your ankles and give them support. Soles should be made of hard, durable, slip-resistant material. Keep heels short so they do not catch on rough surfaces. Tuck in laces so they won't catch on your motorcycle.

- **Gloves** allow a better grip and help protect your hands in a crash. Your gloves should be made of leather or similar durable material.
- **Hearing protection** reduces noise while allowing you to hear important sounds such as car horns or sirens. Long term exposure to engine and wind noise can cause permanent hearing damage even if you wear a full face helmet. Whether you choose disposable foam plugs or reusable custom molded devices, be sure you adhere to state laws regarding hearing protection.

In cold or wet weather, your clothes should keep you warm and dry, as well as protect you from injury. You cannot control a motorcycle well if you are numb. Riding for long periods in cold weather can cause severe chill and fatigue. A winter jacket should resist wind and fit snugly at the neck, wrists and waist. Good-quality rainsuits designed for motorcycle riding resist tearing apart or ballooning up at high speeds.

CLOTHING



KNOW YOUR MOTORCYCLE

There are plenty of things on the highway that can cause you trouble. Your motorcycle should not be one of them. To make sure that your motorcycle won't let you down:

- **Start** with the right motorcycle for you.
- **Read** the owner's manual.
- **Be familiar** with the motorcycle controls.
- **Check** the motorcycle before every ride.
- **Keep** it in safe riding condition between rides.
- **Avoid** add-ons and modifications that make your motorcycle harder to handle.

The Right Motorcycle For You

First, make sure your motorcycle is right for you. It should "fit" you. Your feet should reach the ground while you are seated on the motorcycle, and the controls should be easy to operate. Smaller motorcycles are usually easier for beginners to operate.

At a minimum, your street-legal motorcycle should have:

- **Headlight, taillight and brakelight.**

TEST YOURSELF

1

A plastic shatter-resistant face shield:

- Is not necessary if you have a windshield.
- Only protects your eyes.
- Helps protect your whole face.
- Does not protect your face as well as goggles.

Answer - page 48

- Front and rear brakes.
- Turn signals.
- Horn.
- Two mirrors.

Borrowing and Lending

Borrowers and lenders of motorcycles, beware. Crashes are more likely to occur among beginning riders — especially in the first months of riding. Riding an unfamiliar motorcycle adds to the problem. If you borrow a motorcycle, get familiar with it in a controlled area. And if you lend your motorcycle to friends, make sure they are licensed and know how to ride before allowing them out into traffic.

No matter how experienced you may be, ride extra carefully on any motorcycle that's new or unfamiliar to you. More than half of all crashes

involve riders with less than five months of experience on their motorcycle.

Get Familiar with the Motorcycle Controls

Make sure you are completely familiar with the motorcycle before you take it out on the street. Be sure to review the owner's manual. This is particularly important if you are riding a borrowed motorcycle.

If you are going to use an unfamiliar motorcycle:

- **Make all the checks** you would on your own motorcycle.
- **Find out where everything is**, particularly the turn signals, horn, headlight switch, fuel-supply valve and engine cut-off switch. Find and operate these items without having to look for them.

MOTORCYCLE CONTROLS

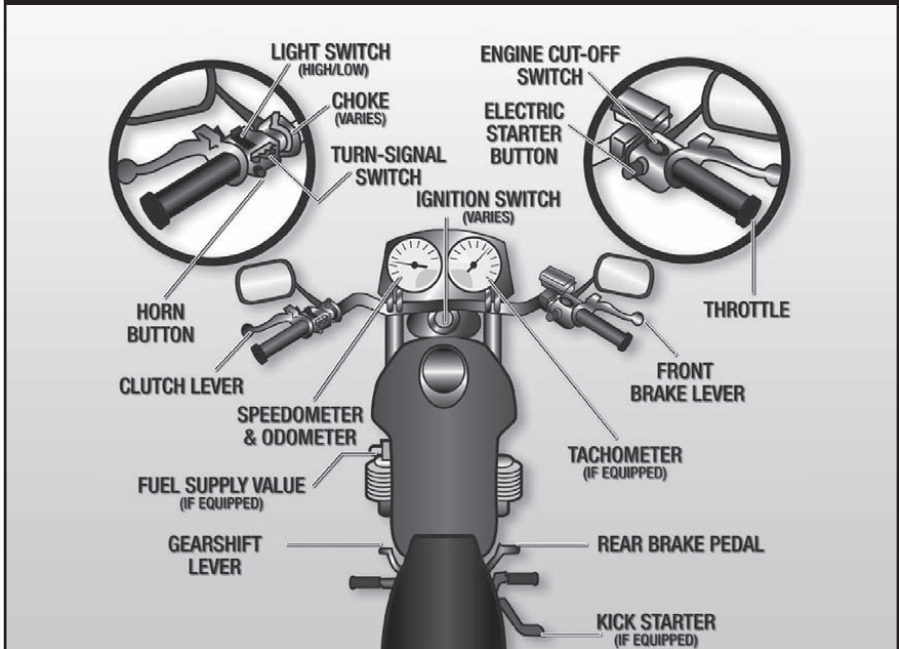

- **Know the controls.** Work the throttle, clutch, brakes, and shifter a few times before you start riding.
- **Ride very cautiously** and be aware of surroundings. Accelerate gently, take turns more slowly and leave extra room for stopping.

Check Your Motorcycle

A motorcycle needs more frequent attention than a car. A minor technical failure on a car is seldom more than an inconvenience for the driver. The same failure on a motorcycle may result in a crash or having to leave your motorcycle parked on the side of the road. If anything's wrong with your motorcycle, you'll want to find out about it before you get in traffic.

The primary source of information about how a motorcycle should be inspected and maintained is its owner's manual. Be sure to absorb all of its important information. A motorcycle will continue to ride like new if it is properly maintained and routine inspections become part of its maintenance cycle.

A pre-ride inspection only takes a few minutes and should be done before every ride to prevent problems. It's quick and easy to check the critical components and should be as routine and automatic as checking the weather forecast before heading out for the day. A convenient reminder developed by MSF is T-CLOCSSM. There is a T-CLOCS "tear-out" sheet at the back of this manual for you to keep with you when you ride. A T-CLOCS inspection should be conducted before every ride, and includes checks of:

T — Tires and Wheels

- Check tire inflation pressure, treadwear and general condition of sidewalls and tread surface.

- Try the front and rear brake levers one at a time. Make sure each feels firm and holds the motorcycle when fully applied.

C — Controls

- Make sure the clutch and throttle operate smoothly. The throttle should snap back to fully closed when released. The clutch should feel tight and should operate smoothly.
- Try the horn. Make sure it works.

L — Lights and Electrics

- Check both headlight and taillight. Test your switch to make sure both high and low beams work.
- Turn on both right and left hand turn signals. Make sure all lights are working properly.
- Try both brakes and make sure each one turns on the brake light.
- Clean and adjust your mirrors before starting. It's difficult to ride with one hand while you try to adjust a mirror. Adjust each mirror so you can see the lane behind and as much as possible of the lane next to you. When properly adjusted, a mirror may show the edge of your arm or shoulder – but it's the road behind you and to the side that are most important.

O — Oil and Other Fluids

- Check engine oil and transmission fluid levels.
- Check the brake hydraulic fluid and coolant level weekly.
- Be sure your fuel valve is open before starting out. With the fuel valve closed, your motorcycle may start with only the fuel that is still in the lines, but will stall once the lines are empty.

- Look underneath the motorcycle for signs of an oil or fuel leak.

C — Chassis

- Check the front suspension. Ensure there is no binding. The rear shocks and springs should move smoothly.
- Be sure the chain or belt is adjusted according to the manufacturer's specifications and that the sprockets are not worn or damaged.

S — Stands

- Ensure the side stand operates smoothly and that the spring holds it tightly in the up position. If equipped, the center stand should also be held firmly against the frame whenever the motorcycle is moving.

Additionally, regular maintenance such as tune-ups and oil changes are as important for a motorcycle as routine checkups by your doctor are for you. Wear and tear is normal with use; routine maintenance will help prevent costly breakdowns. The schedule for regular upkeep for motorcycle parts and controls is contained in your motorcycle's owner's manual.

KNOW YOUR RESPONSIBILITIES

"Accident" implies an unforeseen event that occurs without fault or negligence. In traffic, that is not the case. In fact, most people involved in a crash can claim some responsibility for what takes place.

Consider a situation where someone decides to drive through an intersection on a yellow light turning red. Your light turns green. You pull into the intersection without checking for possible traffic. That is all it takes for the two of you to crash. It was the driver's responsibility to stop, and it was your

responsibility to look before pulling out. Both of you are at fault. Someone else might be the first to start the chain of events leading to a crash, but it doesn't leave any of us free of responsibility.

As a rider you can't be sure that other operators will see you or yield the right of way. To lessen your chances of a crash occurring:

- **Be visible** — wear proper clothing, use your headlight, ride in the best lane position to see and be seen.
- **Communicate your intentions** — use the proper signals, brake light and lane position.
- **Maintain an adequate space cushion** — when following, being followed, lane sharing, passing and being passed.
- **Search your path** of travel 12 seconds ahead.
- **Identify and separate** hazards.
- **Be prepared to act** — remain alert and know how to carry out proper crash-avoidance skills.

Blame doesn't matter when someone is injured in a crash. The ability to ride aware, make critical decisions and carry them out separates responsible riders from the rest. Remember, it is up to you to keep from being the cause of, or an unprepared participant in, any crash.

TEST YOURSELF

2

More than half of all crashes:

- Occur at speeds greater than 35mph.
- Happen at night.
- Are caused by worn tires.
- Involve riders who have less than five months of experience on their motorcycles.

Answer - page 48

This manual cannot teach you how to control direction, speed or balance. That's something you can learn only through practice, preferably in a formal course of instruction like an MSF *RiderCourse*. But control begins with knowing your abilities and riding within them, along with knowing and obeying the rules of the road.

BASIC VEHICLE CONTROL

Body Position

To control a motorcycle well:

- **Posture** — Position yourself comfortably so you are able to operate all the controls and can use your arms to steer the motorcycle, rather than to hold yourself up. This helps you bond with your motorcycle and allows you to react quickly to hazards.
- **Seat** — Sit far enough forward so that arms are slightly bent when you hold the handgrips. Bending your arms permits you to press on the handlebars without having to stretch.
- **Hands** — Hold the handgrips firmly to keep your grip over rough surfaces. Start with your right wrist flat. This will help you keep from accidentally using too much

throttle. Also, adjust the handlebars so your hands are even with or below your elbows. This permits you to use the proper muscles for precision steering.

- **Knees** — Keep your knees against the gas tank to help you keep your balance as the motorcycle turns.
- **Feet** — Keep your feet firmly on the footrests to maintain balance. Don't drag your feet. If your foot catches on something, you could be injured and it could affect your control of the motorcycle. Keep your feet near the controls so you can get to them fast if needed. Also, don't let your toes point downward — they may get caught between the road and the footrests.

Shifting Gears

There is more to shifting gears than simply getting the motorcycle to pick up speed smoothly. Learning to use the gears when downshifting, turning or starting on hills is equally important for safe motorcycle operation.

The gearshift lever is located in front of the left footrest and is operated by the left foot. To shift "up" to a higher gear, position your foot under the shift lever and lift. To downshift, press the shift lever down. The shift lever changes one gear each time it is lifted or pressed down. Whenever the lever is released, spring loading returns it to center, where the mechanism resets for the next shift up or down. A typical gear pattern is 1-N-2-3-4-5. The N is

HOLDING HANDGRIPS



for neutral, which is selected by either a “half lift” from 1st gear or a “half press” from 2nd gear. Most motorcycles have five gears, but some have four or six gears.

SHIFTING GEARS

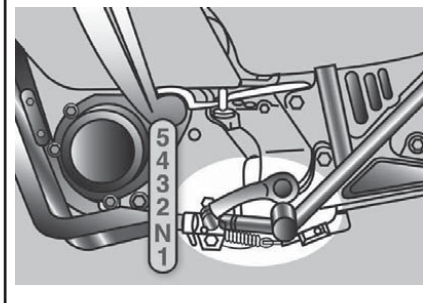

As your motorcycle increases speed, you will need to shift up to a higher gear. Shift up well before the engine RPM reaches its maximum recommended speed. As a general rule, shift up soon enough to avoid over-revving the engine, but not so soon to cause the engine to lug.

When upshifting, use a 3-step

process: 1) Roll off the throttle as you squeeze the clutch lever, 2) lift the shift lever firmly as far as it will go, 3) smoothly ease out the clutch and adjust the throttle. Once the shift is completed, release the shift lever to permit it to reset for the next shift.

You should shift down through the gears with the clutch as you slow or stop, and can also shift down when you need more power to accelerate.

Make certain you are riding slowly enough when you shift into a lower gear. If not, the motorcycle will lurch, and the rear wheel may skid. When riding downhill or shifting into first gear you may need to use the brakes to slow

enough before downshifting safely.

When downshifting, use a 3-step

process: 1) Roll off the throttle as you squeeze the clutch lever, 2) press the shift lever down firmly, 3) ease out the clutch lever as you roll on the throttle. Once the shift is completed, release the shift lever to permit it to reset for the next shift. Rolling on the throttle slightly while smoothly easing out the clutch can help the engine come up to speed more quickly and make the downshift smoother. Shifting to a lower gear causes an effect similar to using the brakes. This is known as engine braking. To use engine braking, shift down one gear at a time and ease out the clutch through the friction zone between each downshift. Keep the clutch in the friction zone until the engine speed stabilizes. Then ease out the lever fully until ready for the next downshift. Usually you shift gears one at a time, but it is possible to shift through more than one gear while the clutch is squeezed.

Remain in first gear while you are stopped so that you can move out quickly if you need to.

Work toward a smooth, even clutch release, especially when downshifting. It is best to change gears before entering a turn. However, sometimes shifting while in the turn is necessary. If so, remember to do so smoothly. A sudden change in power to the rear wheel can cause a skid.

Braking

Improper braking technique remains a significant contributing factor in many motorcycle crashes. Your motorcycle has two brake controls: one for the front wheel and one for the rear wheel. Always use both brakes every time you

slow or stop. The front brake is more powerful and can provide at least 70% of your total stopping power. The front brake is safe to use if you use it properly.

Maximum straight-line braking is accomplished by fully applying both front and rear brakes without locking either wheel.

To do this:

- **Squeeze the front brake** smoothly, firmly and with progressively more force. Do not grab the brake lever or use abrupt pressure.
- **As the motorcycle's weight** transfers forward, more traction becomes available at the front wheel, so the front brake can be applied harder after braking begins.
- **Keep your knees against the** tank and your eyes up, looking well ahead. This helps you stop the motorcycle in a straight line.
- **Apply light-to-lighter pressure** to the rear brake pedal to prevent a rear wheel skid. As weight transfers forward less traction is available at the rear. Use less rear brake pressure.

Using both brakes for even "normal" stops will permit you to develop the proper habit or skill of using both brakes properly in an emergency. Squeeze the front brake and press down on the rear. Grabbing at the front brake or jamming down on the rear can cause the brakes to lock, resulting in control problems.

Braking in a Corner

Any time a motorcycle is leaned over, the amount of traction available for braking is reduced. The greater the lean angle, the more the possibility of the tires losing traction.

To stop as quickly and as safely as possible in a curve, and depending on road and traffic conditions, try to get the motorcycle as perpendicular to the road as possible, then brake. If conditions do not allow, brake smoothly and gradually, but do not apply as much braking force as you would if the motorcycle were straight up. As you slow, you can reduce your lean angle, and as more traction becomes available for braking, you can more firmly apply the brakes, so that by the time the motorcycle is stopped, the motorcycle is straight up, and the handlebars are squared.

Linked and Integrated Braking Systems

Some motorcycles have linked braking which connects the front and rear brakes on the motorcycle and applies braking pressure to both brakes when either the front lever or rear pedal is applied. An integrated braking system is a variation of the linked system in which partial front braking is applied whenever the rear brake is activated. Consult your owner's manual for a detailed explanation on the operation and effective use of these systems.

Anti-Lock Braking Systems (ABS)

ABS is designed to prevent wheel lock-up and avoid skids when stopping in straight-line, panic situations. ABS operates when maximum pressure on both the front and rear brake controls is applied. If electronic sensors detect the possibility of a wheel lock, brake hydraulic pressure is released then reapplied to maintain maximum braking effectiveness.

The system is capable of releasing and reapplying pressure more than 15 times per second.

Turning

Approach turns and curves with caution. Riders often try to take curves or turns too fast. When they can't hold the turn, they end up crossing into another lane of traffic or going off the road. Or, they overreact and brake too hard, causing a skid and loss of control.

Use four steps for better control:

- **SLOW** — Reduce speed before the turn by closing the throttle and, if necessary, applying both brakes.
- **LOOK** — Look through the turn to where you want to go. Turn just your head, not your shoulders, and keep your eyes level with the horizon.
- **PRESS** — To turn, the motorcycle must lean. To lean the motorcycle, press on the handgrip in the direction of the turn. Press left handgrip — lean left — go left. Press right handgrip — lean right — go right. The higher the speed in a turn, or the sharper the turn, the greater the lean angle needs to be.
- **ROLL** — Roll on the throttle to maintain or slightly increase speed. This helps stabilize the motorcycle.

In normal turns, the rider and the motorcycle should lean together at the same angle.

NORMAL TURNS

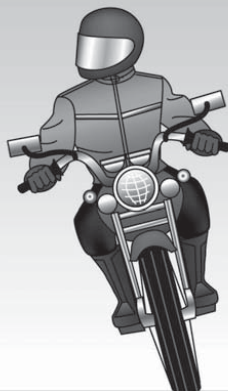

In slow, tight turns, counterbalance by leaning the motorcycle only and keeping your body straight.

SLOW, TIGHT TURNS



TEST YOURSELF

3

When riding, you should:

- Turn your head and shoulders to look through turns.
- Keep your arms straight.
- Keep your knees away from the gas tank.
- Turn just your head and eyes to look where you are going.

Answer - page 48

KEEPING YOUR DISTANCE

The best protection you can have is distance — a “cushion of space” — separating yourself from other vehicles on the roadway. This will provide you with a clear view of emerging traffic situations, so that if someone else makes a mistake, you will have:

- More time to respond.
- More space to maneuver, including an escape route if necessary.

Lane Positions

Successful motorcyclists know that they are safer when clearly seen. In some ways the size of the motorcycle can work to your advantage. Each traffic lane gives a motorcycle three paths of travel, as indicated in the illustration.

Your lane position should help you:

- Increase your ability to see and be seen.
- Avoid others’ blind spots.
- Avoid surface hazards.
- Protect your lane from other drivers.
- Communicate your intentions.

- Avoid windblast from other vehicles.
- Provide an escape route.
- Set up for turns.

Many motorcyclists consider the left third of the lane – the left tire track of automobiles – to be their default lane position. You should then consider varying your lane position as conditions warrant, keeping in mind that no portion of the lane need be avoided — including the center.

You should position yourself in the portion of the lane where you are most likely to be seen and you can maintain a space cushion around you. Change position as traffic situations change. Ride in path 2 or 3 if vehicles and other potential problems are on your left only. Remain in path 1 or 2 if hazards are on your right only. If vehicles are being operated on both sides of you, the center of the lane, path 2, is usually your best option.

Remember, the center third of the lane is the place where debris and oil drippings from cars collect and where hazards such as manhole covers are located. Unless the road is wet, the

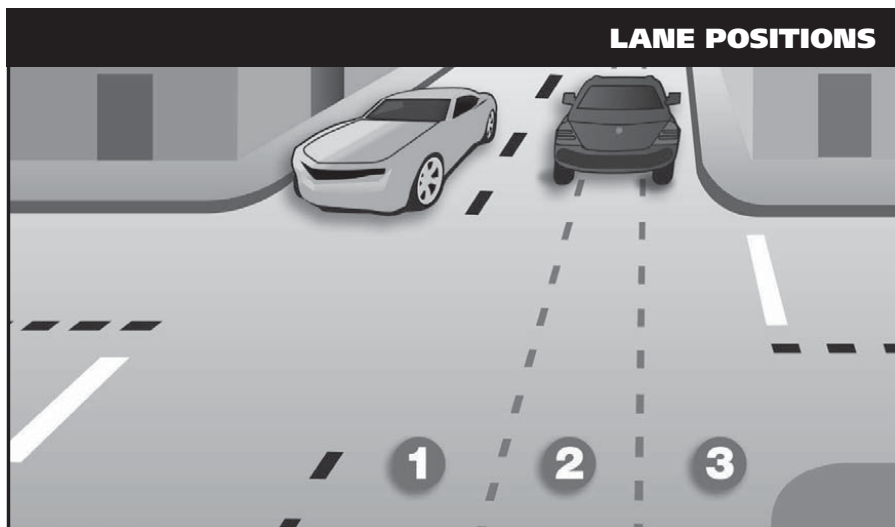

FOLLOWING



average center strip permits adequate traction to ride on safely. You can operate to the left or right of the grease strip and still be within the center third of the traffic lane. Avoid riding on big buildups of oil and grease usually found at busy intersections or tollbooths.

Experienced riders rely on their own best judgment and instincts. One absolute, however, is to avoid riding in another vehicle's blind spot.

Following Another Vehicle

"Following too closely" is a factor in crashes involving motorcyclists. In traffic, motorcycles need as much distance to stop as cars. Normally, **a minimum of two seconds** distance should be maintained behind the vehicle ahead.

To gauge your following distance:

- **Pick out a marker**, such as a pavement marking or lamppost, on or near the road ahead.
- **When the rear bumper** of the vehicle ahead passes the marker,

count off the seconds: "one-thousand-one, one-thousand-two."

- **If you reach the marker** before you reach "two," you are following too closely.

A two-second following distance leaves a minimum amount of space to stop or swerve if the driver ahead stops suddenly. It also permits a better view of potholes and other hazards in the road.

A larger cushion of space is needed if your motorcycle will take longer than normal to stop. If the pavement is slippery, if you cannot see through the vehicle ahead, or if traffic is heavy and someone may squeeze in front of you, open up a three-second or more following distance.

Keep well behind the vehicle ahead even when you are stopped. This will make it easier to get out of the way if someone bears down on you from behind. It will also give you a cushion of space if the vehicle ahead starts to back up for some reason.

When behind a car, ride where the driver can see you in the rearview mirror. Riding in the center portion of the lane should put your image in the middle of the rearview mirror — where a driver is most likely to see you.

Riding at the far side of a lane may permit a driver to see you in a sideview mirror. But remember that most drivers don't look at their sideview mirrors nearly as often as they check the rearview mirror. If the traffic situation allows, the center portion of the lane is usually the best place for you to be seen by the drivers ahead and to prevent lane sharing by others.

Being Followed

Speeding up to lose someone following too closely only ends up with someone tailgating you at a higher speed.

A better way to handle tailgaters is to get them in front of you. When someone is following too closely, change lanes and let them pass. If you can't do this, slow down and open up extra space ahead of you to allow room for both you and the tailgater to stop. This will also encourage them to pass. If they don't pass, you will have given yourself and the tailgater more time and space to react in case an emergency does develop ahead.

Passing and Being Passed

Passing and being passed by another vehicle is not much different than with a car. However, visibility is more critical. Be sure other drivers see you, and that you see potential hazards.

Passing

1. **Ride in the left portion** of the lane at a safe following distance to increase your line of sight and make you more visible. Signal and check for oncoming traffic. Use your mirrors and turn your head to look for traffic behind.
2. **When safe**, move into the left lane and accelerate. Select a lane position that doesn't crowd the car and provides space to avoid hazards in your lane.
3. **Ride through the blind spot** as quickly as possible.
4. **Signal again**, and complete mirror and headchecks before returning to your original lane and then cancel the signal.

Remember, passes must be completed within posted speed limits, and only where permitted. Know your signs and road markings!

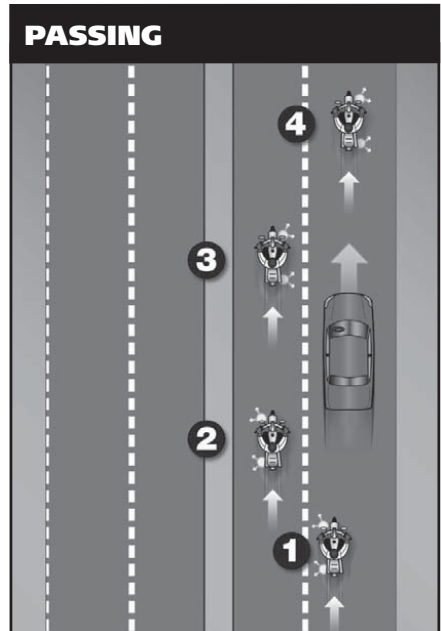

Being Passed

When you are being passed from behind, stay in the center portion of your lane. Riding close to the passing vehicle could put you in a hazardous situation.

Avoid being hit by:

- **The other vehicle** — A slight mistake by you or the passing driver could cause a sideswipe.
- **Extended mirrors** — Some drivers forget that their mirrors hang out farther than their fenders.
- **Objects thrown from windows** — Even if the driver knows you're there, a passenger may not see you and might toss something on you or the road ahead of you.
- **Blasts of wind from larger vehicles** — They can affect your control. You have more room for error if you are in the middle portion when hit by this blast than if you are on either side of the lane.

Do not move into the portion of the lane farthest from the passing vehicle. It might invite the other driver to cut back into your lane too early.

Lane Sharing

Cars and motorcycles need a full lane to operate safely. Lane sharing is usually prohibited.

Riding between rows of stopped or moving cars in the same lane can leave you vulnerable to the unexpected. A hand could come out of a window; a door could open; a car could turn suddenly. Discourage lane sharing by others. Keep a center-portion position whenever drivers might be tempted to squeeze by you. Drivers are most tempted to do this:

- **In heavy**, bumper-to-bumper traffic.
- **When they** want to pass you.
- **When you** are preparing to turn at an intersection.
- **When you** are moving into an exit lane or leaving a highway.

BEING PASSED

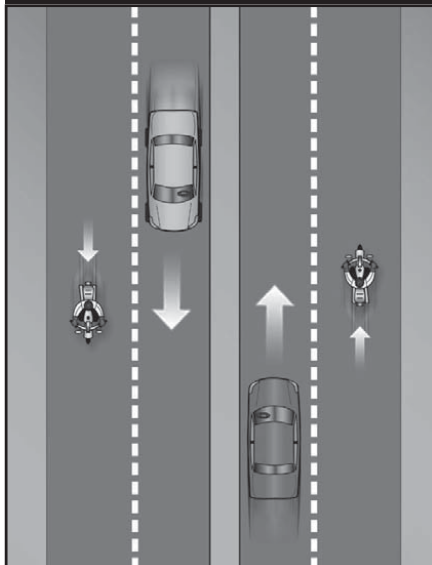

TEST YOURSELF

4

Usually, a good way to handle tailgaters is to:

- Change lanes and let them pass.
- Use your horn and make obscene gestures.
- Speed up to put distance between you and the tailgater.
- Ignore them.

Answer - page 48

Merging Cars

Drivers on an entrance ramp may not see you on the highway. Give them plenty of room. Change to another lane if one is open. If there is no room for a lane change, adjust speed to open up space for the merging driver.

Cars Alongside

Do not ride next to cars or trucks in other lanes if you do not have to. You might be in the blind spot of a car in the next lane, which could switch into your lane without warning. Cars in the next lane also block your escape if you come upon danger in your own lane. Speed up or drop back to find a place clear of traffic on both sides.

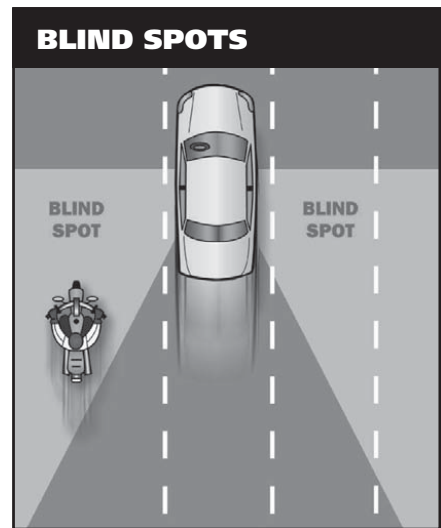
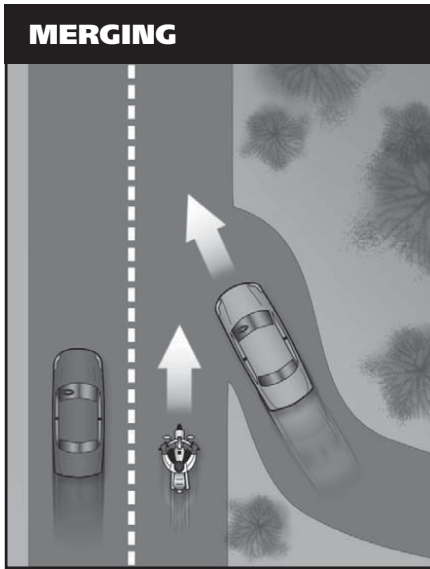

SEE

Good, experienced riders are always aware of what is going on around them. They reduce their risk by using MSF's three-step SEE strategy:

- **S**earch
- **E**valuate
- **E**xecute

SEE will help you assess what is going on in traffic so you can plan and implement the safest course of action as traffic situations change. Let's look at each of these steps.

Search

How assertively you search, and how much time and space you have, can eliminate or minimize risk. As you search, focus on finding potential escape routes, especially in or around intersections, shopping areas and school and construction zones.

One way to search is to use your "RiderRadar" to aggressively scan the environment ahead of you, to the sides, and behind you to avoid potential hazards even before they arise. There are three "lead times" experienced riders consider. First, be alert and scan for hazards that are about 2 seconds ahead of you, or within your following distance. Scanning your 4-second immediate path can allow you time for a quick response if something should go wrong. Anything that is within 4 seconds of your path is considered immediate because 4 seconds is

RIDER RADAR

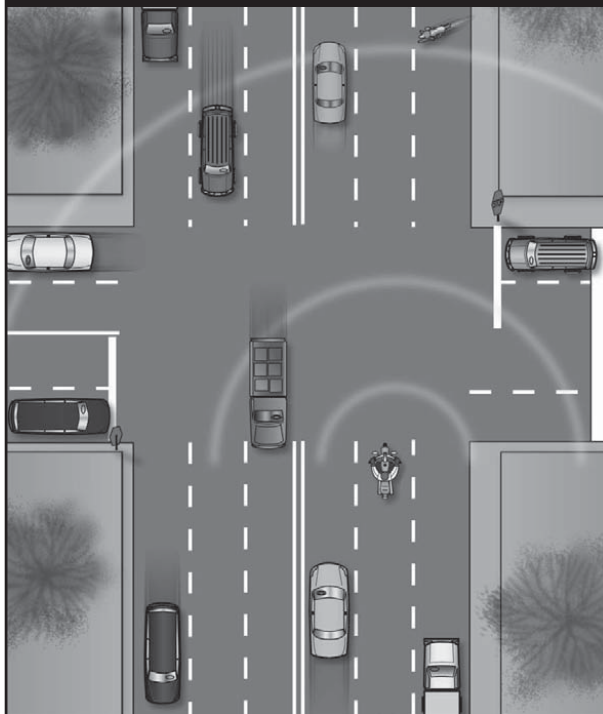

considered enough time and space to swerve and/or brake for fixed hazards or for someone or something entering your path of travel.

Finally, experienced riders search for hazards that are further out, looking ahead to an area it would take about 12 seconds to reach. This provides time to prepare for a situation before it becomes immediate.

Using the SEE strategy will help you to **Search** for a variety of factors such as:

- **Oncoming traffic** that may turn left in front of you.
- **Traffic** coming from the left and from the right.
- **Traffic** approaching from behind.

- **Hazardous** road conditions that require you to be alert, especially in areas with limited visibility. Visually “busy” surroundings could hide you and your motorcycle from others.

Evaluate

Evaluate means to think about how hazards can interact to create risks for you. Anticipate potential problems and have a plan to reduce risks, particularly when faced with:

- **Road and surface characteristics** such as potholes, guardrails, bridges, telephone poles and trees that won’t move into your path, but may influence your riding strategy.
- **Traffic control devices** including traffic signals, warning signs, and pavement markings, which will require you to carefully evaluate circumstances ahead.
- **Vehicles and other traffic** that may move into your path and increase the likelihood of a crash. Think about your time and space requirements in order to maintain a margin of safety, and give yourself time to react if an emergency arises.

Execute

Finally, **Execute** your decision. To create more space and minimize harm from any hazard:

- **Communicate** your presence with lights and/or horn.
- **Adjust your speed** by accelerating, stopping or slowing.
- **Adjust your position** and/or direction by swerving, changing lanes, or moving to another position within your lane.

Apply the old adage “one step at a time” to handle two or more hazards. Adjust speed to permit two hazards to separate. Then deal with them one at a time as single hazards. Decision-making becomes more complex with three or more hazards. Evaluate the consequences of each and give equal distance to the hazards.

In potential high-risk areas, such as intersections, shopping areas and school and construction zones, cover the clutch and both brakes to reduce the time you need to react.

INTERSECTIONS

The greatest potential for conflict between you and other traffic is at intersections. An intersection can be in the middle of an urban area or at a driveway on a residential street — anywhere traffic may cross your path of travel. Over one-half of motorcycle/car crashes are caused by drivers entering a rider’s right-of-way. Cars that turn left in front of you, including cars turning left from the lane on your right, and cars on side streets that pull into your lane, are the biggest dangers. Your use of SEE at intersections is critical.

TEST YOURSELF

5

To reduce your reaction time, you should:

- Ride slower than the speed limit.
- Cover the clutch and the brakes.
- Shift into neutral when slowing.
- Pull in the clutch when turning.

Answer - page 48

LARGE INTERSECTIONS

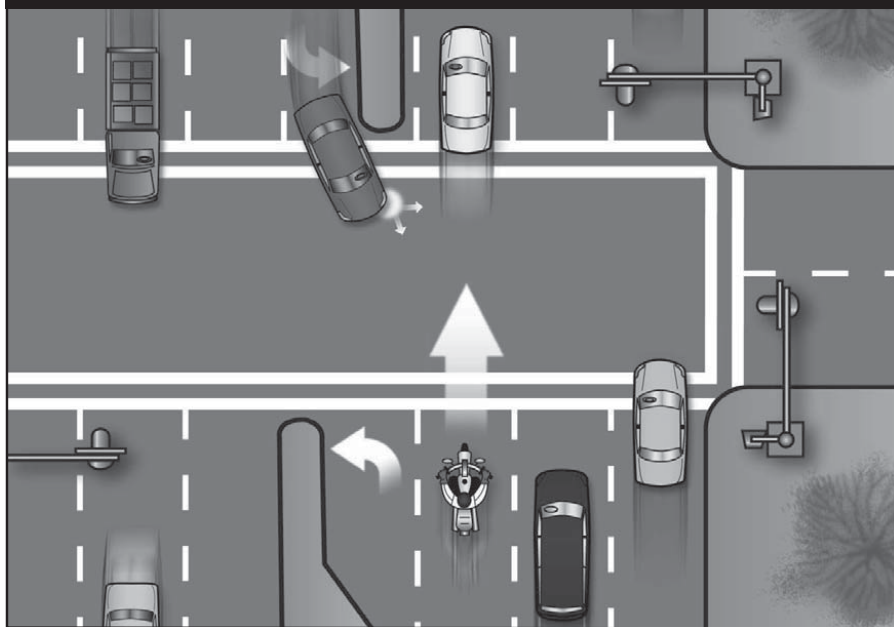

There are no guarantees that others see you. Never count on “eye contact” as a sign that a driver will yield. Too often, a driver looks right at a motorcyclist and still fails to “see” him or her. The only eyes that you can count on are your own. If a car can enter your path, assume that it will. Good riders are always “looking for trouble” — not to get into it, but to stay out of it.

Increase your chances of being seen at intersections. Ride with your headlight on and in a lane position that provides the best view of oncoming traffic. Provide a space cushion around the motorcycle that permits you to take evasive action. When approaching an intersection where a vehicle driver is preparing to cross your path, slow down and select a lane position to increase your visibility to that driver. Cover the clutch lever and both brakes to reduce reaction time. As you enter

SMALL INTERSECTION

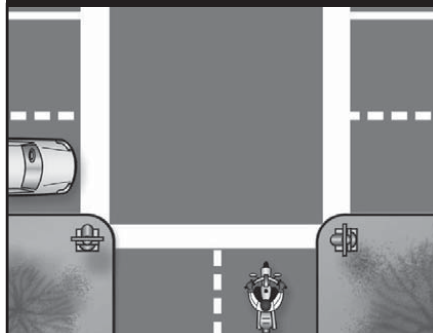

TEST YOURSELF

6

Making eye contact with other drivers:

- A. Is a good sign they see you.
- B. Is not worth the effort it takes.
- C. Doesn't mean that the driver will yield.
- D. Guarantees that the other driver will yield to you.

Answer - page 48

the intersection, move away from the vehicle. Do not change speed or position radically, as drivers might think you are preparing to turn. Be prepared to brake hard and hold your position if an oncoming vehicle turns in front of you, especially if there is other traffic around you. This strategy should also be used whenever a vehicle in the oncoming lane of traffic is signaling for a left turn, whether at an intersection or not.

Blind Intersections

If you approach a blind intersection, move to the portion of the lane that will bring you into another driver's field of vision at the earliest possible moment. In this picture, the rider has moved to the left portion of the lane — away from the parked car — so the driver on the cross street can see him as soon as possible.

Remember, the key is to see as much as possible and remain visible to others while protecting your space.

If you have a stop sign or stop line, stop there first. Then edge forward and stop again, just short of where the cross-traffic lane meets your lane. From that position, lean your body forward and look around buildings, parked cars or bushes to see if anything is coming. Just make sure your front wheel stays out of the cross lane of travel while you're looking.

Passing Parked Cars

When passing parked cars, stay toward the left of your lane. You can avoid problems caused by doors opening, drivers getting out of cars or people stepping from between cars. If oncoming traffic is present, it is usually best to remain in the center-lane position to maximize your space cushion.

BLIND INTERSECTIONS

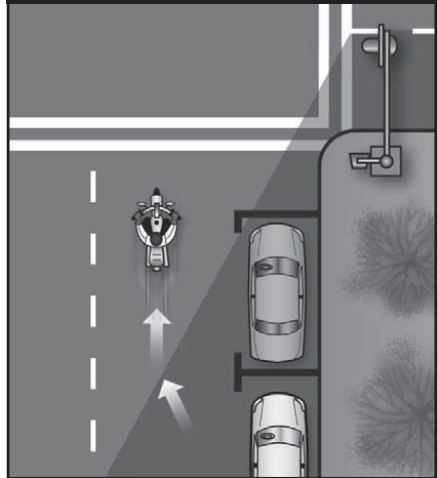

STOP SIGNS

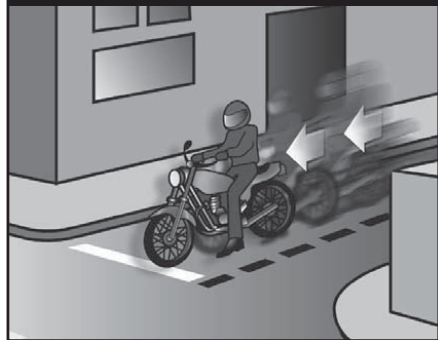

PARKED CARS



A bigger problem can occur if the driver pulls away from the curb without checking for traffic behind. Even if he does look, he may fail to see you.

In either event, the driver might cut into your path. Slow down or change lanes to make room for someone cutting in.

Cars making a sudden U-turn are the most dangerous. They may cut you off entirely, blocking the whole roadway and leaving you with no place to go. Since you can't tell what a driver will do, slow down and get the driver's attention. Sound your horn and continue with caution.

Parking at the Roadside

If parking in a parallel parking space next to a curb, position the motorcycle at an angle with the rear wheel to the curb. (Note: Some cities have ordinances that require motorcycles to park parallel to the curb.)

Increasing Conspicuity

In crashes with motorcyclists, drivers often say that they never saw the motorcycle. From ahead or behind, a motorcycle's outline is much smaller than a car's. Also, it's hard to see something you are not looking for, and most drivers are not looking for motorcycles. More likely, they are looking through the skinny, two-wheeled silhouette in search of cars that may pose a problem to them.

Even if a driver does see you coming, you aren't necessarily safe. Smaller vehicles appear farther away and seem to be traveling slower than they actually are. It is common for drivers to pull out in front of motorcyclists, thinking they have plenty of time. Too often, they are wrong.

PARKING AT CURBS

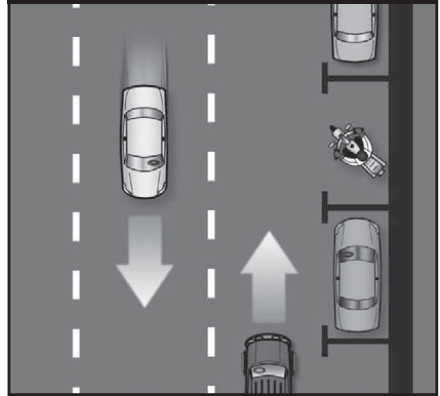

However, you can do many things to make it easier for others to recognize you and your motorcycle.

Clothing

Most crashes occur in broad daylight. Wear bright-colored clothing to increase your chances of being seen. Remember, your body is half of the visible surface area of the rider/motorcycle unit.

Bright orange, red, yellow or green jackets/vests are your best bets for being seen. Your helmet can do more than protect you in a crash. Brightly colored helmets can also help others see you.

Any bright color is better than drab or dark colors. Reflective, bright-colored clothing (helmet and jacket/vest) is best.

Reflective material on a vest and on the sides of the helmet will help drivers coming from the side to spot you. Reflective material can also be a big help for drivers coming toward you or from behind.

Headlight

The best way to help others see your motorcycle is to keep the headlight on — **at all times** (new motorcycles sold in the USA since 1978 automatically

SIGNALING

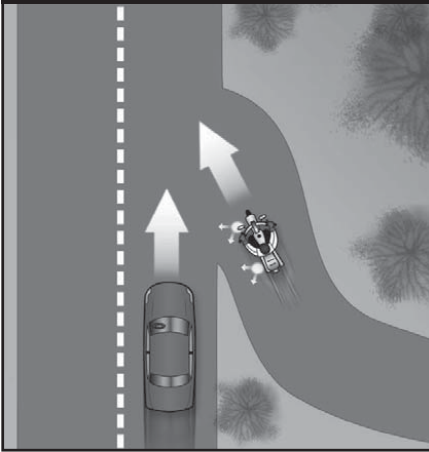

have the headlights on when running). Studies show that, during the day, a motorcycle with its light on is twice as likely to be noticed. Use low beam at night and in fog.

Signals

The signals on a motorcycle are similar to those on a car. They tell others what you plan to do.

However, due to a rider's added vulnerability, signals are even more important. Use them anytime you plan to change lanes or turn. Use them even when you think no one else is around. It's the car you don't see that's going to give you the most trouble. Your signal lights also make you easier to spot. That's why it's a good idea to use your turn signals even when what you plan to do is obvious.

When you enter a freeway, drivers approaching from behind are more likely to see your signal blinking and make room for you.

Turning your signal light on before each turn reduces confusion and frustration for the traffic around you.

Once you turn, make sure your signal is off or a driver may pull directly into your path, thinking you plan to turn again. Use your signals at every turn so drivers can react accordingly. Don't make them guess what you intend to do.

Brake Light

Your motorcycle's brake light is usually not as noticeable as the brake lights on a car — particularly when your taillight is on. (It goes on with the headlight.) If the situation will permit, help others notice you by flashing your brake light before you slow down. It is especially important to flash your brake light before:

- **You slow more quickly** than others might expect (turning off a high-speed highway).
- **You slow where** others may not expect it (in the middle of a block or at an alley).

If you are being followed closely, it's a good idea to flash your brake light before you slow. The tailgater may be watching you and not see something ahead that will make you slow down. This will hopefully discourage them from tailgating and warn them of hazards ahead they may not see.

Using Your Mirrors

While it's most important to keep track of what's happening ahead, you can't afford to ignore situations behind. Traffic conditions change quickly. Knowing what's going on behind is essential for you to make a safe decision about how to handle trouble ahead.

Frequent mirror checks should be part of your normal searching routine. Make a special point of using your mirrors:

- **When you are stopped** at an intersection. Watch cars coming up

from behind. If the drivers aren't paying attention, they could be on top of you before they see you.

- **Before you change lanes.** Make sure no one is about to pass you.
- **Before you slow down.** The driver behind may not expect you to slow, or may be unsure about where you will slow. For example, you signal a turn and the driver thinks you plan to turn at a distant intersection, rather than at a nearer driveway.

Most motorcycles have rounded (convex) mirrors. These provide a wider view of the road behind than do flat mirrors. They also make cars seem farther away than they really are. If you are not used to convex mirrors, get familiar with them. (*While you are stopped, pick out a parked car in your mirror. Form a mental image of how far away it is. Then, turn around and look at it to see how close you came.*) Practice with your mirrors until you become a good judge of distance. Even then, allow extra distance before you change lanes.

Head Checks

Checking your mirrors is not enough. Motorcycles have "blind spots" like cars. Before you change lanes, turn your head, and look to the side for other vehicles.

On a road with several lanes, check the far lane and the one next to you. A driver in the distant lane may head for the same space you plan to take.

TEST YOURSELF

7

Reflective clothing should:

- Be worn at night.
- Be worn during the day.
- Not be worn.
- Be worn day and night

Answer - page 48

USING MIRRORS

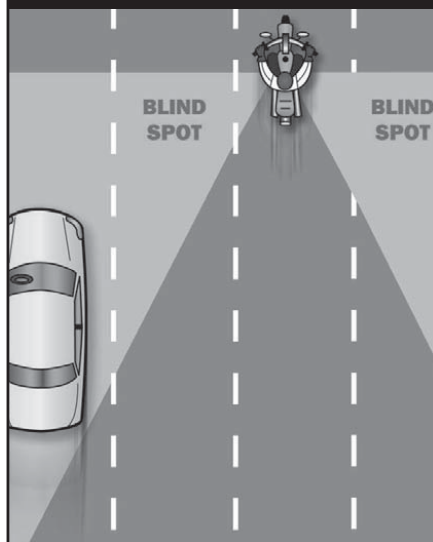

Frequent head checks should be your normal scanning routine, also. Only by knowing what is happening **all around** you are you fully prepared to deal with it.

Horn

Be ready to use your horn to get someone's attention quickly.

It is a good idea to give a quick beep before passing anyone that may move into your lane.

Here are some situations:

- **A driver** in the lane next to you is driving too closely to the vehicle ahead and may want to pass.
- **A parked car** has someone in the driver's seat.
- **Someone is in the street**, riding a bicycle or walking.

In an emergency, sound your horn loud and long. Be ready to stop or swerve away from the danger.

Keep in mind that a motorcycle's horn isn't as loud as a car's — therefore, use it, but don't rely on it. Other strategies, like having time and space to maneuver, may be appropriate along with the horn.

Riding at Night

At night it is harder for you to see and be seen. Picking your headlight or taillight out of the car lights around you is not easy for other drivers. To compensate, you should:

- **Reduce Your Speed** — Ride even slower than you would during the day — particularly on roads you don't know well. This will increase your chances of avoiding a hazard.
- **Increase Distance** — Distances are harder to judge at night than during the day. Your eyes rely upon shadows and light contrasts to determine how far away an object is and how fast it is coming. These contrasts are missing or distorted under artificial lights at night. Open up a three-second following distance or more. And allow more distance to pass and be passed.
- **Use the Car Ahead** — The headlights of the car ahead can give you a better view of the road than even your high beam can. Taillights bouncing up and down can alert you to bumps or rough pavement.
- **Use Your High Beam** — Get all the light you can. Use your high beam whenever you are not following or meeting a car. Be visible: Wear reflective materials when riding at night.
- **Be Flexible About Lane Position.** Change to whatever portion of the lane is best able to help you see, be seen and keep an adequate space cushion.

CRASH AVOIDANCE

No matter how careful you are, there will be times when you find yourself in a tight spot. Your chances of getting out safely depend on your ability to react quickly and properly. Often, a crash occurs because a rider is not prepared or skilled in crash-avoidance maneuvers.

Know when and how to stop or swerve, two skills critical in avoiding a crash. It is not always desirable or possible to stop quickly to avoid an obstacle. Riders must also be able to swerve around an obstacle. Determining which skill is necessary for the situation is important as well.

Studies show that most crash-involved riders:

- **Underbrake** the front tire and overbrake the rear.
- **Did not** separate braking from swerving or did not choose swerving when it was appropriate.

The following information offers some good advice.

Quick Stops

To stop quickly, apply both brakes at the same time. Don't be shy about using the front brake, but don't "grab" it, either. Squeeze the brake lever firmly and progressively. If the front wheel locks, release the front brake immediately then reapply it firmly. At the same time, press down on the rear brake. If you accidentally lock the rear brake on a good traction surface, you can keep it locked until you have completely stopped; but, even with a locked rear wheel, you can control the motorcycle on a straightaway if it is upright and going in a straight line.

Stopping Quickly in a Curve

If you know the technique, using both brakes in a turn is possible, although it should be done very carefully. When leaning the motorcycle some of the traction is used for cornering. Less traction is available for stopping. A skid can occur if you apply too much brake. Also, using the front brake incorrectly on a slippery surface may be hazardous. Use caution and squeeze the brake lever, never grab.

If you must stop quickly while turning in a curve, first straighten and square the handlebars, then stop. If you find yourself in a situation that does not allow straightening first, such as when there is a danger of running off the road in a left-hand curve, or when facing oncoming traffic in a right-hand curve, apply the brakes smoothly and gradually. As you slow, you can reduce your lean angle and apply more brake pressure until the motorcycle is straight and maximum brake pressure can be applied. Always straighten the handlebars in the last few

feet of stopping to maintain your balance and remain upright.

STOPPING DISTANCE

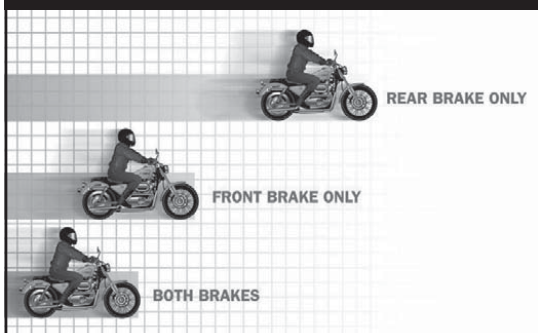

Swerving or Turning Quickly

Sometimes you may not have enough room to stop, even if you use both brakes properly. You may encounter an unexpected object in your path. Or the car ahead might squeal to a stop. The only way to avoid a crash may be to turn quickly or swerve around it.

A swerve is a sudden change in direction. It can be two quick turns, or a rapid shift to the side. Apply a small amount of hand pressure to the handgrip located on the side of your intended direction of escape. This will

SWERVE, THEN BRAKE

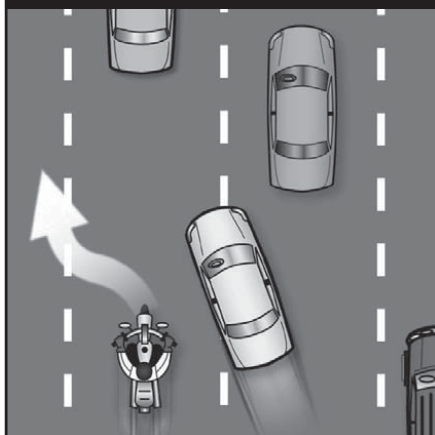

BRAKE, THEN SWERVE



cause the motorcycle to lean quickly. The sharper the turn(s), the more the motorcycle must lean.

Keep your body upright and allow the motorcycle to lean in the direction of the turn while keeping your knees against the tank and your feet solidly on the foot rests. Let the motorcycle move underneath you. Make your escape route the target of your vision. Press on the opposite handlegrip once you clear the obstacle to return you to your original direction of travel. To swerve to the left, press the left handlegrip, then press the right to recover. To swerve to the right, press right, then left.

If braking is required, separate it from swerving. Brake before or after – never while swerving.

Maximum Straight-Line Braking

Maximum straight-line braking is accomplished by fully applying front and rear brakes without locking either wheel. Keep your body centered over the motorcycle and look well ahead, not down. This will help you keep the motorcycle in as straight a line as possible, minimizing lean angle and the likelihood of the wheels losing traction.

Front-Wheel Skids

If the front wheel locks, release the front brake immediately and completely.

Reapply the brake smoothly. Front-wheel skids result in immediate loss of steering control and balance. Failure to fully release the brake lever immediately will result in a crash.

Rear-Wheel Skids

A skidding rear tire is a dangerous condition that can result in a violent

crash and serious injury or death. Too much rear brake pressure causes rear-wheel lockup. As soon as the rear wheel locks, your ability to change direction is lost. To regain control the brake must be released. However, if the rear wheel is out of alignment with the front, there is a risk of a high-side crash. This occurs when the wheels are out of alignment and a locked rear wheel is released. The motorcycle can abruptly snap upright and tumble, throwing the rider into the air ahead of the motorcycle's path. Even slight misalignment can result in a high-side crash.

Curves

A primary cause of single-vehicle crashes is motorcyclists running wide in a curve or turn and colliding with the roadway or a fixed object.

Every curve is different. Be alert to whether a curve remains constant, gradually widens, gets tighter or involves multiple turns. Ride within your skill level and posted speed limits.

Your best path may not always follow the curve of the road. Change lane position depending on traffic, road conditions and curve of the road. If no traffic is present, start at the outside of a curve to increase your line of sight and the effective radius of the turn. As you turn, move toward the inside of the curve, and as you pass the center, move to the outside to exit.

Another alternative is to move to the center of your lane before entering a curve — and stay there until you exit. This permits you to spot approaching traffic as soon as possible. You can also adjust for traffic "crowding" the center line, or debris blocking part of your lane.

CONSTANT CURVES

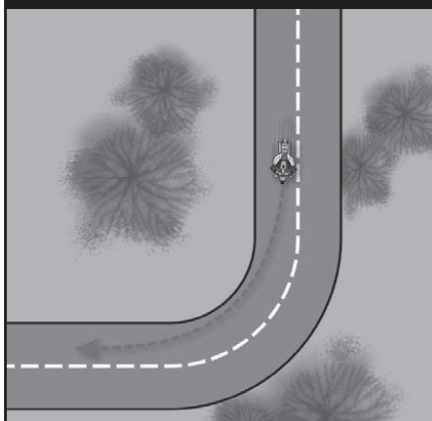

MULTIPLE CURVES

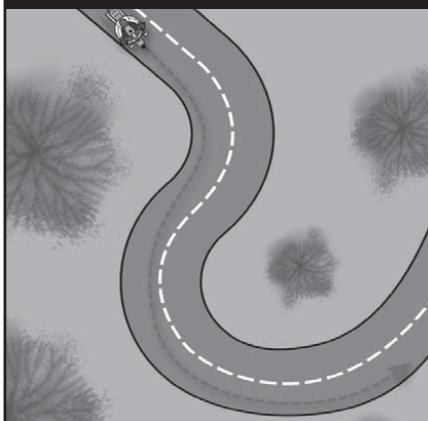
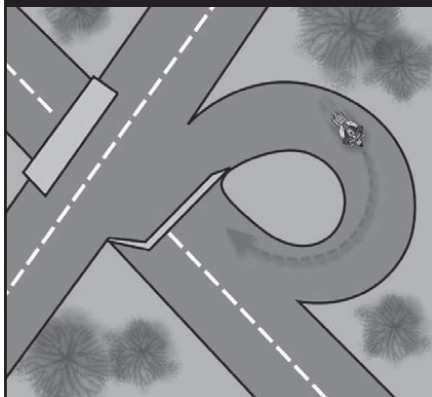
DECREASING CURVES
(TIGHTER TURNS)

WIDENING CURVES

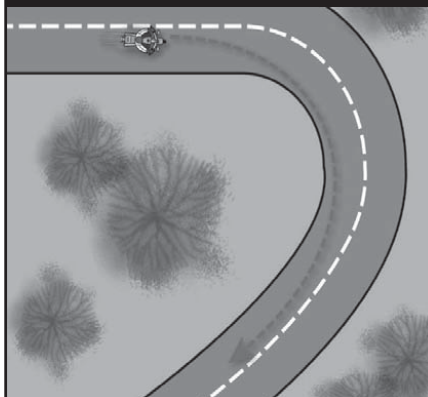

HANDLING DANGEROUS SURFACES

Your chance of falling or being involved in a crash increases whenever you ride across:

- Uneven surfaces or obstacles.
- Slippery surfaces.
- Railroad tracks.
- Grooves and gratings.

Uneven Surfaces
and Obstacles

Watch for uneven surfaces such as

bumps, broken pavement, potholes or small pieces of highway trash.

Try to avoid obstacles by slowing or going around them. If you must go over the obstacle, first determine if it is possible. Approach it at as close to a 90° angle as possible. Look where you want to go to control your path of travel. If you have to ride over the obstacle, you should:

- **Slow down** as much as possible before contact.
- **Make sure** the motorcycle is straight.
- **Rise slightly** off the seat with your

OBSTACLES

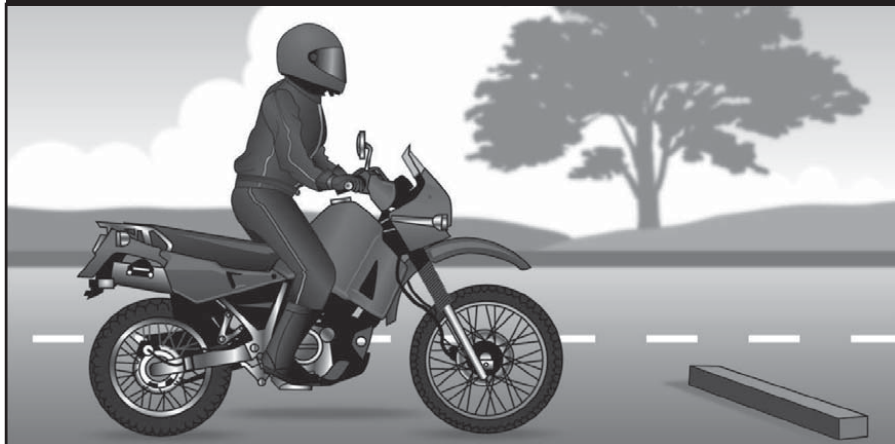

weight on the footrests to absorb the shock with your knees and elbows, and avoid being thrown off the motorcycle.

- **Just before contact**, roll on the throttle slightly to lighten the front end.

If you ride over an object on the street, pull off the road and check your tires and rims for damage before riding any farther.

Slippery Surfaces

Motorcycles handle better when ridden on surfaces that permit good traction. Surfaces that provide poor traction include:

- **Wet pavement**, particularly just after it starts to rain and before surface oil washes to the side of the road.
- **Gravel roads**, or where sand and gravel collect.
- **Mud, leaves, snow, and ice.**
- **Lane markings (painted lines)**, steel plates and manhole covers, especially when wet.

To ride safely on slippery surfaces:

- **Reduce Speed** — Slow down

before you get to a slippery surface to lessen your chances of skidding. Your motorcycle needs more distance to stop. And it is particularly important to reduce speed before entering wet curves.

- **Avoid Sudden Moves** — Any sudden change in speed or direction can cause a skid. Be as smooth as possible when you speed up, shift gears, turn or brake.
- **Use Both Brakes** — The front brake is still effective, even on a slippery surface. Squeeze the brake lever gradually to avoid locking the front wheel. Remember, gentle pressure on the rear brake.
- **The center of a lane** can be hazardous when wet. When it starts to rain, ride in the tire tracks left by

TEST YOURSELF

8

The best way to stop quickly is to:

- Use the front brake only.
- Use the rear brake first.
- Throttle down and use the front brake.
- Use both brakes at the same time.

Answer - page 48

cars. Often, the left tire track will be the best position, depending on traffic and other road conditions.

- **Watch for oil spots** when you put your foot down to stop or park. You may slip and fall.
- **Dirt and gravel** collect along the sides of the road — especially on curves and ramps leading to and from highways. Be aware of what's on the

edge of the road, particularly when making sharp turns and getting on or off freeways at high speeds.

- **Rain dries and snow melts faster** on some sections of a road than on others. Patches of ice tend to develop in low or shaded areas and on bridges and overpasses. Wet surfaces or wet leaves are just as slippery. Ride on the least slippery portion of the lane and reduce speed.

Cautious riders steer clear of roads covered with ice or snow. If you can't avoid a slippery surface, keep your motorcycle straight up and proceed as *slowly* as possible. If you encounter a large surface so slippery that you must coast, or travel at a walking pace,

CROSSTRACKS—CORRECT

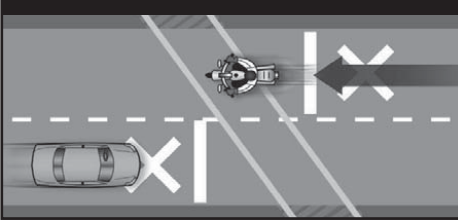

CROSSTRACKS—INCORRECT



PARALLEL TRACKS—CORRECT

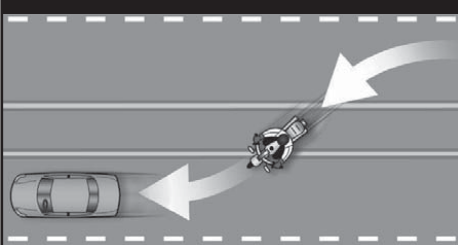

PARALLEL TRACKS—INCORRECT

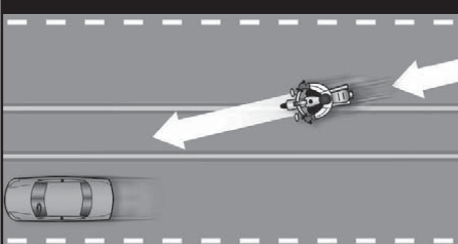

GRATE CROSSINGS—CORRECT

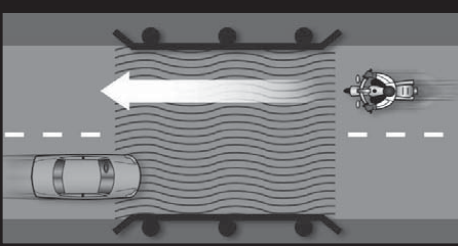

GRATE CROSSINGS—INCORRECT

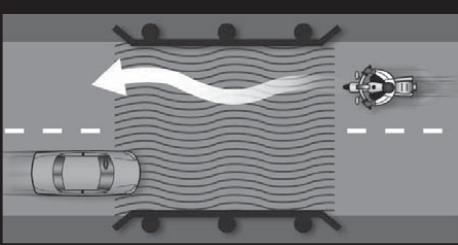

TEST YOURSELF

9

When it starts to rain it is usually best to:

- Ride in the center of the lane.
- Pull off to the side until the rain stops.
- Ride in the tire tracks left by cars.
- Increase your speed.

Answer - page 48

consider letting your feet skim along the surface. If the motorcycle starts to fall, you can catch yourself. Be sure to keep off the brakes. If possible, squeeze the clutch and coast. Attempting this maneuver at anything other than the slowest of speeds could prove hazardous.

Railroad Tracks, Trolley Tracks and Pavement Seams.

Usually it is safer to ride straight within your lane to cross tracks. Turning to take tracks head-on (at a 90° angle) can be more dangerous — your path may carry you into another lane of traffic.

For track and road seams that run parallel to your course, move far enough away from tracks, ruts, or pavement seams to cross at an angle of at least 45°. Then, make a deliberate turn. Edging across could catch your tires and throw you off balance.

Grooves and Gratings

Riding over rain grooves or bridge gratings may cause a motorcycle to weave. The uneasy, wandering feeling is generally not hazardous. Relax, maintain a steady speed and ride straight across. Crossing at an angle forces riders to zigzag to stay in the lane. The zigzag is far more hazardous than the wandering feeling.

MECHANICAL PROBLEMS

You can find yourself in an emergency the moment something goes wrong with your motorcycle. In dealing with any mechanical problem, take into account the road and traffic conditions you face. Here are some guidelines that can help you handle mechanical problems safely.

Tire Failure

You will seldom hear a tire go flat. If the motorcycle starts handling differently, it may be a tire failure. This

can be dangerous. You must be able to tell from the way the motorcycle reacts. If one of your tires suddenly loses air, react quickly to keep your balance. Pull off and check the tires.

If the front tire goes flat, the steering will feel “heavy.” A front-wheel flat is particularly hazardous because it affects your steering. You have to steer well to keep your balance.

If the rear tire goes flat, the back of the motorcycle may jerk or sway from side to side.

If either tire goes flat while riding:

- **Hold handgrips** firmly, ease off the throttle, and keep a straight course.
- **If braking is required**, gradually apply the brake of the tire that isn't flat, if you are sure which one it is.
- **When the motorcycle slows**, edge to the side of the road, squeeze the clutch and stop.

Stuck Throttle

Twist the throttle back and forth several times. If the throttle cable is stuck, this may free it. If the throttle stays stuck, immediately operate the engine cut-off switch and pull in the clutch at the same time. This will remove power from the rear wheel, though engine sound may not immediately decline. Once the motorcycle is “under control,” pull off and stop.

After you have stopped, check the throttle cable carefully to find the source of the trouble. Make certain the throttle works freely before you start to ride again.

Wobble

A “wobble” occurs when the front wheel and handlebars suddenly start to shake from side to side at any speed. Most wobbles can be traced to improper

loading, unsuitable accessories or incorrect tire pressure. If you are carrying a heavy load, lighten it. If you can't, reposition it. Center the weight lower and farther forward on the motorcycle. Make sure tire pressure, spring pre-load, air shocks and dampers are at the settings recommended for the weight you are carrying. Make sure windshields and fairings are mounted properly.

Check for poorly adjusted steering; worn steering parts; a front wheel that is bent, misaligned, or out of balance; loose wheel bearings or spokes; and worn swingarm bearings. If none of these is determined to be the cause, have the motorcycle checked out thoroughly by a qualified professional.

Trying to "accelerate out of a wobble" will only make the motorcycle more unstable. Instead:

- **Grip the handlebars firmly**, but don't fight the wobble.
- **Close the throttle gradually** to slow down. Do not apply the brakes; braking could make the wobble worse.
- **Move your weight** as far forward and down as possible.
- **Pull off the road** as soon as you can to fix the problem.

Drive Train Problems

The drive train for a motorcycle uses either a chain, belt, or drive shaft to transfer power from the engine to the rear wheel. Routine inspection, adjustment, and maintenance makes failure a rare occurrence. A chain or belt that slips or breaks while you're riding could lock the rear wheel and cause your motorcycle to skid.

If the chain or belt breaks, you'll notice an instant loss of power to the rear wheel. Close the throttle and brake

to a stop in a safe area.

On a motorcycle with a drive shaft, loss of oil in the rear differential can cause the rear wheel to lock, and you may not be able to prevent a skid.

Engine Seizure

When the engine "locks" or "freezes" it is usually low on oil. The engine's moving parts can't move smoothly against each other, and the engine overheats. The first sign may be a loss of engine power or a change in the engine's sound. Squeeze the clutch lever to disengage the engine from the rear wheel. Pull off the road and stop. Check the oil. If needed, oil should be added as soon as possible or the engine will seize. When this happens, the effect is the same as a locked rear wheel. Let the engine cool before restarting.

ANIMALS

Naturally, you should do everything you safely can to avoid hitting an animal. If you are in traffic, however, remain in your lane. Hitting something small is less dangerous to you than hitting something big — like a car.

Motorcycles seem to attract dogs. If you are being chased, downshift and approach the animal slowly. As you approach it, accelerate and leave the animal behind. Don't kick at the animal. Keep control of your motorcycle and look to where you want to go.

TEST YOURSELF

10

If your motorcycle starts to wobble:

- A. Accelerate out of the wobble.
- B. Use the brakes gradually.
- C. Grip the handlebars firmly and close the throttle gradually.
- D. Downshift.

Answer - page 48

For larger animals (deer, elk, cattle) brake and prepare to stop — they are unpredictable.

FLYING OBJECTS

From time to time riders are struck by insects, cigarettes thrown from cars or pebbles kicked up by the tires of the vehicle ahead. If you are wearing face protection, it might get smeared or cracked, making it difficult to see. Without face protection, an object could hit you in the eye, face or mouth. Whatever happens, keep your eyes on the road and your hands on the handlebars. When safe, pull off the road and repair the damage.

GETTING OFF THE ROAD

If you need to leave the road to check the motorcycle (or just to rest), be sure to:

- **Check the roadside** — Make sure the surface of the roadside is firm enough to ride on. If it is soft grass, loose sand or if you're just not sure about it, slow way down before you turn onto it.
- **Signal** — Drivers behind might not expect you to slow down. Give a clear signal that you will be slowing down and changing direction. Check your mirror and make a head check before you take any action.
- **Pull off the road** — Get as far off the road as you can. It can be very hard to spot a motorcycle by the side of the road. You don't want someone else pulling off at the same place you are.
- **Park carefully** — Loose and sloped shoulders can make setting the side or center stand difficult.

CARRYING PASSENGERS AND CARGO

The extra weight of a passenger

or cargo will affect the way your motorcycle behaves, requiring extra practice, preparation and caution. For this reason, only experienced riders should attempt to carry passengers or large loads. Before taking a passenger or a heavy load on the street, prepare yourself and your motorcycle for safe operation in traffic.

Preparing Your Motorcycle

Tire Pressure — Check the air pressure of both tires. Refer to the owner's manual or the label affixed to the motorcycle for the correct inflation specifications. Though most of the added weight will typically be on the rear wheel, don't forget to also check the pressure on the front tire. Correct inflation pressures will maintain maximum stability, steering precision and braking capability.

Suspension — With a heavy load, the riding characteristics and balance of the motorcycle will change. On some motorcycles, it will be necessary to adjust the suspension settings (spring preload, compression/damping settings, etc.) to compensate for the lowered rear of the motorcycle. Refer to the owner's manual for adjustment procedures and specifications.

Headlight — Prior to loading, position the motorcycle about 10 feet from a wall in an unlighted garage and mark the headlight beam location on the wall with chalk. With a full load and passenger, recheck the headlight beam location. Use the adjusting screws on the headlight to lower the beam to the same height. Check your owner's manual for adjustment procedure.

Equipment for Carrying a Passenger

- Be sure your passenger is properly

attired, wearing the same level of personal protective gear as you.

- Be sure your motorcycle is equipped with passenger footrests.
- Your motorcycle should have a proper seat, one large enough to hold both you and your passenger without crowding. You should not sit more forward than you usually do.
- Check that there is a strap or solid handholds for your passenger to hold onto.

Preparing Your Passenger to Ride

Ensure your passenger is able to reach the passenger footrests, and is able to hold on to your waist, hips, belt, or the bike's passenger handholds. Children should be placed immediately behind the rider. A child sitting in front of the rider will not be able to properly balance him/herself and may interfere with the rider's control of the motorcycle.

Passenger safety begins with proper instruction. Riders should not assume that passengers are familiar with motorcycle handling, control, or balance. As a routine practice, always instruct your passenger on cycling basics prior to starting the trip, even if your passenger is a motorcycle rider.

As you prepare for your ride, tell your passenger to:

- Get on the motorcycle only after

you have started the engine and have the transmission in neutral. As the passenger mounts, keep both your feet on the ground and the brakes applied.

- Sit as far forward as possible without hindering your control of the motorcycle.
- Hold firmly onto your waist, hips, belt or passenger handholds for balance and security.
- Keep both feet firmly on the cycle's footrests, even when stopped. Firm footing will prevent your passenger from falling off and pulling you off.
- Keep legs away from the muffler(s), chains or moving parts.
- Stay directly behind you and lean with you through turns and curves. It is helpful for the passenger to look over the rider's shoulder in the direction of turns and curves.
- Avoid unnecessary conversation and avoid leaning or turning around. Make no sudden moves that might affect the stability of the motorcycle when it is in operation.
- Rise slightly off the seat when crossing an obstacle.

Also, remind your passenger to tighten his or her hold when you:

- Approach surface hazards such as bumps or uneven road surfaces.
- Are about to start from a stop or begin moving into traffic.
- Are about to turn sharply or make a sudden move.

TEST YOURSELF

11

If you are chased by a dog:

- Kick it away.
- Stop until the animal loses interest.
- Swerve around the animal.
- Approach the animal slowly, then speed up.

Answer - page 48

Riding With Passengers

Your motorcycle will respond differently when you ride with a passenger. The heavier your passenger, the longer it will take to speed up, slow

down, or turn.

When riding with passengers:

- Ride a little slower, especially when taking curves, corners, or bumps. If any part of the motorcycle scrapes the ground at lean angle, steering control can be lost.
- Start slowing earlier as you approach a stop, and maintain a larger space cushion whenever slowing or stopping.
- Wait for larger gaps to cross, enter, or merge in traffic.

Carrying Loads

Everything you are likely to need for a riding holiday or weekend trip can be packed on your motorcycle in many different ways. There are complete luggage systems, saddlebags that are permanently attached to the motorcycle, soft bags that do not require a carrier system and can be tied to the seat, and a tank bag for other small items. You can also travel simply with only a backpack. Whatever you decide, do not exceed gross vehicle weight rating when traveling with cargo and a passenger, and always make adjustments to the motorcycle to compensate for the added weight.

Tips for Traveling with Passengers and Cargo

- Keep the load forward. Pack heavier items in the front of the tank bag. Lighter items such as your sleeping bag, ground pad or tent, should be packed on a luggage rack behind you. Try to place the load over, or in front of, the rear axle. Mounting loads behind the rear axle can affect how the motorcycle turns and brakes. It can also cause a wobble.
- Plan your route and length of each

day's riding segment and allow plenty of time for breaks. Poor weather, breakdowns, and fatigue are always possible.

- Consider selecting some interesting secondary roads to occasionally reduce the monotony of the highway.
- Start as early in the morning as possible. When you are fresh, you ride at peak performance. For most riders, this is usually between 6 a.m. and 11 a.m. – then, take a good hour's break for lunch. Your energy will pick up again in the afternoon.
- Don't forget sun protection in the summer. Some combinations of riding gear can leave your neck exposed, risking sunburn.
- If you wear a backpack, be sure it is securely attached to you. Try to adjust the shoulder straps so that the backpack rests lightly on the seat. This will reduce the tension in your neck and shoulders.
- If you have a tank bag, be sure it is securely mounted and does not obstruct your view of the controls or instruments. If necessary, pack it only partially full. When strapping the tank bag in place, make sure it does not catch any of the brake lines or cables in the area of the steering head.
- Secure loads low, or put them in saddlebags. Attaching a load to a sissy bar raises the motorcycle's center

TEST YOURSELF

12

Passengers should:

- Lean as you lean.
- Hold on to the motorcycle seat.
- Sit as far back as possible.
- Never hold onto you.

Answer - page 48

of gravity and can upset its balance.

- If you use saddlebags, load each with about the same weight. An uneven load can cause the motorcycle to pull to one side. Overloading may also cause the bags to catch in the wheel or chain, locking the rear wheel and causing the motorcycle to skid.
- Fasten the load securely with elastic cords (bungee cords or nets). Elastic cords with more than one attachment point per side are recommended. A loose load could catch in the wheel or chain, causing it to lock up, resulting in a skid. Rope can stretch and knots can come loose, permitting the load to shift or fall. You should stop and check the load often to make sure it has not shifted or loosened.
- Include a small tool kit and some common spare parts that you might need. Water and some energy bars or other food should also be part of your preparation, and don't forget a first aid kit, especially if you are riding in a group.

Pre-Ride Test

Prior to starting out, take a test ride with your fully loaded motorcycle through some familiar neighborhood roads to get a feel for the operation of your motorcycle. Be sure the suspension settings are correct, and that the side stand, footrests, and exhaust pipes don't scrape over bumps and in turns. Ensure the tank bag does not get in the way of the handlebars or restrict the steering. Also check the security of the load, so that your luggage does not hit you in the back under maximum braking.

You will also find that the performance of a fully loaded motorcycle will

be different than what you are used to. Test the power when accelerating and be aware that it will be lower, increasing passing times and distances. Braking will also feel different, and stopping distances may increase.

GROUP RIDING

Preparation

Preparing yourself for a group ride is as important as making sure your motorcycle is ready. Riding with a group requires an alert mind that is free from worries, distractions and stress. It also means riding free from the influence of alcohol or drugs. For some, even too much caffeine or prescription drugs can adversely affect concentration.

Prior to a long trip, it's a good idea to have your motorcycle serviced at your local dealership if you aren't able to do the work yourself. A thorough pre-ride check is a must. Use the T-CLOCS checklist as a reminder of the important components to check before you leave. Remember to consider such variables as passengers and extra weight from cargo that might require a change in tire pressure or suspension adjustment.

Plan

Before starting out, hold a rider's meeting to discuss the route, length of riding segments, rest stops and locations for fuel, meals and lodging. Make sure everyone knows the route. That way, if someone becomes separated, he or she won't have to hurry to keep from getting lost or making the wrong turn. Choose a lead rider and a sweep rider. These should be the most experienced riders of the group. The lead rider should look ahead for changes in road, traffic or weather conditions, and signal early so the word gets back in plenty of time to the other riders. The sweep rider is the last rider in the group, and sets the pace for the group. Place inexperienced riders just behind the

leader. That ensures that they won't have to chase after the group, and the more experienced riders can watch them from the back.

The most important rules for group riding are: no competition, no passing of other riders and no tailgating. If a rider insists on riding faster than the group, allow him or her to go ahead to an agreed meeting point.

Hand signals

During the rider's meeting, review the hand signals so all riders can communicate during the ride. A diagram of the most common hand signals is at the end of this manual.

Follow those behind

During the ride, use your mirrors to keep an eye on the person behind and confirm that the group is staying together. If a rider falls behind, everyone should slow down to keep the group together.

Keep Your Distance

Maintain close ranks, but at the same time, maintain an adequate space cushion to allow each rider in the group time and distance to react to hazards. A close group takes up less space on the highway, is easier to see, and is less likely to become separated. This must, however, be done properly.

Don't Pair Up

Never ride directly alongside another rider in the same lane. There is no place to go if you have to maneuver to avoid a car or hazard in the roadway. Wait until you are both stopped to talk.

Staggered Formation

This is the best way to keep the ranks close yet maintain an adequate space cushion. The group leader rides in the left side of the lane, and the second rider stays at least one second back and rides in the right side of the lane. The

third maintains the left position of the lane, at least two seconds behind the first rider. The fourth rider should keep at least a two second distance from the second rider in the right side of the lane, and so on. This formation keeps the group close and permits each rider to maintain a safe distance from others ahead, behind and to the sides.

It is best to move to single file formation when riding in curves, turning, and entering or leaving freeways or highways.

Intersections

Intersections present the highest risk for motorcyclists in a group. When making a left turn at an intersection with a left turn signal arrow, tighten the formation to allow as many riders through the intersection as possible. Make the turn single file – do not ride side-by-side. If not all riders get through the light, stop at a safe point ahead and wait. This will prevent riders from feeling pressured to speed up or run a red light.

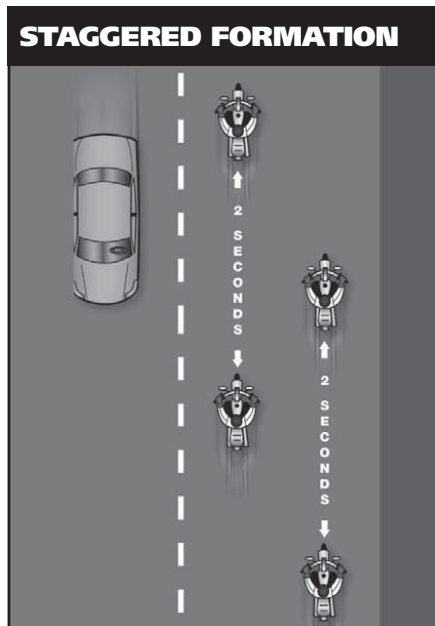

Interstate Highways and Freeways

A staggered formation is essential when riding on freeways and interstates. However, enter in single file and form up only after all riders have safely merged in traffic. The lead rider should move the group over at least one lane to prevent vehicles that are entering and exiting traffic from disrupting your formation. In heavy traffic, resist the temptation to ride too close together. Maintain your minimum one-second, two-second staggered formation space cushion. When exiting, use a single file formation for better space cushion and time to react to conditions at the end of the off-ramp.

Parking

When possible, park as a group, so everyone can get off their motorcycles more quickly. Avoid parking downhill or head-in, and if possible, park where you can pull through, making the arrival and departure smoother. Whenever possible, park so that the group can depart as a unit in single file.

Passing in Formation

When the group wants to pass slow traffic on a freeway or interstate, the group may pass as a unit. On a two-lane highway, riders in a staggered formation should pass one at a time.

- First, the lead rider should pull out and pass when it is safe. After passing the leader should return to the left position and continue riding

GROUP PASSING (STAGE 1)

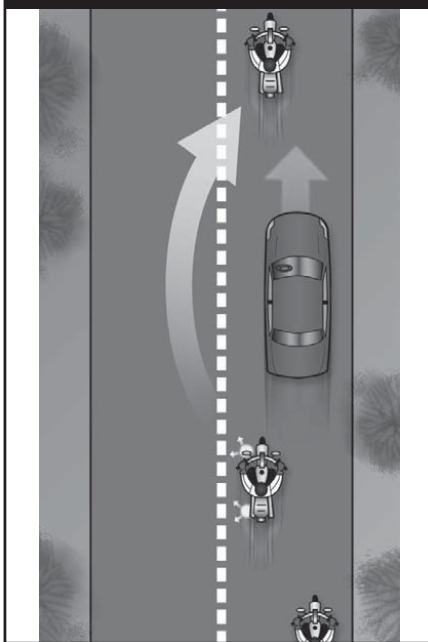

GROUP PASSING (STAGE 2)

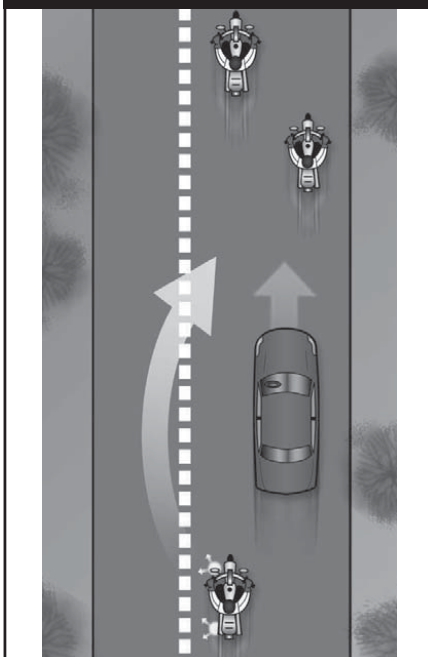

TEST YOURSELF

13

When riding in a group, inexperienced riders should position themselves:

- Just behind the leader.
- In front of the group.
- At the tail end of the group.
- Beside the leader.

Answer - page 48

at passing speed to open room for the next rider.

- Next, the second rider should move up to the left position in the lane and wait for a chance to safely pass. When passing be sure you have a clear view of oncoming traffic. Just because the lead rider passed, that does not mean that conditions haven't changed and that it is still safe for other riders to pass. After passing the rider should return to the right position and open up room for the next rider.

Some people suggest that the lead rider should move to the right side of the lane after passing the vehicle. This is not a good idea, since it might encourage the second rider to pass and cut back in before there is enough space cushion in front of the passed vehicle. It's simpler and safer to wait until there is enough room ahead of the passed vehicle to allow each rider to move into the same position held before the pass.

Ten Rules of Group Riding

- Base the length of the route and segments on ability of the least experienced rider.
- Take timely breaks to prevent loss of concentration and reduce fatigue.
- Adjust the pace through curves to the ability of the least experienced rider. If necessary, form two groups with different speeds.
- Don't tailgate or encourage the rider in front to speed. If you want to ride faster, ride ahead of the group.
- Keep adequate following distance and maintain a staggered formation.
- Do not pass in the group, except in the case of emergency.
- Place inexperienced riders just behind the leader so they can keep pace without riding faster than it is safe.
- When passing, be conscious of the traffic conditions and oncoming traffic. Even though the previous riders passed safely, it may not be safe for you.
- Maintain adequate time distance between riders, especially at intersections. This allows you to avoid hard braking.
- Check your mirrors frequently to ensure the group stays together.

Riding a motorcycle is a demanding and complex task. Skilled riders pay attention to the riding environment and to operating the motorcycle, identifying potential hazards, making good judgments and executing decisions quickly and skillfully. Your ability to perform and respond to changing road and traffic conditions is influenced by how fit and alert you are. Alcohol and drugs, more than any other factor, degrade your ability to think clearly and to ride skillfully. As little as one drink can have a significant effect on your performance.

Let's look at the risks involved in riding after drinking or using drugs. What to do to protect yourself and your fellow riders is also examined.

WHY THIS INFORMATION IS IMPORTANT

Alcohol is a major contributor to motorcycle crashes, particularly fatal crashes. Studies show that 29% of all fatally injured motorcycle riders had BAC levels above the legal limit of 0.08%. An additional 8% had lower alcohol levels (BAC 0.01 to 0.07%), demonstrating that having only a drink or two in one's system is enough to impair riding skills. Drug levels are harder to distinguish or have not been separated from drinking violations for the traffic records. But riding "under the influence" of either alcohol or drugs poses physical hazards and legal consequences for every rider.

Drinking and drug use is as big a problem among motorcyclists as it is among automobile drivers. Motorcyclists, however, are more likely to be killed or severely injured in a crash. Injuries occur in 90% of motorcycle crashes and 33% of automobile crashes that involve abuse of substances. On a yearly basis, 2,000 motorcyclists are killed and about 50,000 seriously injured in this same type of crash. These statistics are too overwhelming to ignore.

By becoming knowledgeable about the effects of alcohol and drugs you will see that riding and substance abuse don't mix. Take positive steps to protect yourself and prevent others from injuring themselves.

ALCOHOL AND DRUGS IN MOTORCYCLE OPERATION

No one is immune to the effects of alcohol or drugs. Friends may brag about their ability to hold their liquor or perform better on drugs, but alcohol or drugs make them less able to think clearly and perform physical tasks skillfully. Judgment and the decision-making processes needed for vehicle operation are affected long before legal limits are reached.

Many over-the-counter, prescription and illegal drugs have side effects that increase the risk of riding. It is difficult to accurately measure the involvement of particular drugs in motorcycle crashes. But we do know what the effects of various drugs have on the processes involved in riding a motorcycle. We also know that the combined effects of alcohol and drugs are more dangerous than either is alone.

ALCOHOL IN THE BODY

Alcohol enters the bloodstream quickly. Unlike most foods and beverages, it does not need to be digested. Within minutes after being consumed, it reaches the brain and begins to affect the drinker. The major effect alcohol has is to slow down and impair bodily functions — both mental and physical. Whatever you do, you do less well after consuming alcohol.

Blood Alcohol Concentration

Blood Alcohol Concentration or BAC is the amount of alcohol in relation to blood in the body. Generally, alcohol can be eliminated in the body at the rate of almost one drink per hour. But a variety of factors may also influence the level of alcohol retained. The more alcohol in your blood, the greater the degree of impairment.

Three primary factors play a major part in determining BAC:

- **The amount** of alcohol you consume.
- **How fast** you drink.
- **Your body** weight.

Other factors also contribute to the way alcohol affects your system.

Your sex, physical condition and food intake are just a few that may cause your BAC level to be even higher. But the full effects of these are not completely known. **Alcohol may still accumulate in your body even if you are drinking at a rate of one drink per hour.** Abilities and judgment can be affected by that one drink.

A 12-ounce can of beer, a mixed drink with one shot (1.5 ounces) of hard

liquor, and a 5-ounce glass of wine all contain the same amount of alcohol.

The faster you drink, the more alcohol accumulates in your body. If you drink two drinks in an hour, at the end of that hour, at least one drink will remain in your bloodstream.

Without taking into account any other factors, these examples illustrate why time is a critical factor when a rider decides to drink.

If you drink:

– Seven drinks over the span of three hours you would have at least four ($7 - 3 = 4$) drinks remaining in your system at the end of the three hours. You would need at least another four hours to eliminate the alcohol from the four remaining drinks before you consider riding.

– Four drinks over the span of two hours, you would have at least two ($4 - 2 = 2$) drinks remaining in your system at the end of the two hours. You would need at least another two hours to eliminate the alcohol from the two remaining drinks before you consider riding.

ALCOHOL CONTENT

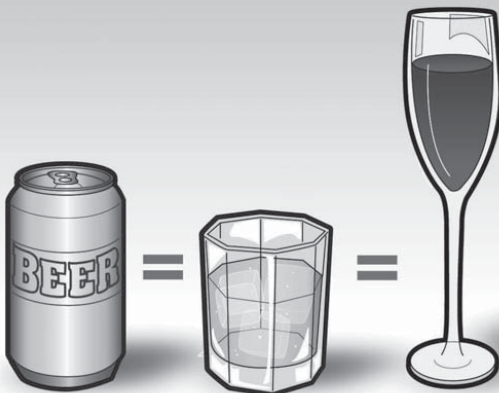

ALCOHOL AND THE LAW

In all states, an adult with a BAC of 0.08% or above is considered intoxicated. For operators under the age of 21, lower BAC limits (0.00 to 0.02%, depending on state) apply. It doesn't matter how sober you may look or act. A breath, blood, or urine test is what usually determines whether you are riding legally or illegally.

Whether or not you are legally intoxicated is not the real issue. Impairment of judgment and skills begins well below the legal limit.

Your chances of being stopped for riding under the influence of alcohol are increasing. Law enforcement is being stepped up across the country in response to the senseless deaths and injuries caused by drinking drivers and riders.

Consequences of Conviction

Years ago, first offenders had a good chance of getting off with a small fine and participation in alcohol-abuse classes. Today the laws of most states impose stiff penalties on drinking operators. And those penalties are mandatory, meaning that judges must impose them.

If you are convicted of riding under the influence of alcohol or drugs, you may receive any of the following penalties:

- **License Suspension** — Mandatory suspension for conviction, arrest or refusal to submit to a breath test.
- **Fines** — Severe fines are another aspect of a conviction, usually levied with a license suspension.
- **Insurance Rate Increase** — A DUI/DWI conviction can put you into a "high risk" category. So, having a DUI on your driving record means you'll be paying for it long after your court or legal interactions have ended.

- **Community Service** — Performing tasks such as picking up litter along the highway, washing cars in the motor-vehicle pool or working at an emergency ward.
- **Costs** — Additional lawyer's fees, lost work time spent in court or alcohol-education programs, public transportation costs (while your license is suspended), and the added psychological costs of being known as a "drunk driver."

MINIMIZE THE RISKS

Your ability to judge how well you are riding is affected first. Although you may be performing more and more poorly, you think you are doing better and better. The result is that you ride confidently, taking greater and greater risks. Minimize the risks of drinking and riding by taking steps before you drink or choose to totally separate the two. Control your drinking or control your riding.

Make an Intelligent Choice

Don't Drink — Once you start, your resistance is weaker.

Setting a limit or pacing yourself are poor alternatives at best. Your ability to use good judgment is one of the first things affected by alcohol. Even if you have tried to drink in moderation, you may not realize to what extent your skills have suffered from alcohol's fatiguing effects.

Or Don't Ride — If you haven't controlled your drinking, you must control your riding.

- **Leave the motorcycle** — so you won't be tempted to ride. Arrange another way to get home.
- **Wait** — If you exceed your limit, wait until your system eliminates the alcohol and its fatiguing effects.

STEP IN TO PROTECT A FRIEND

People who have had too much to drink are unable to make a responsible decision. It is up to others to step in and keep them from taking too great a risk. No one wants to do this — it's uncomfortable and embarrassing. And you are rarely thanked for your efforts at the time. But the alternatives are often worse.

There are several ways to keep friends from hurting themselves:

- **Arrange a safe ride** — Provide alternative ways for them to get home.
- **Slow the pace of drinking** — Involve them in other activities.
- **Keep them there** — Use any excuse to keep them from getting on their motorcycle. Serve them food and coffee to pass the time. Explain your concerns for their risks of getting arrested or hurt or hurting someone else. Take their key, if you can, and secure their bike.
- **Get friends involved** — Use peer pressure from a group of friends to intervene.

It helps to enlist support from others when you decide to step in. The more people on your side, the easier it is to be firm and the harder it is for the rider to resist. While you may not be thanked at the time, you will never have to say, "If only I had..."

MARIJUANA AND MOTORCYCLE OPERATION

Marijuana is gaining acceptance as having legitimate medicinal applications and as a recreational drug in the United States, as evidenced by recent trends in state laws permitting its use. As of early 2014, 20 states allowed marijuana

for medical use, and two allowed it for recreational use by people 21 and over.

Although marijuana may be legal for medicinal or recreational use in your state, it is still not legal, safe, or wise to operate a motor vehicle while impaired by marijuana, since it tends to distort your perception of time, space and speed. This is especially critical for motorcycle riders, who must continually make detailed assessments of complex traffic situations and make split-second decisions requiring precise rider input to navigate safely and maintain an adequate safety margin.

States are beginning to set marijuana impairment limits based on blood content levels of marijuana's primary psychoactive ingredient, THC. However, compared to alcohol and BAC level, it is difficult to determine the relationship between the amount of marijuana ingested and the resulting THC level in the blood. Complicating factors include marijuana's potency, which is highly variable, and ingestion method, which has significant bearing on the onset and duration of impairment.

When marijuana is smoked, its effects generally begin within a few minutes and can last from 2 to 4 hours. But when marijuana is eaten the onset of effects could be delayed for more than an hour and the duration of the "high" could be more than 6 hours.

Be safe. Do not operate your motorcycle or any motor vehicle if you are impaired by marijuana, and find alternate transportation if you are planning to be under the influence of marijuana at your destination. Just as with alcohol, riders impaired by marijuana can be convicted of riding under the influence, and be subjected to similar harsh penalties.

FATIGUE

Riding a motorcycle is more tiring than driving a car. On a long trip, you'll tire sooner than you would in a car. Avoid riding when tired. Fatigue can affect your control of the motorcycle.

- **Protect yourself from the elements** — Wind, cold, and rain make you tire quickly. Dress warmly. A windshield is worth its cost if you plan to ride long distances.
- **Limit your distance** — Experienced riders seldom try to ride more than about six hours a day.
- **Take frequent rest breaks** — Stop and get off the motorcycle at least every two hours.
- **Don't drink or use drugs** — Artificial stimulants often result in extreme fatigue or depression when they wear off. Riders are unable to concentrate on the task at hand.

TEST YOURSELF

14

If you wait one hour per drink for the alcohol to be eliminated from your body before riding:

- A. You cannot be arrested for drinking and riding.
- B. Your riding skills will not be affected.
- C. Side effects from the drinking may still remain.
- D. You will be okay as long as you ride slowly.

Answer - page 48

Safe riding requires knowledge and skill. Licensing tests are the best measurement of the skills necessary to operate safely in traffic. Assessing your own skills is not enough. People often overestimate their own abilities. It's even harder for friends and relatives to be totally honest about your skills. Licensing exams are designed to be scored more objectively.

To earn your license, you must pass a knowledge test and an on-cycle skill test. Knowledge test questions are based on information, practices and ideas from this manual. They require that you know and understand road rules and safe riding practices. An on-cycle skill test will either be conducted in an actual traffic environment or in a controlled, off-street area.

Knowledge Test

(Sample Questions)

1. It is MOST important to flash your brake light when:

- A. Someone is following too closely.
- B. You will be slowing suddenly.
- C. There is a stop sign ahead.
- D. Your signals are not working.

2. The FRONT brake supplies how much of the potential stopping power?

- A. About 25%.
- B. About 50%.
- C. About 70%.
- D. All of the stopping power.

3. To swerve correctly:

- A. Shift your weight quickly.
- B. Turn the handlebars quickly.
- C. Press the handgrip in the direction of the turn.
- D. Press the handgrip in the opposite direction of the turn.

4. If a tire goes flat while riding and you must stop, it is usually best to:

- A. Relax on the handgrips.
- B. Shift your weight toward the good tire.
- C. Brake on the good tire and steer to the side of the road.
- D. Use both brakes and stop quickly.

5. The car below is waiting to enter the intersection. It is best to:

- A. Make eye contact with the driver.
- B. Reduce speed and be ready to react.
- C. Maintain speed and position.
- D. Maintain speed and move right.

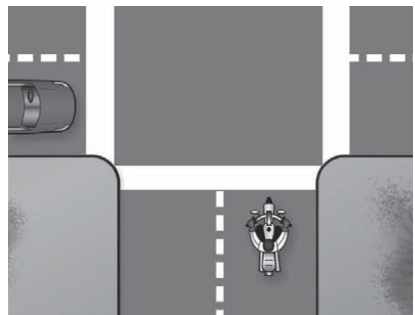

On-Motorcycle Skill Test

Basic vehicle control and crash-avoidance skills are included in on-motorcycle tests to determine your ability to handle normal and hazardous traffic situations.

You may be tested for your ability to:

- **Know your motorcycle** and your riding limits.
- **Accelerate, brake and turn safely.**
- **See, be seen** and communicate with others.
- **Adjust speed** and position to the traffic situation.

- **Stop, turn and swerve quickly.**
- **Make critical decisions** and carry them out.

Examiners may score on factors related to safety such as:

- **Selecting** safe speeds to perform maneuvers.
- **Choosing** the correct path and staying within boundaries.
- **Completing** normal and quick stops.
- **Completing** normal and quick turns or swerves.

Answers to Test Yourself (throughout the booklet)

1-C, 2-D, 3-D, 4-A, 5-B,
6-C, 7-D, 8-D, 9-C, 10-C,
11-D, 12-A, 13-A, 14-C

Answers to Knowledge Test (p.47):

1-B, 2-C, 3-C, 4-C, 5-B

Diagrams and drawings used in this manual are for reference only and are not to correct scale for size of vehicles and distances.

SUPPLEMENTARY INFORMATION FOR THREE-WHEEL MOTORCYCLES

Many states require a separate license endorsement to operate a three-wheel motorcycle. This requires the rider to pass both a written and a skills test. The purpose of this supplement is to help prepare riders to complete the written exam for a three-wheel motorcycle license or endorsement. This information is provided in addition to that offered in the first part of this Motorcycle Operator Manual (MOM), so when preparing to take the written test, begin by reading the information on two-wheel motorcycles thoroughly. It provides information on safe operation of your motorcycle in traffic. This supplement contains information specific to the safe operation of a three-wheel motorcycle, including both three-track motorcycles and motorcycles with sidecars.

KNOW YOUR VEHICLE

There are many types of three-wheel motorcycles available on the market today. Requirements for licensing three-wheel motorcycles vary by state. In general, three-wheel motorcycles will have the following characteristics:

1. **Three wheels** leaving two or three separate tracks during straight line operation.
2. **Motorcycle-based** conversion or design with:
 - **Handlebar steering**
 - Motorcycle-type controls with the standard layout. Convenience alterations like a single brake pedal or lever control, automatic clutch, or automatic transmission.

- **Saddle seating**
 - Seating in which the rider/passenger straddles the vehicle.
 - If designed for a passenger, the passenger must be seated behind the operator (or in a separate passenger compartment in the case of a motorcycle with sidecar).
- 3. **Turning** diameter of the vehicle at its widest point must be less than 40'.
- 4. **The vehicle** meets all applicable federal on-road vehicle standards.

The following vehicles are not included in this definition, and therefore testing requirements may not be applicable. Always refer to your state Department of Motor Vehicles, Department of Licensing or other appropriate state regulatory agency for exact regulations regarding testing for:

- **Automotive hybrids** or automotive conversions
 - **Vehicles with automotive** controls or seating
 - **Vehicles with front or rear mounted engines** (engines must be mounted mid-frame below the rider to be considered motorcycle-based)
 - **Vehicles with enclosed** or semi-enclosed riding compartments
 - **Motorcycles or scooters** with two close-set wheels in front (contact patches less than 18.1 inches apart) that lean and maneuver like standard, single-track, two-wheel motorcycles
- or**
- **Vehicles** with any other departure from the above standards.

Three-Wheel Motorcycle Designs

Three-wheel motorcycle designs vary among manufacturers. Unlike traditional motorcycles, which are considered single-track motorcycles, three-wheel motorcycles could be either dual or triple track design. Dual track vehicles are motorcycles with sidecars, while triple track motorcycles can be configured either with dual front wheels or dual rear wheels.

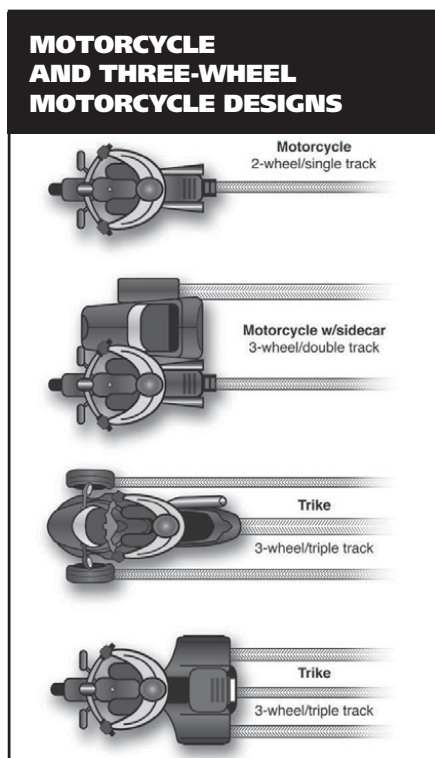

The Right Motorcycle for You

Make sure your three-wheel motorcycle or sidecar-equipped motorcycle is right for you. You should be able to comfortably reach and operate all of the controls, and be able to complete full turns using the

handlebars without excessive upper body movements that could jeopardize stability and control.

Borrowing and Lending

Borrowers and lenders, beware.

Crashes are fairly common among beginning operators, especially in the first months of riding. Operating an unfamiliar motorcycle adds to the problem. If you borrow a three-wheel motorcycle or motorcycle with sidecar, get familiar with it in a controlled area first. If you lend your three-wheel motorcycle or motorcycle with sidecar to friends, make sure they are licensed and know how to ride before you allow them to operate in traffic. Such motorcycles operate very differently than two-wheel motorcycles.

No matter how experienced you may be, be extra careful on any vehicle that is unfamiliar or new to you.

Get Familiar with Motorcycle Controls

Be sure you are familiar with the controls of the three-wheel motorcycle or motorcycle with a sidecar before attempting to operate it on any highway, since some controls may differ from those found on other motorcycles. This is especially important if you are riding on a borrowed motorcycle. Before beginning the ride:

- **Make all the checks** you would on your own motorcycle.
- **Familiarize yourself** with all controls, such as the turn signals, horn, headlight switch, fuel control valve, and cut-off switch. Locate and operate these items without having to search for them.

- **Operate all the controls** before you start riding. Know the gearshift pattern and operate the throttle, clutch and brakes a few times. Controls react differently on different motorcycles, and exact locations of controls may vary slightly. Additionally, some motorcycle conversions may be equipped with a single brake pedal or lever control, automatic clutch, or automatic transmission.
- **As you begin to ride**, start out slowly and carefully and be aware of your surroundings. Accelerate gently, take turns a little more slowly, and leave extra room for stopping.

BASIC VEHICLE CONTROL

Steering & Tip

Three-wheel motorcycles handle differently than two-wheel motorcycles. With three wheels on the ground, they are naturally more stable than a two-wheel motorcycle. They also steer differently. Because conventional three-wheel motorcycles cannot lean, they cannot countersteer. Instead, the front wheel is pointed in the direction the rider wants the motorcycle to go.

Under some conditions during the operation of a three-wheel motorcycle, it is possible to have only two wheels in contact with the road surface. This could occur during turning or tight maneuvers whenever enough weight is transferred outside of what are called tip-over lines. This tendency requires careful load and passenger positioning inside the tip-over lines to help maintain maximum stability.

Body Position

As with any motor vehicle, operator position is important for control and for reducing or preventing fatigue. The operator should be able to reach both handgrips comfortably, since more handlebar movement is necessary than when riding a two-wheel motorcycle. While it is not necessary for the rider of a three-wheel motorcycle to move drastically during operation, shifting weight in the direction of the turn can improve control.

Braking

On a motorcycle with a sidecar, during braking in a sharp turn, the sidecar wheel may lift off the ground. Motorcycle and sidecar tires have limited traction or grip on the road surface, and traction is greater when the motorcycle is rolling, not skidding or slipping. During turning, some of the available tire traction is used for cornering, so less is available for stopping. Thus, a skid can occur if you brake too hard.

Turning

The tendency of the rear inside wheel to lift during turning is greater with increased speed and tighter curve radii. During a turn, inertia causes the center of gravity of the motorcycle to shift sideways and outward toward the

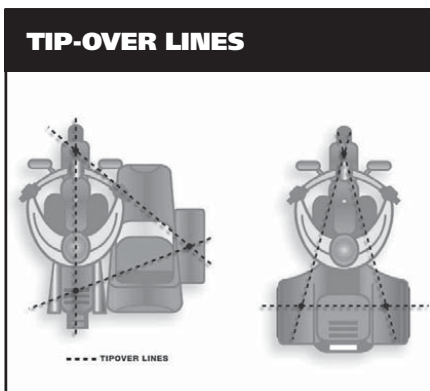

tip-over line. The reduced weight over the opposite side wheel can cause it to lift slightly.

The weight of a three-track motorcycle is distributed almost equally between the two front or two rear wheels. These motorcycles handle the same in left and right hand turns.

When turning a three-track motorcycle:

- **Approach a turn** at speed with your head up, and look through the turn.
- **Concentrate** on pointing the front wheel/wheels in the direction you want the motorcycle to go.
- **Roll off** the throttle before entering the turn.
- **Apply the brakes** enough to slow the motorcycle to a speed at which you can ride safely through the turn, then release the brakes before the turn.
- **Slightly lean** your upper body in the direction you intend to turn.
- **Steer** the front wheel/wheels toward the turn.
- **Roll on** the throttle to pull the motorcycle through the turn.

On the other hand, because the center of gravity of a motorcycle with sidecar is close to the motorcycle itself, the behavior of the vehicle when turning right and when turning left is quite different.

During a right turn, a slight sideways movement of the center of gravity creates a greater tendency for the sidecar wheel to lift. The lift will be greater if the sidecar is empty or lightly loaded.

When turning right on a motorcycle with sidecar:

- **Anticipate** the degree of turn required.
- **Reduce speed** before entering the curve by downshifting or braking.
- **Slightly lean** your upper body in the direction you intend to turn.
- **Maintain speed** as you enter the curve.
- **Accelerate** gradually as you exit the curve.

During a left hand turn, the sidecar acts as a stabilizer, so the sidecar wheel stays on the ground. However, if the turn is taken too sharply or at too high a rate of speed, there is a tendency for the motorcycle rear suspension to extend, and this may cause the rear wheel of the motorcycle to lift off the ground.

When turning left on a motorcycle with sidecar:

- **Reduce** speed prior to entering the turn
- **Apply** more pressure on the rear brake then on the front

Hills

When riding uphill on a three-wheel motorcycle or motorcycle with a sidecar, some weight will shift to the rear, causing the front of the motorcycle to become lighter. This weight shift reduces the traction on the front tire/tires for steering and tire grip.

When riding downhill, gravity increases the amount of braking force required to slow or stop the motorcycle. It is important, therefore, to begin slowing earlier for cornering and stopping.

Lane Position

The track of the dual wheels of a three-wheel motorcycle or motorcycle with a sidecar is almost the same width as some automobiles. Unlike a motorcycle, you are limited, therefore, in lane positioning. Keep toward the center of the lane to be sure the track of the dual wheels does not cross the painted lines into opposing traffic. Riding too far to the right could cause loss of traction if the tire leaves the pavement.

Lane positioning when riding in groups is also an important consideration. You will not be able to use a staggered formation, such as you would when riding two-wheeled motorcycles. Ride single file and always maintain a safe margin, two seconds minimum, between vehicles.

Parking at the Roadside

Because of the limitations on mobility and motorcycle length, it is not practical to park your motorcycle at a 90 degree angle with your rear wheel touching the curb, as you would with a two-wheel motorcycle. Position your motorcycle in a parking space so you are parked parallel to the curb and set the parking brake. Some three-wheel motorcycles have reverse, so you can more easily maneuver into a parking space designed for an automobile. Parking parallel to the curb will facilitate pulling away from the curb and entering the lanes of traffic.

Acceleration and Deceleration

A three-wheel motorcycle with two drive wheels tends to be much more stable during acceleration and braking than a motorcycle with a sidecar. Attaching a sidecar to your motorcycle adds a non-powered, off-centered mass of weight. So, during acceleration,

the sidecar will feel as though it is lagging behind you, causing the vehicle to feel as though it is being steered to the right. During deceleration or braking, the momentum of the sidecar continues to carry it forward, giving the feeling that the sidecar is trying to pass you, making the motorcycle feel as though it is being steered left.

- **On acceleration**, compensate for this tendency by steering slightly in the opposite direction from the sidecar.
- **On deceleration**, compensate for this tendency by steering slightly in the direction of the sidecar. You can also pull in the clutch when braking.

Swerving

A quick stop may not always be sufficient to avoid an obstacle in your path, even if you properly apply both brakes. Sometimes the only way to avoid a collision is to swerve. A swerve is any sudden change of direction. It can be two quick turns or a rapid shift to the side when maneuvering the motorcycle. Often, there is not much time to adjust your body position.

A three-wheel motorcycle or motorcycle with sidecar is not as maneuverable as a two-wheel motorcycle, so plan well ahead to avoid the need for any sudden turns or swerving. If braking is required, brake either before or after the swerve, never while swerving.

Cornering & Curves

The cornering characteristics of a three-wheel motorcycle or motorcycle with a sidecar differ from those of a motorcycle. Even with three wheels on the ground, a sidecar can tip over if it is being turned too sharply or is going too fast for a corner. Therefore, it is best to

PATH THROUGH A CURVE



always slow before entering a corner.

The best path to follow in the curve may not be the one that follows the curve of the road. Following the center of the lane may actually increase the tip over forces. Check opposing traffic carefully, and if safe, enter the curve toward the outside of your lane. This increases your line of sight through the curve and reduces the effective radius of the curve. As you turn, move toward the inside of the curve, and as you pass the center, move to the outside to exit, always remembering to stay in your lane.

CARRYING PASSENGERS AND CARGO

Three-wheel motorcycles are designed to carry passengers and cargo, but always be sure not to exceed the tire or motorcycle loading capacity. The extra weight could change the handling characteristics of the vehicle slightly, so you must give some thought to where the loads are positioned.

Many three-track motorcycles will have built-in storage compartments for cargo, either in front of, or behind the rider. On these motorcycles, center the load and keep it low in the storage areas so it is positioned within the tip-over lines and balanced side-to-side. If a passenger is being carried, the passenger will sit directly behind the rider.

On a motorcycle with a sidecar, the best place for a passenger is in the sidecar. Never put a single passenger on the saddle; the added weight on the tip-over-line will increase the instability of the motorcycle. While a second passenger can be carried on the seat behind the rider, the heavier passenger should always be in the sidecar.

The passenger sitting behind the rider should sit upright at all times. It is not necessary for the passenger to lean into curves with the rider.

When carrying loads in a sidecar, secure the load firmly in place, since if the load shifts, handling will be affected. Loads should be distributed toward the rear of the sidecar to reduce tipping of the nose of the sidecar in the event of a sudden left turn.

When loaded, you may find performance is reduced and that stopping distances are longer, so allow a little extra distance. The addition of a sidecar passenger will greatly improve stability, and right hand turns can be made at a slightly higher speed. Turning left, however, will require more turning force.

HAND SIGNALS

1 Single File –
arm and index
finger extended
straight up.



2 Double File –
arm with index
and middle finger
extended straight up.



3 Stop –
arm extended
straight down,
palm facing
back.



4 Speed Up –
arm extended
straight out,
palm facing up,
swing upward.



5 Slow Down –
arm extended
straight out, palm
facing down, swing
down to your side.



6 Follow Me –
arm extended
straight up
from shoulder,
palm forward.



7 You Lead/Come –
arm extended upward 45 degrees,
palm forward pointing with index
finger, swing in arc from back to front.



HAND SIGNALS

8 Hazard in Roadway –

on the left, point with left hand; on the right, point with right foot.



9 Highbeam –

tap on top of helmet with open palm down.



10 Fuel –

arm out to side pointing to tank with finger extended.



11 Comfort Stop –

forearm extended, fist clenched with short up and down motion.



12 Refreshment Stop –

fingers closed, thumb to mouth.



13 Turn Signal On –

open and close hand with fingers and thumb extended.



14 Pull Off –

arm positioned as for right turn, forearm swung toward shoulder.



T-CLOCS: Pre-Ride Inspection Checklist

T-CLOCS ITEM	WHAT TO CHECK	WHAT TO LOOK FOR	CHECK-OFF	
T-TIRES & WHEELS				
Tires	Condition	Tread depth, wear, weathering, evenly seated, bulges, embedded objects.	Front	Rear
	Air Pressure	Check when cold, adjust to load.	Front	Rear
Wheels	Spokes	Bent, broken, missing, tension, check at top of wheel: "ring" = OK — "thud" = loose spoke	Front	Rear
	Cast	Cracks, dents.	Front	Rear
	Rims	Out of round/true = 5mm. Spin wheel, index against stationary pointer.	Front	Rear
	Bearings	Grab top and bottom of tire and flex: No freeplay (click) between hub and axle, no growl when spinning.	Front	Rear
	Seals	Cracked, cut or torn, excessive grease on outside, reddish-brown around outside.	Front	Rear
Brakes	Function	Each brake alone keeps bike from rolling.	Front	Rear
C-CONTROLS				
Levers and Pedal	Condition	Broken, bent, cracked, mounts tight, ball ends on handlebar levers, proper adjustment.		
	Pivots	Lubricated.		
Cables	Condition	Fraying, kinks, lubrication: ends and interior.		
	Routing	No interference or pulling at steering head, suspension, no sharp angles, wire supports in place.		
Hoses	Condition	Cuts, cracks, leaks, bulges, chafing, deterioration.		
	Routing	No interference or pulling at steering head, suspension, no sharp angles, hose supports in place.		
Throttle	Operation	Moves freely, snaps closed, no revving when handlebars are turned.		
L-LIGHTS				
Battery	Condition	Terminals; clean and tight, electrolyte level, held down securely.		
	Vent Tube	Not kinked, routed properly, not plugged.		
Headlamp	Condition	Cracks, reflector, mounting and adjustment system.		
	Aim	Height and right/left.		
	Operation	Hi beam/low beam operation.		
Tail lamp/ brake lamp	Condition	Cracks, clean and tight.		
	Operation	Activates upon front brake/rear brake application.		
Turn signals	Operation	Flashes correctly.	Front left Rear left	Front right Rear right
Mirrors	Condition	Cracks, clean, tight mounts and swivel joints.		
	Aim	Adjust when seated on bike.		
Lenses & Reflectors	Condition	Cracked, broken, securely mounted, excessive condensation.		
Wiring	Condition	Fraying, chafing, insulation.		
	Routing	Pinched, no interference or pulling at steering head or suspension, wire looms and ties in place, connectors tight, clean.		
O-OIL				
Levels	Engine Oil	Check warm on center stand on level ground, dipstick, sight glass.		
	Hypoid Gear Oil, Shaft Drive	Transmission, rear drive, shaft.		
	Hydraulic Fluid	Brakes, clutch, reservoir or sight glass.		
	Coolant	Reservoir and/or coolant recovery tank — check only when cool.		
	Fuel	Tank or gauge.		
Leaks	Engine Oil	Gaskets, housings, seals.		
	Hypoid Gear Oil, Shaft Drive	Gaskets, seals, breathers.		
	Hydraulic Fluid	Hoses, master cylinders, calipers.		
	Coolant	Radiator, hoses, tanks, fittings, pipes.		
	Fuel	Lines, fuel valve, carbs.		

You can tear this page out and keep it with you when you ride.

T-CLOCS: Pre-Ride Inspection Checklist

T-CLOCS ITEM WHAT TO CHECK WHAT TO LOOK FOR CHECK-OFF

C-CHASSIS				
Frame	Condition	Cracks at gussets, accessory mounts, look for paint lifting.		
	Steering-Head Bearings	No detent or tight spots through full travel, raise front wheel, check for play by pulling/pushing forks.		
	Swingarm Bushings/ Bearings	Raise rear wheel, check for play by pushing/pulling swingarm.		
Suspension	Front Forks	Smooth travel, equal air pressure/damping, anti-dive settings.	Left	Right
	Rear Shock(s)	Smooth travel, equal pre-load/air pressure/damping settings, linkage moves freely and is lubricated.	Left	Right
Chain or Belt	Tension	Check at tightest point.		
	Lubrication	Side plates when hot. Note: do not lubricate belts.		
	Sprockets	Teeth not hooked, securely mounted		
Fasteners	Threaded	Tight, missing bolts, nuts.		
	Clips	Broken, missing.		
	Cotter Pins	Broken, missing.		
S-STANDS				
Center stand	Condition	Cracks, bent.		
	Retention	Springs in place, tension to hold position.		
Side stand	Condition	Cracks, bent (safety cut-out switch or pad equipped).		
	Retention	Springs in place, tension to hold position.		

You can tear this page out and keep it with you when you ride.

EMERGENCY INFORMATION

Rider's Name _____ Blood Type _____

Allergies/Medical Conditions _____

Doctor's Name/Phone _____

Cycle Insurer Name/Phone _____

Contact this person if rider is injured

Name _____ Home Phone _____

Work Phone _____ Cell Phone _____

MOTORCYCLES MAKE SENSE – SO DOES PROFESSIONAL TRAINING

Motorcycles are inexpensive to operate, fun to ride and easy to park. Unfortunately, many riders never learn critical skills needed to ride safely.

Professional training for beginning and experienced riders prepares them for real-world traffic situations. Motorcycle Safety Foundation *RiderCoursesSM* teach and improve such skills as:

- Effective turning
- Braking maneuvers
- Protective apparel selection
- Obstacle avoidance
- Traffic strategies
- Maintenance

**For the basic or experienced *RiderCourse* nearest you,
call toll free: 800.446.9227
or visit msf-usa.org**

The Motorcycle Safety Foundation's (MSF) purpose is to improve the safety of motorcyclists on the nation's streets and highways. In an attempt to reduce motorcycle crashes and injuries, the Foundation has programs in rider education, licensing improvement, public information and statistics. These programs are designed for both motorcyclists and motorists. A national not-for-profit organization, the MSF is sponsored by BMW, BRP, Harley-Davidson, Honda, Kawasaki, KTM, Piaggio, Suzuki, Triumph, Victory and Yamaha.

The information contained in this publication is offered for the benefit of those who have an interest in riding motorcycles. The information has been compiled from publications, interviews and observations of individuals and organizations familiar with the use of motorcycles, accessories, and training. Because there are many differences in product design, riding styles, federal, state and local laws, there may be organizations and individuals who hold differing opinions. Consult your local regulatory agencies for information concerning the operation of motorcycles in your area. Although the MSF will continue to research, field test and publish responsible viewpoints on the subject, it disclaims any liability for the views expressed herein.



Printing and distribution courtesy of
Motorcycle Safety Foundation
msf-usa.org

Second Revision	December 1978	Tenth Revision	January 2002
Third Revision	February 1981	Eleventh Revision.....	July 2002
Fourth Revision	January 1983	Twelfth Revision	May 2004
Fifth Revision	October 1987	Thirteenth Revision.....	June 2007
Sixth Revision	April 1991	Fourteenth Revision.....	March 2008
Seventh Revision	September 1992	Fifteenth Revision	June 2009
Eighth Revision	January 1999	Sixteenth Revision	January 2011
Ninth Revision.....	March 2000	Seventeenth Revision.....	February 2014



Tennessee Department of Safety and Homeland Security, Authorization No. 349234, 50,000 copies, August 2016. This public document was promulgated at a cost of \$.46 per copy.