

**NEW POWER STEERING PUMPS FROM \$179 + gst**

**NEW PUMPS FULLY WARRANTED EXPRESS DELIVERY ACROSS AUSTRALIA  
RING JOE FOR YOUR VERY BEST PRICES**

**ALFA ROMEO 156**



156 2.0 Twin Spark  
GT 2.0 Spyder  
**TPP AR017N**

**ALFA 159 / AUDI A4**



Alfa 159  
Diesel Turbo 1.9  
Audi A4  
**TPP 21-5352**

**AUDI 80 90**

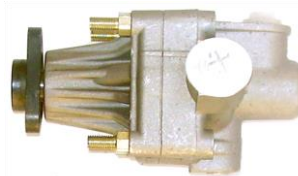

Audi 80 2.0 1981-94  
Audi 90 2.0 1981-91  
VW Passat 1988-95  
**TPP 050145155AX**

**AUDI A3**



Audi A3 1.6 96-00;  
1.8, 1.8T, Quattro  
1.9Tdi 1996 to 2014  
**TPP 1JO 422 154C**

**AUDI A3**



A3 1.6 1.8 1.8T  
1.9Tdi  
**TPP 27145157N**

**AUDI A4 A6**



2.8 & 3.0 incl Quattros  
A80/90 6 cyl.  
A4/S4 1.8 2.0 A6/S6  
TT 2000-06  
**8D0145156N**

**AUDI A6 100**



A6 1.8 2.6 2.4 incl Avant  
Audi 100 2.0  
Avant 2.6  
**TPP AU105N**

**AUDI A6**



A6 C6 4F  
2.4, 2.8FSi, 3.0 TFSi, 3.2 FSi  
Includes Avant and Quattros  
**4F0145155H**

**AUDI A4 A6**



A4 2.4 2.8 10/96-12/04  
A6 V6 2.5tdi & 2.8 97- 01/05  
2.7t V6 99 on  
Passat 2.8 V6 98-05  
Skoda Superb 12/01-03/08  
**TPP 8D0145156FN**

**AUDI Q5**



Q5 (8R) 2.0 TFSi Quattro  
& 2.0 TDi  
11/2008-2016  
**TPP 7651974127**

**AUDI Q7**



Q7 3.0 TDi Quattro  
3/06 to 8/15;  
6.0 TDi Quattro  
9/08 to 5/14  
**TPP7L8422154**

**AUDI A4 A5**



A4 3.2 FSi 09/08-03/12  
A4 3.2 FSi quattro 11/07-03/12  
S4 3.0 quattro 11/08-12/15  
A5 Coupe  
3.2 FSi Coupe & qtro 6/07-03/12  
S5 3.0 quattro/conv 10/11-1/17  
3.2 FSi & quattro conv 3/09-3/12  
**8K0145156E**

**BMW 1/3 3.0**



E81 E87 05-12  
E90 E93 05-11  
E84 X1 09-15

**TPP 32414039954**

**BMW 1/3 E81/90/91**



1 118D 120D 06 to 12  
3 318D 320D 04 to 12  
3 Touring Wagon 2005 on

**TPP 32414029151**

**BMW 7 E65/66/67**



730i Li 3.0

03-2003 to 07-2008

**32416766071**

**BMW E30 E39 E38**



E30 3 Series  
E39 5 Series  
E38 7 Series

**TPP1092135N**

**BMW E38-83**



E38 E39 3E46 E53 E60 E61

E65 E83 3.0Td

Also Range Rover Mk3

L322 3.0 TD

03-2002 to 8-2012;

**QVB 000230**

**BMW E46**



320i & Ci, 325i & Ci 10/00 on

323i & Ci 5/99 on

328i 10/98 on

328Ci 10/99on,330i/Ci 10/00

**TPP ME9067N**

**BMW E46**



3 SERIES to 9/1999

323i 323Ci

325i 325Ci

328Ci

**TPP 32411094965**

**BMW E53**



X5 8cyl

4.4 4.4i 4.38 4.0is

2002-2003

**TPP32416757913**

**BMW E53**



E53 X5

8cyl 3.0i

2001-2006

**TPP 3241675840**

**BMW E53**

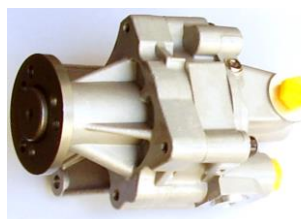

E53 X5

4.4i, 4.6is

2000-10/2002

**TPP 32411096434**

**BMW E82 - E93**



E82 E88 128i

E90: (325 328 330) i/xi

E91: 325xi 328i 328xi

E92: 328i 328xi E93: 328i

**TPP 32414042171**

**BMW X5**



X5

**TPP BM301**

**BMW E24 E28 E30**



E24 6 series 85-90

E28 5 series 81-87

E30 3 series 81-94

**TPP32411126845**

**BMW MINI**



Mini 1D

2003 - 2006

**TPP 32416766051**

### CITROEN



Berlingo. Xsara, ZX (N2)  
Peugeot 306 1.9D, 405  
**TPP C17**

### DAEWOO ESPERO



1.5  
1993 to 1999  
**TPP 90412113**

### DAEWOO LEGANZA



1997-2002  
**TPP 96215322**

### DAEWOO NUBIRA



1.6 1997 to 2003  
Lalosi 1.6 2002  
**TPP 96460960**

### FORD FALCON



Falcon/Fairlane EA EB ED  
**TPP 1309N**  
EF AU Series I II III  
**TPP 1538N**

### FORD FALCON



Falcon  
BA 6 cyl  
**TPP 1895N**

### FORD FALCON



Falcon BA V8  
**TPP 1896N**

### FORD MAVERICK



Ford Maverick  
Tribute V6  
**TPP 1784**

### FORD TRANSIT



2.4 TDCi  
4x4 11/06-8/14  
RWD 04/06-08/14  
**TPP 1370729**

### FORD MONDEO III



Clipper 2.5 0  
1/10/00 to 01/3/07;  
Renault Laguna 1.6 16V  
**1S7C3A696AJ**

### FORD MONDEO IV



2.3 2007-2015  
S-Max 2.0 2.3 2006-2014  
Galaxy 2.0  
**TPP 6G913A696AG**

### HOLDEN VN on



Commodore 6cyl  
VN VP VR: **TPP 1343N**  
VS VT VY: **TPP 1532N**

### HOLDEN VZ



Commodore VZ  
6cyl: **TPP 1942N**  
8cyl: **TPP 1951N**



**HOLDEN CRUZE**



1.6 1.8 2009 on  
1.8 LPG 2011 on  
**TPP96837813**

**CHEVROLET CRUZE**



J300 1.6 1.8  
**TPP96837812**

**HOLDEN VECTRA**



JS 2.6 V6  
**TPP 8D0145156FN**

**HOLDEN RODEO**



Rodeo RA 07 on  
Colorado  
D-Max 3.0  
Turbo Diesel 4JJ1  
**TPP 97946698**  
**(OEM: 8-97946-694-0)**

**HOLDEN RODEO**



Rodeo TF  
4 & 6cyl  
Petrol/Diesel  
6/94 on  
**TPP 1616N**

**HOLDEN RODEO**



Rodeo TFR  
Turbo Diesel  
6/94 on  
**TPP 6020045**

**HOLDEN ISUZU**



Trooper 97-91  
Bighorn  
Jackaroo  
4JB1 4JG2  
Diesel  
**TPP 8-97129-593-0**

**HOLDEN VECTRA**



4cyl  
**GM09004N**

**HOLDEN VIVA**



JF 1.8  
10/05-04/09  
**NO PART NUMBER**

**HONDA ACCORD**



Accord 2.2 94-97  
Odyssey 95-97  
**TPP A1215907**

**HONDA ACCORD**



2.3 4cyl & V6  
1998-2002  
**TPP A1215919**

**HONDA ACCORD**



Accord 2.4 03-07  
CRV 03-04 /2.4 05-12  
Euro V6 & 4CYL  
(all engines)  
**TPP A1215348**

**HONDA ACCORD**

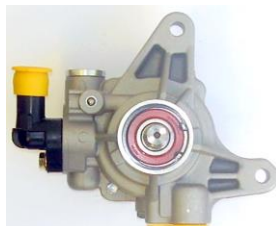

Accord 2.4  
2003 to 2005  
**TPP 21-5341**

**HONDA ACCORD**



Accord 2.4  
2008-2011  
**TPP 56110-R40-A01**

**HONDA ACCORD**



CM4 CM5 2.0 2.4  
03-05  
Sedan & Coupe  
03-07  
**TPP 56110-RCA-A02**

**HONDA ACCORD**



CM5 CM6 V6

2003-2007

TPP 56110-RCA-A01

**HONDA ACCORD**

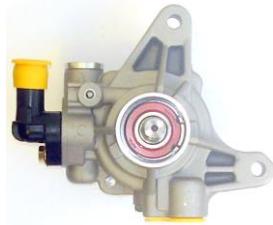

Euro 2.4

2002-08

TPP 121-5341

**HONDA ACCORD**

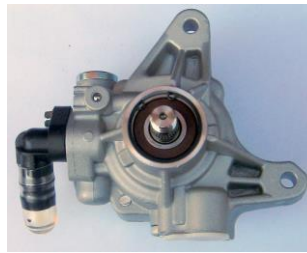

2.4

Accord VII 1/04 to 5/08

CRV II & III 2/05 to 08

Acura RSX20/TSX 02 on

56110-S9A

**HONDA ACCORD**

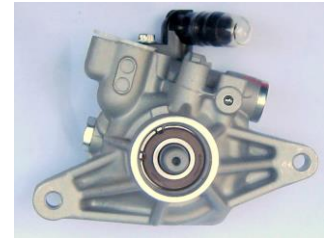

Accord 3.0 V6

2003-2007

Civic 1.8

2006-2011;

TPP 21-5267

56110-RNA-A02

**HONDA ACCORD**



Accord V6

Odyssey 2005-2010

MDX

TPP A1215442

**HONDA CIVIC**



Civic 1.7

Acura EL 1.7

2001-2005

TPP 56110-PLA-013

**HONDA ODYSSEY**



1999 to 2004

TPP 21-5268

**HONDA ODYSSEY**



Odyssey 4cyl

2005 to 2007

TPP 56110-RFE-013

**HYUNDAI ACCENT**



Accent 1.3

to 2006

TPP 57110-25000

**HYUNDAI ACCENT**



2006 to 2009

TPP 57100-1G000

**HYUNDAI ELANTRA**



Elantra 2.0 01-06

Tiburon 03-08

TPP 57100-2D101

**HYUNDAI ELANTRA**



Elantra 2002 to 05

Lantra 6/95 to 10/00

TPP A1215261

**HYUNDAI EXCEL**



Excel 1.3 Pony 1.3

1989-84

TPP 7M0145157SX

**HYUNDAI SANTA FE**



FE 2.4

2001 to 2006

TPP 57100-26200

**HYUNDAI SANTA FE**



V6 2.7 01-06

Sonata V6 2.7 02-05

TPP 21-5253

**HYUNDAI SANTA FE**



FE V6 3.2

2003 to 2006

TPP21-5354

**HYUNDAI  
SONATA**

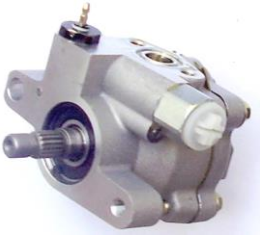

Sonata 2.4  
2000 to 05  
**TPP 21-5257**

**HYUNDAI  
SONATA**

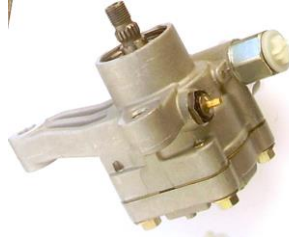

V6 3.3  
2007-2010  
**TPP215471**

**HYUNDAI  
TERRACAN**



2002 to 2006  
**TPP 57110-H1501**

**HYUNDAI  
TIBURON**



V6 2.7  
2003 to 2008  
**TPP 215423**

**HYUNDAI TUCSON**



V6 2.7  
(Kia Sportage V6)  
2005-2010  
**TPP 215449**

**HYUNDAI TUCSON**



2.0 2.7  
2005-2009  
(Kia Sportage 2.7)  
2005-2010  
**TPP 57100-2E000**

**HYUNDAI  
I-LOAD**



I-Load 2008  
Turbo  
Petrol & Diesel  
**TPP57100-4H000/200**

**HYUNDAI  
GRAND STAREX**



2015-2017  
**TPP571004H200**

**JEEP CHEROKEE**



2.1Tdi 1984-2014  
4.0i 1988-2014  
2.5 1995-2014  
**TPP 26076557**

**JEEP CHEROKEE**



XJ 2.5i 1997 to 2000  
TJ 2.5i 1997 to 2002  
**TPP J8203**

**JEEP CHEROKEE**



XJ SE 4.0  
1991 to 1995  
**TPP J8201**

**JEEP CHEROKEE**



XJ  
Grand Cherokee ZJ  
4.0 4.7 5.2 V8 1993 -  
**TPP CF-20-38771**

**JEEP GRAND  
CHEROKEE**



4.7 V8  
2001 to 2004  
**TPP 20-62608**

**JEEP CHEROKEE**



1XJ 1991-1996  
Grand Cherokee  
1ZJ 1993-1998  
4.0i L6 Petrol  
**TPP 53007383**

**JEEP GRAND  
CHEROKEE**



Grand Cherokee II WJ WG  
4.7 V8 8/00- 4x4 6/03-  
Lorado  
**TPP 216-C27003**

**JEEP LIBERTY  
RENEGADE**



3.7 V6  
2004-2006  
**TPP 52088710AE**



**JEEP WRANGLER**



**JK 3.8**

**2007 to 2011**

**TPP52059899AE**

**JEEP WRANGLER**



**4.0 1997-2006**

**Cherokee 1996-2001**

**TPP 52087871AB**

**JEEP WRANGLER**



**JK 3.6**

**2012 to 2015**

**TPP 5154400AC**

**KIA PREGIO**



**2.7D**

**(TB) 1997-2015**

**TPP-0K72A-32-600B**

**KIA OPTIMA**



**Optima/ Magentis**

**2006 to 2010**

**Rondo**

**2006 to 2011**

**TPP57100-2G000**

**KIA OPTIMA**



**Optima L4 2.4 2001 to 2006**

**Sonata 2.4 2000 to 2005**

**TPP 21-5257**

**KIA RIO**



**1.6**

**2005 to 2011**

**TPP 57100-1G000**

**KIA SEDONA**

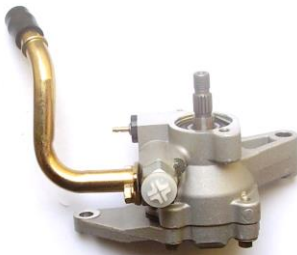

**2002 to 2005**

**TPP21-5354**

**KIA SORENTO**



**V6 3.5**

**2003 to 2006**

**TPP21-5354**

**KIA SPORTAGE**



**2.7 2005 to 2010**

**(Hyundai Tucson 2.0 2.7)**

**2005-2009**

**TPP 57100-2E000**

**KIA SPORTAGE**



**V6 2005 to 2010**

**(Hyundai Tucson V6 2.7)**

**TPP 215449**

**LANDROVER  
DISCOVERY 1**



**Discovery 1994 to 1998**

**Defender 1990 to 2001**

**Range Rover Classic (soft dash)**

**(All 300TDi 2.5 TDi Engine only)**

**TPP ANR2157**

**LANDROVER  
DISCOVERY 2**



**Discovery 2 TD5**

**TPP QVB101240**

**LANDROVER  
DISCOVERY 2**



**Discovery 2 V8**

**TPP LA001**

**LANDROVER  
DISCOVERY 3**



Range Rover Sport  
2.7 V6 Diesel  
TPP QVB 500660

**LANDROVER  
FREELANDER**



1.8i 16v 1998 to 2006  
2.5 V6  
TPP QVB101462L

**LANDROVER  
FREELANDER 2**



2008-2012  
TPP LR7028

**RANGE ROVER**



L322 3.0 TD  
2002-2009;  
Also BMW 3.0Td  
QVB 000230

**RANGE ROVER**



L322 HSE  
4.2 4.4  
2002 -2012  
QVB500430

**RANGE ROVER**



Mk3 L322 3.0 TD  
03-2002 to 8-2012  
Also BMW E38 E39  
E46 E53 E60 E61  
E65 E83 3.0Td  
QVB 000230

**RANGE ROVER**



Vogue  
3.6 TD V8  
2002 to 2012  
TPP QVB 500630

**LEXUS RX300**



MVC30 MCU35  
2003 to 2009  
TPP 44310-08010

**LEXUS IS300**



IS 300  
2001 to 2005  
TPP 215259

**LEXUS LS400**



Lexus LS400  
1990 to 1997  
TPP 44320-50020

**LEXUS LX470**



Lexus LX470  
1998 to 2007  
Landcruiser UZJ100 V8  
TPP 44320 60320

**LEXUS LX470**



LX470 V8 4.7  
Also Landcruiser  
TPP 215402

**MAZDA 3 / 5**



Mazda 3 2.0 2.3 2.5 2004-12  
Mazda 5 2.3 2.5 2006-12  
BBM4-Z32-68Z

**MAZDA 6**



Mazda 6  
TPP M8241

**MAZDA TRIBUTE**



V6  
Also Ford Maverick  
TPP 1784



## MERCEDES ML



320 98-03, 350 03-05,  
430 99-01, 500 02-05,  
55, AMG 00-03  
TPP 00346666401

## MERCEDES ML



ML320 (98-03)  
ML350/500 (03-05)  
ML430 (99-01)  
ML55 AMG (00-03)  
TPP ME002

## MERCEDES C CLASS



W204  
C180/200/220/250  
Diesel  
TPP006466150

## MERCEDES C CLASS



C220 C250  
TPP 2466109

## MERCEDES C CLASS

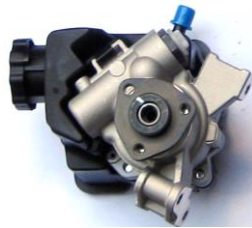

C Class (W203);  
Coupe (CL203)  
E Class (W211);  
T-Model (S211) 02-09  
TPP0024667401

## MERCEDES C/E CLASS



C-Class Coupe 06/11  
C-Class Saloon 01/07-01/14  
C-Class T 08/07-08/14  
E-Class Convertible 01/2010  
E-Class Coupe 01/2009  
A0064666801

## MERCEDES C SLK



C220 C230 SLK230  
1996-2004  
TPP24663901

## MERCEDES C



C230 1.8 4cyl 16V  
2003 to 2005  
TPP 34664001

## MERCEDES C CLK SLK



C180 C220 SLK200  
CLK200 Incl Convertible  
TPP ME09008N

## MERCEDES CLS



SLK55  
CLS 500 55AMG  
E240 320 500 55AMG;  
TPP0044661401

## MERCEDES R ML E



R500 ML350 ML500  
E550 E350 2006-2007  
3.5V6 5.0 5.5 V8  
TPP 44667601

## MERCEDES GL ML R



GL320 CDI ML280 CDI  
ML320 CDI R280 R320  
S320CDI S350 CDI  
7/2005 -  
TPP 0064663101

## MERCEDES GL R



V6 3.0DT  
GL320/350 R320/350  
CDi & Bluetec 4Matic  
2008-2013  
TPP 0064663101

## MERCEDES C ML VITO



Vito V6 2005 on  
C240 ML320 ML350  
ML55 AMG  
TPP ME09009N

## MERCEDES C/E CLASS



C180/C200 C230  
C280/36AMG  
E280/E320  
E280T/E320T  
TPP24662901

**MERCEDES VITO**



108 2.3D  
1997-2003

**TPP0024664901**

**MERCEDES VITO SPRINTER**



Sprinter CDI 03/1999 on  
Vito 9/2010 on  
0064665201

**TPP CF-24-66-9001**

**MERCEDES SPRINTER**



210D 312D  
1995-2006

**TPP7691955910**

**MERCEDES VITO VIANO SPRINTER**



Sprinter 906 3,5-t  
Vito CDI 2.2 2.1 3/09-16  
Viano CDI 2.0 7/2010 on

**TPP0064667801**

**MITSUBISHI CANTER**



4M51

**TPP MK383005**

**MITSUBISHI TRITON**



MN L200 2.5  
KB4 4D56 2005 on

**TPP 4450A173**

**MITSUBISHI TRITON**



MK L200  
KA5T KB5T 4G64  
2008-2010

**TPP MR992871**

**MITSUBISHI TRITON**



ML 2.4 4cyl 4G64  
7/2006 to 7/2009

**TPP MR995025**

**MITSUBISHI TRITON**



Triton L200  
4M40 K67 K77

**TPP MR374895**

**MITSUBISHI TRITON**



ML  
V6 Petrol  
2008 on

**TPP**

**MITSUBISHI TRITON**



L200  
B40 KA4T KB4T

**TPP MR995027**

**MITSUBISHI TRITON**

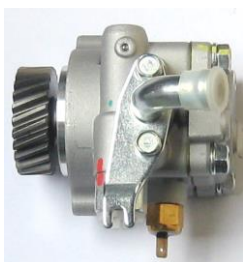

L200 4M41  
Pajero/Shogun IV 3.2 Di-D  
2007-2017

**MR992873**

**MITSUBISHI TRITON PAJERO**



2.4 Petrol  
2/03 to 3/06

**TPP CF409009**

**MITSUBISHI PAJERO**



Shogun III Off Road  
Cabrio 3.2 Di-D  
04/2000 to 12/2006

**TPP MR223480**

**MITSUBISHI OUTLANDER 1**



Petrol incl Turbo 2003-06  
Outlander 2 Diesel 2006 on

**TPP4450A107**



**NISSAN  
ALTIMA**



Altima 02-06  
Maxima 04-08  
Quest 3.5 V6 04-09  
**TPP 49110-7Y000**

**NISSAN  
D21**

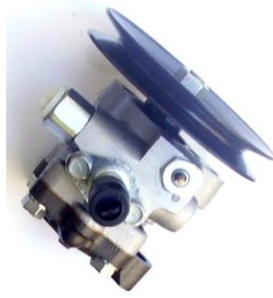

**TPP 4100002**

**NISSAN  
D22**

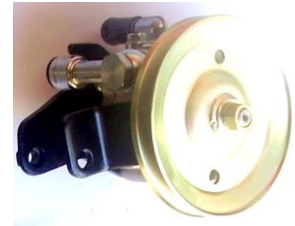

2.5 1997-2001  
2.5 TD 4x4 1997 on  
**TPPXD-N008**  
**49110-2S600**

**NISSAN  
D22 D23**



**TPP 5100002**

**NISSAN  
PATROL**



GR Off Road  
Y61 5/2000 on  
**TPP 49110VC100**

**NISSAN  
PATROL**



Y61  
TD48  
**TPP 49110-VS40A**

**NISSAN  
PATROL**



Y61 GU  
Eng: TB42-45-48  
1997-2001  
**49110VB100NG**

**NISSAN FRONTIER  
PATHFINDER**



Frontier 4.0 V6  
Pathfinder 2005-2011  
Murano 2007; Xterra  
Suzuki Equator 2009-2010  
**TPP 215451**

**NISSAN FRONTIER  
PATHFINDER**



2.4 1987- 1988  
D21 2.4 1987 - 1994,  
Pick Up 1995 - 1997  
240SX 1989 - 1990  
**TPP 215728**

**NISSAN  
PATHFINDER**

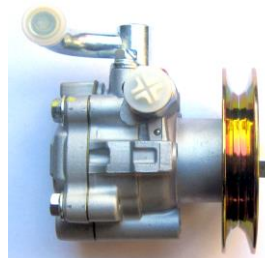

LE SE XE 6cyl 3.3  
1996-2003  
**49110-0W000**

**NISSAN  
PATHFINDER**



QX4 3.3 V6  
1996 to 2000;  
Y60 4.2 Diesel  
**TPP 215028**

**NISSAN  
NAVARA D40**



YD25 NP300  
2010-2018  
**TPP 49110-EB300**

**NISSAN  
X-TRAIL**



R25  
**TPP 491108**

**ROVER**



Rover 75 1999-2005  
MG ZT 2.0 2.5 Petrol  
**TPP QVB101411E**

**PEUGEOT**

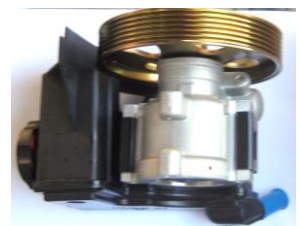

206 1.1 1.4 1.6 2.0  
Incl Partner  
Citroen Berlingo/Xsara  
**TPP 4007.V5**



**PEUGEOT**



306 1.4  
Xsara  
TPP 9634070580

**PEUGEOT**



405 1.9D incl Turbo  
1988-92  
TPP 4007.Q4

**SAAB AERO**



9-2X 2.0  
Aero 05-06  
34430FE041

**SAAB 900**



900 1985-1993  
900 Convertible 1994  
TPP 9101585

**SAAB 9000**



9000  
2.0 2.3 3.0  
TPP 8963993

**SKODA OCTAVIA I**



Hatch & Wagon 1.6, 1.8, 1.8T,  
1.9Tdi  
9/96-12/10  
TPP 1JO 422 154 C

**SKODA SUPERB**



2.8 V6  
12/01-3/08  
TPP 8D0 145 156F

**SUBARU FORESTER**



2.5 2009-2010  
Impreza 2.5 2008-2011,  
WRX 2009-2010  
STi 2010-2011  
34430FG0109L

**SUBARU IMPREZA**



WRX  
WRX STi  
2004-2007  
34430FE041

**SUBARU IMPREZA**



WRX  
2005 on  
TPP A-1215396

**SUBARU IMPREZA**



1997-1998  
Liberty 1997-1999  
Outback 2.2 1996 -  
TPP A1215990NEW

**SUBARU IMPREZA**



Impreza/Liberty  
1996-1998  
Outback 2.2  
1996  
TPP A1215932

**SUBARU IMPREZA**

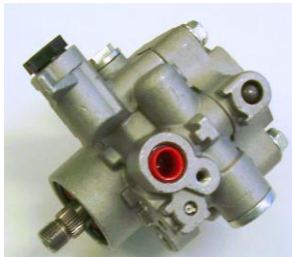

Impreza 2012-14  
Liberty 2005-06 & 2009;  
TPP A1215196

**SUBARU IMPREZA**



2003-2004  
Forester 2003-2007  
Outback E2-30 7/2006-  
Liberty  
Specify Pulley Diameter  
& Groove Count (5 or 6)  
TPP A125444

**SUBARU IMPREZA**

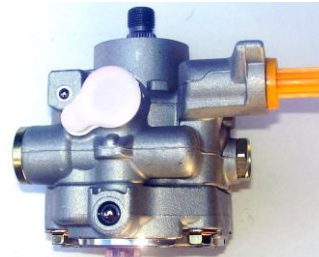

2011-2013  
Liberty 2003-2009  
Outback 2005-2006;  
Forester 2.5 2005-2012  
34430-AG050

**SUBARU OUTBACK**



3.0 &  
Liberty SU-006  
2001-2004  
34430-AE083  
TPP A1215254

**SUBARU FORESTER**



1998

Incl Turbo

TPP A1215205

**SUBARU FORESTER**

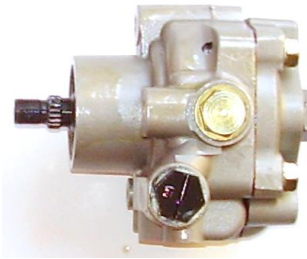

1999-2001

TPP A1215139

**SUZUKI EQUATOR**



2009-2010

TPP 215451

**TOYOTA CAMRY**



Camry 2.4

2002-2010

TPP 21-5254

**TOYOTA CAMRY**



2.2 SXV20 55-FE Engine  
1997-2001

Soarer/Lexus 6cy

1994

TPP 44320-33100

**TOYOTA CAMRY**

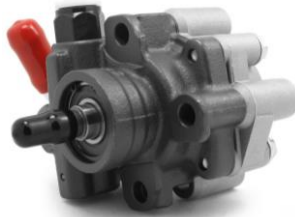

3.0 1995-2006

Kluger 3.3 2004-2007

Lexus RX330 2005-

2006

TPP A1215931

**TOYOTA CAMRY**



3.0 3.3 6Cyl

1MZFE 3MZFE

MCV30 MCV31

2002-2006

TPP 4432033150

**TOYOTA CAMRY**



3.5 2007-2010

Avalon 2005-2010

TPP121447

**TOYOTA CAMRY**



MVC10

1993-1994

LEXUS RX300/330/350

TPP44320-33080

**TOYOTA COROLLA**



Corolla 1.6

1988-1998

TPP 21-5345

44320-02031

**TOYOTA COROLLA**



Corolla 1998 to 2002

TPP 21-5168

44320-02034

**TOYOTA COROLLA**



Corolla ZZ122 1ZZ

2001-2007

TPP 21-5345

**TOYOTA HIACE**



2.4 2.8 3.0

(3 Bolt Holes all same size)

TPP 44320-26070

**TOYOTA HIACE BUS**

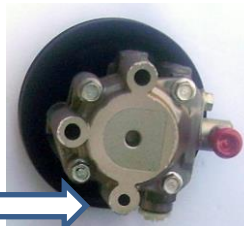

RZH104/105

(3 Bolt Holes one smaller)

TPP 44320-26063

**TOYOTA HIACE**



HiAce 3.0 LH101

HiLux 3.0 LN167

1988-1997

4Runner 2.4 2.8

TDI 10/1989-06/1996

(2 Bolt Holes)

TPP 44320-26073



**TOYOTA HILUX**



HiLux  
4 Runner  
3.4 Petrol  
1996-04  
**TPP A1215229NEW**

**TOYOTA HILUX**



LN58/65/85/86/106/107/111  
1983-1991  
Dyna 150 1997-2000  
2.8 3.0 Diesel  
(Spline)  
**TPP 1338**

**TOYOTA HILUX**

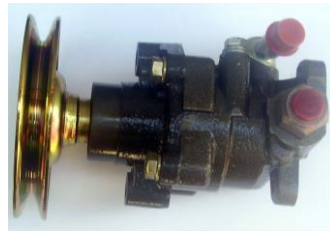

2WD & 4WD Petrol  
YN65 YN85 YN106 RN85  
RN90 RN105 RN10 RN110  
4 Runner Petrol 1989  
2.4 TDi 1990 on  
**TPP 1337**

**TOYOTA HILUX**



2.4 Petrol 2WD 4WD  
YN57/58/85/106  
RN85/90/105/110/LN86  
2.8 Diesel LN106-107  
1983-9/97 (Keyway)  
**TPP 1466**

**TOYOTA HILUX**



2.4i Petrol 4cyl 4x4  
LN/KDN/RZN 145->174  
RZN168  
1997-2005  
**TPP 44320-35560**

**TOYOTA HILUX**



2.7 Petrol  
Hi Ace GGN  
01/ 2005 on  
**TPP 1848N**

**TOYOTA HILUX**



HiLux KUN26R;  
HiAce KDH201 2007;  
Prado 95 3.0 Diesel Turbo  
**TPP 1218N**  
**OEM 44310-26380**

**TOYOTA HILUX**



1996 to 2001  
4 Runner  
**TPP A1215228**

**TOYOTA HILUX**



2.8 D22R FJ80  
(Keyway)  
**TPP 44320-14111**

**TOYOTA LANDCRUISER**



Lexus LX470  
V8 4.7  
**TPP 215402**

**TOYOTA LANDCRUISER**



100 Series  
1975-1980  
HZJ105 Series  
Diesel  
**TPP 1501N**

**TOYOTA LANDCRUISER**



FZJ105  
6 cyl Petrol  
**TPP 1415**

**TOYOTA LANDCRUISER**

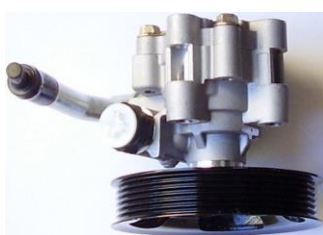

GRJ200 6 cyl Petrol  
2008 to 2016  
**TPP 44310-60470**

**TOYOTA LANDCRUISER**



HDJ100 Turbo Diesel  
VZJ100 V8 VDJ200 V8  
1-HD-FTE engine to 2002  
**TPP 44310-60420**

**TOYOTA LANDCRUISER**



HDTE 4.2  
HDJ100R Diesel Turbo  
8/2000 on  
**TPP 44310-60410**

**TOYOTA LANDCRUISER**



HJ60/61/75 BJ73 BZ  
HiLux 8/88-12/97  
4 Runner 89-95  
2.4 2.8 Diesel  
**TPP 1373**



**TOYOTA  
LANDCRUISER**



**UZJ100**  
Crown 3.0 JZS133 91-01  
**44320-30440**

**TOYOTA  
LANDCRUISER**



**4700 UZJ100 V8**  
Lexus LX470  
**TPP 44320-60320**

**TOYOTA  
LANDCRUISER**



**3FE-FJ80 Petrol**  
1991 to 1993  
**TPP 1445**

**TOYOTA  
LANDCRUISER**



**FJ Cruiser 4000 2006-09**  
4Runner 2003-2009  
Tundra 4.0GR 2005-2006  
**TPP 44310-35660**

**TOYOTA  
LANDCRUISER 70**



**VDJ76 78 79 4.5TD**  
GRG76 78 79 4.0 V6  
Petrol 03/07- 01/19  
**44310-60460**

**TOYOTA  
LANDCRUISER**



**V8**  
Petrol  
**TPP 44320070110**

**TOYOTA  
PRADO**



**VZJ95 Series**  
Petrol  
**TPP 4432060270**

**TOYOTA  
PRADO**



**KZJ95R/120/150**  
3.0 Diesel Turbo  
10/00-3/03  
**TPP 1218**

**TOYOTA  
PRADO**



**120 Series**  
Petrol  
**TPP T660**

**TOYOTA  
PRADO**



**150 Series**  
GRJ KDJ TRJ  
Petrol  
**TPP 44310-60551**

**TOYOTA  
4 RUNNER**



**3.4 V6 Petrol**  
SR5 Sport 4 Door  
**TPP 44320-35490**

**TOYOTA  
RAV 4**



**ACA-20 ACA-21R**  
2001-2005  
All Engines  
**TPP A2125276NEW**

**VW GOLF 17 & II**



**Golf 17 & II 1979-1991**  
Jetta 1978-1992  
Passat 1988-1977  
Skoda Octavia 1996-2010  
**TPP 27145157N**

**VW GOLF III**

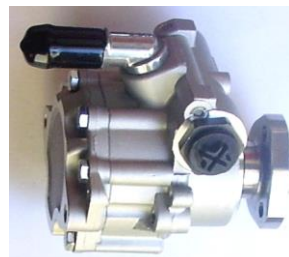

**Golf III/Passat 1.8**  
Golf III/Passat 1.9TDi  
2.8 VR6 Golf III/ Vento  
Caddy II 1.9D  
**TPP XD-So21**

**VW GOLF III**



**Golf III 2.8VRS,**  
2.9 VRS incl Syncro  
Passat B5 11/000-5/05  
Skoda Superb 02-08  
**TPP 8D0 145 156F**

**VW GOLF IV**



**1.6, 1.9tdi 2.5V5**  
1997-06;  
Jetta IV  
1998-2005;  
Beetle 1.4 1.6 1.8T 1.9tdi  
**TPP 1J0 422 154C**

## VW TRANSPORTER



1.6 1.8 incl syncro 1.9td  
GTi 165v 2.6 16v 4motion  
1991-2006

Passat 1.8 incl syncro,  
2.0 1.9td 1988-1997

Vento

1.6, 1.8, 2.0, 1.9D/TDi/SDi

1991-1998

Ford Galaxy

1.9TDi, 2.0i, 2.3 16v  
1995-2006

Hyundai Pony/Excel 1.3  
1989-1984

**7M0145157SX**

## VW TRANSPORTER



T28 2.0 TDi  
2009-2015

Amorak

**TPP 7E0422154E**

## VW CRAFTER 30-35

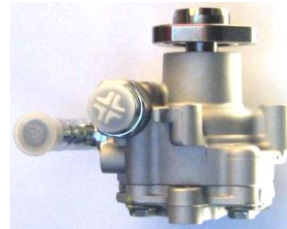

2.0TDI 2.5 TDi  
2006-2016

Transporter T5  
4/03 on

**TPP 2E0422155A**

## VW TRANSPORTER



Transporter  
2003-2009

7HA 7HH 7EA 7EH

MPV 2.5 Tdi

**TPP 7H0 422 153A**

## VW TRANSPORTER



T5 & Multivan  
4/03-11/09

Toureg 10/02-5/10

Audi Q7

**TPP 7L6422154**

## VW TRANSPORTER



Transporter T5

2004 -

(Long Neck)

Caddy 1.6 Petrol 2008

**TPP 7H0422154F**

## VW TRANSPORTER



Transporter T4

1992 -

(Short Neck)

**TPP 028145157F**

## VW TRANSPORTER



Transporter T4

1990 to 4/2003

**TPP 044145157A**

## VW BORA



Bora 10/98 to 2/02

Golf IV & Wagon 8/97-6/05

Beetle 1/98 to 10/10

Passat B5 11/00 to 5/05

Skoda Octavia 9/96 to 5/05

**TPP 038145157**

## VOLVO 850/960



960 2.9/2.5 MK I/II  
850 2.5Tdi

(all incl wagon)

**TPP 9457904**

## VOLVO XC90



XC90 V8

2005 on

**TPP 30741375**

## VOLVO XC90/V70



XC90 S60 S80 V70  
2.5 5cyl

2.9i 6cyl incl turbo  
2005 to 2007

**TPP 30665098**

## VOLVO XC90/V70



XC90 2.5 + T6  
S60 V70 II

(With Thread)

2002 to 2014

**TPP 7617 955 141**

## VOLVO S80



S80

2000 to 2006

**TPP VOX1 974001**

## VOLVO S80



S80 2.5 3.0

2001 to 2006

**TPP VOX1 974003**

# NEW POWER STEERING RACKS

New Racks Built To OEM Quality

1 YEAR WARRANTY

PHONE JOE FOR THESE & OTHER RACKS

## HILUX KUN26 4x4

Part No: TPR11502NEW

## HILUX KUN16 2WD

Part No: TPR11501NEW



## HIACE VAN 3Y/4Y

Short Wheel Base

Part No: TPRTYKDH223VAN



## HIACE VAN 3Y/4Y

Long Wheel Base KDH200

Commuter Bus

Part No: TPRTYKDH223NEW



## LANDCRUISER FZJ

100 SERIES DIESEL

EARLY 1/98-7/02

Part No: TPRTY100NEW



## LANDCRUISER HDJ/UZJ

100 SERIES DIESEL

LATE 10/02 ON

Part No: TPRTY105NEW



## LANDCRUISER

200 SERIES

Part No: TPRTY200NEW



## PRADO KZJ

95 SERIES

Part No: TPR11153NEW



## PRADO RZJ 120 SERIES

Part No: TPR120PRADO

OEM:44250-35051







**HOLDEN**  
**Commodore**  
**VE & VZ**



**MERCEDES**  
**Sprinter**  
**2006 on**



**MITSUBISHI TRITON**  
**2WD & 4X4**  
**6/5006 on**  
**Part No: TPRTRITON**



**NISSAN NAVARA**  
**D40**  
**Part No: TPRND40**



**NISSAN X-TRAIL**  
**T30**



**NISSAN X-TRAIL**  
**T31**

**Holden VT VX VY (TPR11150N)**  
**Hyundai Getz 1.6 Toyota Camry SXV20-MCV20**  
**BMW & Mercedes Arriving Soon**



Standard boot TE-555-10 \$16.00  
 4x4 Large Boot TE-666-10 \$17.00  
 PRICES PER BOOT  
 Sold In Boxes Of Ten

## THE SMART BOOT FOR THE SMART MECHANIC

Australia's most popular stretch boot.

Reduces fitting time by half

**2 Boot Sizes Fit 100% Of Vehicles**

5 Year/100,000 km Warranty on Sedans

3 Year/60,000 km Warranty on 4x4

**Economy Stretch CV Boots - Great Quality - Great Price**  
**Box Of 10 \$110.00 TE-555-10A**

**All These Stretch Boots  
 Suitable For Use With UK-  
 Made Duragun**  
**Our Innovative Time-Saving Device  
 For Stretching CV Boots Over  
 CV Joints Without Dismantling**

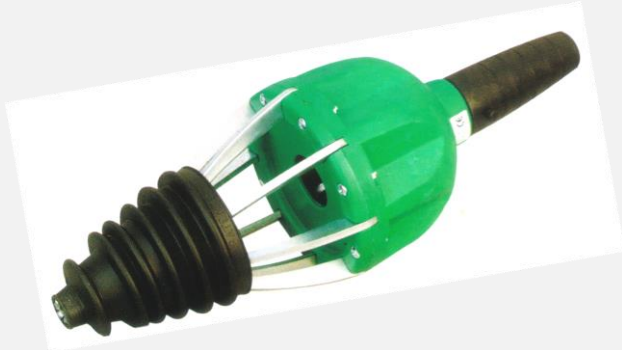

- REDUCES FITTING TIME TO APPROX 30 MINUTES
- STANDARD AIR-LINE FITTING, WORKING PRESSURE 4 TO 8 BAR
- SUPPLIED READY ASSEMBLED, READY FOR USE
- USE WITH EITHER BOGE OR UNIVERSAL STRETCH BOOTS
- INNER JOINT – SIMPLY TURN BOOT INSIDE OUT
- FOR JOINTS UP TO 115 MM
- DESIGNED FOR SINGLE-HAND OPERATION
- ONE MODEL COVERS ALL VEHICLES
- WEIGHT ONLY 2 KG

**ENQUIRE ABOUT OUR GREAT  
 BOOT/GUN DEALS**



## Universal Stretch Rack Boots

**Boxes Of Ten**

**\$110.00**

## Terrific New Products From

# BAILCAST

The UK's Most Innovative Maker of CV Equipment

Imported From UK



Bailcast's New Range Of  
Ball Joint & Tie Rod Boots

Sold In Pairs:

**Small Medium**  
**Large Extra Large**

**\*EXCLUSIVE TO TURNERS\***



SELECTION BOX OF 20 BOOTS & FITTING TOOL  
SPECIAL INTRODUCTORY OFFER

**\$49.00**

## STICKYBOOT

**The Tongue & Groove Split Boot  
For When the Going Gets Awkward  
... or just plain easy**



**NO DISMANTLING!**  
Stickyboot can also be  
fitted to trilobal/tripod  
joints.

Part Number: CVS18

**KIT CONTAINS:**

Stickyboot CV boot,  
stainless steel clamps,  
rubber adhesive, latex  
gloves, 60g grease,  
instructions.

**\$25.00 each**

Buy 4 or more:

**\$23.00 each**

Buy Box of Ten:

**Get one free**

**The Brilliant Time And  
Labour Saving  
AIR POWERED  
DURAGUN**



**Special  
DURAGUN**

**Plus Box Of 10 Quality Stretch  
CV Boots**

**Only \$299.00**













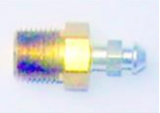





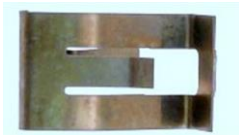

# AUSTRALIAN MARKET BRAKE PART ASSORTMENTS IN TWO STURDY PARTITIONED BOXES

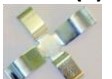
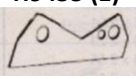
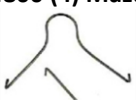

## DRUM BRAKE ASSORTMENT - Part No: H 1263      \$125 + gst

|   |   |  |  |   |
|---|---|--|--|---|
| <p>H 1132 (25)</p>  <p>H 4755 (10)</p>  | <p>H 1175 (10)</p>  <p>H 1177 (20)</p>  | <p>H 1135 (25)</p>    | <p>H 9400 (5)</p>  <p>ATAP 9405 (5)</p>          | <p>H 9411 (5)</p>                                |
| <p>H 1457 (4)</p>    | <p>H 9450 (20)</p>   | <p>H 1162 (10)</p>    | <p>H9452 (8) H9453 (6)</p>  <p>H 9445 (2)</p>  | <p>H 1150 - Long (4)<br/>H 1150 - Short (4)</p>  |
| <p>H 1103 (10)</p>    | <p>H 1106 (10)</p>   | <p>H 1108 (10)</p>  | <p>H 1109 (10)</p>   | <p>H 1107 (10)</p>                             |

## DISC BRAKE ASSORTMENT - Part No: H 1264      \$105 + gst

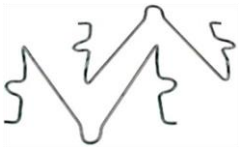
|  |  |   |  |  |
|--|--|---|--|--|
| <p>H5282 (4)</p>  <p>Laser/Mazda</p>  | <p>H4869 (4)</p>  <p>Honda/Mazda<br/>Toyota</p> | <p>H4887 (4)</p>  <p>Honda/Datsun</p>          | <p>H4881 (4)</p>  <p>Toyota</p>   | <p>H4810 (2)<br/>H4811 (2)</p>  <p>Toyota</p> |
| <p>H13296</p>   | <p>H4744 (4)</p>                                | <p>H4749 (4)</p>  <p>Toyota</p>                | <p>H4878 (4)</p>  <p>Honda/Colt/Toyota</p>                                | <p>H4636 (4)</p>  <p>Volvo</p>                |
| <p>H4866 (2)</p>  <p>H9455 (1)</p>  <p>H4800 (4) Mazda</p>  | <p>H4749 (4)</p>  <p>Toyota</p>                 | <p>H4916 (4)</p>  <p>Honda/Colt<br/>Toyota</p> | <p>H4797 Long (2)<br/>Datsun</p>  <p>H4764 Short (4)<br/>Datsun/Nissan</p> | <p>H4906 (4)</p>  <p>Ford/Isuzu</p>           |

# Slip-N-Grip Vehicle Interior Protection



Part No: PSC250C

## SEAT PROTECTORS

**TWO-LAYER  
CONSTRUCTION  
ENSURES COVER  
STAYS IN PLACE  
STANDARDISED DESIGN  
PROTECTS BUCKET,  
BENCH AND  
SPLIT SEATS**

**Pack of 250  
\$88.00 + gst**

## STEERING WHEEL COVERS



**EASY TO APPLY  
ELASTIC DESIGN**

**Pack of 250  
\$69.23 + gst  
Part No: PSWC500**

## PLASTIC FLOOR MATS



**TWO-LAYER CONSTRUCTION  
ENSURES MAT STAYS IN PLACE  
IMPERVIOUS TO WATER, OIL,  
GREASE AND MOST**

**SHOP CHEMICALS**

**Pack of 500 \$88.00 + gst**

Part No: PFM500



Part No: PKTAG



## PLASTIC KEY TAGS

**SELF-LOCKING  
HOLDS KEYS SECURE  
PERFECT FOR  
QUICK TAGGING**

**Pack of 1000  
\$45.00 + gst**

**SPECIFY  
RED BLUE  
WHITE YELLOW**

**ASK ABOUT OUR  
GREAT FIRST-TIME  
BUYER OFFER**

# WHY PAY MORE FOR RADIATORS

ASK FOR CATALOGUE - OVER 700 PART NUMBERS

**HUGE  
RANGE  
24 MONTHS  
WARRANTY**

MENTION THESE SPECIAL  
PRICES WHEN ORDERING  
\*Prices Include GST\*



**CONDENSERS TOO!!**

**CALL JOE**



**FOR  
GREAT  
DEALS!**

**GRAB THESE SPECIALS UNTIL END OF 2020**

|             |   |           |
|-------------|---|-----------|
| RBM27022    | BMW E39                                       | \$ 220.00 |
| RDW42015    | Daewoo Nubira 1997 on                         | \$ 135.00 |
| RFD16011    | Ford Courier / Bravo 1996 on                  | \$ 183.25 |
| RFD16041    | Ford Courier / Bravo 1989-95                  | \$ 167.50 |
| RFD16016-26 | Ford Falcon BA                                | \$ 150.00 |
| RFD16046    | Ford Falcon XG                                | \$ 167.50 |
| RFD16014    | Ford Falcon EL-EF V6 8/94-8/98                | \$150.00  |
| RFD16015    | Ford Falcon AU II 6cyl 9/98-9/02              | \$ 140.00 |
| RFD16021    | Ford Laser KF KH, Mazda 323                   | \$ 158.75 |
| RHD22023    | Holden Commodore VT to VX                     | \$ 150.00 |
| RHD22035    | Holden Commodore VT VX 5.7 V8 Gen III         | \$ 165.75 |
| RHD22021A   | Holden Commodore VY V6                        | \$ 150.00 |
| RHD22039    | Holden Rodeo RA Petrol 2002 on                | \$ 220.00 |
| RHD22044B   | Holden Vectra ZC                              | \$ 183.25 |
| RHO17022-16 | Honda CRV 1994-01                             | \$ 167.50 |
| RKI29014    | Kia Sportage 1996-03                          | \$ 165.75 |
| RNI19018-26 | Nissan D21 Navara Petrol                      | \$ 167.50 |
| SAA 7940    | SAAB 4cyl 9-5                                 | \$ 270.75 |
| RSB14019    | Subaru Forester 2002 on                       | \$ 176.25 |
| RSB1645     | Subaru Impreza 1992-02 & Forester (not turbo) | \$ 183.25 |
| RTY18024    | Toyota Corolla AE92                           | \$ 150.00 |
| RTY18035    | Toyota HiAce Diesel                           | \$ 253.25 |
|             | Toyota Landcruiser 80 Series Petrol           | \$ 270.00 |

**Receive \$100 Voucher From Turners for Steering Racks & Pumps  
CV Shafts & Tools When You Order Your First Radiator**



# GENUINE LUK CLUTCH KITS

Exedy / DCT / DSG Dual Mass Flywheels

COMPETITIVE PRICES  
RING JOE FOR QUOTE



**AVAILABLE NOW**

OEM Dual Mass Flywheels (DMF)  
to suit a range of vehicles with  
wet or dry dual clutch transmissions

Should there be any doubt as to the serviceability of  
the DMF during the replacement of dual clutch assemblies  
the manufacturer recommends that the DMF be replaced.

*NOTE:*

*Due to the varied differences between DMF units fitted to  
similar vehicles the VIN number is essential to  
ensure the correct part is supplied.*

# We Sell These Famous Products At Very Competitive Prices

## SHOCKS & STRUTS

Monroe

KYB

Gabriel

Sachs



## G-Torque Gaskets & VRS Kits

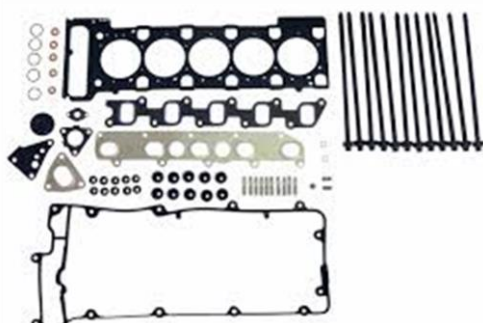

# AIR OPERATED SANDBLASTER

End Of Year Special Price \$99.00 + gst

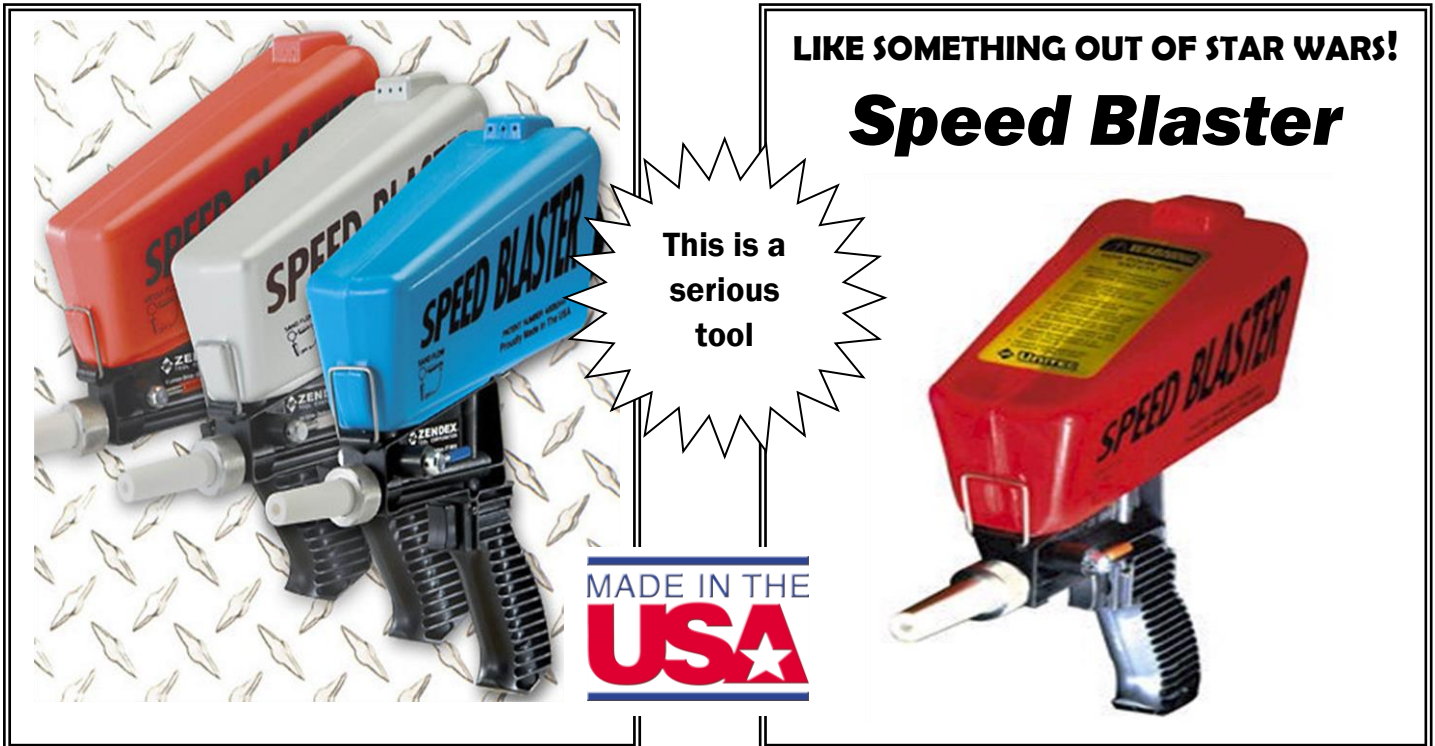

Full elimination of rust, scale and corrosion is difficult.

Complete removal is best attained by the blasting of high-speed media particles at the small niches in the metal.

The gravity fed, safety-vented reservoir tank of *Speed Blaster* eliminates the need for tubes or siphon hoses that easily clog.

A variety of blast media not exceeding 14 grit can be used.

With correct media and moisture-free air *Speed Blaster* runs virtually clog free continuously.

Sand flow is metered precisely with the fully adjustable material control valve.

Gravity forces the particles into a hardened steel mixing chamber where they practically hit warp speed passing through a space-age ceramic nozzle.

Balance, performance and built to last, *Speed Blaster* is available in Red or Blue neon . . . We can't help it if they look great too.

## SPECIFICATIONS

Operating Pressure: 60 -100 PSI  
Consumption: 12 CFM - 125 PSI  
1/4 NPT

Working Pressure: 100 -125 PSI Air  
Minimum Air Compressor: 3 HP Fitting Size:  
Container Capacity: 26 oz (vol) Gun Material: ABS  
Empty Weight: 14 oz Maximum Particle Size: 14 Grit

**Part No: SB007B**



# TOP 50 DRIVESHAFTS



## Grab These NEW Shafts At Special Prices

**New Shafts In Stock For Most Makes And Models**

**All With 3 Year Warranty**

**Large Selection Of European Shafts at Budget Prices**

**BUY 10 SHAFTS AND GET ONE FREE**

### FORD

**+ GST**

|           |                                 |    |           |
|-----------|---------------------------------|----|-----------|
| CVS.291   | Courier/ Raider / Bravo / B2600 | LH | \$ 110.00 |
| CVS.292   | Courier/ Raider / Bravo         | RH | \$ 110.00 |
| CVS.MZ92  | Courier 4WD with Auto Hub       | RH | \$ 140.00 |
| CVS.2583  | Festiva WB Manual/DB 1.3 121    | LH | \$ 110.00 |
| CVS.FD17  | Focus                           |    | \$ 130.00 |
| CVS.215   | Laser KJ KL/323 BA Protege1.6   | LH | \$ 110.00 |
| CVS.205   | Laser KC-KE/Capri N/T           | LH | \$ 110.00 |
| CVS.206   | Laser KC-KE/Capri N/T           | RH | \$ 110.00 |
| CVS.FD89  | Ranger / BT-50                  | LH | \$ 140.00 |
| CVS.FD90  | Ranger / BT-50                  | RH | \$ 140.00 |
| CVS.FD87  | Territory                       | LH | \$ 140.00 |
| CVS.FD88  | Territory                       | RH | \$ 140.00 |
| CVS.FD298 | Ford/Mazda                      |    | \$ 151.50 |

### HOLDEN

|         |                                     |    |           |
|---------|-------------------------------------|----|-----------|
| CVS.351 | Commodore VN,VP,VQ,VR.VS Rear W/IRS | RR | \$ 135.00 |
| CVS.377 | Rodeo RA                            | LR | \$ 145.00 |

**HYUNDAI****+ GST**

|         |  |    |           |
|---------|--|----|-----------|
| CVS.542 | Accent/Getz Automatic 09/02 to 8/11    | RH | \$ 125.00 |
| CVS.543 | Accent/Getz Manual 09/02 to 8/11       | LH | \$ 110.00 |
| CVS.544 | Accent/Getz Manual 09/02 to 8/11       | RH | \$ 110.00 |
| CVS.503 | Excel X3 19/4 to 6/11                  | LH | \$ 110.00 |
| CVS.504 | Hyundai X3 19/4 to 6/11                |    | \$ 110.00 |
| CVS.505 | Hyundai X2 1/90 to 11/94               |    | \$ 110.00 |
| CVS.529 | Elantra Automatic 1.8 2.0 2000 to 2/07 | LH | \$ 125.00 |
| CVS.530 | Elantra Automatic 1.8 2.0 2000 to 2/07 | RH | \$ 130.00 |
| CVS.541 | Getz Automatic 09/02 to 8/11           | LH | \$ 120.50 |
| CVS.542 | Getz Automatic 09/02 to 8/11           | RH | \$ 135.00 |

**MITSUBISHI**

|          |           |    |           |
|----------|-----------|----|-----------|
| CVS.MI13 | Triton ML | LH | \$ 140.00 |
| CVS.MI14 | Triton ML | RH | \$ 140.00 |

**NISSAN**

|         |                    |    |           |
|---------|--------------------|----|-----------|
| CVS.837 | Pulsar N15 1.6     | LH | \$ 110.00 |
| CVS.838 | Pulsar N15 1.6     | RH | \$ 110.00 |
| CVS.879 | Navara D40         | RH | \$ 140.00 |
| CVS.878 | Navara D22 4/97 on | LR | \$ 140.00 |

**SUBARU**

|               |   |     |           |
|---------------|---|-----|-----------|
| CVS.923       | Leone 4x4/Brumby 79-84                              | L/R | \$ 130.00 |
| CVS.949 - 905 | Forester 3/08 on                                    | L/R | \$ 159.00 |
| CVS.947A      | Outback/Forester incl ABS                           | L/R | \$ 135.00 |
| CVS.947       | Liberty (some)                                      | L/R | \$ 135.00 |
| CVS.965       | GD GG Impreza WRX 2.0/2.5 04; Forester 8/02 to 2/08 | L/R | \$ 145.00 |

**TOYOTA**

|             |   |     |           |
|-------------|---|-----|-----------|
| CVS.1139    | Camry SDV10 / 20 Series 4 cyl             | LH  | \$ 110.00 |
| CVS.1140    | Camry SDV10 / 20 Series 4 cyl             | RH  | \$ 130.00 |
| CVS.1105    | Corolla AE90-92-93-101-102-112, AE82 DOHC | LH  | \$ 110.00 |
| CVS.1106    | Corolla AE90-92-93-101-102-112, AE82 DOHC | RH  | \$ 110.00 |
| CVS.1161    | HiLux/4Runner with IFS                    | LR  | \$ 130.00 |
| CVS.1161L   | HiLux Surf Raised Suspension              | LH  | \$ 135.00 |
| CVS.1187L   | HiLux KUN26 Raised Suspension             | LH  | \$ 140.00 |
| CVS.1187    | HiLux KUN26                               | L/R | \$ 140.00 |
| CVS.1192L   | Landcruiser 80 Series                     | LH  | \$ 95.00  |
| CVS.1192R   | Landcruiser 80 Series                     | RH  | \$ 110.00 |
| CVS.1192LF2 | Landcruiser HZJ FZJ 78-79                 | LH  | \$ 120.00 |
| CVS.1192RF2 | Landcruiser HZJ FZJ 78-79                 | RH  | \$ 120.00 |
| CVS.1165    | Landcruiser/Prado 100 Series              | LR  | \$ 155.00 |
| CVS.1163    | Landcruiser/Prado 90 Series               | LR  | \$ 135.00 |
| CVS.1167    | Landcruiser 100 Series with IFS           |     | \$ 165.00 |

# NEW POWER STEERING PUMPS BY LUK & ZF

**AVAILABLE NOW**

**O.E.M. GERMAN-MADE PUMPS FOR SELECTED VEHICLES  
INCLUDING: AUDI BMW MERCEDES MINI VOLVO**



| Part No | Make | Vehicle                         |
|---------|------|---------------------------------|
| 37970   | ZF   | Audi A4, VW Passat              |
| 37950   | LUK  | BMW E36                         |
| 37925   | LUK  | BMW E39                         |
| 38045   | ZF   | BMW E46                         |
| 37900   | LUK  | BMW E46 LF20                    |
| 37910   | LUK  | BMW E46 LF30                    |
| 37990   | ZF   | BMW E60 E63                     |
| 37965   | ZF   | BMW E87 E90 E91                 |
| 38040   | ZF   | BMW X3 E83 2.5 & 3.0            |
| 38010   | ZF   | BMW X5 E53 4.4                  |
| 38025   | ZF   | Land Rover                      |
| 38020   | ZF   | Mercedes                        |
| 37915   | ZF   | Mercedes                        |
| 37975   | ZF   | Mercedes C Class, E Class       |
| 37905   | LUK  | Mercedes C, CLK, E & ML Class   |
| 38000   | ZF   | Mercedes E Class (211)          |
| 38050   | ZF   | Mercedes ML63 (164)             |
| 38060   | ZF   | Mercedes Sprinter               |
| 38030   | ZF   | Mercedes Sprinter (W/O Switch)  |
| 38035   | ZF   | Mercedes Sprinter (With Switch) |
| 37945   | ZF   | Mercedes Sprinter, Viano, Vito  |
| 37920   | LUK  | Mercedes Vito                   |
| 37930   | ZF   | Mini Electric/Hydraulic         |
| 38005   | ZF   | Volvo                           |
| 38055   | ZF   | Volvo XC90 D5                   |
| 38015   | ZF   | Volvo, Ford                     |

**ALSO AVAILABLE A HUGE RANGE OF ECONOMY PUMPS  
TO SUITE MOST EUROPEAN AND DOMESTIC VEHICLES**





**Made In Japan  
by NOK  
Split & Welded  
CV Boots  
Made To O.E.M.  
Standard**

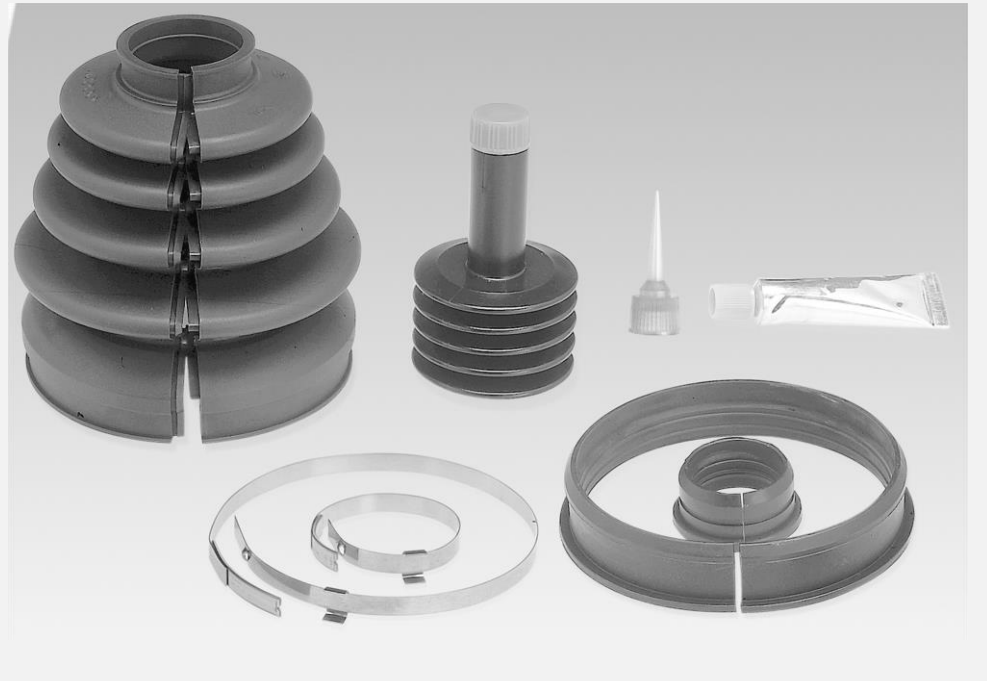

**NOW FITTED OEM ON AN INCEASING NUMBER OF NEW VEHICLES**

**Made From Modern Materials That  
Far Outstrip Older Compounds,  
These New NOK Boots Save Time  
and Money In Speed Of Fitting**

**PLUS the Hard-wearing Nature Of These New Materials  
Enables Us To Give Five Times The Usual Warranty .**

**Each Boxed Kit Contains**

- **Split Boot**
- **Fixing Agent**
- **Large Adaptor Grommet**
- **Small Adaptor Grommet**
- **2 Stainless Steel Clamps**
- **Grease**
- **Full Instructions**

**NOK's Split Boot Is Available  
In A Range Of Sizes To Match  
Individual Vehicles  
Contact Turners For  
Comprehensive Listings**

**NOTE: UNLIKE PREVIOUS SPLIT BOOTS,  
BY USING THE FIXING AGENT PROVIDED  
THESE BOOTS ARE WELDED NOT  
"GLUED"**

**Sold In Kits of One**

# Do Your Customers Think REVERSING SENSORS

Are Too Expensive?  
**THINK AGAIN**  
Offer Them This  
Value-for Money Kit

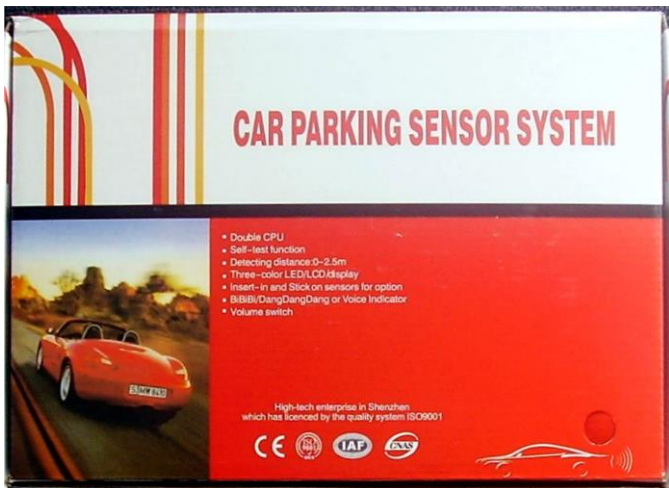

**Sensor Installation drawing (Unit:cm)**

The position for sensor to install is depend on the quantity of the sensor (NOTE: There are four type to choose, four sensor, five sensors, six sensors and eight sensors.)

1. four Sensors

2. eight sensors

**The Way of sensor installation**

1. Installation position (angle)

2. The installation step

Define the position and make sure there is no obstacle by side-glance on a 90° angle, otherwise will affect the detectable effect.

**Alarm Mode**

| Stages | Distance  | Awareness      | Sound Alarm | Number  | color | Video            | LED/LCD | BAT     |
|--------|-----------|----------------|-------------|---------|-------|------------------|---------|---------|
| 1      | >250cm    | Safe area      | silence     | 1,6-2.5 | white |                  |         | No back |
| 2      | 160-250cm | Safe area      | Dang_Dang   | 1,6-2.5 | white |                  |         | 1       |
| 3      | 100-150   | Safe area      | Dang_Dang   | 1,6-2.5 | white | Green            |         | 1-6     |
| 4      | 70-90cm   | Alert area     | Dang_Dang   | 0.7-0.9 | white | Green+yellow     |         | 7-9     |
| 5      | 40-60cm   | Alert area     | Dang_Dang   | 0.5-0.6 | white | Green+yellow     |         | 10      |
| 6      | 0-30cm    | Dangerous area | Dang_Dang   | 0.0-0.4 | white | Green+yellow+red |         | 10      |

**More eyes & More Ssfе**

**Functional Characteristics:**

- Prevent from corner colliding and impacting with special design for easy operating.
- The vocal notification of "Bi-Bi" and digital distance display show the characteristics, especially at night.
- The sever colors display for orientation of obstacles.
- The provoke design for voice and digital make it more harmonious and attractive.
- The appearance of sensor and body of vehicle is a perfect match, just like original binding accessories.
- The humanity design and human voice notification for distance of obstacles. (vocal)

**Technical parameter:**

Operating voltage: DC12V ± 2V      Detective range: front: 0.3-0.8m    back: 0.3-2.0m  
 Operating temperature: -20°C ~ 70°C      Operating electric current: 200mA ± 50mA  
 Detective angle: H: 80°    V: 70°

**Install sketch map**

1. The host connects line diagram

2-4 Spread feeling machine series      6-8 Spread feeling machine series

2. The product installs diagram

Note: Spread a feeling machine an amount to be divided into 4, 5, 6, 7, 8 press label to avoid put to connect

4 contain after spreading the feeling machine    A B C D  
 5 spread feeling to contain E F before the machine, containing A B C behind  
 6 spread feeling to contain E F before the machine, containing A B C D behind  
 8 spread feeling to contain E G H F before the machine, containing A B C D behind

## Trade Price

**Introductory Offer Only \$59.00**

**(USUALLY \$79.00)**

# **NU-TECH**

**Polymer Bushing System**

**Full Restoration of Marginally Worn  
Front End Parts To New Or  
Closer Than New Tolerances  
SAVE \$\$\$ - DON'T REPLACE . . . REPAIR!**

**The solution for hard-to-find or costly steering & suspension parts including classics & vintage**  
**ALSO IDEAL FOR HEAVY VEHICLES**

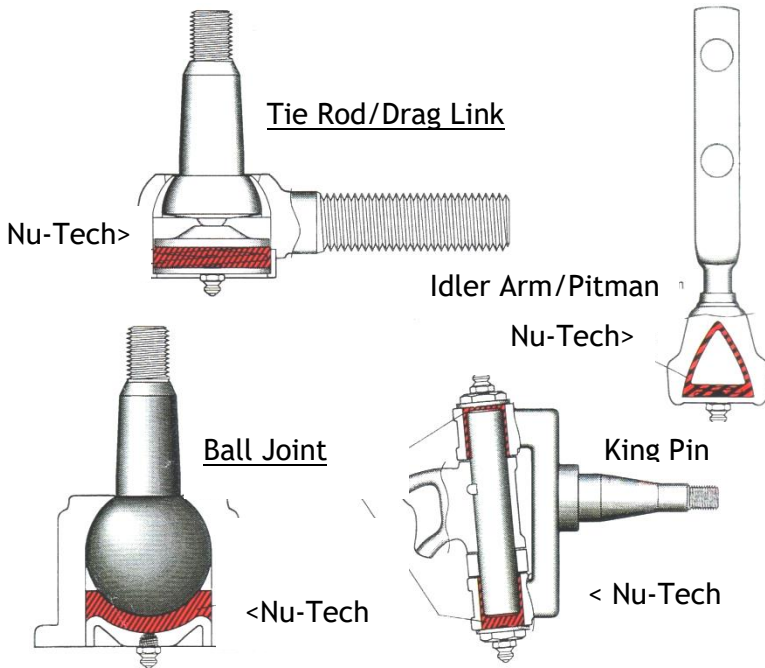

- TIE ROD ENDS
- BALL JOINTS
- IDLER ARMS
- DRAG LINKS
- KING PINS
- CENTRE LINKS
- CONTROL ARM BUSHINGS

**IN FACT . . . Any Friction Bushing That Is Not a Bearing or Rubber Mounting**

**NOT to be Confused with Similar Inferior Acrylic Treatments**

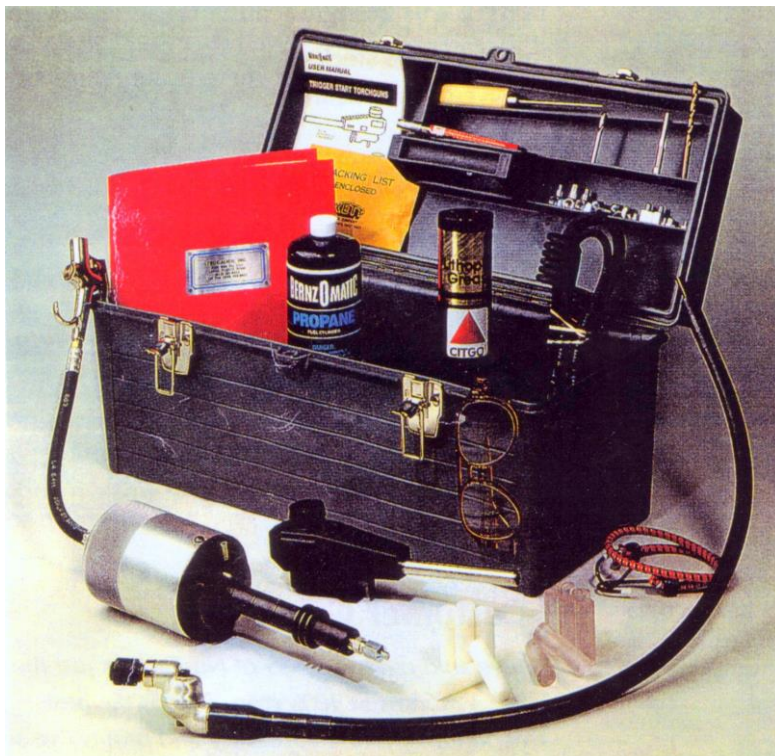

**Terrific  
Business Opportunity**  
**Service Your Area With  
Full Kit and Polymer  
Flyers Supplied  
Training Included**



**MID YEAR SALE ON CERAMIC BRAKE PADS**



**CERAMIC BRAKE PADS BY BOSJN**

**All Pads \$25.00 including gst**

**Quote This Ad & Get 20% Off**

**Hardware Kits**

**When Ordering Selected Pads**

**DB Nos: 288 1200 1267 1331 1332 1365 1482 1760 1800**

**DB288**

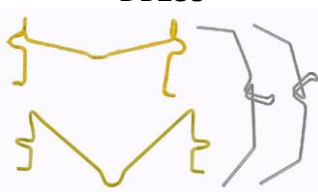

**Eunos Cargo Bundera  
4Runner HiLux Landcruiser**

**DB1200**

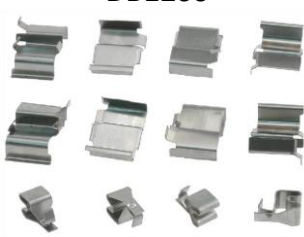

**Landcruiser Pajero Prado**

**DB1267**



**Nova Camry Corolla Corona  
Cressida Crown RAV4**

**DB1331**



**Commodore Crewman Monaro  
Statesman Ute Pontiac GTO**

**DB1365**



**Lexus LX450  
Landcruiser**

**DB1482**

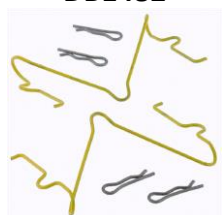

**Lexus GX Pajero FJ Cruiser  
Landcruiser Prado**

**DB1760**



**Mazda 6**

**DB1800**



**Aurion Camry**

**LARGE RANGE OF DRUM & HANDBRAKE KITS**



**ROTORS TOO**



**ASSORTMENT BOXES**



# TAILSHAFTS

## WIDE SELECTION ALWAYS AVAILABLE



**AVAILABLE NOW!**

### Mid-Year Specials On LANDCRUISER TAILSHAFTS

|                    |                |          |
|--------------------|----------------|----------|
| 78 Series Rear *   | 37110-6A250JNG | \$495.00 |
| 79 Series Rear     | 37110-6A260NG  | \$385.00 |
| 78/79 Series Front | 37140-35190NG  | \$385.00 |
| 75 Series Rear *   | 37110-60530JNG | \$495.00 |
| 75 Series Front    | 37140-60280NG  | \$385.00 |

\*JAPANESE



### HOLDEN COMMODORE REAR DRIVESHAFTS

Common Tail Shafts Including Centre Bearing P.O.A From \$550

Most Versions Available

Phone Joe for All Your Transmission Needs 1800 819 033

**SAVINGS WITHOUT COMPROMISE**

**Extended Brake Hoses**

**Brake Callipers**

**Disc Rotors**



|                              |                    |           |         |
|------------------------------|--------------------|-----------|---------|
| 90080-94029ENG KUN26 & GGN25 | Hilux Front        | RHS & LHS | \$16.00 |
| 90947-T2015ENG KUN26 & GGN25 | Hilux Rear         | Non VSC   | \$14.00 |
| 90947-T2057ENG KUN26 & GGN25 | Hilux Rear         | with VSC  | \$16.00 |
| 90947-T2058ENG KUN26 & GGN25 | Hilux Rear         | with VSC  | \$16.00 |
| 90947-02B48ENG 78/79#        | Landcruiser Front* | RHS & LHS | \$16.00 |
| 90947-02A07ENG 78/79#        | Landcruiser Rear   | RHS       | \$16.00 |
| 90947-02A08ENG 78/79#        | Landcruiser Rear   | LHS       | \$16.00 |



|                              |                |
|------------------------------|----------------|
| 47730-60070NG Rear Calliper  | RHS 70/80/105# |
| 47750-60070NG Rear Calliper  | LHS 70/80/105# |
| 47730-60120NG Front Calliper | RHS 78/79#     |
| 47750-60120NG Front Calliper | LHS 78/79#     |



|  |         |
|--|---------|
| 43512-35190NG Front Rotor Hilux 85-04 With IFS     | \$40.00 |
| 43512-35200NG Front Rotor 130# Hilux/4Runner 91-95 | \$45.00 |
| 43512-60120NG Front Rotor Prado 4/96-9/02          | \$35.00 |
| 43512-60150NG Front Rotor Prado 9/02-06/05         | \$48.00 |
| 42431-60200NG Rear Rotor Prado 4/96-6/05           | \$44.00 |
| 43512-60050NG Front Rotor 80# Landcruiser Early    | \$40.00 |
| 43512-60090NG Front Rotor 80# Landcruiser Late     | \$40.00 |
| 43512-60170NG Front Rotor 100# Landcruiser#        | \$40.00 |
| 42431-60280NG Rear Rotor 100# Landcruiser#         | \$45.00 |





## UPPER & LOWER CONTROL ARMS

High Quality

Two Years Warranty

Low Price

**RING JOE FOR ALL OTHER MAKE & MODELS**



| PART NO.          | VEHICLE                                    | LOCATION                              | TRADE |
|-------------------|--|---------------------------------------|-------|
| <b>ALFA ROMEO</b> |  |                                       |       |
| TCAALF001L        | ALFA ROMEO 147 9/01-11; 156 2/99-07        | LEFT FRONT UPPER                      | \$102 |
| TCAALF001R        | ALFA ROMEO 147 9/01-11; 156 2/99-07        | RIGHT FRONT UPPER                     | \$102 |
| TCAALF002L        | ALFA ROMEO 147 9/01-11; 156 9/01-11        | LEFT FRONT LOWER                      | \$164 |
| TCAALF002R        | ALFA ROMEO 147 9/01-11; 156 9/01-11        | RIGHT FRONT LOWER                     | \$164 |
| <b>AUDI</b>       |  |                                       |       |
| TCAAU002L         | A3 8P 06/2004-04/2013 (DIESEL)             | LEFT FRONT LOWER                      | \$137 |
| TCAAU002R         | A3 8P 06/2004-04/2013 (DIESEL)             | RIGHT FRONT LOWER                     | \$137 |
| TCAAU004L         | A4 B5/B6 95-05; A4/S4 B7 02/05-12/07       | LEFT FRONT LOWER REAR                 | \$113 |
| TCAAU004R         | A6 C5 97-01; A8 D2 95-03                   | RIGHT FRONT LOWER REAR                | \$113 |
| TCAAU007L         | A4/S4 B8 1/08-5/12; A5 8T 12/07-01/12      | LEFT FRONT LOWER FRONT                | \$120 |
| TCAAU007R         | Q5 8R 3/09-08/12 (STRAIGHT)                | RIGHT FRONT LOWER FRONT               | \$120 |
| TCAAU010L         | A4 B7 02/2005-12/2007                      | FRONT UPPER FRONT TORQUE ARM LEFT     | \$68  |
| TCAAU010R         | A4 B7 02/2005-12/2007                      | FRONT UPPER FRONT TORQUE ARM RIGHT    | \$68  |
| TCAAU010R         | A4 B7 02/2005-12/2007                      | FRONT UPPER FRONT TORQUE ARM RIGHT    | \$68  |
| TCAAU011L         | A4 B8 01/2008 -05/2012;                    | LEFT FRONT LOWER REAR (CURVED STYLE)  | \$149 |
| TCAAU011R         | A5 8T 12/2007 - 01/2012 TAPER: 15MM        | RIGHT FRONT LOWER REAR (CURVED STYLE) | \$149 |
| TCAAU012L         | A4/S4 B8 01/2008-05/2012 TAPER: 17MM       | LEFT FRONT LOWER REAR (CURVED STYLE)  | \$149 |
| TCAAU012R         | A4/S4 B8 01/2008-05/2012 TAPER: 17MM       | RIGHT FRONT LOWER REAR (CURVED STYLE) | \$149 |
| TCAAU016N         | A4 B5/B6 08/95-12/07; A4/S4 B7 02/05-12/07 | LOWER FRONT (TAPER: 16.5MM)           | \$102 |
| TCAAU017N         | A4 B5/B6/B7 08/95-12/07; A6 C5 10/97-08/04 | LOWER FRONT (TAPER: 20MM)             | \$102 |
| TCAAU017N         | A8 D2 05/95-08/03                          | LOWER FRONT (TAPER: 20MM)             | \$102 |
| TCAAU005N         | AUDI Q7 4L 08-10                           | FRONT UPPER 07/07-05/15 (L=R)         | \$106 |
| TCAAU006L         | Q7 4L 07/2007-05/2015                      | LEFT FRONT LOWER                      | \$202 |
| TCAAU006R         | Q7 4L 07/2007-05/2015                      | RIGHT FRONT LOWER                     | \$202 |

|            |  |  |       |
|------------|--|--|-------|
| TCAAU008L  | A6 C6 9/04-6/11; A8 D3/4E 8/03-6/10 (CURVED)             | LEFT FRONT LOWER REAR (CURVED STYLE)     | \$114 |
| TCAAU008R  | A6 C6 9/04-6/11; A8 D3/4E 8/03-6/10 (CURVED)             | RIGHT FRONT LOWER REAR (CURVED STYLE)    | \$114 |
| TCAAU009N  | A6/S6 C6/4F 09/04-06/11<br>A8 D3/4E 8/03-6/10 (STRAIGHT) | FRONT LOWER FRONT LH/RH                  | \$135 |
| TCAAU013L  | A6/S6 C6/4F 09/2004 ~ 06/2011                            | LEFT FRONT UPPER FRONT (STRAIGHT STYLE)  | \$72  |
| TCAAU013R  | A6/S6 C6/4F 09/2004 ~ 06/2011                            | RIGHT FRONT UPPER FRONT (STRAIGHT STYLE) | \$72  |
| TCAAU015L  | Q3 8U 03/2012 ~ ONWARDS                                  | LEFT FRONT LOWER - NO BALL JOINT         | \$181 |
| TCAAU015R  | Q3 8U 03/2012 ~ ONWARDS                                  | RIGHT FRONT LOWER - NO BALL JOINT        | \$181 |
| TCAAU018N  | AUDI A3 8L 05/1997 ~ 05/2004                             | FRONT LOWER LH=RH                        | \$173 |
| <b>BMW</b> |  |  |       |
| TCABMW001L | E30 3 Series 318 325 M3 84-93                            | FRONT LOWER WITH BALL JOINT KIT LEFT     | \$123 |
| TCABMW001R | E30 3 Series 318 325 M3 84-93                            | FRONT LOWER WITH BALL JOINT KIT RIGHT    | \$123 |
| TCABMW002L | 1 SER. E87 09/04-09/11; 3 SERIES E90-E93 03/05-12        | LEFT FRONT LOWER REAR                    | \$126 |
| TCABMW002R | X1 E84 01/10-07/15                                       | RIGHT FRONT LOWER REAR                   | \$126 |
| TCABMW009L | 1 SERIES E87 09/04-09/11; 3 SERIES E90-E93 03/05-12      | LEFT FRONT LOWER FRONT                   | \$124 |
| TCABMW009R | 1 SERIES E87 09/04-09/11; 3 SERIES E90-E93 03/05-12      | RIGHT FRONT LOWER FRONT                  | \$124 |
| TCABMW003L | 5 SER. E39 (V8) 5/96-9/03 (LONG BJ PIN)                  | LEFT FRONT LOWER                         | \$91  |
| TCABMW003R | 5 SER. E39 (V8) 5/96-9/03 (LONG BJ PIN)                  | RIGHT FRONT LOWER                        | \$91  |
| TCABMW004L | 5 SER. E39 (V6) 5/96-9/03 (SHORT BJ PIN)                 | LEFT FRONT LOWER                         | \$85  |
| TCABMW004R | 5 SER. E39 (V6) 5/96-9/03 (SHORT BJ PIN)                 | RIGHT FRONT LOWER                        | \$85  |
| TCABMW005L | 5 SER. E60/61 10/03-3/10                                 | LEFT FRONT UPPER                         | \$137 |
| TCABMW005R | 5 SER. E60/61 10/03-3/10                                 | RIGHT FRONT UPPER                        | \$137 |
| TCABMW006L | 5 SER. E60/61 10/03-3/10                                 | LEFT FRONT LOWER                         | \$107 |
| TCABMW006R | 5 SER. E60/61 10/03-3/10                                 | RIGHT FRONT LOWER                        | \$107 |
| TCABMW007L | 6 SER. E63/E64 05/0-01/10                                | LEFT FRONT LOWER REAR                    | \$98  |
| TCABMW007R | 7 SER. E65/66 05/04-01/10                                | RIGHT FRONT LOWER REAR                   | \$98  |
| TCABMW011L | X3 E83 06/2004-02/2011                                   | LEFT FRONT UPPER, HOLE DEPTH: 35MM       | \$128 |
| TCABMW011R | X3 E83 06/2004-02/2011                                   | RIGHT FRONT UPPER, HOLE DEPTH: 35MM      | \$128 |
| TCABMW015L | X3 E83 06/2004 ~ 2012                                    | LEFT FRONT LOWER                         | \$90  |
| TCABMW015R | X3 E83 06/2004 ~ 2012                                    | RIGHT FRONT LOWER                        | \$90  |
| TCABMW012L | X5 E53 11/2000-12/2006                                   | LEFT FRONT LOWER REAR                    | \$95  |
| TCABMW012R | X5 E53 11/2000-12/2006                                   | RIGHT FRONT LOWER REAR                   | \$95  |
| TCABMW013L | X5 E53 11/2000-12/2006                                   | LEFT FRONT LOWER FRONT                   | \$104 |
| TCABMW013R | X5 E53 11/2000-12/2006                                   | RIGHT FRONT LOWER FRONT                  | \$104 |
| TCABMW014L | X5 / X6 E70 / E71 03/2007-07/2013                        | LEFT FRONT UPPER                         | \$141 |
| TCABMW014R | X5 / X6 E70 / E71 03/2007-07/2013                        | RIGHT FRONT UPPER                        | \$141 |
| TCABMW016L | X5 / X6 E70 / E71 03/2007-07/2013                        | LEFT FRONT LOWER (Near Fire Wall)        | \$115 |
| TCABMW016R | X5 / X6 E70 / E71 03/2007-07/2013                        | RIGHT FRONT LOWER (Near Fire Wall)       | \$115 |
| TCABMW017L | X5 / X6 E70 / E71 03/2007-07/2013                        | LEFT FRONT LOWER (Near Radiator)         | \$119 |

|                 |   |   |       |
|-----------------|---|---|-------|
| TCABMW017R      | X5 / X6 E70 / E71 03/2007-07/2013           | RIGHT FRONT LOWER (Near Radiator)                   | \$119 |
| <b>CHRYSLER</b> |   |   |       |
| TCACR001N       | 300 & 300C 11/2005 on                       | FRONT LOWER REAR STRAIGHT TYPE LH/RH                | \$109 |
| TCACR002L       | 300 & 300C 11/2005 on                       | LEFT FRONT UPPER (Oval holes near ball )            | \$109 |
| TCACR002R       | 300 & 300C 11/2005 on                       | RIGHT FRONT UPPER (Oval holes near ball )           | \$109 |
| TCACR003L       | 300 & 300C 11/2005 on                       | LEFT FRONT UPPER (2 even round holes nr ball joint) | \$103 |
| TCACR003R       | 300 & 300C 11/2005 on                       | RIGHT FRONT UPPER 2even round holes nr ball joint)  | \$103 |
| TCACR004L       | 300 & 300C 11/2005 on                       | LEFT FRONT LOWER FRONT (BENT TYPE)                  | \$104 |
| TCACR004R       | 300 & 300C 11/2005 on                       | RIGHT FRONT LOWER FRONT (BENT TYPE)                 | \$104 |
| <b>DAEWOO</b>   |   |   |       |
| TCADW001L       | KALOS T200 04/2003 ~ ONWARDS                | LEFT FRONT LOWER                                    | \$94  |
| TCADW001R       | KALOS T200 04/2003 ~ ONWARDS                | RIGHT FRONT LOWER                                   | \$94  |
| <b>DAIHATSU</b> |   |   |       |
| TCADH001L       | DAIHATSU SIRION M3.01 11/2004-11/2008       | LEFT FRONT LOWER                                    | \$106 |
| TCADH001R       | DAIHATSU SIRION M3.01 11/2004-11/2008       | RIGHT FRONT LOWER                                   | \$106 |
| <b>FORD</b>     |   |   |       |
| TCAFD001L       | TERRITORY TX SX SY 2WD AWD 04-09            | LEFT FRONT LOWER                                    | \$88  |
| TCAFD001R       | TERRITORY TX SX SY 2WD AWD 04-09            | RIGHT FRONT LOWER                                   | \$88  |
| TCAFD003M       | TERRITORY SX SY AWD 2WD 04-11               | LOWER FRONT RADIUS ARM (PAIR)                       | \$240 |
| TCAFD006        | TERRITORY 2004 on; FALCON BA BF FG 2002 on  | REAR TRAILING ARM BLADE (PAIR)                      | \$180 |
| TCAFD002L       | FALCON AU2 BA BF                            | LEFT FRONT LOWER BALL JOINTS                        | \$125 |
| TCAFD002R       | FALCON AU2 BA BF                            | RIGHT FRONT LOWER BALL JOINTS                       | \$125 |
| TCAFD018N       | FALCON, FAIRLANE, LTD BA BF 10/2002-02/2008 | REAR LOWER (SET LH/RH)                              | \$147 |
| TCAFD007L       | FALCON FG 02/2008 - 08/2014                 | LEFT FRONT LOWER REAR (V6/V8)                       | \$138 |
| TCAFD007R       | FALCON FG 02/2008 - 08/2014                 | RIGHT FRONT LOWER REAR (V6/V8)                      | \$138 |
| TCAFD008L       | FALCON FG 02/2008 - 08/2014                 | LEFT FRONT LOWER FRONT (V6/V8)                      | \$141 |
| TCAFD008R       | FALCON FG 02/2008 - 08/2014                 | RIGHT FRONT LOWER FRONT (V6/V8)                     | \$141 |
| TCALV001        | FALCON FG G6E XR6 XR8 XT                    | RIGHT FRONT UPPER (Pair)                            | \$189 |
| TCALV001L       | FALCON FG G6E XR6 XR8 XT                    | LEFT FRONT UPPER                                    | \$94  |
| TCALV001R       | FALCON FG G6E XR6 XR8 XT                    | RIGHT FRONT UPPER                                   | \$94  |
| TCAFD004L       | LASER KN KQ 1999-2002                       | LEFT FRONT LOWER                                    | \$94  |
| TCAFD004R       | LASER KN KQ 1999-2002                       | RIGHT FRONT LOWER                                   | \$94  |
| TCAMA002L       | RANGER PJ PK 4WD 2006-2011                  | LEFT FRONT UPPER                                    | \$128 |
| TCAMA002R       | RANGER PJ PK 4WD 2006-2011                  | RIGHT FRONT UPPER                                   | \$128 |
| TCAFD005        | RANGER T6 PX PXII 4WD 2012-ON               | FRONT UPPER ADJUSTABLE (Pair)                       | \$319 |
| TCAMA018L       | RANGER PJ/PK 4WD 12/2006-08/2011            | LEFT FRONT LOWER                                    | \$154 |
| TCAMA018R       | RANGER PJ/PK 4WD 12/2006-08/2011            | RIGHT FRONT LOWER                                   | \$154 |
| TCAMA019L       | RANGER PX SER1 (4WD) 09/2011 - 05/2015      | LEFT FRONT UPPER                                    | \$88  |
| TCAMA019R       | RANGER PX SER1 (4WD) 09/2011 - 05/2015      | RIGHT FRONT UPPER                                   | \$88  |
| TCAMA020L       | RANGER PX SER1 09/2011 - 5/2015             | LEFT FRONT LOWER                                    | \$168 |
| TCAMA020R       | RANGER PX SER1 09/2011 - 5/2015             | RIGHT FRONT LOWER                                   | \$168 |



|              |  |   |       |
|--------------|--|---|-------|
| TCAFD012L    | FOCUS LS/LT/LV 06/2005 - 03/2011       | LEFT FRONT LOWER (TAPER DIAMETER: 18MM) | \$137 |
| TCAFD012R    | FOCUS LS/LT/LV 06/2005 - 03/2011       | LEFT FRONT LOWER (TAPER DIAMETER: 18MM) | \$137 |
| TCAFD013L    | FOCUS LS/LT 06/2005 - 06/2009          | LEFT FRONT LOWER (TAPER DIAMETER: 15MM) | \$137 |
| TCAFD013R    | FOCUS LS/LT 06/2005 - 06/2009          | LEFT FRONT LOWER (TAPER DIAMETER: 15MM) | \$137 |
| TCAFD014L    | FOCUS LW 04/2011 - 11/2014             | LEFT FRONT LOWER                        | \$153 |
| TCAFD014R    | FOCUS LW 04/2011 - 11/2014             | RIGHT FRONT LOWER                       | \$153 |
| TCAFD015L    | MONDEO MA - MC 10/2007 - 12/2014       | LEFT FRONT LOWER                        | \$132 |
| TCAFD015R    | MONDEO MA - MC 10/2007 - 12/2014       | RIGHT FRONT LOWER                       | \$132 |
| TCAFD016L    | FIESTA WP/WQ 04/2004 - 12/2008         | LEFT FRONT LOWER                        | \$141 |
| TCAFD016R    | FIESTA WP/WQ 04/2004 - 12/2008         | RIGHT FRONT LOWER                       | \$141 |
| TCAMA015L    | FIESTA WS/WT 09/2008 - 07/2013         | LEFT FRONT LOWER                        | \$106 |
| TCAMA015R    | FIESTA WS/WT 09/2008 - 07/2013         | RIGHT FRONT LOWER                       | \$106 |
| TCAMA017L    | ESCAPE BA/ZA/ZB/ZC 02/2001 - 03/2008   | LEFT FRONT LOWER                        | \$129 |
| TCAMA017R    | ESCAPE BA/ZA/ZB/ZC 02/2001 - 03/2008   | RIGHT FRONT LOWER                       | \$129 |
| TCAFD017L    | TRANSIT VH - VM 11/2000 - 08/2014      | LEFT FRONT LOWER                        | \$106 |
| TCAFD017R    | TRANSIT VH - VM 11/2000 - 08/2014      | RIGHT FRONT LOWER                       | \$106 |
| <b>HONDA</b> |  |   |       |
| TCAHD004L    | CRV RD1 RD2 RD3 10/1996 - 11/2001      | LEFT FRONT LOWER                        | \$101 |
| TCAHD004R    | CRV RD1 RD2 RD3 10/1996 - 11/2001      | RIGHT FRONT LOWER                       | \$101 |
| TCAHD008L    | CRV CR-V 10/1996 - 01/2007             | LEFT FRONT UPPER                        | \$66  |
| TCAHD008R    | CRV CR-V 10/1996 - 01/2007             | RIGHT FRONT UPPER                       | \$66  |
| TCAHD001     | CR-V CRV RD4 RD5 RD7 2001-2007         | LOWER FRONT (1 Pair)                    | \$194 |
| TCAHD006L    | CRV CR-V RE 2007-2012                  | LEFT LOWER FRONT                        | \$168 |
| TCAHD006R    | CRV CR-V RE 2007-2012                  | RIGHT LOWER FRONT                       | \$168 |
| TCAHD007L    | CR-V RE6 2012-2017                     | LEFT LOWER FRONT                        | \$132 |
| TCAHD007R    | CR-V RE6 2012-2017                     | RIGHT LOWER FRONT                       | \$132 |
| TCAHD003L    | ACCORD/EURO CM CL 06/2003 - 01/2008    | LEFT LOWER FRONT                        | \$132 |
| TCAHD003R    | ACCORD/EURO CM CL 06/2003 - 01/2008    | RIGHT LOWER FRONT                       | \$132 |
| TCAHD005L    | ACCORD/EURO CP/CU 02/2008 - 02/2013    | LEFT FRONT LOWER BALL JOINT             | \$159 |
| TCAHD005R    | ACCORD/EURO CP/CU 02/2008 - 02/2013    | RIGHT FRONT LOWER BALL JOINT            | \$159 |
| TCAHD009L    | ACCORD CM EURO CL 06/2003 - 01/2008    | LEFT FRONT UPPER                        | \$86  |
| TCAHD009R    | ACCORD CM EURO CL 06/2003 - 01/2008    | RIGHT FRONT UPPER                       | \$86  |
| TCAHD010L    | ACCORD CG CK CH 1997-2003              | LEFT FRONT LOWER                        | \$92  |
| TCAHD010R    | ACCORD CG CK CH 1997-2003              | RIGHT FRONT LOWER                       | \$92  |
| TCAHD013L    | JAZZ GD 10/2002 - 09/2008              | LEFT FRONT LOWER                        | \$97  |
| TCAHD013R    | JAZZ GD 10/2002 - 09/2008              | RIGHT FRONT LOWER                       | \$97  |
| TCAHD014L    | JAZZ GE 10/2008 - 06/2014              | LEFT FRONT LOWER                        | \$110 |
| TCAHD014R    | JAZZ GE 10/2008 - 06/2014              | RIGHT FRONT LOWER                       | \$110 |
| TCAHD002L    | CIVIC/HYBRID ES EU 10/00 - 01/06       | LEFT FRONT LOWER                        | \$101 |
| TCAHD002R    | INTEGRA DC5 09/01 - 09/04              | RIGHT FRONT LOWER                       | \$101 |
| TCAHD015L    | CIVIC/HYBRID FD FD1 FD2 02/2006 - 2011 | LEFT FRONT LOWER                        | \$117 |

|                   |   |  |              |
|-------------------|---|--|--------------|
| <b>TCAHD015R</b>  | CIVIC/HYBRID FD FD1 FD2 02/2006 - 2011      | RIGHT FRONT LOWER                        | <b>\$117</b> |
| <b>TCAHD017L</b>  | CIVIC FN 06/2007 - 01/2012                  | LEFT FRONT LOWER                         | <b>\$186</b> |
| <b>TCAHD017R</b>  | CIVIC FN 06/2007 - 01/2012                  | RIGHT FRONT LOWER                        | <b>\$186</b> |
| <b>TCAHD012L</b>  | ODYSSEY RB 2004-2008                        | LEFT FRONT LOWER                         | <b>\$154</b> |
| <b>TCAHD012R</b>  | ODYSSEY RB 2004-2008                        | RIGHT FRONT LOWER                        | <b>\$154</b> |
| <b>TCAHD020L</b>  | ODYSSEY RB 06/2004-08/2013                  | LEFT                                     | <b>\$136</b> |
| <b>TCAHD020R</b>  | ODYSSEY RB 06/2004-08/2013                  | RIGHT                                    | <b>\$136</b> |
| <b>HOLDEN</b>     |   |  |              |
| <b>TCADW001L</b>  | BARINA TK SEDAN 04/06 - 09/12               | LEFT FRONT LOWER                         | <b>\$94</b>  |
| <b>TCADW001R</b>  | BARINA TK HATCHBACK 12/05 - 09/12           | RIGHT FRONT LOWER                        | <b>\$94</b>  |
| <b>TCAHLN001</b>  | COMMODORE VT (SERIES 1 ONLY)                | FRONT LOWER WITH BALL JOINTS (Pair)      | <b>\$144</b> |
| <b>TCAHLN002</b>  | COMMODORE SERIES 2 VT VU VX VY VZ 1997-2006 | LOWER FRONT (Pair)                       | <b>\$144</b> |
| <b>TCAHLN003</b>  | COMMODORE VE 2006-2013                      | FRONT LOWER REAR (1 Pair - Curved Type)  | <b>\$192</b> |
| <b>TCAHLN004</b>  | COMMODORE VE 2006-2013                      | FRONT LOWER FRONT (1 Pair - Curved Type) | <b>\$194</b> |
| <b>TCAHLN005L</b> | CAPTIVA 5 7 CG 2006 on                      | LEFT FRONT LOWER                         | <b>\$158</b> |
| <b>TCAHLN005R</b> | CAPTIVA 5 7 CG 2006 on                      | RIGHT FRONT LOWER                        | <b>\$158</b> |
| <b>TCAHLN006</b>  | COLORADO 2011 on                            | UPPER ADJUSTABLE (1 Pair)                | <b>\$319</b> |
| <b>TCAHLN007L</b> | RODEO RA; COLORADO RC 2WD 2003-2012         | LEFT FRONT UPPER                         | <b>\$91</b>  |
| <b>TCAHLN007R</b> | RODEO RA; COLORADO RC 2WD 2003-2012         | RIGHT FRONT UPPER                        | <b>\$91</b>  |
| <b>TCAHLN008L</b> | RODEO RA; COLORADO RC 4WD 2003-2012         | LEFT FRONT UPPER                         | <b>\$127</b> |
| <b>TCAHLN008R</b> | RODEO RA; COLORADO RC 4WD 2003-2012         | RIGHT FRONT UPPER                        | <b>\$127</b> |
| <b>TCAHLN009L</b> | RODEO RA; COLORADO RC 2WD 2003-2012         | LEFT FRONT LOWER                         | <b>\$141</b> |
| <b>TCAHLN009R</b> | RODEO RA; COLORADO RC 2WD 2003-2012         | RIGHT FRONT LOWER                        | <b>\$141</b> |
| <b>TCAHLN010L</b> | RODEO RA; COLORADO RC 2WD 2003-2012         | LEFT FRONT LOWER                         | <b>\$159</b> |
| <b>TCAHLN010R</b> | RODEO RA COLORADO RC 4WD 2003-2012          | RIGHT FRONT LOWER                        | <b>\$159</b> |
| <b>TCAHLN011L</b> | RODEO TF 1997-2003 4WD                      | LEFT FRONT UPPER                         | <b>\$114</b> |
| <b>TCAHLN011R</b> | RODEO TF 1997-2003 4WD                      | RIGHT FRONT UPPER                        | <b>\$114</b> |
| <b>TCAHLN012L</b> | VIVA JF 10/2005 on                          | LEFT FRONT LOWER                         | <b>\$99</b>  |
| <b>TCAHLN012R</b> | VIVA JF 10/2005 on                          | RIGHT FRONT LOWER                        | <b>\$99</b>  |
| <b>TCAHLN014L</b> | COLORADO RG 4WD 2012 on                     | LEFT FRONT LOWER                         | <b>\$181</b> |
| <b>TCAHLN014R</b> | COLORADO RG 4WD 2012 on                     | RIGHT FRONT LOWER                        | <b>\$181</b> |
| <b>TCAHLN015L</b> | COLORADO RG 4WD 2012 on                     | LEFT FRONT UPPER                         | <b>\$123</b> |
| <b>TCAHLN015R</b> | COLORADO RG 4WD 2012 on                     | RIGHT FRONT UPPER                        | <b>\$123</b> |
| <b>HYUNDAI</b>    |   |  |              |
| <b>TCAHY001L</b>  | ILOAD iMAX TQ 2008 On                       | LEFT FRONT LOWER BALL JOINT              | <b>\$135</b> |
| <b>TCAHY001R</b>  | ILOAD iMAX TQ 2008 On                       | RIGHT FRONT LOWER BALL JOINT             | <b>\$135</b> |
| <b>TCAHY002L</b>  | ELANTRA XD 11/00 - 07/06;                   | LEFT FRONT LOWER                         | <b>\$100</b> |
| <b>TCAHY002R</b>  | TIBURON GK 03/02 - 01/07                    | RIGHT FRONT LOWER                        | <b>\$100</b> |
| <b>TCAHY009L</b>  | ELANTRA HD 08/06-02/11                      | LEFT FRONT LOWER                         | <b>\$100</b> |
| <b>TCAHY009R</b>  | i30 FD 03/07-04/12                          | RIGHT FRONT LOWER                        | <b>\$100</b> |
| <b>TCAHY010L</b>  | ELANTRA MD 03/11-11/15                      | LEFT FRONT LOWER                         | <b>\$114</b> |

|              |   |                              |       |
|--------------|---|------------------------------|-------|
| TCAHY010R    | VELOSTER FS COUPE 11/12 on              | RIGHT FRONT LOWER            | \$114 |
| TCAHY004L    | SONATA NF 06/05-11/14                   | LEFT FRONT LOWER             | \$163 |
| TCAHY004R    | GRANDEUR TG 10/05 on                    | RIGHT FRONT LOWER            | \$163 |
| TCAHY005L    | TUSCON JM 08/2004-2010                  | LEFT FRONT LOWER             | \$125 |
| TCAHY005R    | TUSCON JM 08/2004-2010                  | RIGHT FRONT LOWER            | \$125 |
| TCAHY006L    | IX35 LM 02/2010-2015                    | LEFT FRONT LOWER             | \$132 |
| TCAHY006R    | IX35 LM 02/2010-2015                    | RIGHT FRONT LOWER            | \$132 |
| TCAHY007L    | ACCENT MC 05/2006-12/2009               | LEFT FRONT LOWER             | \$110 |
| TCAHY007R    | ACCENT MC 05/2006-12/2009               | RIGHT FRONT LOWER            | \$110 |
| TCAHY013L    | ACCENT RB 07/2011 on                    | LEFT FRONT LOWER             | \$98  |
| TCAHY013R    | ACCENT RB 07/2011 on                    | RIGHT FRONT LOWER            | \$98  |
| TCAHY014L    | SANTAFE SM 09/2000-04/2006              | LEFT FRONT LOWER             | \$112 |
| TCAHY014R    | SANTAFE SM 09/2000-04/2006              | RIGHT FRONT LOWER            | \$112 |
| TCAHY008L    | SANTA FE CM 05/2006-07/2012             | LEFT FRONT LOWER             | \$115 |
| TCAHY008R    | SANTA FE CM 05/2006-07/2012             | RIGHT FRONT LOWER            | \$115 |
| TCAHY011L    | GETZ TB 09/2002-2011                    | LEFT FRONT LOWER             | \$100 |
| TCAHY011R    | GETZ TB 09/2002-2011                    | RIGHT FRONT LOWER            | \$100 |
| <b>ISUZU</b> |   |                              |       |
| TCAHLN006    | DMAX MUX 2011 on                        | UPPERS - ADJUSTABLE (1 pair) | \$319 |
| TCAHLN007L   | DMAX TFR 2WD 2008-2012                  | LEFT FRONT UPPER             | \$91  |
| TCAHLN007R   | DMAX TFR 2WD 2008-2012                  | RIGHT FRONT UPPER            | \$91  |
| TCAHLN008L   | DMAX TFR 4WD 2008-2012                  | LEFT FRONT UPPER             | \$127 |
| TCAHLN008R   | DMAX TFR 4WD 2008-2012                  | RIGHT FRONT UPPER            | \$127 |
| TCAHLN009L   | DMAX TFR 2WD 2008-2012                  | LEFT FRONT LOWER             | \$141 |
| TCAHLN009R   | DMAX TFR 2WD 2008-2012                  | RIGHT FRONT LOWER            | \$141 |
| TCAHLN010L   | DMAX TFR 4WD 2008-2012                  | LEFT FRONT LOWER             | \$159 |
| TCAHLN010R   | DMAX TFR 4WD 2008-2012                  | RIGHT FRONT LOWER            | \$159 |
| TCAHLN014L   | DMAX TFS 4WD 2012 on                    | LEFT FRONT LOWER             | \$181 |
| TCAHLN014R   | DMAX TFS 4WD 2012 on                    | RIGHT FRONT LOWER            | \$181 |
| TCAHLN015L   | DMAX TFS 4WD 2012 on                    | LEFT FRONT UPPER             | \$123 |
| TCAHLN015R   | DMAX TFS 4WD 2012 on                    | RIGHT FRONT UPPER            | \$123 |
| <b>JEEP</b>  |   |                              |       |
| TCAJP008N    | GRAND CHEROKEE WJ/WG 1999 - 2005        | FRONT UPPER L/R              | \$88  |
| TCAJP009N    | GRAND CHEROKEE WJ/WG 1999 - 2005        | FRONT LOWER L/R              | \$91  |
| TCAJP001L    | GRAND CHEROKEE WH 06/05-01/11           | LEFT FRONT LOWER             | \$304 |
| TCAJP001R    | COMMANDER XH 05/2006 on                 | RIGHT FRONT LOWER            | \$304 |
| TCAJP002N    | GRAND CHEROKEE WH 2005-2011             | FRONT UPPER BALL JOINTS L/R  | \$106 |
| TCAJP003     | GRAND CHEROKEE WH COMMANDER XH 05/06 on | REAR LOWER L/R               | \$75  |
| TCAJP004     | GRAND CHEROKEE WH COMMANDER XH 05/06 on | REAR UPPER L/R               | \$79  |
| TCAJP015L    | GRAND CHEROKEE WK 10/2010-01/2016       | LEFT FRONT UPPER             | \$124 |
| TCAJP015R    | GRAND CHEROKEE WK 10/2010-01/2016       | RIGHT FRONT UPPER            | \$124 |



|                  |  |                             |       |
|------------------|--|-----------------------------|-------|
| TCAJP021L        | GRAND CHEROKEE WK 10/2010-01/2016  | LEFT FRONT LOWER            | \$245 |
| TCAJP021R        | GRAND CHEROKEE WK 10/2010-01/2016  | RIGHT FRONT LOWER           | \$245 |
| TCAJP005         | CHEROKEE KJ 10/2001 - 01/2008  | FRONT UPPER BALL JOINTS L/R | \$333 |
| TCAJP006N        | CHEROKEE KJ 09/2001-01/2008  | CENTRE REAR UPPER           | \$166 |
| TCAJP010N        | CHEROKEE XJ 94-01; GRAND CHEROKEE ZG 96-05/99<br>WRANGLER TJ 10/96-02/07 | FRONT UPPER LH/RH           | \$69  |
| TCAJP011N        | CHEROKEE XJ 94-01  | FRONT LOWER LH/RH           | \$69  |
| TCAJP011N        | WRANGLER TJ 10/96-02/07  | FRONT& REAR LOWER LH/RH     | \$69  |
| TCAJP012N        | CHEROKEE XJ 94-01; GRAND CHEROKEE ZG 96-05/99<br>WRANGLER TJ 10/96-02/07 | REAR UPPER LH/RH            | \$80  |
| TCAJP013L        | CHEROKEE KJ 10/2001-01/2008  | LEFT FRONT LOWER            | \$236 |
| TCAJP013R        | CHEROKEE KJ 10/2001-01/2008  | RIGHT FRONT LOWER           | \$236 |
| TCAJP017N        | CHEROKEE XJ 1994-2001; GRAND CHEROKEE ZG 1996-05/1999                    | REAR LOWER L/R              | \$76  |
| TCAJP018N        | CHEROKEE KJ 09/2001-01/2008  | REAR LOWER LH/RH            | \$85  |
| TCAJP019L        | JEEP CHEROKEE KK 02/2008-12/2012   | LEFT FRONT UPPER            | \$136 |
| TCAJP019R        | JEEP CHEROKEE KK 02/2008-12/2012   | RIGHT FRONT UPPER           | \$136 |
| TCAJP007L        | COMPASS MK 2007 on; PATRIOT MK 03/2007 on                                | LEFT FRONT LOWER            | \$111 |
| TCAJP007R        | COMPASS MK 2007 on; PATRIOT MK 03/2007 on                                | RIGHT FRONT LOWER           | \$111 |
| TCAJP014N        | JEEP WRANGLER JK 2007 on   | FRONT UPPER LH/RH           | \$91  |
| TCAJP016N        | JEEP WRANGLER JK 2007 on   | FRONT LOWER LH/RH           | \$80  |
| <b>KIA</b>       |  |                             |       |
| TCAHY005L        | SPORTAGE KM 08/2004-04/2010  | LEFT FRONT LOWER            | \$125 |
| TCAHY005R        | SPORTAGE KM 08/2004-04/2010  | RIGHT FRONT LOWER           | \$125 |
| TCAHY006L        | SPORTAGE SL 05/2010-09/2015  | LEFT FRONT LOWER            | \$132 |
| TCAHY006R        | SPORTAGE SL 05/2010-09/2015  | RIGHT FRONT LOWER           | \$132 |
| TCAKI001L        | CERATO LD 07/2004-12/2008  | LEFT FRONT LOWER            | \$107 |
| TCAKI001R        | CERATO LD 07/2004-12/2008  | RIGHT FRONT LOWER           | \$107 |
| <b>LANDROVER</b> |  |                             |       |
| TCALR001L        | RANGE ROVER SPORT L320 08/2005-10/2013                                   | LEFT FRONT LOWER            | \$281 |
| TCALR001R        | RANGE ROVER SPORT L320 08/2005-10/2013                                   | RIGHT FRONT LOWER           | \$281 |
| TCALR004N        | RANGE ROVER L322 08/2002-09/2012   | FRONT LOWER L/R             | \$101 |
| TCALR005L        | DISCOVERY 3 04/2005-09/2009  | LEFT FRONT UPPER            | \$139 |
| TCALR005R        | DISCOVERY 4 10/2009-2013   | RIGHT FRONT UPPER           | \$139 |
| TCALR008L        | FREELANDER L359 06/2007-2015   | LEFT FRONT LOWER            | \$172 |
| TCALR008R        | FREELANDER L359 06/2007-2015   | RIGHT FRONT LOWER           | \$172 |
| <b>LEXUS</b>     |  |                             |       |
| TCALX001L        | LS460 USF40 4/07-1/13  | LEFT FRONT LOWER REAR       | \$149 |
| TCALX001R        | LS460 USF40 4/07-1/13  | RIGHT FRONT LOWER REAR      | \$149 |
| TCALX002L        | LS460 USF40 4/07-1/13  | LEFT FRONT UPPER FRONT      | \$88  |
| TCALX002R        | LS460 USF40 4/07-1/13  | RIGHT FRONT UPPER FRONT     | \$88  |
| TCALX003L        | LS460 USF40 4/07-1/13  | LEFT FRONT UPPER REAR       | \$93  |
| TCALX003R        | LS460 USF40 4/07-1/13  | RIGHT FRONT UPPER REAR      | \$93  |

|              |   |                                   |       |
|--------------|---|-----------------------------------|-------|
| TCATA008L    | ES300 MCV20R 08/1996-07/2001                      | LEFT FRONT LOWER                  | \$98  |
| TCATA008R    | ES300 MCV20R 08/1996-07/2001                      | RIGHT FRONT LOWER                 | \$98  |
| TCATA012L    | ES300 MCV30R 08/0-05; RX330/350 MCU28 02/03-12/08 | LEFT FRONT LOWER                  | \$96  |
| TCATA012R    | RX400H MHU38R 07on                                | RIGHT FRONT LOWER                 | \$96  |
| TCATA011L    | RX270/350/450H GGL/GYL 2009 - 05/2012             | LEFT FRONT LOWER                  | \$115 |
| TCATA011R    | RX270/350/450H GGL/GYL 2009 - 05/2012             | RIGHT FRONT LOWER                 | \$115 |
| TCATA026L    | LX470 UZJ100 04/1998-07/2007                      | LEFT FRONT UPPER                  | \$106 |
| TCATA026R    | LX470 UZJ100 04/1998-07/2007                      | RIGHT FRONT UPPER                 | \$106 |
| TCATA014L    | LX570 URJ201R 11/2007-12/2011                     | LEFT FRONT UPPER                  | \$90  |
| TCATA014R    | LX570 URJ201R 11/2007-12/2011                     | RIGHT FRONT UPPER                 | \$90  |
| TCATA027L    | LX570 URJ201R 11/2007-12/2011                     | LEFT FRONT LOWER                  | \$222 |
| TCATA027R    | LX570 URJ201R 11/2007-12/2011                     | RIGHT FRONT LOWER                 | \$222 |
| <b>MAZDA</b> |   |                                   |       |
| TCAMA001     | MAZDA 3 BK 2004-2008                              | LOWER FRONT (1 Pair)              | \$224 |
| TCAMA0010N   | MAZDA 3 BK 01/2004-12/2008                        | REAR UPPER LH/RH                  | \$61  |
| TCAMA0011N   | MAZDA 3 BK 01/2004-12/2008                        | REAR LOWER (LATERAL) LH/RH        | \$50  |
| TCAMA002L    | BT50 UTE 06-11; B2500 B-Series UN 98-06           | LEFT UPPER FRONT                  | \$128 |
| TCAMA002R    | BRAVO 98-06; FIGHTER 98-06                        | RIGHT UPPER FRONT                 | \$128 |
| TCAMA003N    | MAXDA 6 2002-2008 GG                              | FRONT LOWER ARMS L/R              | \$93  |
| TCAMA004L    | MAZDA 6 GG GY 2002-2007                           | LEFT FRONT LOWER CASTOR ARM       | \$88  |
| TCAMA004R    | Mazda 6 GG GY 2002-2007                           | TIGHT FRONT LOWER CASTOR ARM      | \$88  |
| TCAMA012L    | MAZDA 6 GG 08/2002-11/2007                        | LEFT FRONT UPPER                  | \$94  |
| TCAMA012R    | MAZDA 6 GG 08/2002-11/2007                        | RIGHT FRONT UPPER                 | \$94  |
| TCAMA014N    | MAZDA 6 GG 08/2002-11/2007                        | REAR UPPER LH/RH                  | \$76  |
| TCAMA006L    | MAZDA 6 GH 12/2007-11/2012                        | LEFT FRONT LOWER                  | \$222 |
| TCAMA006R    | MAZDA 6 GH 12/2007-11/2012                        | RIGHT FRONT LOWER                 | \$222 |
| TCAMA016L    | MAZDA 6 GH 12/2007-11/2012                        | LEFT FRONT LOWER                  | \$88  |
| TCAMA016R    | MAZDA 6 GH 12/2007-11/2012                        | RIGHT FRONT LOWER                 | \$88  |
| TCAMA007L    | MAZDA CX5 CX-5 KE 2012-03/17                      | LEFT FRONT LOWER WITH BALL JOINT  | \$141 |
| TCAMA007R    | MAZDA CX5 CX-5 KE 2012-03/17                      | RIGHT FRONT LOWER WITH BALL JOINT | \$141 |
| TCAMA008L    | MAZDA CX-7 ER 11/200- 01/2012                     | LEFT FRONT LOWER                  | \$153 |
| TCAMA008R    | MAZDA CX-7 ER 11/200- 01/2012                     | RIGHT FRONT LOWER                 | \$153 |
| TCAMA009L    | MAZDA CX-9 TB SERIES 1/2/3 10/2007-06/2016        | LEFT FRONT LOWER                  | \$164 |
| TCAMA009R    | MAZDA CX-9 TB SERIES 1/2/3 10/2007-06/2016        | RIGHT FRONT LOWER                 | \$164 |
| TCAFD016L    | MAZDA 2 DY 10/2002-05/2007                        | LEFT FRONT LOWER                  | \$141 |
| TCAFD016R    | MAZDA 2 DY 10/2002-05/2007                        | RIGHT FRONT LOWER                 | \$141 |
| TCAMA015L    | MAZDA 2 DE 06/2007-08/2014                        | LEFT FRONT LOWER                  | \$106 |
| TCAMA015R    | MAZDA 2 DE 06/2007-08/2014                        | RIGHT FRONT LOWER                 | \$106 |
| TCAFD004L    | MAZDA 323 BJ 1998-2003                            | LEFT FRONT LOWER                  | \$94  |
| TCAFD004R    | PREMACY CP 2000-2003                              | RIGHT FRONT LOWER                 | \$94  |
| TCAMA017L    | MAZDA TRIBUTE 03/2001 on                          | LEFT FRONT LOWER                  | \$129 |

|                   |  |                         |       |
|-------------------|--|-------------------------|-------|
| TCAMA017R         | MAZDA TRIBUTE 03/2001 on                           | RIGHT FRONT LOWER       | \$129 |
| TCAMA018L         | MAZDA BT-50 4WD UN 11/2006-09/2011                 | LEFT FRONT LOWER        | \$154 |
| TCAMA018R         | MAZDA BT-50 4WD UN 11/2006-09/2011                 | RIGHT FRONT LOWER       | \$154 |
| TCAMA020L         | MAZDA BT-50 UR 10/2011-8/2015                      | LEFT FRONT LOWER        | \$168 |
| TCAMA020R         | MAZDA BT-50 UR 10/2011-8/2015                      | RIGHT FRONT LOWER       | \$168 |
| TCAMA019L         | MAZDA BT-50 UR/UP (4WD) 10/2011 on                 | LEFT FRONT UPPER        | \$88  |
| TCAMA019R         | MAZDA BT-50 UR/UP (4WD) 10/2011 on                 | RIGHT FRONT UPPER       | \$88  |
| <b>MERCEDES</b>   |  |                         |       |
| TCABEN001         | W203 S203 C230 C240 C280                           | FRONT UPPER L/R         | \$216 |
| TCABEN002         | A209 C209 W203 R171 2000-2011                      | FRONT LOWER L/R         | \$168 |
| TCABEN003L        | M/GL CLASS W164/X164 09/2005 on                    | LEFT FRONT LOWER        | \$291 |
| TCABEN003R        | M/GL CLASS W164/X164 09/2005 on                    | RIGHT FRONT LOWER       | \$291 |
| TCABEN006L        | M/GL CLASS W164/X164 09/2005 on                    | LEFT FRONT UPPER        | \$144 |
| TCABEN006R        | M/GL CLASS W164/X164 09/2005 on                    | RIGHT FRONT UPPER       | \$144 |
| TCABEN004L        | E-CLASS W211 01/2002-07/2009                       | LEFT FRONT LOWER FRONT  | \$135 |
| TCABEN004R        | E-CLASS W211 01/2002-07/2009                       | RIGHT FRONT LOWER FRONT | \$135 |
| TCABEN008L        | E-CLASS W211 01/2002-07/2009                       | LEFT FRONT LOWER REAR   | \$115 |
| TCABEN008R        | E-CLASS W211 01/2002-07/2009                       | RIGHT FRONT LOWER REAR  | \$115 |
| TCABEN005L        | C-CLASS W204 07/2007-04/2014                       | LEFT FRONT LOWER        | \$114 |
| TCABEN005R        | C-CLASS W204 07/2007-04/2014                       | RIGHT FRONT LOWER       | \$114 |
| TCABEN009L        | S-CLASS Sedan W220 10/1998-08/2005                 | LEFT FRONT LOWER        | \$137 |
| TCABEN009R        | S-CLASS Sedan W220 10/1998-08/2005                 | RIGHT FRONT LOWER       | \$137 |
| TCABEN010L        | S-CLASS Sedan W220 CL215 10/1998-08/2005           | LEFT FRONT LOWER        | \$132 |
| TCABEN010R        | S-CLASS Sedan W220 CL215 10/1998-08/2005           | RIGHT FRONT LOWER       | \$132 |
| <b>MITSUBISHI</b> |  |                         |       |
| TCAMB001          | TRITON MK 4WD 10/1996-06/2006                      | UPPER (1Pair)           | \$320 |
| TCAMB002L         | OUTLANDER ZG/ZH/ZJ 11/06-12/14;                    | LEFT FRONT LOWER        | \$106 |
| TCAMB002R         | ASX XA/XB/XC 08/10 on; LANCER SEDAN CJ/CF 09/07 on | RIGHT FRONT LOWER       | \$106 |
| TCAMB003L         | OUTLANDER ZE/ZF 02/2003-10/2006                    | LEFT FRONT LOWER        | \$106 |
| TCAMB003R         | OUTLANDER ZE/ZF 02/2003-10/2006                    | RIGHT FRONT LOWER       | \$106 |
| TCAMB004L         | PAJERO NM - NX 05/2000 on                          | LEFT FRONT UPPER        | \$104 |
| TCAMB004R         | PAJERO NM - NX 05/2000 on                          | RIGHT FRONT UPPER       | \$104 |
| TCAMB005L         | PAJERO NM/NP 05/2000-10/2006                       | LEFT FRONT LOWER        | \$168 |
| TCAMB005R         | PAJERO NM/NP 05/2000-10/2006                       | RIGHT FRONT LOWER       | \$168 |
| <b>NISSAN</b>     |  |                         |       |
| TCANS014L         | PULSAR N14 10/1991-09/1995                         | LEFT FRONT LOWER        | \$93  |
| TCANS014R         | PULSAR N14 10/1991-09/1995                         | RIGHT FRONT LOWER       | \$93  |
| TCANS001L         | PULSAR N16   | LEFT LOWER              | \$96  |
| TCANS001R         | PULSAR N16   | RIGHT LOWER             | \$96  |
| TCANS003L         | X-TRAIL T30 2000-2007                              | LEFT LOWER              | \$179 |
| TCANS003R         | X-TRAIL T30 2000-2007                              | RIGHT LOWER             | \$179 |



|                |   |  |       |
|----------------|---|--|-------|
| TCANS005L      | X-TRAIL T31 09/07-02/14; DUALIS J10 11/07-05/14 | X-TRAIL LEFT; DUALIS FRONT LOWER             | \$92  |
| TCANS005R      | X-TRAIL T31 09/07-02/14; DUALIS J10 11/07-05/14 | X-TRAIL RIGHT; DUALIS FRONT LOWER            | \$92  |
| TCANS010L      | X-TRAIL T32 03/2014 on                          | LEFT FRONT LOWER                             | \$101 |
| TCANS010R      | X-TRAIL T32 03/2014 on                          | RIGHT FRONT LOWER                            | \$101 |
| TCANS004L      | TILDA C11 02/06 on; CUBE Z11/Z12 02 on          | LEFT FRONT LOWER                             | \$85  |
| TCANS004R      | TILDA C11 02/06 on; CUBE Z11/Z12 02 on          | RIGHT FRONT LOWER                            | \$85  |
| TCANS006       | NAVARA D40 D23 NP300; PATHFINDER R51            | UPPERS (1 Pair) L/R                          | \$319 |
| TCANS011L      | NAVARA 4WD D22 04/1997-12/2015                  | LEFT FRONT LOWER                             | \$158 |
| TCANS011R      | NAVARA 4WD D22 04/1997-12/2015                  | RIGHT FRONT LOWER                            | \$158 |
| TCANS016L      | NAVARA 4WD D22 04/1997-12/2015                  | LEFT FRONT UPPER                             | \$102 |
| TCANS016R      | NAVARA 4WD D22 04/1997-12/2015                  | RIGHT FRONT UPPER                            | \$102 |
| TCANS012L      | NAVARA 2WD D22 04/1997-12/2015                  | LEFT FRONT UPPER                             | \$84  |
| TCANS012L      | NAVARA 2WD D22 04/1997-12/2015                  | RIGHT FRONT UPPER                            | \$84  |
| TCANS013L      | NAVARA 2WD D22 04/1997-12/2015                  | LEFT FRONT LOWER                             | \$110 |
| TCANS013R      | NAVARA 2WD D22 04/1997-12/2015                  | RIGHT FRONT LOWER                            | \$110 |
| TCANS024L      | NAVARA (THAI BUILD) D40 5 SPEED AUTO            | LEFT FRONT LOWER (THAI BUILT AUTO ONLY)      | \$144 |
| TCANS024R      | 07/2005-04/2015                                 | RIGHT FRONT LOWER (THAI BUILT AUTO ONLY)     | \$144 |
| TCANS022L      | NAVARA (THAI BUILD) D40 07/2005-04/2015         | LEFT FRONT UPPER (THAI BUILT ONLY)           | \$106 |
| TCANS022R      | NAVARA (THAI BUILD) D40 07/2005-04/2015         | RIGHT FRONT UPPER (THAI BUILT ONLY)          | \$106 |
| TCANS007L      | ALMERA N17 06/12 on; MICRA K13 11/10 on         | LEFT FRONT LOWER                             | \$97  |
| TCANS007R      | ALMERA N17 06/12 on; MICRA K13 11/10 on         | RIGHT FRONT LOWER                            | \$97  |
| TCANS017L      | NISSAN MAXIMA A33 12/1999-11/2003               | LEFT FRONT LOWER                             | \$126 |
| TCANS017R      | NISSAN MAXIMA A33 12/1999-11/2003               | RIGHT FRONT LOWER                            | \$126 |
| TCANS008L      | MAXIM J31 12/03-1/2009                          | LEFT LOWERS                                  | \$141 |
| TCANS008R      | MAXIM J31 12/03-1/2009                          | RIGHT LOWERS                                 | \$141 |
| TCANS009L      | NISSAN Maxima J32 2009 on                       | LEFT FRONT LOWER                             | \$198 |
| TCANS009R      | NISSAN Maxima J32 2009 on                       | RIGHT FRONT LOWER                            | \$198 |
| TCANS018L      | 350Z Z33 02/2003-04/2007                        | LEFT FRONT LOWER FRONT (Depth Range 4mm-6mm) | \$120 |
| TCANS018R      | SKYLINE V35 06/2001-10/2006                     | R FRONT LOWER FRONT (Depth Range 4mm-6mm)    | \$120 |
| TCANS020L      | 350Z Z33 VQ35DE/HR 02/2003-2011                 | LEFT FRONT LOWER REAR (CURVE)                | \$158 |
| TCANS020R      | Skyline V35 06/2001-10/2006                     | RIGHT FRONT LOWER REAR (CURVE)               | \$158 |
| TCANS019L      | MURANO Z50 06/2005-09/2008                      | LEFT FRONT LOWER                             | \$154 |
| TCANS019R      | MURANO Z50 06/2005-09/2008                      | RIGHT FRONT LOWER                            | \$154 |
| TCANS023L      | PATHFINDER R50 11/1995-06/2005                  | LEFT FRONT LOWER                             | \$106 |
| TCANS023R      | ELGRAND E50 1997-2002                           | RIGHT FRONT LOWER                            | \$106 |
| TCANS025L      | ELGRAND E51 2002-2008                           | LEFT FRONT LOWER                             | \$162 |
| TCANS025R      | ELGRAND E51 2002-2008                           | RIGHT FRONT LOWER                            | \$162 |
| <b>PEUGEOT</b> |   |  |       |
| TCAPE001L      | 206 10/1999-09/2007                             | LEFT FRONT LOWER                             | \$99  |
| TCAPE001R      | 206 10/1999-09/2007                             | RIGHT FRONT LOWER                            | \$99  |
| TCAPE002L      | 307 T5/T6 12/2001-2007                          | LEFT FRONT LOWER                             | \$89  |

|                |  |                                  |       |
|----------------|--|----------------------------------|-------|
| TCAPE002R      | 307 T5/T6 12/2001-2007                                     | RIGHT FRONT LOWER                | \$89  |
| TCAMB002L      | 4007 11/2009 on; 4008 06/2012 on                           | LEFT FRONT LOWER                 | \$106 |
| TCAMB002R      | 4007 11/2009 on; 4008 06/2012 on                           | RIGHT FRONT LOWER                | \$106 |
| <b>PORSCHE</b> |  |                                  |       |
| TCAAU005N      | CAYENNE 03-08  | FRONT UPPER L/R                  | \$106 |
| TCAAU006L      | CAYENNE 03-08  | LEFT FRONT LOWER                 | \$202 |
| TCAAU006R      | CAYENNE 03-08  | RIGHT FRONT LOWER                | \$202 |
| <b>RENAULT</b> |  |                                  |       |
| TCANS004L      | KOLEOS H45 09/2008-10/2011                                 | LEFT FRONT LOWER                 | \$85  |
| TCANS004R      | KOLEOS H45 09/2008-10/2011                                 | RIGHT FRONT LOWER                | \$85  |
| <b>SKODA</b>   |  |                                  |       |
| TCAAU002L      | OCTAVIA 1Z 10/2007-10/2013(D)                              | LEFT FRONT LOWER                 | \$137 |
| TCAAU002R      | OCTAVIA 1Z 10/2007-10/2013(D)                              | RIGHT FRONT LOWER                | \$137 |
| <b>SUBARU</b>  |  |                                  |       |
| TCASB001L      | IMPREZA GE/GH GJ/GP 09/2007-10/2016                        | LEFT FRONT LOWER 455mm Distance  | \$123 |
| TCASB001R      | OUTBACK; LIBERTY BP BL                                     | RIGHT FRONT LOWER 455mm Distance | \$123 |
| TCASB002L      | FORESTER SH 2008-2012                                      | LEFT FRONT LOWER                 | \$123 |
| TCASB002R      | FORESTER SH 2008-2012                                      | RIGHT FRONT LOWER                | \$123 |
| TCASB005L      | SUBARU FORESTER SJ 01/2013 on                              | LEFT FRONT LOWER                 | \$163 |
| TCASB005R      | SUBARU FORESTER SJ 01/2013 on                              | RIGHT FRONT LOWER                | \$163 |
| TCASB003L-WS   | IMPREZA GE/GH GJ/GP 09/2007-10/2016                        | LEFT FRONT LOWER 480mm           | \$150 |
| TCASB003R-WS   | OUTBACK, LIBERT BP BL 2002-2009                            | RIGHT FRONT LOWER 480mm          | \$150 |
| TCASB004L      | OUTBACK, LIBERTY BM/BR 2009-2014                           | LEFT FRONT LOWER                 | \$136 |
| TCASB004R      | OUTBACK, LIBERTY BM/BR 2009-2014                           | RIGHT FRONT LOWER                | \$136 |
| <b>SUZUKI</b>  |  |                                  |       |
| TCASU001L      | GRAND VITARA SQ416 04/1998-07/2005                         | LEFT FRONT LOWER                 | \$181 |
| TCASU001R      | GRAND VITARA SQ416 04/1998-07/2005                         | RIGHT FRONT LOWER                | \$181 |
| TCASU002L      | GRAND VITARA JB420 08/2005 on                              | LEFT FRONT LOWER                 | \$115 |
| TCASU002R      | GRAND VITARA JB420 08/2005 on                              | RIGHT FRONT LOWER                | \$115 |
| <b>TOYOTA</b>  |  |                                  |       |
| TCATA001L      | HiLUX 4WD KUN/TGN/GGN 2005 on                              | LEFT UPPER                       | \$125 |
| TCATA001R      | HiLUX 4WD KUN/TGN/GGN 2005 on                              | RIGHT UPPER                      | \$125 |
| TCATA002L      | HiLUX 4WD KUN/TGN/GGN 2005 on                              | LEFT FRONT LOWER                 | \$120 |
| TCATA002R      | HiLUX 4WD KUN/TGN/GGN 2005 on                              | RIGHT FRONT LOWER                | \$120 |
| TCATA015L      | HiLUX RN85 10/1989-09/1997                                 | LEFT FRONT LOWER                 | \$70  |
| TCATA015R      | HiLUX RN85 10/1989-09/1997                                 | RIGHT FRONT LOWER                | \$70  |
| TCATA016N      | HiLUX 2WD RN85 1989-1997<br>RN14#/LN16# SERIES 10/97-03/05 | FRONT UPPER LH/RH                | \$201 |
| TCATA017L      | HiLUX 4WD RN14#/LN16# SERIES 10/1997-03/2005               | LEFT FRONT UPPER                 | \$126 |
| TCATA017R      | HiLUX 4WD RN14#/LN16# SERIES 10/1997-03/2005               | RIGHT FRONT UPPER                | \$126 |
| TCATA018L      | HiLUX 2WD TGN/KUN/GGN 04/2005-06/2015                      | LEFT FRONT UPPER                 | \$109 |

|           |  |   |       |
|-----------|--|---|-------|
| TCATA018R | HILUX 2WD TGN/KUN/GGN 04/2005-06/2015              | RIGHT FRONT UPPER                               | \$109 |
| TCATA019L | HiLUX 2WD TGN/KUN/GGN 04/2005on                    | LEFT FRONT LOWER                                | \$126 |
| TCATA019R | HiLUX 2WD TGN/KUN/GGN 04/2005on                    | RIGHT FRONT LOWER                               | \$126 |
| TCATA003L | ECHO NCP10 10/1999- 04/2003                        | LEFT FRONT LOWER 12.2mm Bushing inner diameter  | \$98  |
| TCATA003R | ECHO NCP10 10/1999- 04/2003                        | RIGHT FRONT LOWER 12.2mm Bushing inner diameter | \$98  |
| TCATA004L | HiACE RZH 09/98-02/05; HiACE SBV RCH 10/95-11/03   | LEFT UPPER                                      | \$141 |
| TCATA004R | REGIUS KCH40/RCH41 04/97-05/02                     | RIGHT UPPER                                     | \$141 |
| TCATA009L | HiACE TRH KDH 03/2005 on                           | LEFT FRONT UPPER                                | \$123 |
| TCATA009R | HiACE TRH KDH 03/2005 on                           | RIGHT FRONT UPPER                               | \$123 |
| TCATA022L | HiACE TRH/KDH 03/2005 on                           | LEFT FRONT LOWER                                | \$84  |
| TCATA022R | HiACE TRH/KDH 03/2005 on                           | RIGHT FRONT LOWER                               | \$84  |
| TCATA005L | PRADO 90 95 LJ90 RZJ90 KZJ95 1996-03 (OEM)TY104701 | LEFT FRONT LOWER                                | \$123 |
| TCATA005R | PRADO 90 95 LJ90 RZJ90 KZJ95 1996-03               | RIGHT FRONT LOWER                               | \$123 |
| TCATA006L | LANDCRUISER; PRADO 90 95 1996-2003                 | LEFT FRONT UPPER                                | \$83  |
| TCATA006R | LANDCRUISER; PRADO 90 95 1996-2003                 | RIGHT FRONT UPPER                               | \$83  |
| TCATA010L | PRADO 120 Series 02/2003-10/2009                   | LEFT FRONT LOWER                                | \$142 |
| TCATA010R | PRADO 120 Series 02/2003-10/2009                   | RIGHT FRONT LOWER                               | \$142 |
| TCATA023L | PRADO J120 J150 11/2009 on                         | LEFT FRONT UPPER                                | \$126 |
| TCATA023R | PRADO J120 J150 11/2009 on                         | RIGHT FRONT UPPER                               | \$126 |
| TCATA007L | COROLLA ZZE122 12/01-04/07                         | LEFT FRONT LOWER                                | \$93  |
| TCATA007R | CELICA ZTZ231 12/99-2005                           | RIGHT FRONT LOWER                               | \$93  |
| TCATA008L | CAMRY SDV10 SK20 1993-2002;                        | LEFT FRONT LOWER                                | \$98  |
| TCATA008R | AVALON MCX10 04/00-09/03                           | RIGHT FRONT LOWER                               | \$98  |
| TCATA013L | CAMRY ACV36 MCV36 09/02-06/06                      | LEFT FRONT LOWER                                | \$88  |
| TCATA013R | AVALON MCX10 10/03-03/06                           | RIGHT FRONT LOWER                               | \$88  |
| TCATA012L | CAMRY ACV40R ACV50R 07/2006 on                     | LEFT FRONT LOWER                                | \$96  |
| TCATA012R | AURION GSV40/50 10/06-17                           | RIGHT FRONT LOWER                               | \$96  |
| TCATA012L | KLUGER MCU28 10/03-07/07                           | LEFT FRONT LOWER                                | \$96  |
| TCATA012R | TARAGO ACR30 06/00-02/06                           | RIGHT FRONT LOWER                               | \$96  |
| TCATA011L | KLUGER GSU40/45 08/2007-02/2014                    | LEFT FRONT LOWER                                | \$115 |
| TCATA011R | KLUGER GSU40/45 08/2007-02/2014                    | RIGHT FRONT LOWER                               | \$115 |
| TCATA014L | LANDCRUISER 200 SERIES 08/2007 on                  | LEFT FRONT UPPER                                | \$90  |
| TCATA014R | LANDCRUISER 200 SERIES 08/2007 on                  | RIGHT FRONT UPPER                               | \$90  |
| TCATA020L | RAV4 ACA30 SERIES 01/2006-11/2012                  | LEFT FRONT LOWER                                | \$105 |
| TCATA020R | TARAGO ACR50 03/2006 on                            | RIGHT FRONT LOWER                               | \$105 |
| TCATA025L | AVENSIS ACM20/ACM21 10/2001-2010                   | LEFT FRONT LOWER                                | \$108 |
| TCATA025R | AVENSIS ACM20/ACM21 10/2001-2010                   | RIGHT FRONT LOWER                               | \$108 |
| TCATA026L | LANDCRUISER 100 SERIES 04/1998-07/2007             | LEFT FRONT UPPER                                | \$106 |
| TCATA026R | LANDCRUISER 100 SERIES 04/1998-07/2007             | RIGHT FRONT UPPER                               | \$106 |
| TCATA027L | LANDCRUISER 200 SERIES 08/2007 on                  | LEFT FRONT LOWER                                | \$222 |
| TCATA027R | LANDCRUISER 200 SERIES 08/2007 on                  | RIGHT FRONT LOWER                               | \$222 |



|              |   |  |       |
|--------------|---|--|-------|
| TCATA029L    | YARIS NCP90 HATCHBACK/SEDAN 01/06 on          | LEFT FRONT LOWER                             | \$103 |
| TCATA029R    | YARIS NCP130 11/11 on; PRIUS C NHP10 03/12 on | RIGHT FRONT LOWER                            | \$103 |
| <b>VOLVO</b> |   |  |       |
| TCAFD012L    | S40/V50 03/2004 on; C70 08/2006-2013          | LEFT FRONT LOWER TAPER DIAMETER 18mm         | \$137 |
| TCAFD012R    | S40/V50 03/2004 on; C70 08/2006-2013          | RIGHT FRONT LOWER TAPER DIAMETER 18mm        | \$137 |
| TCAFD013L    | S40/V50 03/2004 on; C70 08/2006-2013          | LEFT FRONT LOWER TAPER DIAMETER 15mm         | \$137 |
| TCAFD013R    | S40/V50 03/2004 on; C70 08/2006-2013          | RIGHT FRONT LOWER TAPER DIAMETER 15mm        | \$137 |
| TCAVOL001L   | S60 11/2000-11/2010                           | LEFT FRONT LOWER                             | \$158 |
| TCAVOL001R   | LAST 6 DIGIT CHASSIS NUMBER/626501            | RIGHT FRONT LOWER                            | \$158 |
| TCAVOL002L   | VOLVO S70/C70/V700 4/1997-2000; 850           | LEFT FRONT LOWER                             | \$104 |
| TCAVOL002R   | VOLVO S70/C70/V700 4/1997-2000; 850           | RIGHT FRONT LOWER                            | \$104 |
| TCAVOL003L   | XC70/CROSS COUNTRY 4/2003-11/2007             | LEFT FRONT LOWER                             | \$174 |
| TCAVOL003R   | XC70/CROSS COUNTRY 4/2003-11/2007             | RIGHT FRONT LOWER                            | \$174 |
| <b>VW</b>    |   |  |       |
| TCAVW001L    | GOLF 4 1998-2004; BORA 1J 12/99 on            | LEFT FRONT LOWER L=R (Ball Joint Different)  | \$106 |
| TCAVW001R    | BEETLE 9C 12/99-09/05                         | RIGHT FRONT LOWER L=R (Ball Joint Different) | \$106 |
| TCAVW002L    | GOLF MK5 07/2004-09/2008 (PETROL)             | LEFT FRONT LOWER                             | \$138 |
| TCAVW002R    | GOLF MK5 07/2004-09/2008 (PETROL)             | RIGHT FRONT LOWER                            | \$138 |
| TCAAU002L    | GOLF 5 6 07/04-07/13; CADDY 2K 02/05-07/10;   | LEFT FRONT LOWER (DIESEL)                    | \$137 |
| TCAAU002R    | EOS 1F 02/07 on; JETTA 1K 02/06-07/11         | RIGHT FRONT LOWER (DIESEL)                   | \$137 |
| TCAAU005N    | TOUREG 2004 - 2010                            | FRONT UPPER L/R                              | \$106 |
| TCAAU006L    | TOUREG 2004 - 2010                            | LEFT FRONT LOWER                             | \$202 |
| TCAAU006R    | TOUREG 2004 - 2010                            | RIGHT FRONT LOWER                            | \$202 |
| TCAAU010L    | PASSAT GP 05/2001-06/2005                     | LEFT FRONT UPPER FRONT TORQUE ARM            | \$68  |
| TCAAU010R    | PASSAT GP 05/2001-06/2005                     | RIGHT FRONT UPPER FRONT TORQUE ARM           | \$68  |
| TCAAU015L    | PASSAT B6 3C 07/05-05/15; 3CC 08/08-01/12     | LEFT FRONT LOWER                             | \$181 |
| TCAAU015R    | TIGUAN 5N 05/08-16                            | RIGHT FRONT LOWER                            | \$181 |
| TCAAU017N    | PASSAT B5 02/1998-04/2001                     | LOWER FRONT L/R (TAPER:20mm)                 | \$102 |
| TCAVW003L    | AMAROK 2H 01/2012 on                          | LEFT FRONT UPPER                             | \$143 |
| TCAVW003R    | AMAROK 2H 01/2012 on                          | RIGHT FRONT UPPER                            | \$143 |

# GOLD CERAMIC PADS by HONG SUNG

|         |         |         |         |         |         |          |  |
|---------|---------|---------|---------|---------|---------|----------|--|
| HDB2    | HDB1205 | HDB1302 | HDB1422 | HDB1516 | HDB1763 | HDB1865  | HDB2243  |
| HDB300  | HDB1206 | HDB1308 | HDB1424 | HDB1517 | HDB1765 | HDB1913  | HDB2268  |
| HDB308  | HDB1208 | HDB1311 | HDB1425 | HDB1518 | HDB1766 | HDB1914  | HDB2272  |
| HDB388  | HDB1209 | HDB1312 | HDB1426 | HDB1519 | HDB1772 | HDB1916  | 7690   |
| HDB422  | HDB1210 | HDB1323 | HDB1429 | HDB1521 | HDB1774 | HDB1919  |  |
| HDB425  | HDB1213 | HDB1328 | HDB1431 | HDB1660 | HDB1785 | HDB1920  | <b>SHADED<br/>NUMBERS<br/>ARE<br/>THE<br/>MOST<br/>POPULAR</b> |
| HDB437  | HDB1215 | HDB1331 | HDB1432 | HDB1662 | HDB1786 | HDB1923  |  |
| HDB442  | HDB1223 | HDB1332 | HDB1434 | HDB1665 | HDB1787 | HDB1924  |  |
| HDB1085 | HDB1224 | HDB1333 | HDB1441 | HDB1672 | HDB1789 | HDB1940  |  |
| HDB1086 | HDB1228 | HDB1335 | HDB1441 | HDB1673 | HDB1796 | HDB1941  |  |
| HDB1103 | HDB1230 | HDB1337 | HDB1449 | HDB1674 | HDB1800 | HDB1942  |  |
| HDB1108 | HDB1231 | HDB1338 | HDB1450 | HDB1678 | HDB1801 | HDB1943  |  |
| HDB1109 | HDB1232 | HDB1342 | HDB1451 | HDB1679 | HDB1802 | HDB1946  |  |
| HDB1110 | HDB1238 | HDB1345 | HDB1452 | HDB1680 | HDB1803 | HDB1953  |  |
| HDB1113 | HDB1239 | HDB1347 | HDB1454 | HDB1681 | HDB1805 | HDB1957  |  |
| HDB1116 | HDB1241 | HDB1350 | HDB1455 | HDB1682 | HDB1808 | HDB1985  |  |
| HDB1141 | HDB1245 | HDB1351 | HDB1462 | HDB1684 | HDB1814 | HDB1989  |  |
| HDB1142 | HDB1247 | HDB1358 | HDB1463 | HDB1686 | HDB1815 | HDB1990  |  |
| HDB1147 | HDB1249 | HDB1359 | HDB1464 | HDB1688 | HDB1816 | HDB1996  |  |
| HDB1149 | HDB1252 | HDB1362 | HDB1466 | HDB1689 | HDB1817 | HDB2002  |  |
| HDB1158 | HDB1254 | HDB1363 | HDB1468 | HDB1690 | HDB1818 | HDB2004  |  |
| HDB1159 | HDB1255 | HDB1365 | HDB1471 | HDB1696 | HDB1819 | HDB2005  |  |
| HDB1163 | HDB1258 | HDB1368 | HDB1472 | HDB1710 | HDB1820 | HDB2034  |  |
| HDB1164 | HDB1259 | HDB1370 | HDB1473 | HDB1713 | HDB1821 | HDB2035  |  |
| HDB1165 | HDB1261 | HDB1372 | HDB1474 | HDB1714 | HDB1830 | HDB2038  |  |
| HDB1166 | HDB1262 | HDB1375 | HDB1475 | HDB1718 | HDB1832 | HDB2039  |  |
| HDB1167 | HDB1265 | HDB1376 | HDB1479 | HDB1722 | HDB1833 | HDB2047  |  |
| HDB1170 | HDB1267 | HDB1378 | HDB1481 | HDB1724 | HDB1835 | HDB2056  |  |
| HDB1177 | HDB1268 | HDB1379 | HDB1482 | HDB1725 | HDB1838 | HDB2072  |  |
| HDB1179 | HDB1270 | HDB1382 | HDB1484 | HDB1727 | HDB1841 | HDB2076  |  |
| HDB1185 | HDB1273 | HDB1383 | HDB1487 | HDB1728 | HDB1842 | HDB 2088 |  |
| HDB1186 | HDB1274 | HDB1384 | HDB1488 | HDB1739 | HDB1843 | HDB2089  |  |
| HDB1187 | HDB1275 | HDB1385 | HDB1489 | HDB1741 | HDB1847 | HDB2118  |  |
| HDB1191 | HDB1277 | HDB1388 | HDB1490 | HDB1745 | HDB1849 | HDB2159  |  |
| HDB1192 | HDB1278 | HDB1391 | HDB1491 | HDB1753 | HDB1850 | HDB2174  |  |
| HDB1199 | HDB1280 | HDB1393 | HDB1493 | HDB1754 | HDB1852 | HDB2177  |  |
| HDB1200 | HDB1284 | HDB1395 | HDB1503 | HDB1755 | HDB1854 | HDB2178  |  |
| HDB1203 | HDB1286 | HDB1403 | HDB1504 | HDB1757 | HDB1856 | HDB2212  |  |
| HDB1204 | HDB1291 | HDB1405 | HDB1510 | HDB1758 | HDB1857 | HDB2221  |  |
| HDB1205 | HDB1297 | HDB1410 | HDB1511 | HDB1760 | HDB1858 | HDB2226  |  |
| HDB1206 | HDB1298 | HDB1416 | HDB1515 | HDB1761 | HDB1862 | HDB2227  |  |



SINCE 1967

Turner Enterprises Pty Ltd

Sydney: Joe (02) 9905 0574

1800 819 033 Fax 9905 0591

SALES@TURNERENTERPRISES.COM.AU WWW.TURNERENTERPRISES.COM.AU



# CERAMIC PADS

## By Hong Sung

No Dust No Noise Longer Lifespan

OEM On Kia & Hyundai

Passenger Cars: \$30.00

4 X 4: \$33.00

PLUS GST



MADE IN KOREA

ONE YEAR WARRANTY

Phone For Best Prices On Rotors

Turners Stocks A Huge Range Of Brake Hardware Kits

