

Dimensions for *Martin* sheaves are listed in the following tables with QD bushings in place. The type of sheave shown below is indicated by a letter, and the construction is indicated by a number, as shown on facing page.

## QD Sheaves – 3V

1 Groove*										2 Grooves									
F = 0.6875										F = 1.0968									
Part Number	OD	PD	Type	Bush	Bush Max Bore	E *	K	L Length Thru Bore	M *	Wt. Less Bush	Part Number	Type	Bush	Bush Max Bore	E *	K	L Length Thru Bore	M *	Wt. Less Bush
1 3V 220 JA	2.20	2.15	E-1	JA	1.25	.5625	0.4375	1.0625	0.9375	0.7	2 3V 220 JA	E-1	JA	1.25	0.9688	0.4375	1.0625	0.9375	0.9
1 3V 235 JA	2.35	2.30	E-1	JA	1.25	0.5625	0.4375	1.0625	0.9375	0.8	2 3V 235 JA	E-1	JA	1.25	0.9688	0.4375	1.0625	0.9375	1.0
1 3V 250 JA	2.50	2.45	E-1	JA	1.25	0.5625	0.4375	1.0625	0.9375	0.8	2 3V 250 JA	E-1	JA	1.25	0.9688	0.4375	1.0625	0.9375	1.2
1 3V 265 JA	2.65	2.60	C-1	JA	1.25	0.375	0.125	1.0625	—	0.9	2 3V 265 JA	D-1	JA	1.25	0.375	0.125	1.0625	0.4063	1.3
1 3V 280 JA	2.80	2.75	C-1	JA	1.25	0.375	0.125	1.0625	—	0.9	2 3V 280 JA	D-1	JA	1.25	0.375	0.125	1.0625	0.4063	1.4
1 3V 300 JA	3	2.95	C-1	JA	1.25	0.375	0.125	1.0625	—	1.0	2 3V 300 JA	D-1	JA	1.25	0.375	0.125	1.0625	0.4063	1.6
1 3V 315 JA	3.15	3.10	C-1	JA	1.25	0.375	0.125	1.0625	—	1.0	2 3V 315 JA	D-1	JA	1.25	0.375	0.125	1.0625	0.4063	1.8
1 3V 335 JA	3.35	3.30	C-1	JA	1.25	0.375	0.125	1.0625	—	1.1	2 3V 335 SH	D-1	SH	1.6875	0.4219	0.1406	1.3125	0.2031	2.0
1 3V 365 SH	3.65	3.60	D-1	SH	1.6875	0.5625	—	1.3125	0.0625	1.3	2 3V 365 SH	D-1	SH	1.6875	0.4219	0.1406	1.3125	0.2031	2.4
1 3V 412 SH	4.12	4.07	D-1	SH	1.6875	0.5625	—	1.3125	0.0625	1.7	2 3V 412 SH	D-1	SH	1.6875	0.2813	0.2813	1.3125	0.0625	2.7
1 3V 450 SH	4.50	4.45	D-2	SH	1.6875	0.5625	—	1.3125	0.0625	2.1	2 3V 450 SH	D-1	SH	1.6875	0.25	0.3125	1.3125	0.0313	2.9
1 3V 475 SH	4.75	4.70	D-2	SH	1.6875	0.5625	—	1.3125	0.0625	2.5	2 3V 475 SH	D-1	SH	1.6875	0.25	0.3125	1.3125	0.0313	3.1
1 3V 500 SH	5	4.95	D-2	SH	1.6875	0.5625	—	1.3125	0.0625	2.8	2 3V 500 SH	D-1	SH	1.6875	0.25	0.3125	1.3125	0.0313	3.6
1 3V 530 SH	5.30	5.25	D-2	SH	1.6875	0.5625	—	1.3125	0.0625	3.2	2 3V 530 SH	D-1	SH	1.6875	0.25	0.3125	1.3125	0.0313	4.5
1 3V 560 SH	5.60	5.55	D-2	SH	1.6875	0.5625	—	1.3125	0.0625	3.2	2 3V 560 SH	D-1	SH	1.6875	0.25	0.3125	1.3125	0.0313	5.0
1 3V 600 SH	6	5.95	D-2	SH	1.6875	0.5625	—	1.3125	0.0625	3.5	2 3V 600 SH	D-1	SH	1.6875	0.25	0.3125	1.3125	0.0313	5.5
1 3V 650 SH	6.50	6.45	D-3	SH	1.6875	0.5625	—	1.3125	0.0625	3.9	2 3V 650 SDS	D-3	SDS	2	0.3125	0.3125	1.375	0.0313	5.8
1 3V 690 SH	6.90	6.85	D-3	SH	1.6875	0.5625	—	1.3125	0.0625	4.5	2 3V 690 SDS	D-3	SDS	2	0.3125	0.3125	1.375	0.0313	6.6
1 3V 800 SDS	8	7.95	C-3	SDS	2	0.625	—	1.375	—	5.5	2 3V 800 SDS	D-3	SDS	2	0.3125	0.3125	1.375	0.0313	7.0
1 3V 1060 SDS	10.60	10.55	C-3	SDS	2	0.625	—	1.3750	—	8.0	2 3V 1060 SK	C-3	SK	2.625	0.4375	0.25	1.9375	0.4063	10.0
1 3V 1400 SK	14	13.95	C-3	SK	2.625	0.6875	—	1.9375	—	13.5	2 3V 1400 SK	C-3	SK	2.625	0.4375	0.25	1.9375	0.4063	16.0
1 3V 1900 SK	19	18.95	C-3	SK	2.625	0.6875	—	1.9375	—	17.0	2 3V 1900 SK	C-3	SK	2.625	0.4375	0.25	1.9375	0.4063	25.0
—	25	24.95	—	—	—	—	—	—	—	—	2 3V 2500 SF	C-3	SF	2.9375	0.4375	0.25	2.0625	0.5313	28.0

NOTE: Dimensions in inches, weight in pounds. Weights do not include bushings. See page B-3 and B-4 for additional bushing dimensions.

\* F = 0.75" for 1 3V 800 SDS and 1 3V 1060 SDS, F = 13/16" for 1 3V 1400 SK and 1 3V 1900 SK.

★ E and M dimensions are nominal and will vary depending on shaft tolerances. Type E sheaves are drilled for reverse mounting only.

# 3V Hi-Cap Wedge Stock QD Sheaves



3/8 x 5/16

3V

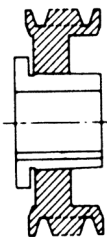

1 = Solid

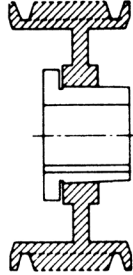

2 = Web

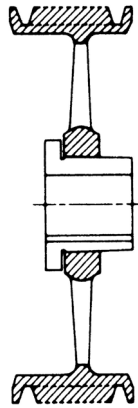

3 = Arm/Spoke



Let *Martin* quote your made to order and large quantity requirements.

## QD Sheaves – 3V

3 Grooves F = 1.5											4 Grooves F = 1.9063									
Part Number	OD	PD 3V Belt	Type	Bush	Bush Max Bore	E *	K	L Length Thru Bore	M *	Wt. Less Bush	Part Number	Type	Bush	Bush Max Bore	E *	K	L Length Thru Bore	M *	Wt. Less Bush	
3 3V 250 JA	2.50	2.45	E-1	JA	1.25	1.625	0.4375	1.0625	0.9375	1.6	-	-	-	-	-	-	-	-	-	-
3 3V 265 JA	2.65	2.60	D-1	JA	1.25	0.375	0.125	1.0625	0.8125	1.8	4 3V 265 JA	D-1	JA	1.250	0.375	0.125	1.0625	1.2188	1.3	
3 3V 280 JA	2.80	2.75	D-1	JA	1.25	0.375	0.125	1.0625	0.8125	2.0	4 3V 280 JA	D-1	JA	1.250	0.375	0.125	1.0625	1.2188	1.6	
3 3V 300 SH	3	2.95	E-1	SH	1.6875	1.0625	-	1.9375	0.5625	2.2	4 3V 300 SH	E-1	SH	1.6875	1.4688	0.3125	1.3125	0.875	1.9	
3 3V 315 SH	3.15	3.10	E-1	SH	1.6875	1.0625	0.3125	1.3125	0.875	2.5	4 3V 315 SH	E-1	SH	1.6875	1.4688	0.3125	1.3125	0.875	2.2	
3 3V 335 SH	3.35	3.30	D-1	SH	1.6875	0.4375	0.125	1.3125	0.625	2.8	4 3V 335 SH	D-1	SH	1.6875	0.4375	0.125	1.3125	1.0313	2.5	
3 3V 365 SH	3.65	3.60	D-1	SH	1.6875	0.4375	0.125	1.3125	0.625	3.0	4 3V 365 SH	D-1	SH	1.6875	0.4375	0.125	1.3125	1.0313	2.8	
3 3V 412 SH	4.12	4.07	A-1	SH	1.6875	0.125	0.6875	1.3125	0.0625	3.3	4 3V 412 SH	A-1	SH	1.6875	0.25	0.8125	1.3125	0.3438	3.2	
3 3V 450 SDS	4.50	4.45	A-1	SDS	2	0.0625	0.6875	1.375	0.0625	3.5	4 3V 450 SDS	A-1	SDS	2	0.1875	0.8125	1.375	0.3438	3.5	
3 3V 475 SDS	4.75	4.70	A-1	SDS	2	0.0625	0.6875	1.375	0.0625	3.7	4 3V 475 SDS	A-1	SDS	2	0.1875	0.8125	1.375	0.3438	4.0	
3 3V 500 SDS	5	4.95	A-1	SDS	2	0.0625	0.6875	1.375	0.0625	4.0	4 3V 500 SDS	A-1	SDS	2	0.1875	0.8125	1.375	0.3438	4.5	
3 3V 530 SDS	5.30	5.25	A-1	SDS	2	0.0625	0.6875	1.375	0.0625	4.3	4 3V 530 SDS	A-1	SDS	2	0.1875	0.8125	1.375	0.3438	5.0	
3 3V 560 SDS	5.60	5.55	A-1	SDS	2	0.0625	0.6875	1.375	0.0625	4.9	4 3V 560 SDS	A-1	SDS	2	0.1875	0.8125	1.375	0.3438	5.7	
3 3V 600 SDS	6	5.95	A-1	SDS	2	0.0625	0.6875	1.375	0.0625	5.9	4 3V 600 SK	D-1	SK	2.625	0.0625	0.625	1.9375	0.0313	7.5	
3 3V 650 SDS	6.50	6.45	A-3	SDS	2	0.0625	0.6875	1.375	0.0625	6.3	4 3V 650 SK	A-1	SK	2.625	0.0625	0.625	1.9375	0.0313	8.0	
3 3V 690 SDS	6.90	6.85	A-3	SDS	2	0.0625	0.6875	1.375	0.0625	6.8	4 3V 690 SK	A-1	SK	2.625	0.0625	0.625	1.9375	0.0313	10.0	
3 3V 800 SK	8	7.95	C-2	SK	2.625	0.4375	0.25	1.9375	-	10.6	4 3V 800 SK	D-2	SK	2.625	0.0625	0.625	1.9375	0.0313	12.0	
3 3V 1060 SK	10.60	10.55	C-3	SK	2.625	0.4375	0.25	1.9375	-	12.0	4 3V 1060 SK	D-3	SK	2.625	0.0625	0.625	1.9375	0.0313	16.0	
3 3V 1400 SK	14	13.95	C-3	SK	2.625	0.4375	0.25	1.9375	-	20.0	4 3V 1400 SK	D-3	SK	2.625	0.0625	0.625	1.9375	0.0313	22.0	
3 3V 1900 SF	19	18.95	C-3	SF	2.9375	0.4375	0.25	2.0625	0.125	33.0	4 3V 1900 SF	C-3	SF	2.9375	0.0625	0.625	2.0625	0.0938	37.0	
3 3V 2500 SF	25	24.95	C-3	SF	2.9375	0.4375	0.25	2.0625	0.125	45.0	4 3V 2500 SF	C-3	SF	2.9375	0.0625	0.625	2.0625	0.0938	53.0	
3 3V 3350 SF	33.50	33.45	C-3	SF	2.9375	0.4375	0.25	2.0625	0.125	75.0	4 3V 3350 E	C-3	E	3.5	0.375	0.5	2.625	0.3438	80.0	

NOTE: Dimensions in inches, weight in pounds. Weights do not include bushings. See page B-3 and B-4 for additional bushing dimensions.  
 \* E and M dimensions are nominal and will vary depending on shaft tolerances. Type E sheaves are drilled for reverse mounting only.

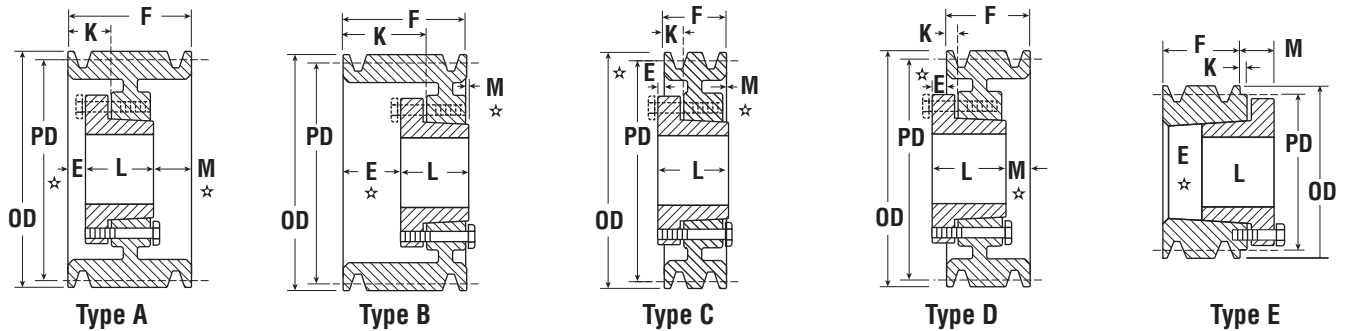

## QD Sheaves – 3V

5 Grooves* F = 2.3125											6 Grooves F = 2.7188								
Part Number	OD	PD 3V Belt	Type	Bush	Bush Max Bore	E *	K	L Length Thru Bore	M *	Wt. Less Bush	Part Number	Type	Bush	Bush Max Bore	E *	K	L Length Thru Bore	M *	Wt. Less Bush
5 3V 475 SDS	4.75	4.70	A-2	SDS	2	0.1875	0.8125	1.375	0.75	4.5	6 3V 475 SK	D-1	SK	2.625	0.5625	0.125	1.9375	1.3438	6.0
5 3V 500 SDS	5	4.95	A-2	SDS	2	0.1875	0.8125	1.375	0.75	5.3	6 3V 500 SK	D-1	SK	2.625	0.5625	0.125	1.9375	1.3438	6.5
5 3V 530 SK	5.30	5.25	A-1	SK	2.625	0.25	0.9375	1.9375	0.125	5.8	6 3V 530 SK	A-1	SK	2.625	0.625	1.3125	1.9375	0.1563	6.8
5 3V 560 SK	5.60	5.55	A-1	SK	2.625	0.25	0.9375	1.9375	0.125	7.0	6 3V 560 SK	A-1	SK	2.625	0.625	1.3125	1.9375	0.1563	8.0
5 3V 600 SK	6	5.95	A-1	SK	2.625	0.25	0.9375	1.9375	0.125	8.3	6 3V 600 SK	A-1	SK	2.625	0.625	1.3125	1.9375	0.1563	9.0
5 3V 650 SK	6.50	6.45	A-1	SK	2.625	0.25	0.9375	1.9375	0.125	9.0	6 3V 650 SK	A-2	SK	2.625	0.625	1.3125	1.9375	0.1563	10.0
5 3V 690 SK	6.90	6.85	A-1	SK	2.625	0.25	0.9375	1.9375	0.125	12.0	6 3V 690 SK	A-2	SK	2.625	0.625	1.3125	1.9375	0.1563	11.5
5 3V 800 SK	8	7.95	A-2	SK	2.625	0.25	0.9375	1.9375	0.125	13.0	6 3V 800 SK	A-2	SK	2.625	0.1875	0.875	1.9375	0.5938	17.0
5 3V 1060 SK	10.60	10.55	A-3	SK	2.625	0.25	0.9375	1.9375	0.125	17.0	6 3V 1060 SF	A-2	SF	2.9375	0.1875	0.875	2.0625	0.4688	25.0
5 3V 1400 SF	14	13.95	A-3	SK	2.9375	0.1875	0.875	2.0625	0.0625	27.0	6 3V 1400 SF	A-3	SF	2.9375	0.1875	0.875	2.063	0.4688	34.0
5 3V 1900 SF	19	18.95	A-3	SK	2.9375	0.1875	0.875	2.0625	0.0625	40.0	6 3V 1900 E	B-3	E	3.5	0.125	1	2.625	0.0313	45.0
5 3V 2500 E	25	24.95	C-3	E	3.5	0.25	0.625	2.625	0.0625	69.0	6 3V 2500 E	B-3	E	3.5	0.125	1	2.625	0.0313	75.0
5 3V 3350 E	33.50	33.45	C-3	E	3.5	0.25	0.625	2.625	0.0625	97.0	6 3V 3350 E	B-3	E	3.5	0.125	1	2.625	0.0313	98.0

## QD Sheaves – 3V

8 Grooves* F = 3.5313											10 Grooves F = 4.3438								
Part Number	OD	PD 3V Belt	Type	Bush	Bush Max Bore	E *	K	L Length Thru Bore	M *	Wt. Less Bush	Part Number	Type	Bush	Bush Max Bore	E *	K	L Length Thru Bore	M *	Wt. Less Bush
8 3V 475 SK	4.75	4.70	D-1	SK	2.625	0.5625	0.125	1.9375	2.1563	6.0	10 3V 475 SK	D-1	SK	2.625	0.5625	0.125	1.9375	2.9688	7.0
8 3V 500 SK	5	4.95	D-1	SK	2.625	0.5625	0.125	1.9375	2.1563	6.9	10 3V 500 SK	D-1	SK	2.625	0.5625	0.125	1.9375	2.9688	8.6
8 3V 530 SK	5.30	5.25	A-1	SK	2.625	0.625	1.3125	1.9375	0.9688	7.8	10 3V 530 SK	A-1	SK	2.625	0.75	1.4375	1.9375	1.6563	9.0
8 3V 560 SK	5.60	5.55	A-1	SK	2.625	0.625	1.3125	1.9375	0.9688	9.0	10 3V 560 SK	A-1	SK	2.625	0.75	1.4375	1.9375	1.6563	10.0
8 3V 600 SK	6	5.95	A-1	SK	2.625	0.625	1.3125	1.9375	0.9688	10.0	10 3V 600 SK	A-1	SK	2.625	0.75	1.4375	1.9375	1.6563	11.0
8 3V 650 SK	6.50	6.45	A-2	SK	2.625	0.625	1.3125	1.9375	0.9688	12.9	10 3V 650 SK	A-2	SK	2.625	0.75	1.4375	1.9375	1.6563	14.0
8 3V 690 SK	6.90	6.85	A-2	SK	2.625	0.625	1.3125	1.9375	0.9688	14.0	10 3V 690 SK	A-2	SK	2.625	0.75	1.4375	1.9375	1.6563	16.0
8 3V 800 SF	8	7.95	A-1	SF	2.9375	0.4375	1.125	2.0625	1.0313	20.0	10 3V 800 SF	A-1	SF	2.9375	0.8125	1.5	2.0625	1.4688	22.0
8 3V 1060 SF	10.60	10.55	A-2	SF	2.9375	0.4375	1.125	2.0625	1.0313	28.0	10 3V 1060 E	A-2	E	3.5	0.375	1.25	2.625	1.3438	33.0
8 3V 1400 E	14	13.95	A-3	E	3.5	0.375	1.25	2.625	0.5313	40.0	10 3V 1400 E	A-3	E	3.5	0.375	1.25	2.625	1.3438	43.0
8 3V 1900 E	19	18.95	A-3	E	3.5	0.375	1.25	2.625	0.5313	62.0	10 3V 1900 E	A-3	E	3.5	0.375	1.25	2.625	1.3438	66.0
8 3V 2500 E	25	24.95	A-3	E	3.5	0.375	1.25	2.625	0.5313	87.0	10 3V 2500 F	A-3	F	3.9375	0.3125	1.3125	3.625	0.4063	98.0
8 3V 3350 F	33.50	33.45	B-3	F	3.9375	0.0625	1.0625	3.625	0.1563	152.0	10 3V 3350 F	A-3	F	3.9375	0.3125	1.3125	3.625	0.4063	178.0

NOTE: Dimensions in inches, weight in pounds. Weights do not include bushings. See page B-3 and B-4 for additional bushing dimensions.  
 \* E and M dimensions are nominal and will vary depending on shaft tolerances. Type E sheaves are drilled for reverse mounting only.

# 5V Hi-Cap Wedge Stock QD Sheaves



5V

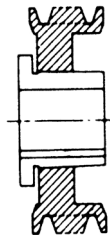

1 = Solid

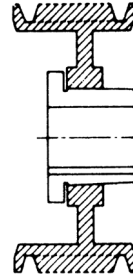

2 = Web

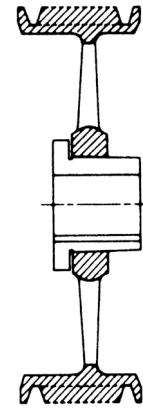

3 = Arm/Spoke

## QD Sheaves – 5V

2 Grooves F = 1.6875											3 Grooves F = 2.375								
Part Number	OD	PD 3V Belt	Type	Bush	Bush Max Bore	E *	K	L Length Thru Bore	M *	Wt. Less Bush	Part Number	Type	Bush	Bush Max Bore	E *	K	L Length Thru Bore	M *	Wt. Less Bush
2 5V 440 SH	4.40	4.30	A-1	SH	1.6875	0.3125	0.875	1.3125	0.0625	4.0	3 5V 440 SDS	E-1	SDS	2	1.625	-	1.375	0.625	5.5
2 5V 465 SDS	4.65	4.55	E-1	SDS	2	0.9375	-	1.375	0.625	4.5	3 5V 465 SDS	E-1	SDS	2	1.625	-	1.375	0.625	6.5
2 5V 490 SDS	4.90	4.80	A-1	SDS	2	0.0625	0.6875	1.375	0.25	5.0	3 5V 490 SDS	A-1	SDS	2	0.4375	1.0625	1.375	0.5625	7.0
2 5V 520 SDS	5.20	5.10	A-1	SDS	2	0.0625	0.6875	1.375	0.25	5.5	3 5V 520 SDS	A-1	SDS	2	0.4375	1.0625	1.375	0.5625	7.5
2 5V 550 SDS	5.5	5.40	A-1	SDS	2	0.0625	0.6875	1.375	0.25	6.0	3 5V 550 SDS	A-1	SDS	2	0.4375	1.0625	1.375	0.5625	8.0
2 5V 590 SDS	5.90	5.80	A-1	SDS	2	0.0625	0.6875	1.375	0.25	7.0	3 5V 590 SDS	A-1	SDS	2	0.4375	1.0625	1.375	0.5625	8.5
2 5V 630 SK	6.30	6.20	C-1	SK	2.625	0.25	0.4375	1.9375	-	8.0	3 5V 630 SK	A-1	SK	2.625	0.375	1.0625	1.9375	0.0625	11.0
2 5V 670 SK	6.70	6.60	C-1	SK	2.625	0.25	0.4375	1.9375	-	10.0	3 5V 670 SK	A-1	SK	2.625	0.375	1.0625	1.9375	0.0625	11.5
2 5V 710 SK	7.10	7	C-1	SK	2.625	0.25	0.4375	1.9375	-	11.0	3 5V 710 SF	A-1	SF	2.9375	0.3125	1	2.0625	-	13.0
2 5V 750 SK	7.5	7.40	C-1	SK	2.625	0.25	0.4375	1.9375	-	13.0	3 5V 750 SF	A-1	SF	2.9375	0.3125	1	2.0625	-	14.0
2 5V 800 SK	8	7.90	C-1	SK	2.625	0.25	0.4375	1.9375	-	14.0	3 5V 800 SF	A-1	SF	2.9375	0.3125	1	2.0625	-	15.0
2 5V 850 SK	8.5	8.40	C-1	SK	2.625	0.25	0.4375	1.9375	-	15.0	3 5V 850 SF	A-1	SF	2.9375	0.3125	1	2.0625	-	16.0
2 5V 900 SK	9	8.90	C-2	SK	2.625	0.25	0.4375	1.9375	-	16.0	3 5V 900 SF	A-2	SF	2.9375	0.3125	1	2.0625	-	17.0
2 5V 925 SK	9.25	9.15	C-2	SK	2.625	0.25	0.4375	1.9375	-	16.5	3 5V 925 SF	A-2	SF	2.9375	0.3125	1	2.0625	-	18.0
2 5V 975 SK	9.75	9.65	C-3	SK	2.625	0.25	0.4375	1.9375	-	17.0	3 5V 975 SF	A-2	SF	2.9375	0.3125	1	2.0625	-	19.0
2 5V 1030 SK	10.30	10.20	C-3	SK	2.625	0.25	0.4375	1.9375	-	18.0	3 5V 1030 SF	A-2	SF	2.9375	0.3125	1	2.0625	-	22.0
2 5V 1090 SK	10.90	10.80	C-3	SK	2.625	0.25	0.4375	1.9375	-	19.0	3 5V 1090 SF	A-2	SF	2.9375	0.3125	1	2.0625	-	25.0
2 5V 1130 SK	11.30	11.20	C-3	SK	2.625	0.25	0.4375	1.9375	-	19.5	3 5V 1130 SF	A-2	SF	2.9375	0.3125	1	2.0625	-	25.0
2 5V 1180 SK	11.80	11.70	C-3	SK	2.625	0.25	0.4375	1.9375	-	20.0	3 5V 1180 SF	A-2	SF	2.9375	0.3125	1	2.0625	-	29.0
2 5V 1250 SF	12.5	12.40	C-3	SF	2.9375	0.25	0.4375	2.0625	0.125	25.0	3 5V 1250 E	C-2	E	3.5	0.125	0.75	2.625	0.125	32.0
2 5V 1320 SF	13.20	13.10	C-3	SF	2.9375	0.25	0.4375	2.0625	0.125	27.0	3 5V 1320 E	C-3	E	3.5	0.125	0.75	2.625	0.125	38.0
2 5V 1400 SF	14	13.90	C-3	SF	2.9375	0.25	0.4375	2.0625	0.125	28.0	3 5V 1400 E	C-3	E	3.5	0.125	0.75	2.625	0.125	43.0
2 5V 1500 SF	15	14.90	C-3	SF	2.9375	0.25	0.4375	2.0625	0.125	30.0	3 5V 1500 E	C-3	E	3.5	0.125	0.75	2.625	0.125	44.0
2 5V 1600 SF	16	15.90	C-3	SF	2.9375	0.25	0.4375	2.0625	0.125	34.0	3 5V 1600 E	C-3	E	3.5	0.125	0.75	2.625	0.125	46.0
2 5V 1870 SF	18.70	18.60	C-3	SF	2.9375	0.25	0.4375	2.0625	0.125	49.0	3 5V 1870 E	C-3	E	3.5	0.125	0.75	2.625	0.125	60.0
2 5V 2120 SF	21.20	21.10	C-3	SF	2.9375	0.25	0.4375	2.0625	0.125	50.0	3 5V 2120 E	C-3	E	3.5	0.125	0.75	2.625	0.125	68.0
2 5V 2360 E	23.60	23.5	C-3	E	3.5	0.625	0.25	2.625	0.3125	72.0	3 5V 2360 E	C-3	E	3.5	0.125	0.75	2.625	0.125	80.0
2 5V 2800 E	28	27.90	C-3	E	3.5	0.625	0.25	2.625	0.3125	80.0	3 5V 2800 E	C-3	E	3.5	0.125	0.75	2.625	0.125	92.0
-	31.5	31.40	-	-	-	-	-	-	-	-	3 5V 3150 F	C-3	F	3.9375	0.4375	0.5625	3.625	0.8125	136.0
-	37.5	37.40	-	-	-	-	-	-	-	-	3 5V 3750 F	C-3	F	3.9375	0.4375	0.5625	3.625	0.8125	156.0
-	50	49.90	-	-	-	-	-	-	-	-	3 5V 5000 F	C-3	F	3.9375	0.4375	0.5625	3.625	0.8125	210.0

NOTE: Dimensions in inches, weight in pounds. Weights do not include bushings. See page B-3 and B-4 for additional bushing dimensions.  
 \* E and M dimensions are nominal and will vary depending on shaft tolerances. Type E sheaves are drilled for reverse mounting only.

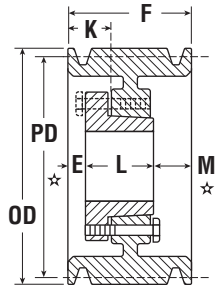

Type A

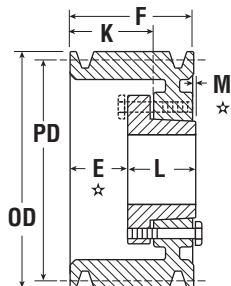

Type B

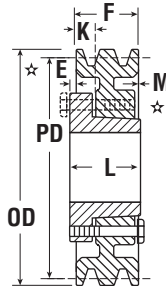

Type C

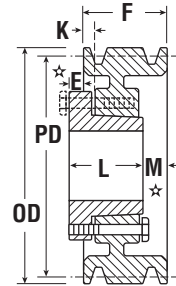

Type D

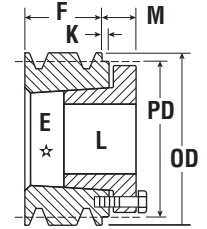

Type E

## QD Sheaves – 5V

4 Grooves											5 Grooves								
F = 3.0625											F = 3.75								
Part Number	OD	PD	Type	Bush	Bush Max Bore	E *	K	L Length Thru Bore	M *	Wt. Less Bush	Part Number	Type	Bush	Bush Max Bore	E *	K	L Length Thru Bore	M *	Wt. Less Bush
4 5V 440 SD	4.40	4.30	E-1	SD	2	1.875	-	1.8125	0.625	5.0	5 5V 440 SD	E-1	SD	2	2.5625	-	1.8125	0.625	6.0
4 5V 465 SD	4.65	4.55	E-1	SD	2	1.875	-	1.8125	0.625	6.0	5 5V 465 SD	E-1	SD	2	2.5625	1.3125	1.8125	0.625	7.0
4 5V 490 SD	4.90	4.80	A-1	SD	2	0.6875	1.3125	1.8125	0.5625	7.0	5 5V 490 SD	A-1	SD	2	0.6875	1.3125	1.8125	1.25	8.0
4 5V 520 SD	5.20	5.10	A-1	SD	2	0.6875	1.3125	1.8125	0.5625	8.0	5 5V 520 SD	A-1	SD	2	0.6875	1.3125	1.8125	1.25	9.0
4 5V 550 SD	5.5	5.40	A-1	SD	2	0.6875	1.3125	1.8125	0.5625	9.0	5 5V 550 SD	A-1	SD	2	0.6875	1.3125	1.8125	1.25	10.0
4 5V 590 SD	5.90	5.80	A-1	SD	2	0.6875	1.3125	1.8125	0.5625	10.8	5 5V 590 SK	A-1	SK	2.625	0.625	1.3125	1.9375	1.1875	11.0
4 5V 630 SK	6.30	6.20	A-1	SK	2.625	0.625	1.3125	1.9375	0.5	12.0	5 5V 630 SK	A-1	SK	2.625	0.625	1.3125	1.9375	1.1875	12.0
4 5V 670 SK	6.70	6.60	A-1	SK	2.625	0.625	1.3125	1.9375	0.5	14.0	5 5V 670 SF	A-1	SF	2.9375	0.625	1.3125	2.0625	1.0625	13.0
4 5V 710 SF	7.10	7	A-1	SF	2.9375	0.375	1.0625	2.0625	0.625	15.0	5 5V 710 SF	A-1	SF	2.9375	0.6875	1.375	2.0625	1	14.0
4 5V 750 SF	7.5	7.40	A-1	SF	2.9375	0.375	1.0625	2.0625	0.625	16.0	5 5V 750 SF	A-1	SF	2.9375	0.6875	1.375	2.0625	1	16.0
4 5V 800 E	8	7.90	B-1	E	3.5	0.5625	1.4375	2.625	0.125	19.0	5 5V 800 E	A-1	E	3.5	0.875	1.75	2.625	0.25	19.0
4 5V 850 E	8.5	8.40	B-1	E	3.5	0.5625	1.4375	2.625	0.125	23.0	5 5V 850 E	A-1	E	3.5	0.875	1.75	2.625	0.25	22.0
4 5V 900 E	9	8.90	B-1	E	3.5	0.5625	1.4375	2.625	0.125	25.0	5 5V 900 E	A-1	E	3.5	0.875	1.75	2.625	0.25	26.0
4 5V 925 E	9.25	9.15	B-1	E	3.5	0.5625	1.4375	2.625	0.125	26.0	5 5V 925 E	A-1	E	3.5	0.875	1.75	2.625	0.25	28.0
4 5V 975 E	9.75	9.65	B-1	E	3.5	0.5625	1.4375	2.625	0.125	28.0	5 5V 975 E	A-1	E	3.5	0.875	1.75	2.625	0.25	30.0
4 5V 1030 E	10.30	10.20	B-1	E	3.5	0.5625	1.4375	2.625	0.125	30.0	5 5V 1030 E	A-1	E	3.5	0.875	1.75	2.625	0.25	33.0
4 5V 1090 E	10.90	10.80	B-2	E	3.5	0.5625	1.4375	2.625	0.125	39.0	5 5V 1090 E	A-1	E	3.5	0.875	1.75	2.625	0.25	41.0
4 5V 1130 E	11.30	11.20	B-2	E	3.5	0.5625	1.4375	2.625	0.125	40.0	5 5V 1130 E	A-1	E	3.5	0.875	1.75	2.625	0.25	42.0
4 5V 1180 E	11.80	11.70	B-2	E	3.5	0.5625	1.4375	2.625	0.125	41.0	5 5V 1180 E	A-1	E	3.5	0.875	1.75	2.625	0.25	44.0
4 5V 1250 E	12.5	12.40	B-3	E	3.5	0.5625	1.4375	2.625	0.125	43.0	5 5V 1250 E	A-3	E	3.5	0.875	1.75	2.625	0.25	45.0
4 5V 1320 E	13.20	13.10	B-3	E	3.5	0.5625	1.4375	2.625	0.125	45.0	5 5V 1320 E	A-3	E	3.5	0.875	1.75	2.625	0.25	46.0
4 5V 1400 E	14	13.90	B-3	E	3.5	0.5625	1.4375	2.625	0.125	46.0	5 5V 1400 E	A-3	E	3.5	0.875	1.75	2.625	0.25	47.0
4 5V 1500 E	15	14.90	B-3	E	3.5	0.5625	1.4375	2.625	0.125	47.0	5 5V 1500 E	A-3	E	3.5	0.875	1.75	2.625	0.25	53.0
4 5V 1600 E	16	15.9	B-3	E	3.5	0.5625	1.4375	2.625	0.125	49.0	5 5V 1600 E	A-3	E	3.5	0.875	1.75	2.625	0.25	56.0
4 5V 1870 E	18.7	18.6	A-3	E	3.5	0.375	1.25	2.625	0.0625	71.0	5 5V 1870 F	B-3	F	3.9375	0.3125	1.3125	3.625	0.1875	96.0
4 5V 2120 E	21.20	21.10	A-3	E	3.5	0.375	1.25	2.625	0.0625	72.0	5 5V 2120 F	B-3	F	3.9375	0.3125	1.3125	3.625	0.1875	98.0
4 5V 2360 F	23.60	23.5	C-3	F	3.9375	0.125	0.875	3.625	0.4375	111.0	5 5V 2360 F	B-3	F	3.9375	0.3125	1.3125	3.625	0.1875	120.0
4 5V 2800 F	28	27.90	C-3	F	3.9375	0.125	0.875	3.625	0.4375	118.0	5 5V 2800 F	B-3	F	3.9375	0.3125	1.3125	3.625	0.1875	135.0
4 5V 3150 F	31.5	31.40	C-3	F	3.9375	0.125	0.875	3.625	0.4375	146.7	5 5V 3150 J	C-3	J	4.5	0.1875	1	4.5	0.5625	188.0
4 5V 3750 F	37.5	37.40	C-3	F	3.9375	0.125	0.875	3.625	0.4375	178.0	5 5V 3750 J	C-3	J	4.5	0.1875	1	4.5	0.5625	224.0
4 5V 5000 J	50	49.90	C-3	J	4.5	0.5	0.6875	4.5	0.9375	266.0	5 5V 5000 J	C-3	J	4.5	0.1875	1	4.5	0.5625	308.0

NOTE: Dimensions in inches, weight in pounds. Weights do not include bushings. See page B-3 and B-4 for additional bushing dimensions.  
 \* E and M dimensions are nominal and will vary depending on shaft tolerances. Type E sheaves are drilled for reverse mounting only.

# 5V Hi-Cap Wedge Stock QD Sheaves

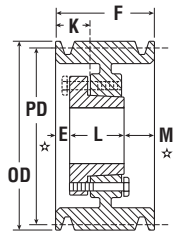

Type A

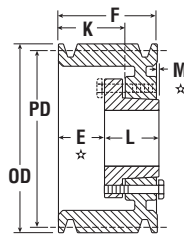

Type B

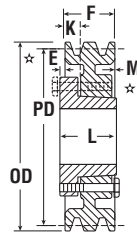

Type C

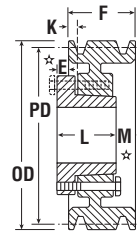

Type D

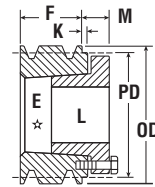

Type E



5/8 x 17/32

5V

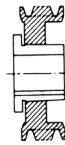

1 = Solid

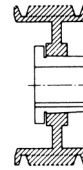

2 = Web

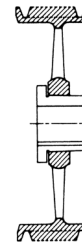

3 = Arm/Spoke

## QD Sheaves – 5V

6 Grooves F = 4.4375										7 Grooves F = 5.125										
Part Number	OD	PD 3V Belt	Type	Bush	Bush Max Bore	E *	K	L Length Thru Bore	M *	Wt. Less Bush	Part Number	Type	Bush	Bush Max Bore	E *	K	L Length Thru Bore	M *	Wt. Less Bush	
6 5V 440 SD	4.40	4.30	E-1	SD	2	3.25	—	1.8125	0.625	7.0	—	—	—	—	—	—	—	—	—	—
6 5V 465 SD	4.65	4.55	E-1	SD	2	3.25	—	1.8125	0.625	7.8	—	—	—	—	—	—	—	—	—	—
6 5V 490 SD	4.90	4.80	A-1	SD	2	0.6875	1.3125	1.8125	1.9375	9.0	—	—	—	—	—	—	—	—	—	—
6 5V 520 SD	5.20	5.10	A-1	SD	2	0.6875	1.3125	1.8125	1.9375	10.8	—	—	—	—	—	—	—	—	—	—
6 5V 550 SD	5.5	5.40	A-1	SD	2	0.6875	1.3125	1.8125	1.9375	11.3	—	—	—	—	—	—	—	—	—	—
6 5V 590 SK	5.90	5.80	A-1	SK	2.625	0.625	1.3125	1.9375	1.875	12.0	—	—	—	—	—	—	—	—	—	—
6 5V 630 SK	6.30	6.20	A-1	SK	2.625	0.625	1.3125	1.9375	1.875	13.0	—	—	—	—	—	—	—	—	—	—
6 5V 670 SF	6.70	6.60	A-1	SF	2.9375	0.9375	1.625	2.0625	1.4375	14.0	—	—	—	—	—	—	—	—	—	—
6 5V 710 SF	7.10	7	A-1	SF	2.9375	0.9375	1.625	2.0625	1.4375	15.0	7 5V 710 SF	A-1	SF	2.9375	0.9375	1.625	2.0625	2.125	17.0	—
6 5V 750 SF	7.5	7.40	A-1	SF	2.9375	0.9375	1.625	2.0625	1.4375	17.0	7 5V 750 SF	A-1	SF	2.9375	0.9375	1.625	2.0625	2.125	19.0	—
6 5V 800 E	8	7.90	A-1	E	3.5	1.125	2	2.625	0.6875	20.0	7 5V 800 E	A-1	E	3.5	1.125	2	2.625	1.375	22.0	—
6 5V 850 E	8.5	8.40	A-1	E	3.5	1.125	2	2.625	0.6875	25.0	7 5V 850 E	A-1	E	3.5	1.125	2	2.625	1.375	26.0	—
6 5V 900 E	9	8.90	A-1	E	3.5	1.125	2	2.625	0.6875	28.0	7 5V 900 E	A-1	E	3.5	1.125	2	2.625	1.375	29.0	—
6 5V 925 E	9.25	9.15	A-1	E	3.5	1.125	2	2.625	0.6875	29.0	7 5V 925 E	A-1	E	3.5	1.125	2	2.625	1.375	33.0	—
6 5V 975 E	9.75	9.65	A-1	E	3.5	1.125	2	2.625	0.6875	31.0	7 5V 975 E	A-1	E	3.5	1.125	2	2.625	1.375	37.0	—
6 5V 1030 E	10.30	10.20	A-1	E	3.5	1.125	2	2.625	0.6875	33.0	7 5V 1030 F	B-1	F	3.9375	1.625	2.5625	3.625	0.125	49.0	—
6 5V 1090 E	10.90	10.80	A-1	E	3.5	1.125	2	2.625	0.6875	38.0	7 5V 1090 F	B-1	F	3.9375	1.625	2.5625	3.625	0.125	56.0	—
6 5V 1130 E	11.30	11.20	A-1	E	3.5	1.125	2	2.625	0.6875	41.0	7 5V 1130 F	B-1	F	3.9375	1.625	2.5625	3.625	0.125	61.0	—
6 5V 1180 E	11.80	11.70	A-1	E	3.5	1.125	2	2.625	0.6875	43.0	7 5V 1180 F	B-2	F	3.9375	1.625	2.5625	3.625	0.125	56.0	—
6 5V 1250 F	12.5	12.40	B-3	F	3.9375	1.0625	2.0625	3.625	0.25	45.0	7 5V 1250 F	B-3	F	3.9375	1.625	2.5625	3.625	0.125	53.0	—
6 5V 1320 F	13.20	13.10	B-3	F	3.9375	1.0625	2.0625	3.625	0.25	48.0	7 5V 1320 F	B-3	F	3.9375	1.625	2.5625	3.625	0.125	52.0	—
6 5V 1400 F	14	13.90	B-3	F	3.9375	1.0625	2.0625	3.625	0.25	59.0	7 5V 1400 F	B-3	F	3.9375	1.625	2.5625	3.625	0.125	62.0	—
6 5V 1500 F	15	14.90	B-3	F	3.9375	1.0625	2.0625	3.625	0.25	64.0	7 5V 1500 F	B-3	F	3.9375	1.625	2.5625	3.625	0.125	67.0	—
6 5V 1600 F	16	15.90	B-3	F	3.9375	1.0625	2.0625	3.625	0.25	68.0	7 5V 1600 F	B-3	F	3.9375	1.625	2.5625	3.625	0.125	77.0	—
6 5V 1870 F	18.70	18.60	A-3	F	3.9375	0.3125	1.3125	3.625	0.5	83.8	7 5V 1870 F	A-3	F	3.9375	0.375	1.3125	3.625	1.125	99.0	—
6 5V 2120 F	21.20	21.10	A-3	F	3.9375	0.3125	1.3125	3.625	0.5	110.0	7 5V 2120 J	C-3	J	4.5	0.1875	1.3125	4.5	0.4375	138.0	—
6 5V 2360 J	23.60	23.5	B-3	J	4.5	0.125	1.3125	4.5	0.1875	148.0	7 5V 2360 J	C-3	J	4.5	0.1875	1.3125	4.5	0.4375	174.0	—
6 5V 2800 J	28	27.90	B-3	J	4.5	0.125	1.3125	4.5	0.1875	169.0	7 5V 2800 J	C-3	J	4.5	0.1875	1.3125	4.5	0.4375	169.0	—
6 5V 3150 J	31.5	31.40	B-3	J	4.5	0.125	1.3125	4.5	0.1875	206.0	7 5V 3150 J	C-3	J	4.5	0.1875	1.3125	4.5	0.4375	241.0	—
6 5V 3750 J	37.5	37.40	B-3	J	4.5	0.125	1.3125	4.5	0.1875	241.0	7 5V 3750 M	C-3	M	5.5	0.5625	1.9375	6.75	2.1875	300.0	—
6 5V 5000 M	50	49.90	C-3	M	5.5	0.125	0.5	6.75	1.375	388.0	7 5V 5000 M	C-3	M	5.5	0.875	0.5	6.75	0.75	408.0	—

NOTE: Dimensions in inches, weight in pounds. Weights do not include bushings. See page B-3 and B-4 for additional bushing dimensions.  
 \* E and M dimensions are nominal and will vary depending on shaft tolerances. Type E sheaves are drilled for reverse mounting only.





# Hi-Cap Wedge Stock QD Sheaves 5V

## QD Sheaves – 5V

8 Grooves										9 Grooves										
F = 5.8125										F = 6.5										
Part Number	OD	PD 3V Belt	Type	Bush	Bush Max Bore	E ★	K	L Length Thru Bore	M ★	Wt. Less Bush	Part Number	Type	Bush	Bush Max Bore	E ★	K	L Length Thru Bore	M ★	Wt. Less Bush	
8 5V 710 SF	7.10	7	A-1	SF	2.9375	1.4375	2.125	2.0625	2.3125	19.0	–	–	–	–	–	–	–	–	–	–
8 5V 750 SF	7.5	7.40	A-1	SF	2.9375	1.4375	2.125	2.0625	2.3125	20.0	–	–	–	–	–	–	–	–	–	–
8 5V 800 E	8	7.90	A-1	E	3.5	1.625	2.5	2.625	1.5625	25.0	9 5V 800 E	A-1	E	3.5	1.625	2.5	2.625	2.25	26.0	
8 5V 850 E	8.5	8.40	A-1	E	3.5	1.625	2.5	2.625	1.5625	29.0	9 5V 850 E	A-1	E	3.5	1.625	2.5	2.625	2.25	30.0	
8 5V 900 E	9	8.90	A-1	E	3.5	1.625	2.5	2.625	1.5625	32.0	9 5V 900 E	A-1	E	3.5	1.625	2.5	2.625	2.25	33.0	
8 5V 925 F	9.25	9.15	A-1	F	3.5	1.5625	2.5625	3.625	0.625	39.0	9 5V 925 F	A-1	F	3.9375	1.625	2.5625	3.625	1.25	33.0	
8 5V 975 F	9.75	9.65	A-1	F	3.9375	1.5625	2.5625	3.625	0.625	42.0	9 5V 975 F	A-1	F	3.9375	1.625	2.5625	3.625	1.25	45.0	
8 5V 1030 F	10.30	10.20	A-1	F	3.9375	1.5625	2.5625	3.625	0.625	52.0	9 5V 1030 F	A-1	F	3.9375	1.625	2.5625	3.625	1.25	54.0	
8 5V 1090 F	10.90	10.80	A-1	F	3.9375	1.5625	2.5625	3.625	0.625	59.0	9 5V 1090 F	A-1	F	3.9375	1.625	2.5625	3.625	1.25	62.0	
8 5V 1130 F	11.30	11.20	A-1	F	3.9375	1.5625	2.5625	3.625	0.625	62.0	9 5V 1130 F	A-1	F	3.9375	1.625	2.5625	3.625	1.25	67.0	
8 5V 1180 F	11.80	11.70	A-1	F	3.9375	1.5625	2.5625	3.625	0.625	64.0	9 5V 1180 F	A-1	F	3.9375	1.625	2.5625	3.625	1.25	73.0	
8 5V 1250 F	12.5	12.40	A-3	F	3.9375	1.5625	2.5625	3.625	0.625	66.0	9 5V 1250 F	A-3	F	3.9375	1.625	2.5625	3.625	1.25	61.0	
8 5V 1320 F	13.20	13.10	A-3	F	3.9375	1.5625	2.5625	3.625	0.625	68.0	9 5V 1320 F	A-3	F	3.9375	1.625	2.5625	3.625	1.25	60.0	
8 5V 1400 F	14	13.90	A-3	F	3.9375	1.5625	2.5625	3.625	0.625	70.0	9 5V 1400 F	A-3	F	3.9375	1.625	2.5625	3.625	1.25	70.0	
8 5V 1500 F	15	14.90	A-3	F	3.9375	1.5625	2.5625	3.625	0.625	73.0	9 5V 1500 J	B-2	J	4.5	2.4375	3.5625	4.5	0.4375	95.0	
8 5V 1600 F	16	15.90	A-3	F	3.9375	1.5625	2.5625	3.625	0.625	89.0	9 5V 1600 J	B-2	J	4.5	2.4375	3.5625	4.5	0.4375	103.0	
8 5V 1870 J	18.70	18.60	A-3	J	4.5	0.375	1.5625	4.5	0.9375	132.0	9 5V 1870 J	A-3	J	4.5	0.4375	1.5625	4.5	1.5625	140.0	
8 5V 2120 J	21.20	21.10	A-3	J	4.5	0.375	1.5625	4.5	0.9375	150.0	9 5V 2120 J	A-3	J	4.5	0.4375	1.5625	4.5	1.5625	152.0	
8 5V 2360 J	23.60	23.5	A-3	J	4.5	0.375	1.5625	4.5	0.9375	162.0	9 5V 2360 J	A-3	J	4.5	0.4375	1.5625	4.5	1.5625	176.0	
8 5V 2800 J	28	27.90	A-3	J	4.5	0.375	1.5625	4.5	0.9375	191.0	9 5V 2800 M	B-3	M	5.5	0.5625	1.9375	6.75	0.8125	265.0	
8 5V 3150 M	31.5	31.40	B-3	M	5.5	0.5	1.9375	6.75	1.4375	298.0	9 5V 3150 M	B-3	M	5.5	0.5625	1.9375	6.75	0.8125	313.0	
8 5V 3750 M	37.5	37.40	B-3	M	5.5	0.5	1.9375	6.75	1.4375	319.0	9 5V 3750 M	B-3	M	5.5	0.5625	1.9375	6.75	0.8125	409.0	
8 5V 5000 M	50	49.90	B-3	M	5.5	0.5	1.9375	6.75	1.4375	497.0	9 5V 5000 M	B-3	M	5.5	0.5625	1.9375	6.75	0.8125	483.0	

10 Grooves										
F = 7.1875										
Part Number	OD	PD 3V Belt	Type	Bush	Bush Max Bore	E ★	K	L Length Thru Bore	M ★	Wt. Less Bush
10 5V 800 E	8	7.90	A-1	E	3.5	2.375	3.25	2.625	2.1875	27.0
10 5V 850 E	8.5	8.40	A-1	E	3.5	2.375	3.25	2.625	2.1875	32.0
10 5V 900 F	9	8.90	A-1	F	3.9375	2.3125	3.3125	3.625	1.25	41.0
10 5V 925 F	9.25	9.15	A-1	F	3.9375	2.3125	3.3125	3.625	1.25	47.0
10 5V 975 F	9.75	9.65	A-1	F	3.9375	2.3125	3.3125	3.625	1.25	58.0
10 5V 1030 F	10.30	10.20	A-1	F	3.9375	2.3125	3.3125	3.625	1.25	66.0
10 5V 1090 F	10.90	10.80	A-1	F	3.9375	2.3125	3.3125	3.625	1.25	75.0
10 5V 1130 F	11.30	11.20	A-1	F	3.9375	2.3125	3.3125	3.625	1.25	79.0
10 5V 1180 F	11.80	11.70	A-1	F	3.9375	2.3125	3.3125	3.625	1.25	80.0
10 5V 1250 J	12.5	12.40	A-1	J	4.5	2.375	3.5625	4.5	0.3125	82.0
10 5V 1320 J	13.20	13.10	A-1	J	4.5	2.375	3.5625	4.5	0.3125	85.0
10 5V 1400 J	14	13.90	A-1	J	4.5	2.375	3.5625	4.5	0.3125	90.0
10 5V 1500 J	15	14.90	A-2	J	4.5	2.375	3.5625	4.5	0.3125	92.0
10 5V 1600 J	16	15.90	A-1	J	4.5	2.375	3.5625	4.5	0.3125	102.0
10 5V 1870 J	18.70	18.60	A-3	J	4.5	0.375	1.5625	4.5	2.1875	150.0
10 5V 2120 J	21.20	21.10	A-3	J	4.5	0.375	1.5625	4.5	2.1875	164.0
10 5V 2360 M	23.60	23.5	B-3	M	5.5	0.5	1.9375	6.75	0.0625	258.0
10 5V 2800 M	28	27.90	B-3	M	5.5	0.5	1.9375	6.75	0.0625	278.0
10 5V 3150 M	31.5	31.40	B-3	M	5.5	0.5	1.9375	6.75	0.0625	318.0
10 5V 3750 M	37.5	37.40	B-3	M	5.5	0.5	1.9375	6.75	0.0625	340.0
10 5V 5000 M	50	49.90	B-3	M	5.5	0.5	1.9375	6.75	0.0625	538.0

NOTE: Dimensions in inches, weight in pounds. Weights do not include bushings. See page B-3 and B-4 for additional bushing dimensions.  
 ★ E and M dimensions are nominal and will vary depending on shaft tolerances. Type E sheaves are drilled for reverse mounting only.

# 8V Hi-Cap Wedge Stock QD Sheaves



## QD Sheaves – 8V

4 Grooves											5 Grooves								
F = 4.875											F = 6								
Part Number	OD	PD	Type	Bush	Bush Max Bore	E ★	K	L Length Thru Bore	M ★	Wt. Less Bush	Part Number	Type	Bush	Bush Max Bore	E ★	K	L Length Thru Bore	M ★	Wt. Less Bush
		3V Belt																	
4 8V 1250 F	12.5	12.3	A-1	F	3.9375	0.1875	1.1875	3.625	1.0625	63.0	5 8V 1250 F	A-1	F	3.9375	1.3125	2.3125	3.625	1.0625	68.0
4 8V 1320 F	13.2	13	A-2	F	3.9375	0.1875	1.1875	3.625	1.0625	66.0	5 8V 1320 F	A-2	F	3.9375	1.3125	2.3125	3.625	1.0625	75.0
4 8V 1400 F	14	13.8	A-2	F	3.9375	0.1875	1.1875	3.625	1.0625	70.0	5 8V 1400 F	A-2	F	3.9375	1.3125	2.3125	3.625	1.0625	78.0
4 8V 1500 F	15	14.8	A-2	F	3.9375	0.1875	1.1875	3.625	1.0625	74.0	5 8V 1500 F	A-2	F	3.9375	1.3125	2.3125	3.625	1.0625	94.0
4 8V 1600 F	16	15.8	A-2	F	3.9375	0.1875	1.1875	3.625	1.0625	82.0	5 8V 1600 F	A-2	F	3.9375	1.3125	2.3125	3.625	1.0625	101.0
4 8V 1700 F	17	16.8	A-3	F	3.9375	0.1875	1.1875	3.625	1.0625	94.0	5 8V 1700 J	A-3	J	4.5	0.8125	2	4.5	0.6875	111.0
4 8V 1800 F	18	17.8	A-3	F	3.9375	0.1875	1.1875	3.625	1.0625	99.0	5 8V 1800 J	A-3	J	4.5	0.8125	2	4.5	0.6875	130.0
4 8V 1900 F	19	18.8	A-3	F	3.9375	0.1875	1.1875	3.625	1.0625	105.0	5 8V 1900 J	A-3	J	4.5	0.8125	2	4.5	0.6875	135.0
4 8V 2000 J	20	19.8	A-3	J	4.5	0.25	1.4375	4.5	0.125	141.0	5 8V 2000 J	A-3	J	4.5	0.8125	2	4.5	0.6875	152.0
4 8V 2120 J	21.2	21	A-3	J	4.5	0.25	1.4375	4.5	0.125	150.0	5 8V 2120 J	A-3	J	4.5	0.8125	2	4.5	0.6875	153.0
4 8V 2240 J	22.4	22.2	A-3	J	4.5	0.25	1.4375	4.5	0.125	177.0	5 8V 2240 M	B-3	M	5.5	0.5	1.9375	6.75	1.25	223.0
4 8V 2480 M	24.8	24.6	C-3	M	5.5	0.625	0.8125	6.75	1.25	223.0	5 8V 2480 M	B-3	M	5.5	0.5	1.9375	6.75	1.25	234.0
4 8V 3000 M	30	29.8	C-3	M	5.5	0.625	0.8125	6.75	1.25	285.0	5 8V 3000 M	B-3	M	5.5	0.5	1.9375	6.75	1.25	294.0
4 8V 3550 M	35.5	35.3	C-3	M	5.5	0.625	0.8125	6.75	1.25	305.0	5 8V 3550 M	B-3	M	5.5	0.5	1.9375	6.75	1.25	325.0
4 8V 4000 M	40	39.8	C-3	M	5.5	0.625	0.8125	6.75	1.25	355.0	5 8V 4000 M	B-3	M	5.5	0.5	1.9375	6.75	1.25	430.0
4 8V 4450 M	44.5	44.3	C-3	M	5.5	0.625	0.8125	6.75	1.25	369.0	5 8V 4450 N	C-3	N	6	0.8125	0.9375	8.125	1.3125	485.0
4 8V 5300 M	53	52.8	C-3	M	5.5	0.375	0.8125	6.75	1.25	478.0	5 8V 5300 N	C-3	N	6	0.8125	0.9375	8.125	1.3125	672.0

6 Grooves											8 Grooves								
F = 4.875											F = 6								
Part Number	OD	PD	Type	Bush	Bush Max Bore	E ★	K	L Length Thru Bore	M ★	Wt. Less Bush	Part Number	Type	Bush	Bush Max Bore	E ★	K	L Length Thru Bore	M ★	Wt. Less Bush
		3V Belt																	
6 8V 1250 F	12.5	12.3	A-1	F	3.9375	1.3125	2.3125	3.625	2.1875	86.0	8 8V 1250 J	A-1	J	4.5	2.375	3.5625	4.5	2.5	108.0
6 8V 1320 F	13.2	13	A-1	F	3.9375	1.3125	2.3125	3.625	2.1875	94.0	8 8V 1320 J	A-1	J	4.5	2.375	3.5625	4.5	2.5	118.0
6 8V 1400 F	14	13.8	A-1	F	3.9375	1.3125	2.3125	3.625	2.1875	108.0	8 8V 1400 J	A-1	J	4.5	2.375	3.5625	4.5	2.5	131.0
6 8V 1500 J	15	14.8	A-1	J	4.5	1.375	2.5625	4.5	1.25	138.0	8 8V 1500 J	A-1	J	4.5	2.375	3.5625	4.5	2.5	151.0
6 8V 1600 J	16	15.8	A-1	J	4.5	1.375	2.5625	4.5	1.25	142.0	8 8V 1600 J	A-1	J	4.5	2.375	3.5625	4.5	2.5	155.0
6 8V 1700 J	17	16.8	A-2	J	4.5	1.375	2.5625	4.5	1.25	144.0	8 8V 1700 M	A-2	M	5.5	2.5	3.9375	6.75	0.125	188.0
6 8V 1800 J	18	17.8	A-2	J	4.5	1.375	2.5625	4.5	1.25	160.0	8 8V 1800 M	A-2	M	5.5	2.5	3.9375	6.75	0.125	202.0
6 8V 1900 J	19	18.8	A-2	J	4.5	1.375	2.5625	4.5	1.25	172.0	8 8V 1900 M	A-2	M	5.5	2.5	3.9375	6.75	0.125	221.0
6 8V 2000 M	20	19.8	B-2	M	5.5	1.5	2.9375	6.75	1.125	204.0	8 8V 2000 M	A-2	M	5.5	2.5	3.9375	6.75	0.125	236.0
6 8V 2120 M	21.2	21	B-2	M	5.5	1.5	2.9375	6.75	1.125	226.0	8 8V 2120 M	A-2	M	5.5	2.5	3.9375	6.75	0.125	267.0
6 8V 2240 M	22.4	22.2	B-3	M	5.5	1.5	2.9375	6.75	1.125	235.0	8 8V 2240 M	A-3	M	5.5	2.5	3.9375	6.75	0.125	284.0
6 8V 2480 M	24.8	24.6	B-3	M	5.5	0.5	1.9375	6.75	0.125	246.0	8 8V 2480 N	A-2	N	6	0.5	2.25	8.125	0.75	418.0
6 8V 3000 M	30	29.8	B-3	M	6	0.5	1.9375	6.75	0.125	306.0	8 8V 3000 N	A-3	N	6	0.5	2.25	8.125	0.75	447.0
6 8V 3550 N	35.5	35.3	C-3	N	6	0.625	1.125	8.125	0.375	466.0	8 8V 3550 N	A-3	N	6	0.5	2.25	8.125	0.75	553.0
6 8V 4000 N	40	39.8	C-3	N	6	0.625	1.125	8.125	0.375	548.0	8 8V 4000 N	A-3	N	6	0.5	2.25	8.125	0.75	648.0
6 8V 4450 N	44.5	44.3	C-3	N	6	0.625	1.125	8.125	0.375	590.0	8 8V 4450 P	B-3	P	6.75	0.625	2.625	9.375	0.625	679.0
6 8V 5300 N	53	52.8	C-3	N	6	0.625	1.125	8.125	0.375	658.0	8 8V 5300 P	B-3	P	6.75	0.625	2.625	9.375	0.625	946.0
6 8V 6300 P	63	62.8	C-3	P	6.75	-	2	9.375	1.875	860.0	8 8V 6300 P	B-3	P	6.75	0.625	2.625	9.375	0.25	1372.0
6 8V 7100 P	71	70.8	B-3	P	6.75	-	2	9.375	1.875	1272.0	8 8V 7100 W	C-3	W	8.5	0.875	1.375	11.375	0.75	1680.0

NOTE: Dimensions in inches, weight in pounds. Weights do not include bushings. See page B-3 and B-4 for additional bushing dimensions.

★ E and M dimensions are nominal and will vary depending on shaft tolerances. Type E sheaves are drilled for reverse mounting only.



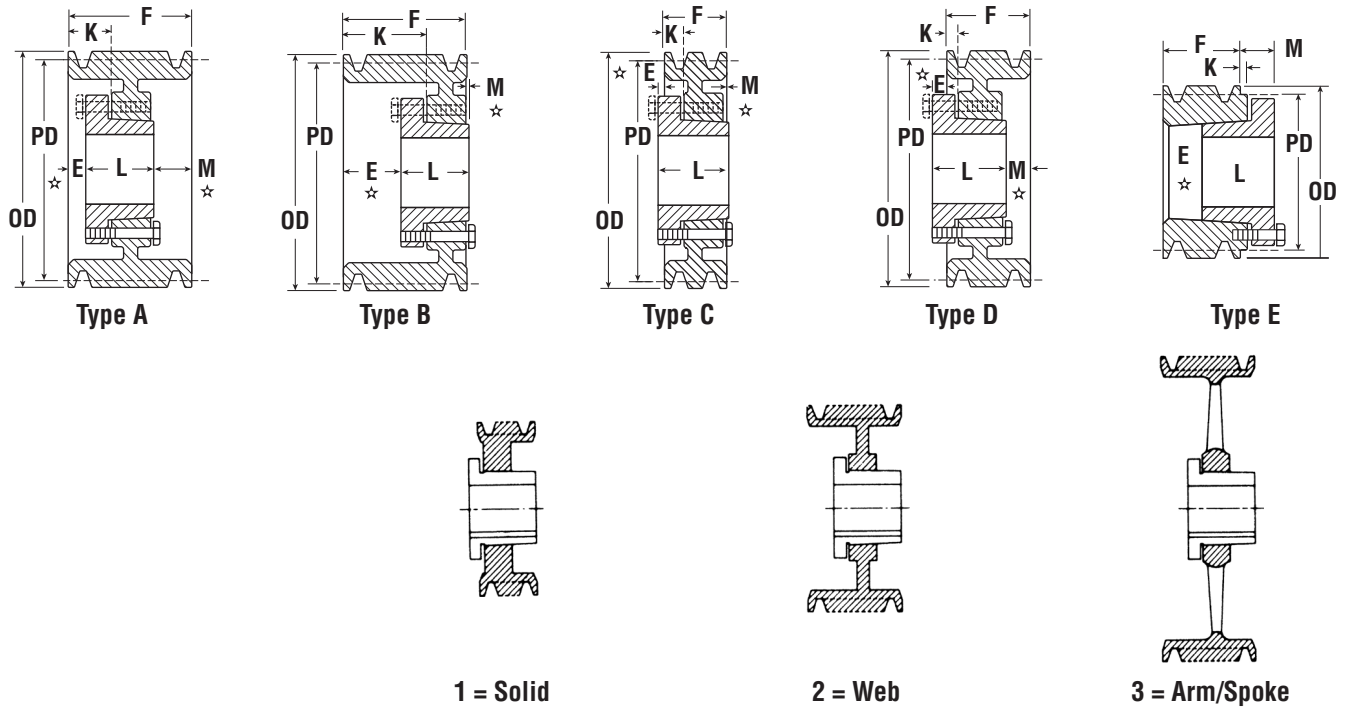

## QD Sheaves – 8V

10 Grooves F = 11.625											12 Grooves F = 14								
Part Number	OD	PD 3V Belt	Type	Bush	Bush Max Bore	E *	K	L Length Thru Bore	M *	Wt. Less Bush	Part Number	Type	Bush	Bush Max Bore	E *	K	L Length Thru Bore	M *	Wt. Less Bush
10 8V 1250 J	12.5	12.3	A-1	J	4.5	2.375	3.5625	4.5	4.75	122.0	12 8V 1250 M	A-1	M	5.5	2.5	3.9375	6.75	4.625	161.0
10 8V 1320 J	13.2	13	A-1	J	4.5	2.375	3.5625	4.5	4.75	140.0	12 8V 1320 M	A-1	M	5.5	2.5	3.9375	6.75	4.625	185.0
10 8V 1400 J	14	13.8	A-1	J	4.5	2.375	3.5625	4.5	4.75	152.0	12 8V 1400 M	A-1	M	5.5	2.5	3.9375	6.75	4.625	211.0
10 8V 1500 M	15	14.8	A-1	M	5.5	2.5	3.9375	6.75	2.375	212.0	12 8V 1500 M	A-1	M	5.5	2.5	3.9375	6.75	4.625	234.0
10 8V 1600 M	16	15.8	A-1	M	5.5	2.5	3.9375	6.75	2.375	219.0	12 8V 1600 M	A-1	M	5.5	2.5	3.9375	6.75	4.625	285.0
10 8V 1700 M	17	16.8	A-2	M	5.5	2.5	3.9375	6.75	2.375	228.0	12 8V 1700 M	A-1	M	5.5	2.5	3.9375	6.75	4.625	324.0
10 8V 1800 M	18	17.8	A-2	M	5.5	2.5	3.9375	6.75	2.375	236.0	12 8V 1800 M	A-2	M	5.5	2.5	3.9375	6.75	4.625	330.0
10 8V 1900 M	19	18.8	A-2	M	5.5	2.5	3.9375	6.75	2.375	260.0	12 8V 1900 N	A-2	N	6	0.5	2.25	8.125	5.25	338.0
10 8V 2000 M	20	19.8	A-2	M	5.5	2.5	3.9375	6.75	2.375	280.0	12 8V 2000 N	A-2	N	6	0.5	2.25	8.125	5.25	365.0
10 8V 2120 M	21.2	21	A-2	M	5.5	2.5	3.9375	6.75	2.375	298.0	12 8V 2120 N	A-2	N	6	0.5	2.25	8.125	5.25	382.0
10 8V 2240 N	22.4	22.2	A-2	N	6	0.5	2.25	8.125	3	366.0	12 8V 2240 N	A-2	N	6	0.5	2.25	8.125	5.25	399.0
10 8V 2480 N	24.8	24.6	A-2	N	6	0.5	2.25	8.125	3	454.0	12 8V 2480 N	A-2	N	6	0.5	2.25	8.125	5.25	454.0
10 8V 3000 N	30	29.8	A-3	N	6	0.5	2.25	8.125	3	468.0	12 8V 3000 P	A-3	P	6.75	0.625	2.625	9.375	3.875	605.0
10 8V 3550 P	35.5	35.3	A-3	P	6.75	0.625	2.625	9.375	1.625	784.0	12 8V 3550 P	A-3	P	6.75	0.625	2.625	9.375	3.875	706.0
10 8V 4000 P	40	39.8	A-3	P	6.75	0.625	2.625	9.375	1.625	826.0	12 8V 4000 P	A-3	P	6.75	0.625	2.625	9.375	3.875	766.0
10 8V 4450 P	44.5	44.3	A-3	P	6.75	0.625	2.625	9.375	1.625	996.0	12 8V 4450 P	A-3	P	6.75	0.625	2.625	9.375	3.875	910.0
10 8V 5300 P	53	52.8	A-3	P	6.75	0.625	2.625	9.375	0.25	1010.0	12 8V 5300 W	A-3	W	8.5	0.625	2.875	11.375	2.25	1333.0
10 8V 6300 W	63	62.8	A-3	W	8.5	0.625	2.875	11.375	—	1443.0	12 8V 6300 W	A-3	W	8.5	0.625	2.875	11.375	2.25	1777.0
10 8V 7100 W	71	70.8	A-3	W	8.5	0.625	2.875	11.375	—	1842.0	12 8V 7100 W	A-3	W	8.5	0.625	2.875	11.375	2.25	2002.0

NOTE: Dimensions in inches, weight in pounds. Weights do not include bushings. See page B-3 and B-4 for additional bushing dimensions.  
 \* E and M dimensions are nominal and will vary depending on shaft tolerances. Type E sheaves are drilled for reverse mounting only.

# A-B Combination Groove Conventional Stock QD Sheaves



## Combination Groove Dimensions

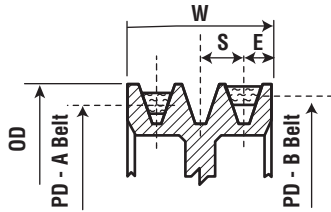

Belt Selection	E	S	OD
AB	.5	.75	PD B + .35

W = S (N-1) + 2E  
N = No. of Grooves

Drawing shows position of "A" and "B" belts in groove.

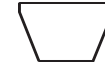

1/2 x 5/16

A



2 1/32 x 1 3/32

B

Drawing shows position of A and B belts in groove when used in QD Sheaves

## QD Sheaves – A-B

1 Groove											2 Grooves									
F = 7/8 thru 1 B 64 SDS / F = 1 others											F = 1.75									
Part Number	PD		QD	Type	Bush	Bush Max Bore	E *	K	L Length Thru Bore	M *	Wt. Less Bush	Part Number	Type	Bush	Bush Max Bore	E *	K	L Length Thru Bore	M *	Wt. Less Bush
	A Belt	B Belt																		
1 B 34 SH	3.0	3.4	3.75	D-1	SH	1.6875	0.5625	—	1.3125	0.125	1.4	2 B 34 SH	E-1	SH	1.6875	1	—	1.3125	0.5625	2.8
1 B 36 SH	3.2	3.6	3.95	D-1	SH	1.6875	0.5625	—	1.3125	0.125	1.6	2 B 36 SH	D-1	SH	1.6875	0.375	0.1875	1.3125	0.8125	2.8
1 B 38 SH	3.4	3.8	4.15	D-1	SH	1.6875	0.5625	—	1.3125	0.125	1.2	2 B 38 SH	D-1	SH	1.6875	0.375	0.1875	1.3125	0.8125	3.3
1 B 40 SH	3.6	4.0	4.35	C-1	SH	1.6875	0.25	0.3125	1.3125	0.1875	2.2	2 B 40 SH	A-1	SH	1.6875	0.125	0.6875	1.3125	0.3125	3.4
1 B 42 SH	3.8	4.2	4.55	C-1	SH	1.6875	0.25	0.3125	1.3125	0.1875	6.9	2 B 42 SH	A-1	SH	1.6875	0.125	0.6875	1.3125	0.3125	3.8
1 B 44 SH	4.0	4.4	4.75	C-1	SH	1.6875	0.25	0.3125	1.3125	0.1875	2.9	2 B 44 SH	A-1	SH	1.6875	0.125	0.6875	1.3125	0.3125	4.6
1 B 46 SDS	4.2	4.6	4.95	C-1	SDS	2	0.3125	0.3125	1.375	0.1875	2.6	2 B 46 SDS	A-2	SDS	2	0.0625	0.6875	1.375	0.3125	4.3
1 B 48 SDS	4.4	4.8	5.15	C-1	SDS	2	0.3125	0.3125	1.375	0.1875	3.1	2 B 48 SDS	A-2	SDS	2	0.0625	0.6875	1.375	0.3125	4.8
1 B 50 SDS	4.6	5.0	5.35	C-1	SDS	2	0.3125	0.3125	1.375	0.1875	3.5	2 B 50 SDS	A-2	SDS	2	0.0625	0.6875	1.375	0.3125	5.5
1 B 52 SDS	4.8	5.2	5.55	C-1	SDS	2	0.3125	0.3125	1.375	0.1875	3.7	2 B 52 SDS	A-2	SDS	2	0.0625	0.6875	1.375	0.3125	5.8
1 B 54 SDS	5.0	5.4	5.75	C-1	SDS	2	0.3125	0.3125	1.375	0.1875	4.0	2 B 54 SDS	A-2	SDS	2	0.0625	0.6875	1.375	0.3125	6.1
1 B 56 SDS	5.2	5.6	5.95	C-1	SDS	2	0.3125	0.3125	1.375	0.1875	4.2	2 B 56 SDS	A-2	SDS	2	0.0625	0.6875	1.375	0.3125	6.6
1 B 58 SDS	5.4	5.8	6.15	C-1	SDS	2	0.3125	0.3125	1.375	0.1875	4.5	2 B 58 SDS	A-1	SDS	2	0.0625	0.6875	1.375	0.3125	7.2
1 B 60 SDS	5.6	6.0	6.35	C-1	SDS	2	0.3125	0.3125	1.375	0.1875	4.9	2 B 60 SDS	A-2	SDS	2	0.0625	0.6875	1.375	0.3125	7.6
1 B 62 SDS	5.8	6.2	6.55	C-2	SDS	2	0.3125	0.3125	1.375	0.1875	5.5	2 B 62 SDS	A-2	SDS	2	0.0625	0.6875	1.375	0.3125	7.0
1 B 64 SDS	6.0	6.4	6.75	C-2	SDS	2	0.3125	0.3125	1.375	0.1875	5.7	2 B 64 SDS	A-2	SDS	2	0.0625	0.6875	1.375	0.3125	7.0
1 B 66 SDS	6.2	6.6	6.95	C-2	SDS	2	0.3125	0.3125	1.375	0.1875	5.9	2 B 66 SDS	A-2	SDS	2	0.0625	0.6875	1.375	0.3125	9.0
1 B 68 SDS	6.4	6.8	7.15	C-2	SDS	2	0.3125	0.3125	1.375	0.1875	4.8	2 B 68 SDS	A-2	SDS	2	0.0625	0.6875	1.375	0.3125	9.2
1 B 70 SDS	6.6	7.0	7.35	C-2	SDS	2	0.5	0.125	1.375	0.125	5.8	2 B 70 SK	D-2	SK	2.625	0.25	0.4375	1.9375	0.0625	8.8
1 B 74 SDS	7.0	7.4	7.75	C-2	SDS	2	0.5	0.125	1.375	0.125	6.4	2 B 74 SK	D-2	SK	2.625	0.25	0.4375	1.9375	0.0625	11.0
1 B 80 SDS	7.6	8.0	8.35	C-3	SDS	2	0.5	0.125	1.375	0.125	6.8	2 B 80 SK	D-2	SK	2.625	0.25	0.4375	1.9375	0.0625	12.6
1 B 86 SDS	8.2	8.6	8.95	C-3	SDS	2	0.5	0.125	1.375	0.125	7.2	2 B 86 SK	D-3	SK	2.625	0.25	0.4375	1.9375	0.0625	12.0
1 B 94 SDS	9.0	9.4	9.75	C-3	SDS	2	0.5	0.125	1.375	0.125	8.0	2 B 94 SK	D-3	SK	2.625	0.25	0.4375	1.9375	0.0625	13.4
1 B 110 SDS	10.6	11.0	11.35	C-3	SDS	2	0.5	0.125	1.375	0.125	9.0	2 B 110 SK	D-3	SK	2.625	0.25	0.4375	1.9375	0.0625	16.4
1 B 124 SDS	12.0	12.4	12.75	C-3	SDS	2	0.5	0.125	1.375	0.125	11.0	2 B 124 SK	D-3	SK	2.625	0.25	0.4375	1.9375	0.0625	19.2
1 B 136 SDS	13.2	13.6	13.95	C-3	SDS	2	0.5	0.125	1.375	0.125	12.0	2 B 136 SK	D-3	SK	2.625	0.25	0.4375	1.9375	0.0625	19.0
1 B 154 SK	15.0	15.4	15.75	C-3	SK	2.625	0.5625	0.125	1.9375	0.375	13.0	2 B 154 SK	D-3	SK	2.625	0.25	0.4375	1.9375	0.0625	22.0
1 B 160 SK	15.6	16.0	16.35	C-3	SK	2.625	0.5625	0.125	1.9375	0.375	15.0	2 B 160 SK	D-3	SK	2.625	0.25	0.4375	1.9375	0.0625	26.0
1 B 184 SK	18.0	18.4	18.75	C-3	SK	2.625	0.5625	0.125	1.9375	0.375	19.0	2 B 184 SK	D-3	SK	2.625	0.25	0.4375	1.9375	0.0625	30.0
1 B 200 SK	19.6	20.0	20.35	C-3	SK	2.625	0.5625	0.125	1.9375	0.375	25.0	2 B 200 SF	D-3	SF	2.9375	0.3125	0.375	2.0625	—	35.0
—	24.6	25.0	25.35	—	—	—	—	—	—	—	—	2 B 250 SF	D-3	SF	2.9375	0.3125	0.375	2.0625	—	57.0
—	29.6	30.0	30.35	—	—	—	—	—	—	—	—	2 B 300 SF	D-3	SF	2.9375	0.3125	0.375	2.0625	—	80.0
—	37.6	38.0	38.35	—	—	—	—	—	—	—	—	2 B 380 SF	D-3	SF	2.9375	0.3125	0.375	2.0625	—	99.0

NOTE: Dimensions in inches, weight in pounds. Weights do not include bushings. See page B-3 and B-4 for additional bushing dimensions.

\* E and M dimensions are nominal and will vary depending on shaft tolerances. Type E sheaves are drilled for reverse mounting only.

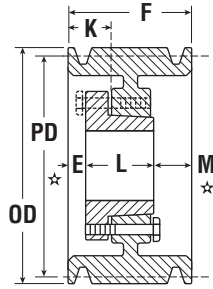

Type A

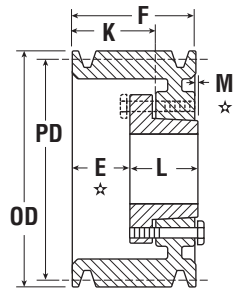

Type B

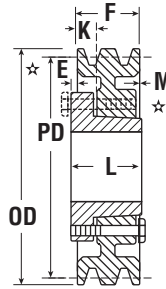

Type C

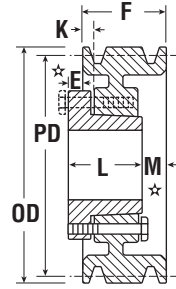

Type D

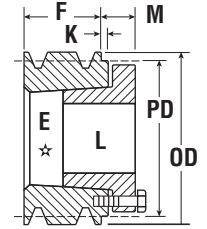

Type E

## QD Sheaves – A-B

3 Grooves F = 2½											4 Grooves F = 3¼									
Part Number	PD		QD	Type	Bush	Bush Max Bore	E ★	K	L Length Thru Bore	M ★	Wt. Less Bush	Part Number	Type	Bush	Bush Max Bore	E ★	K	L Length Thru Bore	M ★	Wt. Less Bush
	A Belt	B Belt																		
3 B 34 SH	3.0	3.4	3.75	E-1	SH	1.6875	1.75	—	0.9375	0.5625	3.4	4 B 34 SD	E-1	SD	2	2.375	0.3125	1.8125	0.9375	4.0
3 B 36 SH	3.2	3.6	3.95	E-1	SH	1.6875	0.375	0.1875	0.9375	1.1875	3.8	4 B 36 SD	E-1	SD	2	2.375	0.3125	1.8125	0.9375	5.0
3 B 38 SH	3.4	3.8	4.15	E-1	SH	1.6875	0.375	0.1875	0.9375	1.1875	4.0	4 B 38 SD	E-1	SD	2	2.375	0.3125	1.8125	0.9375	5.5
3 B 40 SH	3.6	4.0	4.35	A-1	SH	1.6875	0.5	0.6875	0.9375	0.6875	4.5	4 B 40 SD	E-1	SD	2	2.0625	—	1.8125	0.625	6.0
3 B 42 SH	3.8	4.2	4.55	A-1	SH	1.6875	0.5	0.6875	0.9375	0.6875	5.0	4 B 42 SD	E-1	SD	2	2.0625	—	1.8125	0.625	7.0
3 B 44 SH	4.0	4.4	4.75	A-1	SH	1.6875	0.5	0.6875	0.9375	0.6875	5.5	4 B 44 SD	E-1	SD	2	2.0625	—	1.8125	0.625	7.3
3 B 46 SD	4.2	4.6	4.95	A-1	SD	2	0.438	0.6875	1.8125	0.25	6.0	4 B 46 SD	A-1	SD	2	0.6875	0.9375	1.8125	0.75	7.6
3 B 48 SD	4.4	4.8	5.15	A-1	SD	2	0.438	0.6875	1.8125	0.25	6.5	4 B 48 SD	A-1	SD	2	0.6875	0.9375	1.8125	0.75	8.0
3 B 50 SD	4.6	5.0	5.35	A-1	SD	2	0.438	0.6875	1.8125	0.25	7.0	4 B 50 SD	A-1	SD	2	0.6875	0.9375	1.8125	0.75	9.0
3 B 52 SD	4.8	5.2	5.55	A-1	SD	2	0.438	0.6875	1.8125	0.25	8.0	4 B 52 SD	A-1	SD	2	0.6875	0.9375	1.8125	0.75	10.0
3 B 54 SD	5.0	5.4	5.75	A-1	SD	2	0.438	0.6875	1.8125	0.25	8.5	4 B 54 SD	A-1	SD	2	0.6875	0.9375	1.8125	0.75	10.5
3 B 56 SD	5.2	5.6	5.95	A-1	SD	2	0.438	0.6875	1.8125	0.25	9.0	4 B 56 SD	A-1	SD	2	0.6875	0.9375	1.8125	0.75	11.0
3 B 58 SD	5.4	5.8	6.15	A-1	SD	2	0.438	0.6875	1.8125	0.25	10.0	4 B 58 SD	A-1	SD	2	0.6875	0.9375	1.8125	0.75	12.0
3 B 60 SD	5.6	6.0	6.35	A-1	SD	2	0.438	0.6875	1.8125	0.25	11.0	4 B 60 SD	A-1	SD	2	0.6875	0.9375	1.8125	0.75	12.5
3 B 62 SD	5.8	6.2	6.55	A-1	SD	2	0.438	0.6875	1.8125	0.25	12.0	4 B 62 SD	A-1	SD	2	0.6875	0.9375	1.8125	0.75	13.0
3 B 64 SD	6.0	6.4	6.75	A-1	SD	2	0.438	0.6875	1.8125	0.25	12.3	4 B 64 SD	A-1	SD	2	0.6875	0.9375	1.8125	0.75	14.0
3 B 66 SD	6.2	6.6	6.95	A-1	SD	2	0.438	0.6875	1.8125	0.25	12.6	4 B 66 SD	A-1	SD	2	0.6875	0.9375	1.8125	0.75	14.5
3 B 68 SD	6.4	6.8	7.15	A-1	SD	2	0.438	0.6875	1.8125	0.25	13.0	4 B 68 SD	A-1	SD	2	0.6875	0.9375	1.8125	0.75	15.0
3 B 70 SK	6.6	7.0	7.35	A-1	SK	2.625	—	0.6875	1.9375	0.56	14.0	4 B 70 SK	A-1	SK	2.625	0.3125	1	1.9375	1	15.5
3 B 74 SK	7.0	7.4	7.75	A-1	SK	2.625	—	0.6875	1.9375	0.56	15.0	4 B 74 SK	A-1	SK	2.625	0.3125	1	1.9375	1	16.0
3 B 80 SK	7.6	8.0	8.35	A-1	SK	2.625	—	0.6875	1.9375	0.56	16.0	4 B 80 SK	A-1	SK	2.625	0.3125	1	1.9375	1	17.0
3 B 86 SK	8.2	8.6	8.95	A-3	SK	2.625	—	0.6875	1.9375	0.56	17.0	4 B 86 SK	A-3	SK	2.625	0.3125	1	1.9375	1	18.0
3 B 94 SK	9.0	9.4	9.75	A-3	SK	2.625	—	0.6875	1.9375	0.56	18.0	4 B 94 SK	A-3	SK	2.625	0.3125	1	1.9375	1	19.0
3 B 110 SK	10.6	11.0	11.35	A-3	SK	2.625	—	0.6875	1.9375	0.56	19.0	4 B 110 SK	A-3	SK	2.625	0.3125	1	1.9375	1	24.0
3 B 124 SK	12.0	12.4	12.75	A-3	SK	2.625	—	0.6875	1.9375	0.56	23.0	4 B 124 SK	A-3	SK	2.625	0.3125	1	1.9375	1	26.0
3 B 136 SK	13.2	13.6	13.95	A-3	SK	2.625	—	0.6875	1.9375	0.56	24.1	4 B 136 SK	A-3	SK	2.625	0.3125	1	1.9375	1	28.0
3 B 154 SK	15.0	15.4	15.75	A-3	SK	2.625	—	0.6875	1.9375	0.56	28.0	4 B 154 SF	A-3	SF	2.9375	0.3125	1	2.0625	0.875	41.0
3 B 160 SK	15.6	16.0	16.35	A-3	SK	2.625	—	0.6875	1.9375	0.56	29.0	4 B 160 SF	A-3	SF	2.9375	0.3125	1	2.0625	0.875	42.0
3 B 184 SK	18.0	18.4	18.75	A-3	SK	2.625	—	0.6875	1.9375	0.56	37.0	4 B 184 SF	A-3	SF	2.9375	0.3125	1	2.0625	0.875	48.0
3 B 200 SF	19.6	20.0	20.35	D-3	SF	2.9375	0.0625	0.625	2.0625	0.5	39.0	4 B 200 SF	A-3	SF	2.9375	0.3125	1	2.0625	0.875	58.0
3 B 250 SF	24.6	25.0	25.35	D-3	SF	2.9375	0.0625	0.625	2.0625	0.5	67.0	4 B 250 E	A-3	E	3.5	0.125	1	2.6250	0.5	78.0
3 B 300 SF	29.6	30.0	30.35	D-3	SF	2.9375	0.0625	0.625	2.0625	0.5	74.0	4 B 300 E	A-3	E	3.5	0.125	1	2.6250	0.5	93.0
3 B 380 E	37.6	38.0	38.35	D-3	E	3.5	0.25	0.625	2.625	0.125	122.0	4 B 380 E	A-3	E	3.5	0.125	1	2.6250	0.5	138.0

NOTE: Dimensions in inches, weight in pounds. Weights do not include bushings. See page B-3 and B-4 for additional bushing dimensions.  
★ E and M dimensions are nominal and will vary depending on shaft tolerances. Type E sheaves are drilled for reverse mounting only.

# A-B Combination Groove Conventional Stock QD Sheaves



1/2 x 5/16

**A**



2 1/32 x 1 1/32

**B**

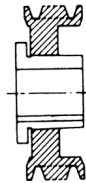

**1 = Solid**

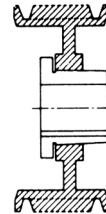

**2 = Web**

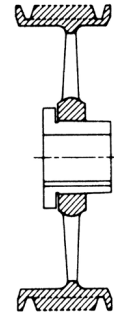

**3 = Arm/Spoke**

## QD Sheaves – A-B

5 Grooves F = 4												6 Grooves F = 4 3/4								
Part Number	PD		QD	Type	Bush	Bush Max Bore	E ★	K	L Length Thru Bore	M ★	Wt. Less Bush	Part Number	Type	Bush	Bush Max Bore	E ★	K	L Length Thru Bore	M ★	Wt. Less Bush
	A Belt	B Belt																		
5 B 34 SD	3.0	3.4	3.75	E-1	SD	2	3.25	0.4375	1.8125	1.0625	5.0	6 B 34 SD	E-1	SD	2	3.875	0.3125	1.8125	0.9375	6.0
5 B 36 SD	3.2	3.6	3.95	E-1	SD	2	3.25	0.4375	1.8125	1.0625	6.0	6 B 36 SD	E-1	SD	2	3.875	0.3125	1.8125	0.8125	7.0
5 B 38 SD	3.4	3.8	4.15	E-1	SD	2	3.125	0.3125	1.8125	1.3125	6.5	6 B 38 SD	E-1	SD	2	3.875	0.3125	1.8125	0.8125	7.5
5 B 40 SD	3.6	4.0	4.35	E-1	SD	2	2.813	–	1.8125	0.625	7.0	6 B 40 SD	E-1	SD	2	3.5625	–	1.8125	0.625	8.0
5 B 42 SD	3.8	4.2	4.55	E-1	SD	2	2.8125	–	1.8125	0.625	7.5	6 B 42 SD	E-1	SD	2	3.5625	–	1.8125	0.625	9.0
5 B 44 SD	4.0	4.4	4.75	E-1	SD	2	2.8125	–	1.8125	0.625	8.0	6 B 44 SD	E-1	SD	2	3.5625	–	1.8125	0.625	9.5
5 B 46 SD	4.2	4.6	4.95	A-1	SD	2	0.6875	1.3125	1.8125	1.5	9.0	6 B 46 SD	A-1	SD	2	3.5625	1.1875	1.8125	2.375	10.0
5 B 48 SD	4.4	4.8	5.15	A-1	SD	2	0.6875	1.3125	1.8125	1.5	9.5	6 B 48 SD	A-1	SD	2	2.25	1.1875	1.8125	2.375	10.5
5 B 50 SD	4.6	5.0	5.35	A-1	SD	2	0.6875	1.3125	1.8125	1.5	10.0	6 B 50 SD	A-1	SD	2	2.25	1.1875	1.8125	2.375	11.0
5 B 52 SD	4.8	5.2	5.55	A-1	SD	2	0.6875	1.3125	1.8125	1.5	10.5	6 B 52 SD	A-1	SD	2	2.25	1.1875	1.8125	2.375	11.5
5 B 54 SK	5.0	5.4	5.75	A-1	SK	2.625	0.625	1.3125	1.9375	1.4375	11.0	6 B 54 SK	A-1	SK	2.63	0.625	1.3125	1.9375	2.1875	12.0
5 B 56 SK	5.2	5.6	5.95	A-1	SK	2.625	0.625	1.3125	1.9375	1.4375	11.5	6 B 56 SK	A-1	SK	2.63	0.625	1.3125	1.9375	2.1875	13.0
5 B 58 SK	5.4	5.8	6.15	A-1	SK	2.625	0.625	1.3125	1.9375	1.4375	12.0	6 B 58 SK	A-1	SK	2.63	0.625	1.3125	1.9375	2.1875	14.0
5 B60 SK	5.6	6.0	6.35	A-1	SK	2.625	0.625	1.3125	1.9375	1.4375	13.0	6 B60 SK	A-1	SK	2.63	0.625	1.3125	1.9375	2.1875	15.0
5 B62 SK	5.8	6.2	6.55	A-1	SK	2.625	0.625	1.3125	1.9375	1.4375	14.0	6 B62 SK	A-1	SK	2.63	0.625	1.3125	1.9375	2.1875	16.0
5 B64 SK	6.0	6.4	6.75	A-1	SK	2.625	0.625	1.3125	1.9375	1.4375	15.0	6 B64 SK	A-1	SK	2.63	0.625	1.3125	1.9375	2.1875	17.0
5 B66 SK	6.2	6.6	6.95	A-1	SK	2.625	0.625	1.3125	1.9375	1.4375	16.0	6 B66 SK	A-1	SK	2.63	0.625	1.3125	1.9375	2.1875	18.0
5 B68 SK	6.4	6.8	7.15	A-1	SK	2.625	0.625	1.3125	1.9375	1.4375	17.0	6 B68 SK	A-1	SK	2.63	0.625	1.3125	1.9375	2.1875	19.0
5 B 70 SF	6.6	7.0	7.35	A-1	SF	2.9375	0.625	1.3125	2.0625	1.3125	18.0	6 B 70 SF	A-1	SF	2.94	1	1.6875	2.0625	1.6875	19.5
5 B 74 SF	7.0	7.4	7.75	A-1	SF	2.9375	0.625	1.3125	2.0625	1.3125	20.0	6 B 74 SF	A-1	SF	2.94	1	1.6875	2.0625	1.6875	22.0
5 B 80 SF	7.6	8.0	8.35	A-1	SF	2.9375	0.625	1.3125	2.0625	1.3125	23.0	6 B 80 SF	A-1	SF	2.94	1	1.6875	2.0625	1.6875	25.0
5 B 86 SF	8.2	8.6	8.95	A-2	SF	2.9375	0.625	1.3125	2.0625	1.3125	24.0	6 B 86 SF	A-2	SF	2.94	1	1.6875	2.0625	1.6875	28.0
5 B 94 SF	9.0	9.4	9.75	A-2	SF	2.9375	0.625	1.3125	2.0625	1.3125	26.0	6 B 94 SF	A-2	SF	2.94	1	1.6875	2.0625	1.6875	29.0
5 B 110 SF	10.6	11.0	11.35	A-2	SF	2.9375	0.625	1.3125	2.0625	1.3125	32.0	6 B 110 SF	A-2	SF	2.94	1	1.6875	2.0625	1.6875	30.0
5 B 124 SF	12.0	12.4	12.75	A-3	SF	2.9375	0.625	1.3125	2.0625	1.3125	35.0	6 B 124 SF	A-3	SF	2.94	1	1.6875	2.0625	1.6875	40.0
5 B 136 SF	13.2	13.6	13.95	A-3	SF	2.9375	0.625	1.3125	2.0625	1.3125	36.0	6 B 136 SF	A-3	SF	2.94	1	1.6875	2.0625	1.6875	45.0
5 B 154 SF	15.0	15.4	15.75	A-3	SF	2.9375	0.625	1.3125	2.0625	1.3125	46.0	6 B 154 SF	A-3	SF	2.94	1	1.6875	2.0625	1.6875	46.0
5 B 160 SF	15.6	16.0	16.35	A-3	SF	2.9375	0.625	1.3125	2.0625	1.3125	48.0	6 B 160 SF	A-3	SF	2.94	1	1.6875	2.0625	1.6875	50.0
5 B 184 SF	18.0	18.4	18.75	A-3	SF	2.9375	0.625	1.3125	2.0625	1.3125	50.0	6 B 184 SF	A-3	SF	2.94	1	1.6875	2.0625	1.6875	60.0
5 B 200 E	19.6	20.0	20.35	A-3	E	3.5	0.375	1.250	2.625	1	72.0	6 B 200 E	A-3	E	3.5	0.5	1.375	2.625	1.625	78.0
5 B 250 E	24.6	25.0	25.35	A-3	E	3.5	0.375	1.250	2.625	1	90.0	6 B 250 E	A-3	E	3.5	0.5	1.375	2.625	1.625	98.0
5 B 300 E	29.6	30.0	30.35	A-3	E	3.5	0.375	1.250	2.625	1	108.0	6 B 300 E	A-3	E	3.5	0.5	1.375	2.625	1.625	109.0
5 B 380 E	37.6	38.0	38.35	A-3	E	3.5	0.375	1.250	2.625	1	145.0	6 B 380 E	A-3	E	3.5	0.5	1.375	2.625	1.625	173.0

NOTE: Dimensions in inches, weight in pounds. Weights do not include bushings. See page B-3 and B-4 for additional bushing dimensions.  
★ E and M dimensions are nominal and will vary depending on shaft tolerances. Type E sheaves are drilled for reverse mounting only.

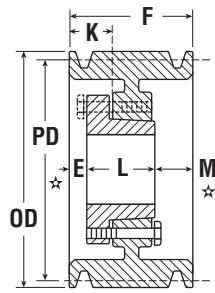

Type A

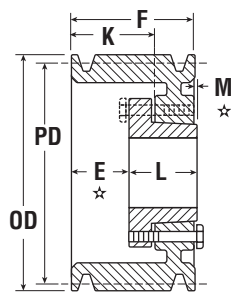

Type B

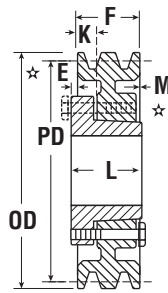

Type C

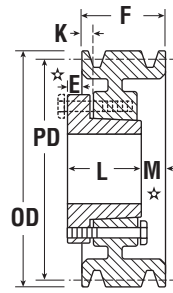

Type D

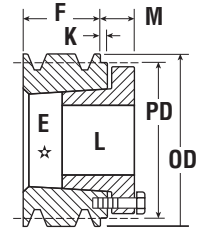

Type E



$\frac{1}{2} \times \frac{5}{16}$

A



$\frac{21}{32} \times \frac{13}{32}$

B

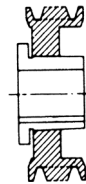

1 = Solid

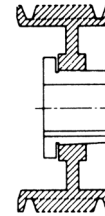

2 = Web

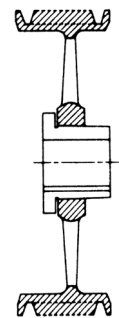

3 = Arm/Spoke

## QD Sheaves – A-B

8 Grooves F = 6 $\frac{1}{4}$												10 Grooves F = 7 $\frac{3}{4}$								
Part Number	PD		QD	Type	Bush	Bush Max Bore	E *	K	L Length Thru Bore	M *	Wt. Less Bush	Part Number	Type	Bush	Bush Max Bore	E *	K	L Length Thru Bore	M *	Wt. Less Bush
	A Belt	B Belt																		
8 B 54 SK	5.0	5.4	5.75	A-1	SK	2.625	1.125	1.8125	1.9375	3.1875	14.0	10 B 54 SK	A-1	SK	2.625	1.875	2.5625	1.9375	3.9375	15.0
8 B 56 SK	5.2	5.6	5.95	A-1	SK	2.625	1.125	1.8125	1.9375	3.1875	16.0	10 B 56 SK	A-1	SK	2.625	1.875	2.5625	1.9375	3.9375	18.0
8 B 58 SK	5.4	5.8	6.15	A-1	SK	2.625	1.125	1.8125	1.9375	3.1875	16.5	10 B 58 SK	A-1	SK	2.625	1.875	2.5625	1.9375	3.9375	20.0
8 B 60 SF	5.6	6.0	6.35	A-1	SF	2.9375	1.125	1.8125	2.0625	3.0625	17.0	10 B 60 SF	A-1	SF	2.9375	1.875	2.5625	2.0625	3.8125	22.0
8 B 62 SF	5.8	6.2	6.55	A-1	SF	2.9375	1.125	1.8125	2.0625	3.0625	18.0	10 B 62 SF	A-1	SF	2.9375	1.875	2.5625	2.0625	3.8125	24.0
8 B 64 SF	6.0	6.4	6.75	A-1	SF	2.9375	1.125	1.8125	2.0625	3.0625	18.5	10 B 64 SF	A-1	SF	2.9375	1.875	2.5625	2.0625	3.8125	25.0
8 B 66 SF	6.2	6.6	6.95	A-1	SF	2.9375	1.125	1.8125	2.0625	3.0625	21.0	10 B 66 SF	A-1	SF	2.9375	1.875	2.5625	2.0625	3.8125	26.0
8 B 68 SF	6.4	6.8	7.15	A-1	SF	2.9375	1.125	1.8125	2.0625	3.0625	22.0	10 B 68 SF	A-1	SF	2.9375	1.875	2.5625	2.0625	3.8125	27.0
8 B 70 SF	6.6	7.0	7.35	A-1	SF	2.9375	1.125	1.8125	2.0625	3.0625	22.5	10 B 70 SF	A-1	SF	2.9375	1.875	2.5625	2.0625	3.8125	28.0
8 B 74 SF	7.0	7.4	7.75	A-1	SF	2.9375	1.125	1.8125	2.0625	3.0625	25.0	10 B 74 SF	A-1	SF	2.9375	1.875	2.5625	2.0625	3.8125	31.0
8 B 80 SF	7.6	8.0	8.35	A-1	SF	2.9375	1.125	1.8125	2.0625	3.0625	29.0	10 B 80 SF	A-1	SF	2.9375	1.875	2.5625	2.0625	3.8125	35.0
8 B 86 E	8.2	8.6	8.95	A-1	E	3.5	1.5	2.375	2.625	2.125	34.0	10 B 86 E	A-1	E	3.5	2.25	3.125	2.625	2.875	38.0
8 B 94 E	9.0	9.4	9.75	A-1	E	3.5	1.5	2.375	2.625	2.125	40.0	10 B 94 E	A-1	E	3.5	2.25	3.125	2.625	2.875	45.0
8 B 110 E	10.6	11.0	11.35	A-2	E	3.5	1.5	2.375	2.625	2.125	47.0	10 B 110 E	A-2	E	3.5	2.25	3.125	2.625	2.875	53.0
8 B 124 E	12.0	12.4	12.75	A-3	E	3.5	1.5	2.375	2.625	2.125	52.0	10 B 124 E	A-3	E	3.5	2.25	3.125	2.625	2.875	63.0
8 B 136 E	13.2	13.6	13.95	A-3	E	3.5	1.5	2.375	2.625	2.125	60.0	10 B 136 F	A-3	F	3.9375	1.0625	2.0625	3.625	3.0625	78.0
8 B 154 E	15.4	15.4	15.75	A-3	E	3.5	1.5	2.375	2.625	2.125	82.0	10 B 154 F	A-3	F	3.9375	1.0625	2.0625	3.625	3.0625	90.0
8 B 160 E	15.6	16.0	16.35	A-3	E	3.5	1.5	2.375	2.625	2.125	90.0	10 B 160 F	A-3	F	3.9375	1.0625	2.0625	3.625	3.0625	96.0
8 B 184 F	18.0	18.4	18.75	A-3	F	3.9375	0.3125	1.3125	3.625	2.3125	110.0	10 B 184 F	A-3	F	3.9375	1.0625	2.0625	3.625	3.0625	113.0
8 B 200 F	19.6	20.0	20.35	A-3	F	3.9375	0.3125	1.3125	3.625	2.3125	122.0	10 B 200 F	A-3	F	3.9375	1.0625	2.0625	3.625	3.0625	114.0
8 B 250 F	24.6	25.0	25.35	A-3	F	3.9375	0.3125	1.3125	3.625	2.3125	138.0	10 B 250 F	A-3	F	3.9375	1.0625	2.0625	3.625	3.0625	138.0
8 B 300 F	29.6	30.0	30.35	A-3	F	3.9375	0.3125	1.3125	3.625	2.3125	168.0	10 B 300 F	A-3	F	3.9375	1.0625	2.0625	3.625	3.0625	200.0
8 B 380 F	37.6	38.0	38.35	A-3	F	3.9375	0.3125	1.3125	3.625	2.3125	222.0	10 B 380 J	A-3	J	4.5	0.375	1.5625	4.5	2.875	279.0

NOTE: Dimensions in inches, weight in pounds. Weights do not include bushings. See page B-3 and B-4 for additional bushing dimensions.  
 \* E and M dimensions are nominal and will vary depending on shaft tolerances. Type E sheaves are drilled for reverse mounting only.

# C Conventional Stock QD Sheaves

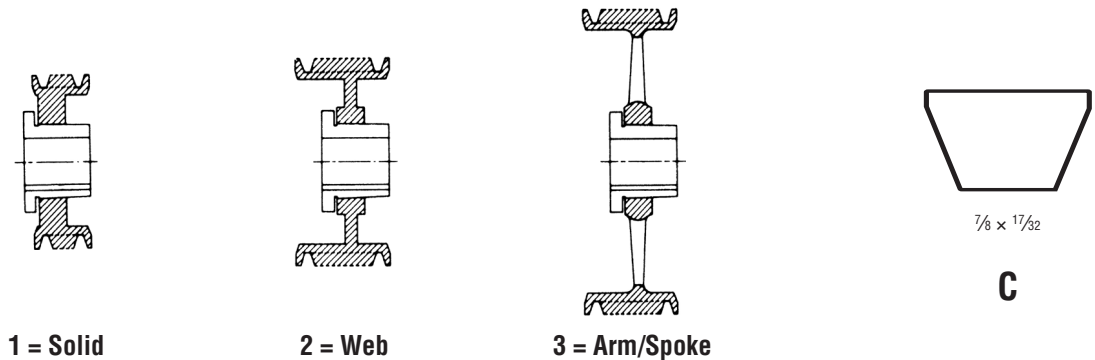
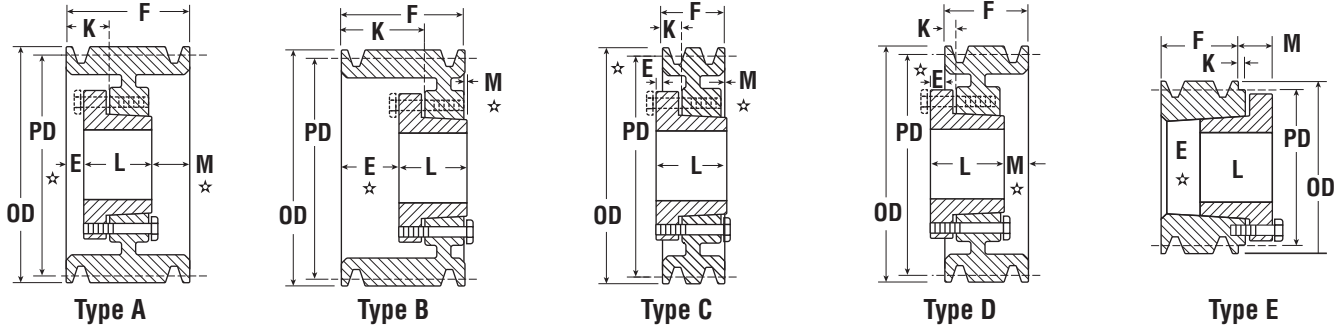

## QD Sheaves – C

1 Groove F = 1 3/8										2 Grooves F = 2 3/8									
Part Number	PD	QD	Type	Bush	Bush Max Bore	E *	K	L Length Thru Bore	M *	Wt. Less Bush	Part Number	Type	Bush	Bush Max Bore	E *	K	L Length Thru Bore	M *	Wt. Less Bush
	C Belt																		
1 C 60 SK	6.0	6.4	C-1	SK	2.625	0.5625	0.125	1.9375	0	9.4	2 C 60 SF	A-1	SF	2.9375	0.188	0.875	2.0625	0.125	8.0
1 C 70 SF	7.0	7.4	C-1	SF	2.9375	0.5625	0.125	2.0625	0.125	9.8	2 C 70 SF	A-1	SF	2.9375	0.125	0.8125	2.0625	0.1875	12.0
1 C 75 SF	7.5	7.9	C-1	SF	2.9375	0.5625	0.125	2.0625	0.125	11.0	2 C 75 SF	A-1	SF	2.9375	0.125	0.8125	2.0625	0.1875	15.0
1 C 80 SF	8.0	8.4	C-1	SF	2.9375	0.5625	0.125	2.0625	0.125	13.0	2 C 80 SF	A-1	SF	2.9375	0.125	0.8125	2.0625	0.1875	16.0
1 C 85 SF	8.5	8.9	C-1	SF	2.9375	0.5625	0.125	2.0625	0.125	13.3	2 C 85 SF	A-1	SF	2.9375	0.125	0.8125	2.0625	0.1875	19.0
1 C 90 SF	9.0	9.4	C-3	SF	2.9375	0.5625	0.125	2.0625	0.125	13.5	2 C 90 SF	A-2	SF	2.9375	0.125	0.8125	2.0625	0.1875	19.5
1 C 95 SF	9.5	9.9	C-3	SF	2.9375	0.5625	0.125	2.0625	0.125	13.8	2 C 95 SF	A-2	SF	2.9375	0.125	0.8125	2.0625	0.1875	21.0
1 C 100 SF	10.0	10.4	C-3	SF	2.9375	0.5625	0.125	2.0625	0.125	14.0	2 C 100 SF	A-2	SF	2.9375	0.125	0.8125	2.0625	0.1875	22.0
1 C 105 SF	10.5	10.9	C-3	SF	2.9375	0.5625	0.125	2.0625	0.125	15.0	2 C 105 SF	A-2	SF	2.9375	0.125	0.8125	2.0625	0.1875	25.0
1 C 110 SF	11.0	11.4	C-3	SF	2.9375	0.5625	0.125	2.0625	0.125	15.8	2 C 110 SF	A-3	SF	2.9375	0.125	0.8125	2.0625	0.1875	26.0
1 C 120 SF	12.0	12.4	C-3	SF	2.9375	0.5625	0.125	2.0625	0.125	17.0	2 C 120 SF	D-3	SF	2.9375	0.125	0.5625	2.0625	0.4375	29.0
1 C 130 SF	13.0	13.4	C-3	SF	2.9375	0.5625	0.125	2.0625	0.125	18.0	2 C 130 SF	D-3	SF	2.9375	0.125	0.5625	2.063	0.4375	31.0
1 C 140 SF	14.0	14.4	C-3	SF	2.9375	0.5625	0.125	2.0625	0.125	20.0	2 C 140 SF	D-3	SF	2.9375	0.125	0.5625	2.063	0.4375	35.0
1 C 150 SF	15.0	15.4	C-3	SF	2.9375	0.5625	0.125	2.0625	0.125	21.0	2 C 150 SF	D-3	SF	2.9375	0.125	0.5625	2.063	0.4375	39.0
1 C 160 SF	16.0	16.4	C-3	SF	2.9375	0.5625	0.125	2.0625	0.125	24.0	2 C 160 SF	D-3	SF	2.9375	0.125	0.5625	2.063	0.4375	43.0
1 C 180 SF	18.0	18.4	C-3	SF	2.9375	0.5625	0.125	2.0625	0.125	27.0	2 C 180 SF	D-3	SF	2.9375	0.125	0.5625	2.0625	0.4375	48.0
1 C 200 SF	20.0	20.4	C-3	SF	2.9375	0.5625	0.125	2.0625	0.125	31.0	2 C 200 SF	D-3	SF	2.9375	0.125	0.5625	2.0625	0.4375	55.0
1 C 240 SF	24.0	24.4	C-3	SF	2.9375	0.5625	0.125	2.0625	0.125	37.0	2 C 240 SF	D-3	SF	2.9375	0.125	0.5625	2.0625	0.4375	65.0
-	27.0	27.4	-	-	-	-	-	-	-	-	2 C 270 F	C-3	F	3.9375	0.6875	0.3125	3.625	0.5625	107.0
-	30.0	30.4	-	-	-	-	-	-	-	-	2 C 300 F	C-3	F	3.9375	0.6875	0.3125	3.625	0.5625	115.0

NOTE: Dimensions in inches, weight in pounds. Weights do not include bushings. See page B-3 and B-4 for additional bushing dimensions.  
 \* E and M dimensions are nominal and will vary depending on shaft tolerances. Type E sheaves are drilled for reverse mounting only.





# Conventional Stock QD Sheaves C

3 Grooves											4 Grooves								
F = 3 <sup>3</sup> / <sub>8</sub>											F = 4 <sup>3</sup> / <sub>8</sub>								
Part Number	PD	QD	Type	Bush	Bush Max Bore	E *	K	L Length Thru Bore	M *	Wt. Less Bush	Part Number	Type	Bush	Bush Max Bore	E *	K	L Length Thru Bore	M *	Wt. Less Bush
	C Belt																		
3 C 50 SD	5.0	5.4	A-1	SD	2	0.63	1.250	1.8125	1	8.0	4 C 50 SD	A-1	SD	2	0.625	1.25	1.8125	1.9375	10.0
3 C 54 SD	5.4	5.8	A-1	SD	2	0.7	1.3	1.8125	0.9	9.0	4 C 54 SD	A-1	SD	2	0.6875	1.3125	1.8125	1.875	12.0
3 C 55 SD	5.5	5.9	A-1	SD	2	0.7	1.3	1.8125	0.9	10.0	4 C 55 SD	A-1	SD	2	0.6875	1.3125	1.8125	1.875	12.4
3 C 56 SD	5.6	6.0	A-1	SD	2	0.7	1.3	1.8125	0.9	11.0	4 C 56 SD	A-1	SD	2	0.6875	1.3125	1.8125	1.875	12.4
3 C 60 SF	6.0	6.4	A-1	SF	2.9375	0.2	0.9	2.1	1.1	12.0	4 C 60 SF	A-1	SF	2.9375	0.1875	0.875	2.0625	2.125	12.6
3 C 70 SF	7.0	7.4	A-1	SF	2.9375	0.6	1.3	2.1	0.7	14.0	4 C 70 SF	A-2	SF	2.9375	0.875	1.1875	2.0625	1.4375	13.0
3 C 75 SF	7.5	7.9	A-1	SF	2.9375	0.6	1.3	2.1	0.7	17.0	4 C 75 SF	A-2	SF	2.9375	0.875	1.1875	2.0625	1.4375	19.0
3 C 80 E	8.0	8.4	B-1	E	3.5	0.9	1.8	2.6	0.1	19.0	4 C 80 E	A-2	E	3.5	1.125	2	2.625	0.625	24.0
3 C 85 E	8.5	8.9	B-1	E	3.5	0.9	1.8	2.6	0.1	22.0	4 C 85 E	A-1	E	3.5	1.125	2	2.625	0.625	27.0
3 C 90 E	9.0	9.4	B-1	E	3.5	0.9	1.8	2.6	0.1	26.0	4 C 90 E	A-1	E	3.5	1.125	2	2.625	0.625	30.0
3 C 95 E	9.5	9.9	B-1	E	3.5	0.9	1.8	2.6	0.1	29.0	4 C 95 E	A-1	E	3.5	1.125	2	2.625	0.625	33.0
3 C 100 E	10.0	10.4	B-1	E	3.5	0.9	1.8	2.6	0.1	27.0	4 C 100 E	A-1	E	3.5	1.125	2	2.625	0.625	35.0
3 C 105 E	10.5	10.9	B-2	E	3.5	0.9	1.8	2.6	0.1	31.0	4 C 105 E	A-2	E	3.5	1.125	2	2.625	0.625	40.0
3 C 110 E	11.0	11.4	B-2	E	3.5	0.9	1.8	2.6	0.1	38.0	4 C 110 E	A-1	E	3.5	1.125	2	2.625	0.625	45.0
3 C 120 E	12.0	12.4	B-3	E	3.5	0.9	1.8	2.6	0.1	40.0	4 C 120 E	A-1	E	3.5	1.125	2	2.625	0.625	48.0
3 C 130 E	13.0	13.4	B-3	E	3.5	0.9	1.8	2.6	0.1	43.0	4 C 130 E	A-3	E	3.5	1.125	2	2.625	0.625	49.0
3 C 140 E	14.0	14.4	B-3	E	3.5	0.9	1.8	2.6	0.1	46.0	4 C 140 E	A-3	E	3.5	1.125	2	2.625	0.625	56.0
3 C 150 E	15.0	15.4	B-3	E	3.5	0.9	1.8	2.6	0.1	52.0	4 C 150 E	A-3	E	3.5	1.125	2	2.625	0.625	62.0
3 C 160 E	16.0	16.4	B-3	E	3.5	0.9	1.8	2.6	0.1	58.0	4 C 160 E	A-3	E	3.5	1.125	2	2.625	0.625	68.0
3 C 180 E	18.0	18.4	B-3	E	3.5	0.9	1.8	2.6	0.1	67.0	4 C 180 E	A-3	E	3.5	1.125	2	2.625	0.625	74.0
3 C 200 E	20.0	20.4	A-3	E	3.5	0.1	1.0	2.6	0.6	70.0	4 C 200 E	A-3	E	3.5	0.625	2	2.625	1.125	81.0
3 C 240 E	24.0	24.4	A-3	E	3.5	0.1	1.0	2.6	0.6	90.0	4 C 240 F	A-3	F	3.9375	0.3125	1.3125	3.625	0.4375	120.0
3 C 270 F	27.0	27.4	C-3	F	3.94	0.2	1.2	3.6	0.1	124.0	4 C 270 F	A-3	F	3.9375	0.3125	1.3125	3.625	0.4375	138.0
3 C 300 F	30.0	30.4	C-3	F	3.94	0.2	1.2	3.6	0.1	130.0	4 C 300 F	A-3	F	3.9375	0.3125	1.3125	3.625	0.4375	166.0
3 C 360 F	36.0	36.4	C-3	F	3.94	0.2	1.2	3.6	0.1	166.0	4 C 360 F	A-3	F	3.9375	0.3125	1.3125	3.625	0.4375	176.0
3 C 440 F	44.0	44.4	C-3	F	3.94	0.2	1.2	3.6	0.1	208.0	4 C 440 J	B-3	J	4.5	0.375	1.5625	4.5	0.5	254.0
3 C 500 F	50.0	50.4	C-3	F	3.94	0.2	1.2	3.6	0.1	250.0	4 C 500 J	B-3	J	4.5	0.375	1.5625	4.5	0.5	318.0

5 Grooves											6 Grooves								
F = 5 <sup>3</sup> / <sub>8</sub>											F = 6 <sup>3</sup> / <sub>8</sub>								
Part Number	PD	QD	Type	Bush	Bush Max Bore	E *	K	L Length Thru Bore	M *	Wt. Less Bush	Part Number	Type	Bush	Bush Max Bore	E *	K	L Length Thru Bore	M *	Wt. Less Bush
	C Belt																		
5 C 60 SF	6.0	6.4	A-1	SF	2.9375	0.375	0.875	2.0625	3.125	14.0	6 C 60 SF	A-1	SF	2.9375	0.1875	0.875	2.0625	4.125	16.0
5 C 70 SF	7.0	7.4	A-1	SF	2.9375	1.25	1.9375	2.0625	2.0625	19.0	6 C 70 SF	A-1	SF	2.9375	1.25	1.9375	2.0625	3.0625	22.0
5 C 75 SF	7.5	7.9	A-1	SF	2.9375	1.25	1.9375	2.0625	2.0625	22.0	6 C 75 SF	A-1	SF	2.9375	1.25	1.9375	2.0625	3.0625	25.0
5 C 80 E	8.0	8.4	A-1	E	3.5	1.5	2.375	2.625	1.25	28.0	6 C 80 E	A-1	E	3.5	1.5	2.375	2.625	2.25	31.0
5 C 85 E	8.5	8.9	A-1	E	3.5	1.5	2.375	2.625	1.25	31.0	6 C 85 E	A-1	E	3.5	1.5	2.375	2.625	2.25	35.0
5 C 90 E	9.0	9.4	A-1	E	3.5	1.5	2.375	2.625	1.25	32.0	6 C 90 F	A-1	F	3.9375	1.4375	2.4375	3.625	1.3125	40.0
5 C 95 E	9.5	9.9	A-1	E	3.5	1.5	2.375	2.625	1.25	36.0	6 C 95 F	A-1	F	3.9375	1.4375	2.4375	3.625	1.3125	44.0
5 C 100 E	10	10.4	A-2	E	3.5	1.5	2.375	2.625	1.25	38.0	6 C 100 F	A-1	F	3.9375	1.4375	2.4375	3.625	1.3125	50.0
5 C 105 E	10.5	10.9	A-2	E	3.5	1.5	2.375	2.625	1.25	43.0	6 C 105 F	A-1	F	3.9375	1.4375	2.4375	3.625	1.3125	56.0
5 C 110 E	11	11.4	A-1	E	3.5	1.5	2.375	2.625	1.25	50.0	6 C 110 F	A-1	F	3.9375	1.4375	2.4375	3.625	1.3125	60.0
5 C 120 E	12	12.4	A-1	E	3.5	1.5	2.375	2.625	1.25	55.0	6 C 120 F	A-1	F	3.9375	1.4375	2.4375	3.625	1.3125	65.0
5 C 130 E	13	13.4	A-3	E	3.5	1.5	2.375	2.625	1.25	58.0	6 C 130 F	A-3	F	3.9375	1.4375	2.4375	3.625	1.3125	67.0
5 C 140 E	14	14.4	A-3	E	3.5	1.5	2.375	2.625	1.25	61.0	6 C 140 F	A-3	F	3.9375	1.4375	2.4375	3.625	1.3125	75.0
5 C 150 E	15	15.4	A-3	E	3.5	1.5	2.375	2.625	1.25	69.0	6 C 150 F	A-3	F	3.9375	1.4375	2.4375	3.625	1.3125	91.0
5 C 160 E	16	16.4	A-3	E	3.5	1.5	2.375	2.625	1.25	75.0	6 C 160 F	A-3	F	3.9375	1.4375	2.4375	3.625	1.3125	93.0
5 C 180 E	18	18.4	A-3	E	3.5	1.5	2.375	2.625	1.25	85.0	6 C 180 F	A-3	F	3.9375	1.4375	2.4375	3.625	1.3125	106.0
5 C 200 F	20	20.4	A-3	F	3.9375	0.3125	1.3125	3.625	1.4375	108.0	6 C 200 F	A-3	F	3.9375	1.3125	1.9375	3.625	1.8125	125.0
5 C 240 F	24	24.4	A-3	F	3.9375	0.3125	1.3125	3.625	1.4375	124.0	6 C 240 F	A-3	F	3.9375	1.3125	1.9375	3.625	1.8125	162.0
5 C 270 F	27	27.4	A-3	F	3.9375	0.3125	1.3125	3.625	1.4375	154.0	6 C 270 J	A-3	J	3.9375	0.375	1.5625	4.5	1.5	190.0
5 C 300 F	30	30.4	A-3	F	3.9375	0.3125	1.3125	3.625	1.4375	174.0	6 C 300 J	A-3	J	4.5	0.375	1.5625	4.5	1.5	229.0
5 C 360 J	36	36.4	A-3	J	4.5	0.375	1.5625	4.5	0.5	226.0	6 C 360 J	A-3	J	4.5	0.375	1.5625	4.5	1.5	270.0
5 C 440 J	44	44.4	A-3	J	4.5	0.375	1.5625	4.5	0.5	289.0	6 C 440 J	A-3	J	4.5	0.375	1.5625	4.5	1.5	301.0
5 C 500 J	50	50.4	A-3	J	4.5	0.375	1.5625	4.5	0.5	316.0	6 C 500 M	B-3	M	5.5	0.5	1.9375	6.75	0.875	444.0

# C Conventional Stock QD Sheaves



## QD Sheaves – C

8 Grooves										10 Grooves										
F = 8 <sup>3</sup> / <sub>8</sub>										F = 10 <sup>3</sup> / <sub>8</sub>										
Part Number	PD C Belt	QD	Type	Bush	Bush Max Bore	E ★	K	L Length Thru Bore	M ★	Wt. Less Bush	Part Number	Type	Bush	Bush Max Bore	E ★	K	L Length Thru Bore	M ★	Wt. Less Bush	
8 C 70 SF	7	7.4	A-1	SF	2.9375	2.3125	3	2.0625	4	35.0	–	–	–	–	–	–	–	–	–	–
8 C 80 E	8	8.4	A-1	E	3.5	2.375	3.25	2.625	3.375	36.6	10 C 80 E	A-1	E	4	2.375	3.25	2.625	5.375	42.8	
8 C 85 E	8.5	8.9	A-1	E	3.5	2.375	3.25	2.625	3.375	41.0	10 C 85 E	A-1	E	4	2.375	3.25	2.625	5.375	48.5	
8 C 90 F	9	9.4	A-1	F	3.9375	2.3125	3.3125	3.625	2.4375	50.0	10 C 90 J	A-1	J	5	2.375	3.5625	4.5	3.5	54.0	
8 C 95 F	9.5	9.9	A-1	F	3.9375	2.3125	3.3125	3.625	2.4375	51.0	10 C 95 J	A-1	J	4.5	2.375	3.5625	4.5	3.5	60.0	
8 C 100 F	10	10.4	A-1	F	3.9375	2.3125	3.3125	3.625	2.4375	60.0	10 C 100 J	A-1	J	4.5	2.375	3.5625	4.5	3.5	68.0	
8 C 105 F	10.5	10.9	A-1	F	3.9375	2.3125	3.3125	3.625	2.4375	67.0	10 C 105 J	A-1	J	4.5	2.375	3.5625	4.5	3.5	75.0	
8 C 110 F	11	11.4	A-1	F	3.9375	2.3125	3.3125	3.625	2.4375	74.0	10 C 110 J	A-1	J	4.5	2.375	4	4.5	3.5	90.0	
8 C 120 F	12	12.4	A-1	F	3.9375	2.3125	3.3125	3.625	2.4375	87.0	10 C 120 J	A-1	J	4.5	2.375	4	4.5	3.5	106.0	
8 C 130 F	13	13.4	A-3	F	3.9375	2.3125	3.3125	3.625	2.4375	94.0	10 C 130 J	A-2	J	4.5	2.375	4	4.5	3.5	110.0	
8 C 140 F	14	14.4	A-3	F	3.9375	2.3125	3.3125	3.625	2.4375	99.0	10 C 140 J	A-2	J	4.5	2.375	4	4.5	3.5	124.0	
8 C 150 F	15	15.4	A-2	F	3.9375	2.3125	3.3125	3.625	2.4375	111.0	10 C 150 J	A-2	J	4.5	2.375	4	4.5	3.5	138.0	
8 C 160 F	16	16.4	A-3	F	3.9375	2.3125	3.3125	3.625	2.4375	112.0	10 C 160 J	A-3	J	4.5	2.375	4	4.5	3.5	139.0	
8 C 180 F	18	18.4	A-3	F	3.9375	2.3125	3.3125	3.625	2.4375	116.0	10 C 180 J	A-3	J	4.5	2.375	4	4.5	3.5	168.0	
8 C 200 J	20	20.4	A-3	J	4.5	0.375	1.5625	4.5	3.5	146.0	10 C 200 J	A-3	J	4.5	2.375	4	4.5	3.5	182.0	
8 C 240 J	24	24.4	A-3	J	4.5	0.375	1.5625	4.5	3.5	195.0	10 C 240 M	A-3	M	5.5	0.500	2	6.75	3.125	272.0	
8 C 270 J	27	27.4	A-3	J	4.5	0.375	1.5625	4.5	3.5	216.0	–	–	–	–	–	–	–	–	–	–
8 C 300 J	30	30.4	A-3	J	4.5	0.375	1.5625	4.5	3.5	268.0	10 C 300 M	A-3	M	5.5	0.500	2	6.75	3.125	355.0	
8 C 360 M	36	36.4	A-3	M	5.5	0.5	1.9375	6.75	1.125	364.0	10 C 360 M	A-3	M	5.5	0.500	2	6.75	3.125	455.0	
8 C 440 M	44	44.4	A-3	M	5.5	0.5	1.9375	6.75	1.125	413.0	10 C 440 M	A-3	M	5.5	0.500	2	6.75	3.125	544.0	
8 C 500 M	50	50.4	A-3	M	5.5	0.5	1.9375	6.75	1.125	474.0	10 C 500 M	A-3	M	5.5	0.500	2	6.75	3.125	622.0	

12 Grooves										
F = 12 <sup>3</sup> / <sub>8</sub>										
Part Number	PD C Belt	QD	Type	Bush	Bush Max Bore	E ★	K	L Length Thru Bore	M ★	Wt. Less Bush
12 C 90 J	9	9.4	A-1	J	4.5	2.875	4.0625	4.5	5	63.0
12 C 95 J	9.5	9.9	A-1	J	4.5	2.875	4.0625	4.5	5	75.0
12 C 100 J	10	10.4	A-1	J	4.5	2.875	4.0625	4.5	5	84.0
12 C 105 J	10.5	10.9	A-1	J	4.5	2.875	4.0625	4.5	5	86.0
12 C 110 J	11	11.4	A-1	J	4.5	2.875	4.0625	4.5	5	97.0
12 C 120 J	12	12.4	A-1	J	4.5	2.875	4.0625	4.5	5	119.0
12 C 130 J	13	13.4	A-2	J	4.5	2.875	4.0625	4.5	5	125.0
12 C 140 J	14	14.4	A-2	J	4.5	2.875	4.0625	4.5	5	139.0
12 C 150 J	15	15.4	A-2	J	4.5	2.875	4.0625	4.5	5	156.0
12 C 160 J	16	16.4	A-3	J	4.5	2.875	4.0625	4.5	5	175.0
12 C 180 J	18	18.4	A-3	J	4.5	2.875	4.0625	4.5	5	185.0
12 C 200 M	20	20.4	A-3	M	5.5	0.5	1.9375	6.75	5.125	228.0
12 C 240 M	24	24.4	A-3	M	5.5	0.5	1.9375	6.75	5.125	287.0
12 C 300 M	30	30.4	A-3	M	5.5	0.5	1.9375	6.75	5.125	350.0
12 C 360 M	36	36.4	A-3	M	5.5	0.5	1.9375	6.75	5.125	430.0
12 C 440 M	44	44.4	A-3	M	5.5	0.5	1.9375	6.75	5.125	565.0
12 C 500 M	50	50.4	A-3	M	5.5	0.5	1.9375	6.75	5.125	595.0

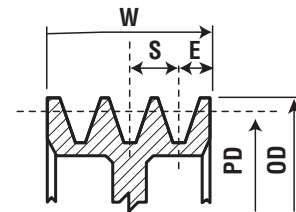

Combination Groove Dimensions

Belt Selection	E	S	OD
C	.6875	1	PD B + .40

$$W = S(N-1) + 2E$$

N = No. of Grooves

NOTE: Dimensions in inches, weight in pounds. Weights do not include bushings. See page B-3 and B-4 for additional bushing dimensions.

## QD Sheaves – D

3 Grooves											4 Grooves								
F = 4 <sup>5</sup> / <sub>8</sub>											F = 6 <sup>3</sup> / <sub>16</sub>								
Part Number	PD	QD	Type	Bush	Bush Max Bore	E ★	K	L Length Thru Bore	M ★	Wt. Less Bush	Part Number	Type	Bush	Bush Max Bore	E ★	K	L Length Thru Bore	M ★	Wt. Less Bush
	C Belt																		
3 D 120 F	12	12.6	A-2	F	3.9375	0.5	1.5	3.625	0.5	58.0	4 D 120 F	A-2	F	3.9375	1.3125	2.3125	3.625	1.125	68.0
3 D 130 F	13	13.6	A-2	F	3.9375	0.5	1.5	3.625	0.5	63.0	4 D 130 F	A-2	F	3.9375	1.3125	2.3125	3.625	1.125	78.0
3 D 135 F	13.5	14.1	A-2	F	3.9375	0.5	1.5	3.625	0.5	68.0	4 D 135 F	A-2	F	3.9375	1.3125	2.3125	3.625	1.125	82.0
3 D 140 F	14	14.6	A-2	F	3.9375	0.5	1.5	3.625	0.5	71.0	4 D 140 F	A-2	F	3.9375	1.3125	2.3125	3.625	1.125	91.0
3 D 145 F	14.5	15.1	A-2	F	3.9375	0.5	1.5	3.625	0.5	82.0	4 D 145 F	A-2	F	3.9375	1.3125	2.3125	3.625	1.125	93.0
3 D 150 F	15	15.6	A-2	F	3.9375	0.5	1.5	3.625	0.5	86.0	4 D 150 F	A-2	F	3.9375	1.3125	2.3125	3.625	1.125	99.0
3 D 155 F	15.5	16.1	A-2	F	3.9375	0.5	1.5	3.625	0.5	93.0	4 D 155 F	A-2	F	3.9375	1.3125	2.3125	3.625	1.125	111.0
3 D 160 F	16	16.6	A-2	F	3.9375	0.5	1.5	3.625	0.5	95.0	4 D 160 F	A-2	F	3.9375	1.3125	2.3125	3.625	1.125	122.0
–	–	–	–	–	–	–	–	–	–	–	4 D 170 J	A-2	J	4.5	1.375	2.3125	4.5	0.1875	136.0
3 D 180 J	18	18.6	A-3	J	4.5	–	1.1875	4.5	0.125	105.0	4 D 180 J	A-3	J	4.5	1.375	2.3125	4.5	0.1875	141.0
3 D 200 J	20	20.6	A-2	J	4.5	–	1.1875	4.5	0.125	148.0	4 D 200 J	A-2	J	4.5	0.375	1.5625	4.5	1.1875	167.0
3 D 220 J	22	22.6	A-3	J	4.5	–	1.1875	4.5	0.125	164.0	4 D 220 J	A-3	J	4.5	0.375	1.5625	4.5	1.1875	183.0
3 D 270 J	27	27.6	A-3	J	4.5	–	1.1875	4.5	0.125	180.0	4 D 270 J	A-3	J	4.5	0.375	1.5625	4.5	1.1875	222.0
3 D 330 J	33	33.6	A-3	J	4.5	–	1.1875	4.5	0.125	195.0	4 D 330 M	B-3	M	5.5	0.5	1.9375	6.75	1.1875	315.0
3 D 400 J	40	40.6	A-3	J	4.5	–	1.1875	4.5	0.125	260.0	4 D 400 M	B-3	M	5.5	0.5	1.9375	6.75	1.1875	337.0

5 Grooves										
F = 7 <sup>1</sup> / <sub>2</sub>										
Part Number	PD	QD	Type	Bush	Bush Max Bore	E ★	K	L Length Thru Bore	M ★	Wt. Less Bush
	C Belt									
5 D 120 F	12	12.6	A-2	F	3.9375	2.0625	3.0625	3.625	1.8125	87.0
5 D 130 F	13	13.6	A-2	F	3.9375	2.0625	3.0625	3.625	1.8125	88.0
5 D 135 F	13.5	14.1	A-2	F	3.9375	2.0625	3.0625	3.625	1.8125	92.0
5 D 140 F	14	14.6	A-2	F	3.9375	2.0625	3.0625	3.625	1.8125	96.0
5 D 145 F	14.5	15.1	A-2	F	3.9375	2.0625	3.0625	3.625	1.8125	111.0
5 D 150 F	15	15.6	A-2	F	3.9375	2.0625	3.0625	3.625	1.8125	115.0
5 D 155 F	15.5	16.1	A-2	F	3.9375	2.0625	3.0625	3.625	1.8125	121.0
5 D 160 F	16	16.6	A-2	F	3.9375	2.0625	3.0625	3.625	1.8125	128.0
5 D 170 J	17	17.6	A-2	J	4.5	0.375	1.5625	4.5	2.625	135.0
5 D 180 J	18	18.6	A-3	J	4.5	0.375	1.5625	4.5	2.625	148.0
5 D 200 J	20	20.6	A-3	J	4.5	0.375	1.5625	4.5	2.625	184.0
5 D 220 J	22	22.6	A-3	J	4.5	0.38	1.5625	4.5	2.625	202.0
5 D 270 M	27	27.6	A-3	M	5.5	0.5	1.9375	6.75	0.25	250.0
5 D 330 M	33	33.6	A-3	M	5.5	0.5	1.9375	6.75	0.25	280.0
5 D 400 M	40	40.6	A-3	M	5.5	0.5	1.9375	6.75	0.25	380.0
12 C 440 M	44	44.4	A-3	M	5.5	0.5	1.9375	6.75	5.125	565.0
12 C 500 M	50	50.4	A-3	M	5.5	0.5	1.9375	6.75	5.125	595.0

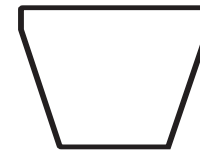
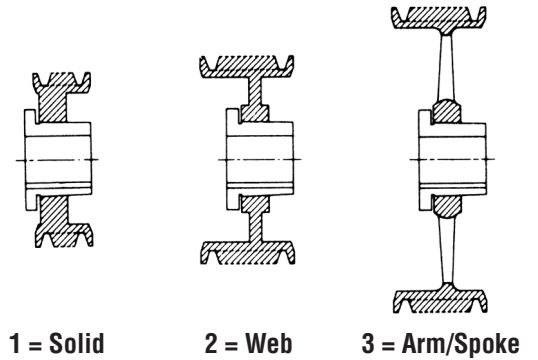

1<sup>1</sup>/<sub>4</sub> x <sup>3</sup>/<sub>16</sub>

**D**

NOTE: Dimensions in inches, weight in pounds. Weights do not include bushings. See page B-3 and B-4 for additional bushing dimensions.

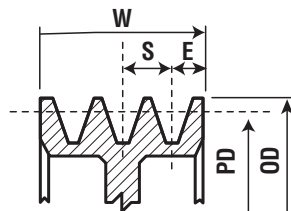

### Combination Groove Dimensions

Belt Selection	E	S	OD
C	.6875	1	PD B + .40

W = S(N-1) + 2E  
N = No. of Grooves

# D Conventional Stock QD Sheaves

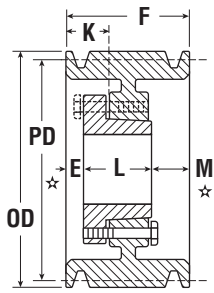

Type A

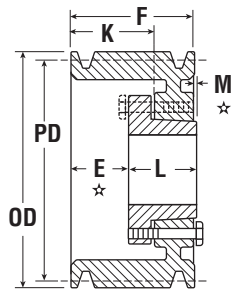

Type B

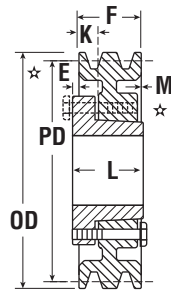

Type C

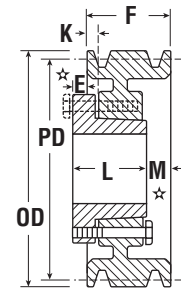

Type D

## QD Sheaves – D

6 Grooves										8 Grooves									
F = 8 <sup>15</sup> / <sub>16</sub>										F = 11 <sup>13</sup> / <sub>16</sub>									
Part Number	PD	QD	Type	Bush	Bush Max Bore	E *	K	L Length Thru Bore	M *	Wt. Less Bush	Part Number	Type	Bush	Bush Max Bore	E *	K	L Length Thru Bore	M *	Wt. Less Bush
	C Belt																		
6 D 120 J	12	12.6	A-1	J	4.5	2.125	3.3125	4.5	2.3125	104.0	8 D 120 J	A-1	J	4.5	2.375	3.5625	4.5	4.9375	126.0
6 D 130 J	13	13.6	A-1	J	4.5	2.125	3.3125	4.5	2.3125	122.0	8 D 130 J	A-1	J	4.5	2.375	3.5625	4.5	4.9375	147.0
6 D 135 J	13.5	14.1	A-1	J	4.5	2.125	3.3125	4.5	2.3125	125.0	8 D 135 J	A-1	J	4.5	2.375	3.5625	4.5	4.9375	150.0
6 D 140 J	14	14.6	A-2	J	4.5	2.125	3.3125	4.5	2.3125	128.0	8 D 140 J	A-1	J	4.5	2.375	3.5625	4.5	4.9375	155.0
6 D 145 J	14.5	15.1	A-2	J	4.5	2.125	3.3125	4.5	2.3125	130.0	8 D 145 J	A-1	J	4.5	2.375	3.5625	4.5	4.9375	160.0
6 D 150 J	15	15.6	A-2	J	4.5	2.125	3.3125	4.5	2.3125	136.0	8 D 150 J	A-2	J	4.5	2.375	3.5625	4.5	4.9375	176.0
6 D 155 J	15.5	16.1	A-2	J	4.5	2.125	3.3125	4.5	2.3125	139.0	8 D 155 J	A-2	J	4.5	2.375	3.5625	4.5	4.9375	180.0
6 D 160 J	16	16.6	A-2	J	4.5	2.125	3.3125	4.5	2.3125	141.0	8 D 160 J	A-2	J	4.5	2.375	3.5625	4.5	4.9375	200.0
6 D 170 J	17	17.6	A-2	J	4.5	2.125	3.3125	4.5	2.3125	154.0	8 D 170 M	A-1	M	5.5	2.5	3.9375	6.75	2.5625	225.0
6 D 180 J	18	18.6	A-2	J	4.5	2.125	3.3125	4.5	2.3125	172.0	8 D 180 M	A-2	M	5.5	2.5	3.9375	6.75	2.5625	250.0
6 D 200 J	20	20.6	A-2	J	4.5	2.125	3.3125	4.5	2.3125	183.0	8 D 200 M	A-2	M	5.5	2.5	3.9375	6.75	2.5625	270.0
6 D 220 M	22	22.6	A-2	M	5.5	0.5	1.9375	6.75	1.6875	272.0	8 D 220 M	A-2	M	5.5	0.5	1.9375	6.75	4.5625	316.0
6 D 270 M	27	27.6	A-3	M	5.5	0.5	1.9375	6.75	1.6875	280.0	8 D 270 N	A-3	M	5.5	0.5	1.9375	6.75	4.5625	440.0
6 D 330 M	33	33.6	A-3	M	5.5	0.5	1.9375	6.75	1.6875	356.0	8 D 330 N	A-3	M	5.5	0.5	1.9375	6.75	4.5625	458.0
6 D 400 M	40	40.6	A-3	M	5.5	0.5	1.9375	6.75	1.6875	415.0	8 D 400 N	A-3	N	5.5	0.5	2.25	8.125	3.1875	638.0
6 D 440 M	44	44.6	A-3	M	5.5	0.5	1.9375	6.75	1.6875	536.0	8 D 440 N	A-3	N	6	0.5	2.25	8.125	3.1875	616.0
6 D 480 M	48	48.6	A-3	M	5.5	0.5	1.9375	6.75	1.6875	572.0	8 D 480 N	A-3	N	6	0.5	2.25	8.125	3.1875	755.0
6 D 580 N	58	58.6	A-3	N	6	0.5	2.25	8.125	0.3125	1006.0	8 D 580 N	A-3	N	6	0.5	2.25	8.125	3.1875	1112.0

10 Grooves										12 Grooves										
F = 4 <sup>11</sup> / <sub>16</sub>										F = 17 <sup>9</sup> / <sub>16</sub>										
Part Number	PD	QD	Type	Bush	Bush Max Bore	E *	K	L Length Thru Bore	M *	Wt. Less Bush	Part Number	Type	Bush	Bush Max Bore	E *	K	L Length Thru Bore	M *	Wt. Less Bush	
	C Belt																			
10 D 120 M	12	12.6	A-1	M	5.5	2.5	3.9375	6.75	5.4375	158.0	12 D 120 M	A-1	M	5.5	3.5	4.9375	6.75	7.3125	158.0	
10 D 125 M	12.5	13.1	A-1	M	5.5	2.5	3.9375	6.75	5.4375	178.0	-	-	-	-	-	-	-	-	-	-
10 D 130 M	13	13.6	A-1	M	5.5	2.5	3.9375	6.75	5.4375	196.0	12 D 130 M	A-1	M	5.5	3.5	4.9375	6.75	7.3125	219.0	
10 D 135 M	13.5	14.1	A-1	M	5.5	2.5	3.9375	6.75	5.4375	207.0	12 D 135 M	A-1	M	5.5	3.5	4.9375	6.75	7.3125	242.0	
10 D 140 M	14	14.6	A-1	M	5.5	2.5	3.9375	6.75	5.4375	225.0	12 D 140 M	A-1	M	5.5	3.5	4.9375	6.75	7.3125	246.0	
10 D 145 M	14.5	15.1	A-1	M	5.5	2.5	3.9375	6.75	5.4375	238.0	12 D 145 M	A-1	M	5.5	3.5	4.9375	6.75	7.3125	266.0	
10 D 150 M	15	15.6	A-1	M	5.5	2.5	3.9375	6.75	5.4375	260.0	12 D 150 M	A-1	M	5.5	3.5	4.9375	6.75	7.3125	287.0	
10 D 155 M	15.5	16.1	A-1	M	5.5	2.5	3.9375	6.75	5.4375	279.0	12 D 155 M	A-1	M	5.5	3.5	4.9375	6.75	7.3125	308.0	
10 D 160 M	16	16.6	A-1	M	5.5	2.5	3.9375	6.75	5.4375	292.0	12 D 160 M	A-1	M	5.5	3.5	4.9375	6.75	7.3125	325.0	
10 D 170 M	17	17.6	A-1	M	5.5	2.5	3.9375	6.75	5.4375	330.0	12 D 170 M	A-1	M	5.5	3.5	4.9375	6.75	7.3125	330.0	
10 D 180 M	18	18.6	A-1	M	5.5	2.5	3.9375	6.75	5.4375	340.0	12 D 180 M	A-1	M	5.5	3.5	4.9375	6.75	7.3125	340.0	
10 D 200 M	20	20.6	A-2	M	5.5	2.5	3.9375	6.75	5.4375	355.0	12 D 200 M	A-2	M	5.5	3.5	4.9375	6.75	7.3125	355.0	
10 D 220 M	22	22.6	A-3	M	5.5	1.5	2.9375	6.75	6.4375	348.0	12 D 220 M	A-2	M	5.5	2.5	3.9375	6.75	8.3125	392.0	
10 D 270 M	27	27.6	A-3	M	5.5	1.5	2.9375	6.75	6.4375	434.0	12 D 270 M	A-3	N	6	2.5	4.25	6.75	6.9375	505.0	
10 D 330 N	33	33.6	A-3	N	6	1.5	3.25	8.125	5.0625	502.0	12 D 330 M	A-3	N	6	2.5	4.25	6.75	6.9375	619.0	
10 D 400 N	40	40.6	A-3	N	6	1.5	3.25	8.125	5.0625	727.0	12 D 400 P	A-3	P	6.75	0.625	2.625	8.125	7.5625	946.0	
10 D 480 P	48	48.6	A-3	P	6.75	0.625	2.625	9.375	4.6875	755.0	12 D 480 P	A-3	P	6.75	0.625	2.625	8.125	7.5625	1155.0	
10 D 580 P	58	58.6	A-3	P	6.75	0.625	2.625	9.375	4.6875	1286.0	12 D 580 P	A-3	P	6.75	0.625	2.625	8.125	7.8125	1576.0	