

**U.S. COURTS
DESIGN GUIDE
JUDICIAL CONFERENCE
OF THE UNITED STATES**

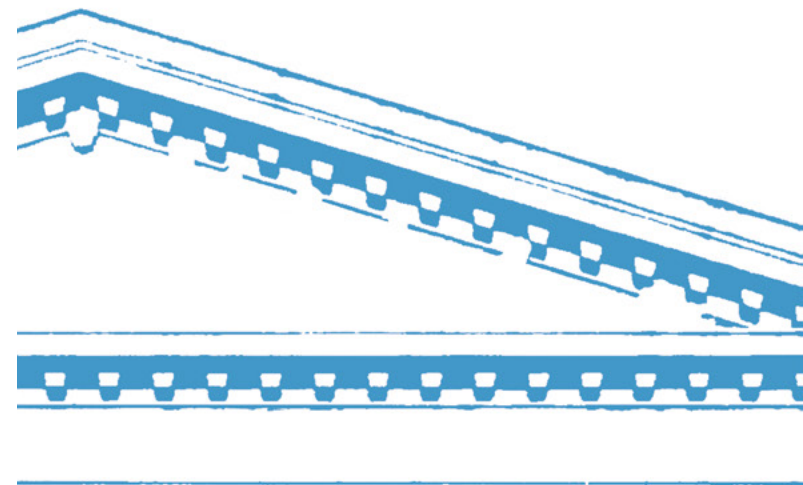

Revised March 2021



Acknowledgments

The Judicial Conference of the United States (JCUS) acknowledges that the completion of the *U.S. Courts Design Guide (Design Guide)* could not have been possible without the participation and assistance of many people across the Judiciary whose names are enumerated in this section. The Judicial Conference thanks each of them for their contributions.

COMMITTEE ON SPACE AND FACILITIES

The JCUS thanks the following members of the Committee on Space and Facilities for their support, time, and expertise in reviewing drafts of this edition of the *Design Guide*.

Honorable David Jeremiah Barron

United States Court of Appeals Judge, First Circuit
Member 2019–Present

Honorable Karon Bowdre

United States District Court Judge, Northern District of Alabama
Member 2019–Present

Honorable Philip A. Brimmer

United States District Court Chief Judge, District of Colorado
Member 2019–Present

Honorable James A. Beaty, Jr.

United States District Court Judge, Middle District of North Carolina
Member 2012–2018

Honorable Susan R. Bolton

United States District Court Judge, District of Arizona
Member 2011–2016; Chair 2016–2019

Honorable Kevin J. Carey

United States Bankruptcy Court Judge, District of Delaware
Member 2010–2016

Honorable Robert H. Cleland

United States District Court Judge, Eastern District of Michigan
Member 2011–2017

Honorable Christopher Reid Cooper

United States District Court Judge, District of Columbia
Member 2018–Present

Honorable Aida M. Delgado-Colon

United States District Court Judge, District of Puerto Rico
Member 2013–2019

Honorable Michael Walter Fitzgerald

United States District Court Judge, Central District of California
Member 2019–Present

Honorable Gregory K. Frizzell

United States District Court Chief Judge, Northern District of Oklahoma
Member 2013–2019

Honorable James Rodney Gilstrap

United States District Court Chief Judge, Eastern District of Texas
Member 2018–Present

Honorable F.A. Gossett III

United States Magistrate Judge, District of Nebraska
Member 2011–2017

Honorable Pamela Harris

United States Court of Appeals Judge, Fourth Circuit
Member 2017–Present

Honorable Jeffrey J. Helmick

United States District Court Judge, Northern District of Ohio
Member 2017–2019, Chair 2019–Present

Honorable John E. Jones III

United States District Court Judge, Middle District of Pennsylvania
Member 2018–Present

Honorable David C. Keesler

United States Magistrate Judge, Western District of North Carolina
Member 2017–Present

Honorable Denzil Price Marshall, Jr.

United States District Court Judge, Eastern District of Arkansas
Member 2016–Present

Honorable Beverly B. Martin

United States Court of Appeals Judge, Eleventh Circuit
Member 2013–Present

Honorable Michael J. Melloy

United States Court of Appeals Judge, Eighth Circuit
Member 2009–2016

Honorable Robert E. Nugent

United States Bankruptcy Court Judge, District of Kansas
Member 2016–2019

Honorable Sul Ozerden

United States District Court Judge, Southern District of
Mississippi
Member 2012–2018

Honorable James E. Shadid

United States District Court Judge, Central District of Illinois
Member 2019–Present

Honorable D. Brooks Smith

United States Court of Appeals Chief Judge, Third Circuit
Member 2006–2013; Chair 2013–2016

Honorable Glenn T. Suddaby

United States District Court Chief Judge, Northern District of
New York
Member 2018–Present

Honorable Emmet G. Sullivan

United States District Court Judge, District of Columbia
Member 2012–2018

Honorable Alvin W. Thompson

United States District Court Judge, District of Connecticut
Member 2010–2016

Honorable Michael George Williamson

United States Bankruptcy Court Judge, Middle District of Florida
Member 2019–Present

Honorable Richard L. Young

United States District Court Judge, Southern District of Indiana
Member 2013–Present

U.S. COURTS DESIGN GUIDE WORKING GROUP

The JCUS thanks the members of the *Design Guide* Working Group for their dedication, leadership, and expertise in planning, developing, and editing of the *Design Guide*.

Honorable Robert Jonker (Chair)

United States District Court Chief Judge, Western District of
Michigan

Cliff Harlan (Chair)

Assistant Circuit Executive for Space and Facilities, Ninth Circuit

Honorable Charles Caldwell

United States Bankruptcy Court Judge, Southern District of Ohio

Honorable Michael J. Melloy

United States Court of Appeals Judge, Eighth Circuit

Honorable Michael Roemer

United States Magistrate Judge, Western District of New York

Stephanie Butler

United States Bankruptcy Court Clerk, Eastern District of North
Carolina

Douglas Bys

Deputy Chief Probation Officer, Central District of California

Michael Gans

United States Court of Appeals Clerk, Eighth Circuit

Chris Maloney

Chief Probation Officer, District of Massachusetts

Karen Mitchell

United States District Court Clerk, Northern District of Texas

Laura Nelson

Assistant Circuit Executive for Space and Facilities, Tenth
Circuit

Una O’Boyle

United States Bankruptcy Court Clerk, District of Delaware

Amy Rice

United States Bankruptcy Court Architect, Southern District of Alabama

Owen Smith

United States Court of Appeals Circuit Librarian, Sixth Circuit

Robin Tabora

United States District Court Clerk, District of Connecticut

Jeanne Walsh

Chief Probation Officer, Northern District of Illinois

Margaret Wiegand

United States Court of Appeals Circuit Executive, Third Circuit

ADMINISTRATIVE OFFICE OF THE U.S. COURTS

The JCUS appreciates the efforts of James C. Duff, Director of the Administrative Office of the U.S. Courts, and the Office of Facilities and Security staff and thanks them for their coordination, administration, and expertise in implementing the latest edition of the *Design Guide*.

Melanie F. Gilbert

Chief, Facilities and Security Office

Jack Cummins

Chief, Security and Facilities Policy Staff

David Insinga

Chief, Space and Facilities Division

Christopher Smith

Chief, Facilities Integration and Transformation Branch

Reema Gupta

Supervisory Architect, Space and Facilities Division

Sheritta W. Taylor

Management Analyst, Security and Facilities Policy Staff

Erica Carter

Program Analyst, Space and Facilities Division

Lydia Piper

Project Manager, Space and Facilities, U.S. District Court, District of New Mexico

CONSULTANTS

The JCUS thanks the following individuals from AECOM for their contributions to the *Design Guide*.

Kristine Johnson, AIA, NCARB, LEED AP

Associate Vice President, Justice Market Sector Lead Southeast

Dilip Parikh, PE

Senior Project Manager

Eric Zeldis, AIA

Project Architect



Preface

U.S. Courts Design Guide Update

The *U.S. Courts Design Guide (Design Guide)* sets forth the federal judiciary’s requirements for the design, construction, and renovation of court facilities and is intended for use by judges, architects, engineers, General Services Administration (GSA) personnel, and court administrators who are involved in federal court construction projects.

In 2017, the Judicial Conference of the United States (JCUS), upon the recommendation of the Committee on Space and Facilities, approved the undertaking of a comprehensive review and revision of the 2007 *Design Guide*. JCUS approved this revision in March 2021. This latest edition of the *Design Guide* is intended to provide guidance for the interpretation and applicability of building standards and Judiciary policy, and to incorporate industry standards and best practices for the design and construction of federal courthouses. Since every district has its own set of unique opportunities and challenges, this *Design Guide* update emphasizes the need for flexibility in the design and construction process. Project stakeholders are encouraged to collaborate and think creatively about their spatial needs to uphold the integrity and accomplish the mission of the federal court system. Where the *Design Guide* conflicts with other guidance, policy, and standards, the Administrative Office of the U.S. Courts (AOUSC) should be contacted to determine the appropriate guidance.

The *Design Guide* is both a design and financial commitment document. The JCUS’s space-rental budget correlates to the design standards contained in the *Design Guide*. The *Design Guide* lists and describes major spaces and spatial groupings located within federal courthouses. The number of major space groupings required for a particular court building is *not* determined by this document and should be determined by the program of requirements developed and submitted by the Judiciary. Individual project circumstances and requirements dictate which of the major space groupings should be included in a building program.

How to Use this Guide

The *Design Guide* consists of 18 chapters, one appendix, a glossary, and an index. Each chapter begins with a cover sheet that summarizes the respective chapter. If the chapter cover sheet is viewed electronically, the information under the “Chapter Topics” and “Chapter Figures and Tables” subheadings offers hyperlinks to the respective chapter subsections, figures, and/or tables. Other cross references and hyperlinks provided in the body of the chapter will appear in blue. Cross references and hyperlinks might link the user to references within other chapters, appendices, or external information, such as websites. Each chapter contains space standards, adjacency requirements, and other applicable technical information for that chapter’s topic. The spatial and technical information in these chapters is to be used to design the various types of court projects.

Room Data Sheets

A major feature of the latest version of the *Design Guide* is the inclusion of room data sheets (RDS) located in the appendix. The RDS compile information previously contained in the various chapters of the *Design Guide* and consolidate the information into one area. Each RDS contains spatial, programmatic, and technical requirements for a specific space or grouping of spaces. The RDS are not intended to be used as stand-alone documents and should be used in conjunction with information located throughout the guide.

Each RDS contains one or multiple depictions of how each space may be used. It is important to note that these graphics are *not* designs but are idealized diagrams and for illustrative purposes only. Each court project will contain unique challenges that may suggest alternative spatial layouts that are more appropriate for that specific project. It is essential that the *Design Guide* user obtain additional information from the court, GSA, and other stakeholders to tailor the design response to the specific court requirements demanded by that project or situation.

Adjacency Diagrams

Adjacency diagrams are provided in Chapters 3 through 11. Each diagram represents an idealized arrangement of the required types of spaces, circulation patterns, and access points. Effort should be made during the design process to maintain the arrangements illustrated in the adjacency diagrams. In practice, however, this arrangement may not be possible.

It is important for users of the *Design Guide* to understand what the diagrams do and do not represent. Adjacency diagrams depict only circulatory relationships among spaces; they are not floor plans, which normally describe exact spatial sizes, configurations, and corridor distances between spaces. The boxes in the adjacency diagrams represent spaces and illustrate relative size to one another. Rectangular shapes do not imply that actual spaces must be rectangular. Similarly, irregular shapes convey no particular form, since physical conditions, external constraints, and design considerations may dictate other configurations. In addition, the relationships between spaces along circulation routes indicate adjacencies only, not approximate distances. For example, to facilitate courtroom sharing, chambers may be located on one common floor with a judges’ elevator moving between several courtroom floors. The location of spaces on one side of the diagram or another does not necessarily fix their position on any side of a planned facility or office. Circles showing vertical circulation do not indicate the number or specific location of elevators or stairwells; for example, while a diagram may indicate circles to represent vertical service circulation, the requirements for a freight elevator might be accommodated by a single elevator and will be dictated by building occupants and individual project requirements.

The adjacency diagrams include three circulation patterns: public, restricted, and secure. Each is indicated by a different line color. A yellow line represents public traffic patterns used by lawyers, spectators, media representatives, and other individuals. Restricted circulation patterns within and between office spaces are represented by blue lines. Restricted circulation is generally used by judges, courtroom deputy clerks, court security officers, authorized visitors, and administrative or clerical support staff. A red line represents secure circulation for prisoner movement; secure circulation must not intersect public or restricted circulation.

Although the lines used to indicate traffic patterns imply the existence of corridors, this is not always the case. In some instances, a circulation pattern is subsumed by another space, such as when lobby space is used as a public circulation area. In other instances, a circulation pattern might intersect an indicated space—for example, where public traffic intersects a reception counter used to control access from waiting areas to restricted spaces. Any uncontrolled intersection of differing circulation patterns constitutes a breach of security and must be avoided. Additionally, lines indicating circulation do not describe egress requirements.

Dots containing red and white triangles on the adjacency diagrams indicate either transition or circulation termination points: termination points for public or private circulation, points of transition from one circulation type to another (e.g., public to restricted or external to internal), or transition points from a circulation type to a given space (e.g., from public access to a reception area).

Vertical circulation is also shown on the adjacency diagrams. A solid yellow dot indicates vertical public circulation for movement between floors. A solid blue dot indicates restricted vertical circulation, extending to secure parking within the building and connecting with restricted circulation on other floors. A solid gray dot indicates vertical circulation for the movement of freight and other bulky items. A solid red dot indicates vertical secure circulation exclusively for in-custody defendants and security officers of the U.S. Marshals Service (USMS).

The types, numbers, and sizes of spaces shown on the adjacency diagrams should not be interpreted literally as specific requirements; instead, the actual types, numbers, and sizes of spaces must be determined on a case-by-case basis, and will be dependent upon the program, design, applicable building codes, and other requirements.

For certain spaces, such as courtrooms and judges' chambers suites, the number of boxes shown on the adjacency diagrams does not necessarily indicate the number of actual spaces in a planned facility. The diagram should be used as a guide for determining the type of spaces required.



Summary of Revisions

As a living document, the *U.S. Courts Design Guide (Design Guide)* must keep pace with suggestions for changes, which arise from new Judiciary policies and new technical criteria intended to keep pace with state-of-the-art construction practices. Changes to the 2021 edition of the *Design Guide* are summarized below.

Revisions through June 2021

Summary of Revisions

- Added new section to summarize changes and revisions to this edition of the *Design Guide*. (AO Technical Update 06/21)

Chapter 4

Table 4.3, Table 4.4, and Table 4.5

- Revised footnote 1 to clarify restroom requirements and provisions. (AO Technical Update 06/21)

Chapter 6

Table 6.1

- Corrected total net square footage values for all judges' chambers suites. (AO Technical Update 06/21)

Table of Contents

Acknowledgments	iii
Preface	vii
Summary of Revisions	xi
Table of Contents	xii
Chapter 1 - Introduction and the Federal Court System	1-1
Introduction.....	1-2
Programming and Budgetary Notes.....	1-2
The System.....	1-4
Organization of the <i>Design Guide</i>	1-5
Chapter 2 - Courthouse Programming and Budgetary Considerations	2-1
Introduction.....	2-2
Supporting Documents.....	2-2
General Cost-Control Strategies.....	2-4
Value Engineering and Life-Cycle Costing.....	2-6
Typical Federal Courthouse Project Development.....	2-7
Chapter 3 - Planning for U.S. Courthouses	3-1
Introduction.....	3-2
Supporting Documents.....	3-2
Programming and Budgetary Notes.....	3-2
Spaces Common to Federal Courts.....	3-4
Functions of the Three Court Types.....	3-5
Users and Capacities.....	3-6
Access for People with Disabilities.....	3-6
Courthouse Zoning and Building Circulation.....	3-7
Program Stacking.....	3-10
Chapter 4 - Courtrooms and Associated Spaces	4-1
Introduction.....	4-2
Supporting Documents.....	4-2
Programming and Budgetary Notes.....	4-2
General Requirements for All Courtrooms.....	4-4
Appellate Courtrooms.....	4-8
District Judge Courtrooms.....	4-11
Magistrate Judge Courtrooms.....	4-15
Bankruptcy Judge Courtrooms.....	4-20

Chapter 5 - Jury Facilities	5-1
Supporting Documents.....	5-2
Programming and Budgetary Notes.....	5-2
Functions and Activities.....	5-3
Users and Capacities.....	5-5
Design Requirements.....	5-5
Adjacency and Circulation.....	5-7
Chapter 6 - Judges' Chambers Suites	6-1
Supporting Documents.....	6-2
Programming and Budgetary Notes.....	6-2
Functions and Activities.....	6-4
Users and Capacities.....	6-4
Design Requirements.....	6-4
Adjacency and Circulation.....	6-8
Chapter 7 - Court Libraries	7-1
Supporting Documents.....	7-2
Programming and Budgetary Notes.....	7-2
Functions and Activities.....	7-4
Users and Capacities.....	7-5
Design Requirements.....	7-5
Planning Issues.....	7-6
Space Allotments.....	7-9
Adjacency and Circulation.....	7-9
Chapter 8 - Clerk's Office	8-1
Supporting Documents.....	8-2
Programming and Budgetary Notes.....	8-2
Functions and Activities.....	8-4
Users and Capacities.....	8-4
Design Requirements.....	8-5
Adjacency and Circulation.....	8-9
Chapter 9 - Probation and Pretrial Services Offices	9-1
Introduction.....	9-2
Supporting Documents.....	9-2
Programming and Budgetary Notes.....	9-2
Functions and Activities.....	9-4
Users and Capacities.....	9-4
Design Requirements.....	9-5
Adjacency and Circulation.....	9-9

Chapter 10 - Other Court Units.....	10-1
Supporting Documents.....	10-2
Programming and Budgetary Notes.....	10-2
Functions and Activities.....	10-4
Users and Capacities.....	10-4
Design Requirements.....	10-4
Adjacency and Circulation.....	10-8
Chapter 11 - Shared Support Spaces.....	11-1
Supporting Documents.....	11-2
Programming and Budgetary Notes.....	11-2
Functions and Activities.....	11-4
Users and Capacities.....	11-5
Design Requirements.....	11-5
Adjacency and Circulation.....	11-7
Chapter 12 - Tenant Improvements and Furnishings.....	12-1
Introduction.....	12-2
Supporting Documents.....	12-2
Programming and Budgetary Notes.....	12-2
Tenant Improvements - Interior Finishes.....	12-3
Tenant Improvements - Millwork.....	12-10
Furnishings.....	12-11
Chapter 13 - Interior Signage.....	13-1
Introduction.....	13-2
Supporting Documents.....	13-2
Programming and Budgetary Notes.....	13-2
Design Requirements.....	13-2
Chapter 14 - Acoustics.....	14-1
Introduction.....	14-2
Supporting Documents.....	14-2
Design Requirements.....	14-3
Renovations and Alterations (R&A).....	14-10
Chapter 15 - Building Systems.....	15-1
Supporting Documents.....	15-2
Mechanical Systems.....	15-3
Electrical Distribution Systems.....	15-8
Lighting Systems.....	15-11
Communication Systems.....	15-15
Renovations and Alterations (R&A).....	15-18

Chapter 16 - Building Security.....	16-1
Introduction.....	16-2
Supporting Documents.....	16-2
Agency Responsibilities.....	16-2
Security Systems and Resource Request Process.....	16-3
Security Concepts.....	16-4
Exterior Security.....	16-4
Interior Security.....	16-6
Co-tenancy with the Federal Judiciary.....	16-10
Security Funding.....	16-10
Chapter 17 - Renovations and Alterations (R&A).....	17-1
Introduction.....	17-2
Supporting Documents.....	17-2
Programming and Budgetary Notes.....	17-2
Roles and Responsibilities.....	17-3
Types of R&A Projects.....	17-4
Considerations and Suggested Actions.....	17-7
Chapter 18 - Alternative Workplace Strategies.....	18-1
Introduction.....	18-2
Background.....	18-2
Supporting Documents.....	18-2
Programming and Budgetary Notes.....	18-3
Functions and Activities.....	18-5
Alternative Workplace Strategies Concepts.....	18-5
Workplace Settings.....	18-6
Neighborhoods.....	18-7
Alternative Workplace Strategies Programming and Planning.....	18-7
Alternative Workplace Strategies Design.....	18-8

Appendix - Room Data Sheets.....	A-1
---	------------

Glossary

Index



INTRODUCTION AND THE FEDERAL COURT SYSTEM

This chapter outlines the intent of the *Design Guide*, and how to use its contents. It also briefly describes the organization of the federal court system, its administrative functions, and the judicial process.

Chapter Topics:

- Introduction
- Programming and Budgetary Notes
- The System
- Organization of the *Design Guide*

Chapter Figures and Tables:

- | | |
|------------|---|
| Figure 1.1 | U.S. Court of Appeals - Relevant Chapters |
| Figure 1.2 | U.S. District Court - Relevant Chapters |
| Figure 1.3 | U.S. Bankruptcy Court - Relevant Chapters |

Introduction

Scope

The comprehensive design guidelines contained in this document describe the types of spaces commonly associated with facilities for the U.S. Court of Appeals (USCA), U.S. District Court (USDC), U.S. Bankruptcy Court (USBC), Court of Appeals for the Federal Circuit, Court of Federal Claims, and Court of International Trade. The *Design Guide* includes criteria for accommodating courts in both multi-tenant and leased facilities.

In accordance with Federal Emergency Management Agency guidelines, new courthouses are considered critical action facilities. Where indicated, appropriate floodplain mitigation measures ensuring the life safety requirements of the facility are required. Refer to [Facilities Standards for the Public Buildings Service \(GSA PBS P-100\), section 1.3.12.2 Critical Action Facilities](#).

The design guidelines presented in this document apply to the design and construction of new buildings, annexes, all new leased space in new locations, and repair and alteration projects in which new space is being configured for a court unit, including courtrooms and chambers.

Objectives

The *Design Guide* has three major objectives. First, it serves as a planning tool for federal judges and key judicial personnel who are directly involved in the design of a federal court facility. Second, it provides relevant information for the General Services Administration (GSA) and an architectural/engineering (A/E) team to effectively plan, budget, program, and design a functional, aesthetically appropriate, and cost-effective court facility. Information in the *Design Guide* enables judges and judiciary personnel to collaborate effectively with the GSA and the A/E team throughout a project's design and documentation phases. The *Design Guide* also provides information for the A/E team and specialists regarding security, acoustics, telecommunications, data, and audio-visual systems. Finally, the *Design Guide* provides policy guidance from the Judicial Conference of the United States (JCUS) for the overall planning, programming, and designing of federal court facilities throughout the United States and its territories, through its Committee on Space and Facilities, and the Administrative Office of the U.S. Courts (AOUSC).

It is not the intent of the *Design Guide* to be overly prescriptive and hinder creative ideas to address court needs. The absence of a *Design Guide* standard or requirement does not mean a plan cannot be implemented given the appropriate authority. Courts should work closely with their respective assistant circuit executives (ACEs) for space and facilities, GSA, and A/E teams to identify areas of concern and develop cost-efficient and effective

solutions to problems. If the best solution is outside of, or not included as part of, *Design Guide* standards or requirements, courts should seek the proper exception. The goal of the *Design Guide* is to provide guidance for new construction and renovations that addresses the needs of the Judiciary.

The *Design Guide* contains design criteria for courthouses. Users should read all introductory text carefully to understand the scope, function, and intent of the guidelines and their relationship to the design process.

Programming and Budgetary Notes

Programming and budgetary notes found throughout the *Design Guide* provide assistance with decisions to be made during the development of courthouse projects. The notes include both judicial branch policy and lessons learned from completed projects. The notes supplement the criteria in the *Design Guide*; their purpose is to provide direction in using the flexibility of the *Design Guide* to develop justifiable and cost-effective federal courthouse projects.

Space Envelope Flexibility

A total space envelope for new space will be calculated using appropriate circulation factors, allowances for support-type spaces, and the space standards described in the *Design Guide*. Courts have the flexibility to configure space within the envelope to meet their local needs. However, design and construction should be in general compliance with the square footage standards designated in the *Design Guide* in the space and ceiling requirements tables. If the court unit wishes to significantly change the space standards described in the space and ceiling requirements tables without exceeding the total envelope of space for the unit, it must seek approval from its respective circuit judicial council.

The space envelope for a respective court unit is defined as:

- Entire clerk's office
- Entire probation office
- Entire pretrial services office
- Entire staff attorney's office
- Entire circuit executive's office
- All courtrooms designated by judge type (circuit judges, district judges, magistrate judges, and bankruptcy judges)
- All chambers designated by judge type (circuit judges, district judges, magistrate judges, and bankruptcy judges)

For existing space, courts have the flexibility to configure space within the existing envelope to meet their local needs. However, any significant departure from the square footage standards designated in the *Design Guide* in the space and ceiling requirements

tables must be approved by the respective circuit judicial council. This does not mean that existing space must be changed to meet *Design Guide* standards. Only new construction completed as part of a renovation should be considered.

Renovations and Alterations (R&A)

Many of the construction projects conducted in the Judiciary are renovations to existing space. Although the *Design Guide* applies to these projects, it is understood that some standards in the *Design Guide* are difficult or impossible to achieve in existing space, particularly in historic buildings. Courts should consult [Chapter 17, “Renovations and Alterations \(R&A\),”](#) and [GSA PBS P-100](#) for guidance in these circumstances. References to R&A guidelines are also included throughout the *Design Guide* where appropriate.

Exceptions to the *Design Guide* Standards

The *Design Guide* provides guidance on standards for courthouse construction and renovations to existing space. Any significant departure from these standards is considered an exception and must be approved by the respective authority as outlined below.

Authority of the Circuit Judicial Councils

Circuit judicial councils play an important space-management role by reviewing district-wide facility plans, approving requests for new or modified space, and enforcing adherence to design guidelines. The circuit judicial councils have authority over, and responsibility for, a circuit’s space-management program (28 USC §332 and §462(b)) and for determining the need for space. As directed by the JCUS, any significant departure from the standards in the *Design Guide* must be approved by the respective circuit judicial council.

Authority of the Committee on Space and Facilities

The authority to approve the following exceptions to the *Design Guide* standards rests with the Committee on Space and Facilities: (1) exceeding the total envelope for either the court unit or the project as a whole, (2) changing the standard configurations for judges’ chambers and courtrooms, and (3) exceeding the plumbing standards. If the Committee on Space and Facilities disagrees with a circuit judicial council request for one of these exceptions, the Judicial Conference will decide whether to grant the exception.

Authority of the Judicial Conference

The authority for approving any exception to prospectus-level courthouse projects that would result in additional estimated costs, including additional rent payment obligations, lies with the Judicial Conference. Approval is required, after review by the Committee on Space and Facilities, for any exception to the *Design Guide* approved by a circuit judicial council. The request must include (1) a justification for the exception and (2) a construction cost estimate. [All approved exceptions for prospectus-level projects](#) are reported to GSA and Congress. Approved exceptions may require the project to be

reauthorized by Congress if the exception had not been previously identified. Contact the AOUSC for more detailed information.

For prospectus-level courthouse projects, if an exception is approved by the JCUS which would result in additional estimated costs, the chair of the circuit’s space and facilities committee or the chief judge or other judge designated by the court that sought the exception that exceeds the *Design Guide* criteria must be willing, if requested by the Committee on Space and Facilities, to appear before Congress concerning funding for such construction.

General Programming Notes

The *Design Guide* is intended to be a performance document. Criteria for any space or grouping of spaces should be considered in conjunction with the specific needs of the court office or function for which space is being designed.

Criteria in the *Design Guide* do not represent space entitlements. The criteria apply to an array of space types that should be justified based on the specific purpose of each project. Facility plans, programs, and designs should include only the space needed to satisfy the functional and security requirements of the court.

Differences between the space in an existing facility and the criteria in the *Design Guide* are not justification for facility alteration and expansion. In such cases, alternatives to space expansion are investigated before any additional space is requested. In addition, like-for-like space is not a guarantee. Space allocated in an existing location is not justification for the same amount of space in a new location if the space allocation is not warranted. Current needs should be evaluated when moving into new space to determine the appropriate space envelope. Any additional space must be approved by the appropriate authority. Design architects and court staff are prohibited from adding spaces not originally contemplated in the approved prospectus or design program. Increasing the floor area or building volume requires the necessary approvals.

General Budgetary Notes

Renovation and new construction occur when the court and circuit judicial council identify space needs through the Judiciary’s asset management planning process and document these needs in the long-range facilities plan. GSA determines by what method the space is provided—for example, by the construction of a new building, the renovation of an existing building, a lease, or other means.

The Judicial Conference recognizes and strongly supports a pragmatic approach to design that includes the use of durable and sustainable materials. This approach ensures that courthouses constructed now will last well into the future.

Following the publication of the *2007 Design Guide*, the Judiciary introduced several cost-saving measures, such as courtroom sharing and the Integrated Workplace Initiative (IWI), that sought to provide flexibility and efficiency in court spaces while preserving the dignity of the Judiciary. Courtroom sharing for certain judge types is now a standard throughout the Judiciary, and IWI is recognized as an alternative to traditional office design. For more information on cost- and space-saving efforts and programs, contact the AOUSC Space and Facilities Division.

The System

Introduction

As established by the Constitution, the federal courts constitute one of three coequal branches of our national government. The other two branches are the executive and legislative. While positions established under the Constitution for the executive and legislative branches (e.g., President, Vice President, senators, and representatives) are elected for a set number of years, justices of the Supreme Court and judges of the inferior courts established by Congress are appointed to lifetime positions by the President, with advice and consent of the Senate. These judges are subject to removal from office only through impeachment, as provided in the Constitution. The Constitution also prohibits lowering the pay of federal judges. These two forms of protection allow federal judges to make decisions, even unpopular ones, without fear of removal from office or reduction of salary and maintain the independence of the federal judiciary.

Types of Federal Courts

Article III of the Constitution provides for a Supreme Court and whatever other federal courts Congress considers necessary. The number of federal judges is small. While the Supreme Court and its justices are located in Washington, D.C., most members of the federal judiciary are dispersed throughout the United States and its territories.

Trial Courts

Congress has divided the country into 94 federal judicial districts, each with its own USDC. The USDCs are the federal trial courts where cases are tried, witnesses testify, and juries serve.

In the federal trial courts, the broadest judicial responsibility is given to district judges. District judges conduct a wide range of judicial proceedings, including jury trials, and sometimes appeals from bankruptcy judges. Proceedings occur in both civil and criminal cases. Only district judges are authorized to conduct felony criminal trials.

Typically, one to five district judges are located in small- to medium-sized court facilities; however, in several large metropolitan areas, 15 or more district judges are located in a single facility. Generally, one trial courtroom is required for each district judgeship.

Magistrate and bankruptcy judges assist district judges by conducting some of the proceedings in the federal trial courts.

Magistrate judges are appointed by the district judges to exercise jurisdiction in a narrower range of cases than district judges, as determined by statute and a delegation of authority from district judges. Magistrate judges hear preliminary matters in criminal cases and try minor criminal cases. Under certain circumstances, magistrate judges may conduct the full range of proceedings in civil cases, up to and including jury trials. Bankruptcy judges are appointed by the circuit courts and have authority under federal bankruptcy law to act over all matters involving debtor-creditor relationships. Bankruptcy judges conduct a variety of civil hearings and, in very limited circumstances, may conduct civil jury trials.

Court of International Trade

The geographic jurisdiction of the United States Court of International Trade extends throughout the United States. The court hears and decides cases that arise anywhere in the nation and is also authorized to hold hearings in foreign countries. There are nine judges assigned to the Court of International Trade. The types of cases the court is authorized to decide are limited and defined by the Constitution and specific laws enacted by the Congress. Headquartered in New York City, the Court of International Trade often conducts trials in U.S. courthouses in districts throughout the country.

Court of Federal Claims

The United States Court of Federal Claims is a court of record with national jurisdiction. The United States Court of Federal Claims was created in October 1982 by the Federal Courts Improvement Act pursuant to Article 1 of the United States Constitution. The court consists of 16 judges nominated by the President and confirmed by the Senate for a term of 15 years. The Court of Federal Claims is authorized to hear primarily money claims founded upon the Constitution, federal statutes, executive regulations, or contracts, express or implied in fact, with the United States. The court is headquartered in Washington, D.C.

Courts of Appeals

Congress grouped the 94 USDCs into 12 regional circuits and a federal circuit and established within each circuit a single USCA. Litigants who lose in the USDC may appeal their case to the USCA, which reviews cases to see whether the trial judge correctly applied the law. The USCA also reviews cases decided by the tax court and various federal agencies, such as the National Labor Relations Board. The USCA is the final stop for most litigation in the federal system. There are currently 179 circuit judges authorized to review cases in the 13 circuits, including the federal circuit. Typically, one to five circuit judges are located in a few cities in the various circuits. Occasionally, many more judges are housed in a single location. Only one headquarters courtroom (en banc courtroom) exists within each circuit. One or more auxiliary, or panel, courtrooms may be located throughout each circuit. Most federal court facilities, however, do not house circuit judges or courtrooms.

Court of Appeals for the Federal Circuit

The United States Court of Appeals for the Federal Circuit is unique among the 13 Circuit Courts of Appeals. It has nationwide jurisdiction in a variety of subject areas, including international trade, government contracts, patents, trademarks, certain money claims against the United States government, federal personnel, veterans' benefits, and public safety officers' benefits claims. Appeals to the court come from all federal district courts, the United States Court of Federal Claims, the United States Court of International Trade, and the United States Court of Appeals for Veterans Claims. The court has 12 active judges who are appointed for life by the President. The court is headquartered in Washington, D.C.

The Supreme Court

The U.S. Supreme Court is the highest court in the nation. Cases from the 13 appellate courts and the highest courts of each state can be appealed to the Supreme Court. The Supreme Court is not required to hear every case brought before it. In fact, each year the Supreme Court agrees to hear a small fraction of the appeals presented. The courtroom and other facilities for the nine Supreme Court justices are located in the Supreme Court Building in Washington, D.C. Design criteria for the Supreme Court are not included in the *Design Guide*.

Administration of the Federal Courts

National-level policies for federal courts are established by a standing body of federal judges called the Judicial Conference of the United States. The JCUS is chaired by the Chief Justice of the United States. Standing committees of judges have policy responsibilities that are exercised on behalf of the JCUS. In each of the various circuits, administrative oversight is carried out through committees called circuit judicial councils. Most local court management is vested in the court itself. Chief judges have certain statutory and delegated authorities. Additionally, each court type is authorized by statute to appoint a clerk of court to carry out duties assigned by the court, by statute, as well as duties delegated under authority of the Director of the AOUSC. Courts may also appoint other specialized officers, such as probation and pre-trial services chiefs, circuit librarians, and chief mediators. Circuit judicial councils appoint circuit executives to support the work of the councils.

The federal judiciary is served by the AOUSC, which is located in Washington, D.C. The AOUSC performs a wide range of administrative duties to assist the operation of the federal courts. Section 462 of Title 28, United States Code, gives the Director of the AOUSC authority to provide accommodations for the courts, "but only if the judicial council of the appropriate circuit has approved the accommodations as necessary" and directs that the Administrator of the GSA shall provide the accommodations that the Director requests.

Organization of the *Design Guide*

Three figures at the end of this chapter ([Figures 1.1-1.3](#)) identify the relevant chapters that provide information on the policy and standards for each court unit within the three types of courts: USCA, USDC, and USBC. The information in these chapters and the appendix, "Room Data Sheets," along with technical information found in Chapters 12–18, are to be used to design the various types of court projects.

[Chapter 1: Introduction and the Federal Court System](#) outlines the intent, use, and contents of the *Design Guide* and briefly describes the organization of the federal court system, its administrative functions, and the judicial process.

[Chapter 2: Courthouse Programming and Budgetary Considerations](#) includes a guide to supporting documents; describes the processes used to plan, program, design, and construct federal court facilities; and discusses strategies for developing cost-effective courthouses to accommodate the Judiciary's current and future needs. The budgetary responsibilities of the Judiciary, GSA, and other courthouse project participants are also described.

[Chapter 3: Planning for U.S. Courthouses](#) contains general design guidelines for judges and judicial personnel working with an A/E team to design a new court facility. In addition, the chapter assists A/E team members in understanding the functional and spatial relationships among the major components of a court facility, and the need for separate circulation systems. The chapter describes the major spaces in each of the three court types (USCA, USDC, and USBC) and spaces common to all courthouses, contains a typical floor plan for a courtroom floor, and discusses collegial versus collocated judges' chambers and courts in multi-tenant buildings.

Chapters 4 through 11 contain specific design guidelines to assist the A/E team in the design of a new court facility. Each chapter addresses a major functional category of space or grouping of spaces. These chapters include discussions of functions and activities, user capacities, and specific design requirements, and contain programming and budgetary notes, a list of possible space types, and adjacency diagrams.

[Chapter 4: Courtrooms and Associated Spaces](#) contains specific design guidelines for appellate courtrooms and for district, magistrate, and bankruptcy judges' courtrooms.

[Chapter 5: Jury Facilities](#) describes specific design guidelines for the jury assembly suite, trial jury suite, and grand jury suite.

[Chapter 6: Judges' Chambers Suites](#) describes specific design guidelines for the resident and non-resident chambers suites of circuit, district, magistrate, and bankruptcy judges.

[Chapter 7: Court Libraries](#) contains specific design guidelines for circuit headquarters libraries, satellite libraries, and unstaffed libraries.

[Chapter 8: Clerk’s Office](#) contains specific design guidelines for clerks’ offices of the USCA, USDC, and USBC.

[Chapter 9: Probation and Pretrial Services Offices](#) contains specific design guidelines for the offices of probation and pretrial services personnel.

[Chapter 10: Other Court Units](#) contains specific design guidelines for the Office of the Circuit Executive (USCA), Office of the Bankruptcy Administrator, Office of the Bankruptcy Appellate Panel clerk (BAP), Office of the Senior Staff Attorney (USCA), Office of the Pre-Argument/Conference Attorney (USCA), Office of the District Court Executive (USDC), and the trial preparation suite for the federal public defender.

[Chapter 11: Shared Support Spaces](#) defines specific design guidelines for shared judges’ conference rooms, news media rooms, central mail and package screening stations, central mail facilities, bulk and archival storage, and communications equipment rooms and risers. There are two distinct types of shared support space:

Judiciary Shared Spaces - judges’ conference room, news media room, bulk and archival storage, and communications equipment rooms and risers.

Building Joint Use Shared Spaces - central mail and package screening and building mail facilities.

[Chapter 12: Tenant Improvements and Furnishings](#) contains specific design criteria for finishes, built-in millwork, and movable furniture.

[Chapter 13: Interior Signage](#) contains specific standards for interior signage.

[Chapter 14: Acoustics](#) contains specific acoustic criteria for various areas of the courthouse.

[Chapter 15: Building Systems](#) contains specific technical requirements relevant to courthouse functions and spaces. Performance criteria for these systems are provided in [GSA PBS P-100](#).

[Chapter 16: Building Security](#) describes security requirements for court facilities.

[Chapter 17: Renovations and Alterations](#) provides guidance and information for major and minor renovation and alteration projects that are planned either by the Judiciary or by the GSA.

[Chapter 18: Alternative Workplace Strategies](#) describes alternative workplace strategies that result in more efficient use of space than traditional office/workstation layouts and complement a mobile work force, collaborative work environments, and modern information technologies.

The appendix contains the RDS referenced in the *Design Guide*, and the glossary provides definitions to referenced abbreviations.

Changes to the *Design Guide*

Any suggestions for modifications to the *Design Guide* should be forwarded to the [Chief, Space and Facilities Division, AOUSC](#).

Figure 1.1
U.S. Court of Appeals - Relevant Chapters

Colors Legend:

- Chapter 3**
Planning for U.S. Courthouses
- Chapter 4**
Courtrooms and Associated Spaces
- Chapter 6**
Judges' Chambers Suites
- Chapter 7**
Court Libraries
- Chapter 8**
Clerk's Office
- Chapter 10**
Other Court Units

Symbols Legend:

- Public Circulation
- Public Vertical Circulation
- Restricted Circulation
- Restricted Vertical Circulation
- X
 Circulation Access Control Point

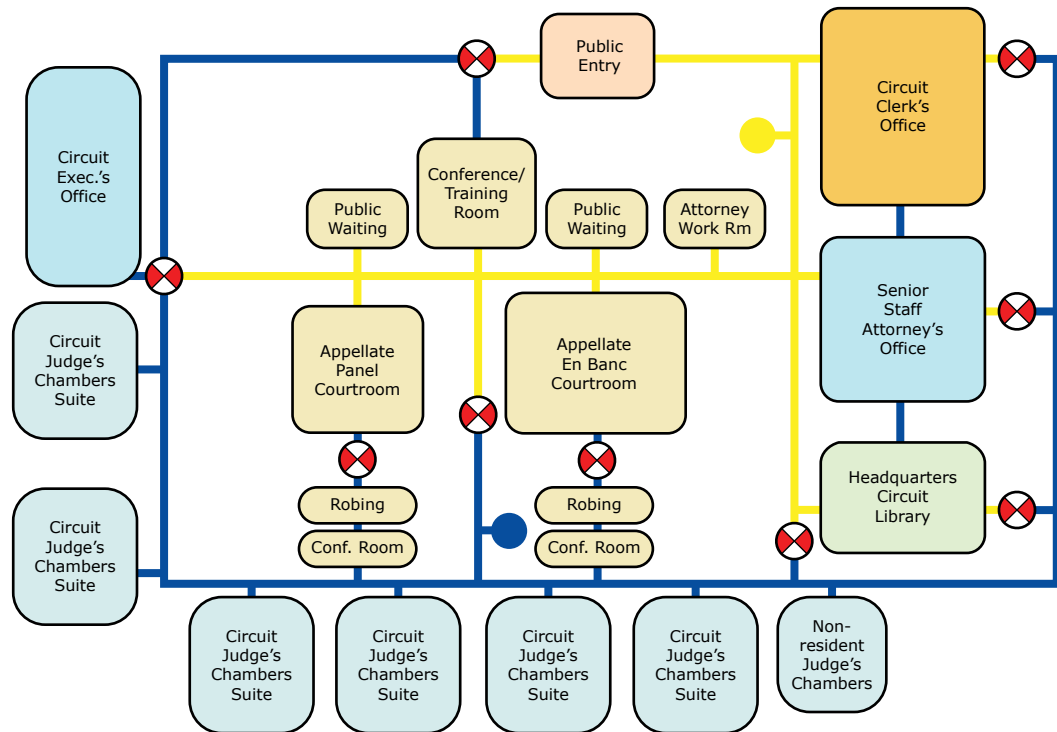

Note: The adjacency diagram is intended only as an illustration.

Figure 1.2
U.S. District Court - Relevant Chapters

Colors Legend:

- Chapter 3**
Planning for U.S. Courthouses
- Chapter 4**
Courtrooms and Associated Spaces
- Chapter 5**
Jury Facilities
- Chapter 6**
Judges' Chambers Suites
- Chapter 7**
Court Libraries
- Chapter 8**
Clerk's Office
- Chapter 9**
Probation and Pretrial Services Offices
- Chapter 10**
Other Court Units

Symbols Legend:

- Public Circulation
- Public Vertical Circulation
- Restricted Circulation
- Restricted Vertical Circulation
- Secure Circulation
- Secure Vertical Circulation
- Service Vertical Circulation
- Circulation Access Control Point

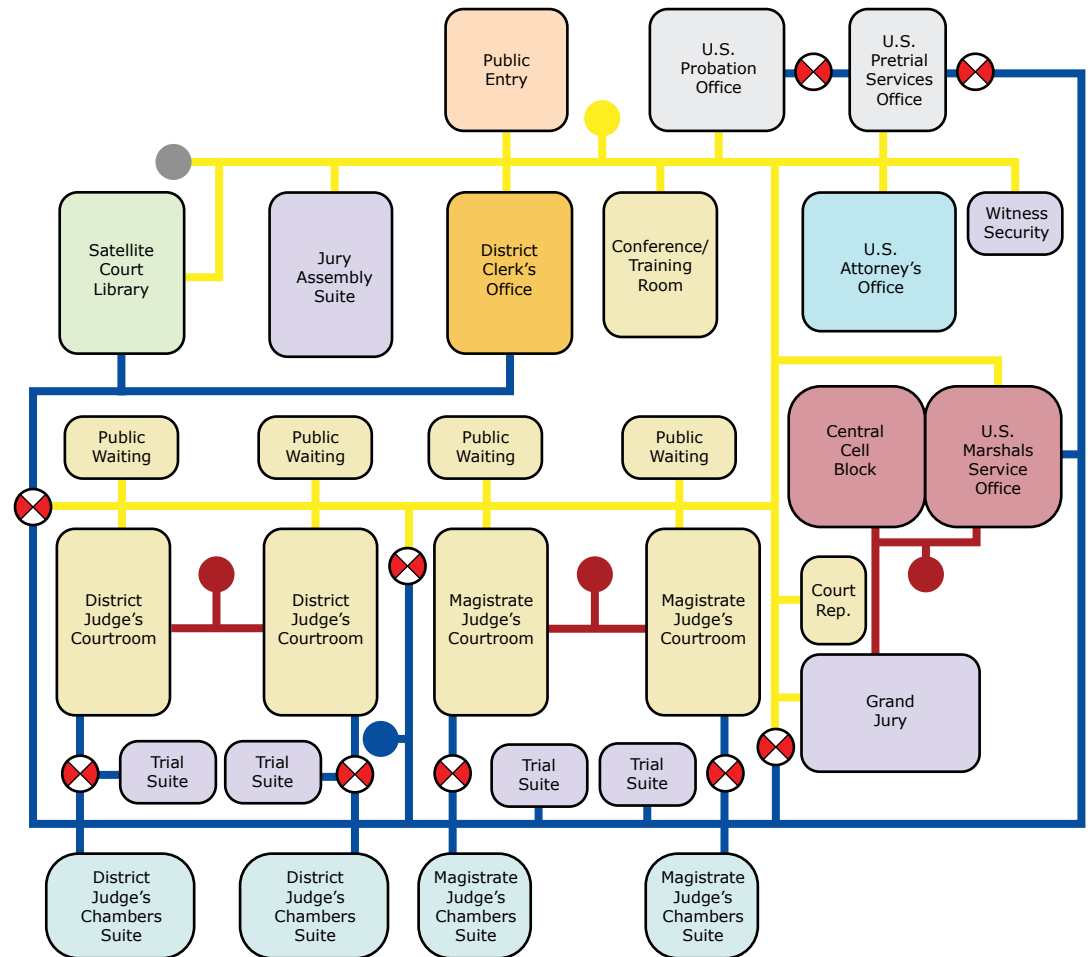

Note: The adjacency diagram is intended only as an illustration.

Figure 1.3

U.S. Bankruptcy Court - Relevant Chapters

Colors Legend:

- Chapter 3**
Planning for U.S. Courthouses
- Chapter 4**
Courtrooms and Associated Spaces
- Chapter 6**
Judges' Chambers Suites
- Chapter 7**
Court Libraries
- Chapter 8**
Clerk's Office

Symbols Legend:

- Public Circulation
- Public Vertical Circulation
- Restricted Circulation
- Restricted Vertical Circulation
- Service Vertical Circulation
- X
 Circulation Access Control Point

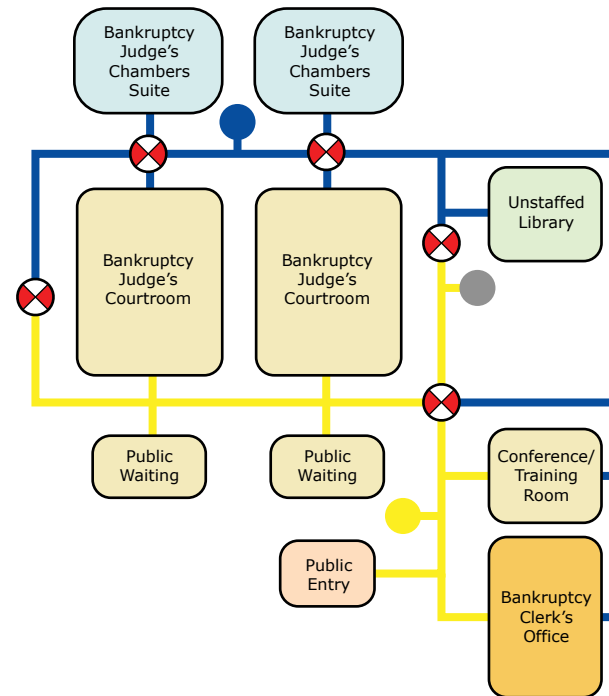

Note: The adjacency diagram is intended only as an illustration.



COURTHOUSE PROGRAMMING AND BUDGETARY CONSIDERATIONS

This chapter describes the process used to plan, program, design, and construct federal court facilities and provides strategies for developing cost-effective courthouses to accommodate the Judiciary's current and future needs. The budgetary responsibilities of the Judiciary, the General Services Administration (GSA), and other courthouse project participants are also described.

Chapter Topics:

- Introduction
- Supporting Documents
- General Cost-Control Strategies
- Value Engineering and Life-Cycle Costing
- Typical Federal Courthouse Project Development Process

Chapter Figures and Tables:

Figure 2.1	Cost Influence Graph
Table 2.1	Construction Costs of Judicial Facilities by Building Element
Table 2.2	Funding Responsibilities

Introduction

Federal courthouse space and ceiling requirements for specific projects are developed through a process of planning, programming, design, and construction. This process includes a project team composed of the Judiciary (judges, court unit executives, court project architects, assistant circuit executives (ACEs) for space and facilities, circuit judicial councils, and Administrative Office of the U.S. Courts (AOUSC) management and professional staff); consultants (architects, engineers, audiovisual engineers, registered communications distribution designers, acoustic and lighting engineers, and U.S. Marshals Service (USMS) systems, security, and equipment engineers); GSA and other federal agencies; and contractors. Court unit executives manage and oversee court operations in their court unit, ensuring that judges and court employees are able to meet the Judiciary's mission of equal justice under law. The project team is required to make informed decisions about the Judiciary's functional needs while effectively controlling project costs. The project team should consider efficiency, value, life-cycle cost, and budgetary impact when making design decisions.

The criteria presented in this document *do not* represent an entitlement to space, furnishings, or finishes. However, the application of the criteria presented is intended to help direct project decisions toward producing functional, cost-effective facilities. Project teams should be conscious of the estimated project budget during the decision-making process. It is not the intent of the *Design Guide* to be overly prescriptive or to impede creative ideas to address the space and operational needs of the courts. The absence of a *Design Guide* standard or requirement does not imply authorization of a project without approval by the appropriate authority. Courts should work closely with their respective ACEs, GSA, and their architectural/engineering (A/E) team to identify areas of concern and develop cost-efficient and effective solutions.

Supporting Documents

The references listed below provide information on many facets of the design and construction of federal courthouses. They are not intended to be a substitution for *Design Guide* standards.

General References

- *American Society of Heating, Refrigerating, and Air-Conditioning Engineers (ASHRAE) Handbook Series*, most current editions adopted by the Department of Energy

- *Architectural Barriers Act Accessibility Standard (ABAAS)*
This document contains scoping technical requirements for implementation of the Architectural Barriers Act (ABA) of 1968 and is the GSA accessibility standard which replaced the UFAS on May 9, 2006. This standard applies to all federal projects.
- *Design Notebook for Federal Building Lobby Security*, GSA and USMS, undated
The goal of this publication is to illustrate how effective security screening and the related equipment and personnel can be integrated into the design of lobby spaces in new courthouses. The notebook includes prototype designs as well as typical details.
- *Facilities Standards for the Public Buildings Service (GSA PBS P-100)*, most current edition
Court facilities are built under GSA's construction program. GSA PBS P-100 establishes design standards and criteria for new buildings, major and minor alterations, and work in historic structures for the Public Buildings Service (PBS) of GSA. The publication includes criteria for the site; building structure (including seismic design); building mechanical and electrical systems; building services such as elevators, fire protection, and security; resilience for the service life of the asset; and general office design. The publication also contains references to appropriate building codes. In contrast, the *Design Guide* covers only those criteria pertaining to the unique functions of the U.S. Courts. Where appropriate, the *Design Guide* directly references criteria found in GSA PBS P-100.
- *GSA CourtsWeb*
- *GSA Design Guide for Operational Excellence*, most current edition.
- *GSA National Business Space Assignment Policy (NBSAP)*, most current edition
- *GSA Smart Building Implementation Guide*
- *GSA Smart Building Program Guide*
- *Illuminating Engineering Society (IES) Lighting Handbook*, most current edition, Chapter 10, "Lighting Design Guide"
This document contains the recommended foot-candles for all types of spaces, such as offices, conference rooms, courtrooms, etc., that could be designed within a court facility.
- *IES G-1-16, Guide for Security Lighting for People, Property, and Critical Infrastructure*, most current edition
This document is intended to provide specific guidelines for situations where it has been determined that security is an issue and an important determining factor in the design or retrofit of a given property.
- *IES RP-1, American National Standard Practice for Office Lighting*, most current edition
- *IES RP-20, Lighting for Parking Facilities*, most current edition
The primary purpose of this document is to provide recommendations for design of fixed lighting for parking facilities.

- *Interagency Security Committee (ISC) Security Design Criteria for New Federal Office Buildings and Major Modernization Projects, Medium-High-Level Construction*, GSA, most current edition
- *Pricing Desk Guide*, GSA PBS, most current edition
 - The *Pricing Desk Guide* presents the policies and procedures that the PBS uses to price real estate and related services to federal agencies.
- *Requirements and Specifications for Special Purpose and Support Space Manual (USMS Publication 64), Volume One, Courthouse Management Group Engineering and Architectural*, most current edition
- *Requirements and Specifications for Special Purpose and Support Space Manual (USMS Publication 64), Volume Two, Electronic Security and Hardware*, most current edition
- *Requirements and Specifications for Special Purpose and Support Space Manual (USMS Publication 64), Volume Three, Judicial Security Systems Requirements and Specifications*, most current edition
 - Detailed specifications for security equipment and criteria for USMS administrative and secure spaces are found in USMS Publication 64.
- *Site Security Design Guide*, GSA, most current edition
 - The guide establishes the principles, elements, and process that should be followed when designing site security at any new or existing federal project site.
- *Sound Matters*, GSA, most current edition
 - The guide establishes the principles, elements, and best practice processes that should be followed when designing open offices for occupant acoustical comfort and speech privacy.

Telecommunications Cabling Standards

- *GSA IT - Building Technologies Technical Reference Guide*, most current edition
- *GSA Data Normalization for Building Automation Systems*
- *Telecommunications Design and Distribution Guide (TDDG)*
- *Telecommunications Industry Association (TIA) and Electronics Industries Alliance (EIA), TIA/EIA-568-B Series, Commercial Building*

Telephone/Data Procurement Policy

- *ANSI/CSA/TIA/EIA-942, Telecommunications Infrastructure Standard for Data Centers*, most current edition
- *TIA/EIA-569-A, Commercial Building Standards for Telecommunications Pathways*
- *Vulnerability Assessment of Federal Facilities, Level IV Buildings*, Department of Justice, most current edition

In addition, the following related guides and manuals published by the AOUSC should guide architectural and engineering decisions.

Administrative Office of the U.S. Courts References

The following references are available through the Space and Facilities Division (SFD) of the AOUSC.

- *“AnyCourt” (Program of Requirements)*
 - The Judiciary’s automated space-planning tool is used to provide a court’s space program of requirements for a specific location and project based on personnel data documented in the long-range facilities plan reviewed by the circuit judicial council. This document is utilized by GSA to determine a project’s scope of work, space requirement, and budget.
- *United States Courts Asset Management Planning (AMP) Business Rules*, most current edition
 - The Judiciary’s AMP business rules were adopted by the Judicial Conference of the United States (JCUS) in 2008 to guide the long-range facilities planning process, provide a framework to identify planning alternatives and housing strategies that optimize existing court facilities, support operational needs, and ensure cost efficiency and effectiveness. The rules also specifically address the application of space standards, planning assumptions, and parameters for determining if and when a potential housing strategy will be recommended for progression to the next stage of the planning process, i.e., a prospectus-level GSA feasibility study or a below prospectus-level project.
- *Courtroom Technology Audiovisual Infrastructure Standard*, most current edition
 - The *Courtroom Technology Audiovisual Infrastructure Standard* defines the roles of GSA, A/E teams, and technical consultants for courthouse technology projects and provides technical standards for infrastructure, video evidence presentation systems, videoconferencing systems, and sound systems.
- *Guide to Judiciary Policy*
 - The *Guide to Judiciary Policy* is the official medium by which guidance and information are provided to the Judiciary in support of its day-to-day operations. The guide also codifies policies that are promulgated by the Director of the AOUSC and/or approved by the JCUS. Contributing offices and divisions within the AOUSC are responsible for maintaining their information in a current condition. This document also provides information on the funding, authorization, and documentation required for new furnishings. In addition, information is provided on the hierarchy system for furniture quality and furniture types per position/level of courthouse staff and cost ceilings.
- *U.S. Courts, “The Federal Judiciary”*
- *United States Courthouse Design and Construction Process*, most current edition
- *United States Courts Courtroom Mock-up Evaluation and Assessment Report*, Gulfport, MS; Helena, MT; Miami, FL; Orlando, FL, most current edition
- *United States Courts Moving Guide: A Handbook for Relocating or Expanding Court Operations*, most current edition
- *AO Best Practices Guide for Courthouse Construction*, most current edition

The SFD of the AOUSC has available upon request post-occupancy evaluation reports of completed courthouse and courtroom designs, courthouse videos, and other documentation of the lessons learned from completed projects.

Design professionals who use the *Design Guide* are expected to possess knowledge of and access to literature pertaining to their particular skill areas. Such professionals are also expected to use government, industry, and consensus-based standards in applying *Design Guide* criteria to the design of court projects.

General Cost-Control Strategies

The cost of a courthouse is primarily determined by the size of the building, including both the area (the size and number of spaces) and the volume (the floor-to-floor heights). The size is determined by evaluating the functional requirements of the court (planning), applying the criteria in the *Design Guide* to determine space needs (programming), and developing efficient spatial relationships (design). A more efficient design will likely yield a smaller, more affordable building. An efficient implementation of the program creates a better building for its occupants and users. For each courthouse, construction materials and methods should be selected to satisfy the court's requirements and achieve an optimum balance of up-front initial costs and life-cycle costs.

The JCUS established one of the Judiciary's most critical cost-containment initiatives by calling on the Judiciary to reduce its overall space inventory. In response, the Judiciary has continued to be proactive in cost containment activities related to space and facilities by exploring ways to reduce costs through its national space reduction policies.

New buildings provide the opportunity to explore cost-saving strategies while defining the functional needs of the courthouse. The project development process for renovations and alterations of a courthouse facility in an existing structure represents a greater challenge in creating a balance between function and cost-effectiveness, and therefore demands greater flexibility in defining the program and its relationship to the *Design Guide*. In these situations, courts have the flexibility to configure space within the existing envelope to meet their local needs. However, any significant departure from the square footage standards designated in the *Design Guide* in the space and ceiling requirements tables must be approved by the respective circuit judicial council. This does not mean that existing space is required to be changed to meet *Design Guide* standards. Only new construction completed as part of a renovation should be considered. Courts should consult [Chapter 17, "Renovations and Alterations \(R&A\),"](#) for guidance in these circumstances. References to R&A guidelines are also included throughout the *Design Guide* where appropriate.

The AOUSC, judges, and court unit executives should be a part of the initial planning and program development process to ensure that all requirements are addressed. Before beginning program development and design phases, GSA and the Judiciary should

Figure 2.1
Cost Influence Graph

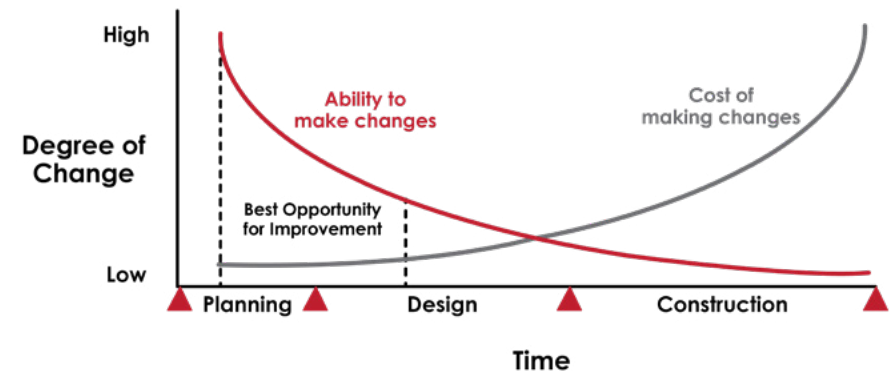

work together to reach an agreement on the appropriate budget for tenant improvements and shell and core costs. As the cost influence graph in [Figure 2.1](#) shows, the greatest opportunity to influence project cost occurs in the planning and programming phases.

Management participation in the planning and programming phases is very important to ensure cost-effectiveness during design and construction. As the project progresses toward the design and construction phases, the cost to implement changes increases. As a cost control strategy, project scope should be defined and agreed upon before designs are developed. Value engineering (VE) is another cost control strategy. During design development, it is optimal to perform value engineering early in the design process. Controlling costs is ultimately an aspect of risk management. During early project planning, programming, and schematic design, integrated involvement of end-users, management, executives, judges, and resource-providing stakeholders is essential to ensure the right project is defined and its costs are controlled.

Construction Cost Benchmarking

The GSA construction cost benchmarks are the estimates used for project budgets. The benchmarks are determined by the GSA benchmark formula.

The cost of constructing judicial facilities is typically higher than the cost of constructing standard federal office buildings, due to the courts' special requirements, including security, separate circulation, and specialized spaces such as courtrooms and judges' chambers. Refer to [Table 2.1](#) for a summary of constructed costs by building element.

Funding Responsibilities

Rental fees paid by the Judiciary to GSA are based on an occupancy agreement (OA) executed by GSA and the AOUSC. The OA identifies shell and core, tenant improvements, parking, and GSA fees. With very few exceptions, GSA's rental rates include standards contained in the *Design Guide*. The project team should refer to GSA's *Pricing Desk Guide*.

The *Design Guide* works in conjunction with GSA criteria to define which features and finishes are provided by GSA as part of the construction cost and which must be funded separately by the Judiciary. Tenant improvement features, such as service counters and ballistic-resistant glazing, result in the Judiciary paying either a higher rental rate or a one-time reimbursable charge.

Refer to [Table 2.2](#) for more details concerning the funding responsibilities of the Judiciary, GSA, and court-related agencies.

Programming and Design Cost-Control Considerations

A facility program that is too rigidly defined does not allow for growth and flexibility. Since a project can typically take seven years from initiation to completion, a rigid program may result in redesign change orders. To avoid this redesign cost, the AnyCourt program of requirements will be used by GSA and the A/E firm to determine the court's needs. However, each court has unique needs based on such factors as geographic location and population. These factors should be considered when developing program requirements. As noted above, courts have the flexibility to configure space within the given envelope, as long as design and construction are in compliance with the square footage standards designated in the *Design Guide* in the space and ceiling requirements tables. If the court unit wishes to change the space standards described in the space and ceiling requirements without exceeding the total envelope of space for the unit, it must seek approval from its respective circuit judicial council. Courts should understand that costs for choices in the design that exceed those assumed in the benchmark (e.g., finishes and space allocation) must be absorbed elsewhere in the program and funded by the court.

The Judiciary allows for program growth, with detailed 10- and 30-year housing requirements (as specified in the AnyCourt). GSA typically designs and constructs courthouses to meet a court's 10-year requirement on a 30-year site. For courthouses, 30-year needs should be considered to avoid having to relocate the courts from a building after it has been constructed. On all prospectus-level construction projects, GSA should require the design architect to provide a plan for accommodating the 30-year needs of the court on the acquired site and demonstrate how the plan complements the project's 10-year housing requirements.

A well-designed courthouse includes a flexible strategy for relocation, expansion, and movement of spaces to address not only the 10-year requirements but also the court's 30-year growth requirements.

Convertible Spaces

Court-related offices initially located in the courthouse can be relocated from the facility to allow expansion of the court. Vacated spaces can be converted into courtrooms and/or associated support facilities. Major court-related offices with the least need to be adjacent to the court include the U.S. Attorney's Office. In addition, areas housing non-court-related offices may be converted to court space, or shell space may be constructed and finished as needed.

Future Expansion

Additional space can be provided within court and court-related spaces to accommodate future expansion for a 10-year requirement only. The amount of space set aside should be based on growth projections contained in the court's long-range facilities plan, as updated through the AnyCourt process. Vertical expansion should not be considered as a viable option due to potential noise and other disruptions to court operations.

For internal expansion and convertible spaces, the following design considerations apply:

- Creating structural zones to accommodate present and future needs
- Constructing court-related office areas with a high bay structure if these offices are to be set aside for future courtroom expansion
- Anticipating the location of future chambers and courtrooms so that judges will have continued access to restricted elevators and circulation patterns
- Planning acoustic isolation to accommodate future offices requiring privacy from the public, but not confidential privacy within the offices
- Creating isolated mechanical zones to accommodate the present and future off-hours needs and/or air-handling needs of courtrooms and chambers
- Designing for the expansion and movement of spaces to allow for the relocation and reuse of workstations, partitions, HVAC equipment and registers, lighting fixtures, electrical outlets, and communication systems

The size of a courthouse may incorporate space-saving approaches, such as the following:

- Staffing projections reflecting current staffing, allocation policy, and trends.
- Operational efficiencies, such as limiting the number of conference rooms, training rooms, libraries, and other office support spaces by sharing among court units.
- Efficient designs reducing the amount of space needed for circulation.
- Judicial support spaces such as conference rooms.
- Multi-use jury assembly areas and grand jury suites.
- Collocating similar functions (e.g., probation and pretrial services offices) so they may share resources.
- Collocating technology (e.g. court technology, telecom, and network) in shared IDF/technology rooms.
- Incorporating alternative workplace strategies and principles as outlined in [Chapter 18, "Alternative Workplace Strategies."](#) These strategies may reduce overall programmed area by incorporating space-sharing principles.

Other space-saving measures include the following:

- Circulation space in the courthouse is reduced when spaces are organized vertically and corridor lengths are minimized. Double-loaded corridors (rooms on both sides of a hallway) should be provided where practical. Circulation requirements are further reduced by organizing mechanical and electrical shafts, elevators, exit stairs, and public toilets around a central core.
- Building volume may be minimized by locating courtrooms, which require greater floor-to-floor heights than office spaces, on as few floors as possible. Additionally, building volume may be reduced by using mezzanine space when grouping low structural bay spaces (i.e., chambers and support space) around high bay spaces (i.e., courtrooms).
- Administrative space may be minimized by providing the clerk’s office and records shelving with contiguous space on a single floor. Storage for bulk supplies, inactive records, furniture, and equipment should be located in basement areas, on the same floor as the loading dock, or in space provided for long-term expansion.

Site Design Cost Drivers

Courthouse construction and operational costs are greatly influenced by the site and environmental characteristics that define the building’s footprint, orientation, and exterior appearance. The size of the site may determine the cost and availability of secured or public parking and govern strategies for future expansion. In 1999, the JCUS adopted a policy regarding parking. To balance concerns about the number of parking spaces assigned against financial constraints, refer to Vol. 16, Ch. 6, § 630 of the *Guide to Judiciary Policy*.

Access to the site, current setback requirements, and the location of other federal agencies will influence security considerations. Additional expenses may be incurred for specialized lighting or landscaping to mitigate site conditions. Generally, a level, square, or rectangular site has proven to be most cost-effective.

Architectural Design Cost Drivers

The most cost-effective court building generally has a rectangular or square footprint. Facilities with low ratios of wall area to space also tend to be more efficient because of reduced circulation requirements, HVAC system costs, and energy consumption.

Other architectural considerations for cost-effective courthouses include the following:

- Spaces sized so that the most efficient structural spans may be used.
- Heavy live load areas such as libraries and file storage grouped around core areas where structural strengthening may be provided economically.
- Non-square angles and rounded areas have been proven to waste space. Areas with non-square angles also require custom-designed furniture, resulting in additional cost.

- Windows and glazed areas are sized and selected appropriately. Glazing costs are higher in judicial facilities in order to address blast, seismic, and ballistic threats. Glazing using custom sizes and shapes, and custom glass types, is even more expensive.
- Exterior wall detailing is simplified, especially on upper floors. This allows the use of high-quality materials on lower floors where they can be appreciated.
- Fully-glazed and oddly-shaped atria increase cost of the enclosure, structure, and MEP systems.
- Building efficiency is a key cost driver and should always be considered during programming and design. A more efficient building has less common and circulation space when compared to the overall usable programmed space and causes the building footprint to shrink, reducing gross building area and building construction cost.
- Skylights increase HVAC costs and can cause maintenance problems. Windows, borrowed light, and clerestories provide natural light at lower initial and life-cycle costs.
- Energy, water, and mechanical operations efficiency substantially lowers costs over the life of the asset.
- Placing speech privacy areas adjacent to each other requires dense walls between the spaces to meet acoustical requirements. Including buffer spaces and sound locks helps limit the construction requirements. Design of areas or rooms requiring sound privacy should be attentive to acoustics and sound transmission and the cost impacts of construction required to contain sound.

Value Engineering and Life-Cycle Costing

VE is a method of calculating the value received for the dollars spent over the lifetime of a building, with the emphasis placed on obtaining the maximum life-cycle value. These calculations should include the cost of construction, operation, and repair of the facility, and the efficient delivery of services. If value engineering is not applied until the later stages of design or after the design is completed, it may cause an examination of alternative design solutions; the substitution of materials, finishes, or systems; and a reevaluation of project priorities. Performing value engineering before the design development stage of design will give the design team the most options in making changes while not causing major redesign. It is important to have a non-biased value engineering approach which emphasizes the use of a “cold” design team and certified value specialist (CVS) as part of the VE workshop. This “cold” team should approach the VE workshop with a blank slate and be able to consider all options in order to improve the value of any project. The maximum life-cycle value may result in increased initial construction costs in exchange for decreased operation costs over the useful life of the building system. Value engineering should not be a vehicle for reducing the initial construction cost of the building. The construction cost per square foot is not the only measure of value when considering the efficiency of the total facility. The life-cycle cost of a building will be reflected in the efficiency of a building long after it is built and occupied.

Life-cycle cost analysis (LCCA) should be used to assess the total cost of building ownership. It considers all costs of acquiring, owning, and disposing of a building or building system. LCCA is very useful when the owner is considering and analyzing the project and/or design alternatives that fulfill the same performance requirements but differ with respect to initial and operating costs. For example, LCCA will help determine whether the incorporation of a [high-performance HVAC](#) or [glazing system](#), which may increase initial cost but result in dramatically reduced operating and maintenance costs, is cost-effective. Accurately forecasting the LCCA of a building system can be broken into two equally important parts. First, understanding the initial installation cost of the system is critical in accurately forecasting a specific item's life-cycle cost. Cost estimates need to be completed for these building systems as these costs will form part of any LCCA. Second, and equally important, an analysis of operations and maintenance costs needs to be completed for all large building systems, especially the mechanical and electrical trades. It is critical to forecast these two aspects as part of the life-cycle cost of a specific item or system. LCCA should be performed in accordance with the National Institute of Standards and Technology's *Life-Cycle Costing Manual for the Federal Energy Management Program* handbook. The output files from the approved government software will be a deliverable during the design process. LCCA should consider the following and refer to 10 CFR 436 for the appropriate LCCA study period for new courthouses (new federal buildings) and courthouse retrofits:

- The payback period for each building component should take into account the useful life of a federal courthouse.
- The functions performed in the building may change or be relocated over time.
- The location of a particular building system, fixture, or finish should take into account special conditions that arise in federal courthouses.

Typical Federal Courthouse Project Development Process

There are different models for courthouse project development, and a summary of the commonly used project delivery methods is provided below. For an in-depth discussion of the roles and responsibilities of each agency as they relate to the project delivery methods, refer to the *AO Best Practices Guide for Courthouse Construction*, most current edition.

Design-Bid-Build

Design-bid-build (DBB) or design-award-build (DAB) is a traditional project delivery method that involves three sequential project phases: the design phase, bid phase, and construction phase. At the outset of a project, GSA contracts a design team, typically composed of architects and engineers, to develop construction drawings and specifications that meet the project goals and budget. After the construction documents have been completed, a contractor, with whom GSA contracts separately, is selected through a bidding process to build the project. The project then enters the construction phase where it is built by the contractor per the design team's plans and specifications.

Design-Build

Design-build (DB) is a method of project delivery whereby GSA contracts a single entity to provide both design and construction services. Because the design and construction services are integrated, this project delivery method allows the project schedule to be accelerated by overlapping portions of the design and construction phases.

Bridging Design-Build

Bridging design-build (BDB) is a hybrid project delivery method that utilizes aspects of both the traditional DBB and DB processes. At the beginning of a project, GSA will contract directly with a design consultant to develop bridging contract drawings and specifications that meet the project's goals and budget. The bridging contract documents will establish the project's design intent; however, the documents will be less developed than traditional construction documents. After the completion of the bridging contract documents, a design-builder is selected through a bidding process. Upon selection, the design-builder will continue to develop the project, produce construction drawings and specifications, and be responsible for the construction of the project.

Construction Manager as Constructor

Construction manager as constructor (CMc) is a project delivery method that utilizes a construction manager during the late stages of design to provide constructibility consultations, cost estimating, and other professional services prior to constructing the project. At the beginning of this project delivery method, GSA contracts a design team similarly to a traditional DBB process. However, after the early stages of design, GSA will contract a CMc to consult on several aspects of the project and provide a guaranteed maximum price for the construction of the project. After assuming responsibility for the construction, the CMc will contract subcontractors to complete the construction phase within the set project schedule and parameters outlined in the contract documents. Refer to *GSAR 536.71 Construction-Manager-As-Constructor Contracting* for additional information.

The Planning, Programming, Design, and Construction Process

Although there are different models available for development of a courthouse construction project, a typical project development process includes four phases:

Planning

The planning phase includes evaluation of workloads, staffing levels, procedures, organizations, and administrative requirements.

Programming

The programming phase translates functional requirements into a space needs (housing) plan and defines the project's design objectives.

Design

Drawings and specifications for constructing the facility are developed in the design phase through an iterative process of increasing detail.

Construction

Materials and labor are organized to implement the design in the construction phase.

A typical project development process for a federal courthouse is described below. Not all projects will follow this exact sequence of events. Cost evaluation and control opportunities occur at each step and should be addressed by the court, GSA, and all consultants.

Planning Phase

Before the project begins, a group of court personnel responsible for facility planning and development should be formed, consisting of judges, court unit executives, and other representatives of the Judiciary. The group should be cost-conscious and creative in developing efficient court facilities. The services of a design and construction professional working directly for the court may be needed to ensure complete and thorough compliance with the *Design Guide*.

Asset Management Planning

In March 2006, the JCUS adopted, in concept, the AMP process as an objective methodology that identifies costs and benefits of alternatives to enhance the current long-range facility planning process. AMP holistically assesses facilities, identifies non-prospectus- and prospectus-level new construction and renovation space projects, considers pros and cons of specific housing strategies, and determines the best strategy by city to meet current and future operational needs.

The court begins planning by evaluating existing facilities and identifying any space deficiencies. Concurrent with the evaluation of existing facilities, the court identifies current and future caseload and staffing requirements. The criteria in the *Design Guide* are combined with this data to identify and develop alternative housing strategies to meet the court's short- and long-term needs. These housing strategies might include leases, minor or major repair and alteration projects, or new courthouse solutions. Accurate data and justifiable assumptions are essential to maximize cost-effectiveness. The resulting long-range facilities plan documents the court's immediate and long-term facility requirements, recommended potential strategies, and cost-benefit analysis, which is provided by an A/E consultant and must be approved by the chief judge of the district and reviewed by the circuit judicial council. AMPs are used by the Judiciary to identify, justify, and prioritize projects that become part of the *Federal Judiciary Courthouse Project Priorities* (CPP). The CPP is a national prioritized list of proposed court construction projects approved by the JCUS.

In 2008, the JCUS delegated to the Committee on Space and Facilities the authority to establish and amend the business rules that govern the AMP methodology. Refer to the *AMP Business Rules Appendix* and Vol. 16, Ch. 1, § 120 of the *Guide to Judiciary Policy*.

Circuit Rent Budget (CRB) Program

The JCUS approved the Circuit Rent Budget (CRB) program as a cost-containment initiative that limits annual rent growth and puts more responsibility on the circuit judicial councils to determine space need priorities within set allocations for rent.

The rent budget has been separated into three components:

Component A: Funds for Current Space

Rent funding is provided for the existing space inventory, including inflationary increases.

Component B: Project-Specific Funds

- Major projects (e.g., new courthouses, annexes, modernizations, and lease-construct courthouses) approved by both the Committee on Space and Facilities and the JCUS.
- Chambers and courtrooms for senior/replacement judges and new judgeships approved by the Committee on Space and Facilities.
- Security pavilion requests to adjoin an existing building must be reviewed by the Committee on Judicial Security before they are considered by the rent management subcommittee of the Committee on Space and Facilities, so that the need for a pavilion from a security standpoint and the impact of the project on the Court Security Appropriation can be taken into account, as well as any potential increase in rent costs. These projects must receive approvals from the Committee on Space and Facilities, Committee on Judicial Security, and the JCUS.

Component C: Circuit Discretionary Funds

Funding allocated to circuit judicial councils by formula for under-prospectus space acquisitions and alteration projects.

For under-prospectus-level renovation or alteration projects, courts can utilize either local funds or request Component C funding from circuit councils. If a project involves a new chambers or courtroom, then Component B funding can be requested and coordinated through circuit executives' offices and the AOUSC.

For prospectus-level renovation or alteration projects, the process will take more time, primarily because congressional authorization and appropriation must be secured. Project drivers must be identified and the following questions asked:

- If new or replacement judges are expected – has the existing court space been thoroughly assessed for alteration or expansion possibilities?
- If other agency space is viewed for possible expansion, have their occupancy

agreement¹ (OA) terms been checked? If sufficient notice is given and planned to coincide with the expiration of the other agency's OA, the Judiciary can save money by not paying forced move costs.

- Is the space viewed for expansion occupied by a large agency which cannot move piecemeal and should move all at once? This may create excess vacant space that GSA may not be able to rent out easily, or on which the Judiciary may be obligated to pay rent.
- Has an AMP recently been completed for the district or circuit? What are the findings?
- Have all the relevant CRB business rules² been followed?
- Is GSA planning systems work that will affect tenant space or operations?

It is important to understand GSA's plans for its buildings. What may appear initially as a cost-saving measure for the Judiciary (such as remaining in an existing building or in leased space), may not always end up being the most cost-effective solution in the long run. For example, if GSA is unable to find other tenants to fill the building, or if a building's deficiencies cost more to fix than a new building would cost, the Judiciary may end up paying higher rent than originally contemplated.

Program Development Phase

The detailed programming, design, and construction of federal courthouses is the responsibility of GSA. GSA initiates a project as requested in the Judiciary's CPP. The GSA's development process begins with a feasibility study that identifies the federal government's facility resources and requirements in a given geographic area. The plan identifies other agencies that may use space in a courthouse for long-term or interim occupancy. The design of facilities for the long-range needs of the courts and overall project budgets is greatly influenced by these occupancy and federal dollars investment decisions. Since a courthouse is a major investment of capital, the need to properly plan and program the project requires integrated commitment and earnest attention to the details available to plan the right project for the investment of federal taxpayer dollars. In response to its real property investment responsibilities, GSA oversees and delivers courthouse projects as a program, and follows standard project management policies and practices to deliver each courthouse project with a regional structure. GSA's central and regional subject matter experts, including the courthouse program's subject matter experts, review projects to ensure consistent, excellent, and cost-effective delivery of the courthouse construction program. The courthouse program is responsible for the management of new federal courthouse construction and the modernization of existing courthouses.

GSA retains the services of a consulting architect or planner to produce a feasibility study. The feasibility study is a programming document that evaluates housing alternatives and further defines the project scope and budget. It uses the court's long-range facilities plan, the court's AnyCourt program of requirements, and the GSA construction cost benchmark as a basis for development. AnyCourt provides detailed square footage requirements for each court function for a specific location, based upon the AMP and supplemental information provided by the Judiciary.

The study addresses site acquisition, design and construction, building systems, and tenant support services, as well as related design issues such as security, court electronic systems, telecommunications, and cost. The study contains a project implementation strategy, including project scheduling, cost-control measures, and other factors.

The purpose of the construction cost benchmark is to establish a budget that provides sufficient funding to deliver a new court facility that meets all *Design Guide* requirements.

The construction cost benchmark is based entirely on information developed in GSA's courthouse program. Because subsequent changes are difficult and more expensive to make as a project progresses, each court should help ensure that its courthouse program is accurate and complete. Features or systems not included in the initial cost estimate will not be funded if they are identified later in the process.

¹ Occupancy agreement – Each space assigned in a GSA-controlled space has an agreement between GSA and the customer agency, stating the financial terms and conditions for occupancy.

² Circuit Rent Budget (CRB) business rules – A set of 11 business rules governs how the three funding components are determined and how rent funds can be used.

Determining the Number of Courtrooms Per Courthouse

The JCUS has adopted policies requiring courts to take several factors into account when considering the construction of courtrooms.

The availability of a courtroom is essential to the fulfillment of the judge's responsibility to serve the public by disposing of criminal trials, sentencing, and civil cases in a fair and expeditious manner, and presiding over the wide range of activities that take place in courtrooms requiring the presence of a judicial officer. With this in mind, the JCUS has adopted policies to determine the number of courtrooms needed at a facility. Refer to Vol. 16, Ch. 2, § 220 and § 230 of the *Guide to Judiciary Policy* for more information regarding these policies.

Active Article III Judges

Provide one courtroom for each active district judge.

Senior District Judges

Provide one courtroom for every two senior district judges. If the court projects an odd number of senior district judges, the number of senior district judges' courtrooms will be rounded up (e.g., for seven senior district judges, four courtrooms will be provided).

Magistrate Judges

In courthouses with one or two magistrate judges, provide one courtroom for each magistrate judge.

In courthouses with three or more magistrate judges, provide one courtroom for every two magistrate judges, plus an additional criminal duty courtroom. If the district court has an odd number of magistrate judges, the number of magistrate judges' courtrooms will be rounded down (e.g., for seven magistrate judges, three courtrooms will be provided plus the criminal duty courtroom).

Bankruptcy Judges

In courthouses with one or two bankruptcy judges, provide one courtroom for every bankruptcy judge.

In courts with three or more bankruptcy judges, provide one courtroom for every two bankruptcy judges plus one courtroom for emergency matters. If the bankruptcy court has an odd number of bankruptcy judges, the number of bankruptcy judge's courtrooms will be rounded down (e.g., for seven bankruptcy judges, three courtrooms will be provided, plus the additional courtroom).

Multi-Party Courtrooms

A multi-party courtroom may be planned for a new courthouse with at least four standard district judge's courtrooms. Such courtrooms should be provided only when needed and must be assigned for normal daily use in addition to use for special proceedings and large, multi-party trials. A multi-party courtroom must be considered an exception if it is provided at a location where there are fewer than four district judge courtrooms. Provision of more than one such courtroom in any facility is also considered an exception.

Courts should determine whether there is a need for a multi-party courtroom at the onset of a project. Multi-party courtrooms may provide a more flexible space, which may be ideal for multi-party trials, naturalization ceremonies, and other uses. Refer to [Chapter 4, "Courtrooms and Associated Spaces," Programming and Budgetary Notes](#) for information pertaining to multi-party courtrooms.

The following assumptions, endorsed by the JCUS, should be considered to determine courtroom capacity in new buildings, new space, or space undergoing renovation. This model allows assumptions to be made about caseload projections and the time frames in which replacement, senior, and new judgeships will occupy the new facility. The model affords flexibility to courts and circuit judicial councils when making decisions about the number of courtrooms to construct in a new facility since adjustments to the assumptions may be made to reflect a specific housing situation "on line."

- The number of new judgeships recommended by the JCUS.
- The number of years senior district and circuit judges will need a courtroom after taking senior status (retirement age is assumed to be 85).
- The senior status eligibility date for appointed judges at the court location.
- Caseload projections based on the district's long-range facilities plan.
- The percentage of the total district caseload handled at the location.
- The year the district and circuit judges are expected to take senior status once they become eligible (a court or circuit judicial council should assume that a judge will take senior status when eligible).

The planning assumptions listed above are subject to modification for just cause by courts in consultation with the respective judicial council.

In addition, the following factors should be taken into account:

Courtrooms for Projected Judgeships

New courthouse construction projects shall be designed to provide space for the existing circuit, district, bankruptcy, and magistrate judges (including vacant judgeship positions), and senior district and circuit judges, as well as space to account for judges who will be eligible for senior status within the 10-year planning period for the project consistent with JCUS policy and congressional direction.

Space for JCUS-recommended judgeships not yet created by Congress is to be taken into consideration at the design concept phase where architects will show how space for these judgeships could fit into the design. Architects will not, however, complete a detailed design that includes space for these judgeships because they have not yet been created by Congress. At this stage, the project would be authorized for a specific number of courtrooms and chambers. A change (increase) would require an amended prospectus, authorization, and funding from the Judiciary.

Space for judgeships that the Judiciary projects will be needed, but have not yet been recommended to the JCUS for approval, will be considered by GSA as part of future expansion plans for the building. Space will not be programmed or included in the design for these projected positions.

Courtroom Sharing

With declining resources and implementation of space- and cost-saving measures by the Judiciary over the last few years, courtroom sharing is recognized as a necessary model for future court operations. In addition, the Judiciary's courtroom sharing policy shall be considered for renovation and alteration projects, including forced moves or existing buildings that inherit new senior judges but lack enough courtrooms. For more information on courtroom sharing policies, refer to Vol. 16, Ch. 2, § 230 of the *Guide to Judiciary Policy*.

In the event a sharing arrangement would cause substantial difficulty to the effective and efficient disposition of cases, a court, as a whole, with the approval of its circuit judicial council, may seek an individual exemption to the JCUS sharing policy from the JCUS's Committee on Space and Facilities. Such exemptions should be considered the exception and not the rule.

Senior District Judge Sharing Policy Exemption Criteria

To be considered for an exemption, a court shall first show a per-active-judge caseload that, absent special circumstances, meets or exceeds the standard established by the JCUS for the consideration of the creation of a new judgeship. Thereafter, a court should demonstrate that deviation from the basic sharing policy of one courtroom for two senior district judges is necessary, based on the following:

- An assessment of the number and type of courtroom events anticipated to be handled by the senior district judge that would indicate that sharing a courtroom would pose a significant burden on the effective and efficient management of that judge's docket.
- The estimated number of years the senior district judge for whom an exemption is sought would need a courtroom after taking senior status, along with a description of how the district has historically utilized senior district judges.
- An assessment of the current complement of courtrooms and their projected use in the facility and throughout the district, to reaffirm the necessity of constructing an additional courtroom.

- Whether a multi-party or other courtroom is available for the senior district judge's use in the new or existing facility.

Magistrate Judge Sharing Policy Exemption Criteria

To be considered for an exemption, a court shall first show that the magistrate judge's courtroom is in use over 75 percent of the work day for case-related purposes. Thereafter, a court should demonstrate that deviation from the basic sharing policy is necessary, based on the following:

- An assessment of the number and type of courtroom events anticipated to be handled by the magistrate judge that would indicate that sharing a courtroom would pose a significant burden on the secure, effective, and efficient management of that judge's docket.
- An assessment of how the district has historically utilized its magistrate judges, supported by actual courtroom use data.
- An assessment of the current complement of courtrooms and their projected use in the facility and throughout the district, to reaffirm the necessity of constructing an additional courtroom.
- Whether a multi-party or other courtroom is available for the magistrate judge's use in the new or existing facility.

Bankruptcy Judge Sharing Policy Exemption Criteria

To be considered for an exemption, a court shall first show that the bankruptcy judge's courtroom is in use over 75 percent of the work day for case-related purposes. Thereafter, a court should demonstrate that deviation from the basic sharing policy is necessary, based on the following:

- An assessment of the number and type of courtroom events anticipated to be handled by the bankruptcy judge that would indicate that sharing a courtroom would pose a significant burden on the secure, effective, and efficient management of that judge's docket.
- An assessment of the current complement of courtrooms and their projected use in the facility and throughout the district, to reaffirm the necessity of constructing an additional courtroom.
- Whether a multi-party or other courtroom is available for the bankruptcy judge's use in the facility.

Many bankruptcy judges are housed in leased facilities where security concerns may arise due to the configuration of the space. Because of this unique situation, an alternative exemption to the sharing policy, notwithstanding the exemption requirements of the previous paragraph, may be considered for bankruptcy judges in leased facilities based on an assessment of the security of a bankruptcy judge's access from chambers to a shared courtroom.

Sizing Courthouse Support Spaces

Certain design decisions are based on the number of people served by the courthouse (the number of exits and restrooms, etc.). Most building codes have square footage allotments per person. Such allotments, which vary by building type, generally yield an estimate far exceeding the actual population in court facilities. The primary cause of this overestimation is the failure to adequately consider the following two factors:

- Some users of a courthouse have different facilities requirements at various times of the day, resulting in duplicate spaces. For example, in a typical day, a single juror might occupy the jury assembly room, jurors' lounge, courtroom jury box, trial jury room, and other spaces. Similarly, a judge might use a private chambers office, judges' conference room, and courtroom.
- A simple count of the number of seats in a courtroom does not accurately yield the size of the spectator population. Because spectator seating is used in the jury selection process, the average size of a jury panel largely determines the number of seats provided in the spectator area (usually 65–85 seats). A typical U.S. District Court (USDC) trial usually attracts fewer than a dozen spectators.

For the above reasons, population estimates for court facilities should take into account the different types of space, the users of the space, and overlapping space use.

Design Phase

When project design funding has been authorized and appropriated, GSA selects the design architect/engineer with input from the courts, in accordance with the requirements of the Brooks Act (40 USC Sections 541–544). The courts should actively participate throughout the selection process to become familiar with the various design teams and to ensure that each team understands the court's facility requirements. Court participation is important because once a design team is selected, the success of a project depends on the ability of all parties to communicate effectively.

During the design stage, after a more definite cost estimate has been generated, a construction prospectus is submitted to Congress for the authorization and appropriation of construction funds. The courthouse construction benchmark tool is used to generate the cost for construction and informs the construction prospectus request if there is one. The construction prospectus is not developed based on a cost estimate of a design. Current escalation factors, locality factors, and market conditions are taken into account. If appropriations are lower than requested, or if construction bids are higher than estimated, the courts, GSA, and consultants may have to modify the facility program and redesign the project to meet the appropriated budget.

Construction Phase

Once a construction prospectus is funded, a contract is awarded. The contract may specify that the GSA contractor identify opportunities for cost savings. The courts should be aware of the functional and cost impact of changes made during construction.

Construction Costs of Judicial Facilities by Building Element

Table 2.1 provides an overview of relative construction costs for major components of federal courthouses.

Table 2.2 outlines funding responsibilities as they relate to new courthouses. Refer to the *GSA Pricing Desk Guide* for more information.

Table 2.1

Construction Costs of Judicial Facilities by Building Element¹

Element	Share of Total Costs	Major Variables
Foundations ²	1%–4%	<ul style="list-style-type: none"> - Local Soil Conditions - Water Table - Number of Floors
Substructure ³	0.5%–3.5%	<ul style="list-style-type: none"> - Basement Requirements - Soil Capacity - Water Table
Superstructure	10%–18%	<ul style="list-style-type: none"> - Spans - Live Loads - Seismic Conditions - Plan Shape
Exterior Closure	7%–17%	<ul style="list-style-type: none"> - Wall-to-Area Ratio - Floor-to-Floor Height - Material Selections - Amount and Choice of Glazing - Wall Detailing
Roofing	0.5%–2.5%	<ul style="list-style-type: none"> - Roof Treatment - Traffic Requirements - Number of Floors
Interior Construction and Tenant Improvements (TIs)	13%–25%	<ul style="list-style-type: none"> - Partitions - Lighting - Material Selection - Acoustics/Floor-to-Slab Partitions - Finish Detailing - Security Requirements - Number of Court Units/Specialized Spaces
Conveying Systems	3%–5%	<ul style="list-style-type: none"> - Traffic Requirements - Number of Core Areas - Elevators/ Cab Detailing - Escalators - Number of Floors

Element	Share of Total Costs	Major Variables
Mechanical	12%–20%	<ul style="list-style-type: none"> - Load Requirements - Security and Acoustics - Operating Flexibility - System Selections - Controls - Local Geographic Conditions - Level of Energy Savings
Electrical	10%–18%	<ul style="list-style-type: none"> - Load Requirements - Lighting Levels and Quality - Security - Operating Flexibility - Communications - Audio and Video Design - Level of Energy Savings, Features, Systems Selections
Equipment	0.3%–1.5%	<ul style="list-style-type: none"> - Scope
Site Work	2%–7%	<ul style="list-style-type: none"> - Utility Service Location - Local Conditions - Access/Egress - Security - Parking³
General Conditions, Overhead, and Profit	6%–13%	<ul style="list-style-type: none"> - Project Magnitude - Project Complexity - Market Conditions - Other Risks - Location

¹ These ranges for building elements do not include any overhead or profit. Overhead and profit are shown as a separate element.

² Foundations, substructure, and roofing percentages will vary by the number of floors and the building footprint.

³ The parking area does not count as usable square feet assigned to tenants but is included in the total gross square feet of a new courthouse construction project.

Table 2.2
Funding Responsibilities

Building Component	GSA Budget Cost	Judiciary Budget Cost	Funded By Others
Base Building	Site Improvements	None	None
	Building Envelope and Structure	None	None
	Building Systems (HVAC, plumbing, electrical)	None	None
Exterior Materials	Exterior facade materials of brick, stone, glass, precast, metal, or similar materials	None	None
Finishes in Interior Public Spaces	Courtroom lobbies on each floor finished as an extension of the main public lobby spaces; all areas and corridors connecting the main public lobby on the primary entry level to all courtroom lobbies finished at a quality level equivalent to the main public lobby; and public corridors connecting other office areas finished at standards described in the <i>Facilities Standards for the Public Buildings Service</i> .	None	None
Finishes in Courtrooms, Judges' Chambers, Associated Spaces, and Offices	Per requirements outlined in Chapter 12 of the <i>Design Guide</i>	Any tenant improvements beyond the TI construction budget allotment should be avoided if possible as they shall be funded via RWA.	None
Movable Furniture and Equipment	Four (4) attorney tables per district courtroom and two (2) tables per magistrate and bankruptcy judge courtroom. Tables shall accommodate AV technology and power cabling.	All movable furniture and equipment, including demountable walls. Costs should not be included in the project budget and are budgeted separately by the Judiciary in a furniture acquisition plan (FAP).	None

Table 2.2
Funding Responsibilities (cont'd)

Building Component	GSA Budget Cost	Judiciary Budget Cost	Funded By Others
Fixed Furniture	Because GSA is responsible for providing most fixed improvements in the tenant spaces, the GSA project budget should include fixed improvements that are attached to the building, such as counters, cabinets in urinalysis laboratories and testing facilities, service units, and bio-safe central mail facilities. The only chairs included as a GSA budget cost are all jury and witness chairs (including chairs affixed in grand jury hearing rooms), which are fixed improvements and typically installed with a fixed base. An allowance for one movable, height-adjustable attorney lectern and four “smart” attorney tables are included in the GSA budget. Cost above the allowance shall be funded by RWA. The GSA project budget also includes the cost of all fixed furnishings such as the judge’s bench, jury box, witness box, courtroom deputy clerk’s station, law clerk’s station, fixed public seating, railings separating public seating from the well of the courtroom, and cabinetry and fixed bookcases in the judge’s chambers.	None	None
Signage	The building signage system will be provided by GSA, except within internal spaces.	Signage (including court seals) within internal judiciary-occupied spaces	Signage within internal executive branch court-related agency spaces
Artwork	GSA administers a federal art-in-architecture program, which commissions specific artists on a building-by-building basis. The GSA project budget includes 0.5 percent of the estimated construction cost at award (ECCA) plus contingency for the federal art-in-architecture program.	None	None
Interior Plantings	Plantings are not included in the GSA budget.	Appropriated funds may not be used for live plants per the <i>Guide to Judiciary Policy</i> , Vol. 16, Ch. 4, Section 480.20(e).	Plantings should not be included without first consulting with GSA and the executive branch court-related agency.

Table 2.2
Funding Responsibilities (cont'd)

Building Component	GSA Budget Cost	Judiciary Budget Cost	Funded By Others
Security Systems	Conduits, closets, and raceways for security systems; appropriate electrical power. Cameras, consoles, conduit and wiring for prisoner holding cells, and other prisoner occupied areas, and main security console.	None	The USMS Office of Security Systems (OSS) pays for ballistic glazing where installed in courtrooms and chambers (or as required). USMS pays for all judicial security systems equipment and installation including interior security surveillance and monitoring systems, including Closed Circuit Video cameras and monitors, duress alarm devices, annunciators, and motion detection equipment; electronic security hardware, remote control devices, and communications systems; and the control wiring for each of these security components and systems in judicial spaces. This includes swipe cards on all interior judiciary spaces, including chambers and courtrooms.
Security Systems (cont'd)	At the building perimeter, egress controls such as strike releases, card readers, PIN keypads, or keys and controlling mechanisms, including lobby turnstiles and their card readers (reference GSA, AOUSC, FPS, USMS MOA). FPS monitoring equipment such as exterior video surveillance systems and intrusion detection systems, direct or remote monitoring.	None	Control and monitoring equipment within the building is paid for by the USMS.
Security Systems (cont'd)	Security door hardware (manual and electronic), raceways, conduits, power wiring, and connections to fire alarm systems for electric locks and strikes Standard, emergency, backup, and predefined electrical power needs, including battery-powered lights (as specified under GSA PBS P-100)	None None	The USMS pays for the installation of control wiring to interior electronic locks and strikes. The uninterrupted power supply required for the internal security systems is the responsibility of the USMS (not GSA PBS P-100 required).
Acoustic Planning	Physical treatments (gasketing, etc.) to meet standards	None	None

Table 2.2
Funding Responsibilities (cont'd)

Building Component	GSA Budget Cost	Judiciary Budget Cost	Funded By Others
Clock and Clock Systems	Wall outlets	Building-wide clock systems should not be specified. Movable clocks may be provided as per the <i>Guide to Judiciary Policy</i> , Volume 16, Chapter 4, Section 420.20.	Consult with the executive branch court-related agency.
Audiovisual Equipment	None, except for the design and development of infrastructure specifications for speech reinforcement systems in courtrooms. Includes provisions for microphone amplification and speaker/broadcast systems; conduits for the audio and video system; and built-in or pull-down screens in the courtrooms.	None	None
Telecommunications	<p>The basic building infrastructure for telecommunications wiring, including telephone and data distribution closets, and the vertical and horizontal distribution system (e.g., chases, under-floor ducts, cable trays, raised floors, etc.) are part of the GSA project budget.</p> <p>Conduits and ducts for court telecommunications are provided for not more than one voice and one data outlet for every 100 net square feet (NSF) (9.3 net square meters).</p>	<p>Telecommunications equipment, wiring, and service is purchased and installed separately either by GSA or by the Judiciary, and should not be included as a contract bid option in the coordinated A/E construction bid package.</p> <p>Requirements in excess of the 100 NSF (9.3 net square meters) standard are to be budgeted by the Judiciary.</p>	Telecommunications equipment and service are purchased and installed by the executive branch court-related agency.
Information Systems Equipment	The basic building infrastructure for computer cabling, including the horizontal and vertical distribution system, is provided as part of the GSA project budget.	Data systems equipment, including terminals, computer workstations, file servers, and computer cabling and connecting wiring, is the responsibility of the Judiciary and should not be included in the project budget.	Data systems equipment is purchased and installed by the executive branch court-related agency.



PLANNING FOR U.S. COURTHOUSES

This chapter addresses detailed planning concepts for U.S. courthouses. Spaces common to all courts and the functions of the three court types are discussed, along with space allocations for circulation and definitions of area accounting techniques. This chapter concludes with direction for planning the zoning of courthouses and adjacency diagrams illustrating the relationships among various court occupancies.

Chapter Topics:

- Introduction
- Supporting Documents
- Programming and Budgetary Notes
- Spaces Common to Federal Courts
- Functions of the Three Court Types
- Users and Capacities
- Access for People with Disabilities
- Courthouse Zoning and Building Circulation
- Program Stacking

Chapter Figures and Tables:

Figure 3.1	General Organizational Relationships
Figure 3.2	Typical Stacking Diagram
Figure 3.3	U.S. Court of Appeals Adjacency Relationships
Figure 3.4	U.S. District Court Adjacency Relationships
Figure 3.5	U.S. Bankruptcy Court Adjacency Relationships
Table 3.1	Metrication
Table 3.2	Circulation Multipliers

Introduction

The architecture of federal courthouses should promote respect for the tradition and purpose of the American judicial process. To this end, a courthouse facility should express solemnity, integrity, rigor, and fairness. The facility should also provide a civic presence and contribute to the architecture of the local community.

Courthouses should be planned and designed to frame, facilitate, and mediate the encounter between the citizen and the justice system. All architectural elements should be proportional and arranged hierarchically to signify orderliness. The materials employed should be consistently applied, natural and regional in origin, and durable, and should invoke a sense of permanence. Colors should complement the natural, regional materials used in the design.

A U.S. courthouse may house multiple court units, court-related offices, and other federal government agencies. Courthouses should be planned and designed to accommodate the needs of the public, judges, court staff, U.S. Marshals Service (USMS), and other court-related offices. The guidelines set forth in this chapter address the adjacency requirements for judges' and court staff offices and court-related offices (e.g., USMS, U.S. Attorney's Office), along with sizing and volume factors for common spaces in all buildings, specifically, segments of public spaces such as entrances, lobbies, atria, and corridors. The chapter includes a typical diagram and stacking plan for a multi-level courthouse and a typical court floor layout.

The criteria presented in this document *do not* represent an entitlement to space, furnishings, or finishes. However, the application of the criteria presented is intended to help direct project decisions toward producing functional, cost-effective facilities. Project teams should be conscious of the benchmark budget during the decision-making process. It is not the intent of the *Design Guide* to be overly prescriptive or to impede creative ideas to address the space and operational needs of the courts. However, the absence of a *Design Guide* standard or requirement does not imply authorization of a project without approval by the appropriate authority. Courts should work closely with their respective assistant circuit executives (ACEs) for space and facilities, the General Services Administration (GSA), and their architectural/engineering (A/E) team to identify areas of concern and develop cost-efficient and effective solutions. The goal of the *Design Guide* is to provide guidance for new construction and renovations that addresses the needs of the Judiciary.

Supporting Documents

A comprehensive guide to supporting documents should be found in Chapter 2, "Courthouse Programming and Budgetary Considerations." That listing includes program and design criteria, courthouse planning and related guidelines, policies, and information

on many facets of the design and construction of federal courthouses. The references listed below relate specifically to this chapter.

- "AnyCourt" (*Program of Requirements*), the Judiciary's automated space-planning tool used to provide a court's space program of requirements
- [Architectural Barriers Act Accessibility Standard \(ABAAS\)](#)
- [Courtroom Technology Audiovisual Infrastructure Standard](#)
- [Design Notebook for Federal Building Lobby Security](#)
- [Facilities Standards for the Public Buildings Service \(GSA PBS P-100\)](#), most current edition
- [National Business Space Assignment Policy \(NBSAP\)](#), GSA, most current edition
- [Requirements and Specifications for Special Purpose and Support Space Manual, Volume Three, Judicial Security Systems Requirements and Specifications \(USMS Publication 64\)](#), most current edition
- [United States Courts, Courthouse Design Reference Manual: An Architect's Desk Reference](#), most current edition, all chapters

Programming and Budgetary Notes

Programming and budgetary notes found throughout the *Design Guide* provide assistance with decisions to be made during the development of courthouse projects. The notes include both judicial branch policy and lessons learned from completed projects. The notes supplement the criteria in the *Design Guide*; their purpose is to provide direction in using the flexibility of the *Design Guide* to develop justifiable and cost-effective federal courthouse projects.

Space Envelope Flexibility

A total space envelope for new space will be calculated using appropriate circulation factors, allowances for support-type spaces, and the space standards described in the *Design Guide*. Courts have the flexibility to configure space within the envelope to meet their local needs. However, design and construction should be in general compliance with the square footage standards designated in the *Design Guide* in the space and ceiling requirements tables. If the court unit wishes to significantly change the space standards described in the space and ceiling requirements tables without exceeding the total envelope of space for the unit, it must seek approval from its respective circuit judicial council.

The space envelope for a respective court unit is defined as:

- Entire clerk's office
- Entire probation office
- Entire pretrial services office
- Entire staff attorney's office
- Entire circuit executive's office

- All courtrooms designated by judge type (circuit judges, district judges, magistrate judges, and bankruptcy judges)
- All chambers designated by judge type (circuit judges, district judges, magistrate judges, and bankruptcy judges)

For existing space, courts have the flexibility to configure space within the existing envelope to meet their local needs. However, any significant departure from the square footage standards designated in the *Design Guide* in the space and ceiling requirements tables must be approved by the respective circuit judicial council. This does not mean that existing space is required to be changed to meet *Design Guide* standards. Only new construction completed as part of a renovation should be considered.

Renovations and Alterations (R&A)

Many of the construction projects conducted in the Judiciary are renovations to existing space. Although the *Design Guide* applies to these projects, it is understood that some standards in the *Design Guide* are difficult or impossible to achieve in existing space, particularly in historic buildings. Courts should consult [Chapter 17, “Renovations and Alterations \(R&A\),”](#) and [GSA PBS P-100](#) for guidance in these circumstances. References to R&A guidelines are also included throughout the *Design Guide* where appropriate.

Exceptions to the *Design Guide* Standards

The *Design Guide* provides guidance on standards for courthouse construction and renovations to existing space. Any significant departure from these standards is considered an exception and must be approved by the respective authority as outlined below.

Authority of the Circuit Judicial Councils

Circuit judicial councils play an important space-management role by reviewing district-wide facility plans, approving requests for new or modified space, and enforcing adherence to design guidelines. The circuit judicial councils have authority over, and responsibility for, a circuit’s space-management program (28 USC §332 and §462(b)) and for determining the need for space. As directed by the Judicial Conference of the United States (JCUS), any significant departure from the standards in the *Design Guide* must be approved by the respective circuit judicial council.

Authority of the Committee on Space and Facilities

The authority to approve the following exceptions to the *Design Guide* standards rests with the Committee on Space and Facilities: (1) exceeding the total envelope for either the court unit or the project as a whole, (2) changing the standard configurations for judges’ chambers and courtrooms, and (3) exceeding the plumbing standards. If the Committee on Space and Facilities disagrees with a circuit judicial council request for one of these exceptions, the Judicial Conference will decide whether to grant the exception.

Authority of the Judicial Conference

The authority for approving any exception to prospectus-level courthouse projects that would result in additional estimated costs, including additional rent payment obligations, lies with the Judicial Conference. Approval is required, after review by the Committee on Space and Facilities, for any exception to the *Design Guide* approved by a circuit judicial council. The request must include (1) a justification for the exception and (2) a construction cost estimate. [All approved exceptions for prospectus-level projects](#) are reported to the GSA and Congress. Approved exceptions may require the project to be reauthorized by Congress if the exception had not been previously identified. Contact the Administrative Office of the U.S. Courts (AOUSC) for more detailed information.

For prospectus-level courthouse projects, if an exception is approved by the JCUS which would result in additional estimated costs, the chair of the circuit’s space and facilities committee or the chief judge or other judge designated by the court that sought the exception that exceeds the *Design Guide* criteria must be willing, if requested by the Committee on Space and Facilities, to appear before Congress concerning funding for such construction.

General Programming Notes

The *Design Guide* is intended to be a performance document. Criteria for any space or grouping of spaces should be considered in conjunction with the specific needs of the court office or function for which space is being designed.

Criteria in the *Design Guide* do not represent space entitlements. The criteria apply to an array of space types that should be justified based on the specific purpose of each project. Facility plans, programs, and designs should include only the space needed to satisfy the functional and security requirements of the court.

Differences between the space in an existing facility and the criteria in the *Design Guide* are not justification for facility alteration and expansion. In such cases, alternatives to space expansion are investigated before any additional space is requested. In addition, like-for-like space is not a guarantee. Space allocated in an existing location is not justification for the same amount of space in a new location if the space allocation is not warranted. Current needs should be evaluated when moving into new space to determine the appropriate space envelope. Any additional space must be approved by the appropriate authority. Design architects and court staff are prohibited from adding spaces not originally contemplated in the approved prospectus or design program. Increasing the floor area or building volume requires the necessary approvals.

General Budgetary Notes

Renovation and new construction occur when the court and circuit judicial council identify space needs through the Judiciary’s asset management planning process and document

these needs in the long-range facilities plan. GSA determines by what method the space is provided—for example, by the construction of a new building, the renovation of an existing building, a lease, or other means.

The Judicial Conference recognizes and strongly supports a pragmatic approach to design that includes the use of durable and sustainable materials. This approach ensures that courthouses constructed now will last well into the future.

Following the publication of the *2007 Design Guide*, the Judiciary introduced several cost-saving measures, such as courtroom sharing and the Integrated Workplace Initiative (IWI), that sought to provide flexibility and efficiency in court spaces while preserving the dignity of the Judiciary. Courtroom sharing for certain judge types is now a standard throughout the Judiciary, and IWI is recognized as an alternative to traditional office design. For more information on cost- and space-saving efforts and programs, contact the AOUSC Space and Facilities Division.

Spaces Common to Federal Courts

Federal courthouses contain several common elements, including public spaces and atria, secure parking, service areas, heavy traffic areas, clerk’s offices, judges’ chambers, and court libraries.

Public Spaces and Atria

The public space should be designed as an integrated continuum of spaces that leads from the building’s main entrance to the various public destinations within it. Each segment of space along the continuum performs multiple functions and should be designed accordingly. The functions include ingress/egress, admittance/discharge, security screening, provision of information/orientation, circulation/conveyance, and accommodation/queuing/waiting/seating.

Entrance

The entrance or entrance vestibule should be clearly visible and recognizable as such from the exterior of the building. The vestibule should be a minimum of 7 feet in depth and able to handle the flow of traffic at peak times.

Security Screening Station

The security screening station should be designed with a non-secure zone in front of the screening equipment (i.e., metal detectors and X-ray machine). The non-secure zone should be large enough to provide safe and comfortable queuing during peak load periods. The design team should include a representative from the USMS to ensure that the requirements for the screening equipment are provided in accordance with USMS Publication 64. The screening stations, security equipment, and associated gun locker

should be integrated with the design of the surrounding architecture. In addition, special consideration should be given to the design of the mechanical system to ensure adequate heating, cooling, and ventilation at the screening station.

Lobby

The building lobby is the main occupant and public gathering point on the secure side of the security screening station. The size and shape of the lobby should facilitate the process of understanding the layout of the building. The amount of floor area required for the lobby space will be determined by the number of people who pass through it, as well as by the ways that other segments of the public space are developed.

Atrium

If the design of the public space includes an atrium, there should be no more than one in the building. If an atrium is provided as a substitute for a lobby, it should otherwise be designed to perform all the functions normally performed by the lobby.

As a volume that connects two or more floors, the atrium’s proportional relationships of height to floor area should conform to familiar ratios and responsible budgeting. The relationship of the atrium volume to a source of natural light at its top, side(s), or base is also critical.

Corridors

Corridors convey, orient, and provide places for people to confer and, often, to wait. Corridor lengths and widths vary according to the volume of traffic and the nature of the spaces to which they lead. Basic corridor widths should enable a minimum of four people to pass abreast of each other (one person escorted by two others and a fourth passing from the opposite direction).

Corridors may be developed uniformly throughout the building, that is, with standardized dimensions and layout from floor to floor. More typically, however, the public corridor layout will vary between the ground level and the floors above, and it may also vary on a single floor—for example, from one wing of a building to another. Some portions of the corridor system may be developed on a double-loaded basis, while others are single loaded.

When the corridor is on a courtroom floor, an additional 400 net square feet (NSF) (37.2 net square meters) for appellate, district, and bankruptcy courtrooms should be provided for the public waiting area outside each courtroom. The space for waiting should not obstruct the adjacent space for circulation. Single-loaded corridors on court floors may be able to accommodate the required waiting area(s) more easily. Double-loaded corridors on court floors where entrances to the courtrooms are opposite each other may involve an added design challenge to provide sufficient waiting space.

All public corridors should be straight, not unduly long, and comfortably proportioned; all should have access to daylight and views.

Court Staff Entry

Other spaces common to all courts include the court staff entry. Staff entry should be through the central public screening point. If the Facility Security Committee and/or the Court Security Committee approves a separate staff entrance, the entrance shall be manned by a court security officer and be provided with the required screening equipment. Circulation for judges and others requiring additional security should not intersect public circulation; these individuals should enter through a restricted lobby from secure parking.

Secure Parking

Parking for judges and the USMS should be secure and located within the court building. Refer to [Chapter 16, “Building Security”](#), for details of judges’ and staff parking.

Service Areas

A building service area requires loading docks with direct restricted entry. In smaller courthouses where a loading dock is not required, the receiving area should have direct restricted entry. The building service area requires access via freight elevator to all building offices.

Heavy Traffic Areas

All areas generating heavy traffic, such as the clerk’s office and building services, should be located on or adjacent to the main public entry level.

Clerk’s Offices

The clerk’s offices of the three courts should have quick and convenient restricted access to and from each courtroom and chambers. Additionally, district clerk’s office staff should have convenient restricted access to and from the jury assembly area.

Judges’ Chambers

Judges’ chambers may be located close to a courtroom or clustered in a separate area. Chambers are accessed from restricted circulation with convenient access to the courtroom(s). Refer to [Chapter 6, “Judges’ Chambers Suites,”](#) for a discussion of functions within the judges’ chambers suites.

Court Libraries

The location of central court libraries should provide access for judges, law clerks, and other court staff by means of a restricted staff corridor. Public access may also be required, as determined by the court. Refer to [Chapter 7, “Central Court Libraries,”](#) for a discussion of functions within the central court libraries.

Probation Offices

The probation office requires access from public circulation after the security screening area in the lobby. If the office operates during off-hours, a separate controlled off-hours access point is desirable.

Pretrial Services Office

The pretrial services office also requires access from public circulation after the security screening area at the main courthouse entrance. In addition, the office requires restricted access to the USMS and magistrate judges’ courtrooms.

Functions of Three Court Types

Major Spaces in Three Federal Court Types

The following is a discussion of the major spaces, groupings, and circulation systems in each of the three most common federal courts. Special courts (Court of Appeals for the Federal Circuit, Court of Federal Claims, and Court of International Trade) have not been included due to their limited number.

U.S. Court of Appeals (USCA)

Since the USCA does not conduct trials, unlike the district court, it requires only two circulation systems: public and restricted. For an overview of the USCA’s circulation and adjacency patterns, refer to [Figure 3.3](#).

The major functional spaces in the USCA are the appellate courtrooms, circuit judges’ robing rooms, and circuit judges’ chambers suites. For court proceedings, the judges move from their chambers to the judges’ conference room, then through the robing room to the courtroom.

The circuit executive’s office should have restricted access to judges’ chambers and the USCA clerk’s office. Since the circuit executive’s office often has little contact with the public, the level of public access should be coordinated with each circuit executive.

The office of the senior staff attorney should be located off a restricted corridor, adjacent to both the USCA clerk’s office and the central court library, and with easy access to judges’ chambers, if possible.

U.S. District Court (USDC)

The USDC conducts jury trials for both civil and criminal cases and other court proceedings. The court requires public, restricted, and secure circulation patterns. For an overview of the USDC’s circulation and adjacency patterns, refer to [Figure 3.4](#).

The activities of the USDC focus on the courtroom. The district and magistrate judge courtrooms require direct access from public, restricted, and secure circulation. Associated spaces located near the district courtroom include attorney/witness conference rooms, accessed from public circulation; the judges' conference/robing room (provided only if the judges' chambers are not located close to the courtroom), accessed from restricted circulation; the trial jury suite, accessed directly from the courtroom or restricted circulation; and prisoner holding cells, accessed from secure circulation.

Jury assembly facilities should be located on the main public entry floor, preferably close to the district court clerk's office. The facilities should have controlled entry and should provide for the convenient movement of jurors to and from courtrooms.

The grand jury suite should be located near the Office of the U.S. Attorney, as that office is responsible for presenting evidence to and obtaining indictments from the grand jury. Grand jurors enter the suite through restricted circulation from a controlled area or an area that is remote from public view. In-custody witnesses enter the suite from secure circulation.

Federal public defenders' staffed offices should be located outside the courthouse unless the federal public defender determines that being in such buildings would compromise the organization's mission. If the Judicial Conference Committee on Defender Services approves the request by a federal public defender to occupy space in a new courthouse, the comparable office space standards for other court units shall apply. The office should be distanced from the offices of the U.S. attorney. A trial preparation suite of 450 usable square feet (41.9 usable square meters), which includes internal circulation for use by federal public defenders during trials, shall be provided in the USDC courthouse. Refer to [Chapter 10, "Other Court Units,"](#) for additional requirements regarding the Office of the Federal Public Defender's trial preparation suite.

U.S. Bankruptcy Court (USBC)

The USBC hears only civil cases. Like the USCA, the USBC needs only two circulation systems: public and restricted. In some locations, jury trials may be held by bankruptcy courts. When this occurs, the USBC should use a vacant USDC courtroom. For an overview of the USBC's circulation and adjacency patterns, refer to [Figure 3.5](#).

USBC courtrooms are accessed by public and restricted circulation. Similar to those near USDC courtrooms, associated spaces located near the bankruptcy courtroom include attorney/witness rooms, accessed from public circulation, and the judges' conference/robing room (provided only if the judges' chambers are not located close to the courtroom), accessed from restricted circulation.

Users and Capacities

Users vary according to the size of the courthouse, the type and volume of cases, and the number of maintenance staff, service company/agency personnel, and the public. For the purposes of certain references in this *Design Guide*, the following designations apply:

A small courthouse has five or fewer courtrooms.

A medium courthouse has 6-12 courtrooms.

A large courthouse has 13-18 courtrooms.

An extra-large courthouse has more than 18 courtrooms.

Access for People with Disabilities

The federal courts are required to conform to the standard of the Architectural Barriers Act (ABA) of 1968 for new construction and renovation of existing facilities. ABAAS is the GSA accessibility standard. It replaces the previous UFAS requirements for accessibility. The standard is based on the [ABA accessibility guidelines](#) published by the U.S. Access Board on July 23, 2004. In addition, GSA policy requires compliance with the local accessibility standards if they are more stringent (refer to [GSA PBS P-100](#)).

Public areas in federal court facilities, including jury facilities, as well as restricted and secure areas, shall be made accessible when newly constructed or renovated. Under ABAAS, an "accessible" facility shall be usable by persons with disabilities. This includes not only those with mobility limitations, but also persons with sight, speech, or hearing disabilities. Per ABAAS and the International Building Code, employee work stations (judge's bench, clerk's station, bailiff's station, deputy clerk's station, and court reporter's station) shall be located on an accessible route. The vertical access to elevated employee work stations within a courtroom is not required at the initial time of construction, provided a ramp or lift may be installed without requiring significant reconfiguration or extension of the courtroom or extension of the electrical system. Other publicly accessible areas such as the litigant and counsel stations, witness station, jury box, lectern, and public seating shall be accessible at the initial start of court operation.

Accessibility within the courtroom shall be achieved with minimum use of well space and the accessible path to all stations within the courtroom shall be facilitated in a dignified manner. The design team shall consider the court's requirements for the height of the judge's bench and other elevated work stations when determining the use of ramps and/or lifts to facilitate accessibility. There are many acceptable courtroom configurations including the use of ramps within the restricted staff corridor to achieve an accessible path to elevated work stations. Coordinate with the AOUSC for additional sample courtroom layouts.

In addition to facility design and courtroom layouts, other technology and devices may be employed to assist persons with disabilities in navigating the courthouse. It is important to have a court plan for accessibility assistance and it is recommended to provide information on this plan at building entry lobbies and public information areas.

People who are deaf or hard of hearing shall be accommodated. Assisted listening systems (ALSs) shall be provided in accordance with ABAAS. Accommodations beyond the requirements of the ABAAS will likely be necessary. In some cases, a sound-reinforcement system may be sufficient; in others, a sign language interpreter is necessary for proceedings involving participants with hearing disabilities. Courtroom layouts shall accommodate the sign language interpreter within the reader's field of vision and also provide the reader with a view of the speaker. This allows the participants to observe the speaker's gestures, facial expressions, and other visual cues.

Provisions for sight-impaired persons shall be accommodated. Accommodations may include utilizing contrasting finishes, spatial cues for navigating, and appropriate use of signage and wayfinding devices. Coordinate infrastructure with wayfinding devices for disabled persons.

Newly constructed courthouse facilities, including all courtrooms, shall comply with the ABAAS. For existing courtrooms that pre-date the ABAAS, renovations and alterations will also need to comply unless it is not technically feasible to do so. Additionally, some alterations will not address all courtrooms in a facility. If all courtrooms cannot be designed to be fully accessible at the initial start of court operation, a minimum of one courtroom per court type and per court floor shall be made fully accessible at the initial start of court operation. Additional sample courtroom layouts and best practice information may be obtained from the Space and Facilities Division of the AOUSC.

Courthouse Zoning and Building Circulation

Courthouses are unique buildings that require special circulation provisions. Courthouses are typically organized into five distinct zones that collocate areas of similar activity, operational need, and access requirements.

Public

The public circulation zone provides access from main building entrances to the functional areas of the building. This zone includes all areas of the building used by the general public, attorneys, clients, witnesses, and jurors. It includes but is not limited to such areas as the main lobby, corridors accessing departmental spaces that interface with the public, public elevators and escalators, public restrooms, court library, pro se areas, waiting areas, snack bars, clerk of court counters, and reception areas. Any member of the community with business in the courthouse would utilize the public circulation zone.

Figure 3.1
General Organizational Relationships

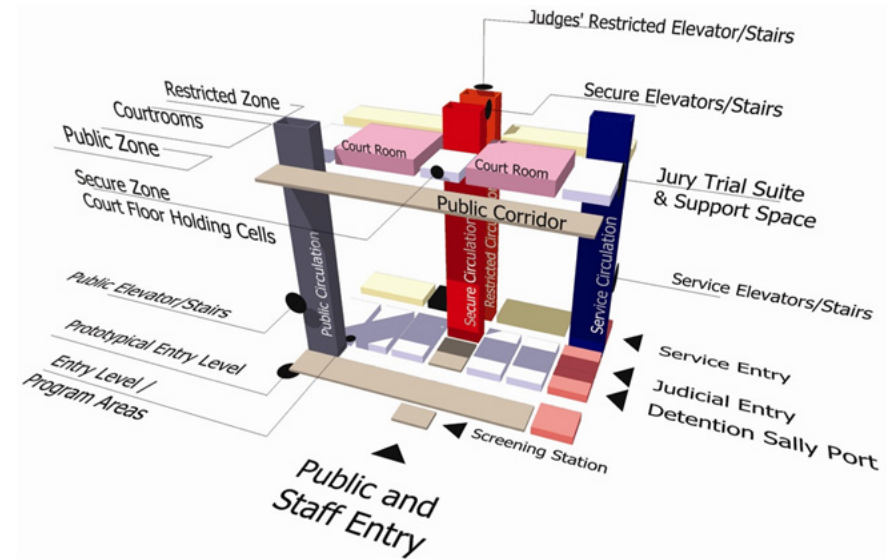

Restricted

The restricted circulation zone provides controlled access to particular courthouse users. Restricted circulation is not typically used by the general public or legal community unless they are escorted by approved court personnel. The restricted circulation zone is intended to safely facilitate the movement of judges and other approved court personnel between chambers, courtrooms, and sometimes departmental areas. It may also be used to facilitate the movement of jurors between courtrooms and jury deliberation rooms. This prevents jurors from interacting with witnesses or the general public during proceedings. Restricted circulation typically connects court and chambers areas to secure or restricted parking facilities and includes dedicated restricted elevators.

Secure

The secure circulation zone provides for the movement of defendants in custody. Access to this building zone is through a secure vehicular or pedestrian sally port. Defendants in custody may be taken to a secure central holding area and then escorted to courtrooms as needed. Circulation from the central holding area to the individual courtrooms is accommodated using dedicated, secure elevators to holding areas located adjacent to the courtrooms. The USMS maintains control of the secure circulation zone.

Interface

In a modern court facility, the only time public, restricted, and secure circulation zones interface is within the courtroom or hearing room.

Service

The service zone includes all the spaces that serve as support areas for the courthouse, including but not limited to loading docks, recycling areas, storage areas, building systems spaces, and building maintenance areas.

Establishing a clear circulation and zoning approach is key to developing an efficient courthouse plan. In addition to court units, courthouses may also house other federal government agencies. The team should review and optimize adjacencies between the courts and other government agencies to be located in the building and clearly define parameters for interface in the circulation zones. [Figure 3.1](#) is a typical diagram of a multilevel courthouse.

Space Allocation for Circulation in Courthouses

Several references have been made to the functional and physical uniqueness of courthouses. One distinguishing feature of courthouse planning is the amount of space required to accommodate the various circulation zones. Courthouses are not typically as efficient as typical office buildings. If circulation and efficiency factors are not clearly understood during the programming, planning, and early design process, total building areas may be miscalculated and funding may not be adequate.

Space Measurement Standards

This section defines terms used in the planning and measurement of space for court buildings. Space criteria in the *Design Guide* are presented in terms of net square feet (NSF) and net square meters (Nm²). It is important to note that NSF (Nm²), as used in the *Design Guide*, is not synonymous with ANSI/BOMA's definition of usable space.

Net Square Footage (NSF)

NSF identifies the area of individual room or space, such as an office, workstation, storage space, or conference room, measured from the inside face of the wall to inside face of wall or from area boundary line to area boundary line. Wall thicknesses, vertical slab penetrations, and circulation space are not included in the NSF of a space. Likewise, the NSF of a workstation in an open office does not include circulation space around it.

Circulation Area

Circulation space includes corridors, aisles, and other similar spaces required for occupants to access means of egress and all other functions in and serving their space. Circulation may be fully enclosed, as in a corridor, or unenclosed, as in an aisle between workstations in an open office configuration.

There are two types of circulation areas: primary and secondary. Primary circulation is the main travel path connecting the building core, various court units, and common spaces, such as elevators and stairs. Secondary circulation connects offices, workstations, and support spaces.

Circulation Multipliers

Circulation multipliers are used to convert the total NSF of a court unit to usable square feet. Each multiplier accounts for the wall thicknesses and circulation required between spaces. Each multiplier is dictated by different design parameters and varies per function within the building.

It should be noted that the circulation multiplier for a specific court unit applies to all spaces within the court unit. For instance, the courtroom multiplier applies to all associated courtroom spaces as well as the courtrooms.

Usable Square Footage (USF)

USF is the area within a building that should be assigned to a specific tenant. The USF of a single organization is the footprint of that organization on the floor plan of the building. USF excludes building infrastructure spaces such as mechanical rooms, building common area, circulation, and public toilets but does include columns and other structural elements located within a court unit's space. In addition, the total USF of a court unit includes any joint use spaces.

The total envelope of space for a given court unit is the total usable square feet. A court unit has the discretion to reconfigure this total envelope.

GSA utilizes the [NBSAP](#) to assign, classify, and measure space in federally-owned buildings. ANSI/BOMA standards serve as the foundation of the NBSAP; however, there are some specific differences between the two. The purpose of the NBSAP is to account for and assign space after a building has been constructed. Although the following terms do not apply to the planning or programming of court space, they should be understood:

Rentable Area

Rentable area is used to determine how much rent a tenant will pay. At a tenant level, rentable area is the amount of USF a tenant should occupy or use within a building plus their respective share of common areas, such as a lobby and joint use spaces.

Gross Area

The Gross area is the total constructed area of a building measured to the outside of the exterior enclosing walls. Gross area may include partially enclosed areas, but it does not include voids.

Metrication

The Metric Conversion Act of 1975, as amended by the Omnibus Trade Act of 1988, establishes the modern metric system (International System of Units) as the preferred system of measurement in the United States. To facilitate the transition to the metric system, English units in the text are followed by metric equivalents in parentheses. Metric units have been rounded to simplify their use in design and construction. [Table 3.1](#) lists the equivalent types of English and metric units used in the *Design Guide*.

Circulation Requirements in Court Space

The net areas specified in the subsequent chapters of the *Design Guide* are exclusive of the area required to accommodate circulation among spaces. The circulation requirements for court space vary based on function, but are also influenced by other factors, such as site limitations and building configuration. The *Design Guide* provides specific values to estimate circulation space requirements for various offices and functional areas of a courthouse. Refer to [Table 3.2, Circulation Multipliers](#), for approved multipliers per court unit or space type.

NSF serves as the base unit or space standard for each space in a courthouse. Space standards for specific spaces should be found within the space tables in the following chapters. For these spaces to appropriately function, the NSF of each space is multiplied by the stipulated circulation multiplier. The product is the USF of a court unit inclusive of wall thickness and internal court unit circulation space. AnyCourt utilizes this formula to determine the total USF for judiciary space listed in the program. This AnyCourt USF is utilized in determining the project budget.

Courtrooms and Associated Spaces

The courtroom is programmed with no internal additional circulation space. Circulation space is required, however, to connect the courtroom to other support functions, such as the Judge’s Conference Room or Attorney Work Room. The spaces associated with courtrooms are listed in [Chapter 4](#), and every space listed in this chapter should utilize the same circulation multiplier.

Jury Facilities (Jury Assembly, Trial Jury Suites, and Grand Jury Suites)

Jury Facility spaces are listed in [Chapter 5](#), and vary in terms of function. The jury assembly suite gives potential jurors a place to receive orientation, gather, and wait to be called to a courtroom for jury selection. The trial jury suite gives juries a space to deliberate at the conclusion of a trial. Grand jury suites are utilized to present evidence and witnesses before grand jurors. Because these spaces function differently, each utilizes a different circulation multiplier.

Judges’ Chambers Suites

The spaces that comprise a judge’s chambers suite are listed in [Chapter 6](#). Circulation space is required to connect the various offices and functions required within a

Table 3.1
Metrication

Measurement Category	English Unit	Metric Unit
Area	Square Foot (SF)	Square Meter (m ²)
Length	Foot (ft), Inch (in)	Millimeter (mm)
Thickness	Gauge (ga)	Millimeter (mm)
Weight/Mass	Ounce (oz)	Kilogram (kg)
Load	Pounds per Square Foot (PSF)	Pascals (Pa)
Volume	Gallon (gal)	Liter (L)
Temperature	Degrees Fahrenheit (°F)	Degrees Celsius (°C)
Air Flow	Cubic Feet per Minute (CFM)	Liters per Second (L/S)
Illuminance	Foot-Candles (FC)	Lux (lx)

chambers suite. Each space listed in [Chapter 6](#) should utilize the same circulation multiplier.

Court Libraries

Court library spaces are listed in [Chapter 7](#). Although many of the library spaces are large, open spaces, circulation is still required to connect the office and support spaces. Court libraries and their associated spaces listed in [Chapter 7](#) should utilize the same circulation multiplier.

Clerk’s Office, Probation and Pretrial Services Office, and Other Court Units

Although the clerk’s office, probation and pretrial services offices, and other unlisted court units function differently, they are all generally composed of closed offices, open workstations, conferencing amenities, and other support spaces. Circulation space is required to connect office spaces with one another and their respective support functions. These court units should utilize the same circulation multiplier, unless alternate workplace strategies (AWS) are implemented.

These court units have the greatest potential to utilize space-saving strategies listed in [Chapter 18, “Alternative Workplace Strategies.”](#) Because open-office floor plans

require greater circulation space than closed office spaces, these court units will be required to utilize a larger circulation multiplier to accurately estimate the needed amount of circulation area.

Judicial Shared Support Spaces

Judicial common building spaces are listed in [Chapter 11](#), and include technology spaces, such as telecommunications closets, and other functions, such as fitness centers.

Program Stacking

The plan for a courthouse should locate all public traffic functions on the lower floors and provide dedicated elevator and stairway systems for the public, court staff, judges, freight, and prisoner movement. Refer to [Figure 3.2](#).

Table 3.2
Circulation Multipliers

Space Type	Circulation Multiplier
Courtrooms and Associated Spaces	1.35
Jury Assembly	1.15
Trial Jury Suites	1.20
Grand Jury Suites	1.35
Judges’ Chambers Suites	1.20
Court Libraries	1.32
Clerk’s Office ¹	1.32
Probation and Pretrial Services Offices ¹	1.32
Other Court Units ¹	1.32
Judicial Shared Support Spaces	1.25

¹ Court units that implement alternate workplace strategies (AWS) shall utilize a circulation multiplier of 1.4. Refer to [Chapter 18](#), “Alternative Workplace Strategies.”

Figure 3.2
Typical Stacking Diagram

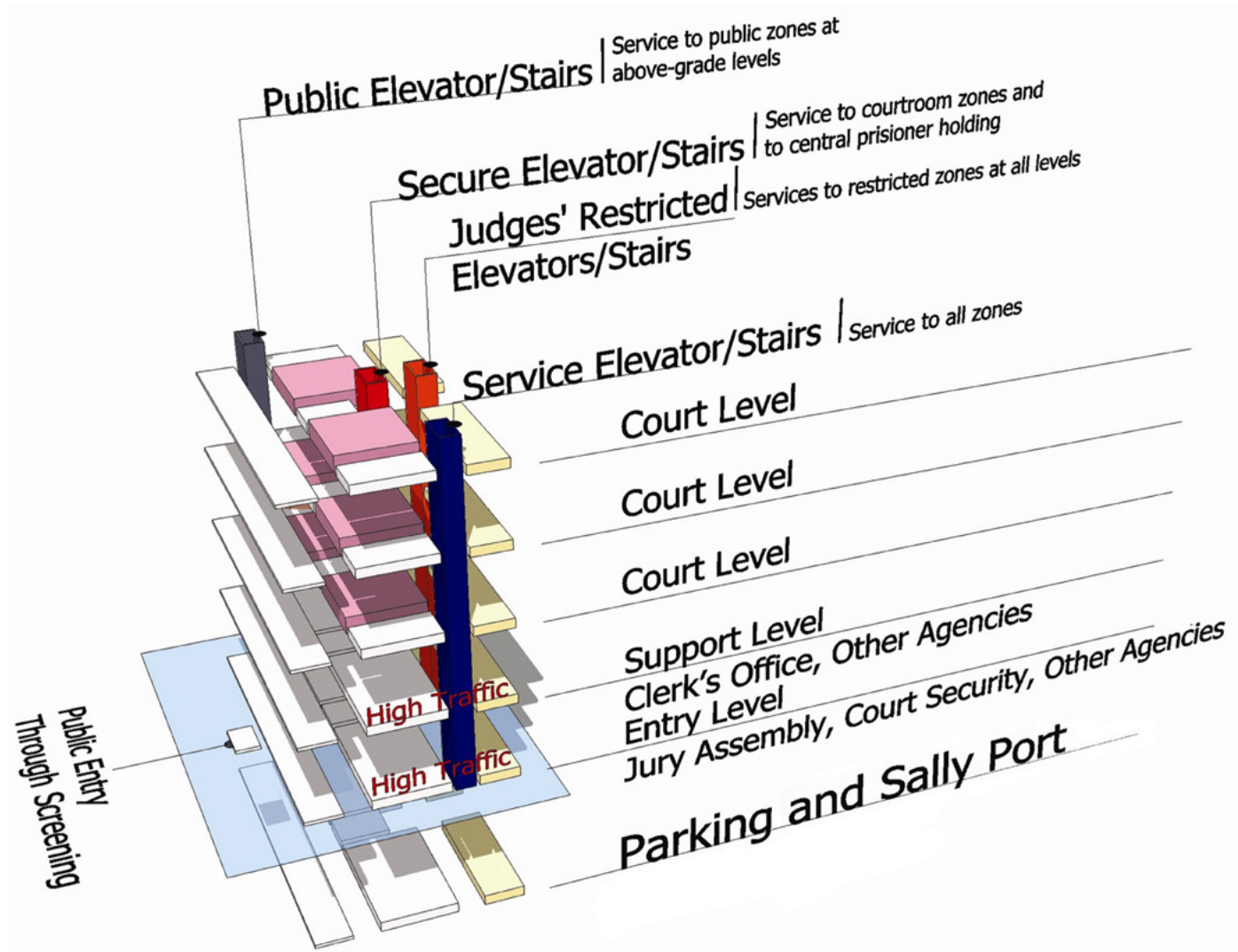

Figure 3.3
U.S. Court of Appeals Adjacency Relationships

Colors Legend:

- Chapter 3**
Planning for U.S. Courthouses
- Chapter 4**
Courtrooms and Associated Spaces
- Chapter 6**
Judges' Chambers Suites
- Chapter 7**
Central Courts Libraries
- Chapter 8**
Clerk's Office
- Chapter 10**
Other Court Units

Symbols Legend:

- Public Circulation
- Public Vertical Circulation
- Restricted Circulation
- Restricted Vertical Circulation
- Circulation Access Control Point

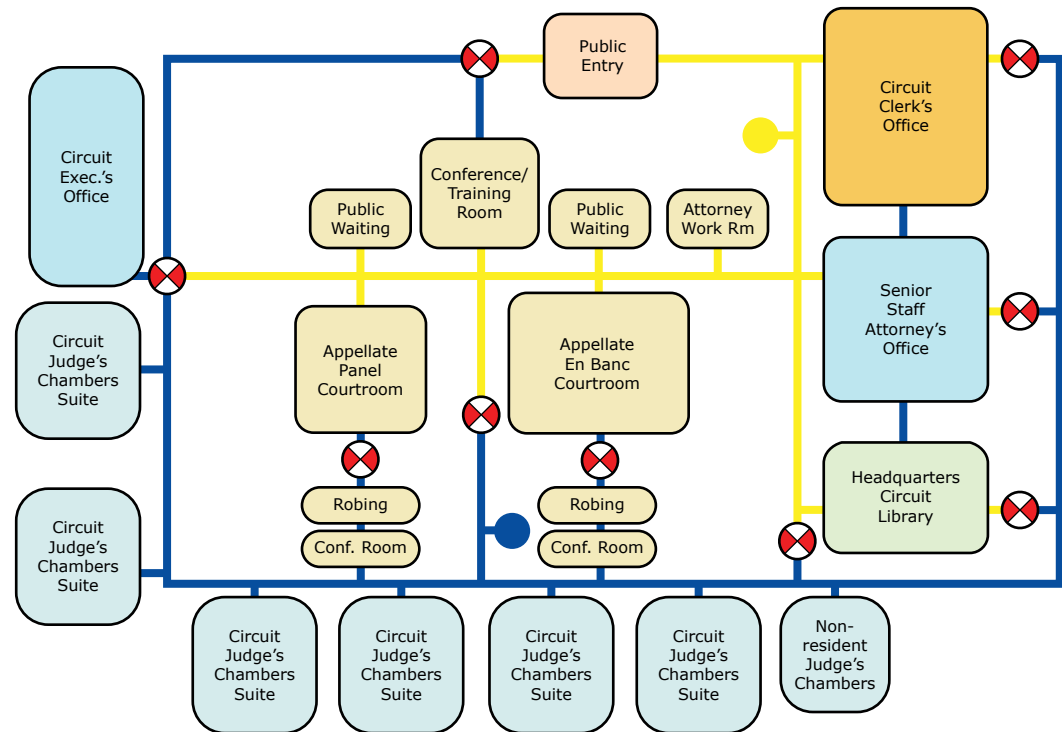

Note: The adjacency diagram is intended only as an illustration.

Figure 3.4
U.S. District Court Adjacency Relationships

Colors Legend:

- Chapter 3**
Planning for U.S. Courthouses
- Chapter 4**
Courtrooms and Associated Spaces
- Chapter 5**
Jury Facilities
- Chapter 6**
Judges' Chambers Suites
- Chapter 7**
Central Courts Libraries
- Chapter 8**
Clerk's Office
- Chapter 9**
Probation and Pretrial Services Offices
- Chapter 10**
Other Court Units

Symbols Legend:

- Public Circulation
- Public Vertical Circulation
- Restricted Circulation
- Restricted Vertical Circulation
- Secure Circulation
- Secure Vertical Circulation
- Service Vertical Circulation
- Circulation Access Control Point

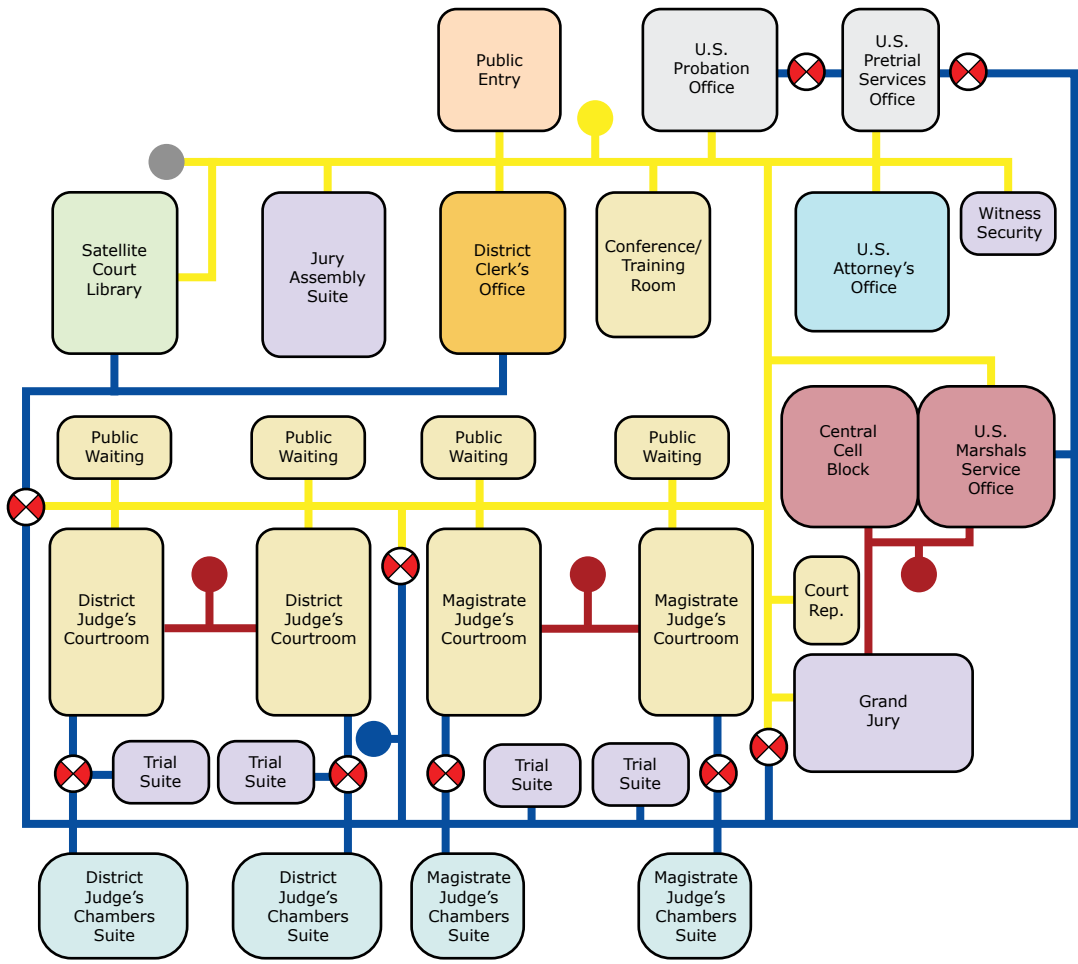

Note: The adjacency diagram is intended only as an illustration.

Figure 3.5
U.S. Bankruptcy Court Adjacency Relationships

Colors Legend:

- Chapter 3**
Planning for U.S. Courthouses
- Chapter 4**
Courtrooms and Associated Spaces
- Chapter 6**
Judges' Chambers Suites
- Chapter 7**
Central Courts Libraries
- Chapter 8**
Clerk's Office

Symbols Legend:

- Public Circulation
- Public Vertical Circulation
- Restricted Circulation
- Restricted Vertical Circulation
- Service Vertical Circulation
- ⊗ Circulation Access Control Point

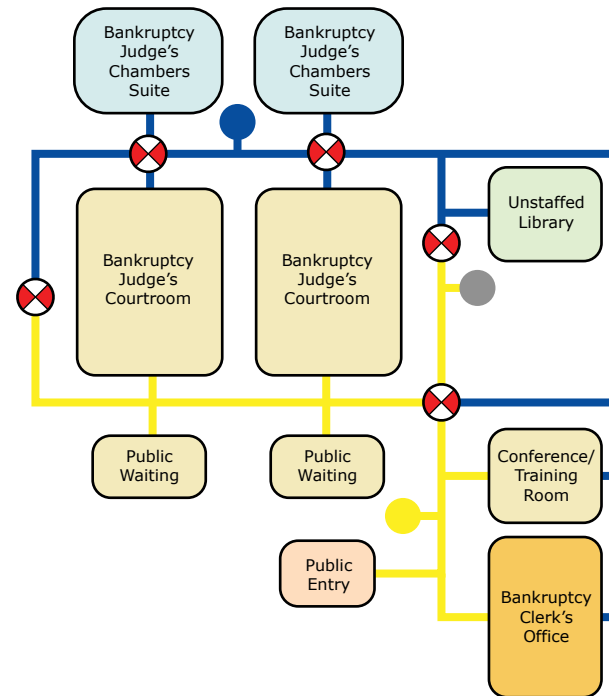

Note: The adjacency diagram is intended only as an illustration.



COURTROOMS AND ASSOCIATED SPACES

This chapter applies to courtrooms and associated spaces for circuit, district, magistrate, and bankruptcy judges. It provides descriptions of functions and activities, users and capacities, design requirements, and space allocation requirements, and includes adjacency diagrams for courtrooms and associated spaces.

Chapter Topics:

- Introduction
- Supporting Documents
- Programming and Budgetary Notes
- General Requirements for All Courtrooms
- Appellate Courtrooms
- District Judge Courtrooms
- Magistrate Judge Courtrooms
- Bankruptcy Judge Courtrooms

Chapter Figures and Tables:

Figure 4.1	Fully Accessible Courtroom
Figure 4.2	Appellate (Panel or En Banc Courtrooms) Adjacency Relationships
Figure 4.3	U.S. District Court Adjacency Diagram
Figure 4.4	U.S. Magistrate Court Adjacency Relationships
Figure 4.5	U.S. Bankruptcy Court Adjacency Relationships
Table 4.1	Ceiling Requirements for Courtrooms and Associated Spaces
Table 4.2	Space Requirements for Appellate Courtrooms and Associated Spaces
Table 4.3	Space Requirements for District Judge Courtrooms and Associated Spaces
Table 4.4	Space Requirements for Magistrate Judge Courtrooms and Associated Spaces
Table 4.5	Space Requirements for Bankruptcy Judge Courtrooms and Associated Spaces

Introduction

The size and design of each type of federal courtroom varies according to the functions and activities that the courtroom should accommodate. These functions are largely determined by the types of cases that the court hears, such as appeals, civil, criminal, or bankruptcy cases.

While the U.S. Court of Appeals (USCA) hears only appeals cases and the U.S. Bankruptcy Court (USBC) handles only bankruptcy cases, both civil and criminal cases are heard by U.S. District Court (USDC) judges. Magistrate judges, who are appointed by each district court, may also handle certain types of civil and criminal cases. The major functions of each courtroom type—appellate courtrooms, district judge courtrooms, magistrate judge courtrooms, and bankruptcy judge courtrooms—are described in the following sections.

Supporting Documents

A comprehensive guide to supplementary publications can be found in [Chapter 2, “Courthouse Programming and Budgetary Considerations.”](#) That listing includes program and design criteria, courthouse planning and related guidelines, policies, and information on many facets of federal courthouse design and construction. The references listed below relate specifically to this chapter.

- [Architectural Barriers Act Accessibility Standard \(ABAAS\)](#)
- [Facilities Standards for the Public Buildings Service \(GSA PBS P100\)](#)
- [Courtroom Technology Audiovisual Infrastructure Standard](#)
- *United States Courts, Courthouse Design Reference Manual: An Architect’s Desk Reference*, most current edition, Chapter 4.
- *Guide to Judicial Policy*, Vol. 16, Ch. 2.

Programming and Budgetary Notes

Programming and budgetary notes found throughout the *Design Guide* provide assistance with decisions to be made during the development of courthouse projects. The notes include both judicial branch policy and lessons learned from completed projects. The notes supplement the criteria in the *Design Guide*; their purpose is to provide direction in using the flexibility of the *Design Guide* to develop justifiable and cost-effective federal courthouse projects.

Space Envelope Flexibility

A total space envelope for new space will be calculated using appropriate circulation factors, allowances for support-type spaces, and the space standards described in the *Design Guide*. Courts have the flexibility to configure space within the envelope to meet their local needs. However, design and construction should be in general compliance with the square footage standards designated in the *Design Guide* in the space and ceiling requirements tables. If the court unit wishes to significantly change the space standards described in the space and ceiling requirements tables without exceeding the total envelope of space for the unit, it must seek approval from its respective circuit judicial council.

The space envelope for a respective court unit is defined as:

- Entire clerk’s office
- Entire probation office
- Entire pretrial services office
- Entire staff attorney’s office
- Entire circuit executive’s office
- All courtrooms designated by judge type (circuit judges, district judges, magistrate judges, and bankruptcy judges)
- All chambers designated by judge type (circuit judges, district judges, magistrate judges, and bankruptcy judges)

For existing space, courts have the flexibility to configure space within the existing envelope to meet their local needs. However, any significant departure from the square footage standards designated in the *Design Guide* in the space and ceiling requirements tables must be approved by the respective circuit judicial council. This does not mean that existing space must be changed to meet *Design Guide* standards. Only new construction completed as part of a renovation should be considered.

Renovations and Alterations (R&A)

Many of the construction projects conducted in the Judiciary are renovations to existing space. Although the *Design Guide* applies to these projects, it is understood that some standards in the *Design Guide* are difficult or impossible to achieve in existing space, particularly in historic buildings. Courts should consult [Chapter 17, “Renovations and Alterations \(R&A\),”](#) and [GSA PBS P-100](#) for guidance in these circumstances. References to R&A guidelines are also included throughout the *Design Guide* where appropriate.

Exceptions to the *Design Guide* Standards

The *Design Guide* provides guidance on standards for courthouse construction and renovations to existing space. Any significant departure from these standards is considered an exception and must be approved by the respective authority as outlined below.

Authority of the Circuit Judicial Councils

Circuit judicial councils play an important space-management role by reviewing district-wide facility plans, approving requests for new or modified space, and enforcing adherence to design guidelines. The circuit judicial councils have authority over, and responsibility for, a circuit's space-management program (28 USC §332 and §462(b)) and for determining the need for space. As directed by the Judicial Conference of the United States (JCUS), any significant departure from the standards in the *Design Guide* must be approved by the respective circuit judicial council.

Authority of the Committee on Space and Facilities

The authority to approve the following exceptions to the *Design Guide* standards rests with the Committee on Space and Facilities: (1) exceeding the total envelope for either the court unit or the project as a whole, (2) changing the standard configurations for judges' chambers and courtrooms, and (3) exceeding the plumbing standards. If the Committee on Space and Facilities disagrees with a circuit judicial council request for one of these exceptions, the Judicial Conference will decide whether to grant the exception.

Authority of the Judicial Conference

The authority for approving any exception to prospectus-level courthouse projects that would result in additional estimated costs, including additional rent payment obligations, lies with the Judicial Conference. Approval is required, after review by the Committee on Space and Facilities, for any exception to the *Design Guide* approved by a circuit judicial council. The request must include (1) a justification for the exception and (2) a construction cost estimate. [All approved exceptions for prospectus-level projects](#) are reported to the General Services Administration (GSA) and Congress. Approved exceptions may require the project to be reauthorized by Congress if the exception had not been previously identified. Contact the Administrative Office of the U.S. Courts (AOUSC) for more detailed information.

For prospectus-level courthouse projects, if an exception is approved by the JCUS which would result in additional estimated costs, the chair of the circuit's space and facilities committee or the chief judge or other judge designated by the court that sought the exception that exceeds the *Design Guide* criteria must be willing, if requested by the Committee on Space and Facilities, to appear before Congress concerning funding for such construction.

General Programming Notes

The *Design Guide* is intended to be a performance document. Criteria for any space or grouping of spaces should be considered in conjunction with the specific needs of the court office or function for which space is being designed.

Criteria in the *Design Guide* do not represent space entitlements. The criteria apply to an array of space types that should be justified based on the specific purpose of each project.

Facility plans, programs, and designs should include only the space needed to satisfy the functional and security requirements of the court.

Differences between the space in an existing facility and the criteria in the *Design Guide* are not justification for facility alteration and expansion. In such cases, alternatives to space expansion are investigated before any additional space is requested. In addition, like-for-like space is not a guarantee. Space allocated in an existing location is not justification for the same amount of space in a new location if the space allocation is not warranted. Current needs should be evaluated when moving into new space to determine the appropriate space envelope. Any additional space must be approved by the appropriate authority. Design architects and court staff are prohibited from adding spaces not originally contemplated in the approved prospectus or design program. Increasing the floor area or building volume requires the necessary approvals.

General Budgetary Notes

Renovation and new construction occur when the court and circuit judicial council identify space needs through the Judiciary's asset management planning process and document these needs in the long-range facilities plan. GSA determines by what method the space is provided—for example, by the construction of a new building, the renovation of an existing building, a lease, or other means.

The Judicial Conference recognizes and strongly supports a pragmatic approach to design that includes the use of durable and sustainable materials. This approach ensures that courthouses constructed now will last well into the future.

Following the publication of the *2007 Design Guide*, the Judiciary introduced several cost-saving measures, such as courtroom sharing and the Integrated Workplace Initiative (IWI), that sought to provide flexibility and efficiency in court spaces while preserving the dignity of the Judiciary. Courtroom sharing for certain judge types is now a standard throughout the Judiciary, and IWI is recognized as an alternative to traditional office design. For more information on cost- and space-saving efforts and programs, contact the AOUSC Space and Facilities Division.

General Requirements for All Courtrooms

Design requirements for various stations and overall functions are discussed here. More detailed design direction is included for each courtroom type (appellate, district, magistrate, and bankruptcy) in the chapter subsections that follow. [Chapter 12, “Tenant Improvements and Furnishings,”](#) provides general guidelines for finishes in courtrooms and associated spaces.

Functions and Associated Spaces

Public Waiting Areas

Public waiting areas are programmed spaces that are utilized by the patrons of the court. The waiting areas are used by attorneys, civil plaintiffs and defendants, out-of-custody criminal defendants, witnesses, spectators, family members, and the news media. The waiting areas are directly adjacent to the courtroom entrances and are separate and distinct from the public circulation and courtroom lobbies. Public waiting areas serve as extensions of public lobby and circulation areas adjacent to courtrooms; therefore, the design and furnishing of these spaces should be consistent. Infrastructure should be considered to support audio and video distribution from the courtrooms and electronic docket signage displays.

Soundlocks

Every courtroom should have a soundlock entry from the public lobby/circulation area. The exterior courtroom door should have locking hardware.

Spectator Seating

The public has the right to attend most court proceedings and shall be able to see and hear all participants as clearly as possible without infringing upon the proceedings in the well of the courtroom.

For controversial and high-security trials, spectators entering the courtroom may be subject to additional screening. Therefore, accommodation for equipment to detect firearms, bombs, and other weapons should be made at the entrance to the spectator area in the public lobby outside the courtroom.

A rail divides the well and spectator area. The rail should have an accessible opening or gate to admit attorneys, witnesses, U.S. Marshals Service (USMS) personnel, and other authorized persons into the well.

Attorney/Witness Rooms

Attorney/witness rooms are associated facilities for courtrooms. Attorneys use the rooms to confer with one another, their clients, and witnesses. Witnesses requiring separation from the general public while in the courthouse may use this room while waiting to testify.

Two attorney/witness rooms, which are adjacent to the courtrooms, may be provided per courtroom. The rooms should be programmed for multiple functions, such as for use as a news media room and for alternative dispute resolution (ADR) proceedings. Infrastructure should be considered to support audio distribution from the courtrooms.

Attorney Work Room

There shall be only one attorney work room provided per courthouse. It is provided for attorneys to use while waiting to appear in court.

Courtroom Positions and Design Requirements

Judge’s Bench

The height and location of the judge’s bench conveys the role of the judge and facilitates control of the court. The height of the judge’s bench and other courtroom stations is determined by the court. Generally, the judge’s bench should be elevated three steps (18 inches) above the courtroom well. The bench work surface should be 28-34 inches (711-864 mm) above the floor level of the judge’s station (i.e., normal desk height) and 30 inches (775 mm) deep. The front of the work surface should have a rail or barrier a maximum of 4 inches (100 mm) high around the top to prevent paper and materials from falling to the floor. Space is provided for a computer that does not obstruct essential sight lines. Each judge shall be provided with a lockable drawer for writing instruments and paper (legal size), and 6 linear feet (1,830 mm) of shelf space. The judge’s bench shall be outfitted with ballistic material providing a minimum of Level IIIA ballistic stopping power and should be configured to allow easy access to duress devices. A clock power and data outlet should be located in the courtroom directly opposite the bench wall, above the entry door(s). Additionally, the judge’s bench shall be able to accommodate a sidebar conversation with attorneys without being overheard by the jury. For additional guidance on sidebar requirements, refer to the [Courtroom Technology Audiovisual Infrastructure Standard](#).

Courtroom Deputy Clerk Station

The courtroom deputy clerk station is recommended to be at the same elevation or 6 inches above the courtroom well and set so that the judge and courtroom deputy clerk can easily see and confer with each other. The courtroom deputy clerk shall also be able to see and hear all court participants clearly, especially witnesses. The courtroom deputy clerk typically controls the temperature, light levels, and audiovisual equipment in the courtroom and should have the necessary controls at their station. The station should be large enough to accommodate a second staff person, who would be present during training or periodic high-volume hearings. The front of the work surface should have a rail or barrier a maximum of 4 inches (100 mm) high around the top to prevent paper and materials from falling to the floor. The computer should be ergonomically placed without obstructing essential sight lines. Infrastructure should be provided to support display of video presentation or video conferencing. Audiovisual (AV) accommodation should be lockable to prevent tampering with the system. Provisions for a printer with sound

isolation may be required. The station shall be outfitted with ballistic material providing a minimum of Level IIIA ballistic stopping power and should be configured to allow easy access to duress devices.

In district, magistrate, and bankruptcy judge courtrooms, a pass-through between the judge's bench and the courtroom deputy can be provided. The pass-through allows for the convenient and inconspicuous transfer of case files and messages.

In district and magistrate judge courtrooms, a securable cabinet should be provided near the deputy clerk's station for letter- or legal-sized documents or large, bulky objects.

The station should accommodate the following storage:

- Two built-in file drawers, each a minimum of 20 inches (500 mm) deep, able to accommodate both letter- and legal-sized files
- A lockable drawer for writing instruments and paper (legal size)
- Storage for AV equipment supplies
- An adjustable shelf in the station a minimum of 18 inches (450 mm) deep by 36 inches (925 mm) long for different sized exhibits

Law Clerk Station

Unless noted otherwise, one or two law clerks may be present at the discretion of the judge. The law clerks provide research assistance to the judge and may attend courtroom proceedings. In a courtroom, the law clerk station should be set so that the judge and law clerk can easily see and confer with each other. In addition, they should be able to see and hear electronic evidence presentation materials.

If seated adjacent to the judge's bench, the law clerk station is recommended to be one step (6 inches) above the well. A work surface a minimum of 24 inches (600 mm) deep by 60 inches (1,525 mm) wide should be provided at desk height. Where more than one law clerk occupies a station, each clerk should be allocated a work surface area a minimum of 30 inches (775 mm) wide. Where a computer is used, a corner or side work surface should be provided that is sized to support a computer. The computer should be ergonomically placed for the clerk's comfort without obstructing essential sight lines. The front of the work surface should have a rail or barrier a maximum of 4 inches (100 mm) high around the top to prevent paper and materials from falling to the floor.

Two 20-inch (500-mm) deep file drawers should be provided to accommodate both letter- and legal-size files. Lockable storage drawers should be provided to accommodate writing implements and legal pads.

In district, magistrate, or bankruptcy judges' courtrooms, a pass-through between the judge's bench and the law clerk station can be provided to allow for the convenient and inconspicuous transfer of documents and messages.

Infrastructure should be provided to support display of video presentation or video conferencing. In addition, a station may be required for an electronic court recording operator (ECRO) technician/clerk. This function may also be performed by the deputy clerk.

Spectator Seating

The right to a public trial necessitates a certain volume of general public seating. Demand for spectator, news media, and family seating varies depending on the public interest and the number of parties in a particular case. Most trials will draw only a few or occasional spectators.

Benches or fixed chairs should be provided. A millwork rail divides the well and spectator area. The rail should have an accessible gate or opening to admit attorneys, witnesses, USMS personnel, and other authorized persons into the well.

Windows

Designing courtrooms with windows requires careful consideration of the benefits, potential problems, and costs. If a courtroom is designed with windows, precautions are necessary to maintain security and environmental controls. A courtroom may have windows (regular or clerestory) or skylights to obtain the benefits of daylight.

Windows and skylights should be sealed, double- or triple-glazed, and equipped to control heat gain/loss, brightness, glare, noise, and dust infiltration. A means of light control and room darkening should also be provided. To prevent distraction and increase security, higher window sills or clerestory windows or skylights are more desirable. Interior windows or interior clerestory windows, incorporated for "borrowed" light, shall meet the acoustic requirements stated in [Chapter 14, "Acoustics."](#)

Ceiling Height

Courtroom ceiling heights should reflect the solemnity of court proceedings. The raised judge's bench and ceiling height contribute to the order and decorum of the proceedings. The ceiling height standards in the *Design Guide* were calculated using generally accepted principles of architectural proportion and by direct observation of effective courtroom designs.

The ceiling is a designed surface. It may be uniformly flat, or it may have two or more planes and include elements such as soffits, perimeter coves, recesses, and reveals as required to integrate HVAC and lighting into a harmonious design. An adjustment of a ceiling surface may also occur where it meets an exterior curtain wall to accommodate different equipment. In situations where there are several different surfaces at different heights above the finished floor, there may be different ways of determining which one is the dominant plane. Ceiling heights should be measured from the finished floor to the dominant surface that either covers the most amount of ceiling square footage, or the

Table 4.1
Ceiling Requirements for Courtrooms and Associated Spaces

Space Name	Ceiling Height (feet)	Ceiling Height (mm)
En Banc Courtroom	18	5,500
Panel Courtroom	16	4,900
Multi-Party Courtroom	18	5,500
District Judge Courtroom	16	4,900
Magistrate Judge Courtroom	16	4,900
Bankruptcy Judge Courtroom	16	4,900
Judges' Conference/Robing Room	10	3,000
Attorney/Witness Rooms	10	3,000
Attorney Work Area	10	3,000

surface that defines the overall character of the ceiling design. The design team should ensure that in all newly constructed spaces the dominant plane of the ceiling does not exceed the maximum ceiling height listed in the *Design Guide*. Dominant planes that exceed these maximum heights are considered an exception. The application of this maximum ceiling height in renovation and alteration projects may be dependent on limitations of existing conditions.

The ceiling height should be in proportion to the area of the space. If the space is located on a floor with a higher floor-to-floor height, the ceiling height of the room may be designed to maximize use of available natural light, volume, and window configuration of that space. Ceiling heights for courtrooms and their associated spaces shall be in accordance with the maximum ceiling heights listed in [Table 4.1](#).

Image Projection/Displays

Mobile projectors, video monitors, and recorders should be stored at a central location for use in the courtroom. All positions within the courtroom should be positioned for optimal viewing of fixed and mobile display technology. Projection screens are considered equipment items funded by the Judiciary. Architectural integration of screens and electrical infrastructure is provided as part of the construction cost.

Refer to [Chapter 15, “Building Systems,”](#) and the *Courtroom Technology Audiovisual Infrastructure Standard* for additional technology requirements for courtrooms and their associated spaces.

Audiovisual Storage

A storage location central to similar courtrooms should be provided for audiovisual equipment, including mobile video monitors and cameras, portable interpretation (TIPS) systems, and portable audio recording/playback equipment. Audiovisual equipment remaining in courtrooms should be built into walls or courtroom furniture. The design team should refer to [Chapter 15, “Building Systems,”](#) and the *Courtroom Technology Audiovisual Infrastructure Standard*.

Audiovisual Equipment Room

An audiovisual equipment room should be provided for audiovisual equipment racks adjacent to the courtroom with power and cooling sufficient to support the audiovisual equipment in both operational and standby modes. Audiovisual equipment rooms may be shared, typically with one larger equipment room per pair of courtrooms. The design team should refer to the *Courtroom Technology Audiovisual Infrastructure Standard*.

Renovations and Alterations (R&A)

Certain design requirements stated in the *Design Guide* may be impractical, impossible, or cost-prohibitive to meet because of challenging existing conditions. Stakeholders should discuss these challenges early in the project and determine how to best implement the *Design Guide* requirements to suit their specific needs and uphold its intent. Refer to [Chapter 17, “Renovations and Alterations,”](#) for additional guidance.

In existing, older courthouses, the size, location, and configuration of courtrooms may vary depending on the structural limitations of the building. A number of factors may contribute to variances:

- Courtrooms were built to previous standards or for different court functions.
- Existing floor plates vary in size and shape and do not always accommodate the most functional dimensions for a courtroom.
- Historic buildings may have limited or restricted space for courtrooms.
- Available space is not always contiguous due to historic elements, other tenants, or building elements such as stairwells, elevators, and corridors.
- Fire and life safety restrictions may affect or conflict with optimum security or functionality.

Figure 4.1
Fully Accessible Courtroom

Symbols Legend:

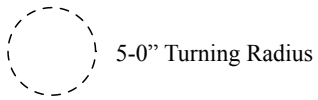

Note: The diagram is intended only as an illustration.

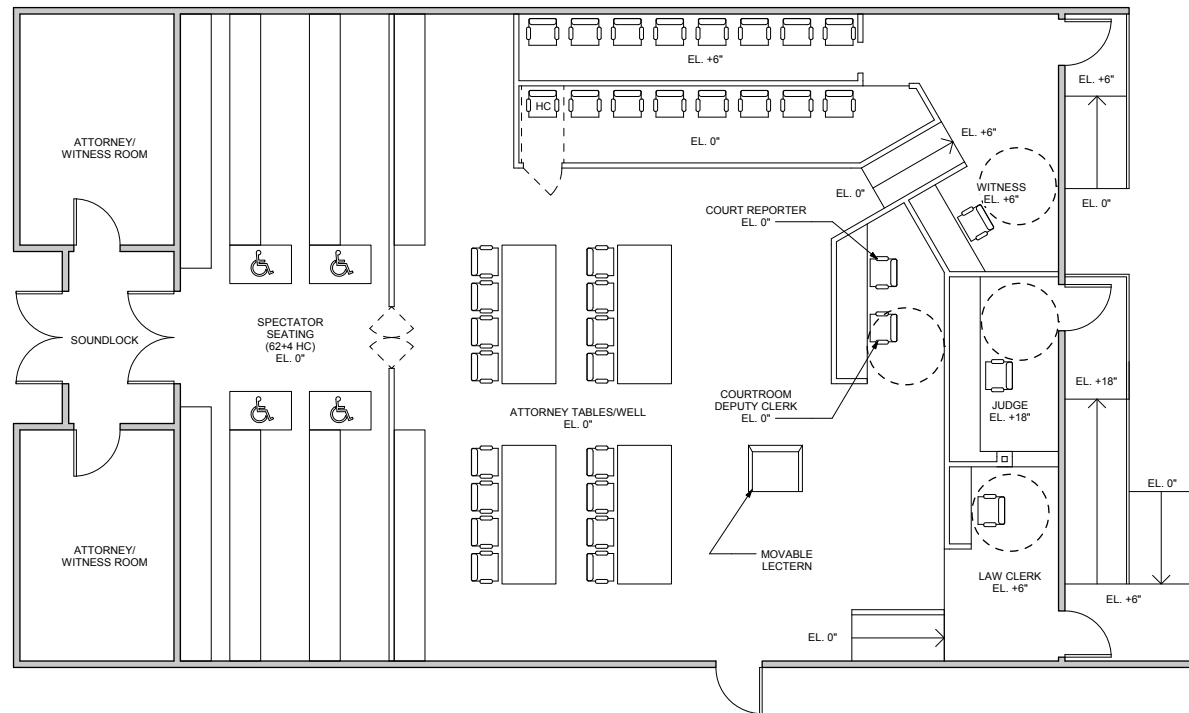

Special Considerations

Barrier-Free Accessibility

Courtroom areas used by the public shall be accessible to people with disabilities. A sample floor plan, shown in [Figure 4.1](#), illustrates barrier free design accommodations for courtrooms. Refer to [Chapter 3, “Planning for U.S. Courthouses,”](#) for detailed accessibility requirements in the courtroom spaces.

Multi-Party Courtrooms

Multi-party courtrooms shall be assigned for normal daily use, in addition to being used for multi-party and large multi-party trials. Refer to [Chapter 2, “Courthouse Programming and Budgetary Considerations”](#) for additional information regarding multi-party courtrooms.

Appellate Courtrooms

Functions

The primary function of appellate courtrooms is the presentation of oral arguments by counsel to circuit judges. Arguments involve appeals of decisions by the USDC and USBC, as well as by the tax court and various federal administrative agencies. Other functions may include ceremonial events such as the investiture of judges newly appointed to the bench.

Judges’ Conference Rooms

Judges’ conference rooms provide space for meeting, training sessions, case conferences by circuit judges, and other functions involving judges. The facility includes a small service unit where food and beverages can be staged. Infrastructure should be provided to support audio and video feeds and display from the courtroom.

Judges’ Robing Room

The judges’ robing room is an associated facility for appellate courtrooms. Circuit judges use the robing room to don and remove judicial robes before and after courtroom proceedings. User capacity varies according to the number of circuit judges and the type of courtroom (i.e., en banc or panel). Infrastructure should be provided to support audio and video feeds and display from the courtroom.

Attorney Work Room

The attorney work room is an associated facility for appellate courtrooms. The facility comprises both a waiting and work area. Attorneys use the work room while waiting to present arguments in USCA proceedings. The work area is used for discussions and last-minute preparation of court presentations. The number of users varies with the number of attorneys waiting to present arguments. Infrastructure should be provided to support audio and video feeds and display from the courtroom.

Design Requirements for Appellate Courtrooms

The well of an en banc or panel courtroom should accommodate an en banc or panel judge’s bench, court personnel workstations, and at least two counsel tables. For both panel and en banc hearings, a courtroom deputy clerk and at least three law clerks are present.

Design requirements for each court position are listed below. Courtroom and associated space requirements for appellate courtrooms are listed in [Table 4.2](#).

Judge’s Bench

A panel of three judges hears appeals (panel courtroom). Some cases are heard by all judges sitting en banc, except in the Ninth Circuit, which typically sits in en banc panels. Since circuit judges sit en banc or in panels, benches may be curved or angled to allow the judges to see one another. Elevating the bench three steps (18 inches) above finished well floor level may be required to facilitate proper sight lines. Infrastructure should be provided to support display of video presentation or video conferencing. The judge’s bench shall be outfitted with ballistic material providing a minimum of Level IIIA ballistic stopping power and should be configured to allow easy access to duress devices.

Courtroom Deputy Clerk Station

In appellate courtrooms, the courtroom deputy clerk may be responsible for announcing cases to be heard and for operating the timing system and recording equipment. The deputy clerk often confers with the judges during proceedings. The deputy clerk station shall be outfitted with ballistic material providing a minimum of Level IIIA ballistic stopping power and should be configured to allow easy access to duress devices.

Law Clerk Stations

The law clerks provide research assistance to the judges and attend oral arguments. Circuit judges’ courtrooms should accommodate a workstation near the bench for at least three law clerks.

Electronic Court Recording Operator (ECRO) Technician/Clerk

Manages the electronic court recording system.

Security Personnel

Normally, no security personnel are present in the courtroom.

Attorney Stations

In appellate cases, at least one attorney is present on each side of the case. Counsel should be accommodated in appellate courtrooms with two attorney tables, each seating at least four participants. Additional seating may be provided within the well for attorneys waiting for their cases to be called.

Table 4.2
Space Requirements for Appellate Courtrooms and Associated Spaces

Appellate Courtrooms and Associated Spaces		
Courtrooms	NSF	Nm ²
En Banc Courtroom	3,000	278.7
Panel Courtroom	1,800	167.2
Associated Spaces	NSF	Nm ²
Public Waiting Area	400	27.8
Soundlock	80	7.4
Public/Attorney Coat Closet	20	1.9
Judges' Conference Room ¹	250	23.3
Judges' Robing Room ²	-	-
Soundlock	80	7.4
Toilet 1	50	4.7
Toilet 2	50	4.7
Attorney Work Area ³	250	23.3
Attorney Waiting Area	100	9.3
Audiovisual Equipment Room	120	11.1
Equipment Storage Room	100	9.3
Exhibits Storage	50	4.7
Staff Toilets ⁴	-	-

¹ Allocation of 250 NSF (23.3 Nm²) includes a service unit.

² Allocate 100 NSF (9.3 Nm²) plus 25 NSF (2.3 Nm²) per judge for judges' robing room.

³ Only one per courthouse, not per courtroom.

⁴ Total staff toilet requirements are to be determined in design by the International Plumbing Code, most current edition. Plumbing fixtures required to serve a given floor shall be proportionally split between the staff and public occupant loads.

Attorney stations are not fixed; however, they are located within a defined area of the courtroom well. Attorneys should see and hear each other and be seen and heard by judges and the courtroom deputy clerk. With the permission of the judge, attorneys may use portable computers at or next to counsel tables. In appellate courtrooms, the lectern may be fixed but should be height adjustable and ABAAS compliant.

Each attorney/litigant table should have a work surface a minimum of 36 inches (915 mm) deep and 84 inches (2,150 mm) wide, allowing at least two linear feet per person. Infrastructure should be provided to support display of video presentation or video conferencing.

Litigants

Typically, no litigants are present in the well of the courtroom.

Witnesses and Interpreters

No witnesses or interpreters are present in the well of the courtroom.

Jurors

No jurors are present.

Spectators

Spectator seating should be provided as follows: en banc courtroom seating for a maximum of 120-150 spectators, and panel courtroom seating for 40-80 spectators. Refer to the "General Requirements for All Courtrooms" section of this chapter for more information regarding spectator seating.

Adjacency and Circulation

The most effective configuration of the courtroom floor minimizes the distance of movement and conflicting circulation patterns of trial participants (Figure 4.2). For an overview of this topic, refer to Chapter 3, "Planning for U.S. Courthouses," for circulation factors.

Courtrooms





Appellate courtrooms should provide both public and restricted access. The courtroom is separated from the public corridor by a soundlock. Restricted access is provided separately for judges and court staff; for court staff, just below the bench, and for judges, close to robing and conference rooms, allowing a formal entry from the side or behind the bench. For ceremonial functions, indirect access may also be provided from the bench down to the well. Circulation space behind the bench should allow a judge to arrive and depart without disrupting other judges.

Figure 4.2
Appellate (Panel or En Banc Courtrooms) Adjacency Relationships

Colors Legend:

 **Chapter 4**
Courtrooms and Associated Spaces

Symbols Legend:

-  Public Circulation
-  Public Vertical Circulation
-  Restricted Circulation
-  Restricted Vertical Circulation
-  Circulation Access Control Point

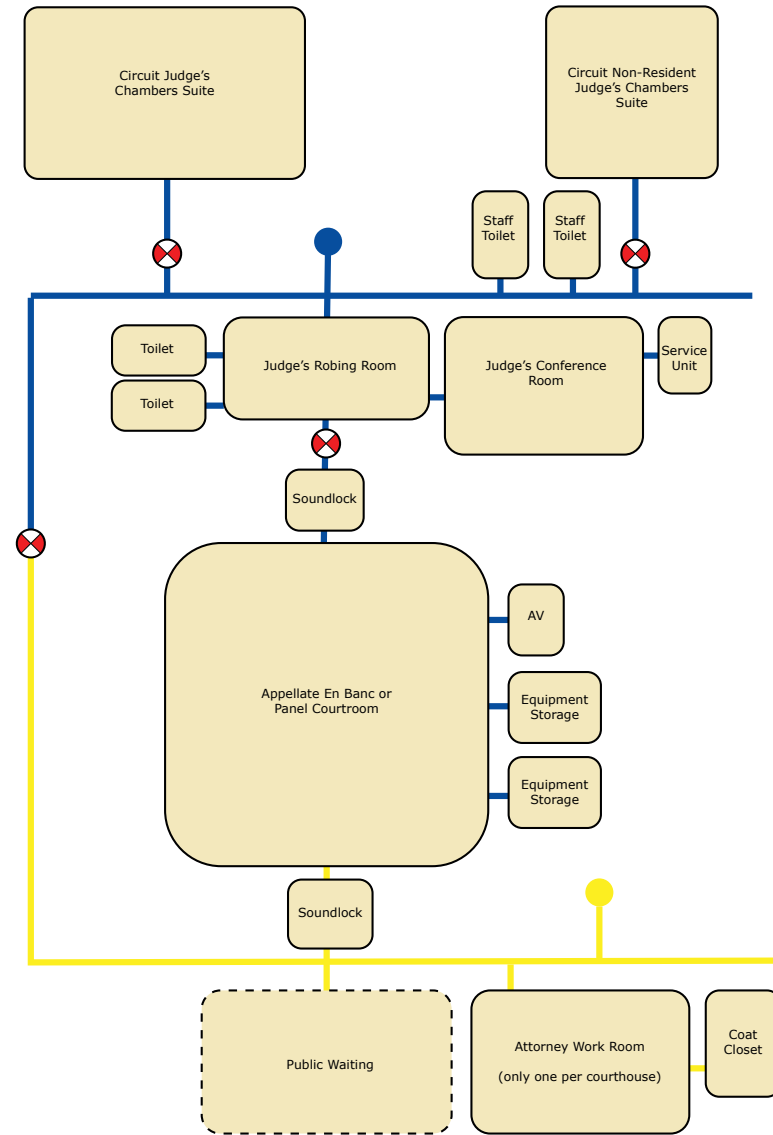

Note: The adjacency diagram is intended only as an illustration.

Judges' Robing Room

The judges' robing room should be directly accessible from the associated courtroom through a soundlock; it should also be accessible from a restricted circulation area. To provide a processional path from the courtroom to the conference room, a robing room may also directly adjoin the USCA shared judges' conference room. For additional information regarding adjacency and circulation related to robing rooms, refer to the USCA adjacency diagrams in [Chapter 3, "Planning for U.S. Courthouses."](#)

The judges' robing room should allow access to private toilets for the judges' use, with separate men's and women's toilet rooms. The toilets should be provided with a soundlock.

Judges' Conference Room

The judges' conference room is accessible from public circulation and restricted circulation through the adjoining robing room.

Attorney Work Room

The attorney work room should be accessible from public circulation.

District Judge Courtrooms

Functions

The primary function of district judge courtrooms is to conduct criminal and civil proceedings. District judges conduct hearings, bench trials, and jury trials in both civil and criminal cases. Only district judges conduct felony criminal trials.

The well of the courtroom should accommodate a judge's bench, court personnel workstations, a witness box, a 16-person jury box, and at least four counsel tables. This allows for 15-20 lawyers, plaintiffs, defendants, and interpreters. Space should be included for exhibit display and USMS personnel stationed around the perimeter of the well.

In the district judge's courtroom well, 10-20 people are typically present in addition to court personnel and the seated jury. However, multi-defendant cases are becoming more common and the need for accommodations for multiple parties is necessary. For example, a criminal trial involving six in-custody defendants could generate 50 or more participants, including the judge, courtroom deputy clerk, court reporter/recorder, law clerk, two assistant U.S. attorneys, two case agents, the six defendants and their defense attorneys, 12 deputy marshals, 16 jurors, a witness, and possibly an interpreter. For examples of courtroom layouts, including a Jeffersonian courtroom, refer to the *AO Best Practices Guide for Courthouse Construction*.

Courtroom Sharing

Courtroom sharing has been recognized as a necessary model for future operations; it is recommended that courtrooms in all new courthouses be designed in a uniform way so that they are interchangeable for this purpose. This includes consideration of placing courtrooms on floors separated from chambers accessible by a secure judges' elevator. Additionally, consideration should be given to duplicate network connectivity in shared courtrooms of different types. Refer to the [Courtroom Technology Audiovisual Infrastructure Standard](#) for additional information.

Judges' Conference/Robing Room

The conference/robing room is an associated facility for district judge courtrooms only when chambers are located in an area remote from the courtroom (i.e., collegial design). Conference/robing rooms are used for private conferences with attorneys during brief trial recesses, and as a place for trial court judges to store robes and prepare to enter the courtroom. Consideration should be given to designs that allow judges' conference/robing rooms to be shared between pairs of courtrooms. Infrastructure should be provided to support audio and video feeds and display from the courtroom.

Design Requirements for District Judge Courtrooms

Design requirements for each court position are listed below. Courtroom and associated space requirements for district judge courtrooms are listed in [Table 4.3](#).

Judge's Bench

A single judge presides over civil and criminal proceedings, although a limited number of district cases are heard by panels of three judges.

Refer to the "[General Requirements for All Courtrooms](#)" section of this chapter for more information regarding the judge's bench.

Courtroom Deputy Clerk Station

The courtroom deputy clerk typically is responsible for tracking all court activity during the proceedings, including the order of cases called, as well as documenting decisions by the court and tagging and caring for exhibits. The deputy clerk often confers with the judge during proceedings and can swear in the jury and witnesses.

Refer to the "[General Requirements for All Courtrooms](#)" section of this chapter for more information regarding the courtroom deputy clerk station.

Law Clerk Station

One or two law clerks and an ECRO technician/clerk may also be present at the judge's discretion.

Table 4.3
Space Requirements for District Judge Courtrooms and Associated Spaces

District Judge Courtrooms and Associated Spaces		
Courtrooms	NSF	Nm ²
Multi-Party Courtroom	3,000	278.7
District Judge Courtroom	2,400	223
Associated Spaces	NSF	Nm ²
Public Waiting Area	400	27.8
Soundlock	80	7.4
Public/Attorney Coat Closet	20	1.9
Judges' Conference/Robing Room ¹	200	23.3
Attorney/Witness Room 1	150	14.0
Attorney/Witness Room 2	150	14.0
Court Reporter/Recorder Office	150	14.0
Court Reporter/Recorder Storage	50	4.7
Attorney Work Area ²	250	23.3
Attorney Waiting Area	100	9.3
Shared Work Room	100	9.3
Transcriber/Typist Workstation	48	4.5
Audiovisual Equipment Room	120	11.1
Equipment Storage Room	100	9.3
Exhibits Storage	50	4.7
Staff Toilets ³	-	-

¹ Provided when chambers are located on a separate floor. If a judges' conference/robing room is provided, a 56 NSF restroom may be programmed in addition to the 200

NSF space. Refer to the “Adjacency and Circulation” subsection of the “District Judge Courtrooms” section.

² Only one per courthouse, not per courtroom.

³ Total staff toilet requirements are to be determined in design by the International Plumbing Code, most current edition. Plumbing fixtures required to serve a given floor shall be proportionally split between the staff and public occupant loads.

Refer to the “General Requirements for All Courtrooms” section of this chapter for more information regarding the law clerk station.

Court Reporter/Recorder Station

The court reporter/recorder records court proceedings. The court reporter/recorder should be able to see the facial expressions of witnesses, attorneys, and the judge, and hear every word spoken. Thus, the court reporter/recorder station should be located close to the witness box. In addition, they should be able to see and hear electronic evidence presentation materials.

Some court reporting/recording technologies require a work surface as part of the station. Work surfaces should be sized to satisfy the requirements of the specific technologies used. The workstation should include a modesty panel.

A lockable, built-in cabinet should be provided for stenographic equipment. Provision of an electrical outlet in the cabinet should be considered to allow the battery of the stenographic equipment to be charged while in storage. In addition, a cabinet with an adjustable shelf and a drawer should be provided for recording equipment. The drawer should be at least 6 inches (150 mm) high and lockable. The cabinet should be provided in a location convenient to the court staff operating the recording equipment.

Furniture and other equipment used by the court reporter/recorder should be movable so that it may be easily rearranged to suit each court reporter or judge.

Witness Box

Witnesses should be able to see, hear, and be seen and heard by all court participants as close to full face as possible. The witness box should accommodate one witness and one interpreter. Witnesses seated in the witness box receive, examine, and return exhibits utilizing technology as well as handle physical objects and papers.

The witness box is recommended to be raised one or two steps (6 or 12 inches) above the well. If an interpreter is necessary, the interpreter should be seated next to or slightly behind the witness and between the witness and the judge. The witness should remain the primary focus. A separate interpreter station accommodating two staff persons may be required in some locations.

Spectator Seating

Spectator seating should be provided to accommodate seating for 65-85 people. However, in cases involving multiple parties, this number may be lowered to accommodate trial participants. Additional seating may be accommodated in another courtroom through the use of an audio/video feed.

Refer to the “[General Requirements for All Courtrooms](#)” section of this chapter for more information regarding spectator seating.

Jury Box

Jury boxes for district judges’ courtrooms should accommodate 16 jurors; multi-party courtrooms should accommodate 18 jurors. Although there may be instances where fewer juror seats are needed in a courtroom, it is recommended that the standard be used for uniformity to allow for courtroom sharing.

A 12-member jury is typically selected from a panel of 45-60 potential jurors and a six-member jury is selected from 15-25 potential jurors. The number of potential jurors may reach 100 or more in cases with heavy media coverage, multiple parties, or lengthy trials. During impaneling, the potential jurors may be seated in the spectator area of the courtroom. These seats may be made available to the public after the jury has been impaneled.

Jurors should be able to see, hear, and be seen by the judge, attorneys, and witnesses. During witness examination, all jurors should be able to see the attorneys, litigants, and witnesses as close to full face as possible. In addition, there should be a clear line of sight to video evidence presentation devices if they are used in the courtroom.

Jurors should be separated from attorneys and litigants to prevent the overhearing of private conversations. The maximum allowable distance between a juror and a litigant sitting at a counsel table across the courtroom well is 40 feet (12,200 mm). In addition, jurors should be separated from the public to avoid interference or intimidation. At least 6 feet (1,825 mm) of space should separate the jury box and the rail dividing the spectator seating area and courtroom well.

The front row of the jury box may be raised one step (6 inches or 150 mm) or on the same floor level as the courtroom well. If the first row is one step above the well, a ramp shall be provided to allow unassisted access for jurors with disabilities using the same path as all other jurors. Gates and openings into the jury box, clear floor space, and vertical clearance shall allow for space to maneuver a wheelchair and for jurors with disabilities to participate from the same position as all other jurors. The front row may have a dedicated wheelchair space or a removable chair to provide the necessary space when needed.

The floor level of the highest tier of the jury box should be at least one step (6 inches or 150 mm) lower than that of the judge’s bench. Jury box requirements should be discussed with the local court and may include requirements for evidence presentation systems. The top tier of a jury box is recommended to be elevated a minimum of 6 inches above the finished well floor.

Attorney and Litigant Stations

At least one attorney is present on each side of the case. Trial attorneys may be assisted by paralegals and other staff, all of whom are positioned in the courtroom at the discretion of the presiding judge. In USDC criminal cases, U.S. government attorneys are usually assisted in court by case agents from the investigative agency involved. Attorney and litigant stations are not fixed; however, they are located within a defined area of the courtroom well. The number of litigants depends entirely upon the number of parties and the nature and complexity of the case. For civil cases, the number of litigants on each side may range from one to 10, although more than 10 litigants is not unusual. In criminal cases, the number of defendants may range from one to 20, although cases with more than 20 defendants do occur. Generally, each defendant is represented by an attorney.

Each attorney/litigant table should have a work surface a minimum of 36 inches (915 mm) deep and 84 inches (2,150 mm) wide, allowing at least two linear feet per person. With the permission of the judge, attorneys may use portable computers at or next to counsel tables. A movable, ABAAS-compliant height-adjustable lectern should be provided for attorneys. Refer to the [Courts Technology Audiovisual Infrastructure Standard](#) for presentation requirements.

In district judges’ courtrooms, attorneys and their clients should be able to confer in private at their courtroom stations without being overheard by jurors, witnesses, opposing attorneys and litigants, spectators, or others in the courtroom. Attorneys should be able to move easily within the well of the courtroom.

U.S. Marshals Service

USMS personnel are responsible for the custody and movement of criminal defendants; the safety, security, and privacy of the judge, jurors, and witnesses; the security of the courtroom and safety of its occupants; and maintaining order in the courtroom. Typically, one or more USMS personnel are present in the courtroom. The total number of USMS personnel depends on the nature of the matter being heard. In criminal cases, two USMS personnel may be present for each in-custody defendant in the courtroom.







USMS personnel should be able to see all participants and the public. Although USMS personnel generally do not have fixed workstations in the courtrooms, they are usually provided with chairs that may be moved to suit the needs of a proceeding. Infrastructure to provide audio and video feeds to the USMS command center should be provided.

Figure 4.3
U.S. District Court Adjacency Relationships

Colors Legend:

 **Chapter 4**
Courtrooms and Associated Spaces

Symbols Legend:

-  Public Circulation
-  Public Vertical Circulation
-  Restricted Circulation
-  Restricted Vertical Circulation
-  Secure Circulation
-  Secure Vertical Circulation
-  Circulation Access Control Point

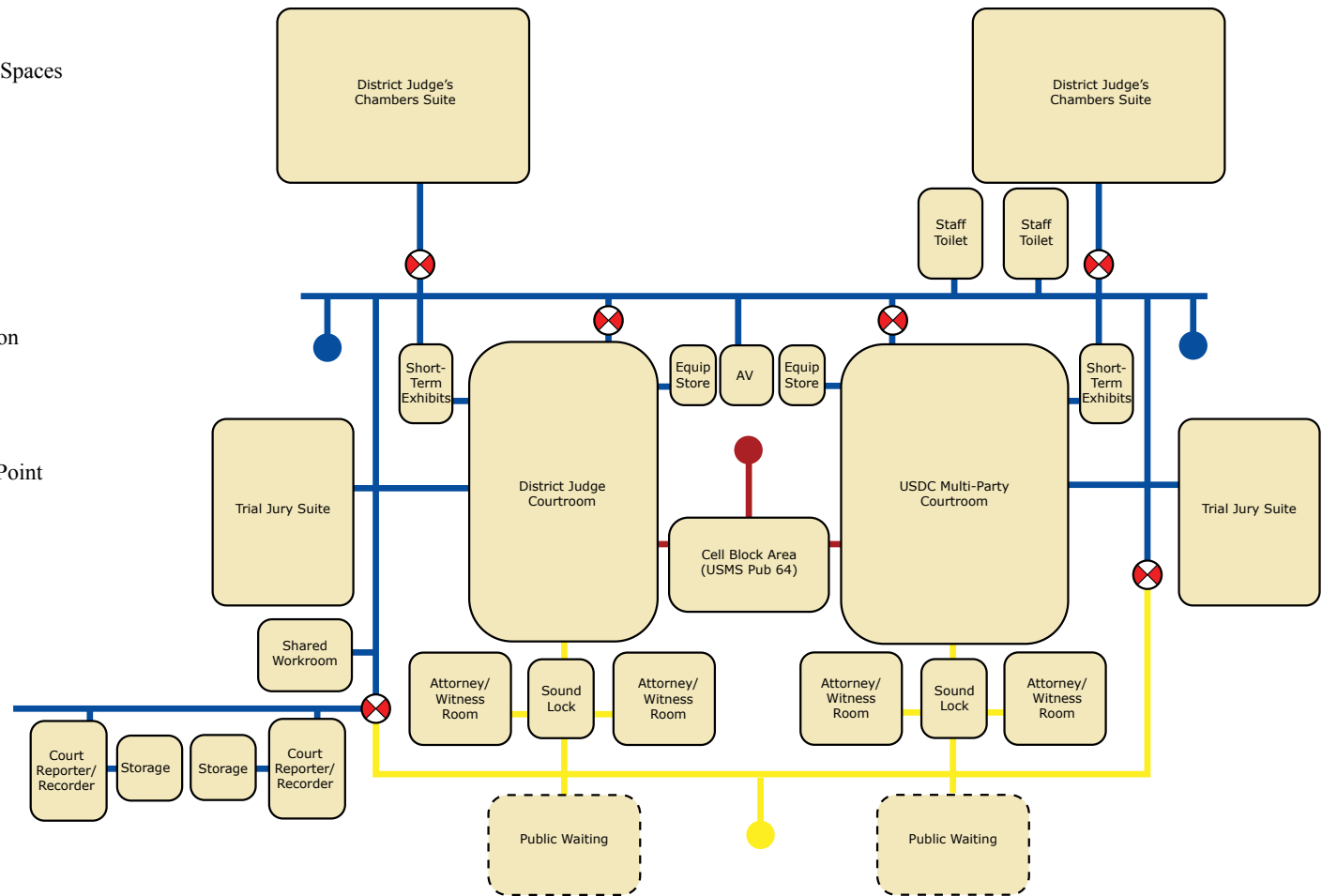

Note: The adjacency diagram is intended only as an illustration. Conference/robing room(s) are allowed where chambers are not on the same floor as the courtroom.

Adjacency and Circulation

The most effective configuration of the courtroom floor minimizes the distance of movement and conflicting circulation patterns of trial participants (Figure 4.3). For an overview of this topic, refer to Chapter 3, “Planning for U.S. Courthouses,” for circulation factors.

Courtrooms

District judge courtrooms should typically provide the following three types of access: (1) public circulation and access for spectators, news media representatives, attorneys, litigants, and witnesses; (2) restricted circulation and access for judges, law clerks, courtroom deputy clerks, court reporters/recorders, and jurors; and (3) secure circulation and access for prisoners and USMS personnel. These three circulation and access patterns should be separate to provide security for all groups. The courtroom should have separate entrances from restricted circulation for the judge; jury, courtroom deputy clerk, and court reporter/recorder; prisoners and USMS personnel; and the public. Entrances for the various groups should be located as close as possible to their stations in the courtroom. Courtrooms are separated from the public corridor by a soundlock.

Judges’ Conference/Robing Room

Conference/robing rooms are required for district, magistrate, and bankruptcy judges’ courtrooms only when judges’ chambers are located in an area remote from the courtroom.

Conference/robing rooms should be located close to the courtroom and accessible from restricted circulation. Consideration should be given to designs that allow judges’ conference/robing rooms to be shared between pairs of courtrooms.

Judges should have access to toilets convenient to the courtroom and accessible through restricted circulation. If necessary, a toilet may be programmed with the conference/robing room.

Attorney/Witness Room

Attorney/witness rooms should be directly accessible from public circulation. In some instances, access from restricted or secure circulation is also desirable. Restricted access provides a higher degree of privacy and security, especially for sensitive witnesses. An occupancy indicator should be provided for each room (e.g., a small sign or view panel adjacent to the door).

Attorney Work Room

The attorney work room should be accessible from public circulation.

Court Reporter/Recorder Facilities

Court reporter/recorder facilities should generally be located near courtrooms. The facilities should be accessible primarily from restricted circulation areas; however, some

public accessibility should also be provided to accommodate the public purchase of transcripts.

Magistrate Judge Courtrooms

Functions

The function of magistrate judge courtrooms is to hold hearings on preliminary matters in criminal cases (e.g., an arraignment, where a defendant is brought before a judge to enter a plea). Magistrate judges preside over these hearings and also conduct misdemeanor trials. Under certain circumstances, magistrate judges conduct the full range of proceedings in civil cases, up to and including jury trials.

Proceedings conducted by magistrate judges typically include multiple defendants or litigants and a number of spectators. The well of the courtroom should accommodate a judge’s bench, court personnel workstations, a witness box, a 12-person jury box, and at least two counsel tables for lawyers, plaintiffs, defendants, and interpreters. Space should be included for exhibit display and USMS personnel stationed around the perimeter of the well.

Courtroom Sharing

The JCUS adopted the following courtroom sharing policy for magistrate judges in new courthouse construction projects: (1) in courthouses with one or two magistrate judges, one courtroom will be provided for each magistrate judge; (2) in courthouses with three or more magistrate judges, one courtroom will be provided for every two magistrate judges; and (3) in courthouses where the application of this formula will result in a fraction (i.e., those with an odd number of magistrate judges), the number of courtrooms allocated will remain at the next lower whole number. In addition, one courtroom will be provided for magistrate judge criminal duty proceedings. Refer to the *Guide to Judiciary Policy*, Vol. 16, Ch. 2, Sec. 230.20

It is recommended that magistrate courtrooms in all new courthouses be designed in a uniform way so they are interchangeable for courtroom sharing. A court, with the approval of its circuit judicial council, may seek an exemption to the courtroom sharing policy from the Committee on Space and Facilities if the required sharing arrangement inhibits the effective and efficient disposition of cases. Such exemptions should be considered the exception and not the rule. Refer to the *Guide to Judiciary Policy*, Vol. 16, Ch. 2, Sec. 230.20.

Additionally, consideration should be given to duplicate network connectivity in shared courtrooms of different types. Refer to the *Courtroom Technology Audiovisual Infrastructure Standard* for additional information.

Judges' Conference/Robing Room

The conference/robing room is an associated facility for magistrate judge courtrooms when chambers are located in an area remote from the courtroom (i.e., collegial design). Conference/robing rooms are used for private conferences with attorneys during brief trial recesses, and as a place for trial court judges to store robes and prepare to enter the courtroom. Consideration should be given to designs that allow judges' conference/robing rooms to be shared between pairs of courtrooms. Infrastructure should be provided to support audio and video feeds and display from the courtroom.

Design Requirements for Magistrate Judge Courtrooms

Design requirements for each court position are listed below. Courtroom and associated space requirements for magistrate judge courtrooms are listed in [Table 4.4](#).

Judge's Bench

A single judge presides over civil and criminal proceedings. A magistrate judge presides over a narrower range of criminal and civil cases than does a district judge.

Refer to the "[General Requirements for All Courtrooms](#)" section of this chapter for more information regarding the judge's bench.

Courtroom Deputy Clerk Station

The courtroom deputy clerk typically is responsible for tracking all court activity during the proceedings, including the order of cases called, as well as documenting decisions by the court and tagging and caring for exhibits. The deputy clerk often confers with the judge during proceedings and can swear in the jury and witnesses.

Refer to the "[General Requirements for All Courtrooms](#)" section of this chapter for more information regarding the courtroom deputy clerk station.

Law Clerk Station

One or two law clerks and an ECRO technician/clerk may also be present, at the discretion of the judge.

Refer to the "[General Requirements for All Courtrooms](#)" section of this chapter for more information regarding the law clerk station.

Court Reporter/Recorder Station

The court reporter/recorder records court proceedings. The court reporter/recorder should be able to see the facial expressions of witnesses, attorneys, and the judge, and hear every word spoken. Thus, the court reporter/recorder station should be located close to the witness box. In addition, they should be able to see and hear electronic evidence presentation materials.

Some court reporting/recording technologies require a work surface as part of the station. Work surfaces should be sized to satisfy the requirements of the specific technologies used. The workstation should include a modesty panel.

A lockable, built-in cabinet should be provided for stenographic equipment. Provision of an electrical outlet in the cabinet should be considered to allow the battery of the stenographic equipment to be charged while in storage. In addition, a cabinet with an adjustable shelf and a drawer should be provided for recording equipment. The drawer should be at least 6 inches (150 mm) high and lockable. The cabinet should be provided in a location convenient to the court staff operating the recording equipment.

Furniture and other equipment used by the court reporter/recorder should be movable so that it may be rearranged easily to suit each court reporter or judge.

Witness Box

Witnesses are routinely called to testify in trials. An interpreter is furnished if required by a witness or defendant. Witnesses should be able to see and hear, and be seen and heard by, all court participants as close to full face as possible. The witness box should accommodate one witness and an interpreter. Witnesses in the box receive, examine, and return exhibits. In addition, the witness should be able to see and hear electronic evidence presentation materials.

The witness box is recommended to be raised one or two steps (6 or 12 inches) above the well. If an interpreter is necessary, the interpreter should be seated next to or slightly behind the witness and between the witness and the judge. The witness should remain the primary focus. A separate interpreter station, accommodating two staff persons may be required in some locations.

Spectator Seating

In a magistrate judge courtroom, seating should be provided for 55-60 persons. However, in cases involving multiple parties, this number may be lowered to accommodate trial participants. Additional seating may be accommodated in another courtroom through the use of an audio/video feed.

Refer to the "[General Requirements for All Courtrooms](#)" section of this chapter for more information regarding spectator seating.

Jury Box

In magistrate judge courtrooms, the jury for civil trials is determined in consultation with the court. Jury boxes for magistrate judges' courtrooms should accommodate 12 jurors. Although there may be instances where fewer or no juror seats are needed in a courtroom, it is recommended that the standard be used for uniformity to allow for courtroom sharing.

Table 4.4
Space Requirements for Magistrate Judge Courtrooms and Associated Spaces

Magistrate Judge Courtrooms and Associated Spaces		
Courtrooms	NSF	Nm ²
Magistrate Judge Courtroom	1,800	167.2
Associated Spaces	NSF	Nm ²
Public Waiting Area	400	27.8
Soundlock	80	7.4
Public/Attorney Coat Closet	20	1.9
Judges' Conference/Robing Room ¹	200	23.3
Attorney/Witness Room 1	150	14.0
Attorney/Witness Room 2	150	14.0
Court Reporter/Recorder Office	150	14.0
Court Reporter/Recorder Storage	50	4.7
Attorney Work Area ²	250	23.3
Attorney Waiting Area	100	9.3
Shared Work Room	100	9.3
Transcriber/Typist Workstation	48	4.5
Audiovisual Equipment Room	120	11.1
Equipment Storage Room	100	9.3
Exhibits Storage	50	4.7
Staff Toilets ³	-	-

¹ Provided when chambers are located on a separate floor. If a judges' conference/robing room is provided, a 56 NSF restroom may be programmed in addition to the 200 NSF space. Refer to the "Adjacency and Circulation" subsection of the "Magistrate Judge Courtrooms" section.

² Only one per courthouse, not per courtroom.

³ Total staff toilet requirements are to be determined in design by the International Plumbing Code, most current edition. Plumbing fixtures required to serve a given floor shall be proportionally split between the staff and public occupant loads.

A 12-member jury is typically selected from a panel of 45-60 potential jurors; a six-member jury is selected from 15-25 potential jurors. The number of potential jurors may equal 100 or more in cases with heavy media coverage, multiple parties, or lengthy trials. During impaneling, the potential jurors may be seated in the spectator area of the courtroom. These seats may be made available to the public after the jury has been impaneled.

Jurors should be able to see, hear, and be seen by the judge, attorneys, and witnesses. During witness examination, all jurors should be able to see the attorneys, litigants, and witnesses as close to full face as possible. In addition, there should be a clear line of sight to video evidence presentation monitors if they are used in the courtroom.

Jurors should be separated 6 feet (1,825 mm) from attorneys and litigants to prevent the overhearing of private conversations. The maximum allowable distance between a juror and a litigant sitting at a counsel table across the courtroom well is 40 feet (12,200 mm). In addition, jurors should be separated from the public to avoid interference or intimidation. At least 6 feet (1,825 mm) of space should separate the jury box and the rail dividing the spectator seating area and courtroom well.

The front row of the jury box may be raised one step (6 inches or 150 mm) or on the same floor level as the courtroom well. If the first row is one step above the well, a ramp shall be provided to allow unassisted access for jurors with disabilities using the same path as all other jurors. Gates and openings into the jury box, clear floor space, and vertical clearance shall allow for space to maneuver a wheelchair and for jurors with disabilities to participate from the same position as all other jurors. The front row may have a dedicated wheelchair space or a removable chair to provide the necessary space when needed.

The floor level of the highest tier of the jury box should be at least one step (6 inches or 150 mm) lower than that of the judge's bench. Jury box requirements should be discussed with your local court. The top tier of a jury box is recommended to be elevated a minimum of 6 inches above the finished well floor.

Attorney and Litigant Stations

At least one attorney is present on each side of the case. Trial attorneys may be assisted by paralegals and other staff, all of whom are positioned in the courtroom at the discretion of the presiding judge. In criminal cases, U.S. government attorneys may be assisted in court by case agents from the investigative agency involved. The number of litigants depends

entirely upon the number of parties and the nature and complexity of the case. For civil cases, the number of litigants on each side may range from one to 10, although more than 10 litigants is not unusual. In criminal cases, the number of defendants may range from one to 20, although cases with more than 20 defendants do occur. Generally, each defendant is represented by an attorney.

Attorney and litigant stations are not fixed; however, they are located within a defined area of the courtroom well. Attorneys and litigants should see and hear and be seen and heard by one another, the judge, witnesses, jurors, the courtroom deputy clerk, and the court reporter/recorder.

Each attorney/litigant table should have a work surface a minimum of 36 inches (915 mm) deep and 84 inches (2,150 mm) wide, allowing at least two linear feet per person. With the permission of the judge, attorneys may use portable computers at or next to counsel tables. An ABAAS-compliant movable, height-adjustable lectern should be provided for attorneys. Refer to the [Courtroom Technology Audiovisual Infrastructure Standard](#) for presentation requirements.

In magistrate judge courtrooms, attorneys and their clients should be able to confer in private at their courtroom stations without being overheard by jurors, the witnesses, opposing attorneys and litigants, spectators, or others in the courtroom. Attorneys should be able to move easily within the well of the courtroom.

U.S. Marshals Service

USMS personnel are responsible for the custody and movement of criminal defendants; the safety, security, and privacy of the judge, jurors, and witnesses; the security of the courtroom and safety of its occupants; and maintaining order in the courtroom. Typically, one or more USMS personnel are present in the courtroom. The total number of USMS personnel depends upon the nature of the matter being heard. In criminal cases, two USMS personnel may be present for each in-custody defendant in the courtroom.

USMS personnel should be able to see all participants and the public. Although USMS personnel generally do not have fixed workstations in the courtrooms, they are usually provided with chairs that may be moved to suit the needs of a proceeding. Infrastructure to provide audio and video feeds to the USMS command center should be provided.

Adjacency and Circulation

The most effective configuration of the courtroom floor minimizes the distance of movement and conflicting circulation patterns of trial participants ([Figure 4.4](#)). Efficient circulation around the courtroom, especially the separation of public and restricted circulation, is more readily achieved by locating the courtroom in the interior of the building. For an overview of this topic, refer to [Chapter 3, “Planning for U.S. Courthouses,”](#) for circulation factors.

Courtrooms

Typically, magistrate judge courtrooms should provide the following three types of access: (1) public circulation and access for spectators, news media representatives, attorneys, litigants, and witnesses; (2) restricted circulation and access for judges, law clerks, courtroom deputy clerks, court reporters/recorders, and jurors; and (3) secure circulation and access for prisoners and USMS personnel. These three circulation and access patterns should be separate to provide security for all groups. The courtroom should have separate entrances from restricted circulation for the judge; jury, courtroom deputy clerk, and court reporter/recorder; prisoners and USMS personnel; and the public. Entrances for the various groups should be located as close as possible to their stations in the courtroom. Courtrooms are separated from the public corridor by a soundlock.

Judges’ Conference/Robing Room

In a collegial design, conference/robing rooms should be located close to the courtroom and accessible from restricted circulation. Consideration should be given to designs that allow judges’ conference/robing rooms to be shared between two courtrooms.

Judges should have access to toilets convenient to the courtroom and accessible through restricted circulation. If necessary, a toilet may be programmed with the conference/robing room.

Attorney/Witness Room

Attorney/witness rooms should be directly accessible from public circulation. In some instances, access from restricted or secure circulation is also desirable. Restricted access provides a higher degree of privacy and security, especially for sensitive witnesses. An occupancy indicator should be provided for each room (e.g., a small sign or view panel adjacent to the door).

Attorney Work Room

The attorney work room may be directly accessible from an adjoining courtroom.

Court Reporter/Recorder Facilities







Court reporter/recorder facilities should generally be located near courtrooms. The facilities should be accessible primarily from restricted circulation areas; however, some public accessibility should also be provided to accommodate the public purchase of transcripts.

Figure 4.4
U.S. Magistrate Court Adjacency Relationships

Colors Legend:

 **Chapter 4**
Courtrooms and Associated Spaces

Symbols Legend:

-  Public Circulation
-  Public Vertical Circulation
-  Public Circulation
-  Restricted Vertical Circulation
-  Secure Circulation
-  Secure Vertical Circulation
-  Circulation Access Control Point

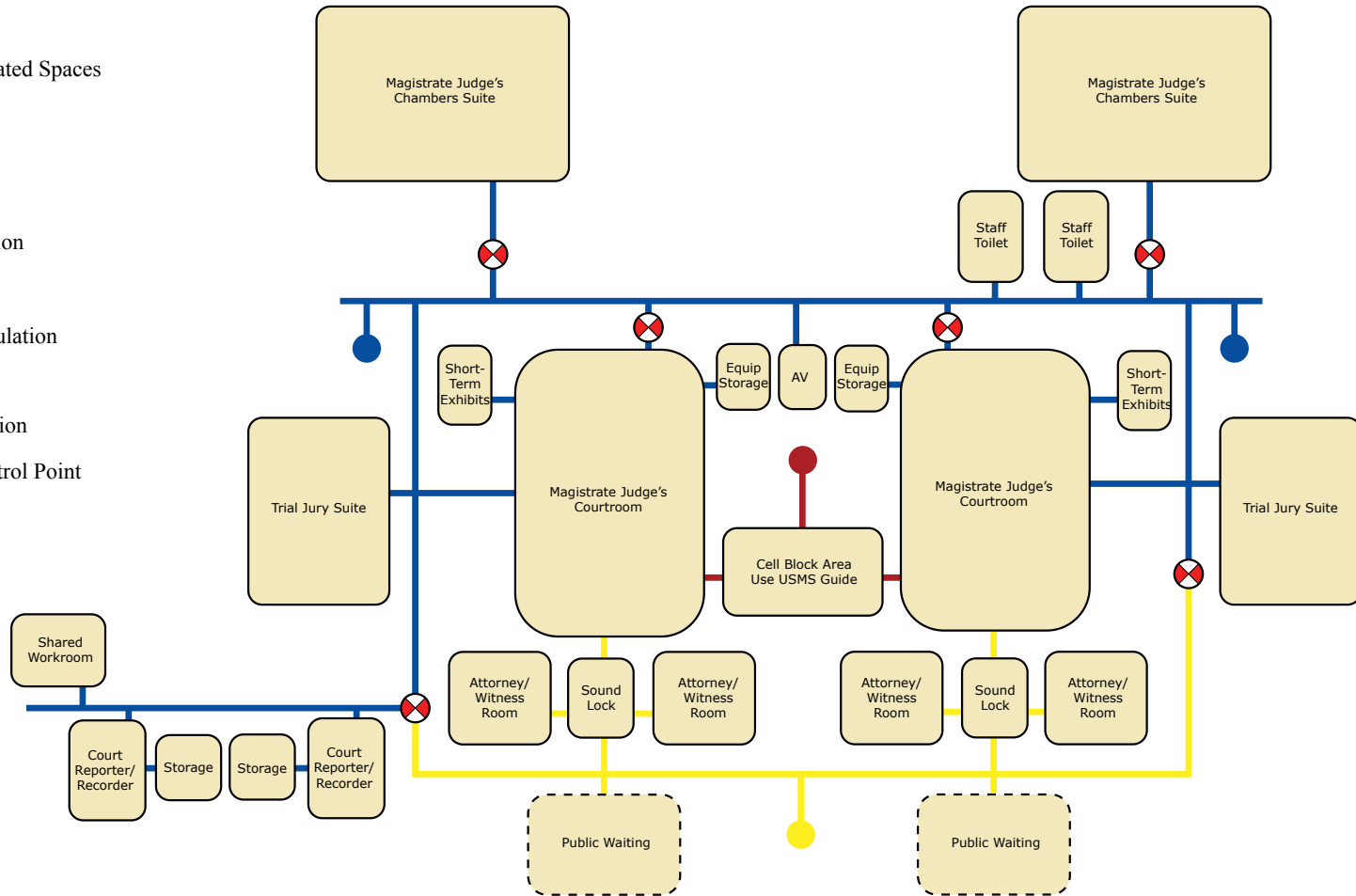

Note: The adjacency diagram is intended only as an illustration. Conference/robing room(s) are allowed where chambers are not on the same floor as the courtroom.

Bankruptcy Judge Courtrooms

Functions

Bankruptcy judges conduct hearings, bench trials, and, in rare situations, jury trials in civil proceedings relating to debtor-creditor relationships. Bankruptcy judges sometimes sit on bankruptcy appellate panels.

Proceedings conducted by bankruptcy judges typically require a well that accommodates a judge's bench, court personnel workstations, a witness box, at least two attorneys' tables, and seating for lawyers, creditors, debtors, plaintiffs, trustees, accountants, and interpreters. Space should also be allowed for the display of exhibits.

Courtroom Sharing

The Judicial Conference adopted a courtroom sharing policy for bankruptcy judges in new courtroom construction projects: (1) in court facilities with one or two bankruptcy judges, one courtroom will be provided for each bankruptcy judge; (2) in court facilities with three or more bankruptcy judges, one courtroom will be provided for every two bankruptcy judges; and (3) in court facilities where the application of this formula will result in a fraction (i.e., those with an odd number of bankruptcy judges), the number of courtrooms allocated will remain at the next lower whole number. In addition to the above, an additional courtroom will be provided for emergency matters, such as Chapter 11 first-day hearings. Refer to the *Guide to Judiciary Policy*, Vol. 16, Ch. 2, Section 230.30.

It is recommended that bankruptcy courtrooms in all new courthouses be designed in a uniform way so that they are interchangeable for courtroom sharing. In situations where bankruptcy judges will be housed in the same courthouse as district and magistrate judges and courtrooms will be shared among all judges, courtrooms should be designed with jury boxes, to allow for greater courtroom sharing among all judges. If a jury box and associated facilities are added into a bankruptcy court, the Judiciary is responsible for the additional costs. A court, with the approval of its circuit judicial council, may seek an exemption to the courtroom sharing policy from the Committee on Space and Facilities if the required sharing arrangement inhibits the effective and efficient disposition of cases. Such exemptions should be considered the exception and not the rule. Refer to the *Guide to Judiciary Policy*, Vol. 16, Ch. 2, Sec. 230.20.

Additionally, consideration should be given to duplicate network connectivity in shared courtrooms of different types. Refer to the *Courtroom Technology Audiovisual Infrastructure Standard* for additional information.

Judges' Conference/Robing Room

The conference/robing room is an associated space for bankruptcy judge courtrooms when chambers are located in an area remote from the courtroom (i.e., collegial design).

Conference/robing rooms are used for private conferences with attorneys during brief trial recesses, and as a place for trial court judges to store robes and prepare to enter the courtroom. Consideration should be given to designs that allow judges' conference/robing rooms to be shared between two courtrooms. Infrastructure should be provided to support audio and video feeds and display from the courtroom.

Design Requirements for Bankruptcy Judge Courtrooms

Design requirements for each court position are listed below. Courtroom and associated space requirements for bankruptcy judge courtrooms are listed in [Table 4.5](#).

Judge's Bench

A single judge presides over bankruptcy proceedings. Refer to the "[General Requirements for All Courtrooms](#)" section of this chapter for more information regarding the judge's bench.

Courtroom Deputy Clerk Station

The courtroom deputy clerk typically is responsible for tracking all court activity during the proceedings, including the order of cases called, as well as documenting decisions by the court and tagging and caring for exhibits. The deputy clerk often confers with the judge during proceedings.

Refer to the "[General Requirements for All Courtrooms](#)" section of this chapter for more information regarding the courtroom deputy clerk station.

Law Clerk Station

The law clerk provides research assistance to the judge and attends courtroom proceedings.

Refer to the "[General Requirements for All Courtrooms](#)" section of this chapter for more information regarding the law clerk station.

Court Reporter/Recorder Station

The court reporter/recorder records court proceedings. The court reporter/recorder should be able to see the facial expressions of witnesses, attorneys, and the judge, and hear every word spoken. Thus, the court reporter/recorder station should be located close to the witness box. In addition, they should be able to see and hear electronic evidence presentation materials.

Some court reporting/recording technologies require a work surface as part of the station. Work surfaces should be sized to satisfy the requirements of the specific technologies used. The workstation should include a modesty panel.

A lockable, built-in cabinet should be provided for stenographic equipment. Provision of an electrical outlet in the cabinet should be considered to allow the battery of the stenographic equipment to be charged while in storage. In addition, a cabinet with an adjustable shelf and a drawer should be provided for recording equipment. The drawer

should be at least 6 inches (150 mm) high and lockable. The cabinet should be provided in a location convenient to the court staff operating the recording equipment.

Furniture and other equipment used by the court reporter/recorder should be movable so that it may be rearranged easily to suit each court reporter or judge.

Witness Box

Witnesses are routinely called to testify in trials. An interpreter is furnished if required by a witness. Witnesses should be able to see and hear, and be seen and heard, by all court participants as close to full face as possible. The witness box should accommodate one witness and an interpreter, and the preferences of the presiding judge. Witnesses in the box receive, examine, and return exhibits. In addition, the witness should be able to see and hear electronic evidence presentation materials

The witness box is recommended to be raised one or two steps (6 or 12 inches) above the well. If an interpreter is necessary, the interpreter should be seated next to or slightly behind the witness and between the witness and the judge. The witness should remain the primary focus. A separate interpreter station accommodating two staff persons may be required in some locations.

Spectator Seating

Spectator seating should be provided for 75-82 people. However, in “mega” proceedings, this number may be lowered to accommodate trial participants. Additional seating may be accommodated in another courtroom through the use of an audio/video feed.

Refer to the “[General Requirements for All Courtrooms](#)” section of this chapter for more information regarding spectator seating.

Jury Box

Juries are rarely used in USBC proceedings. However, in situations where bankruptcy judges will be housed in the same courthouse as district and magistrate judges and courtrooms will be shared among all judges, it is recommended that courtrooms be designed in a uniform way, with jury boxes, to allow for greater courtroom sharing. However, if not housed in the same courthouse, an available magistrate and district judge courtroom in another location should be used for all trials that require a jury. In this situation, no jury box is provided in a bankruptcy judge’s courtroom.

Attorney and Litigant Stations

At least one attorney is present on each side of the case. Other supporting legal staff may be present at the discretion of the presiding judge. The U.S. Trustee may also be represented. The number of litigants varies from two to 20 or more; however, no criminal defendants are present.

Attorney and litigant stations are not fixed; however, they are located within a defined area of the courtroom well. Each attorney/litigant table should have a work surface a minimum of 36 inches (915 mm) deep and 84 inches (2,150 mm) wide, allowing at least two linear feet per person. With the permission of the judge, attorneys may use portable computers at or next to counsel tables. A movable, ABAAS-compliant height-adjustable lectern should be provided for attorneys. Refer to the [Courtroom Technology Audiovisual Infrastructure Standard](#) for presentation requirements.

U.S. Marshals Service

In certain instances, USMS personnel will be present. When present, USMS personnel should be able to see all participants and the public. Although USMS personnel generally do not have fixed workstations in the courtrooms, they are usually provided with chairs that may be moved to suit the needs of a proceeding. Infrastructure to provide audio and video feeds to the USMS command center should be provided.

Special Considerations

USBC “Mega Proceedings”

“Mega proceedings” require bankruptcy judge courtrooms larger than 1,800 net square feet (NSF) or 167.2 net square meters (Nm²). Courts should develop procedures for the routine use of district judge courtroom space to accommodate these large, complex bankruptcy proceedings. In unusual circumstances, a bankruptcy courtroom of 2,400 NSF (223 Nm²) may be programmed, but only if requested by the court and approved by the respective circuit judicial council and the Committee on Space and Facilities. A courtroom of this type may be considered at a location with more than one resident bankruptcy judge if the USBC is not located in the same building as the USDC and there is a need to accommodate mega proceedings on a regular basis. Consult with the AOUSC for further information.

A cooperative arrangement between the USDC and USBC should ensure that jury facilities are available to the USBC when needed.

Adjacency and Circulation

The most effective configuration of the courtroom floor minimizes the distance of movement and conflicting circulation patterns of participants ([Figure 4.5](#)). Efficient circulation around the courtroom, especially the separation of public and restricted circulation, is more readily achieved by locating the courtroom in the interior of the building. For an overview of this topic, refer to [Chapter 3, “Planning for U.S. Courthouses,”](#) for circulation factors.

Table 4.5
Space Requirements for Bankruptcy Judge Courtrooms and Associated Spaces

Bankruptcy Judge Courtrooms and Associated Spaces		
Courtrooms	NSF	Nm ²
Bankruptcy Judge Courtroom	1,800	167.2
Associated Spaces	NSF	Nm ²
Public Waiting Area	400	27.8
Soundlock	80	7.4
Public/Attorney Coat Closet	20	1.9
Judges' Conference/Robing Room ¹	200	23.3
Attorney/Witness Room 1	150	14.0
Attorney/Witness Room 2	150	14.0
Court Reporter/Recorder Office	150	14.0
Court Reporter/Recorder Storage	50	4.7
Attorney Work Area ²	250	23.3
Attorney Waiting Area	100	9.3
Shared Work Room	100	9.3
Transcriber/Typist Workstation	48	4.5
Audiovisual Equipment Room	120	11.1
Equipment Storage Room	100	9.3
Exhibits Storage	50	4.7
Staff Toilets ³	-	-

¹ Provided when chambers are located on a separate floor. If a judges' conference/robing room is provided, a 56 NSF restroom may be programmed in addition to the 200 NSF space. Refer to the "Adjacency and Circulation" subsection of the "Bankruptcy Judge Courtrooms" section.

² Only one per courthouse, not per courtroom.

³ Total staff toilet requirements are to be determined in design by the International Plumbing Code, most current edition. Plumbing fixtures required to serve a given floor shall be proportionally split between the staff and public occupant loads.

Courtrooms

Typically, bankruptcy judge courtrooms should provide the following two types of access: (1) public circulation and access for spectators, news media representatives, attorneys, litigants, and witnesses; and (2) restricted circulation and access for judges, law clerks, courtroom deputy clerks, and court reporters/recorders. These two circulation and access patterns should be separate to provide security for both groups. The courtroom should have separate entrances for the judge; the jury, courtroom deputy clerk, and court reporter/recorder; and the public. Entrances for the various groups should be located as close as possible to their stations in the courtroom. Courtrooms are separated from the public corridor by a soundlock.

Judges' Conference/Robing Room

In a collegial design, conference/robing rooms should be located close to the courtroom and accessible from restricted circulation.

Judges should have access to toilets convenient to the courtroom and accessible through restricted circulation. If necessary, a toilet may be programmed with the conference/robing room.

Attorney/Witness Room

Attorney/witness rooms should be directly accessible from public circulation. In some instances, access from restricted or secure circulation is also desirable. Restricted access provides a higher degree of privacy and security, especially for sensitive witnesses. An occupancy indicator should be provided for each room (e.g., a small sign or view panel adjacent to the door).

Attorney Work Room

The attorney work room may be directly accessible from an adjoining courtroom.

Court Reporter/Recorder Facilities





Court reporter/recorder facilities should generally be located near courtrooms. The facilities should be accessible primarily from restricted circulation areas; however, some public accessibility should also be provided to accommodate the public purchase of transcripts.

Figure 4.5
U.S. Bankruptcy Court Adjacency Relationships

Colors Legend:

 **Chapter 4**
Courtrooms and Associated Spaces

Symbols Legend:

-  Public Circulation
-  Public Vertical Circulation
-  Restricted Circulation
-  Restricted Vertical Circulation
-  Circulation Access Control Point

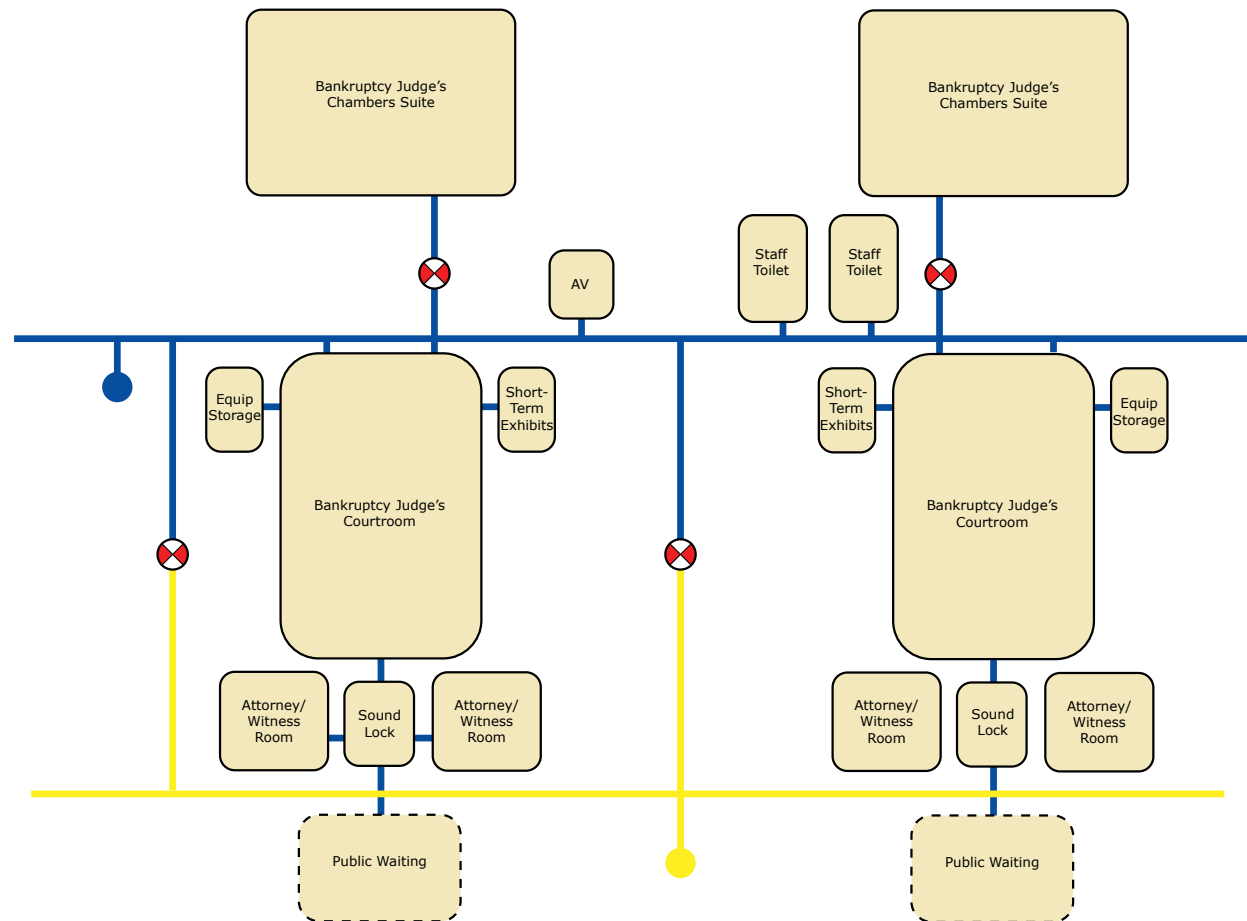

Note: The adjacency diagram is intended only as an illustration.



JURY FACILITIES

This chapter applies to the areas of the courtroom designed to accommodate the jury selection and deliberation process, including jury assembly areas, trial jury suites, and the grand jury suite. It describes jury functions and activities, users and capacities, design requirements, and space allocation requirements, and contains adjacency diagrams.

Chapter Topics:

- Supporting Documents
- Programming and Budgetary Notes
- Functions and Activities
- Users and Capacities
- Design Requirements
- Adjacency and Circulation

Chapter Figures and Tables:

Figure 5.1	Jury Assembly Suite Adjacency Relationships
Figure 5.2	Trial Jury Suite Adjacency Relationships
Figure 5.3	Grand Jury Suite Adjacency Relationships
Table 5.1	Ceiling Requirements for Jury Facility Spaces
Table 5.2	Space Requirements for Jury Facility Spaces

Supporting Documents

A comprehensive guide to supporting documents can be found in [Chapter 2, “Courthouse Programming and Budgetary Considerations.”](#) That listing includes program and design criteria, courthouse planning and related guidelines, policies, and information on many facets of the design and construction of federal courthouses. The reference listed below relates specifically to this chapter.

- *United States Courts, Courthouse Design Reference Manual: An Architect’s Desk Reference*, most current edition, Chapter 7.

Programming and Budgetary Notes

Programming and budgetary notes found throughout the *Design Guide* provide assistance with decisions to be made during the development of courthouse projects. The notes include both judicial branch policy and lessons learned from completed projects. The notes supplement the criteria in the *Design Guide*; their purpose is to provide direction in using the flexibility of the *Design Guide* to develop justifiable and cost-effective federal courthouse projects.

Space Envelope Flexibility

A total space envelope for new space will be calculated using appropriate circulation factors, allowances for support-type spaces, and the space standards described in the *Design Guide*. Courts have the flexibility to configure space within the envelope to meet their local needs. However, design and construction should be in general compliance with the square footage standards designated in the *Design Guide* in the space and ceiling requirements tables. If the court unit wishes to significantly change the space standards described in the space and ceiling requirements tables without exceeding the total envelope of space for the unit, it must seek approval from its respective circuit judicial council.

The space envelope for a respective court unit is defined as:

- Entire clerk’s office
- Entire probation office
- Entire pretrial services office
- Entire staff attorney’s office
- Entire circuit executive’s office
- All courtrooms designated by judge type (circuit judges, district judges, magistrate judges, and bankruptcy judges)
- All chambers designated by judge type (circuit judges, district judges, magistrate judges, and bankruptcy judges)

For existing space, courts have the flexibility to configure space within the existing envelope to meet their local needs. However, any significant departure from the square footage standards designated in the *Design Guide* in the space and ceiling requirements tables must be approved by the respective circuit judicial council. This does not mean that existing space must be changed to meet *Design Guide* standards. Only new construction completed as part of a renovation should be considered.

Renovations and Alterations (R&A)

Many of the construction projects conducted in the Judiciary are renovations to existing space. Although the *Design Guide* applies to these projects, it is understood that some standards in the *Design Guide* are difficult or impossible to achieve in existing space, particularly in historic buildings. Courts should consult [Chapter 17, “Renovations and Alterations \(R&A\),”](#) and [Facilities Standards for the Public Buildings Service \(GSA PBS P-100\)](#) for guidance in these circumstances. References to R&A guidelines are also included throughout the *Design Guide* where appropriate.

Exceptions to the *Design Guide* Standards

The *Design Guide* provides guidance on standards for courthouse construction and renovations to existing space. Any significant departure from these standards is considered an exception and must be approved by the respective authority as outlined below.

Authority of the Circuit Judicial Councils

Circuit judicial councils play an important space-management role by reviewing district-wide facility plans, approving requests for new or modified space, and enforcing adherence to design guidelines. The circuit judicial councils have authority over, and responsibility for, a circuit’s space-management program (28 USC §332 and §462(b)) and for determining the need for space. As directed by the Judicial Conference of the United States (JCUS), any significant departure from the standards in the *Design Guide* must be approved by the respective circuit judicial council.

Authority of the Committee on Space and Facilities

The authority to approve the following exceptions to the *Design Guide* standards rests with the Committee on Space and Facilities: (1) exceeding the total envelope for either the court unit or the project as a whole, (2) changing the standard configurations for judges’ chambers and courtrooms, and (3) exceeding the plumbing standards. If the Committee on Space and Facilities disagrees with a circuit judicial council request for one of these exceptions, the Judicial Conference will decide whether to grant the exception.

Authority of the Judicial Conference

The authority for approving any exception to prospectus-level courthouse projects that would result in additional estimated costs, including additional rent payment obligations, lies with the Judicial Conference. Approval is required, after review by the Committee

on Space and Facilities, for any exception to the *Design Guide* approved by a circuit judicial council. The request must include (1) a justification for the exception and (2) a construction cost estimate. [All approved exceptions for prospectus-level projects](#) are reported to the General Services Administration (GSA) and Congress. Approved exceptions may require the project to be reauthorized by Congress if the exception had not been previously identified. Contact the Administrative Office of the U.S. Courts (AOUSC) for more detailed information.

For prospectus-level courthouse projects, if an exception is approved by the JCUS which would result in additional estimated costs, the chair of the circuit's space and facilities committee or the chief judge or other judge designated by the court that sought the exception that exceeds the *Design Guide* criteria must be willing, if requested by the Committee on Space and Facilities, to appear before Congress concerning funding for such construction.

General Programming Notes

The *Design Guide* is intended to be a performance document. Criteria for any space or grouping of spaces should be considered in conjunction with the specific needs of the court office or function for which space is being designed.

Criteria in the *Design Guide* do not represent space entitlements. The criteria apply to an array of space types that should be justified based on the specific purpose of each project. Facility plans, programs, and designs should include only the space needed to satisfy the functional and security requirements of the court.

Differences between the space in an existing facility and the criteria in the *Design Guide* are not justification for facility alteration and expansion. In such cases, alternatives to space expansion are investigated before any additional space is requested. In addition, like-for-like space is not a guarantee. Space allocated in an existing location is not justification for the same amount of space in a new location if the space allocation is not warranted. Current needs should be evaluated when moving into new space to determine the appropriate space envelope. Any additional space must be approved by the appropriate authority. Design architects and court staff are prohibited from adding spaces not originally contemplated in the approved prospectus or design program. Increasing the floor area or building volume requires the necessary approvals.

General Budgetary Notes

Renovation and new construction occur when the court and circuit judicial council identify space needs through the Judiciary's asset management planning process and document these needs in the long-range facilities plan. GSA determines by what method the space is provided—for example, by the construction of a new building, the renovation of an existing building, a lease, or other means.

The Judicial Conference recognizes and strongly supports a pragmatic approach to design that includes the use of durable and sustainable materials. This approach ensures that courthouses constructed now will last well into the future.

Following the publication of the *2007 Design Guide*, the Judiciary introduced several cost-saving measures, such as courtroom sharing and the Integrated Workplace Initiative (IWI), that sought to provide flexibility and efficiency in court spaces while preserving the dignity of the Judiciary. Courtroom sharing for certain judge types is now a standard throughout the Judiciary, and IWI is recognized as an alternative to traditional office design. For more information on cost- and space-saving efforts and programs, contact the AOUSC Space and Facilities Division.

General Space Notes

Multiuse Jury Facilities

Jury facilities are generally used intermittently. Courthouse programs should consider multiuse opportunities for jury facilities, including but not limited to training, conferences, and alternative dispute resolution. Jury assembly areas may be equipped with movable walls to facilitate use for other activities. Alternate functions should be considered when determining furnishings and equipment.

Size of Jury Deliberation Rooms

The size of the trial jury deliberation room is dependent upon the type of court. Jury deliberation rooms for district court judge courtrooms are 350 net square feet (NSF) (32.5 net square meters (Nm²)) and 250 NSF (23.2 Nm²) for magistrate judge courtrooms. One trial jury deliberation room at 500 NSF shall be provided for every four district judge courtrooms. In buildings with fewer than four district judge courtrooms, one of the jury deliberation rooms to be constructed shall be 500 NSF. If a multi-party courtroom is planned, the 500 NSF jury deliberation room shall be placed adjacent to it.

Jury Facilities for Bankruptcy Judges

A cooperative arrangement between the U.S. District Court (USDC) and U.S. Bankruptcy Court (USBC) ensures that jury facilities will be available to the USBC when needed. Jury facilities shall not be incorporated into the USBC courtroom unless included as discussed in [Chapter 4 \(Courtroom sharing\)](#).

Functions and Activities

In criminal cases, the Sixth Amendment to the United States Constitution guarantees the right to a speedy and public trial by an impartial jury. In civil cases, the Seventh Amendment to the United States Constitution guarantees the right to a jury trial in lawsuits for damages. Although the judge decides the law in the case and instructs the jury on the

law, it is the jury's role to decide the facts in the case and apply the law on which the judge has instructed it to reach a verdict. In cases in which there is contradictory evidence, it is the jury's job to resolve the conflict and decide what really happened.

Broadly speaking, there are two types of juries. A trial jury, which is also called a petit jury, serves in both criminal and civil trials as described above. In federal criminal cases, there are usually 12 jurors and 2-6 alternate jurors. Alternate jurors replace jurors who become ill, disqualified, or unable to perform their duties. In federal civil cases, there are 6-12 jurors. Unlike criminal cases, civil cases do not have alternate jurors.

A grand jury is a group of citizens who listen to evidence of criminal activity presented by the government in order to determine whether there is enough evidence to justify issuing an indictment, in which they charge the defendant with a crime. Federal grand juries have 16-23 members. Unlike petit jurors, who are selected to serve on one trial only, grand jurors serve 1-3 years, sitting one or two days a week, and may hear evidence in many different cases.

Congress requires that each district court develop a plan for selecting jurors. Generally, the selection process begins when the clerk of court randomly draws names from the list of registered voters in the judicial district, and sometimes from other sources, such as the list of licensed drivers. This selected group is called the master wheel. The clerk then sends questionnaires to all the people on the master wheel to determine whether they meet the requirements for jury service. People who fall into certain categories may ask to be excused at this point. The group found eligible to serve and not excused is called the qualified wheel.

The jury administrator then chooses by random means a group of prospective jurors from the qualified wheel, who receive a summons to appear at the courthouse to serve on juries as trials are scheduled. Potential jurors must either wait in the courthouse jury assembly suite or remain available to be used as grand or petit jurors during their term of service. When a jury is needed for a trial, a part of this group, or a panel of potential jurors, is chosen and sent to the courtroom. The trial jurors for the case are then selected from the panel, in the courtroom, during a question-and-answer process called *voir dire*.

Once a petit jury has been selected for a criminal or civil trial, the lawyers for both sides give their opening statements to provide the jury an overview of the evidence they will present. After the evidence has been presented, the lawyers for each side make their closing arguments to the jury to review the most important features of each side's case.

Before or following the closing arguments, the judge gives instructions to the jury, explaining the relevant law, how the law applies to the case being tried, and what questions the jury must decide. After receiving its instructions from the judge, the jury retires to the trial jury suite to discuss the evidence and to reach a verdict (a decision on the factual issues in the case).

A grand jury is different from a trial or petit jury. A grand jury determines whether sufficient evidence exists for a person to be tried for a crime; a petit jury listens to the evidence presented at the trial and determines whether the defendant is guilty of the charge. Also, grand jury proceedings are held *ex parte*, or government only, while a petit jury trial is public.

A criminal case formally begins with an indictment or information. An indictment may be obtained when a lawyer for the executive branch of the U.S. government—the U.S. attorney or an assistant U.S. attorney, also referred to as the prosecutor—presents evidence to a federal grand jury that, according to the government, indicates a person committed a crime. The U.S. attorney tries to convince the grand jury that there is enough evidence to show that the person probably committed the crime and should be formally accused of it. If the grand jury agrees, it issues a formal accusation, called an indictment. After the indictment is issued, the accused person (the defendant) is summoned to court or arrested (if not already under arrest), depending upon the severity of the crime.

The major functions of courthouse spaces designed to accommodate juries are as follows.

Jury Assembly Suite

Potential jurors receive orientation in the jury assembly area and wait there to be called to a courtroom for jury selection. Jurors often spend long periods waiting; therefore, comfortable and appropriate facilities are needed. Because the jury assembly area significantly impacts the jurors' perception of the justice system, it must reflect the importance of jury service to the administration of justice.

Trial Jury Suite

The jury uses the trial jury suite throughout the trial and during deliberations at the conclusion of the trial. The deliberations of a trial jury must be strictly confidential. During deliberations, the jury discusses testimony, exhibits, and other materials. If audiovisual (AV) or graphical displays were used during the proceedings, the displays may also be reviewed during deliberations. Trial jury deliberations may vary in length from less than an hour to several days.

Grand Jury Suite

The U.S. attorney uses the grand jury suite to present evidence and witnesses before grand jurors, who then decide whether to return an indictment. Deliberating grand jurors and waiting witnesses must be accommodated in separate, adjacent spaces. Jurors take notes and ask questions during the proceedings.

Table 5.1
Ceiling Requirements for Jury Facility Spaces

Space Name	Ceiling Height (feet)	Ceiling Height (mm)
Jury Assembly ¹	12	3,000
Trial Jury Suite	10	3,000
Grand Jury Hearing Room ²	11	3,350

¹ The ceiling height for jury assembly may exceed the maximum if located on a floor with a higher floor-to-floor height.

² 11'-0" above the highest tier of juror seating.

Users and Capacities

Jury Assembly Suite

The number of users varies, depending on the number of clerical staff, potential jurors (usually between 60 and 200), and the number of cases set for trial in the facility.

Trial Jury Suite

In district judge cases, users consist of up to 18-member juries (12 jurors plus 2-6 alternates). In magistrate judge cases, users consist of up to 12 jurors.

Grand Jury Suite

Users consist of 16-23 jurors, U.S. attorney personnel, witnesses, the foreperson, the secretary, and the court reporter/recorder.

Design Requirements

The design requirements for jury facilities outlined in this chapter are detailed in the following information. Specific space requirements may be found in [Table 5.1](#), [Table 5.2](#) and the room data sheets.

Ceiling Height

The ceiling is a designed surface. It may be uniformly flat, or it may have two or more planes and include elements such as soffits, perimeter coves, recesses, and reveals as

required to integrate HVAC and lighting into a harmonious design. An adjustment of a ceiling surface may also occur where it meets an exterior curtain wall to accommodate different equipment. In situations where there are several different surfaces at different heights above the finished floor, there may be different ways of determining which one is the dominant plane. Ceiling heights should be measured from the finished floor to the dominant surface that either covers the most amount of ceiling square footage, or the surface that defines the overall character of the ceiling design. The design team must ensure that in all newly constructed spaces the dominant plane of the ceiling does not exceed the maximum ceiling height listed in the *Design Guide*. Dominant planes that exceed these maximum heights are considered an exception unless the space is in an area envisioned for a future courtroom or on a floor with a higher floor-to-floor height. The application of this maximum ceiling height in renovation and alteration projects may be dependent on limitations of existing conditions.

The ceiling height must be in proportion to the area of the space. If the space is located on a floor with a higher floor-to-floor height, the ceiling height of the room may be designed to maximize use of available natural light, volume, and window configuration of that space. Ceiling heights above the finished floor for jury facility spaces shall be in accordance with the maximum ceiling heights listed in [Table 5.1](#).

Jury Assembly Suite

In the jury assembly area, a jury clerk station is provided near the check-in counter in the reception area. The workstation must accommodate a desk and movable chair.

Storage must be provided for jurors' personal belongings (i.e., coats, hats, handbags), preferably in or near the entrance vestibule.

Exterior windows in the jury assembly area, lounges, and staff work areas are encouraged.

Technology requirements vary depending on the size and multi-use functions. Refer to the *Courtroom Technology Audiovisual Infrastructure Standard* for specific requirements and recommendations.

Trial Jury Suite

In the trial jury suite, a sworn-jury custodian station must be provided outside the soundlock entrance. The station must accommodate a work surface with a drawer and an armchair located to allow visual surveillance of the circulation areas leading to the trial jury suite.

Storage must be provided for jurors' personal belongings (i.e., coats, hats, handbags), preferably in or near the entrance vestibule. Lockable cabinets must be provided for exhibits, audiovisual equipment, and supplies that must be left in the room.

Table 5.2
Space Requirements for Jury Facility Spaces

Jury Assembly Suite	NSF	Nm ²
Check-In	100	9.3
Jury Clerk's Office, per clerk	100	9.3
Coat Closet ¹		
Jurors' Toilets	56	5.2
Service Unit	200	18.6
Vending Area, per machine	15	1.4
Juror Lounge, per person ²	20	1.9
Orientation Area, per person	10	0.93
Equipment Storage	150	13.9
Supplies Storage (minimum space)	50	4.7
Trial Jury Suite	NSF	Nm ²
Soundlock Entry	50	4.7
Sworn-Jury Custodian Station	48	4.5
Jurors' Toilets (Two Toilets @ 56 NSF each)	112	10.4
Coat Closet	20	1.9
Trial Jury Room (Multi-Party Courtroom) ³	500	46.4
Trial Jury Room (District Judge Courtrooms) ³	350	32.5
Trial Jury Room (Magistrate Judge Courtrooms) ³	250	23.2
Service Unit	20	1.9
Exhibits Display	50	4.7
Video Equipment Closet	10	0.93

Grand Jury Suite	NSF	Nm ²
Entry Area	50	4.7
Security Workstation	48	4.5
Jurors' Toilets (Two Toilets @ 56 NSF each)	112	10.4
Service Unit	20	1.9
Witness Room (min/max)	120/200	11.1/18.6
Hearing Room	700	65
Video Equipment Closet	10	0.93
Closet	20	1.9

¹ Provide 3 linear inches of coat space (75 mm) per juror.

² Provide jury lounge space for 20 percent of jurors.

³ One jury deliberation room at 500 NSF (46.4 Nm²) shall be provided for every four district judge courtrooms. In courthouses with fewer than four district courtrooms, one of the jury deliberation rooms to be constructed shall be 500 NSF (46.4 Nm²). If a multi-party courtroom is planned, the 500 NSF (46.4 Nm²) jury deliberation room shall be adjacent.

For trial jury suites located above the ground floor, exterior windows are recommended. For trial jury suites on the ground level, provision of indirect daylight through clerestory windows or other design features that maintain security and confidentiality should be considered. In both cases, lighting should be controlled with blinds or drapes.

Technology requirements vary depending on multi-use functions. At a minimum, it is recommended that power, raceway, and blocking be provided to support a large screen display to be used for evidence review or for staff conferences.

Grand Jury Suite

In the grand jury suite, a court security workstation at the entry reception area must be provided. The workstation must accommodate a work surface with a drawer(s) and a swivel-base armchair.

Storage must be provided for jurors' personal belongings (i.e., coats, hats, handbags), preferably in or near the entrance vestibule. Lockable cabinets must be provided for exhibits, audiovisual equipment, and supplies that must be left in the room.

Unlike the other types of jury suites, the grand jury hearing room typically contains tiered juror seating and work surfaces. The tiered juror seating may be arranged in either two or three tiers. Optionally, courts with space limitations and restrictions may utilize movable furniture instead of fixed, tiered seats. Refer to the grand jury hearing room room data sheet for more information and an alternate room layout.

To help maintain security and privacy, grand jury suites should not have windows; however, if windows are provided, opaque shades must be installed.

Technology requirements vary depending on multi-use functions. At a minimum, an audio system and assistive listening system (ALS) are typically provided. Refer to the [Courtroom Technology Audiovisual Infrastructure Standard](#) for specific requirements and recommendation.

Adjacency and Circulation

Jury Assembly Suite

The jury assembly area must be easy to find from public entrances and must be conveniently accessible to all jury courtrooms. A reception area located outside the assembly space must be provided. A set of barrier-free toilet facilities for the exclusive use of jurors may be provided inside the space through a soundlock. Access to the courtrooms may be through either public or restricted circulation.

With a growing need for multipurpose space within the courthouse, the jury assembly area is permitted to be located on the first floor of the courthouse with direct public access from the main lobby within the secure perimeter. This optional location for the suite encourages the multi-use of the jury assembly area and better supports other public gathering requirements.

Overall size varies, but the assembly area requires 10 NSF (0.93 Nm²) per person for the number of people expected to be called for jury service. In addition, 20 NSF (1.9 Nm²) per person for 20 percent of the prospective jurors must be provided for a lounge area. The suite must accommodate the necessary furniture with sufficient room for unencumbered movement. The ceiling height must be in proportion to the area of the space. For further detail and the sizes of jury spaces, refer to [Table 5.1](#) and [Table 5.2](#).

Trial Jury Suite

Jurors must access the trial jury suite from public circulation through a controlled access point into a restricted corridor. The jury must not pass through the public seating area of the courtroom when moving to or from the trial jury suite; instead, jurors must access the courtroom directly from the trial jury suite or through a restricted corridor. Trial jury suites must not be located where the public, attorneys, and litigants can see, hear, or gain access to jurors. During deliberations, access to the suite is strictly controlled by the sworn-jury custodian.

Grand Jury Suite

The grand jury suite must be accessible through public circulation, with an entrance controlled by U.S. Marshals Service (USMS) personnel. The suite must be easily accessible to U.S. attorney staff without requiring them to enter the court's restricted access areas. The suite must be located in an area with light public traffic, and on a floor not occupied by courtrooms. Protected and in-custody witnesses must enter this area through the USMS secure circulation system. During grand jury hearings, the suite must be secure.

Adjacency diagrams ([Figures 5.1-5.3](#)) are located on the following pages. The number of spaces shown on the adjacency diagrams are intended only as an illustration; the actual number of spaces required for a specific facility is determined in the building program.









The design team should refer to [Chapter 3, "Planning for U.S. Courthouses,"](#) for circulation factors.

Figure 5.1
Jury Assembly Suite Adjacency Relationships

Colors Legend:

 **Chapter 5**
Jury Facilities

Symbols Legend:

-  Public Circulation
-  Public Vertical Circulation
-  Restricted Circulation
-  Restricted Vertical Circulation
-  Secure Circulation
-  Secure Vertical Circulation
-  Service Vertical Circulation
-  Circulation Access Control Point

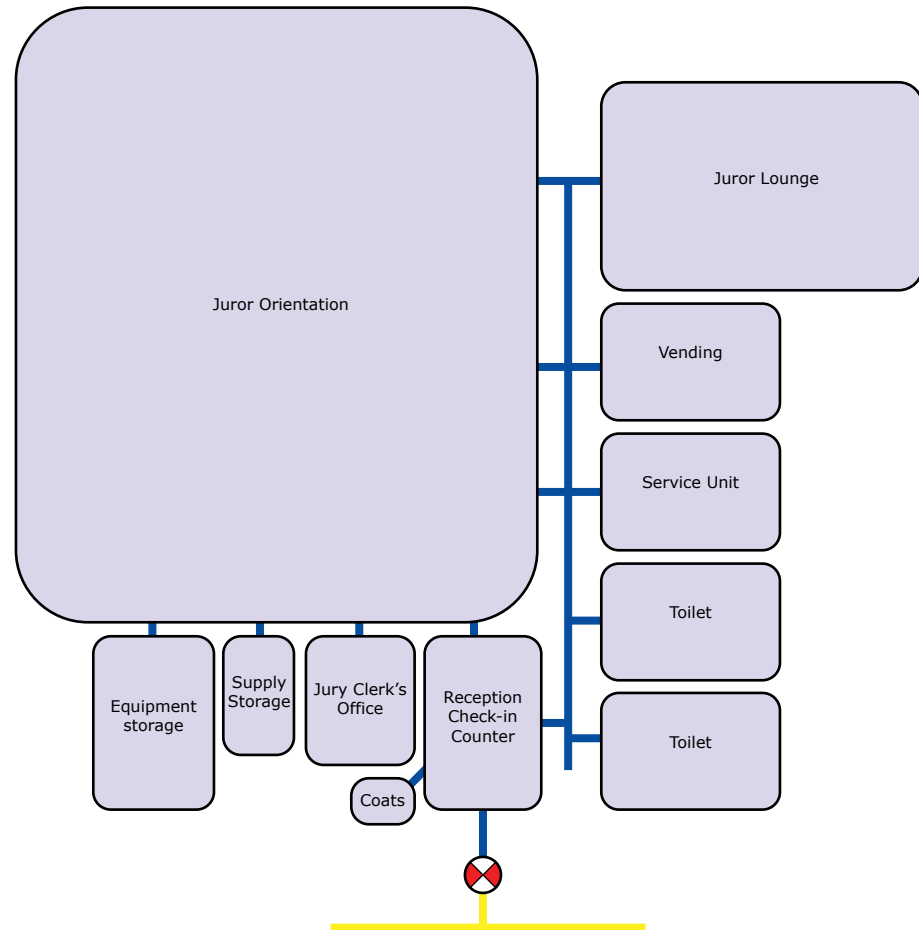

Note: The adjacency diagram is intended only as an illustration.









Figure 5.2

Trial Jury Suite Adjacency Relationships

Colors Legend:

 **Chapter 5**
Jury Facilities

Symbols Legend:

-  Public Circulation
-  Public Vertical Circulation
-  Restricted Circulation
-  Restricted Vertical Circulation
-  Secure Circulation
-  Secure Vertical Circulation
-  Service Vertical Circulation
-  Circulation Access Control Point

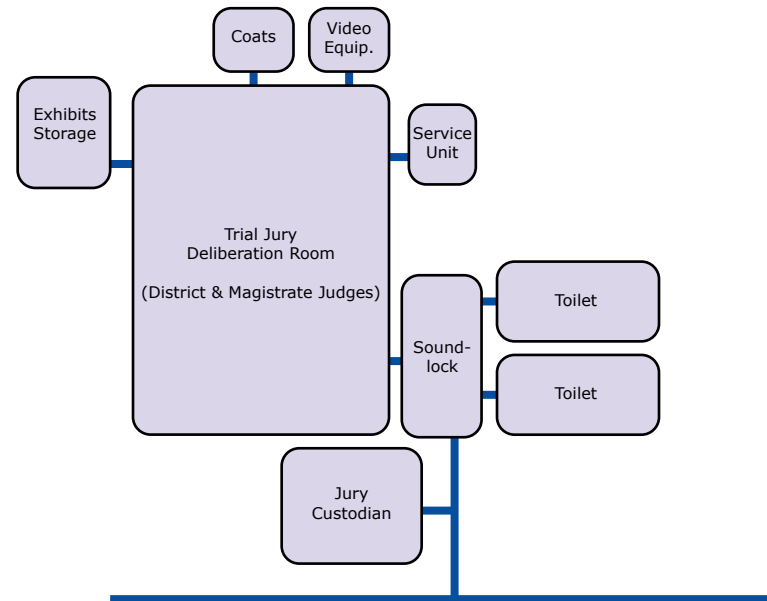









Note: The adjacency diagram is intended only as an illustration.

Figure 5.3
Grand Jury Suite Adjacency Relationships

Colors Legend:

 **Chapter 5**
Jury Facilities

Symbols Legend:

-  Public Circulation
-  Public Vertical Circulation
-  Restricted Circulation
-  Restricted Vertical Circulation
-  Secure Circulation
-  Secure Vertical Circulation
-  Service Vertical Circulation
-  Circulation Access Control Point

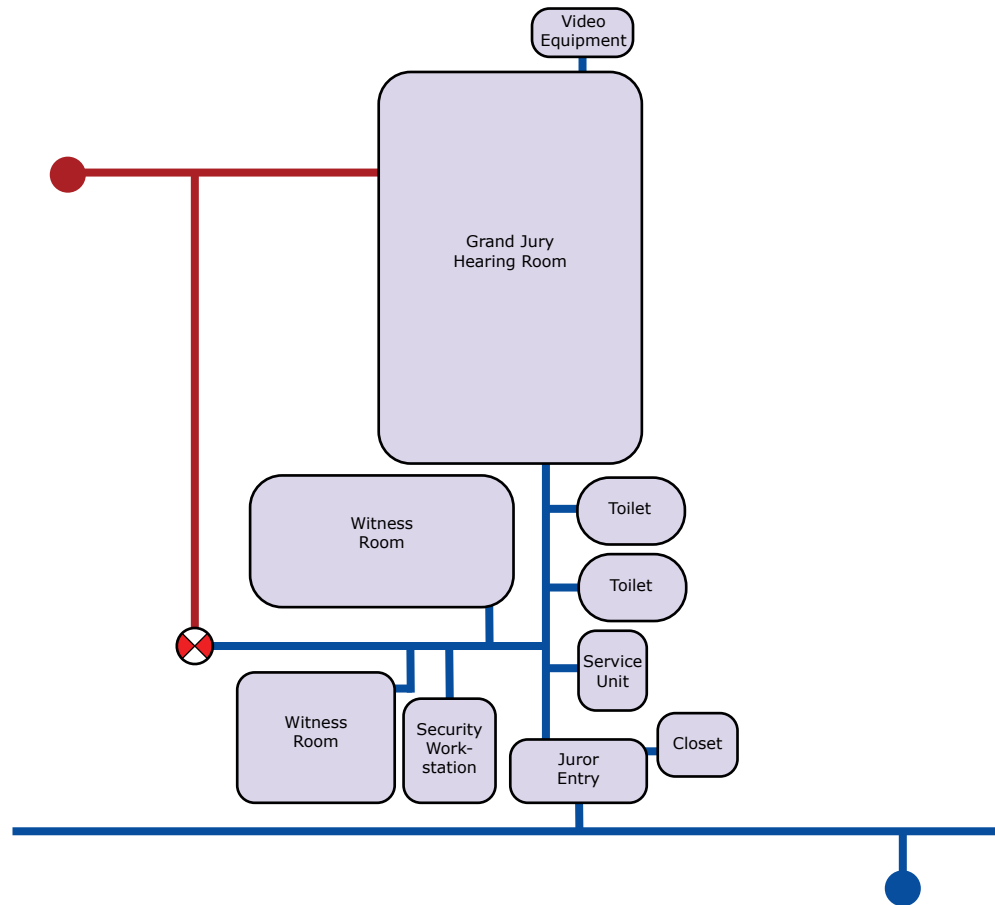



JUDGES' CHAMBERS SUITES

This chapter applies to judges' chambers suites for the U.S. Court of Appeals (USCA), the U.S. District Court (USDC), and the U.S. Bankruptcy Court (USBC). It describes their functions and activities, users and capacities, design requirements, and space allocation requirements, and contains adjacency diagrams.

Chapter Topics:

- Supporting Documents
- Programming and Budgetary Notes
- Functions and Activities
- Users and Capacities
- Design Requirements
- Adjacency and Circulation

Chapter Figures and Tables:

Figure 6.1	Circuit Judge's Resident Chambers Adjacency Relationships
Figure 6.2	Circuit Judge's Non-resident/Visiting Chambers (Headquarters and Outside Headquarters) Adjacency Relationships
Figure 6.3	District Judge's Resident Chambers Adjacency Relationships
Figure 6.4	District, Magistrate, or Bankruptcy Judge's Visiting Chambers Adjacency Relationships
Figure 6.5	Magistrate or Bankruptcy Judge's Resident Chambers Adjacency Relationships
Figure 6.6	Sample Plan - Circuit Judge's Resident Chambers (2060 NSF)
Figure 6.7	Sample Plan - Circuit Judge's Non-resident Chambers (602 NSF)
Figure 6.8	Sample Plan - District Judge's Resident Chambers (1670 NSF)
Figure 6.9	Sample Plan - Magistrate or Bankruptcy Judge's Resident Chambers (1340 NSF)
Table 6.1	Space Requirements for Judges' Chambers Suites

Supporting Documents

A comprehensive guide to supplementary publications can be found in [Chapter 2, “Courthouse Programming and Budgetary Considerations.”](#) That listing includes program and design criteria, courthouse planning and related guidelines, policies, and information on many facets of the design and construction of federal courthouses. The reference listed below relates specifically to this chapter.

- *United States Courts, Courthouse Design Reference Manual: An Architect’s Desk Reference*, most current edition, Chapter 5.

Programming and Budgetary Notes

Programming and budgetary notes found throughout the *Design Guide* provide assistance with decisions to be made during the development of courthouse projects. The notes include both judicial branch policy and lessons learned from completed projects. The notes supplement the criteria in the *Design Guide*; their purpose is to provide direction in using the flexibility of the *Design Guide* to develop justifiable and cost-effective federal courthouse projects.

Space Envelope Flexibility

A total space envelope for new space will be calculated using appropriate circulation factors, allowances for support-type spaces, and the space standards described in the *Design Guide*. Courts have the flexibility to configure space within the envelope to meet their local needs. However, design and construction should be in general compliance with the square footage standards designated in the *Design Guide* in the space and ceiling requirements tables. If the court unit wishes to significantly change the space standards described in the space and ceiling requirements tables without exceeding the total envelope of space for the unit, it must seek approval from its respective circuit judicial council.

The space envelope for a respective court unit is defined as:

- Entire clerk’s office
- Entire probation office
- Entire pretrial services office
- Entire staff attorney’s office
- Entire circuit executive’s office
- All courtrooms designated by judge type (circuit judges, district judges, magistrate judges, and bankruptcy judges)
- All chambers designated by judge type (circuit judges, district judges, magistrate judges, and bankruptcy judges)

For existing space, courts have the flexibility to configure space within the existing envelope to meet their local needs. However, any significant departure from the square footage standards designated in the *Design Guide* in the space and ceiling requirements tables must be approved by the respective circuit judicial council. This does not mean that existing space must be changed to meet *Design Guide* standards. Only new construction completed as part of a renovation should be considered.

Renovations and Alterations (R&A)

Many of the construction projects conducted in the Judiciary are renovations to existing space. Although the *Design Guide* applies to these projects, it is understood that some standards in the *Design Guide* are difficult or impossible to achieve in existing space, particularly in historic buildings. Courts should consult [Chapter 17, “Renovations and Alterations \(R&A\),”](#) and [Facilities Standards for the Public Buildings Service \(GSA PBS P-100\)](#) for guidance in these circumstances. References to R&A guidelines are also included throughout the *Design Guide* where appropriate.

Exceptions to the *Design Guide* Standards

The *Design Guide* provides guidance on standards for courthouse construction and renovations to existing space. Any significant departure from these standards is considered an exception and must be approved by the respective authority as outlined below.

Authority of the Circuit Judicial Councils

Circuit judicial councils play an important space-management role by reviewing district-wide facility plans, approving requests for new or modified space, and enforcing adherence to design guidelines. The circuit judicial councils have authority over, and responsibility for, a circuit’s space-management program (28 USC §332 and §462(b)) and for determining the need for space. As directed by the Judicial Conference of the United States (JCUS), any significant departure from the standards in the *Design Guide* must be approved by the respective circuit judicial council.

Authority of the Committee on Space and Facilities

The authority to approve the following exceptions to the *Design Guide* standards rests with the Committee on Space and Facilities: (1) exceeding the total envelope for either the court unit or the project as a whole, (2) changing the standard configurations for judges’ chambers and courtrooms, and (3) exceeding the plumbing standards. If the Committee on Space and Facilities disagrees with a circuit judicial council request for one of these exceptions, the Judicial Conference will decide whether to grant the exception.

Authority of the Judicial Conference

The authority for approving any exception to prospectus-level courthouse projects that would result in additional estimated costs, including additional rent payment obligations, lies with the Judicial Conference. Approval is required, after review by the Committee

on Space and Facilities, for any exception to the *Design Guide* approved by a circuit judicial council. The request must include (1) a justification for the exception and (2) a construction cost estimate. [All approved exceptions for prospectus-level projects](#) are reported to the General Services Administration (GSA) and Congress. Approved exceptions may require the project to be reauthorized by Congress if the exception had not been previously identified. Contact the Administrative Office of the U.S. Courts (AOUSC) for more detailed information.

For prospectus-level courthouse projects, if an exception is approved by the JCUS which would result in additional estimated costs, the chair of the circuit's space and facilities committee or the chief judge or other judge designated by the court that sought the exception that exceeds the *Design Guide* criteria must be willing, if requested by the Committee on Space and Facilities, to appear before Congress concerning funding for such construction.

General Programming Notes

The *Design Guide* is intended to be a performance document. Criteria for any space or grouping of spaces should be considered in conjunction with the specific needs of the court office or function for which space is being designed.

Criteria in the *Design Guide* do not represent space entitlements. The criteria apply to an array of space types that should be justified based on the specific purpose of each project. Facility plans, programs, and designs should include only the space needed to satisfy the functional and security requirements of the court.

Differences between the space in an existing facility and the criteria in the *Design Guide* are not justification for facility alteration and expansion. In such cases, alternatives to space expansion are investigated before any additional space is requested. In addition, like-for-like space is not a guarantee. Space allocated in an existing location is not justification for the same amount of space in a new location if the space allocation is not warranted. Current needs should be evaluated when moving into new space to determine the appropriate space envelope. Any additional space must be approved by the appropriate authority. Design architects and court staff are prohibited from adding spaces not originally contemplated in the approved prospectus or design program. Increasing the floor area or building volume requires the necessary approvals.

General Budgetary Notes

Renovation and new construction occur when the court and circuit judicial council identify space needs through the Judiciary's asset management planning process and document these needs in the long-range facilities plan. GSA determines by what method the space is provided—for example, by the construction of a new building, the renovation of an existing building, a lease, or other means.

The Judicial Conference recognizes and strongly supports a pragmatic approach to design that includes the use of durable and sustainable materials. This approach ensures that courthouses constructed now will last well into the future.

Following the publication of the *2007 Design Guide*, the Judiciary introduced several cost-saving measures, such as courtroom sharing and the Integrated Workplace Initiative (IWI), that sought to provide flexibility and efficiency in court spaces while preserving the dignity of the Judiciary. Courtroom sharing for certain judge types is now a standard throughout the Judiciary, and IWI is recognized as an alternative to traditional office design. For more information on cost- and space-saving efforts and programs, contact the AOUSC Space and Facilities Division.

General Space Notes

Standardized Chamber Layouts

All resident and non-resident/visiting judges' chambers suites shall be designed in a standard layout based on the type (i.e., circuit, district, magistrate, and bankruptcy judges' chambers). Judges shall agree to a standard layout for their court type. Any exceptions to this policy must be approved by the Committee on Space and Facilities.

Senior Judges

There is no differentiation between chambers space specifications for active and senior judges. As a result, local court and some circuit policies determine whether an active judge who takes senior status may continue in the same chambers. Some courts have special chambers reserved for senior judges. Refer to the *Guide to Judiciary Policy*, Volume 3, Chapter 8 for more information regarding space allocation for senior judges.

Recalled and Part-Time Judges

Judicial Conference policy does not allow planning space for recalled or part-time chambers within new or existing facilities. Refer to the *Asset Management Planning (AMP) Business Rules* and the *Guide to Judiciary Policy*, Volume 3, for more information.

Functions and Activities

The chambers suite includes the judge's private chambers (with adjoining private toilet and vestibule), a reference/conference room, work areas, offices, and other associated spaces used by the judge and support staff. Refer to [Figures 6.1 through 6.5](#) for adjacency diagrams.

Judges' chambers suites provide an area for receiving and screening visitors; storage for staff members' and visitors' coats and other belongings; storage for files used by the judge and staff; a small service unit for coffee and light food preparation; a research area for law clerks; a clerical work area for the judge's judicial assistant; and space for a copier, printer, and other equipment.

In addition to judicial assistants and law clerks, many judges also employ unpaid law school externs/interns. Although the guidelines that follow do not formally designate work spaces for externs/interns, workstations are often provided in the suite's reference/conference room.

Users and Capacities

U.S. Court of Appeals

Chief Judge's Chambers Suite

Users consist of the chief judge, three law clerks, and three judicial assistants (or four law clerks and two judicial assistants), plus visitors.

Circuit Judge's Chambers Suite

Users consist of one judge, three law clerks, and two judicial assistants (or four law clerks and one judicial assistant), plus visitors.

U.S. District Court

Chief Judge's Chambers Suite

Users consist of the chief judge, two law clerks, and one judicial assistant (or three law clerks and no judicial assistant), plus visitors; the chief judge may have a third law clerk or second judicial assistant if there are five or more authorized judgeships in the district. In some courts, the courtroom deputy is also located in the chambers suite. If this is the case, no space is to be provided for the courtroom deputy in the clerk's office.

District Judge's Chambers Suite

Users consist of one judge, two law clerks, and one judicial assistant (or three law clerks and no judicial assistant), plus visitors. In some courts, the courtroom deputy is also located in the chambers suite. If this is the case, no space is to be provided for the courtroom deputy in the clerk's office.

Magistrate Judge's Chambers Suite

Users consist of one magistrate judge, one law clerk, and one judicial assistant (or two law clerks and no assistant), plus visitors. In some courts, the courtroom deputy is also located in the chambers suite. If this is the case, no space is to be provided for the courtroom deputy in the clerk's office.

U.S. Bankruptcy Court

Bankruptcy Judge's Chambers Suite

Users consist of one bankruptcy judge, one law clerk, and one judicial assistant (or two law clerks and no judicial assistant), plus visitors. In some courts, the courtroom deputy is also located in the chambers suite. If this is the case, no space is to be provided for the courtroom deputy in the clerk's office.

Design Requirements

The following section describes the design requirements for the different judicial chambers described in the "Users and Capacities" section of this chapter. Refer to [Table 6.1](#) for additional spatial requirements and [Figures 6.6 through 6.9](#) for sample space plans.

General Design Elements

The following is a description of the design elements in the judge's chambers suite.

Privacy

Total enclosure of the judge's chambers suite is necessary for acoustic and visual privacy, to protect confidentiality, and to prevent distraction. An entrance to the judge's chambers located directly off restricted circulation should be provided with a vestibule to ensure confidentiality. Refer to [Chapter 14, "Acoustics,"](#) for acoustical privacy goals.

Natural Light

Access to natural light is desired for all workstations. Windows are desirable; however, natural light should be controlled to eliminate excessive brightness, glare, or heat.

Ceiling Height

The ceiling is a designed surface. It may be uniformly flat, or it may have two or more planes and include elements such as soffits, perimeter coves, recesses, and reveals as required to integrate HVAC and lighting into a harmonious design. An adjustment of a ceiling surface may also occur where it meets an exterior curtain wall to accommodate different equipment. In situations where there are several different surfaces at different heights above the finished floor, there may be different ways of determining which one is the dominant plane. Ceiling heights should be measured from the finished floor to the dominant surface that either covers the most amount of ceiling square footage, or the

surface that defines the overall character of the ceiling design. The design team should ensure that in all newly constructed spaces the dominant plane of the ceiling does not exceed the maximum ceiling height of 10 feet (3,000 mm) above finished floor for judges' chambers suites and their associated spaces. Dominant planes that exceed this maximum height are considered an exception unless the space is in an area envisioned for a future courtroom or on a floor with a higher floor-to-floor height. The application of this maximum ceiling height in renovation and alteration projects may be dependent on limitations of existing conditions.

The ceiling height should be in proportion to the area of the space. If the space is located on a floor with a higher floor-to-floor height, the ceiling height of the room may be designed to maximize use of available natural light, volume, and window configuration of that space.

Specific Design Elements

Circulation in Chambers

Additional circulation space is not to be included in the chambers design unless needed. The design team should refer to [Chapter 3, "Planning for U.S. Courthouses,"](#) for circulation factors.

Judicial Assistant Work Area

The judicial assistant work area should be designed to allow the suite entrance to be continuously monitored.

Space for a computer printer should be conveniently accessible from the judicial assistant work area but separate from the reception area, to maintain the confidentiality of documents being printed.

Law Clerk Office(s)

A separate office for each law clerk may be provided. Alternatively, clerks may be provided with semiprivate workstations, either in an alcove or separated by modular partitions, bookcases, and so on, depending on the judge's preference. Refer to [Chapter 18, "Alternative Workplace Strategies,"](#) for additional information.

Courtroom Deputy

Each suite may also require a courtroom deputy clerk work area within or close to the chambers suite. If the courtroom deputy clerk is assigned to chambers, a private office of 150 net square feet (NSF) (13.9 Nm²) shall be provided within the space envelope of the chambers suite. No additional space shall be provided for the courtroom deputy clerk in the clerk's office. This applies to chambers for district, magistrate, and bankruptcy judges.

Reference/Conference Room

The reference/conference room is used by the judge and law clerks to research and discuss cases, as well as by the judge to meet with other court staff or attorneys. It may also

house workstations for externs/interns. Shelving should be provided to accommodate the chambers reference collection. In addition, the area should accommodate a conference table and chairs for up to 12 people. Infrastructure should be provided to support audio and video presentation and video conferencing.

Requirements for bookshelves are changing because of evolving methods of legal research. The increasing use of electronic databases and a decreasing reliance on bound volumes are resulting in smaller chambers reference collections. The changes in legal research methods provide an opportunity to reduce the court's expenses for maintaining collections and the space needed to house them. The location and quantity of bookshelves is at the discretion of the judge. If bookshelves are required, shelving shall be affixed to the wall, and the wood shall match or complement the architectural trim. One fixed bookshelf is three linear feet wide by 10 inches deep. Provide fixed bookcases with adjustable shelving in the following quantities:

- Circuit judge – 25 bookshelves
- District judge – 20 bookshelves
- Magistrate judge – 10 bookshelves
- Bankruptcy judge – 10 bookshelves

Informal sharing among chambers should be encouraged. Adjacent chambers in new courthouse designs should be encouraged by providing controlled access into each chamber from a shared reference/conference room. This design provides additional flexibility for individual judges to share books.

Shared Reference (Library) Collections

The sharing of chambers reference collections is currently practiced in some courts and is encouraged when planning courthouse construction projects. In addition to cost savings, sharing collections may offer other advantages such as increasing the depth of the collection available to judges and promoting collegial relations among law clerks and judges, and accommodating workstations for interns and externs. Disadvantages may include reduced convenience or the increased possibility that a desired book may be in use.

The Judiciary's Committee on Court Administration and Case Management has identified space-planning scenarios for sharing chambers reference collections. Variations of the scenarios listed below may be adapted to fit the myriad possible configurations for chambers suites.

- In courthouses where chambers suites are clustered on the same floor, there may be a central shared collection augmented by a minimal number of often-used volumes maintained in chambers. This arrangement increases the possibility of providing library staff and offers the greatest opportunity to increase the depth of the collection; however, access to books may be less convenient.

- The collegial arrangement of chambers suites also provides an opportunity for shared conference rooms and other support spaces. A shared conference room may be larger and better equipped than individual conference rooms in chambers suites.
- In courthouses that do not have clustered chambers suites, reference collections may be shared between adjoining suites. A single shared reference/conference room, situated between the suites, with controlled access into each chamber may be used to store books and legal research, as well as accommodate workstations for interns and externs. This arrangement preserves convenient access to the collection and provides flexibility for individual judges to share books. This scenario places responsibility for administering the collection on the judges' staff.

The total NSF allocated for shared reference collections should not exceed the total NSF allotted in chambers suites for this purpose. Space programmed for shared reference collections should be deducted on a pro rata basis from each chambers suite. Although space savings may be minimal, the cost of maintaining two separate collections is significantly reduced. Shared collections may save net programmed space but may increase space required for circulation. Efficient planning may decrease total space requirements and provide enhanced library services. Consideration should be given to placing workstations for externs and interns in the shared reference library.

Storage

The general storage area in the judge's chambers suite should provide the following:

- Space for lateral files or other appropriate filing equipment
- A closet convenient to the reception area that provides hanging and shelf space for visitors' and staff members' coats and other belongings
- Space for general office and coffee/refreshment supplies
- At least one range of bookshelves for each staff member, including the judicial assistant

Within the judge's private chambers, storage should be provided for the following:

- The judge's personal belongings (storage should be lockable)
- Office supplies (in conveniently located drawers or cabinets, large enough to accommodate legal-sized pads and files)
- Files (storage should be lockable; file storage may be located outside the chambers but should have convenient access)
- Law books (shelves should be conveniently located)

Toilet

A private toilet room should be provided in the chambers suite. Access to the toilet should be through a vestibule that also provides access from the chambers to restricted circulation. The private toilet room should be designed as adaptable and shall meet all necessary clearances for judges with a disability. A toilet lavatory cabinet shall accommodate a sink and a drawer with storage below. Refer to [Table 6.1](#) for more detail on private toilets.

Table 6.1
Space Requirements for Judges' Chambers Suites

Circuit Judge's Resident Chambers Suite	NSF	Nm ²
Judge's Chambers Office	600	55.8
Judge's Private Toilet	56	5.2
Storage	100	9.3
Filing Room	140	13.0
Law Clerks: Three @ 150 NSF (13.9 Nm ²)	450	41.9
Conference/Reference Room	240	22.3
Judicial Assistant Work Space: Two @ 120 NSF (11.2 Nm ²)	240	22.3
Printer/Copier/Fax	60	5.6
Service Unit	20	1.9
Coat Closet	10	0.9
Vestibule	50	4.7
Reception Area	100	9.3
Total NSF¹	2,066	191.9
District Judge's Resident Chambers Suite	NSF	Nm ²
Judge's Chambers Office	500	46.5
Judge's Private Toilet	56	5.2
Storage	80	7.4
Filing Room	140	13.0
Law Clerks: Two @ 150 NSF (13.9 Nm ²)	300	27.9
Conference/Reference Room	240	22.3
Judicial Assistant Work Space	120	11.2
Printer/Copier/Fax	60	5.6

Service Unit	20	1.9
Coat Closet	10	0.9
Vestibule	50	4.7
Reception Area	100	9.3
Total NSF¹	1,676	155.7
Magistrate/Bankruptcy Judge's Resident Chambers Suite	NSF	Nm²
Judge's Chambers Office	400	37.2
Judge's Private Toilet	56	5.2
Storage	80	7.4
Filing Room	60	5.6
Law Clerk	150	14.0
Conference/Reference Room	240	22.3
Judicial Assistant Work Space	120	11.2
Printer/Copier/Fax	60	5.6
Service Unit	20	1.9
Coat Closet	10	0.9
Vestibule	50	4.7
Reception Area	100	9.3
Total NSF¹	1,346	125.0
Circuit Judge's Non-Resident Suite (Headquarters and Non-Headquarters)	NSF	Nm²
Judge's Chambers Office	240	22.3
Judge's Private Toilet	56	5.2
Law Clerk Open Workstations: Three @ 64 NSF (5.8 Nm ²)	192	17.9
Judicial Assistant & Reception	120	11.2
Total NSF¹	608	56.5

Other Non-Resident Chambers Suite		NSF	Nm ²
Judge's Chambers Office		240	22.3
Judge's Private Toilet		56	5.2
Law Clerk Open Workstations: Two @ 64 NSF (5.8 Nm ²)		128	11.9
Judicial Assistant & Reception		120	11.2
Filing Room		140	13.0
Printer/Copier/Fax		60	5.6
Storage		80	7.4
Vestibule		50	4.7
Coat Closet		12	1.1
Service Unit		20	1.9
Total NSF¹		906	84.2

¹ If a different complement of judicial assistants and law clerks is selected, the total NSF shall not be exceeded. If the courtroom deputy clerk is assigned to chambers, a private office of 150 NSF (13.9 Nm²) shall be provided within the space envelope of the chambers suite. No additional space shall be provided for the courtroom deputy clerk in the clerk's office.

Renovations and Alterations (R&A)

Certain design requirements stated in the *Design Guide* may be impractical, impossible, or cost-prohibitive to meet because of challenging existing conditions. Stakeholders should discuss these challenges early in the project and determine how to best implement the *Design Guide* requirements to suit their specific needs and uphold its intent.

In existing, older courthouses, the size, location, and configuration of chambers may vary depending on the structural limitations of the building. A number of factors may contribute to variances:

- Chambers were designed to previous standards or for different court functions.
- Existing floor plates vary in size and shape and do not always accommodate the most functional dimensions for a chambers suite.
- Historic buildings may have limited or restricted space for chambers suites.
- Available space is not always contiguous due to historic elements, other tenants, or building elements such as stairwells, elevators, or corridors.
- Fire and life safety restrictions may affect or conflict with optimum security or functionality.

Adjacency and Circulation

Each judge's chambers suite is accessible only through restricted circulation. The suite is located to be conveniently accessible to the judge's courtroom and its associated areas, unless a collegial chambers floor scheme is selected. When chambers are located on different floors from courtrooms, judges will utilize a restricted judges' elevator that allows for convenient restricted access to courtrooms.



See the adjacency diagrams that follow ([Figures 6.1–6.5](#)) for additional detail regarding adjacency and circulation. [Chapter 3, "Planning for U.S. Courthouses,"](#) provides a discussion on circulation factors to be used in initial programming and design studies.

Figure 6.1
Circuit Resident Judge's Chambers Adjacency Relationships

Colors Legend:

 **Chapter 6**
Judges' Chambers Suites

Symbols Legend:

 Restricted Circulation
 Restricted Vertical Circulation
 Circulation Access Control Point

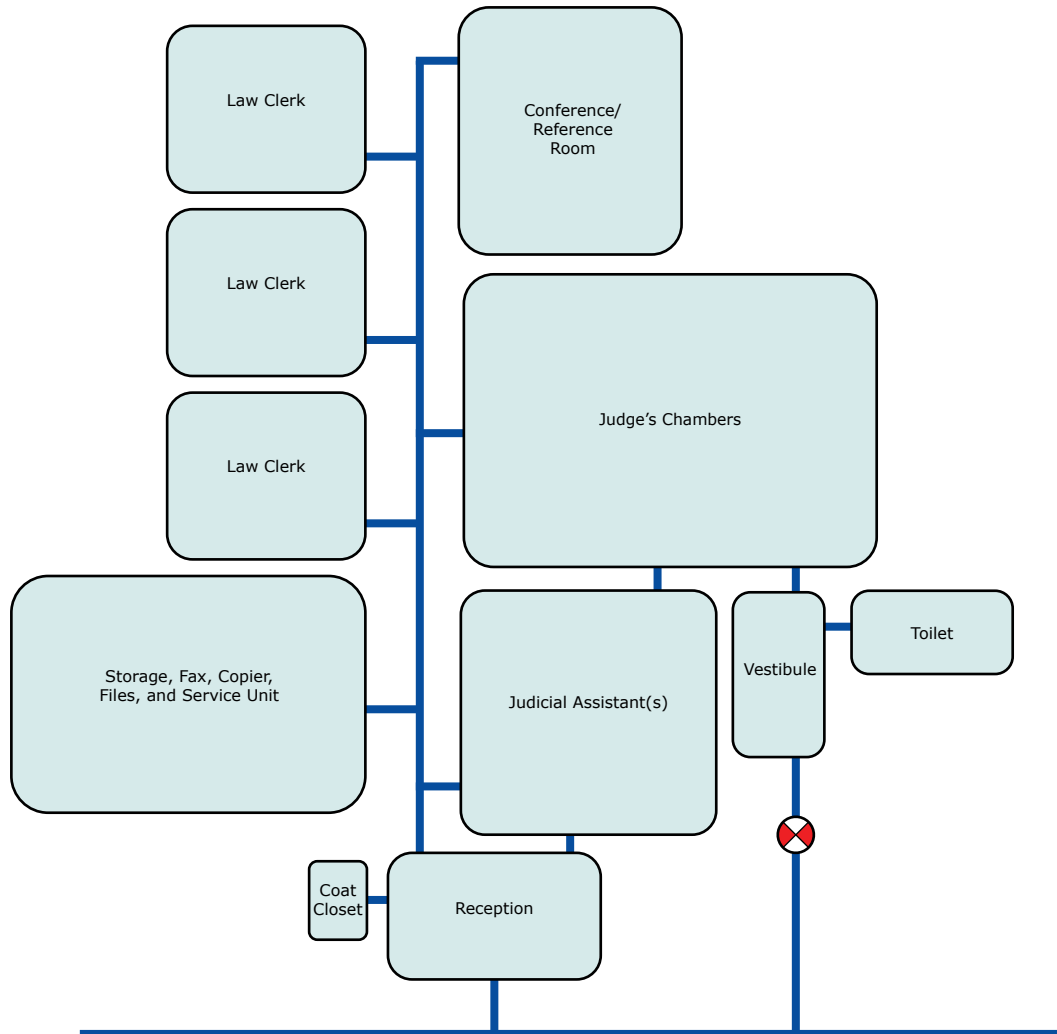

Note: The adjacency diagram is intended only as an illustration.



Figure 6.2

Circuit Judge's Non-resident/Visiting Chambers (Headquarters and Outside Headquarters) Adjacency Relationships

Colors Legend:

 **Chapter 6**
Judges' Chambers Suites

Symbols Legend:

-  Restricted Circulation
-  Restricted Vertical Circulation
-  Circulation Access Control Point

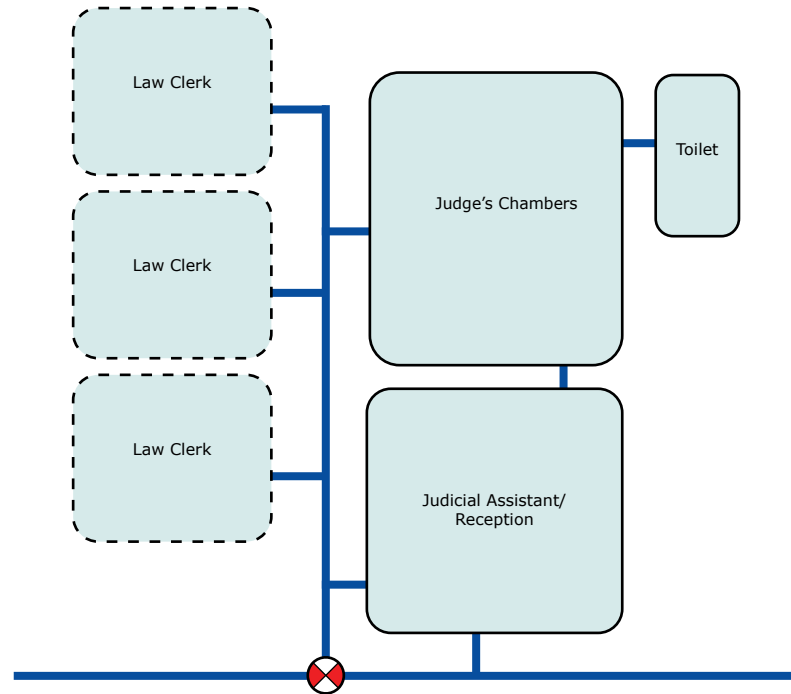

Note: The adjacency diagram is intended only as an illustration.



Figure 6.3

District Judge's Resident Chambers Adjacency Relationships

Colors Legend:

 **Chapter 6**
Judges' Chambers Suites

Symbols Legend:

-  Restricted Circulation
-  Restricted Vertical Circulation
-  Circulation Access Control Point

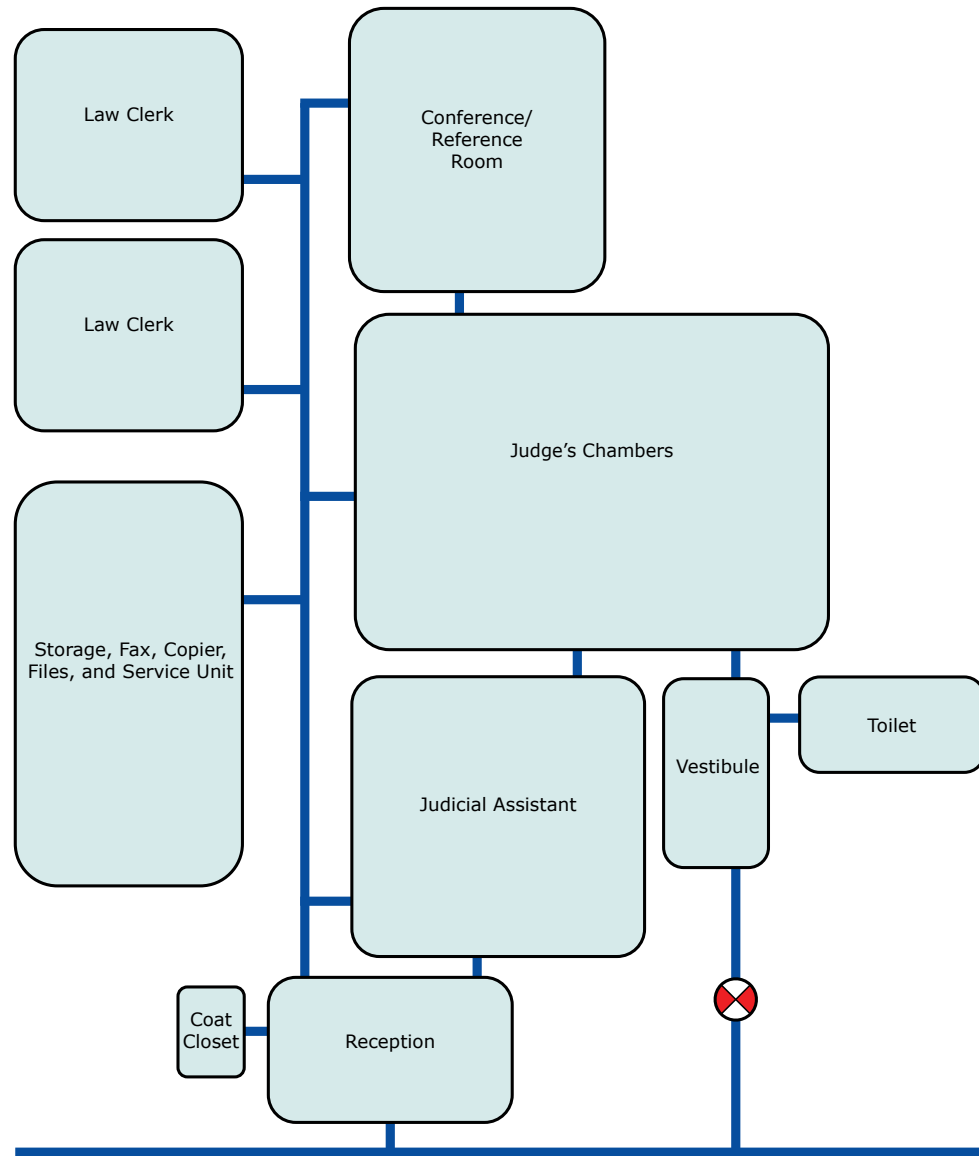

Note: The adjacency diagram is intended only as an illustration. If a courtroom deputy clerk is provided an office in chambers or near chambers, no additional office shall be provided in the clerk's office.



Figure 6.4

District, Magistrate, or Bankruptcy Judge’s Visiting Chambers Adjacency Relationships

Colors Legend:

 **Chapter 6**
Judges’ Chambers Suites

Symbols Legend:

-  Restricted Circulation
-  Restricted Vertical Circulation
-  Circulation Access Control Point

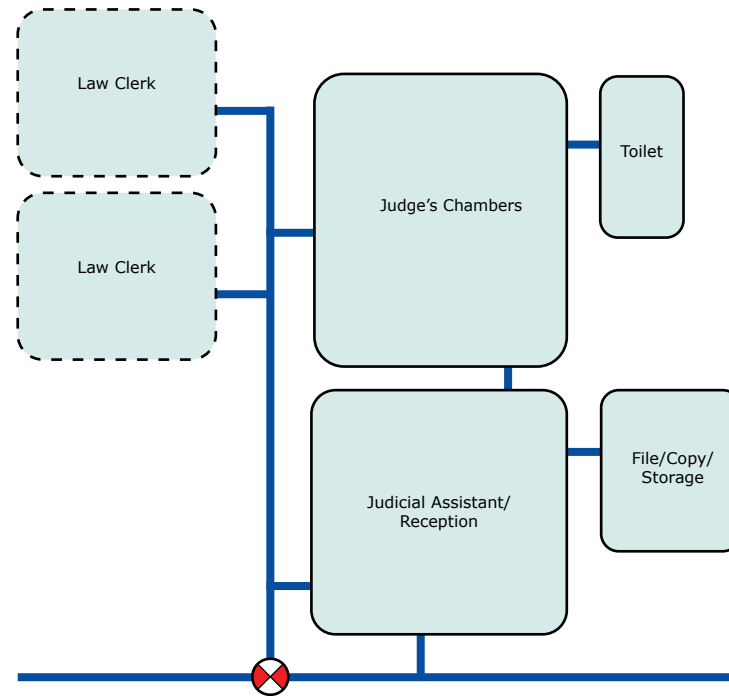



Note: The adjacency diagram is intended only as an illustration. If a courtroom deputy clerk is provided an office in chambers or near chambers, no additional office shall be provided in the clerk’s office.

Figure 6.5
Magistrate or Bankruptcy Judge’s Resident Chambers Adjacency Relationships

Colors Legend:

 **Chapter 6**
Judges’ Chambers Suites

Symbols Legend:

-  Restricted Circulation
-  Restricted Vertical Circulation
-  Circulation Access Control Point

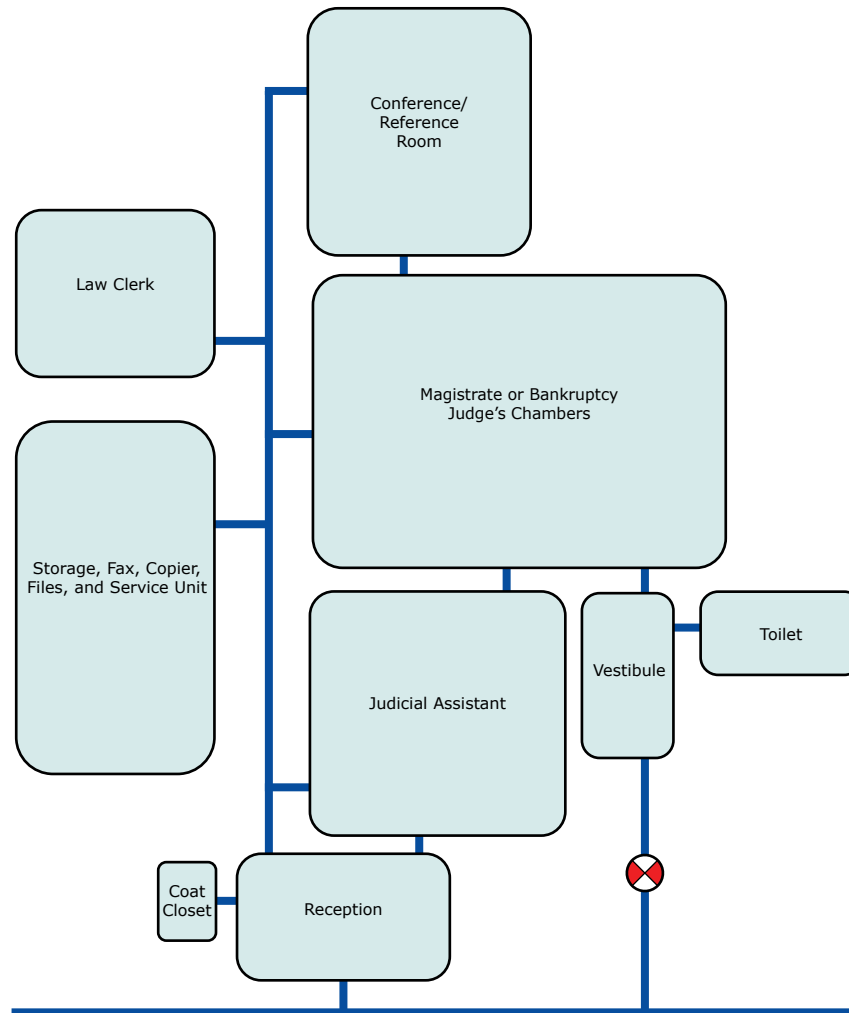

Note: The adjacency diagram is intended only as an illustration. If a courtroom deputy clerk is provided an office in chambers or near chambers, no additional office shall be provided in the clerk’s office.

Figure 6.6
Sample Plan - Circuit Judge's Resident Chambers (2060 NSF)

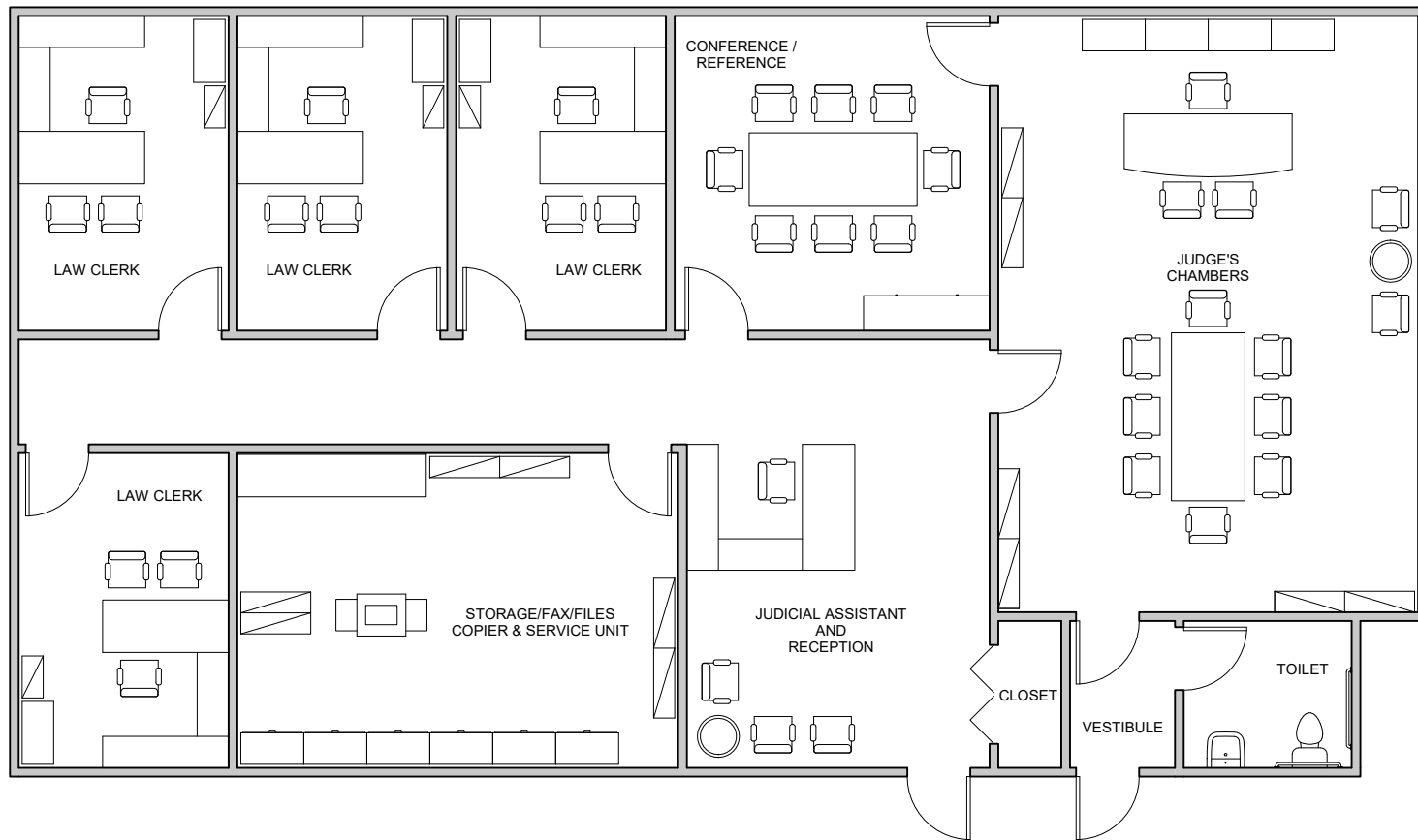

Note: The above figure illustrates a sample layout for a chamber suite. The actual design of chambers will vary according to the overall design of the courthouse. The sample has been provided to illustrate adjacencies and relative sizes of spaces.

Figure 6.7

Sample Plan - Circuit Judge's Non-resident Chambers (602 NSF)

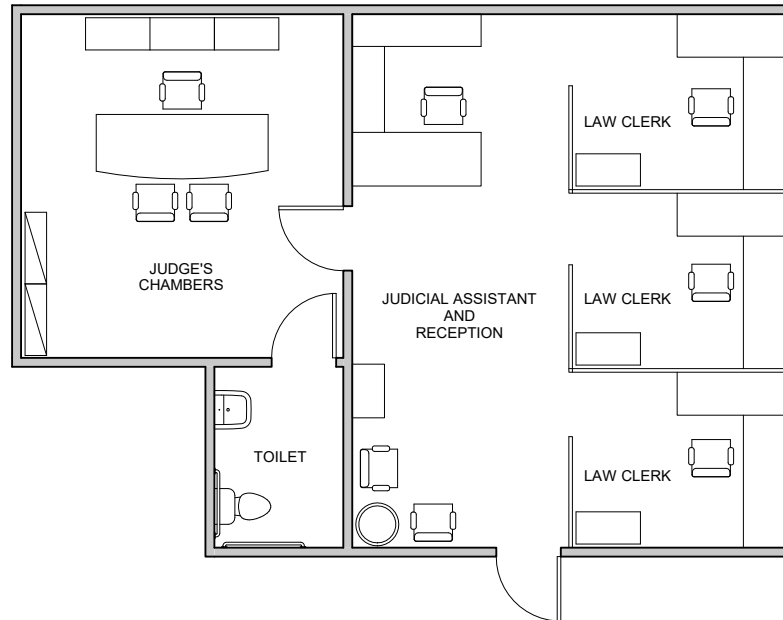

Note: The above figure illustrates a sample layout for a chambers suite. The actual design of chambers will vary according to the overall design of the courthouse. The sample has been provided to illustrate adjacencies and relative sizes of spaces.

Figure 6.8
Sample Plan - District Judge's Resident Chambers (1670 NSF)

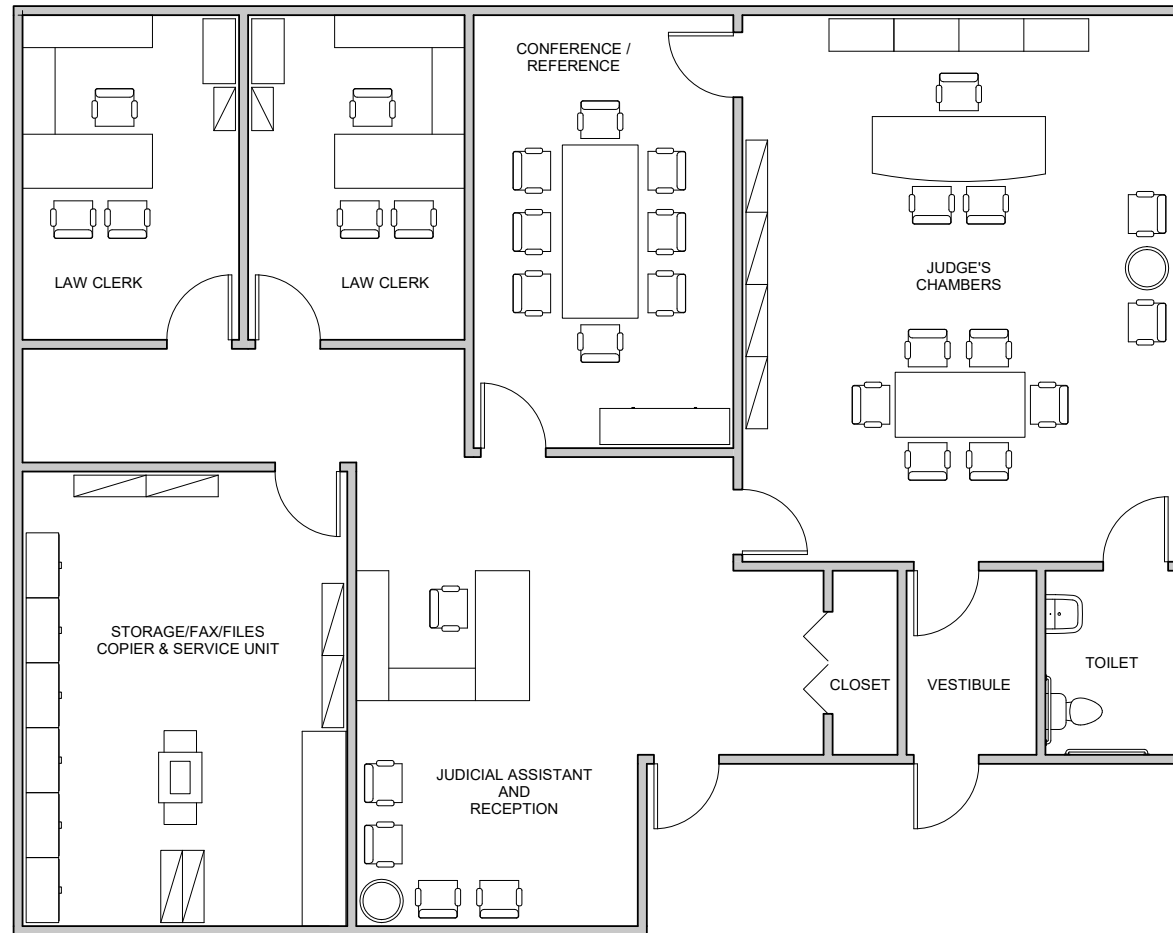

Note: The above figure illustrates a sample layout for a chambers suite. The actual design of chambers will vary according to the overall design of the courthouse. The sample has been provided to illustrate adjacencies and relative sizes of spaces.

Figure 6.9

Sample Plan - Magistrate or Bankruptcy Judge's Resident Chambers (1340 NSF)

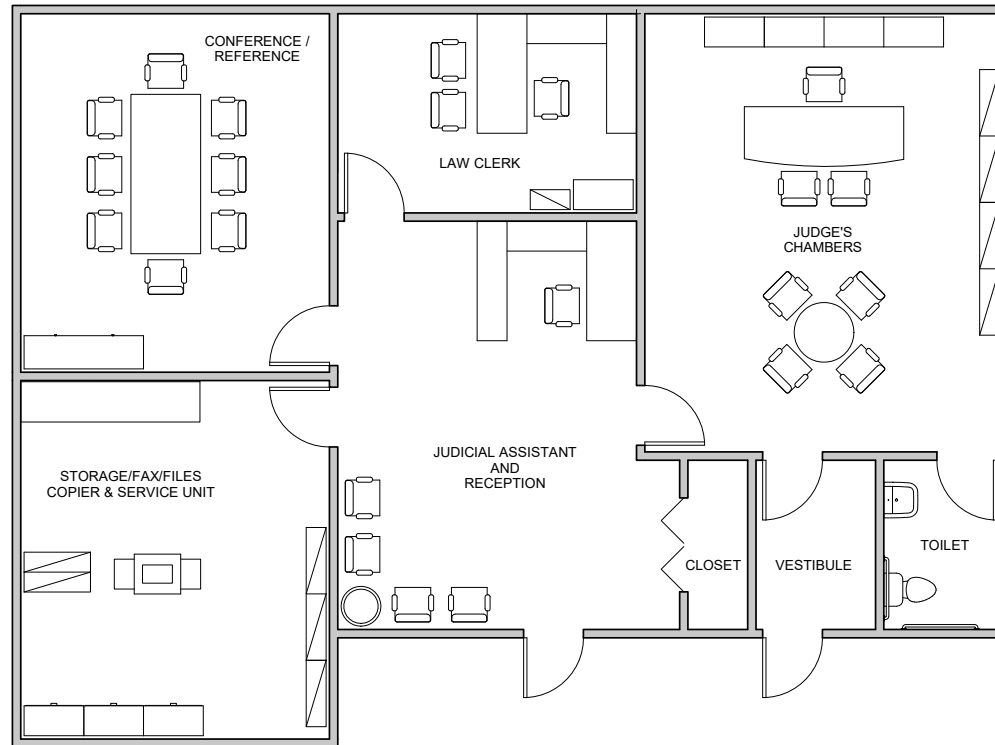

Note: The above figure illustrates a sample layout for a chambers suite. The actual design of chambers will vary according to the overall design of the courthouse. The sample has been provided to illustrate adjacencies and relative sizes of spaces.



COURT LIBRARIES

This chapter applies to court libraries, including circuit headquarters, satellite, and unstaffed libraries. It describes functions and activities, users and capacities, design requirements, and space allocation requirements, and includes adjacency diagrams.

Chapter Topics:

- Supporting Documents
- Programming and Budgetary Notes
- Functions and Activities
- Users and Capacities
- Design Requirements
- Planning Issues
- Space Allotments
- Adjacency and Circulation

Chapter Figures and Tables:

Figure 7.1	Circuit Headquarters Library Adjacency Relationships
Figure 7.2	Satellite Libraries Adjacency Relationships
Figure 7.3	Unstaffed Libraries Adjacency Relationships
Table 7.1	Space Requirements for Court Libraries

Supporting Documents

A comprehensive guide to supporting documents can be found in [Chapter 2, “Courthouse Programming and Budgetary Considerations.”](#) That listing includes program and design criteria, courthouse planning and related guidelines, policies, and information on many facets of the design and construction of federal courthouses. The reference listed below relates specifically to this chapter.

- *United States Courts, Courthouse Design Reference Manual: An Architect’s Desk Reference*, most current edition, Chapter 5.

Programming and Budgetary Notes

Programming and budgetary notes found throughout the *Design Guide* provide assistance with decisions to be made during the development of courthouse projects. The notes include both judicial branch policy and lessons learned from completed projects. The notes supplement the criteria in the *Design Guide*; their purpose is to provide direction in using the flexibility of the *Design Guide* to develop justifiable and cost-effective federal courthouse projects.

Space Envelope Flexibility

A total space envelope for new space will be calculated using appropriate circulation factors, allowances for support-type spaces, and the space standards described in the *Design Guide*. Courts have the flexibility to configure space within the envelope to meet their local needs. However, design and construction should be in general compliance with the square footage standards designated in the *Design Guide* in the space and ceiling requirements tables. If the court unit wishes to significantly change the space standards described in the space and ceiling requirements tables without exceeding the total envelope of space for the unit, it must seek approval from its respective circuit judicial council.

The space envelope for a respective court unit is defined as:

- Entire clerk’s office
- Entire probation office
- Entire pretrial services office
- Entire staff attorney’s office
- Entire circuit executive’s office
- All courtrooms designated by judge type (circuit judges, district judges, magistrate judges, and bankruptcy judges)
- All chambers designated by judge type (circuit judges, district judges, magistrate judges, and bankruptcy judges)

For existing space, courts have the flexibility to configure space within the existing envelope to meet their local needs. However, any significant departure from the square footage standards designated in the *Design Guide* in the space and ceiling requirements tables must be approved by the respective circuit judicial council. This does not mean that existing space must be changed to meet *Design Guide* standards. Only new construction completed as part of a renovation should be considered.

Renovations and Alterations (R&A)

Many of the construction projects conducted in the Judiciary are renovations to existing space. Although the *Design Guide* applies to these projects, it is understood that some standards in the *Design Guide* are difficult or impossible to achieve in existing space, particularly in historic buildings. Courts should consult [Chapter 17, “Renovations and Alterations \(R&A\),”](#) and [Facilities Standards for the Public Buildings Service \(GSA PBS P-100\)](#) for guidance in these circumstances. References to R&A guidelines are also included throughout the *Design Guide* where appropriate.

Exceptions to the *Design Guide* Standards

The *Design Guide* provides guidance on standards for courthouse construction and renovations to existing space. Any significant departure from these standards is considered an exception and must be approved by the respective authority as outlined below.

Authority of the Circuit Judicial Councils

Circuit judicial councils play an important space-management role by reviewing district-wide facility plans, approving requests for new or modified space, and enforcing adherence to design guidelines. The circuit judicial councils have authority over, and responsibility for, a circuit’s space-management program (28 USC §332 and §462(b)) and for determining the need for space. As directed by the Judicial Conference of the United States (JCUS), any significant departure from the standards in the *Design Guide* must be approved by the respective circuit judicial council.

Authority of the Committee on Space and Facilities

The authority to approve the following exceptions to the *Design Guide* standards rests with the Committee on Space and Facilities: (1) exceeding the total envelope for either the court unit or the project as a whole, (2) changing the standard configurations for judges’ chambers and courtrooms, and (3) exceeding the plumbing standards. If the Committee on Space and Facilities disagrees with a circuit judicial council request for one of these exceptions, the Judicial Conference will decide whether to grant the exception.

Authority of the Judicial Conference

The authority for approving any exception to prospectus-level courthouse projects that would result in additional estimated costs, including additional rent payment obligations, lies with the Judicial Conference. Approval is required, after review by the Committee

on Space and Facilities, for any exception to the *Design Guide* approved by a circuit judicial council. The request must include (1) a justification for the exception and (2) a construction cost estimate. [All approved exceptions for prospectus-level projects](#) are reported to the General Services Administration (GSA) and Congress. Approved exceptions may require the project to be reauthorized by Congress if the exception had not been previously identified. Contact the Administrative Office of the U.S. Courts (AOUSC) for more detailed information.

For prospectus-level courthouse projects, if an exception is approved by the JCUS which would result in additional estimated costs, the chair of the circuit's space and facilities committee or the chief judge or other judge designated by the court that sought the exception that exceeds the *Design Guide* criteria must be willing, if requested by the Committee on Space and Facilities, to appear before Congress concerning funding for such construction.

General Programming Notes

The *Design Guide* is intended to be a performance document. Criteria for any space or grouping of spaces should be considered in conjunction with the specific needs of the court office or function for which space is being designed.

Criteria in the *Design Guide* do not represent space entitlements. The criteria apply to an array of space types that should be justified based on the specific purpose of each project. Facility plans, programs, and designs should include only the space needed to satisfy the functional and security requirements of the court.

Differences between the space in an existing facility and the criteria in the *Design Guide* are not justification for facility alteration and expansion. In such cases, alternatives to space expansion are investigated before any additional space is requested. In addition, like-for-like space is not a guarantee. Space allocated in an existing location is not justification for the same amount of space in a new location if the space allocation is not warranted. Current needs should be evaluated when moving into new space to determine the appropriate space envelope. Any additional space must be approved by the appropriate authority. Design architects and court staff are prohibited from adding spaces not originally contemplated in the approved prospectus or design program. Increasing the floor area or building volume requires the necessary approvals.

General Budgetary Notes

Renovation and new construction occur when the court and circuit judicial council identify space needs through the Judiciary's asset management planning process and document these needs in the long-range facilities plan. GSA determines by what method the space is provided—for example, by the construction of a new building, the renovation of an existing building, a lease, or other means.

The Judicial Conference recognizes and strongly supports a pragmatic approach to design that includes the use of durable and sustainable materials. This approach ensures that courthouses constructed now will last well into the future.

Following the publication of the *2007 Design Guide*, the Judiciary introduced several cost-saving measures, such as courtroom sharing and the Integrated Workplace Initiative (IWI), that sought to provide flexibility and efficiency in court spaces while preserving the dignity of the Judiciary. Courtroom sharing for certain judge types is now a standard throughout the Judiciary, and IWI is recognized as an alternative to traditional office design. For more information on cost- and space-saving efforts and programs, contact the AOUSC Space and Facilities Division.

General Space Notes

Establishing the Size of Libraries

Specific requirements for court library collections and libraries should be defined by the court in consultation with the circuit librarian and the librarian of the specific library that is being designed or redesigned.

The lack of availability/proximity of adequate alternate means for obtaining needed materials, such as nearby law library collections and the availability of interlibrary loan arrangements, may affect the size of the library.

The size of a court library is determined largely by the size of its collection. Factors that influence the size of the library, and which must be demonstrated to the satisfaction of the circuit judicial council in order to justify special requirements above guidelines, are listed below. These factors are not intended to be used to unreasonably increase the library size above the spaces listed in [Table 7.1](#).

- Research population needs, including the numbers, types, and jurisdictions of judges served by the library; the numbers of court staff and public users; the size of the library staff; the extent to which chambers law book collections are pooled; the extent to which judges served by the library have reduced their chambers collections, and thus placed greater reliance on the library collection; and the difficulty and expense of using compact shelving and microforms.
- Compact shelving for library collections should be considered where appropriate to reduce the size of the library collection space. Floor strengthening may be required for high-density or full-height shelving and avoided if low-height shelving is used instead.
- The library service needs of active circuit, district, magistrate, and bankruptcy judges and their staff, as well as the requirements of judges located outside the courthouse within the same city or a designated radius, should be considered.

- Planning should take into account the need for patron/user space, including court public patron access policies requiring greater space for public access computers, collaborative work areas, and study spaces; the court-approved need for private research areas for judges, law clerks, staff attorneys, and court staff; and the lack of alternative intern, extern, law clerk, and/or staff attorney research study space.

Preferences for Rectangular Spaces

Square or rectangular spaces, with minimum columns and partitions, should be designed for court libraries.

Cost-Control Issues

The cost of and space for new or shared court library collections should be partially offset by reducing judges' chambers law book collections. When a shared chambers' collection is planned, reducing or increasing the size of a chambers conference/reference room must be approved by the circuit judicial council and shall not exceed the two chambers' envelopes of space.

To reduce unnecessary duplication, the effect of shared chambers law book collections and the coordination of court library and chambers collections should be considered. Informal sharing among chambers should be encouraged. Adjacent chambers in new courthouse designs should be encouraged by providing controlled access to each chambers from a shared reference/conference room. This design provides additional flexibility for individual judges to share books.

Space for shared chambers law book collections should be deducted from space allocated to the chambers suites on a prorated basis. This approach is not considered an exception to the space standards in the *Design Guide*.

The effect on library staffing requirements should be considered when planning court libraries located on more than one floor.

There is a preference for naturally lit environments in the book stack areas.

Functions and Activities

Court librarians assist patrons by collecting and organizing legal materials in a court library to support the research process. How a library's electronic and print resources are used should be a consideration when designing a library. The court library is not to be confused with collections maintained in chambers and other court units' offices. Central libraries are administered by the U.S. Court of Appeals (USCA) and operate autonomously from circuit to circuit.

Each circuit requires a circuit headquarters library, with satellite and unstaffed libraries provided elsewhere in the circuit as needed in those court locations.

Circuit Headquarters Library

The circuit headquarters library is the hub for the administrative operation of each circuit's library services. The library also typically houses the largest and most complete research collection in the circuit.

Administrative and management functions may include space planning, policy development, personnel, budgeting, and procurement. The circuit headquarters library has specialists and technicians who provide centralized services for the circuit. These services may include cataloging; acquisitions for libraries, chambers, and offices; interlibrary loans; and in-depth research requiring online expertise.

All these functions require office and work space in addition to the stack areas and patron seating typical in any library. Other services and features of circuit headquarters libraries include study areas and computer access for judges and staff, as well as photocopy equipment.

An integrated library system is available in every library and is administered through the headquarters library. The system provides comprehensive library management software, including an online public access catalog of holdings in all libraries within the respective circuit.

Separate or large public atria, reading rooms, entryways, or other purely ceremonial spaces that do not house essential library functions should be avoided. These spaces may be developed if the circuit judicial council determines they are necessary and do not cause the library space to exceed the total envelope of space. Consideration should be given to ensure flexible design for future reconfiguration.

Satellite Library

Satellite libraries are typically established for any court location with a library (whether in the same building or in another location) serving at least 10 judges. It is the role of the circuit judicial council to approve the need for and size of a satellite library at a given location. The libraries are usually located in district courthouses and are staffed by one professional or technical staff person (sometimes part-time). Satellite libraries vary in terms of service level and collection size and are staffed based upon the court's needs and number of patrons. The libraries may house shared chambers collections or augment chambers collections.

Similar to the circuit headquarters library, satellite libraries include work space for library staff, photocopy equipment, and study areas and computer access for judges and staff. Additional secure and separate spaces and features may be required if the satellite library is available to the public.

As is the case with the circuit headquarters library, separate or large public atria, reading rooms, entryways, or other purely ceremonial spaces that do not house essential library functions should be avoided. If these spaces are determined by the circuit judicial council to be necessary, their inclusion should not cause the library space to exceed the total envelope of space. Consideration should be given to ensure flexible design for future reconfiguration.

Unstaffed Library

Unstaffed libraries are created in smaller courthouses if the following conditions apply: space is available, judges agree to pool their chambers collections, a group of judges (e.g., bankruptcy) has chambers outside the courthouse, and/or central library staffing support is not available. Occasionally, an unstaffed library is created in the same building as a circuit headquarters or satellite library but located on a different floor.

Users and Capacities

Users vary depending on the size of the courthouse; the type and volume of cases; and the number of maintenance staff, service company/agency personnel, and public individuals present. For the purposes of certain references in this *Design Guide*, the following designations apply:

A small courthouse has five or fewer courtrooms.

A medium courthouse has 6-12 courtrooms.

A large courthouse has 13-18 courtrooms.

An extra-large courthouse has more than 18 courtrooms.

Patrons

- Court personnel who use the libraries primarily include judges, law clerks, staff attorneys, circuit and district court executives' staff, and clerks' staff.
- Other users may include the general public as well as private attorneys, U.S. attorney personnel, and federal public defender personnel.

Library Staff

- Library staff primarily include the circuit librarian; deputy circuit librarian; and professional, automation, and technical staff.
- Staffing levels depend upon the size of the collection and the court facility served.

Design Requirements

Ceiling Height

The ceiling is a designed surface. It may be uniformly flat, or it may have two or more planes and include elements such as soffits, perimeter coves, recesses, and reveals as required to integrate HVAC and lighting into a harmonious design. An adjustment of a ceiling surface may also occur where it meets an exterior curtain wall to accommodate different equipment. In situations where there are several different surfaces at different heights above the finished floor, there may be different ways of determining which one is the dominant plane. Ceiling heights should be measured from the finished floor to the dominant surface that either covers the most amount of ceiling square footage, or the surface that defines the overall character of the ceiling design. The design team should ensure that in all newly constructed spaces the dominant plane of the ceiling does not exceed the maximum ceiling height of 10 feet (3,000 mm) above finished floor for court libraries and their associated spaces. Dominant planes that exceed this maximum height are considered an exception unless the space is in an area envisioned for a future courtroom or on a floor with a higher floor-to-floor height. The application of this maximum ceiling height in renovation and alteration projects may be dependent on limitations of existing conditions.

The ceiling height should be in proportion to the area of the space. If the space is located on a floor with a higher floor-to-floor height, the ceiling height of the room may be designed to maximize use of available natural light, volume, and window configuration of that space.

Planning Issues

General

Whenever planning occurs for new libraries, or for relocations or renovations of existing libraries or shared collections in a court, it is strongly encouraged that a representative from the circuit library committee (if one exists) and the circuit librarian serve on the space planning committee. Consideration of disaster preparedness is a valuable factor to include in discussion of a library design or redesign.

Circulation/Reference Areas

The circulation/reference desk area should allow flexibility to accommodate new technologies and provide space for computers, printers, copiers, and scanners. The circulation/reference desk is required to be up to 20 feet (6,100 mm) long for headquarters libraries and up to 12 feet (3,700 mm) long for satellite libraries. Space for returning books should include a book cart area. A computer workstation for the online catalog should be provided near the circulation/reference area. In Federal Depository Library Program (FDLP) libraries, space should be provided for a public access computer workstation near the circulation/reference area. A wireless connection to the internet should be considered for the court staff patrons and for the public patrons, where IT security concerns allow such a connection.

Bookstacks

The area allocated for the collection (stack areas) should be designed as one contiguous rectangle to maximize the efficiency of collection shelving space and to enable future use of compact shelving where appropriate. Non-square angles and rounded areas are to be avoided. When providing such an area is impossible, space allocated to the collection should be increased.

Planning should take into account collection development needs, including the size and age of the existing library collection, patterns of collaborative collection development among the circuit's libraries, the degree to which centralization and/or specialization of collections is employed to avoid duplication among libraries, the number of states and territories within the circuit, the size and complexity of state law collections, and the number of related state volumes.

Aisles should be at least 36 inches (925 mm) wide, with 48-inch (1,225-mm) cross aisles at the end; each aisle should be no more than seven or eight bookstack units long. A unit of shelving is 3 feet wide by seven shelves high. Major traffic aisles should be at least 60 inches (1,525 mm) wide. Floors should accommodate live loads of at least 150 pounds per square foot (PSF), or 7,200 pascals (Pa), for normal stack areas.

Libraries with collections located on more than one floor should be equipped with dumbwaiters large enough to accommodate a library cart or have access to a freight elevator.

Compact shelving for library collections should be considered (when funding is available) where appropriate to reduce the size of library collection space and meet the library's need for access. Floors supporting this type of shelving should accommodate live loads of at least 300 PSF (14,350 Pa).

The impact of increased automation (e.g., DVD and online materials) on shelf space and electronic equipment should be considered.

Archival Storage

Bookstacks and other space used for the storage of archival material should be planned with a particular concern for the effect of lighting and HVAC issues on the preservation of archival materials. Refer to [Chapter 15, "Building Systems,"](#) and the Archival Storage room data sheet for more information regarding requirements for this space.

Court Work Space Requirements

Work space requirements for judges and staff are influenced by the extent of pooled chambers law book collections and the proximity to chambers facilities. Court policies on the public use of the library also affect work space requirements.

Study Spaces, Meeting Rooms, and Collaborative Work Spaces

In libraries and unstaffed libraries, group study rooms should have adequate space for tables and chairs or study carrels, depending on court needs. To improve flexibility, tables may be considered rather than carrels.

Audiovisual Systems

Infrastructure should be considered in study carrels to support access to digital records, electronic court recordings, and internet reference materials. In addition, infrastructure to support presentations and video conferencing should be considered in meeting rooms.

Periodical Area

Periodical shelving units, newspaper racks, and magazine displays should be arranged with lounge chairs and side tables.

Technical Services Area

The technical services area should accommodate bookshelf units, worktables, book carts, supply cabinets, and file cabinets. In some libraries, staff workstations may be incorporated into this space. A built-in counter with a sink should be provided; other furnishings should

Table 7.1
Space Requirements for Court Libraries

Court Library Spaces	Circuit HQ Libraries		Satellite Libraries		Unstaffed Libraries	
	NSF	Nm ²	NSF	Nm ²	NSF	Nm ²
Library Spaces						
Public Entry/Lobby	200	18.6	100	9.3	-	-
Circulation/Reference Desk	500	46.5	200	18.6	-	-
Periodical Area	200	18.6	200	18.6	-	-
Computer-Assisted Legal Research (CALR) and Library Catalog: Public	292	27.1	96	8.9	-	-
Stack Area (9 NSF/21LF Shelves)	5,000	465	1,500	139.5	500	46.5
Study Area/Seating Area	700	65.1	408	37.9	204	19.0
Court Personnel Work Area: Two Staff @ 64 NSF	-	-	-	-	128	11.9
Office Spaces	NSF	Nm ²	NSF	Nm ²	NSF	Nm ²
Circuit Librarian	240	22.3	-	-	-	-
Circuit Librarian's Private Restroom ¹	56	5.2	-	-	-	-
Deputy Circuit Librarian	180	16.7	-	-	-	-
Professional Staff	150	13.9	150	13.9	-	-
Technical Staff	100	9.3	100	9.3	-	-

Table 7.1
Space Requirements for Court Libraries (cont'd)

Other Spaces	NSF	Nm ²	NSF	Nm ²	NSF	Nm ²
Copier/Scanner: Public	100	9.3	100	3.7	-	-
Copier/Scanner: Staff	50	4.6	50	4.6	50	4.6
Microform Area: Public & Staff 35 NSF (3.3 Nm ²)/Machine 15 NSF (1.4 Nm ²)/Cabinet	200	18.6	100	9.3	-	-
Supplies/Storage Area	100	9.3	100	9.3	100	9.3
Archival Storage ²	-	-	-	-	-	-
Technical Services Area	400	37.2	200	18.6	-	-
Freight Mail Receiving Area (9 NSF/Shelf)	200	18.6	100	9.3	-	-
Shelving Area	500	46.5	250	23.2	-	-

¹ This restroom does figure into the fixture count for the total staff toilet room requirements. If a court unit elects to include this space, the square footage should be offset from within the court unit's space envelope.

² Archival storage should be incorporated into a project on a case-by-case basis depending on the local needs. Refer to [Chapter 15, "Building Systems,"](#) and the room data sheet for an in-depth discussion of the requirements for this space.

be movable. Other special equipment, such as copiers, a fax machine, and microform reader/printer, may also be located in this area.

Microform Area (Patrons and Staff)

Carrels with microform readers/printers should be located near microform storage cabinets.

Because allowable live load requirements for microform storage cabinets can reach 500 PSF (23,950 Pa), equipment selection and location should be coordinated early in the planning process.

Copier Area (Patrons and Staff)

Each copier area contains a copier, a worktable or counter, and supply storage.

Space Allotments

Table 7.1 shows three area allotments because each circuit may have three types of libraries. The spaces shown in Table 7.1 for satellite libraries will apply as a limit to all new satellite libraries. For circuit headquarters libraries and existing satellite libraries, library space requirements are determined by the circuit librarian with the approval of the circuit judicial council. The spaces shown in Table 7.1 are intended as a baseline; actual spaces are determined by the program of requirements. Refer to Table 7.1 as a guideline for specific library space size criteria. Justification for changes to the standard sizes to meet the operational needs of the court without exceeding the envelope of space must be demonstrated to and approved by the circuit judicial council.

Adjacency and Circulation

All libraries require accessibility from restricted circulation areas, although public access can also be required. Libraries should accommodate evening and weekend hours without compromising security. Entrances and exits should be located so that library staff can monitor them during on-duty hours.

Library Components

Computer-Assisted Legal Research (CALR)

CALR stations should be located where they can be closely monitored by library staff. Rooms devoted to CALR training or general training purposes should be considered. When such training rooms are created, they should be designed to allow other uses for the space with minimal modifications. Examples of this would be a reduced reliance on fixed furniture or building features.

Staff Offices

Library staff offices should be located near entrance and circulation/reference areas. Technical staff require workstations in or near the technical services area.

Copier Room (Patrons and Staff)

The public copier/scanner(s) should be located near the circulation/reference areas. The staff copier/scanner should be located near the staff offices and technical services area.

Support Spaces

Areas for supply storage, general storage, mail room, freight staging, and shelving should be located near the technical services area. In addition, the freight staging area should be conveniently accessible to the building loading dock.

Refer to the adjacency diagrams in Figures 7.1 through 7.3 for additional information regarding adjacency and circulation in libraries.

These adjacency diagrams should be interpreted to respond to the specific space and ceiling requirements for the circuit headquarters, satellite, and unstaffed libraries as determined by the court and circuit librarian and approved by the circuit judicial council. The number of spaces shown on the adjacency diagrams is for illustrative purposes only; the building program determines the actual number of spaces required for a specific facility. The design team should refer to Chapter 3, “Planning for U.S. Courthouses,” for circulation factors.

Figure 7.1
Circuit Headquarters Library Adjacency Relationships

Colors Legend:

Chapter 7
Court Libraries

Symbols Legend:

- Public Circulation
- Public Vertical Circulation
- Restricted Circulation
- Restricted Vertical Circulation
- Service Vertical Circulation
- Circulation Access Control Point

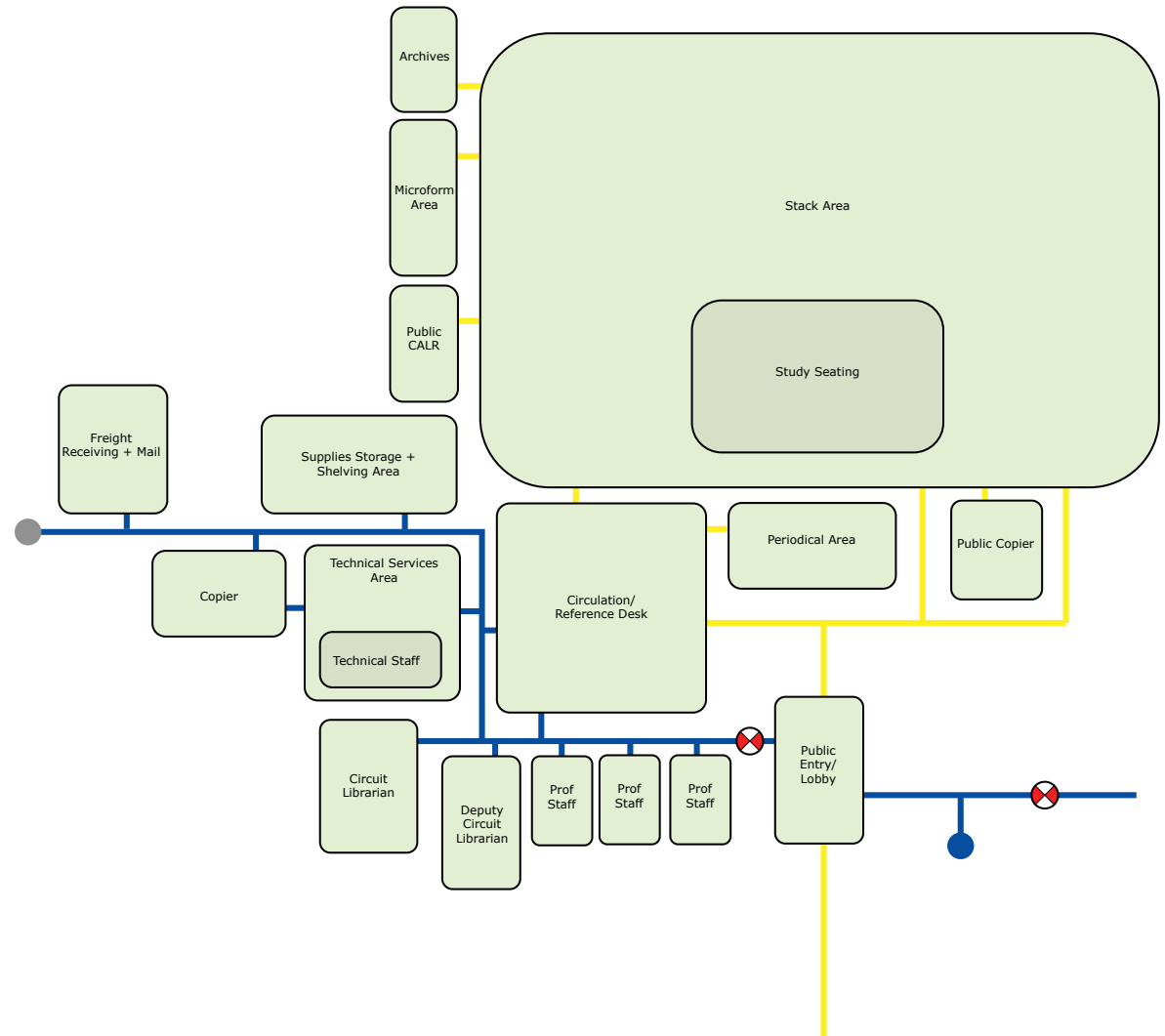







Note: The adjacency diagram is intended only as an illustration.

Figure 7.2
Satellite Libraries Adjacency Relationships

Colors Legend:

 **Chapter 7**
Court Libraries

Symbols Legend:

-  Public Circulation
-  Public Vertical Circulation
-  Restricted Circulation
-  Restricted Vertical Circulation
-  Service Vertical Circulation
-  Circulation Access Control Point

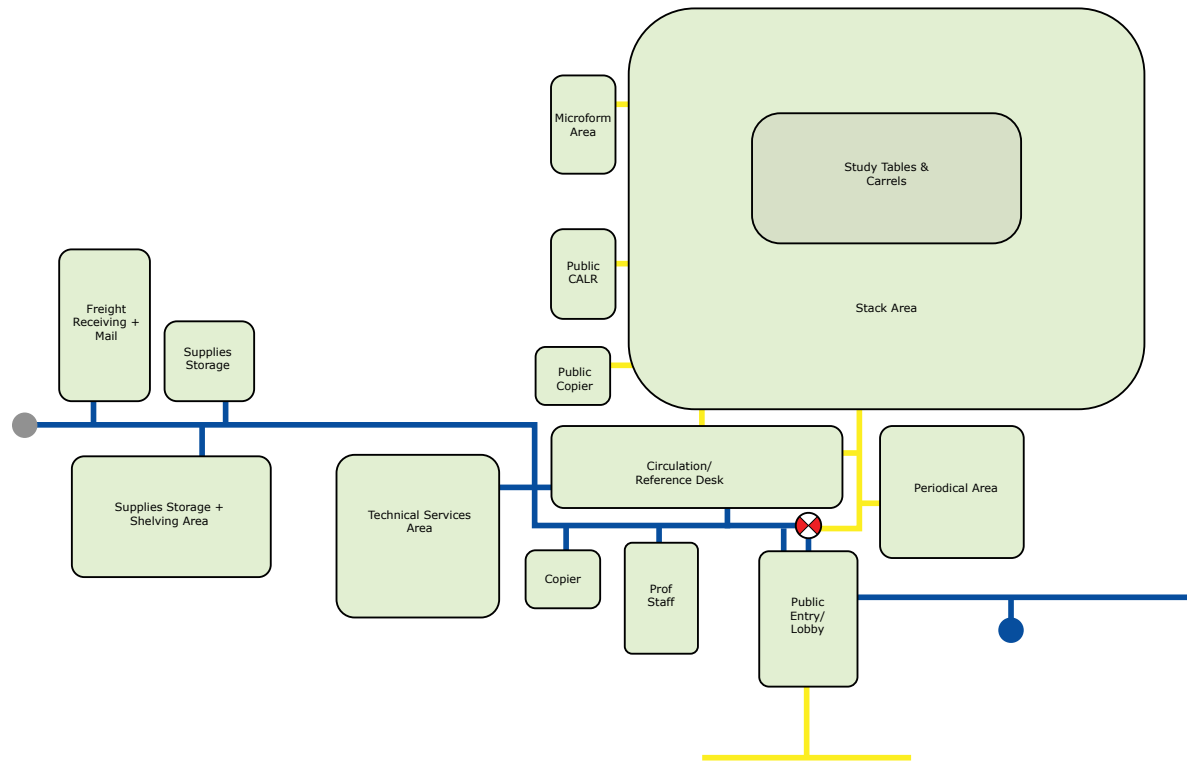







Note: The adjacency diagram is intended only as an illustration.

Figure 7.3
Unstaffed Libraries Adjacency Relationships

Colors Legend:

 **Chapter 7**
Court Libraries

Symbols Legend:

-  Public Circulation
-  Public Vertical Circulation
-  Restricted Circulation
-  Restricted Vertical Circulation
-  Service Vertical Circulation
-  Circulation Access Control Point

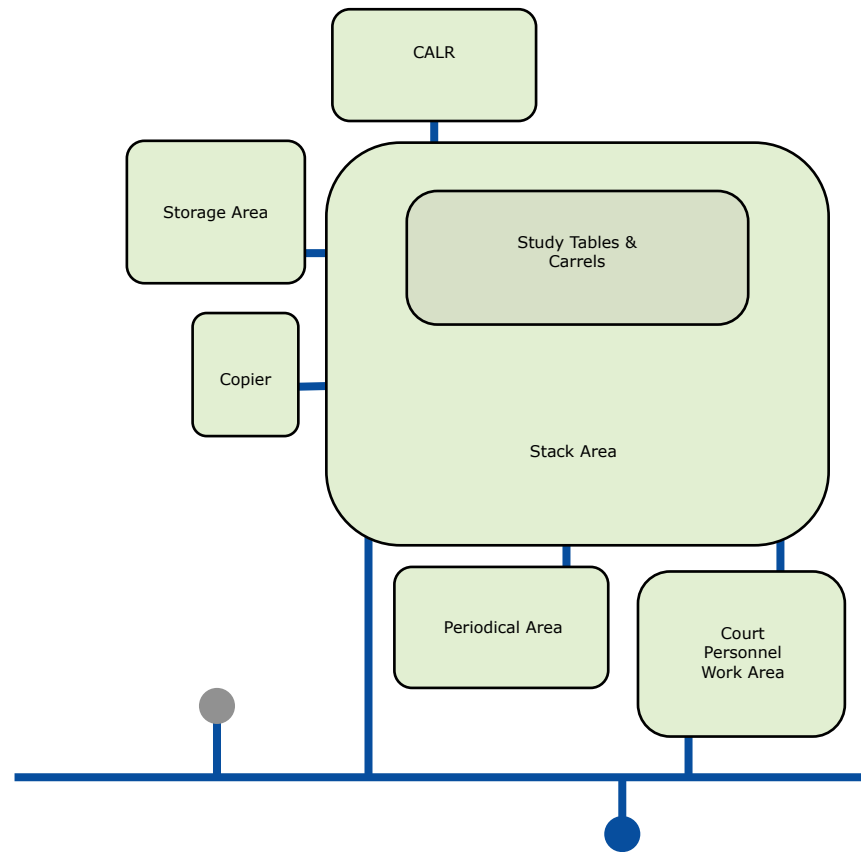

Note: The adjacency diagram is intended only as an illustration.



CLERK'S OFFICE

This chapter applies to the clerks' offices of the U.S. Court of Appeals (USCA), the U.S. District Court (USDC), and the U.S. Bankruptcy Court (USBC). It describes functions and activities, users and capacities, design requirements, and space allocation requirements. It also includes adjacency diagrams.

Chapter Topics:

- Supporting Documents
- Programming and Budgetary Notes
- Functions and Activities
- Users and Capacities
- Design Requirements
- Adjacency and Circulation

Chapter Figures and Tables:

Figure 8.1	Court of Appeals Clerk's Office Adjacency Relationships
Figure 8.2	District and Bankruptcy Clerks' Offices Adjacency Relationships
Table 8.1	Space Requirements for the Clerk's Office

Supporting Documents

A comprehensive guide to supporting documents can be found in [Chapter 2, “Courthouse Programming and Budgetary Considerations.”](#) That listing includes program and design criteria, courthouse planning and related guidelines, policies, and information on many facets of the design and construction of federal courthouses. The reference listed below relates specifically to this chapter.

- *United States Courts, Courthouse Design Reference Manual: An Architect’s Desk Reference*, most current edition, Chapter 9.

Programming and Budgetary Notes

Programming and budgetary notes found throughout the *Design Guide* provide assistance with decisions to be made during the development of courthouse projects. The notes include both judicial branch policy and lessons learned from completed projects. The notes supplement the criteria in the *Design Guide*; their purpose is to provide direction in using the flexibility of the *Design Guide* to develop justifiable and cost-effective federal courthouse projects.

Space Envelope Flexibility

A total space envelope for new space will be calculated using appropriate circulation factors, allowances for support-type spaces, and the space standards described in the *Design Guide*. Courts have the flexibility to configure space within the envelope to meet their local needs. However, design and construction should be in general compliance with the square footage standards designated in the *Design Guide* in the space and ceiling requirements tables. If the court unit wishes to significantly change the space standards described in the space and ceiling requirements tables without exceeding the total envelope of space for the unit, it must seek approval from its respective circuit judicial council.

The space envelope for a respective court unit is defined as:

- Entire clerk’s office
- Entire probation office
- Entire pretrial services office
- Entire staff attorney’s office
- Entire circuit executive’s office
- All courtrooms designated by judge type (circuit judges, district judges, magistrate judges, and bankruptcy judges)
- All chambers designated by judge type (circuit judges, district judges, magistrate judges, and bankruptcy judges)

For existing space, courts have the flexibility to configure space within the existing envelope to meet their local needs. However, any significant departure from the square footage standards designated in the *Design Guide* in the space and ceiling requirements tables must be approved by the respective circuit judicial council. This does not mean that existing space must be changed to meet *Design Guide* standards. Only new construction completed as part of a renovation should be considered.

Renovations and Alterations (R&A)

Many of the construction projects conducted in the Judiciary are renovations to existing space. Although the *Design Guide* applies to these projects, it is understood that some standards in the *Design Guide* are difficult or impossible to achieve in existing space, particularly in historic buildings. Courts should consult [Chapter 17, “Renovations and Alterations \(R&A\),”](#) and [Facilities Standards for the Public Buildings Service \(GSA PBS P-100\)](#) for guidance in these circumstances. References to R&A guidelines are also included throughout the *Design Guide* where appropriate.

Exceptions to the *Design Guide* Standards

The *Design Guide* provides guidance on standards for courthouse construction and renovations to existing space. Any significant departure from these standards is considered an exception and must be approved by the respective authority as outlined below.

Authority of the Circuit Judicial Councils

Circuit judicial councils play an important space-management role by reviewing district-wide facility plans, approving requests for new or modified space, and enforcing adherence to design guidelines. The circuit judicial councils have authority over, and responsibility for, a circuit’s space-management program (28 USC §332 and §462(b)) and for determining the need for space. As directed by the Judicial Conference of the United States (JCUS), any significant departure from the standards in the *Design Guide* must be approved by the respective circuit judicial council.

Authority of the Committee on Space and Facilities

The authority to approve the following exceptions to the *Design Guide* standards rests with the Committee on Space and Facilities: (1) exceeding the total envelope for either the court unit or the project as a whole, (2) changing the standard configurations for judges’ chambers and courtrooms, and (3) exceeding the plumbing standards. If the Committee on Space and Facilities disagrees with a circuit judicial council request for one of these exceptions, the Judicial Conference will decide whether to grant the exception.

Authority of the Judicial Conference

The authority for approving any exception to prospectus-level courthouse projects that would result in additional estimated costs, including additional rent payment obligations, lies with the Judicial Conference. Approval is required, after review by the Committee

on Space and Facilities, for any exception to the *Design Guide* approved by a circuit judicial council. The request must include (1) a justification for the exception and (2) a construction cost estimate. [All approved exceptions for prospectus-level projects](#) are reported to the General Services Administration (GSA) and Congress. Approved exceptions may require the project to be reauthorized by Congress if the exception had not been previously identified. Contact the Administrative Office of the U.S. Courts (AOUSC) for more detailed information.

For prospectus-level courthouse projects, if an exception is approved by the JCUS which would result in additional estimated costs, the chair of the circuit's space and facilities committee or the chief judge or other judge designated by the court that sought the exception that exceeds the *Design Guide* criteria must be willing, if requested by the Committee on Space and Facilities, to appear before Congress concerning funding for such construction.

General Programming Notes

The *Design Guide* is intended to be a performance document. Criteria for any space or grouping of spaces should be considered in conjunction with the specific needs of the court office or function for which space is being designed.

Criteria in the *Design Guide* do not represent space entitlements. The criteria apply to an array of space types that should be justified based on the specific purpose of each project. Facility plans, programs, and designs should include only the space needed to satisfy the functional and security requirements of the court.

Differences between the space in an existing facility and the criteria in the *Design Guide* are not justification for facility alteration and expansion. In such cases, alternatives to space expansion are investigated before any additional space is requested. In addition, like-for-like space is not a guarantee. Space allocated in an existing location is not justification for the same amount of space in a new location if the space allocation is not warranted. Current needs should be evaluated when moving into new space to determine the appropriate space envelope. Any additional space must be approved by the appropriate authority. Design architects and court staff are prohibited from adding spaces not originally contemplated in the approved prospectus or design program. Increasing the floor area or building volume requires the necessary approvals.

General Budgetary Notes

Renovation and new construction occur when the court and circuit judicial council identify space needs through the Judiciary's asset management planning process and document these needs in the long-range facilities plan. GSA determines by what method the space is provided—for example, by the construction of a new building, the renovation of an existing building, a lease, or other means.

The Judicial Conference recognizes and strongly supports a pragmatic approach to design that includes the use of durable and sustainable materials. This approach ensures that courthouses constructed now will last well into the future.

Following the publication of the *2007 Design Guide*, the Judiciary introduced several cost-saving measures, such as courtroom sharing and the Integrated Workplace Initiative (IWI), that sought to provide flexibility and efficiency in court spaces while preserving the dignity of the Judiciary. Courtroom sharing for certain judge types is now a standard throughout the Judiciary, and IWI is recognized as an alternative to traditional office design. For more information on cost- and space-saving efforts and programs, contact the AOUSC Space and Facilities Division.

General Space Notes

Space Standards for Clerk's Office Personnel

Space standards in the *Design Guide* for clerk's office personnel should be allocated according to benchmark occupational groups described in the Judiciary's *Human Resources Manual* and the clerk's office space requirements table, [Tables 8.1](#), in this chapter.

Shared Spaces

Any decision to share various space areas should be left to the discretion of the courts and court units; the design team should consult with the courts and AOUSC. The sharing of various space areas between different courts and units should be considered when courts are collocated in the same building, but only when doing so would be practical and economical and would not compromise functional ability. This includes shared space with the U.S. Marshals Service (USMS) and federal public defender. A court should consult with the circuit judicial council and the AOUSC prior to making any decision or agreement.

Conference and Training Spaces

Conference and training rooms in the clerk's office should accommodate the number of managers and first-line supervisors. Refer to the clerk's office space requirements for specific size criteria. Requirements for larger conference and training spaces should be accommodated in shared conference/training rooms or multi-use spaces within the courthouse. Courts which require conference rooms with more square footage than allotted in the clerk's office space requirements table, [Tables 8.1](#), may configure space to meet the court's needs within the given space envelope. Courts should reference strategies outlined in [Chapter 18, "Alternative Workplace Strategies,"](#) when determining their local conference room needs. However, any significant departure from the standards and strategies provided in this chapter and Chapter 18 must be approved by the circuit judicial council.

Staff Toilet Rooms and Breakrooms

Staff toilets are provided for security reasons and to ensure there is no inappropriate staff contact with attorneys, parties, or other case participants that might compromise the judicial process.

The staff toilets and breakrooms should be located within restricted circulation on floors with court-related offices. For courthouses housing more than one court unit, the design team should consider a shared staff breakroom. If separate staff toilets are necessary, the total number of staff toilets will be determined during design utilizing the most current edition of the *International Plumbing Code*. Plumbing fixtures required to serve a given floor shall be proportionally split between the staff and public occupant loads. Consult with the AOUSC for more detailed information.

Functions and Activities

A clerk's office receives documents and filing fees from attorneys; maintains case dockets and court calendars; distributes court directives, including notices, subpoenas, and summonses; responds to public inquiries; and serves as a central source of public information for the court. In addition, each clerk's office performs the specialized functions required by the particular court it serves. For example, the USDC clerk's office is responsible for processing petit and grand jurors and coordinating naturalization ceremonies. Additionally, each clerk's office performs substantial administrative functions to support the court, which include finance and budget, procurement, facilities, information technology, human resources, and training.

The level and type of activity at the clerk's public intake counter varies greatly with the type of court served. The appellate courts differ significantly from the other two types of courts in terms of the nature of the cases heard. The USCA clerk's office continues to manage a high volume of paper case filings and may also provide public reception services for the staff attorney's office. Most business is conducted by mail. Public traffic volume is generally low except on hearing days, when attorney traffic can be relatively high. The USDC and USBC clerks' offices generally experience peaks of public traffic at the counter in the early morning and afternoon, with a constant but moderate stream of traffic throughout the remainder of the day. However, with the implementation of electronic case filing, public traffic at the counter is decreasing. Additional space may be required behind the counter for additional monitors, printers, scanners, and other types of office equipment. A large clerk's office can establish a separate counter to accommodate various activities, such as pro se filings. The space and operational needs required to accommodate pro se litigants is unique to each court and additional space may be accommodated within the court's space envelope with the appropriate circuit judicial council approval of the space requirements.

Due to electronic case filing, the USDC and USBC clerks' offices no longer experience a large volume of public visitors but do require larger spaces for the public to access documents at a computer access station, either in the public area or the records examination area. Spaces are provided for the public to view, print, and/or scan documents.

Users and Capacities

Users vary depending on the size of the courthouse; the type and volume of cases; and the number of maintenance staff, service company/agency personnel, and public individuals present. For the purposes of certain references in this *Design Guide*, the following designations apply:

A small courthouse has five or fewer courtrooms.

A medium courthouse has 6-12 courtrooms.

A large courthouse has 13-18 courtrooms.

An extra-large courthouse has more than 18 courtrooms.

U.S. Court of Appeals Clerk's Office

User capacity varies depending upon the number of USCA clerk's office staff, circuit judges and support staff, other USCA staff (e.g., staff attorneys), private and government attorneys, legal messenger services, news media representatives, and the general public.

U.S. District Court Clerk's Office

User capacity varies depending upon the number of USDC clerk's office staff; district judges, magistrate judges, and support staff; court reporters/recorders; private and government attorneys; legal messenger services and other attorney support services; title companies and other private concerns researching court records; news media representatives; pro se litigants; and the general public.

U.S. Bankruptcy Court Clerk's Office

User capacity varies depending upon the number of USBC clerk's office staff, bankruptcy judges and support staff, bankruptcy administrator staff (where applicable), court reporters/recorders, U.S. Trustee staff, private and government attorneys, legal messenger services and other attorney support services, title companies and other private concerns researching court records, private copying vendors, news media representatives, pro se litigants, and the general public.

Design Requirements

The design requirements for the clerk’s office outlined in this chapter is detailed in the following information. Specific space requirements can be found in [Table 8.1](#) and the room data sheets.

Ceiling Height

The ceiling is a designed surface. It may be uniformly flat, or it may have two or more planes and include elements such as soffits, perimeter coves, recesses, and reveals as required to integrate HVAC and lighting into a harmonious design. An adjustment of a ceiling surface may also occur where it meets an exterior curtain wall to accommodate different equipment. In situations where there are several different surfaces at different heights above the finished floor, there may be different ways of determining which one is the dominant plane. Ceiling heights should be measured from the finished floor to the dominant surface that either covers the most amount of ceiling square footage, or the surface that defines the overall character of the ceiling design. The design team should ensure that in all newly constructed spaces the dominant plane of the ceiling does not exceed the maximum ceiling height of 12 feet (3,660 mm) above finished floor for the clerk’s office and associated spaces. Dominant planes that exceed this maximum height are considered an exception unless the space is in an area envisioned for a future courtroom or on a floor with a higher floor-to-floor height. The application of this maximum ceiling height in renovation and alteration projects may be dependent on limitations of existing conditions.

The ceiling height should be in proportion to the area of the space. If the space is located on a floor with a higher floor-to-floor height, the ceiling height of the room may be designed to maximize use of available natural light, volume, and window configuration of that space.

Public Counter

A reception counter is provided with counter-to-ceiling break-resistant glazing. For the counter, a durable work surface 26-30 inches deep at stand-up height with a divider to the floor below should be provided. It is recommended that the counter extend 12 inches on the public side of the partition. The counter should accommodate a computer monitor, keyboard, and mouse on the staff side. The counter should accommodate a document-sized deal tray transaction opening for each station provided.

Information Technology (IT) Support Spaces

As technology continues to become more prevalent in courthouses, demand for additional IT support has grown exponentially. Specific IT space requirements are often overlooked and retroactively incorporated into the clerk’s office space envelope since IT is often under the purview of the clerk of court. IT staff and services are often shared among different court units, so it is becoming more frequent for IT to report to a separate, shared support court unit.

Mail Room

Requirements for the central mail facilities are provided in [Chapter 11, “Shared Support Spaces.”](#) Within the clerk’s office, a space is required for the sorting and distribution of mail after it has been opened in and delivered from the central mail facility.

Acoustics

The public counter area should be acoustically separate from adjacent open work areas. Acoustic requirements are provided in [Chapter 14, “Acoustics.”](#)

Video

Audiovisual requirements are provided in [Chapter 15, “Building Systems.”](#)

Table 8.1
Space Requirements for the Clerk's Office

Court of Appeals Clerks' Offices		
Private Offices	NSF	Nm ²
Clerk	240	22.3
Clerk's Private Restroom ¹	56	5.2
Clerk of Court Visiting Office	150	14.0
Chief Deputy Clerk	180	16.7
Manager	180	16.7
Professional Administrative and Line Positions	150	14.0
Attorney	150	14.0
Open Workstations	NSF	Nm ²
Executive Secretary/Reception Area	170	15.8
Operational and Administrative First-Line Supervisor	96	8.9
Operational and Administrative Court Support Positions	64	5.6
Counter and Cashier Workstation	45	4.2
Public Areas	NSF	Nm ²
Queuing/Work Areas	105	9.8
Public Counter (including cashier stations)/per person	5 LF	1.52 Lm
Accessory Stand-up Work Counter/per person	25	2.3
Plus Open Area	100	9.3
Public Pay Printer/Copier/Scanner	100	9.3
Records Exam Area/per person	25	2.3
Plus Open Area	125	11.6
Public Access Computer Station	35	3.3

General Office Spaces	NSF	Nm ²
Facility Access Card Identification (FAC ID) Room	120	11.2
Secured Records Storage, per shelf unit	9	0.9
Active Records Storage, per shelf unit	9	0.9
Inactive Records Storage, per shelf unit	9	0.9
Transfer Box Storage	50	4.7
Work Area ²	195	18.1
Supplies (min/max)	150/300	14.0/27.9
Forms Storage	150	14.0
Equipment Storage (min/max)	150/300	14.0/27.9
Financial Vault	150	14.0
Low Volume Copier Area (per copier)	50	4.7
Medium Volume Copier Area (per copier)	80	7.4
High Volume Copier Area (per copier)	120	11.2
Conference Room (fewer than 20 occupants)	300	27.9
Conference Room (20 or more occupants)	400	37.2
Computer Training Room		
Small/Medium Courthouse (12 or fewer courtrooms)	200	18.6
Large Courthouse (13 or more courtrooms)	300	27.9
Printer/Copier/Fax Area	60	5.6
Evidence Vault (min/max)	80/150	7.4/14.0
Shredder	25	2.3
Staff Breakroom ³ (min/max)	200/600	18.6/55.8
Staff Toilets ⁴	-	-
Exhibit Storage Room	100	9.3
Coat Closets	20	1.9

Mail Work Area	100	9.3
Safe	20	1.9
District and Bankruptcy Clerks' Offices		
Private Offices	NSF	Nm ²
Clerk	240	22.3
Clerk's Private Restroom ¹	56	5.2
Clerk of Court Visiting Office	150	14.0
Chief Deputy Clerk	180	16.7
Deputy Clerk in Charge	180	16.7
First-Line Supervisors	180	16.7
Manager	180	16.7
Professional Administrative and Line Positions	150	14.0
Courtroom Deputy ⁵	150	14.0
Pro se Law Clerk/Staff Attorney	150	14.0
Open Workstations	NSF	Nm ²
Executive Secretary/Reception Area	170	15.8
Operational and Administrative Support First-Line Supervisor	96	8.9
Deputy Clerk	64	5.6
Public Areas		
Public Counter and Clerk Workstation, Including Cashier Stations		
Small Courthouse (five or fewer courtrooms) 10 LF of Counter Space @ 10 ft depth	100	9.3
Medium Courthouse (6-12 courtrooms) 15 LF of Counter Space @ 10 ft depth	150	14.0
Large Courthouse (13 or more courtrooms) 25 LF of Counter Space @ 10 ft depth	250	18.6

Public Scanning Workstation, and Public Pay Copier (PACER Workstation)		
Small Courthouse (five or fewer courtrooms) Two Open Workstations at 64 NSF (51.1 Nm ²) Plus Open Area	128 110	11.8 10.2
Medium Courthouse (6-12 courtrooms) Three Open Workstations at 64 NSF (51.1 Nm ²) Plus Open Area	192 110	17.7 10.2
Large Courthouse (13 or more courtrooms) Five Open Workstations at 64 NSF (51.1 Nm ²) Plus Open Area	320 110	29.5 10.2
Records Exam Area		
Small Courthouse (five or fewer courtrooms)	100	9.3
Medium Courthouse (6-12 courtrooms)	150	14.0
Large Courthouse (13 or more courtrooms)	180	16.7
Public Access Computer Station	35	3.3
Queuing Area		
Small Courthouse (five or fewer courtrooms)	100	9.3
Medium Courthouse (6-12 courtrooms)	150	14.0
Large Courthouse (13 or more courtrooms)	180	16.7
General Office Spaces		
Facility Access Card Identification (FAC ID) Room	120	11.2
Secured Records Storage, per shelf unit	9	0.9
Active Records Storage, per shelf unit	9	0.9
Inactive Records Storage, per shelf unit	9	0.9
Transfer Box Storage	50	4.7
Work Area ²	195	18.1
Supplies (min/max)	50/100	4.7/9.3
Equipment Storage (min/max)	50/150	4.7/14.0

Financial Vault	150	14.0
Low Volume Copier Area (per copier)	50	4.7
Medium Volume Copier Area (per copier)	80	7.4
High Volume Copier Area (per copier)	120	11.2
Conference Room (fewer than 20 occupants)	300	27.9
Conference Room (20 or more occupants)	400	37.2
Computer Training Room (min/max)	200/300	18.6/27.9
Printer/Copier/Fax Area	60	5.6
Evidence Vault (min/max)	80/150	7.4/14.0
Shredder	25	2.3
Staff Breakroom ³ (min/max)	200/600	18.6/55.8
Staff Toilets ⁴	-	-
Exhibit Storage Room	100	9.3
Coat Closets	20	1.9
Mail Work Area	100	9.3
Safe	20	1.9

Information Technology (IT)

Support Spaces	NSF	Nm ²
IT Workroom		
Small Courthouse (five or fewer courtrooms)	100	9.3
Medium Courthouse (6-12 courtrooms)	200	18.6
Large Courthouse (13-18 courtrooms)	250	23.2
Extra-Large Courthouse (more than 18 courtrooms)	300	27.9

Staging/ Processing Area

Small Courthouse (five or fewer courtrooms)	120	11.1
Medium Courthouse (6-12 courtrooms)	300	27.9
Large Courthouse (13-18 courtrooms)	400	37.2
Extra-Large Courthouse (more than 18 courtrooms)	500	46.5

Equipment Storage

Small Courthouse (five or fewer courtrooms)	150	13.9
Medium Courthouse (6-12 courtrooms)	250	23.2
Large Courthouse (13-18 courtrooms)	550	51.1
Extra-Large Courthouse (more than 18 courtrooms)	700	65.0

Supply Storage

Small Courthouse (five or fewer courtrooms)	100	9.3
Medium Courthouse (6-12 courtrooms)	200	18.6
Large Courthouse (13-18 courtrooms)	400	37.2
Extra-Large Courthouse (more than 18 courtrooms)	600	55.7

¹ This restroom does figure into the fixture count for the total staff toilet room requirements. If a court unit elects to include this space, the square footage should be offset from within the court unit's space envelope.

² Space allowance for work area: 15 NSF (1.4Nm²) per staff member. Minimum area is 195 NSF (18.1 Nm²)

³ Area requirements for staff breakroom: Allocate 25 NSF (2.3 Nm²) for every three staff members plus 20 NSF (1.9 Nm²) for a service unit. The minimum staff breakroom is to be 200 NSF (18.6 Nm²), and the maximum staff lounge is to be 600 NSF (55.8 Nm²).

⁴ Total staff toilet requirements are to be determined in design by the *International Plumbing Code*, most current edition. Plumbing fixtures required to serve a given floor should be proportionally split between the staff and public occupant loads.

⁵ If not included in chamber.

Adjacency and Circulation

Convenient and direct circulation should be provided for all clerks' offices due to the potential volume of public traffic ([Figures 8.1 and 8.2](#)). Clerk's office and court staff should have quick and convenient restricted access to and from each courtroom and chambers. Additionally, district clerk's office staff should have convenient restricted access to and from the jury assembly area.

The number of spaces shown on the adjacency diagrams ([Figures 8.1 and 8.2](#)) is for illustrative purposes only; the actual number of spaces required for a specific facility is determined in the project AnyCourt program.









The design team should refer to [Chapter 3, "Planning for U.S. Courthouses,"](#) for circulation factors.

Figure 8.1
Court of Appeals Clerk's Office Adjacency Relationships

Colors Legend:

 **Chapter 8**
Clerk's Office

Symbols Legend:

-  Public Circulation
-  Public Vertical Circulation
-  Restricted Circulation
-  Restricted Vertical Circulation
-  Secure Circulation
-  Secure Vertical Circulation
-  Service Vertical Circulation
-  Circulation Access Control Point

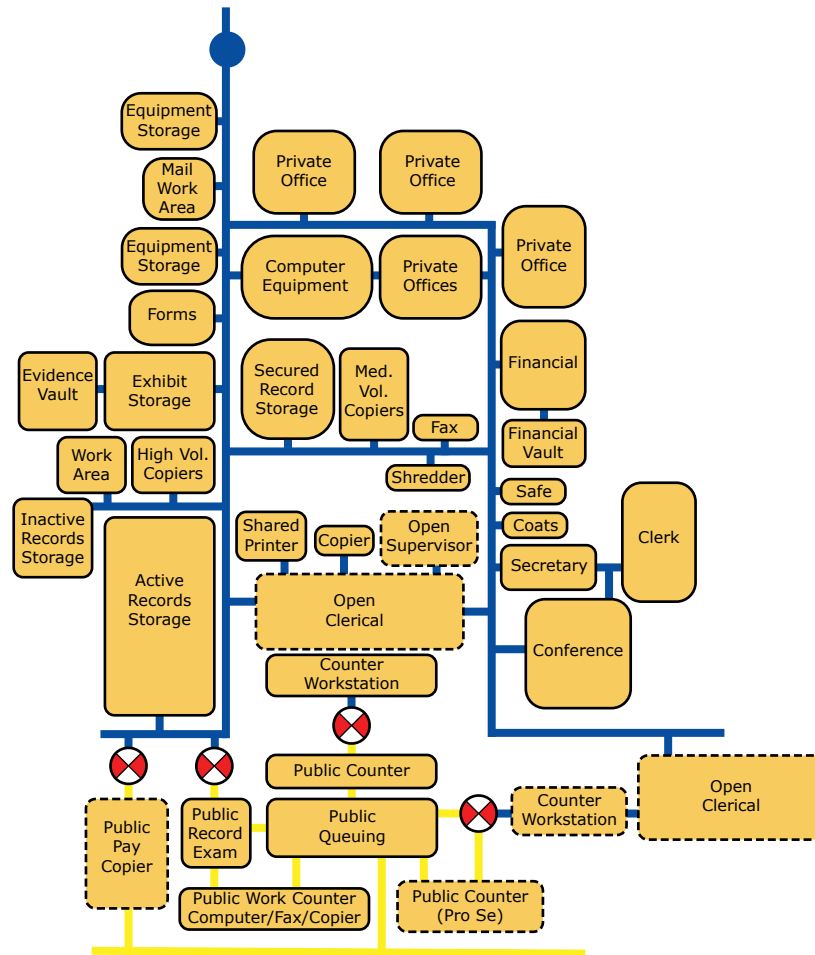

Note: The adjacency diagram is intended only as an illustration.









Figure 8.2

District and Bankruptcy Clerks' Offices Adjacency Relationships

Colors Legend:

 **Chapter 8**
Clerk's Office

Symbols Legend:

-  Public Circulation
-  Public Vertical Circulation
-  Restricted Circulation
-  Restricted Vertical Circulation
-  Secure Circulation
-  Secure Vertical Circulation
-  Service Vertical Circulation
-  Circulation Access Control Point

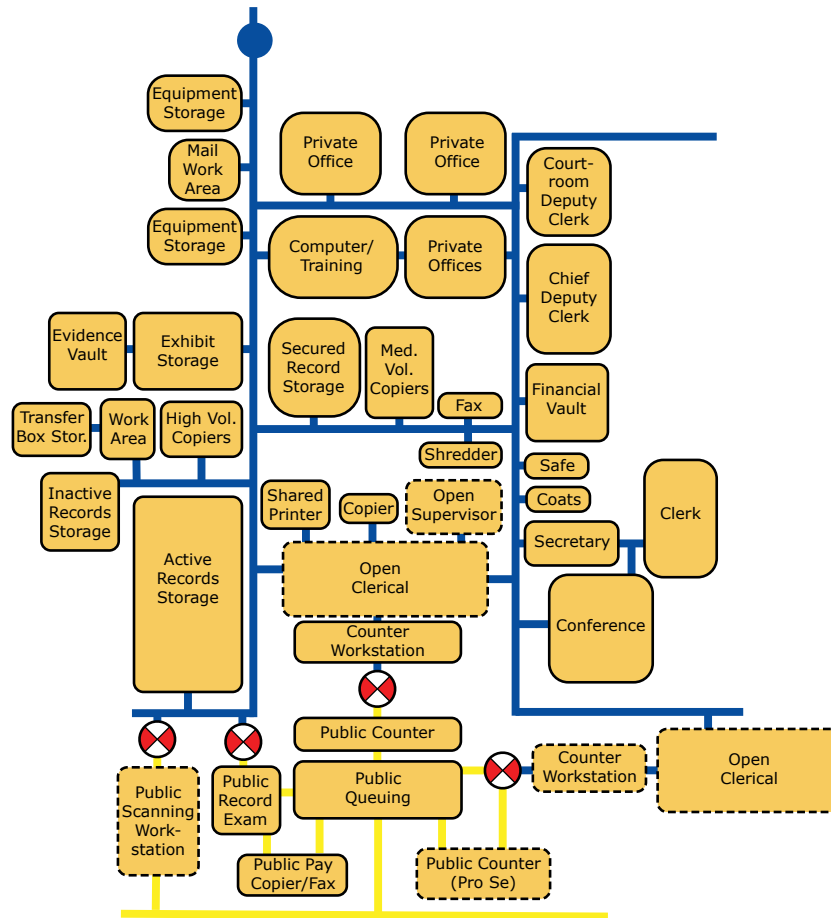

Note: The adjacency diagram is intended only as an illustration.



PROBATION AND PRETRIAL SERVICES OFFICES

This chapter applies to the U.S. Pretrial Services Office and the U.S. Probation Office, which are components of the U.S. District Court. In some courts the offices function independently of each other, and in other courts they are a combined unit. This chapter describes their functions and activities, users and capacities, design requirements, and space allocation requirements, and contains adjacency diagrams.

Chapter Topics:

- Introduction
- Supporting Documents
- Programming and Budgetary Notes
- Functions and Activities
- Users and Capacities
- Design Requirements
- Adjacency and Circulation

Chapter Figures and Tables:

Figure 9.1 Probation and Pretrial Services Offices Adjacency Relationships
Table 9.1 Space Requirements for Probation and Pretrial Services Offices

Introduction

The primary mission of the U.S. Pretrial Services Office (PSO) and the U.S. Probation Office (PO) is essentially the same, which is to provide the court with thorough, verified information on individuals to enable informed release or detention decisions. The PSO and PO both supervise persons released into their custody, reasonably ensure community safety, and investigate and supervise persons referred to diversion programs. Their goal is also essentially the same, which is the successful completion of the term of supervision, during which an individual commits no new crimes, is held accountable for his or her actions and responsibilities toward others, and prepares for continued success through improvements in his or her conduct and condition. The main difference between the PSO and the PO is the time period when each is engaged with an individual, with the transfer of responsibility from the PSO to the PO coming at the time the defendant has been convicted of a crime. Because of their shared mission, the PO and PSO are often collocated into one office space.

Main and satellite offices for the PSO and PO provide a unique opportunity to apply alternative workplace strategies (AWS) because these departments employ a workforce that travels frequently to conduct fieldwork. Because of the high amount of teleworking and fieldwork, it is highly recommended that PSO and PO workplaces consider AWS to improve collaboration and operational efficiency. When implementing an AWS workplace, the stakeholders determine the degree of implementation based on the nature of the work being conducted and on the regional and office culture. In order to best facilitate this process, it is important that consideration for AWS be discussed at the very beginning of the project. For more information regarding the implementation of AWS, refer to [Chapter 18, “Alternative Workplace Strategies.”](#)

Supporting Documents

A comprehensive guide to supporting documents can be found in [Chapter 2, “Courthouse Programming and Budgetary Considerations.”](#) That listing includes program and design criteria, courthouse planning and related guidelines, policies, and information on many facets of the design and construction of federal courthouses. The reference listed below relates specifically to this chapter.

- *United States Courts, Courthouse Design Reference Manual: An Architect’s Desk Reference*, most current edition, Chapter 10.

Programming and Budgetary Notes

Programming and budgetary notes found throughout the *Design Guide* provide assistance with decisions to be made during the development of courthouse projects. The notes include both judicial branch policy and lessons learned from completed projects. The notes supplement the criteria in the *Design Guide*; their purpose is to provide direction in using the flexibility of the *Design Guide* to develop justifiable and cost-effective federal courthouse projects.

Space Envelope Flexibility

A total space envelope for new space will be calculated using appropriate circulation factors, allowances for support-type spaces, and the space standards described in the *Design Guide*. Courts have the flexibility to configure space within the envelope to meet their local needs. However, design and construction should be in general compliance with the square footage standards designated in the *Design Guide* in the space and ceiling requirements tables. If the court unit wishes to significantly change the space standards described in the space and ceiling requirements tables without exceeding the total envelope of space for the unit, it must seek approval from its respective circuit judicial council.

The space envelope for a respective court unit is defined as:

- Entire clerk’s office
- Entire probation office
- Entire pretrial services office
- Entire staff attorney’s office
- Entire circuit executive’s office
- All courtrooms designated by judge type (circuit judges, district judges, magistrate judges, and bankruptcy judges)
- All chambers designated by judge type (circuit judges, district judges, magistrate judges, and bankruptcy judges)

For existing space, courts have the flexibility to configure space within the existing envelope to meet their local needs. However, any significant departure from the square footage standards designated in the *Design Guide* in the space and ceiling requirements tables must be approved by the respective circuit judicial council. This does not mean that existing space must be changed to meet *Design Guide* standards. Only new construction completed as part of a renovation should be considered.

Renovations and Alterations (R&A)

Many of the construction projects conducted in the Judiciary are renovations to existing space. Although the *Design Guide* applies to these projects, it is understood that some standards in the *Design Guide* are difficult or impossible to achieve in existing space, particularly in historic buildings. Courts should consult [Chapter 17, “Renovations and](#)

Alterations (R&A),” and *Facilities Standards for the Public Buildings Service (GSA PBS P-100)* for guidance in these circumstances. References to R&A guidelines are also included throughout the *Design Guide* where appropriate.

Exceptions to the *Design Guide* Standards

The *Design Guide* provides guidance on standards for courthouse construction and renovations to existing space. Any significant departure from these standards is considered an exception and must be approved by the respective authority as outlined below.

Authority of the Circuit Judicial Councils

Circuit judicial councils play an important space-management role by reviewing district-wide facility plans, approving requests for new or modified space, and enforcing adherence to design guidelines. The circuit judicial councils have authority over, and responsibility for, a circuit’s space-management program (28 USC §332 and §462(b)) and for determining the need for space. As directed by the Judicial Conference of the United States (JCUS), any significant departure from the standards in the *Design Guide* must be approved by the respective circuit judicial council.

Authority of the Committee on Space and Facilities

The authority to approve the following exceptions to the *Design Guide* standards rests with the Committee on Space and Facilities: (1) exceeding the total envelope for either the court unit or the project as a whole, (2) changing the standard configurations for judges’ chambers and courtrooms, and (3) exceeding the plumbing standards. If the Committee on Space and Facilities disagrees with a circuit judicial council request for one of these exceptions, the Judicial Conference will decide whether to grant the exception.

Authority of the Judicial Conference

The authority for approving any exception to prospectus-level courthouse projects that would result in additional estimated costs, including additional rent payment obligations, lies with the Judicial Conference. Approval is required, after review by the Committee on Space and Facilities, for any exception to the *Design Guide* approved by a circuit judicial council. The request must include (1) a justification for the exception and (2) a construction cost estimate. [All approved exceptions for prospectus-level projects](#) are reported to the General Services Administration (GSA) and Congress. Approved exceptions may require the project to be reauthorized by Congress if the exception had not been previously identified. Contact the Administrative Office of the U.S. Courts (AOUSC) for more detailed information.

For prospectus-level courthouse projects, if an exception is approved by the JCUS which would result in additional estimated costs, the chair of the circuit’s space and facilities committee or the chief judge or other judge designated by the court that sought the exception that exceeds the *Design Guide* criteria must be willing, if requested by the Committee on Space and Facilities, to appear before Congress concerning funding for such construction.

General Programming Notes

The *Design Guide* is intended to be a performance document. Criteria for any space or grouping of spaces should be considered in conjunction with the specific needs of the court office or function for which space is being designed.

Criteria in the *Design Guide* do not represent space entitlements. The criteria apply to an array of space types that should be justified based on the specific purpose of each project. Facility plans, programs, and designs should include only the space needed to satisfy the functional and security requirements of the court.

Differences between the space in an existing facility and the criteria in the *Design Guide* are not justification for facility alteration and expansion. In such cases, alternatives to space expansion are investigated before any additional space is requested. In addition, like-for-like space is not a guarantee. Space allocated in an existing location is not justification for the same amount of space in a new location if the space allocation is not warranted. Current needs should be evaluated when moving into new space to determine the appropriate space envelope. Any additional space must be approved by the appropriate authority. Design architects and court staff are prohibited from adding spaces not originally contemplated in the approved prospectus or design program. Increasing the floor area or building volume requires the necessary approvals.

General Budgetary Notes

Renovation and new construction occur when the court and circuit judicial council identify space needs through the Judiciary’s asset management planning process and document these needs in the long-range facilities plan. GSA determines by what method the space is provided—for example, by the construction of a new building, the renovation of an existing building, a lease, or other means.

The Judicial Conference recognizes and strongly supports a pragmatic approach to design that includes the use of durable and sustainable materials. This approach ensures that courthouses constructed now will last well into the future.

Following the publication of the *2007 Design Guide*, the Judiciary introduced several cost-saving measures, such as courtroom sharing and the Integrated Workplace Initiative (IWI), that sought to provide flexibility and efficiency in court spaces while preserving the dignity of the Judiciary. Courtroom sharing for certain judge types is now a standard throughout the Judiciary, and IWI is recognized as an alternative to traditional office design. For more information on cost- and space-saving efforts and programs, contact the AOUSC Space and Facilities Division.

General Space Notes

Space Standards for PSO and PO Personnel

Space standards for PSO and PO personnel should be allocated according to the benchmark occupational groups described in the Judiciary’s *Human Resources Manual* and the space requirements (Table 9.1) in this chapter, Space and Ceiling Standards for Probation and Pretrial Services Offices.

Opportunities for Shared Support Spaces

Locating the PSO and PO in close proximity provides an opportunity for shared support spaces.

- The urinalysis toilet, supplies storage closet, and testing and specimen storage room may be shared by the PSO and PO; however, access to the shared facility is required within each office’s restricted circulation.
- An electronic monitoring equipment storage/repair room may be shared by the PSO and PO; however, access to the shared room is required within each office’s restricted circulation.
- The secure computer terminal/printer and secure LAN equipment rooms may be combined and shared by the PSO and PO; however, access to the shared room is required within each office’s restricted circulation.
- Conference rooms in PSO and PO offices should accommodate managers and first-line supervisors. See the PSO and PO space and ceiling requirements (Table 9.1) for specific size criteria. Requirements for larger conference and training spaces will be accommodated in shared conference/training rooms or multi-use spaces within the courthouse as described in Chapter 11, “Shared Support Spaces.”
- Conference rooms should be shared by court units off common areas whenever possible.
- The fax workstation, computer/printer, and shredder should be shared by the PO and PSO whenever possible.

Staff Toilet Rooms and Breakrooms

Staff toilets are provided for security reasons and to ensure there is no inappropriate staff contact with attorneys, parties, or other case participants that might compromise the judicial process.

The staff toilets and breakrooms should be located within restricted circulation on floors with court-related offices. For courthouses housing more than one court unit, the design team should consider a shared staff breakroom. If separate staff toilets are necessary, the total number of staff toilets will be determined during design utilizing the most current edition of the *International Plumbing Code*. Plumbing fixtures required to serve a given floor shall be proportionally split between the staff and public occupant loads. Consult with the AOUSC for more detailed information.

Functions and Activities

The PSO and PO both supervise persons released into their custody, reasonably ensure community safety, and investigate and supervise persons referred to diversion programs. Officers recommend, implement, and monitor compliance with the conditions of release, and work to facilitate an individual’s reintegration into the community as a law-abiding and productive member of society. Officers from both organizations interact with law enforcement, enforce court conditions, supervise defendants and offenders, and recommend sentences. They advise judicial officers by interpreting sentencing guidelines, investigating backgrounds, testifying in court, and learning case law. They also assist individuals by administering drug treatment, identifying and solving problems, and providing counseling and referrals to community agencies.

The nature of these officers’ work often requires them to be placed in potentially dangerous situations, both in their offices and in the community. They have the power to make arrests, although arrests are normally performed by the U.S. Marshals Service (USMS), and they may be granted authority by a court to carry and use weapons, although not all do.

Following an arrest, a PSO officer interviews the individual about his or her family, residential, employment, financial, educational, health, and criminal history. The information is verified, the individual’s flight risk and potential danger to the community are assessed, and a recommendation is made regarding potential release from pretrial custody. The report is submitted to the judge, prosecutor, defendant, and defense attorney.

In the case of the PO, once a defendant has been found guilty, an officer conducts additional interviews and prepares another report, which assists the court in its sentencing function and serves as a detention resource for the Bureau of Prisons (BOP). PO officers are community corrections professionals who serve as officers of the court and as agents of the U.S. Parole Commission. They are responsible for the supervision of persons conditionally released to the community by the courts, the Parole Commission and BOP, and military authorities.

Users and Capacities

Users vary depending on the size of the courthouse; the type and volume of cases; and the number of maintenance staff, service company/agency personnel, and public individuals present. For the purposes of certain references in this *Design Guide*, the following designations apply:

A small courthouse has five or fewer courtrooms.

A medium courthouse has 6-12 courtrooms.

A large courthouse has 13-18 courtrooms.

An extra-large courthouse has more than 18 courtrooms.

Design Requirements

Ceiling Height

The ceiling is a designed surface. It may be uniformly flat, or it may have two or more planes and include elements such as soffits, perimeter coves, recesses, and reveals as required to integrate HVAC and lighting into a harmonious design. An adjustment of a ceiling surface may also occur where it meets an exterior curtain wall to accommodate different equipment. In situations where there are several different surfaces at different heights above the finished floor, there may be different ways of determining which one is the dominant plane. Ceiling heights should be measured from the finished floor to the dominant surface that either covers the most amount of ceiling square footage, or the surface that defines the overall character of the ceiling design. The design team should ensure that in all newly constructed spaces the dominant plane of the ceiling does not exceed the maximum ceiling height of 10 feet (3,000 mm) above finished floor for Probation and Pretrial Services offices and their associated spaces unless the office employs alternative workplace strategies (AWS). If a Probation or Pretrial office employs AWS, the design team should ensure that in all newly constructed spaces the dominant plane of the ceiling does not exceed 12 feet (3660 mm). Dominant planes that exceed this maximum height are considered an exception unless the space is in an area envisioned for a future courtroom or on a floor with a higher floor-to-floor height. The application of this maximum ceiling height in renovation and alteration projects may be dependent on limitations of existing conditions.

The ceiling height should be in proportion to the area of the space. If the space is located on a floor with a higher floor-to-floor height, the ceiling height of the room may be designed to maximize use of available natural light, volume, and window configuration of that space.

Reception Counter/Screening

A reception counter is provided with counter-to-ceiling break-resistant glazing. For the counter, a durable work surface 26-30 inches deep at stand-up height with a divider to the floor below should be provided. It is recommended that the counter extend 12 inches on the public side of the partition. The counter should accommodate a computer monitor, keyboard, and mouse on the staff side. The counter should accommodate a document-sized deal tray transaction opening for each station provided.

In leased locations where weapons screening is not performed at the main entrance of the building, the PSO and PO will work with the USMS to provide bullet-resistant glazing and ballistic wall surround. The AOUSC should be consulted to determine whether additional accommodations for screening equipment will be necessary at a particular leased location.

Depending on the needs of the office, PO and PSO offices may utilize technology such as a monitor, camera, and a two-way communication system to monitor the public reception area rather than a traditional reception counter. In addition, lockable storage may be provided in the reception areas so visitors can store their personal belongings.

Urinalysis Toilet

Urinalysis toilet rooms are used for collecting urine specimens in a secured and supervised environment. Each room should accommodate both the person providing the specimen and an officer to visually monitor the collection process, either directly or through the use of an observation mirror mounted in the room which provides a clear line of sight. As an option, urinalysis collection observation may be from an adjoining room through a window. The officer observation point should be equipped with a duress alarm.

Barrier-free access shall be provided to each room, ideally through two doors. One door is to be used by the offender from the unsecured public waiting room, and the other door for the officer from the secured private office space. However, if space planning allows only one room access point, it is preferred that it be from the unsecured public waiting room. This will eliminate the need for the offender to enter the secured space only to provide a specimen.

Doors leading into the urinalysis toilet from the public area should remain locked at all times. The public entry door should be controlled with a door release button located at the intake counter, or by a key. The door leading into the urinalysis toilet from the secure side of the space should have free ingress, but should remain in the locked position inside the urinalysis toilet. The door in the urinalysis toilet leading into the secure space shall be controlled with a card reader or a key. Additionally, the design of the room should prevent any other potential entry, such as through partitions, the ceiling plenum, a pipe chase, or other similar means. All doors should swing in the direction of egress. The urinalysis toilet should be arranged so an officer can easily view the toilet during specimen testing.

Urinalysis Supplies Storage

The urinalysis supplies storage closet should be securable. The room and all storage closets in it should have door locks and the same partitioning as the toilet room(s) and testing laboratory. Any means of access through the ceiling plenum or similar spaces should be eliminated.

The urinalysis toilet room(s) and testing lab should be adjacent to supplies storage. The storage area should be accessible through restricted circulation only.

Urinalysis Testing and Specimen Storage Room

In some cases, the testing of urinalysis specimens will be undertaken outside the PSO and PO offices, thereby eliminating the need for a testing laboratory. Even if this is the case, there will still be the need for secured specimen storage until such time that the specimens may be transported off-site. The specimens will be stored in a refrigerator or freezer.

The room should accommodate the following items:

- Two countertop enzyme multiplied immunoassay technique (EMIT) machines, each requiring a footprint area of at least 30 inches (775 mm) deep by 60 inches (1,525 mm) wide; 110-volt dedicated power; and additional adjacent counter space at a height of 44 inches (1,125 mm) above finished floor level. Larger testing machines may need to be floor mounted and may require a water holding tank and water filtration system. The testing machine and lab may require additional power and data needs.
- Two operator stools.
- A double stainless steel sink with disposal, set in a millwork base cabinet at least 8 feet (2,425 mm) long with a counter height of 44 inches (1,125 mm) above finished floor level; adjacent 110-volt convenience outlets; and millwork storage cabinets above and below. A separate eyewash station and hand sink should also be provided.
- Two full-sized refrigerators with freezers, one for specimens awaiting testing and the other for chain-of-custody storage of specimens with positive test results. (If a testing laboratory is not required, these refrigerators/freezers should be housed in the urinalysis supplies storage room.)
- Trash disposal.
- Chemical-resistant, laboratory-type finishes on all countertops. A stainless steel countertop with a marine edge is recommended to contain accidental spills.

Both the urinalysis testing laboratory and specimen storage, as applicable, should be accessible only from the restricted office circulation. These rooms and all storage closets in them should have door locks and the same partitioning as the urinalysis rooms.

Urinalysis Testing and Storage Room Finish Requirements

Because of the unique nature of urinalysis facilities, the following finished surfaces should have the following qualities. Refer to Chapter 12, “Tenant Improvements and Furnishings” for other finish suggestions regarding probation and pretrial services spaces.

Walls and Ceilings:

- Surfaces should be smooth and easily cleanable.
- Avoid friable ceiling tile styles, as they liberate dust, are difficult to clean, and

make an excellent habitat for mold and bacteria.

- Recessed lighting is preferable over suspended styles, but avoid placement directly above lab benches to facilitate bulb replacement and repairs.

Flooring:

- Easily washed, non-porous, cove style base, spill/leak resistant. Seamless sheeting preferred over vinyl tile.
- Carpeting should not be used in lab and lab support areas.
- Caulk and seal all floor penetrations to prevent migration in the event of spill or flood.
- Provide floor drains.

Lab Furniture and Furnishings:

- Smooth, non-porous, easily cleaned surfaces.
- Chemical-resistant, laboratory-type finishes on all counter tops with splash blocks, and all seams caulked and sealed. A stainless steel counter top with a marine edge is recommended to contain accidental spills.
- Accessibility below furniture for cleaning in event of accident/spill.
- Review planned operations with proposed occupants to consider any special equipment requirements (e.g., adequate floor load ratings, vibration sensitivity or dampening needs).

Shelving:

- Wall and above bench stainless steel shelving to maximize accessible storage space.
- Chemical-resistant finish surfaces.
- Shelf lips are recommended, as their use greatly reduces accidental slides and slips of bottles off shelves.

Electronic Monitoring Equipment Storage/Repair Room

The equipment needed to monitor one individual currently requires approximately 3 cubic feet of space. The boxes are normally about 3 feet (925 mm) long by 1 foot (300 mm) wide by 1 foot (300 mm) deep and are stored on steel shelving units. The storage/repair room also contains a millwork base cabinet at least 8 feet (2,425 mm) long, with a counter height of 44 inches (1,125 mm) above the finished floor; adjacent 110-volt convenience outlets; and millwork storage cabinets above for use in equipment repair. The door to the room should have a lock and be accessible only from the secured office circulation.

Secure Computer Terminal/Printer and Secure LAN Equipment Rooms

Computer terminal/printer and LAN equipment rooms should be equipped with a secure cipher lock, card reader, or keypad to limit entrance to authorized personnel. Any means of access through the ceiling plenum, pipe chase, or other similar spaces should be eliminated.

Officer Office and Shared Interview Room Requirements

Officers shall be provided a private office, or workstations if employing AWS, and separate, shared interview rooms to support engagement activities with clients. Interview rooms should have two doors: one door from the public reception or waiting area and another door from restricted circulation. Both of these doors should open in the direction of egress. The interview room is required to accommodate at least one table with four chairs.

Satellite Offices

Staffed satellite offices are needed to cover a wide geographic area and carry out the mission of the PSO and PO. PO and PSO offices should be carefully located in an appropriate context. For instance, a PO or PSO office should not be located near or adjacent to a day care facility or school. Due to the wide variety of activities that these workplaces undertake, each satellite office might have different spatial, technological, security, and operational needs. Stakeholders should work with their respective circuit to determine requirements for satellite offices on a case-by-case basis. Although satellite offices should not exceed the spatial requirements listed in [Table 9.1](#), each workplace has the flexibility to configure space within the given space envelope to meet the local needs. Refer to the space envelope flexibility policy listed in the Programming and Budgetary Notes.

To support satellite offices, facilities within the main office should be available for occasional use by officers stationed in satellite offices.

Conference Rooms, Staff Breakroom and Toilets

If necessary, conference rooms, staff breakrooms, and toilets should be located within restricted circulation when these spaces are collocated on floors with court-related offices.

Offices which require conference rooms or staff breakrooms with more square footage than allotted in [Table 9.1](#) may configure space to meet the office's needs within the given space envelope. Courts should reference strategies outlined in [Chapter 18, "Alternative Workplace Strategies,"](#) when determining their local needs. However, any significant departure from the standards and strategies provided in this chapter and Chapter 18 must be approved by the circuit judicial council.

The staff breakrooms should minimally accommodate a microwave oven and a sink; however, other equipment such as refrigerators might also be desired.

Multipurpose Room

Since PO and PSO officers complete a series of specialized trainings, a multipurpose room is may be necessary to house these activities. A retractable divider wall may be desired in the multipurpose room to allow multiple trainings to occur at the same time. This space may function as, but may not be limited to, a training room, conference room, or mat room.

Gun Locker Room

Adequate storage for weapons should be incorporated into the planning, design, and construction of PO and PSO offices. Gun lockers should be located within a secure room controlled by a physical access control system (PACS) and monitored by an intrusion detection system (IDS) and closed circuit video (CCV). The room should be secured by a door with an electric strike and lock.

Gun locker rooms should be large enough to accommodate gun storage lockers, ammunition storage, a gun clearing station, and a standalone gun vault (if required). Walls for gun locker rooms are recommended to consist of either concrete masonry block or metal stud and dry wall construction with heavy gauge metal mesh located on one side of the wall. Walls are required to span from floor slab to floor slab. Floor slabs should be designed to accommodate the additional structural load created by these spaces.

Acoustics

Acoustic requirements are addressed in [Chapter 14, "Acoustics."](#) All interview rooms and offices of PSO and PO supervision officers should be acoustically separate from adjacent areas.

Technology

Infrastructure provisions, conduit, and power should be considered for conference rooms, multipurpose rooms, and selected interview rooms or offices to facilitate presentations, remote meeting participation, and remote interviews.

Heating, Ventilating, and Air-Conditioning (HVAC)

HVAC and electrical systems, including lighting, should economically accommodate early morning and late evening hours. Refer to [Chapter 15, "Building Systems."](#)

Table 9.1
Space Requirements for Probation and Pretrial Services Offices

Probation (PO) and Pretrial Services Offices (PSO)		
Private Offices	NSF	Nm ²
Chief Probation or Chief Pretrial Services Officer	240	22.3
Chief Probation or Chief Pretrial Services Officer's Private Restroom ¹	56	5.2
Executive Secretary/Reception Area	170	15.8
Deputy Chief Probation or Deputy Chief Pretrial Services Officer	180	16.7
Manager	180	16.7
Professional First-Line Supervisor ²	180	16.7
Professional Administrative and Professional Line Positions	150	14.0
PSO and PO Officer Office	120	11.1
Open Workstations	NSF	Nm ²
Operational and Administrative First-Line Supervisor	96	8.9
Clerks	64	5.6
Counter Workstations	45	4.2
General Office Space	NSF	Nm ²
Reception/Waiting, per person	15	1.4
Minimum Area Required	150	13.9
Counter/Screening, per staff position	5 LF	1.52 Lm
Secured Records Storage, per shelf unit	9	0.9
Active Records Storage, per shelf unit	9	0.9
Inactive Records Storage, per shelf unit	9	0.9
Transfer Box Storage	50	4.7

Supplies (min/max)	150/300	14.0/27.9
Equipment Storage (min/max)	150/300	14.0/27.9
Work Area ³	195	18.1
Low Volume Copier Area (per copier)	50	4.7
Medium Volume Copier Area (per copier)	80	7.4
High Volume Copier Area (per copier)	120	11.2
Conference Room (fewer than 20 occupants)	300	27.9
Conference Room (20 or more occupants)	400	37.2
Multipurpose Room	400	37.2
Printer/Copier/Fax Area	60	5.6
Vault or Safe (min/max)	20/80	1.9/7.4
Microform Reader/Printer	35	3.3
Microform Storage Cabinet, per cabinet	12	1.1
Staff Breakroom ⁴ (min/max)	200/600	18.6/55.8
Staff Toilets ⁵	-	-
Coat Closets	20	1.9
Special Office Space	NSF	Nm ²
Shared Interview Room	120	11.1
Toilet for Urinalysis Sample Collection	56	5.2
Urinalysis Supplies Storage	25	2.3
Urinalysis Testing/EMIT Lab & Sample Storage ⁶	200	18.6
Electronic Monitoring Equipment Storage/Repair Room	95	8.8
Secure Computer Terminal/Printer Room & LAN Server	150	13.9
Gun Locker Room	100	9.3

- ¹ This restroom does figure into the fixture count for the total staff toilet room requirements. If a court unit elects to include this space, the square footage should be offset from within the court unit's space envelope.
- ² In a divisional office, first-line supervisors include a supervisory probation clerk and a supervisory probation officer.
- ³ Space allowance for work area: 15 NSF (1.4 Nm²) per staff member. Minimum area is 195 NSF (18.1 Nm²).
- ⁴ Area requirements for staff breakroom: Allocate 25 NSF (2.32 Nm²) for every three staff members plus 20 NSF (1.9 Nm²) for a service unit. The minimum staff breakroom is to be 200 NSF (18.5 Nm²), and the maximum staff breakroom is to be 600 NSF (55.7 Nm²).
- ⁵ Plumbing fixtures required to serve a given floor should be proportionally split between the staff and public occupant loads.
- ⁶ Urinalysis testing/EMIT lab might not be provided within the PSO and PO offices. If not provided, all urinalysis spaces can be eliminated.

Adjacency and Circulation

Both the PSO and the PO require public access to reception areas during the day and in the evenings. Restricted access for office staff is also required during these times; staff should be able to enter and leave the office without passing through the public reception/waiting area or extensively using the public circulation system. If the office is located in a facility where weapons screening is not conducted at the entry, a magnetometer and X-ray machine may be provided by the USMS. Space should be provided to accommodate this screening equipment. Refer to *Requirements and Specifications for Special Purpose and Support Space Manual, Volume Three, Judicial Security Systems Requirements and Specifications* (USMS Publication 64).

The PO requires proximity to the main public entry area, after the security screening point. If the PO requires off-hours access for staff and clients, the most desirable location is on the main public entry level, with separate off-hours controlled access.

The PSO also requires proximity to the main public entry area, after the security screening point. Access should be provided to the USMS Command and Control Center and magistrate judge courtrooms.

The number of spaces shown on the adjacency diagram ([Figure 9.1](#)) is for illustrative purposes only; the actual number of spaces required for a specific facility is determined in the building program.





The design team should refer to [Chapter 3, "Planning for U.S. Courthouses,"](#) for circulation factors.

Figure 9.1
 Probation and Pretrial Services Offices Adjacency Relationships

Colors Legend:

 **Chapter 9**
 Probation and Pretrial Services Offices

Symbols Legend:

-  Public Circulation
-  Public Vertical Circulation
-  Restricted Circulation
-  Restricted Vertical Circulation
-  Circulation Access Control Point

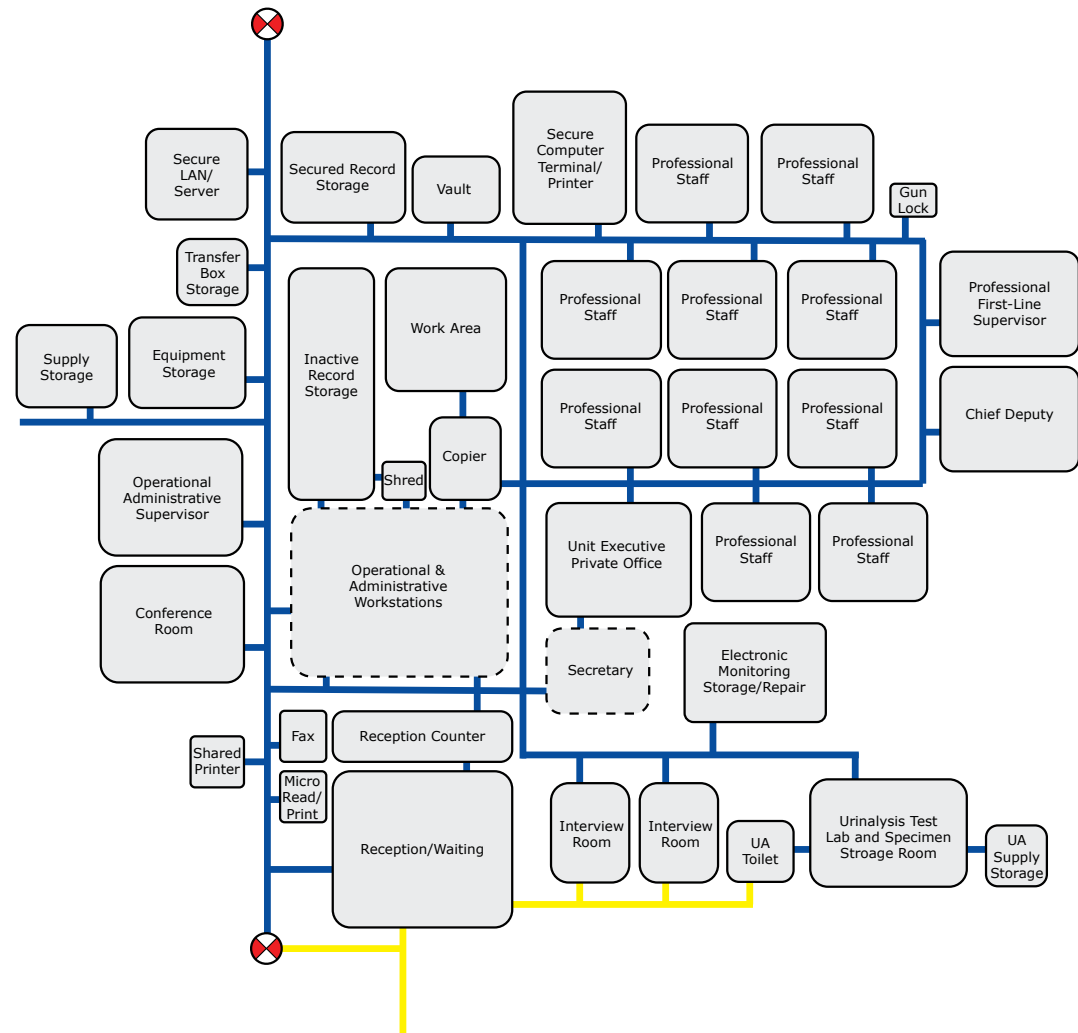

Note: The adjacency diagram is intended only as an illustration.



OTHER COURT UNITS

This chapter includes the Office of the Circuit Executive, Office of the Bankruptcy Appellate Panel Clerk, Office of the Senior Staff Attorney, Office of the Pre-argument/Conference Attorney, Office of the District Court Executive, Office of the Bankruptcy Administrator, and Office of the Federal Public Defender's trial preparation suite. It describes offices' functions and activities, users and capacities, design requirements, and space allocation requirements, and contains adjacency diagrams.

Chapter Topics:

- Supporting Documents
- Programming and Budgetary Notes
- Functions and Activities
- Users and Capacities
- Design Requirements
- Adjacency and Circulation

Chapter Figures and Tables:

Figure 10.1	Office of the Circuit Executive & Office of the District Court Executive Adjacency Relationships
Figure 10.2	Office of the Bankruptcy Appellate Panel (BAP) Clerk Adjacency Relationships
Figure 10.3	Office of the Senior Staff Attorney Adjacency Relationships
Figure 10.4	Office of the Pre-Argument/Conference Attorney Adjacency Relationships
Figure 10.5	Office of the Bankruptcy Administrator Adjacency Relationships
Figure 10.6	Office of the Federal Defender's Trial Preparation Suite Adjacency Relationships
Table 10.1	Ceiling Requirements for Other Court Units
Table 10.2	Space Requirements for Other Court Units

Supporting Documents

A comprehensive guide to supporting documents can be found in [Chapter 2, “Courthouse Programming and Budgetary Considerations.”](#) That listing includes program and design criteria, courthouse planning and related guidelines, policies, and information on many facets of the design and construction of federal courthouses. The reference listed below relates specifically to this chapter.

- *United States Courts, Courthouse Design Reference Manual: An Architect’s Desk Reference*, most current edition, Chapter 10.

Programming and Budgetary Notes

Programming and budgetary notes found throughout the *Design Guide* provide assistance with decisions to be made during the development of courthouse projects. The notes include both judicial branch policy and lessons learned from completed projects. The notes supplement the criteria in the *Design Guide*; their purpose is to provide direction in using the flexibility of the *Design Guide* to develop justifiable and cost-effective federal courthouse projects.

Space Envelope Flexibility

A total space envelope for new space will be calculated using appropriate circulation factors, allowances for support-type spaces, and the space standards described in the *Design Guide*. Courts have the flexibility to configure space within the envelope to meet their local needs. However, design and construction should be in general compliance with the square footage standards designated in the *Design Guide* in the space and ceiling requirements tables. If the court unit wishes to significantly change the space standards described in the space and ceiling requirements tables without exceeding the total envelope of space for the unit, it must seek approval from its respective circuit judicial council.

The space envelope for a respective court unit is defined as:

- Entire clerk’s office
- Entire probation office
- Entire pretrial services office
- Entire staff attorney’s office
- Entire circuit executive’s office
- All courtrooms designated by judge type (circuit judges, district judges, magistrate judges, and bankruptcy judges)
- All chambers designated by judge type (circuit judges, district judges, magistrate judges, and bankruptcy judges)

For existing space, courts have the flexibility to configure space within the existing envelope to meet their local needs. However, any significant departure from the square footage standards designated in the *Design Guide* in the space and ceiling requirements tables must be approved by the respective circuit judicial council. This does not mean that existing space must be changed to meet *Design Guide* standards. Only new construction completed as part of a renovation should be considered.

Renovations and Alterations (R&A)

Many of the construction projects conducted in the Judiciary are renovations to existing space. Although the *Design Guide* applies to these projects, it is understood that some standards in the *Design Guide* are difficult or impossible to achieve in existing space, particularly in historic buildings. Courts should consult [Chapter 17, “Renovations and Alterations \(R&A\),”](#) and [Facilities Standards for the Public Buildings Service \(GSA PBS P-100\)](#) for guidance in these circumstances. References to R&A guidelines are also included throughout the *Design Guide* where appropriate.

Exceptions to the *Design Guide* Standards

The *Design Guide* provides guidance on standards for courthouse construction and renovations to existing space. Any significant departure from these standards is considered an exception and must be approved by the respective authority as outlined below.

Authority of the Circuit Judicial Councils

Circuit judicial councils play an important space-management role by reviewing district-wide facility plans, approving requests for new or modified space, and enforcing adherence to design guidelines. The circuit judicial councils have authority over, and responsibility for, a circuit’s space-management program (28 USC §332 and §462(b)) and for determining the need for space. As directed by the Judicial Conference of the United States (JCUS), any significant departure from the standards in the *Design Guide* must be approved by the respective circuit judicial council.

Authority of the Committee on Space and Facilities

The authority to approve the following exceptions to the *Design Guide* standards rests with the Committee on Space and Facilities: (1) exceeding the total envelope for either the court unit or the project as a whole, (2) changing the standard configurations for judges’ chambers and courtrooms, and (3) exceeding the plumbing standards. If the Committee on Space and Facilities disagrees with a circuit judicial council request for one of these exceptions, the Judicial Conference will decide whether to grant the exception.

Authority of the Judicial Conference

The authority for approving any exception to prospectus-level courthouse projects that would result in additional estimated costs, including additional rent payment obligations, lies with the Judicial Conference. Approval is required, after review by the Committee

on Space and Facilities, for any exception to the *Design Guide* approved by a circuit judicial council. The request must include (1) a justification for the exception and (2) a construction cost estimate. [All approved exceptions for prospectus-level projects](#) are reported to the General Services Administration (GSA) and Congress. Approved exceptions may require the project to be reauthorized by Congress if the exception had not been previously identified. Contact the Administrative Office of the U.S. Courts (AOUSC) for more detailed information.

For prospectus-level courthouse projects, if an exception is approved by the JCUS which would result in additional estimated costs, the chair of the circuit's space and facilities committee or the chief judge or other judge designated by the court that sought the exception that exceeds the *Design Guide* criteria must be willing, if requested by the Committee on Space and Facilities, to appear before Congress concerning funding for such construction.

General Programming Notes

The *Design Guide* is intended to be a performance document. Criteria for any space or grouping of spaces should be considered in conjunction with the specific needs of the court office or function for which space is being designed.

Criteria in the *Design Guide* do not represent space entitlements. The criteria apply to an array of space types that should be justified based on the specific purpose of each project. Facility plans, programs, and designs should include only the space needed to satisfy the functional and security requirements of the court.

Differences between the space in an existing facility and the criteria in the *Design Guide* are not justification for facility alteration and expansion. In such cases, alternatives to space expansion are investigated before any additional space is requested. In addition, like-for-like space is not a guarantee. Space allocated in an existing location is not justification for the same amount of space in a new location if the space allocation is not warranted. Current needs should be evaluated when moving into new space to determine the appropriate space envelope. Any additional space must be approved by the appropriate authority. Design architects and court staff are prohibited from adding spaces not originally contemplated in the approved prospectus or design program. Increasing the floor area or building volume requires the necessary approvals.

General Budgetary Notes

Renovation and new construction occur when the court and circuit judicial council identify space needs through the Judiciary's asset management planning process and document these needs in the long-range facilities plan. GSA determines by what method the space is provided—for example, by the construction of a new building, the renovation of an existing building, a lease, or other means.

The Judicial Conference recognizes and strongly supports a pragmatic approach to design that includes the use of durable and sustainable materials. This approach ensures that courthouses constructed now will last well into the future.

Following the publication of the *2007 Design Guide*, the Judiciary introduced several cost-saving measures, such as courtroom sharing and the Integrated Workplace Initiative (IWI), that sought to provide flexibility and efficiency in court spaces while preserving the dignity of the Judiciary. Courtroom sharing for certain judge types is now a standard throughout the Judiciary, and IWI is recognized as an alternative to traditional office design. For more information on cost- and space-saving efforts and programs, contact the AOUSC Space and Facilities Division.

General Space Notes

Conference and Training Spaces

Conference and training rooms in other court units should accommodate the number of managers and first-line supervisors. Refer to the space requirements in this chapter for specific size criteria. Requirements for larger conference and training spaces should be accommodated in shared conference/training rooms or multiuse spaces within the courthouse. Courts which require conference rooms with more square footage than allotted in the space requirements, [Tables 10.1](#) and [10.2](#), may configure space to meet the court's needs within the given space envelope. Courts should reference strategies outlined in [Chapter 18, "Alternative Workplace Strategies,"](#) when determining their local conference room needs. However, any significant departure from the standards and strategies provided in this chapter and Chapter 18 must be approved by the circuit judicial council.

Staff Toilet Rooms and Breakrooms

Staff toilets are provided for security reasons and to ensure there is no inappropriate staff contact with attorneys, parties, or other case participants that might compromise the judicial process.

The staff toilets and breakrooms should be located within restricted circulation on floors with court-related offices. For courthouses housing more than one court unit, the design team should consider a shared staff breakroom. If separate staff toilets are necessary, the total number of staff toilets will be determined during design utilizing the most current edition of the *International Plumbing Code*. Plumbing fixtures required to serve a given floor shall be proportionally split between the staff and public occupant loads. Consult with the AOUSC for more detailed information.

Functions and Activities

Office of Circuit Executive

The Office of the Circuit Executive provides legal and administrative support in each circuit.

Office of the Bankruptcy Appellate Panel Clerk

In some circuits, bankruptcy appellate panels hear and determine appeals from judgments, orders, and decrees entered by bankruptcy judges.

Office of the Senior Staff Attorney

The Office of the Senior Staff Attorney provides legal assistance to circuit judges.

Office of the Pre-argument/Conference Attorney

In some circuits, a pre-argument/conference attorney is provided under the Civil Appeals Mediation Program. The pre-argument/conference attorney assists the court by working to effect settlements in appellate cases.

Office of the District Court Executive

The Office of the District Court Executive provides legal and administrative support for a particular judicial district. Not every district has this office.

Office of the Bankruptcy Administrator

In some locations, an Office of the Bankruptcy Administrator assists the U.S. Bankruptcy Court (USBC) by overseeing the administration of estates and supervising case trustees and other fiduciaries. Such services are similar to those provided by the U.S. Trustee (executive branch) in other locations.

Office of the Federal Public Defender's Trial Preparation Suite

The Office of the Federal Public Defender provides counsel to persons charged with federal criminal offenses who are financially unable to obtain adequate private representation. Federal defender offices should be located outside the courthouse, or other federal buildings housing law enforcement agencies, unless the federal defender has determined that the location would not compromise the defender organization's ability to fulfill its mission. If the JCUS Committee on Defender Services approves the request by a federal public defender to occupy space in a new courthouse, the comparable office space standards for other court units shall apply. The office should be distanced from the offices of the U.S. attorney. A trial preparation suite of 450 net square feet (41.9 net square meters (Nm²)), which includes internal circulation for use by federal public defenders during trials, should be provided in the U.S. District Court (USDC) courthouse.

Users and Capacities

Users vary depending on the size of the courthouse; the type and volume of cases; and the number of maintenance staff, service company/agency personnel, and public individuals present. For the purposes of certain references in this *Design Guide*, the following designations apply:

A small courthouse has five or fewer courtrooms.

A medium courthouse has 6-12 courtrooms.

A large courthouse has 13-18 courtrooms.

An extra-large courthouse has more than 18 courtrooms.

Design Requirements

The design requirements for other court units outlined in this chapter are detailed in the following information. Specific space requirements can be found in [Table 10.1](#), [Table 10.2](#) and the room data sheets.

Ceiling Height

The ceiling is a designed surface. It may be uniformly flat, or it may have two or more planes and include elements such as soffits, perimeter coves, recesses, and reveals as required to integrate HVAC and lighting into a harmonious design. An adjustment of a ceiling surface may also occur where it meets an exterior curtain wall to accommodate different equipment. In situations where there are several different surfaces at different heights above the finished floor, there may be different ways of determining which one is the dominant plane. Ceiling heights should be measured from the finished floor to the dominant surface that either covers the most amount of ceiling square footage, or the surface that defines the overall character of the ceiling design. The design team should ensure that in all newly constructed spaces the dominant plane of the ceiling does not exceed the maximum ceiling height listed in the *Design Guide*. Dominant planes that exceed these maximum heights are considered an exception unless the space is in an area envisioned for a future courtroom or on a floor with a higher floor-to-floor height. The application of this maximum ceiling height in renovation and alteration projects may be dependent on limitations of existing conditions.

The ceiling height should be in proportion to the area of the space. If the space is located on a floor with a higher floor-to-floor height, the ceiling height of the room may be designed to maximize use of available natural light, volume, and window configuration of that space. Ceiling heights for other court units should be in accordance with the maximum ceiling heights listed in [Table 10.1](#).

Table 10.1

Ceiling Requirements for Other Court Units

Space Name	Ceiling Height (feet)	Ceiling Height (mm)
Circuit Executive and District Court Executive	10	3,000
Bankruptcy Appellate Panel (BAP) Clerk	10	3,000
Senior Staff Attorney	10	3,000
Pre-Argument/Conference Attorney	10	3,000
Bankruptcy Administrator	10	3,000
Federal Public Defender's Trial Preparation Suite	10	3,000

Bulk Storage Area

The design team should collocate all court unit bulk storage areas adjacent to the loading dock and central mail facility. Additional storage space may be configured within the given space envelope. If additional storage space significantly exceeds *Design Guide* standards, courts must obtain circuit judicial council approval.

Table 10.2

Space Requirements for Other Court Units

Circuit Executive ¹ and District Court Executive Spaces		
Private Offices	NSF	Nm ²
Circuit Executive/District Court Executive	240	22.3
Circuit Executive/District Court Executive's Private Restroom ²	56	5.2
Deputy	180	16.7
Assistant Circuit Executive	180	16.7
Professional Staff	150	14.0
Open Workstations	NSF	Nm ²
Executive Secretary	170	15.8
Professional and Administrative Line Position	96	8.9
Operational and Administrative Support Positions	64	5.6
General Office Spaces	NSF	Nm ²
General Reception Area, per visitor	15	1.4
Secured Records Storage, per shelf unit	9	0.9
Active Storage, per file unit	9	0.9
Inactive Records Storage, per file unit	9	0.9
Transfer Box Storage	50	4.7
Supplies (min/max)	50/100	4.7/9.3
Equipment Storage (min/max)	50/150	4.7/14.0
Work Area ³	195	18.1
Low-Volume Copier Area (per copier)	50	4.7
Medium-Volume Copier Area (per copier)	80	7.4
High-Volume Copier Area (per copier)	120	11.2

Conference Room (fewer than 20 occupants)	300	27.9
Conference Room (20 or more occupants)	400	37.2
Catalog Library ⁴	-	-
Printer/Copier/Fax Area	60	5.6
Safe (min/max)	20/80	1.9/7.4
Shredder	25	2.3
Staff Break Room ⁵ (min/max)	200/600	18.6/55.7
Staff Toilets ⁶	-	-
Bankruptcy Appellate Panel (BAP) Clerk		
Private Offices	NSF	Nm ²
Clerk	240	22.3
Clerk's Private Restroom ²	56	5.2
Attorney	150	14.0
Open Workstations		
Deputy Clerks	64	5.6
Public Areas		
Queuing/Work Area ³	150	14.0
Intake Counter	45	4.2
Accessory Stand-up Work Counter	100	9.3
Records Examination Workstation	35	3.3
Public Access Computer Stations	35	3.3
General Office Spaces		
Printer/Copier/Fax Area	60	5.6
Evidence Vault (min/max)	80/150	7.4/14.0
Equipment Storage (min/max)	50/150	4.7/14.0
Mail Work Area	100	9.3

Safe	20	1.9
Shredder	25	2.3
Forms Storage	150	14.0
Supplies (min/max)	50/100	4.7/9.3
Coat Closets	20	1.9
Secured Records Storage, per shelf unit	9	0.9
Active Storage, per file unit	9	0.9
Inactive Records Storage, per file unit	9	0.9
Exhibit Storage Room	150	14.0
Financial Vault	150	14.0
Conference Room	300	27.9
Staff Breakroom ⁵ (min/max)	200/600	18.6/55.7
Staff Toilets ⁶	-	-
Senior Staff Attorney		
Private Offices	NSF	Nm ²
Senior Staff Attorney	240	22.3
Senior Staff Attorney's Private Restroom ²	56	5.2
Senior Supervising Staff Attorney	180	16.7
Other Supervising Staff Attorney	180	16.7
Staff Attorneys	150	14.0
Open Workstations		
Executive Secretary	170	15.8
Secretary	64	6.0
General Office Spaces		
Reception/Waiting Area	105	9.8
Secured Records Storage, per shelf unit	9	0.9

Active Storage, per file unit	9	0.9
Inactive Records Storage, per file unit	9	0.9
Transfer Box Storage	50	4.7
Supplies Storage	50	4.7
Equipment Storage	50	4.7
Work Area ³	195	18.1
Printer/Copier/Fax Area	60	5.6
Conference Room	300	27.9
Shredder	25	2.3
Staff Breakroom ⁵ (min/max)	200/600	18.6/55.8
Staff Toilets ⁶	-	-
Pre-Argument/Conference Attorney		
Private Offices	NSF	Nm ²
Senior Pre-Argument Conference Attorney	240	22.3
Senior Pre-Argument Conference Attorney's Private Restroom ²	56	5.2
Conference Pre-Argument Attorney	180	16.7
Open Workstations		
Executive Secretary	170	15.8
Secretary	96	8.9
General Office Spaces		
Reception/Waiting Area	105	9.8
Secured Records Storage, per shelf unit	9	0.9
Active Storage, per file unit	9	0.9
Inactive Records Storage, per file unit	9	0.9
Supplies Storage (min/max)	50/100	4.7/9.3

Equipment Storage (min/max)	50/150	4.7/14.0
Work Area ³	195	18.1
Printer/Copier/Fax Area	60	5.6
Shredder	25	2.3
Staff Breakroom ⁵ (min/max)	200/600	18.6/55.8
Staff Toilets ⁶	-	-
Bankruptcy Administrator		
Private Offices	NSF	Nm ²
Bankruptcy Administrator	240	22.3
Bankruptcy Administrator's Private Restroom ²	56	5.2
Estate Analyst	150	14.0
Administrative Analyst	150	14.0
Open Workstations		
Estate Administrative Clerks	96	8.9
General Office Spaces		
Records, Copier Area, Work Room, Storage	350	32.6
Printer/Copier/Fax Area	60	5.6
Reception/Waiting Area	150	14.0
Coat Closets	20	1.9
Financial Vault	150	14.0
Conference Room (fewer than 20 occupants)	300	27.9
Conference Room (20 or more occupants)	400	37.2
Creditor Meeting Room (341)	1,500	139.4
Staff Breakroom ⁵ (min/max)	200/600	18.6/55.8
Staff Toilets ⁶	-	-

Federal Public Defender’s Trial Preparation Suite		
Attorney Offices, two @ 150 NSF	300	27.9
Conference/Reception/Waiting Room	100	9.3
Printer/Copier/Fax Area	60	5.6

¹ Space can be programmed for circuit staff (either as part of the circuit executive’s office or the circuit clerk of court) who are assigned to non-circuit headquarters locations.

² This restroom does figure into the fixture count for the total staff toilet room requirements. If a court unit elects to include this space, the square footage should be offset from within the court unit’s space envelope.

³ Space allowance for work area: 15 NSF (1.4Nm²) per staff member. Minimum area is 195 NSF (18.1 Nm²)

⁴ For circuit executive’s office only. Space allowance: 9 NSF (.9 Nm²) for every 21 linear feet of catalogs. Add 25 NSF (2.3 Nm²) per person and 64 NSF (6.0 Nm²) per CALR station.

⁵ Area requirements for staff breakroom: Allocate 25 NSF (2.3 Nm²) for every 3 staff members plus 20 NSF (1.9 Nm²) for a service unit. The minimum staff breakroom is to be 200 NSF (18.6 Nm²), and the maximum staff lounge is to be 600 NSF (55.8 Nm²).

⁶ Total staff toilet requirements are to be determined in design by the *International Plumbing Code*, most current edition. Plumbing fixtures required to serve a given floor should be proportionally split between the staff and public occupant loads.

Adjacency and Circulation

The design team should refer to [Chapter 3, “Planning for U.S. Courthouses,”](#) for circulation factors.

The Office of the Circuit Executive ([Figure 10.1](#)) requires private access for office staff, circuit judges and their support staff, and other court staff. The need for public access is infrequent but should not be precluded.

Office of the Bankruptcy Appellate Panel (BAP) Clerk ([Figure 10.2](#)) requires public access to intake counter and records examination areas. Access for BAP attorneys and staff as well as access to active and bulk storage areas should be from restricted circulation.

The Office of the District Court Executive ([Figure 10.1](#)) requires private access for office staff, district and magistrate judges and their support staff, and other court staff. The need for public access is infrequent but should not be precluded.

The Office of the Senior Staff Attorney ([Figure 10.3](#)) primarily requires private access for USCA staff; limited access from public circulation is also required. The office should be located close to the court library and circuit clerk’s office.

The Office of the Pre-argument/Conference Attorney ([Figure 10.4](#)) requires public access.

The Office of the Bankruptcy Administrator ([Figure 10.5](#)) requires public access.

Office of the Federal Public Defender’s Trial Preparation Suite ([Figure 10.6](#)) should be distanced (for example, at a minimum on a different floor) from the Office of the U.S. Attorney, USMS, U.S. Probation Office, U.S. Pretrial Services Office, Bureau of Prisons, and any other law enforcement agencies as described in 18 U.S.C. § 1114. This separation is essential due to the federal public defender’s mission and role in the legal process. The office should be located off of public circulation.









Figure 10.1

Office of the Circuit Executive & Office of the District Court Executive Adjacency Relationships

Colors Legend:

 **Chapter 10**
Other Court Units

Symbols Legend:

-  Public Circulation
-  Public Vertical Circulation
-  Restricted Circulation
-  Restricted Vertical Circulation
-  Secure Circulation
-  Secure Vertical Circulation
-  Service Vertical Circulation
-  Circulation Access Control Point

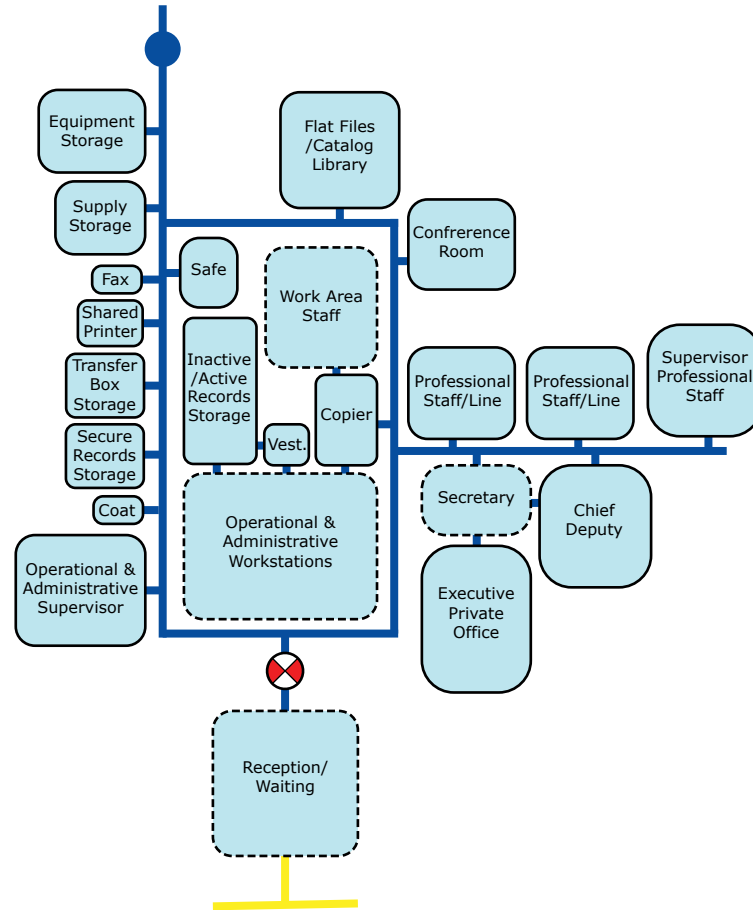

Note: The adjacency diagram is intended only as an illustration.

Figure 10.2
Office of the Bankruptcy Appellate Panel (BAP) Clerk Adjacency Relationships

Colors Legend:

Chapter 10
Other Court Units

Symbols Legend:

- Public Circulation
- Public Vertical Circulation
- Restricted Circulation
- Restricted Vertical Circulation
- Secure Circulation
- Secure Vertical Circulation
- Service Vertical Circulation
- X Circulation Access Control Point

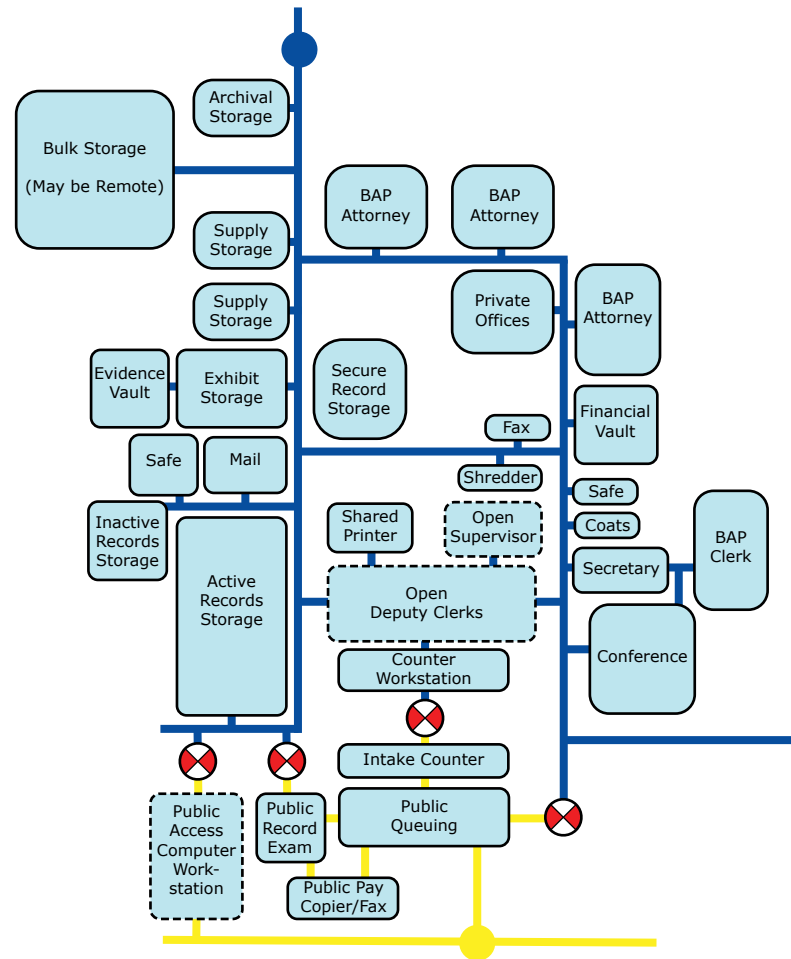









Note: The adjacency diagram is intended only as an illustration.

Figure 10.3
Office of the Senior Staff Attorney Adjacency Relationships

 **Chapter 10**
Other Court Units

Symbols Legend:

-  Public Circulation
-  Public Vertical Circulation
-  Restricted Circulation
-  Restricted Vertical Circulation
-  Secure Circulation
-  Secure Vertical Circulation
-  Service Vertical Circulation
-  Circulation Access Control Point

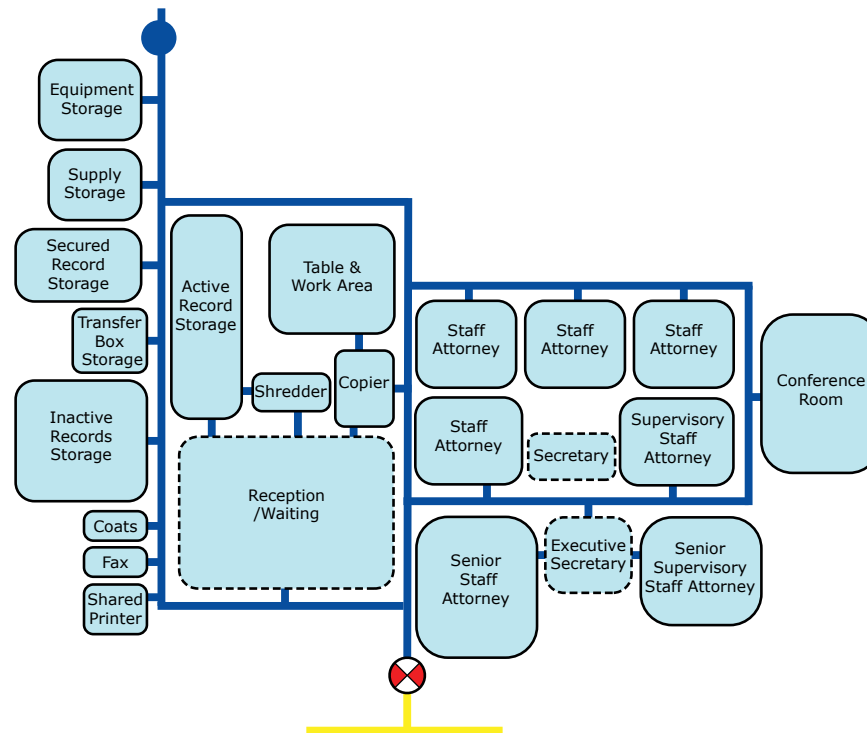









Note: The adjacency diagram is intended only as an illustration.

Figure 10.4
Office of the Pre-Argument/Conference Attorney Adjacency Relationships

 **Chapter 10**
Other Court Units

Symbols Legend:

-  Public Circulation
-  Public Vertical Circulation
-  Restricted Circulation
-  Restricted Vertical Circulation
-  Secure Circulation
-  Secure Vertical Circulation
-  Service Vertical Circulation
-  Circulation Access Control Point

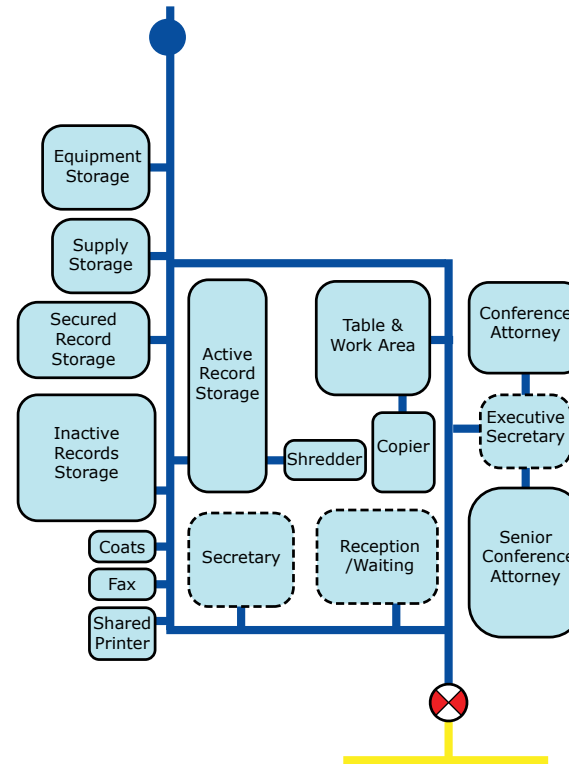









Note: The adjacency diagram is intended only as an illustration.

Figure 10.5

Office of the Bankruptcy Administrator Adjacency Relationships

 **Chapter 10**
Other Court Units

Symbols Legend:

-  Public Circulation
-  Public Vertical Circulation
-  Restricted Circulation
-  Restricted Vertical Circulation
-  Secure Circulation
-  Secure Vertical Circulation
-  Service Vertical Circulation
-  Circulation Access Control Point

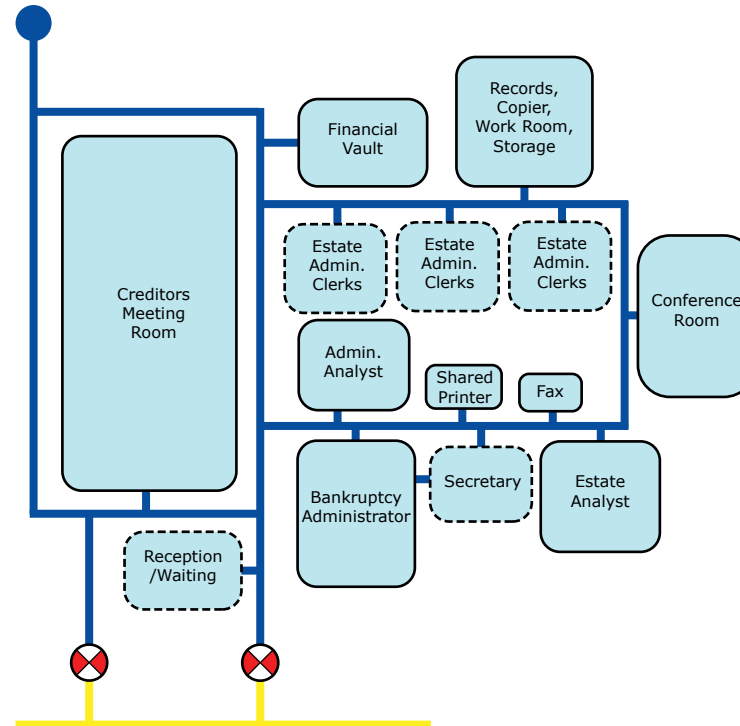









Note: The adjacency diagram is intended only as an illustration.

Figure 10.6

Office of the Federal Public Defender's Trial Preparation Suite Adjacency Relationships

 **Chapter 10**
Other Court Units

Symbols Legend:

-  Public Circulation
-  Public Vertical Circulation
-  Restricted Circulation
-  Restricted Vertical Circulation
-  Secure Circulation
-  Secure Vertical Circulation
-  Service Vertical Circulation
-  Circulation Access Control Point

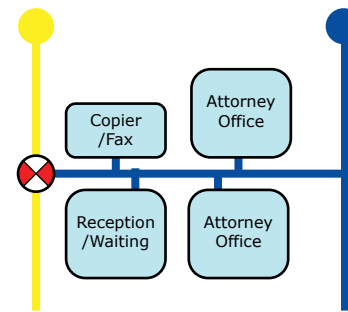

Note: The adjacency diagram is intended only as an illustration.



SHARED SUPPORT SPACES

This chapter applies to shared support and court support spaces, including shared judges' conference rooms, judges' dining areas, news media rooms, guidance on space for alternative dispute resolution proceedings, mail and package screening areas, central mail facilities, bulk and archival storage, fitness centers, and telecommunications rooms. It describes functions and activities, users and capacities, design requirements, and space allocation requirements, and contains an adjacency diagram.

Chapter Topics:

- Supporting Documents
- Programming and Budgetary Notes
- Functions and Activities
- Users and Capacities
- Design Requirements
- Adjacency and Circulation

Chapter Figures and Tables:

Figure 11.1	Shared Support Spaces Adjacency Relationships
Table 11.1	Ceiling Requirements for Shared Support Spaces
Table 11.2	Space Requirements for Shared Support Spaces

Supporting Documents

A comprehensive guide to supporting documents can be found in [Chapter 2, “Courthouse Programming and Budgetary Considerations.”](#) That listing includes program and design criteria, courthouse planning and related guidelines, policies, and information on many facets of the design and construction of federal courthouses. The references listed below relate specifically to this chapter.

- American National Standards Institute (ANSI)/Telecommunication Industry Association standards, most current edition.
- “*AnyCourt*” (*Program of Requirements*), the Judiciary’s automated space-planning tool used to provide a court’s space program of requirements.
- *Courtroom Technology Audiovisual Infrastructure Manual*
- *Requirements and Specifications for Special Purpose and Support Space Manual (also referenced as USMS Publication 64), Volume One, Courthouse Management Group Engineering and Architectural*, most current edition
- *Requirements and Specifications for Special Purpose and Support Space Manual (also referenced as USMS Publication 64), Volume Two, Electronic Security and Hardware*, most current edition
- *Requirements and Specifications for Special Purpose and Support Space Manual (also referenced as USMS Publication 64), Volume Three, Judicial Security Systems Requirements and Specifications*, most current edition
- *United States Courts, Courthouse Design Reference Manual: An Architect’s Desk Reference*, most current edition
- *Guide to Judiciary Policy*, Volume 16, Chapter 2, Section 260, and Volume 12, Chapter 7, Section 750.40

Programming and Budgetary Notes

Programming and budgetary notes found throughout the *Design Guide* provide assistance with decisions to be made during the development of courthouse projects. The notes include both judicial branch policy and lessons learned from completed projects. The notes supplement the criteria in the *Design Guide*; their purpose is to provide direction in using the flexibility of the *Design Guide* to develop justifiable and cost-effective federal courthouse projects.

Space Envelope Flexibility

A total space envelope for new space will be calculated using appropriate circulation factors, allowances for support-type spaces, and the space standards described in the *Design Guide*. Courts have the flexibility to configure space within the envelope to meet their local needs. However, design and construction should be in general compliance with the square footage standards designated in the *Design Guide* in the space and ceiling

requirements tables. If the court unit wishes to significantly change the space standards described in the space and ceiling requirements tables without exceeding the total envelope of space for the unit, it must seek approval from its respective circuit judicial council.

The space envelope for a respective court unit is defined as:

- Entire clerk’s office
- Entire probation office
- Entire pretrial services office
- Entire staff attorney’s office
- Entire circuit executive’s office
- All courtrooms designated by judge type (circuit judges, district judges, magistrate judges, and bankruptcy judges)
- All chambers designated by judge type (circuit judges, district judges, magistrate judges, and bankruptcy judges)

For existing space, courts have the flexibility to configure space within the existing envelope to meet their local needs. However, any significant departure from the square footage standards designated in the *Design Guide* in the space and ceiling requirements tables must be approved by the respective circuit judicial council. This does not mean that existing space must be changed to meet *Design Guide* standards. Only new construction completed as part of a renovation should be considered.

Renovations and Alterations (R&A)

Many of the construction projects conducted in the Judiciary are renovations to existing space. Although the *Design Guide* applies to these projects, it is understood that some standards in the *Design Guide* are difficult or impossible to achieve in existing space, particularly in historic buildings. Courts should consult [Chapter 17, “Renovations and Alterations \(R&A\),”](#) and [Facilities Standards for the Public Buildings Service \(GSA PBS P-100\)](#) for guidance in these circumstances. References to R&A guidelines are also included throughout the *Design Guide* where appropriate.

Exceptions to the *Design Guide* Standards

The *Design Guide* provides guidance on standards for courthouse construction and renovations to existing space. Any significant departure from these standards is considered an exception and must be approved by the respective authority as outlined below.

Authority of the Circuit Judicial Councils

Circuit judicial councils play an important space-management role by reviewing district-wide facility plans, approving requests for new or modified space, and enforcing adherence to design guidelines. The circuit judicial councils have authority over, and responsibility for, a circuit’s space-management program (28 USC §332 and §462(b)) and

for determining the need for space. As directed by the Judicial Conference of the United States (JCUS), any significant departure from the standards in the *Design Guide* must be approved by the respective circuit judicial council.

Authority of the Committee on Space and Facilities

The authority to approve the following exceptions to the *Design Guide* standards rests with the Committee on Space and Facilities: (1) exceeding the total envelope for either the court unit or the project as a whole, (2) changing the standard configurations for judges' chambers and courtrooms, and (3) exceeding the plumbing standards. If the Committee on Space and Facilities disagrees with a circuit judicial council request for one of these exceptions, the Judicial Conference will decide whether to grant the exception.

Authority of the Judicial Conference

The authority for approving any exception to prospectus-level courthouse projects that would result in additional estimated costs, including additional rent payment obligations, lies with the Judicial Conference. Approval is required, after review by the Committee on Space and Facilities, for any exception to the *Design Guide* approved by a circuit judicial council. The request must include (1) a justification for the exception and (2) a construction cost estimate. [All approved exceptions for prospectus-level projects](#) are reported to the General Services Administration (GSA) and Congress. Approved exceptions may require the project to be reauthorized by Congress if the exception had not been previously identified. Contact the Administrative Office of the U.S. Courts (AOUSC) for more detailed information.

For prospectus-level courthouse projects, if an exception is approved by the JCUS which would result in additional estimated costs, the chair of the circuit's space and facilities committee or the chief judge or other judge designated by the court that sought the exception that exceeds the *Design Guide* criteria must be willing, if requested by the Committee on Space and Facilities, to appear before Congress concerning funding for such construction.

General Programming Notes

The *Design Guide* is intended to be a performance document. Criteria for any space or grouping of spaces should be considered in conjunction with the specific needs of the court office or function for which space is being designed.

Criteria in the *Design Guide* do not represent space entitlements. The criteria apply to an array of space types that should be justified based on the specific purpose of each project. Facility plans, programs, and designs should include only the space needed to satisfy the functional and security requirements of the court.

Differences between the space in an existing facility and the criteria in the *Design Guide* are not justification for facility alteration and expansion. In such cases, alternatives to

space expansion are investigated before any additional space is requested. In addition, like-for-like space is not a guarantee. Space allocated in an existing location is not justification for the same amount of space in a new location if the space allocation is not warranted. Current needs should be evaluated when moving into new space to determine the appropriate space envelope. Any additional space must be approved by the appropriate authority. Design architects and court staff are prohibited from adding spaces not originally contemplated in the approved prospectus or design program. Increasing the floor area or building volume requires the necessary approvals.

General Budgetary Notes

Renovation and new construction occur when the court and circuit judicial council identify space needs through the Judiciary's asset management planning process and document these needs in the long-range facilities plan. GSA determines by what method the space is provided—for example, by the construction of a new building, the renovation of an existing building, a lease, or other means.

The Judicial Conference recognizes and strongly supports a pragmatic approach to design that includes the use of durable and sustainable materials. This approach ensures that courthouses constructed now will last well into the future.

Following the publication of the *2007 Design Guide*, the Judiciary introduced several cost-saving measures, such as courtroom sharing and the Integrated Workplace Initiative (IWI), that sought to provide flexibility and efficiency in court spaces while preserving the dignity of the Judiciary. Courtroom sharing for certain judge types is now a standard throughout the Judiciary, and IWI is recognized as an alternative to traditional office design. For more information on cost- and space-saving efforts and programs, contact the AOUSC Space and Facilities Division.

Functions and Activities

Shared Judges' Conference Rooms

Shared judges' conference rooms provide space for meetings, training sessions, and other functions involving all judges in a court. Circuit judges conduct case conferences in these spaces. A court may work within its space envelope to provide a larger conference room to accommodate all of the judges at the court, with approval from the respective circuit judicial council.

One shared conference room is provided for each of the three courts present in the courthouse: appellate, district (and magistrate), and bankruptcy.

Judges' and Juror Dining Areas

Separate judges' and juror dining areas should be provided only if the GSA plans a cafeteria in the building and should be located adjacent to the building's cafeteria. The judges' dining area provides a space separate from the main cafeteria to ensure judges' security and that ongoing proceedings are not compromised by inappropriate contact by a member of the public, jury, or other party to the case.

News Media Room

Reporters use the news media room as a base of operations to report on court matters. The news media room is a shared facility for all courts.

Alternative Dispute Resolution (ADR) Proceeding

ADR proceedings may be accommodated in unoccupied courtrooms and related attorney/witness rooms, trial jury deliberation rooms, or other available conference rooms. If a court determines that use of unoccupied courtrooms or other space cannot adequately accommodate the number of ADR proceedings generally held in a district, a court may elect to construct a separate ADR suite of rooms within their given space envelope, with approval from the circuit judicial council.

Mail and Package Screening Area

Adequate space should be provided adjacent to the loading dock or delivery entrance for secure, safe, and efficient screening of all mail and packages delivered to the courthouse. The space should include an area for a large dual generator X-ray.

Central Mail Facility

The central mail facility is designed to provide a safe location for opening and sorting mail in a contained environment. If a contamination occurs, the mail room is designed to prevent the spread of the threat agent throughout the building.

Bulk and Archival Storage

Space should be provided adjacent to the loading dock for secure storage of office or related equipment, supplies, and furniture. Additional storage space may be constructed within the court unit's space envelope, apart from bulk storage, with approval from the circuit judicial council.

Telecommunication Rooms

A secured-entrance room is required to house equipment from both telecommunications and data service providers and the demarcation point. The main telecommunications room should be centrally located to maintain recommended cabling distances and may include a cross-connect for an adjacent equipment distribution area. Card readers should be utilized to track those entering the telecommunications rooms.

Space requirements should provide flexibility for future improvements to the telecommunications system. These spaces may require 24/7 cooling. Within the communications distribution room, a horizontal distribution area is required for horizontal cross-connects from the distribution point for cabling to the equipment distribution area. In addition, a zone floor distribution area is required for structured cabling for the floor-standing equipment, and an equipment distribution area is required to place equipment cabinets and racks arranged to effectively dissipate heat from electronics.

Fitness Centers

Courts may plan for the construction of fitness centers in new courthouse construction projects by reconfiguring space within its space envelope for use as a fitness center, including appropriate shower facilities, so long as the fitness center does not increase the total square footage of the project (JCUS-MAR 17, p. 23).

If shared with other tenants, fitness centers are considered joint use spaces in federal buildings. Courts are encouraged to share fitness facilities with other building tenants. Tenants are charged rent directly in proportion to their percentage of federal occupancy through joint use charges. Whether a fitness center is planned and operated as judiciary space or as shared space with another agency, courts should consider the size of the space, as well as the cost of acquiring, building, or sharing, and maintaining the space. Any acquisition or build-out of space to be used for a fitness facility should comply with the business rules of the CRB program.

Sensitive Compartmented Information Facilities (SCIFs)

Some courts have projected an increase in the number of sensitive or classified documents that may be reviewed by the courts and, as a result, have requested the addition of a SCIF or secured room in new courthouse construction. A SCIF is an enclosed area within a facility that is used to review, process, and store sensitive and/or classified information.

Courts may plan for the construction of a SCIF in new courthouse construction or renovation and alteration projects. SCIFs may be incorporated by reconfiguring space within the court's total space envelope as long as the SCIF does not increase the total square footage of court unit where it is located. The design, construction, and operation of SCIFs is governed by the National Counterintelligence and Security Center's *IC Tech Spec 705, Technical Specifications for Construction and Management of Sensitive Compartmented Information Facilities*. The size and location of a SCIF is dependent on the needs of the court.

Users and Capacities

Users vary depending on the size of the courthouse; the type and volume of cases; and the number of maintenance staff, service company/agency personnel, and public individuals present. For the purposes of certain references in this *Design Guide*, the following designations apply:

A small courthouse has five or fewer courtrooms.

A medium courthouse has 6-12 courtrooms.

A large courthouse has 13-18 courtrooms.

An extra-large courthouse has more than 18 courtrooms.

Shared Judges' Conference Room

The primary users are the judges of the court. The number of users varies with the size of the court and the number of judges. A court may work within its space envelope to provide a larger conference room to accommodate all of the judges at the court, with approval from the respective circuit judicial council.

Judges' Dining Area

The number of users varies according to the number of judges, as noted in the program of requirements.

News Media Room

The number of users varies, as noted in the program of requirements. Courts may elect to eliminate the news media room if it is determined that it is not used enough to justify its construction. The square footage may then be used in another area of the courts space.

Alternative Dispute Resolution (ADR) Proceeding

ADR proceedings are generally conducted by magistrate judges. The number of proceedings conducted on a daily basis varies by district. If a court determines that use of unoccupied courtrooms or other space cannot adequately accommodate the number of ADR proceedings generally held in a district, a court may elect to construct a separate ADR suite of rooms within their given space envelope, with approval from the circuit judicial council.

Mail and Package Screening Area

The number of users varies depending on the size and number of agencies located within a courthouse.

Central Mail Facility

The number of users varies depending on the size and number of agencies located within a courthouse.

Bulk and Archival Storage

Each court unit should be provided a bulk storage unit adjacent to the loading dock for secure storage of office or related equipment, supplies, and furniture. Additional storage space may be constructed within the court unit's space envelope, apart from bulk storage, with approval from the circuit judicial council.

Telecommunications Rooms

Telecommunications and data requirements are based on the size of the agencies located within the courthouse. Space requirements should provide flexibility for future improvements to the telecommunications system.

Fitness Centers

The number of users varies depending on the size of the court and if the center is mutually agreed to be shared by all tenants.

Design Requirements

General Design Elements

Building support functions described in this chapter are limited to court-occupied spaces. Many of these areas are related functionally and spatially to general building support areas such as loading docks; refuse areas; mechanical, electrical, plumbing, and elevator service rooms; and others. Supporting documents should be referred to for detailed spatial requirements and design criteria.

Central Mail Facility

The design of a central mail facility provides physical countermeasures to prevent the transmittal of biological agents through the mail. Preventive measures that include the central mail facility’s location, finishes, equipment, and mechanical separation should be planned at the design stage.

A central mail facility should be constructed for all mail and package opening, sorting, and distribution. This joint-use facility does not preclude individual distribution and mail sorting facilities within court units. If all tenants (both judiciary and non-judiciary) agree to use a central mail facility for opening and sorting mail, the design team should refer to [GSA PBS P-100](#) for size and design specifications. A central mail facility is considered to be building joint-use space, with all tenants funding their organization’s prorated share of the facility. A counter in the central mail facility should accommodate a sink, eyewash, and upper and lower storage for protective supplies and equipment, such as gloves and gowns.

Refer to [Chapter 16, “Building Security,”](#) for additional security requirements regarding central mail facilities.

Fitness Centers

When designing fitness centers in new construction projects or existing facilities, GSA and its architects should be consulted so that the following key factors are addressed:

- Floor Loading - Prospective equipment and activities to be conducted in the fitness center should be defined during planning and design to assure adequate floor loads are established.
- Acoustics - Consideration should be taken to the appropriate location of fitness centers and acoustical treatments to the envelope to avoid disruption to adjoining departments.
- Mechanical - Consideration to occupancy and activities planned for the fitness center should be accounted for in the mechanical design for the space.
- Audiovisual – Infrastructure should be considered for the following AV system in the fitness center.
 - Ceiling- or wall-mounted television displays with cable tuners.
 - Cable television connections to cardio equipment.
 - Local sound system if the fitness area is to include an aerobics studio.

For guidance on the purchase of fitness equipment, refer to *Guide to Judicial Policy*, Vol 16, § 460.20 and Vol. 12, § 750.40.

Shower and Changing Facilities

Appropriate shower facilities may be located within fitness centers (JCUS-MAR 17, p. 23).

Table 11.1
Ceiling Requirements for Shared Support Spaces

Space Name	Ceiling Height (feet)	Ceiling Height (mm)
Shared Judges’ Conference Room	10	3,000
Judges’ Dining Area	10	3,000
News Media Room	10	3,000
Central Mail Facility	10	3,000
Delivery, Disposal, and Storage Areas	Exposed to Structure	
Equipment Rooms	Exposed to Structure	

Table 11.2
Space Requirements for Shared Support Spaces

Shared Support Spaces		
Shared Judicial Areas	NSF	Nm ²
Shared Judges’ Conference Rooms ¹ (min/max)	200/800	18.6/74.3
Judges’ Dining Area ² (min/max)	200/400	18.6/37.2
Support Areas	NSF	Nm ²
News Media Room		
Small Courthouse (five or fewer courtrooms)	150	13.9
Medium Courthouse (6-12 courtrooms)	250	23.2
Large Courthouse (13-18 courtrooms)	450	37.1
Extra-Large Courthouse (more than 18 courtrooms)	600	55.7
Central Mail Facility		
GSA PBS P-100 Small/Medium Courthouse (12 or fewer courtrooms)	880	81.7

GSA PBS P-100 Large/Extra-Large Courthouse (13 or more courtrooms)	1,100	102.1
Delivery, Disposal and Storage Areas	NSF	Nm ²
Loading Dock	Refer to the AnyCourt Program/GSA PBS P-100	
Temporary Storage	Refer to the AnyCourt Program/GSA PBS P-100	
Bulk and Archival Storage Areas	Refer to the AnyCourt Program	
Mail and Package Screening Stations ³	Refer to the Judicial Security Systems Requirements and Specifications, USMS Volume III Publication 64	
Equipment Rooms	NSF	Nm ²
Telecommunications Rooms	Refer to the AnyCourt Program	

¹ Conference room at 100 NSF (9.2 Nm²) plus 25 NSF/judge (2.3 Nm²/judge). Square footage allocation for minimum and maximum is inclusive of 20 NSF (1.9 Nm²) for a service unit.

² Dining area allocation is 15 NSF (1.4 Nm²) per judge plus 20 NSF (1.9 Nm²) service unit. The minimum allocation is 200 NSF (18.6 Nm²) and the maximum allocation is 300 NSF (27.8 Nm²) inclusive of the service unit.

³ Areas given are exclusive of the mail- and package-screening area on the loading dock. Only one central mail facility is funded for new construction.

Adjacency and Circulation

Shared Judges' Conference Room

The shared judges' conference room should be in a central location to allow access for all judges. The conference room should be accessible from restricted circulation.

Judges' Dining Area

The dining area should be placed adjacent to the cafeteria.

News Media Room

The news media room should be placed on the ground floor or adjacent to a courtroom. The room should be accessed only from public circulation.

Central Mail Facility

The mail room should be located adjacent to the loading dock on an exterior wall.

Bulk and Archival Storage

Equipment, furniture, and court or tenant storage should be accessed from restricted circulation and conveniently located near the loading dock and service elevator to allow for easy movement of materials throughout the building. In the archival storage area, each court-related office should have access only to its assigned space, as this area houses case records, administrative files, and other confidential materials.

Telecommunications Rooms

To prevent vandalism, access to telecommunication rooms should be strictly controlled, especially when the rooms are located on public corridors. The main telecommunications room should be secured with controlled access.

Fitness Centers





Fitness centers are best located on the first floor or basement level, to prevent disturbance of occupied spaces located below the facilities. Fitness centers should be secure, but do not need to be located in a restricted area. Refer to [Chapter 14, "Acoustics,"](#) for additional information.

Figure 11.1
Shared Support Spaces Adjacency Relationships

Colors Legend:

 **Chapter 11**
Shared Support Spaces

Symbols Legend:

-  Public Circulation/Vertical Circulation
-  Restricted Circulation/Vertical Circulation
-  Secure Circulation/Vertical Circulation
-  Service Vertical Circulation
-  Circulation Access Control Point

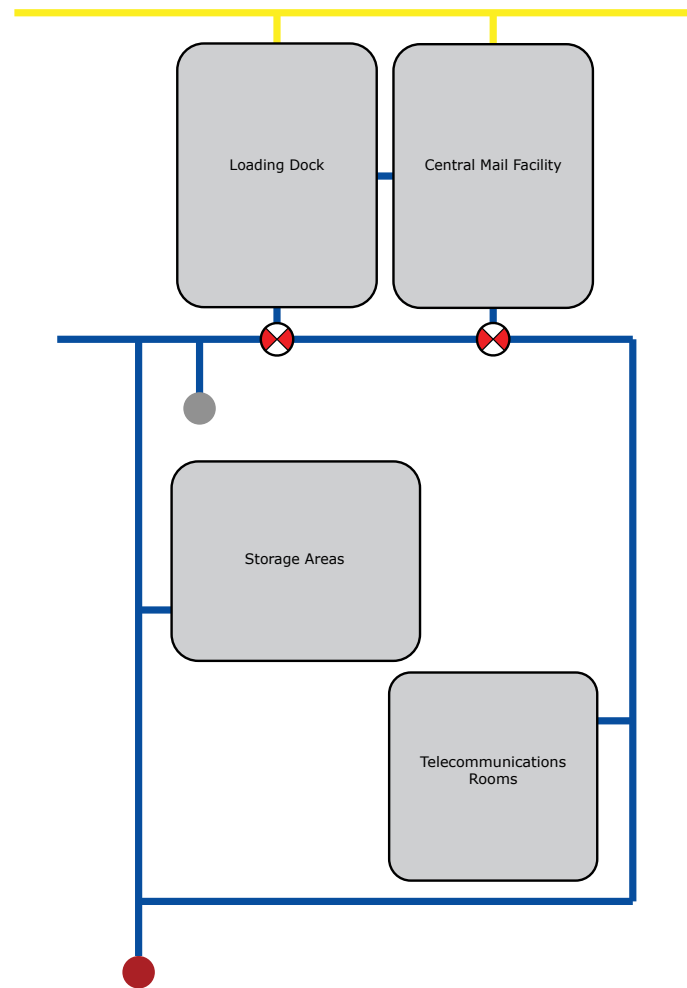

Note: The adjacency diagram is intended only as an illustration.



TENANT IMPROVEMENTS AND FURNISHINGS

This chapter addresses tenant improvements (interior finishes and millwork) and furnishings for all areas of the courthouse. Room-based specifics are included in the room data sheets of the appendix. *Facilities Standards for the Public Buildings Service* (GSA PBS P-100) finishes should be applied wherever requirements are not addressed in this chapter.

Chapter Topics:

- Introduction
- Supporting Documents
- Programming and Budgetary Notes
- Tenant Improvements - Interior Finishes
- Tenant Improvements - Millwork
- Furnishings

Chapter Figures and Tables:

Table 12.1 Sample Finish Schedule

Introduction

Tenant improvements are the finishes and fixtures that typically take a space from the shell condition to a finished, usable condition. The tenant improvement allowance is the funding source provided by the General Services Administration (GSA) that enables the space to be built out to meet the court's specific requirements. There are two components in the tenant improvement allowance: general and customization. The general tenant improvement allowance takes the unfinished shell to the standard GSA level of finish for office space. The customization allowance provides funding to meet court specific requirements.

Tenant Improvements – Interior Finishes

The finish section of this chapter includes the Judiciary's requirements and references the [GSA PBS P-100](#) finish criteria.

Tenant Improvements – Millwork

The millwork section of this chapter addresses millwork, doors, and some furniture items that are built into and procured as part of GSA construction process. Millwork is traditionally made of wood, used as a fixed finish surface or decorative ornament to a building element, such as wood paneling to a wall, or trim around windows and doors. Millwork is not equipment.

Furnishings

The *Design Guide* identifies furnishings provided by the GSA as well as some loose furnishings that are funded by the Judiciary. Furnishings are itemized in the *Design Guide* for the purpose of assisting designers during the conceptual design and the coordination of electrical requirements. Please refer to the *Guide to Judiciary Policy*, Volume 16, Chapter 4, for furniture cost ceilings and additional guidelines. Furniture is typically considered items that are able to be moved within the building.

Supporting Documents

A comprehensive guide to supporting documents can be found in [Chapter 2, "Courthouse Programming and Budgetary Considerations."](#) That listing includes program and design criteria, courthouse planning and related guidelines, policies, and information on many facets of the design and construction of federal courthouses. The references listed below relate specifically to this chapter.

- [GSA PBS P-100](#)
- *Guide to Judiciary Policy*, Volume 16, Chapter 4 and 5
- *Requirements and Specifications for Special Purpose and Support Space Manual* (USMS Publication 64), *Volume One, Courthouse Management Group Engineering and Architectural*, most current edition

- *Requirements and Specifications for Special Purpose and Support Space Manual* (USMS Publication 64), *Volume Two, Electronic Security and Hardware*, most current edition
- *Requirements and Specifications for Special Purpose and Support Space Manual* (USMS Publication 64), *Volume Three, Judicial Security Systems Requirements and Specifications*, most current edition
- *United States Courts, Courthouse Design Reference Manual: An Architect's Desk Reference*, most current edition

Programming and Budgetary Notes

Appropriate Level of Millwork and Finishes

Tenant improvements such as millwork and finishes in the interior of the courthouse should reflect the seriousness of the judicial mandate and the dignity of the judicial system. To this end, the finishes, millwork, and furnishings selected for a courthouse facility should express solemnity, integrity, rigor, and fairness. Any action taken by a court or circuit judicial council that would lead to extravagance in courthouse construction or renovation is prohibited; however, the Judicial Conference of the United States (JCUS) recognizes and strongly supports a pragmatic approach to design that includes the use of durable and sustainable materials. This approach ensures that courthouses will last well into the future. Colors should complement the natural, regional materials used in the design.

The materials employed should be consistently applied and durable, and should invoke a sense of permanence. Products with sustainable characteristics (i.e., regionally produced, natural, recycled content, and recyclable) should be utilized but should still meet the other criteria established for product selection. Plastic laminate is an acceptable choice for millwork.

The selection of finish materials should be appropriate for the specific space uses and compatible with the project budget.

A limited palette of finishes that responds to construction cost limitations, optimizes life-cycle costs, and satisfies functional requirements should be selected for each project.

Tenant improvements, including finishes and millwork, should be durable and sustainable. Maintenance costs and other life-cycle costs of finish materials should be considered.

Significant departure from the above criteria or from cost ceilings noted in the *Guide to Judiciary Policy* must be approved by the circuit judicial council.

Tenant Improvements – Interior Finishes

This section includes information on finish materials and design requirements for the use of finishes. The finish schedule, [Table 12.1](#), shows an example of finish selections for special-use areas of the courthouse. The table is intended to illustrate the type of finishes expected and what can be provided within the tenant improvement budget.

Finish Material Requirements

The selection of finishes for each project should address concerns about the image, construction costs, life-cycle costs, and maintainability of the project budget. While each construction project's budget should be maintained, life-cycle costs are a priority when selecting project finishes. Life-cycle cost considerations include but are not limited to ease with which materials can be maintained, enhanced durability, and maximizing the long-term appearance retention of products utilized. Limiting the quantity of specialty finishes and being selective in their application will minimize costs. However, this should be balanced; using select kinds of specialty finish materials and unique products in a maximum number of areas where such finishing is required can lead to larger orders that yield a buying power in the marketplace, which can enable the purchase of more bulk at a reduced per unit price.

Below are general requirements that apply to the selection of finishes throughout the courthouse:

- A selection of finish palettes for each space type in the courthouse should be selected and consistently applied throughout the courthouse. The palette of finishes may have variations in color and texture but the overall design aesthetic should complement the interior architecture. Once a palette of finishes is selected, the approved palette should be made the standard for the courthouse for future renovations and alterations.
- Finishes represent a standard or benchmark of stature, durability, functionality, and sustainability and are not intended to dictate specific design solutions or treatments.
- Finishes selected should meet the most stringent codes under which the facility is governed. Standards referred to should be the most current edition adopted by the international, federal, or local code authorities.
- Accepted industry standards for products and installation appropriate to the conditions, use, and substrate should be utilized for the selection and specification of all materials.
- Equivalent spaces should utilize the same finishes.
- Acoustic treatment, detailing, and material should be provided as required to meet noise criteria specified in [Chapter 14, "Acoustics."](#)
- Where access to infrastructure maintenance is above the ceiling, accessible finished ceiling assemblies should be used. Other ceiling elements, such as soffits, perimeter coves, recesses, and reveals, should be provided as required to integrate heating,

ventilating and air-conditioning (HVAC), lighting, and sound systems into a harmonious design.

- Where access to the electrical system, low-voltage systems (communications and audiovisual systems), and HVAC installed within the raised access flooring requires upgrades or maintenance, the raised access flooring finish should be easy to remove and reinstall without the additional expense of full removal and replacement of the finish.

Finish Requirements per Courthouse Space

Public Areas

Building Lobby and Primary Circulation

The interior architecture of public spaces in the courthouse should reflect a civic presence. Elevator lobbies on floors housing courts should be considered an extension of the main public lobby spaces. Similarly, for floors currently not housing courts but designated for court occupancy to meet future growth requirements, public and elevator lobbies should be designed with the proper physical structure and dimensions so that equivalent finish levels can be added. All finishes should be compatible with the overall architectural characteristics of the building.

The public lobbies and corridors may have a uniform palette of materials and finishes with minimal or no variations from the lobby to the doors of the courtroom, or alternatively, may have changes in materials and finishes along the procession from lobby to courtroom. Whichever the design preference, it should be compatible with the overall architectural character of the building. The materials and finishes should be able to withstand heavy use and frequent cleaning with cleaning solutions and maintenance equipment. Acoustics should be considered in materials selection for public areas, particularly in the main building entrances and atrium spaces. It is recommended to work with an acoustical consultant to evaluate the effects of material selections in these areas.

The following is a list of materials for consideration in building lobby and primary circulation areas. The suggested materials are not intended to influence quantities or suggest specific material choices. Materials should be selected while keeping in mind cost ceilings, durability, functionality requirements, and the dignity of the court:

- Floor and wall base – terrazzo or stone products; polished concrete is unacceptable for these areas.
- Walls – stone veneer, wood panel systems, glass wall panel systems, metal or other wall panel products, fabric wall covering, or painted gypsum wall board
- Ceilings – acoustical ceiling products, wood or metal ceiling systems, or painted gypsum board

Public Waiting Areas

Public waiting areas serve as extensions of public lobby and circulation areas adjacent to courtrooms; therefore, the design and furnishing of these spaces should be consistent.

The following is a list of materials for consideration in public waiting areas. The suggested materials are not intended to influence quantities or suggest specific material choices. Materials should be selected while keeping in mind cost ceilings, durability, functionality requirements, and the dignity of the court. This list is not comprehensive and is intended as a suggestion of acceptable materials:

- Floor and wall base – terrazzo or stone products
- Walls – stone veneer, wood panel systems, glass wall panel systems, metal or other wall panel products, fabric wall covering, or painted gypsum wall board
- Ceilings – exposed structure, acoustical ceiling products, wood or metal ceiling systems, or painted gypsum board

Jury Assembly

Furnishings and finishes should reflect the importance of jury service. Prospective jurors should be provided with a comfortable, safe environment in which to carry out their jury service. Jury assembly suites are comprised of many different spaces including areas for large assembly, transaction spaces, toilet rooms, work and office areas, as well as pantry and vending provisions. The materials and finishes should be able to withstand heavy use and frequent cleaning with cleaning solutions and maintenance equipment. Materials should be of a complementary palette throughout the entire suite and should coordinate seamlessly with the holistic building aesthetic. Acoustics should be considered in materials selection for all areas but specifically larger assembly areas. It is recommended to work with an acoustical consultant to evaluate the effects of material selections in these areas.

The following is a list of materials for consideration in jury assembly areas. The suggested materials are not intended to influence quantities or suggest specific material choices. Materials should be selected while keeping in mind cost ceilings, durability, functionality requirements, and the dignity of the court. This list is not comprehensive and is intended as a suggestion of acceptable materials:

- Floor and wall base – carpet, carpet tile, and resilient wall base
- Walls – wood panel systems, metal or other wall panel products, fabric wall covering, or painted gypsum wall board
- Ceilings – acoustical ceiling products, wood or metal ceiling systems, or painted gypsum wall board
- Counter interaction spaces – solid surfacing materials or natural quartz, and resin composite countertops

- Pantry/vending areas – premium vinyl tile or resilient flooring
- Toilet facilities – ceramic or porcelain tile products

Attorney Workroom and Attorney/Witness Rooms

Furnishings and finishes should be durable, easily maintained, and provide flexibility for multi-use functions within the space. Due to the confidential nature of discussions that occur within this space and their typical proximity to courtroom entrances and relationship to the public circulation zone, extreme care should be taken to select materials that provide an appropriate level of acoustical isolation.

The following is a list of materials for consideration in attorney workroom and attorney/witness rooms. The suggested materials are not intended to influence quantities or suggest specific material choices. Materials should be selected while keeping in mind cost ceilings, durability, functionality requirements, and the dignity of the court. This list is not comprehensive and is intended as a suggestion of acceptable materials:

- Floor, wall base, and chair rail – carpet, carpet tile, premium vinyl tile, resilient wall base and chair rail, or wood base and chair rail
- Walls – painted gypsum wall board
- Ceilings – acoustical ceiling products

Public Counter Interaction Spaces

Interaction spaces, such as the public counters in the clerk's office and other public-facing court units, should be provided with durable finishes compatible with the design aesthetic of the courthouse's public lobby and primary circulation areas. Acoustics should be considered in materials selection for public counter interaction areas. Floor, ceiling, and wall materials may be different on the public and staff side of the counter.

The following is a list of materials for consideration at public counter interaction spaces. The suggested materials are not intended to influence quantities or suggest specific material choices. Materials should be selected while keeping in mind cost ceilings, durability, functionality requirements, and the dignity of the court. This list is not comprehensive and is intended as a suggestion of acceptable materials:

- Floor and wall base – carpet, carpet tile, and resilient wall base; terrazzo or stone is also acceptable on the public side of the counter
- Walls – fabric wall covering or painted gypsum wall board
- Ceilings – acoustical ceiling products, wood or metal ceiling systems, or painted gypsum wall board
- Counter interaction spaces – solid surfacing materials or natural quartz, and resin composite countertops

Court Libraries

Furnishings and finishes located in central court libraries should be durable and easily maintained. Protection for interior wall surfaces should be provided to prevent damage from rolling book carts. Flooring selections should be able to accommodate heavy traffic and rolling book carts. Coffered ceilings should be avoided.

The following is a list of materials for consideration in central court library spaces. The suggested materials are not intended to influence quantities or suggest specific material choices. Materials should be selected while keeping in mind cost ceilings, durability, functionality requirements, and the dignity of the court. This list is not comprehensive and is intended as a suggestion of acceptable materials:

- Floor and wall base – carpet, carpet tile, and resilient wall base
- Walls – painted gypsum wall board with appropriate wall protection accessories
- Ceilings – acoustical ceiling products
- Counter interaction spaces – solid surfacing materials or natural quartz and resin composite countertops

News Media Room

Furnishings and finishes located in news media rooms should be durable and easily maintained and provide flexibility for a variety of uses.

The following is a list of materials for consideration in the news media room. The suggested materials are not intended to influence quantities or suggest specific material choices. Materials should be selected while keeping in mind cost ceilings, durability, functionality requirements, and the dignity of the court. This list is not comprehensive and is intended as a suggestion of acceptable materials:

- Floor and wall base – carpet tile, premium vinyl tile, vinyl tile, and resilient wall base
- Walls – painted gypsum wall board with appropriate wall protection accessories
- Ceilings – acoustical ceiling products

Courtrooms

Finishes in the courtroom should reflect the seriousness and promote the dignity of court proceedings. Finishes are an integral part of the courtroom's architectural design. Courtroom millwork should be equivalent to the Architectural Woodwork Institute's (AWI) *Quality Standard for Premium Millwork*. Decorative moldings to include but not be limited to base, chair rail, crown, panel molding, caps, and other miscellaneous moldings should be utilized throughout the courtroom. Trim and molding should be complementary of the building design aesthetic or consistent with the existing building design details. Acoustics should be considered in materials selection for courtrooms. It is recommended to work with an acoustical consultant

to evaluate the effects of material selections in these areas. Walls and ceilings are primary surfaces for acoustic treatment within a courtroom. An acoustical consultant can assist with evaluating the optimal locations for sound absorbency, diffusion and reflection to achieve the desired acoustical criteria. Ceiling design and material selection should emphasize the dignity and hierarchy of the courtroom bench positions. Consideration should be taken to avoid materials interfering with electronic signals and other critical courtroom systems.

The following is a list of materials for consideration in the courtrooms. The suggested materials are not intended to influence quantities or suggest specific material choices. Materials should be selected while keeping in mind cost ceilings, durability, functionality requirements, and the dignity of the court. This list is not comprehensive and is intended as a suggestion of acceptable materials:

- Floor, wall base, chair rail and other moldings – carpet and wood
- Walls – wood panels, stone veneer, metal panel systems, acoustical materials, decorative plaster, and painted gypsum wall board
- Ceilings – acoustical ceiling products including, but not limited to, wood and metal ceiling systems, and painted gypsum wall board
- Millwork and counter surfaces – wood, natural stone, leather, high-pressure laminate, solid surfacing material, and natural quartz and resin composite countertops

Restricted Areas

Judges' Chambers Suites

The finishes in judges' chambers suites should reflect the design quality of the courtroom; chambers should be viewed as an extension of the courtroom. The application of wood paneling products should be limited to wainscot and accent details to achieve a complimentary design aesthetic to the courtroom or the existing building design detailing. Due to the confidential nature of discussions that occur within this space and their typical proximity to courtrooms and restricted corridors, care should be taken to select materials that provide an appropriate level of acoustical isolation.

The following is a list of materials for consideration in the chambers. The suggested materials are not intended to influence quantities or suggest specific material choices. Materials should be selected while keeping in mind cost ceilings, durability, functionality requirements, and the dignity of the court. This list is not comprehensive and is intended as a suggestion of acceptable materials:

- Floor – carpet or wood
- Wall base, chair rail, and other moldings – wood
- Walls – wood wainscot, painted gypsum wall board, or fabric wall covering

- Ceilings –acoustical ceiling products and painted gypsum wall board
- Millwork and counter surfaces – wood, natural stone, high-pressure laminate, solid surfacing material, and natural quartz and resin composite countertops
- Window Frames/Sills - wood
- Window Coverings - drapes, blinds, microshades
- Private toilets – porcelain or ceramic tile

Restricted Corridor

Restricted and secure corridors should convey a similar and consistent aesthetic to adjacent spaces within the court floor plans. Restricted corridors should be finished consistently with the courtrooms and chamber spaces.

Secure Areas

Corridors and other spaces utilized for prisoner movement or occupied by the U.S. Marshals Service (USMS) should be in compliance with USMS Publication 64.

Service/Support Areas

Service and building support areas (central mail facilities, loading dock, recycling rooms, building systems spaces) should utilize durable, easily cleaned and maintained finishes.

Other Court Units

Clerk’s Office, Probation/Pretrial Services, Other Court Departments Not Addressed

Other court units such as the clerk’s office, probation/pre-trial services, and pro se typically have a component that interacts with the public and a restricted staff only component. Interaction spaces, such as the public counters in the clerk’s office and other public-facing court units should be provided with durable finishes compatible with the design aesthetic of the courthouse’s public lobby and primary circulation areas. Acoustics should be considered in materials selection for public counter interaction areas. Floor, ceiling, and wall materials may be different on the public and staff side of the counter. The restricted staff components within these areas may be configured in a variety of ways. Acoustical considerations should be evaluated based on the layout of the spaces to provide a comfortable and efficient work environment.

The following is a list of materials for consideration in other court unit areas. The suggested materials are not intended to influence quantities or suggest specific material choices. Materials should be selected keeping in mind cost ceilings, durability and functional requirements of the space, and dignity of court. This list is not comprehensive and is intended as a suggestion of acceptable materials:

- Floor and wall base at staff work and public interaction areas – carpet tile, resilient wall base; terrazzo or stone is also acceptable on the public side of the counter

- Floor and wall base at multi-purpose rooms – resilient flooring, carpet tile, and resilient wall base
- Floor and wall base at urinalysis labs and sample collection areas – resilient flooring and wall base or anti-microbial epoxy flooring and integral cove base
- Floor and wall base at storage and workroom areas – resilient flooring and wall base
- Walls – painted gypsum wall board, water-based catalyzed epoxy paint in urinalysis labs and collection areas
- Ceilings – acoustical ceiling products
- Counter interaction spaces – solid surfacing materials or natural quartz and resin composite countertops

Sample Finish Schedule

Table 12.1 shows an example of finish selections for a U.S. courthouse. The sample is from a federal courthouse project that was designed and constructed within the tenant improvement (TI) construction budget allotment. The schedule shows a range of finishes to meet aesthetic quality expectations and project constraints. These finish schedules should not be considered to be prescriptive. The design team should develop a finish schedule that complements and maintains the integrity of the building’s architectural design and style while meeting the project’s quality requirements and cost limitations.

Legend

Sample Finish Schedule Abbreviations

Abbreviation	Material
ACP	Acoustical Ceiling Panel or Tile
AWP	Acoustical Wall Panel
CT	Ceramic Tile
CPT	Carpet Tile or Broadloom
GB	Gypsum Board
PNT-1	Latex paint with eggshell finish. Preferred finish, unless noted otherwise.
PNT-2	Latex paint with semi-gloss finish. To be used in wet areas such as service units and restroom wet walls.
PNT-3	Water-based catalyzed epoxy or equivalent. To be used for the urinalysis lab.
SVT	Solid/Premium Vinyl Tile
VCT	Vinyl Composition Tile
V/RB	Vinyl/Rubber Base
WD	Wood

Table 12.1
Sample Finish Schedule

Courtrooms	Floor	Base	Wall	Ceiling
	CPT	WD	WD, AWP, PNT-1 on GB	PNT-1 on GB
Judges' Chambers Suites	Floor	Base	Wall	Ceiling
Judge's Chambers Office	CPT	WD	FWC above WD Wainscot	ACP
Judges' Conference/Reference Room	CPT	WD	FWC above WD Wainscot	ACP
Toilet	CT	CT	PNT-2 on GB	PNT-2 on GB
Reception Area	CPT	WD	FWC above WD Wainscot	ACP
Judicial Assistant's Office	CPT	WD	FWC above WD Wainscot	ACP
Law Clerk Office	CPT	WD	PNT-1 on GB	ACP
Copy/Workroom	SVT	V/RB	PNT-1 on GB	ACP
Service Unit	SVT	V/RB	PNT-2 on GB	ACP
Chamber Corridor	CPT	WD	PNT-1 on GB	ACP
Courtroom Deputy Office	CPT	V/RB	PNT-1 on GB	ACP
Storage/Closet	CPT	V/RB	PNT-1 on GB	ACP
Associated Spaces	Floor	Base	Wall	Ceiling
Attorney/Witness Room	CPT	V/RB	PNT-1 on GB	ACP
Judges' Conference/Robing Room	CPT	WD	FWC above WD Wainscot	PNT-1 on GB or ACP
Soundlock	CPT	WD	PNT-1 on GB	PNT-1 on GB
Attorney Workroom	CPT	V/RB	PNT-1 on GB	ACP
Appellate Robing Room	CPT	WD	WD Chair Rail	ACP
Trail Jury Suite	CPT	V/RB	PNT-1 on GB	ACP
Grand Jury Suite	CPT	V/RB	PNT-1 on GB	ACP
Jurors' Toilet	CT	CT	PNT-2 on GB	PNT-2 on GB

Table 12.1
Sample Finish Schedule (cont'd)

Other Court Units and Special Facilities	Floor	Base	Wall	Ceiling
Shared Judges' Conference Room	CPT	WD	FWC above WD Wainscot	ACP
Circuit Executive Private Office	CPT	WD	WD Chair Rail	ACP
Senior Staff Attorney Private Office	CPT	WD	WD Chair Rail	ACP
Clerk of Court Private Office	CPT	WD	WD Chair Rail	ACP
Chief Probation/Pre-trial Services Private Office	CPT	WD	WD Chair Rail	ACP
Circuit Librarian Private Office	CPT	V/RB	PNT-1 on GB	ACP
Stack Area	CPT	V/RB	PNT-1 on GB	ACP
Bankruptcy Administration Office	CPT	V/RB	WD Chair Rail	ACP
Conference Attorney Private Office	CPT	V/RB	WD Chair Rail	ACP
District Court Executive Private Office	CPT	V/RB	WD Chair Rail	ACP
Bankruptcy/Appellate Clerk Private Office	CPT	V/RB	WD Chair Rail	ACP
Probation Urinalysis Laboratory	VCT	V/RB	PNT-3 on GB	PNT-3 on GB

Tenant Improvements - Millwork

This section is intended to provide requirements for the overall quality and amount of millwork in the courthouse. This section addresses funding responsibilities, materials, and design requirements. Refer to the individual room data sheets (RDSs) included in the appendix for a list of required millwork pieces per space. For specific information on station plans, sections, details, and dimensions refer to *United States Courts, Courthouse Design Reference Manual: An Architect's Desk Reference*. Information on the layout of millwork within particular types of spaces is addressed in the space chapters of this document. Refer to Chapters 14-16 for [acoustics](#), [building systems](#), and [security](#) requirements that should be addressed in the construction of millwork.

Millwork Funding Responsibilities

All costs for millwork described in this section, including the movable attorney/prosecutor lectern and attorney/litigant tables, should be funded out of the construction project. This does not include the evidence presentation cart. Coordinate the purchase of the evidence cart with the furniture acquisition plan (FAP). Coordinate infrastructure requirements for all millwork and furniture even that which is not provided as part of the construction funding as part of the base building scope. Any movable items included below should be constructed to ensure continuity of veneer type, stain, and style.

Materials Requirements

Millwork for courtrooms, courtroom associated spaces, and judges' chambers suites should be constructed to AWI standards for premium-grade millwork. The millwork in all other courthouse spaces should be constructed to AWI standards for custom-grade millwork unless noted otherwise.

Design Requirements for Millwork

Many components of building systems, security, and technology are integrated into millwork and should be able to be serviced, upgraded, or replaced over the life cycle of the courthouse. Millwork pieces should be designed to incorporate these requirements. This requirement may be achieved by discreetly locating access panels and hinged pieces to accommodate service access. Refer to [Chapter 4, "Courtrooms and Associated Spaces,"](#) for functional layout, proximity, and sight-line requirements. Refer to [Chapter 14, "Acoustics,"](#) for acoustic requirements; [Chapter 15, "Building Systems,"](#) for building systems requirements; and [Chapter 16, "Building Security,"](#) for security requirements. Consult with the Administrative Office of the U.S. Courts (AOUSC) for additional guidance.

Recurring Millwork Items

Millwork items listed below are used in multiple locations throughout the courthouse.

Doors

All courtroom and chamber doors are to be hardwood-veneer solid-core doors unless security requirements for a particular entry cannot be achieved with this type of door. Where wood doors are specified, they should be finished with stain and a clear sealer. Use AWI premium-grade solid hardwood door jambs, stops, and casings. Doors should be coordinated with USMS security requirements.

Where doors are a part of soundlocks, the doors should include an industry standard sound seal gasketing package including an overlapping astragal seal. Use of sidelights at office doors should be considered for light transmission if they can be accommodated within the project's TI allowance. Where privacy and sound isolation is a concern, the use of side lights should be limited and designed per [Chapter 14, "Acoustics."](#)

Service Units

Service units should be standard-size plastic-laminate or wood upper and lower wall-mounted cabinets and solid surface countertops with an integral sink of a durable material. Intermediate shelves should be provided in upper and lower cabinets. Adjacent to the sink, one drawer minimum should be provided for food preparation utensils and other supplies. Units should be laid out to accommodate some or all of the following: a microwave oven, a sink, a coffeemaker, under-counter lights, and a refrigerator. A wall-mounted shelving unit above the sink area to accommodate the microwave oven may be provided as an option. A service unit in the judges' conference room for the en banc courtroom should be custom-grade wood. Design to coordinate millwork cutouts and infrastructure required for any appliances purchased by a court or judges.

Courtrooms

Millwork is an integral part of courtroom design. The durability, functionality, and quality of the millwork should reflect and complement the aesthetics and dignity of the courtroom. A consistent veneer finish with compatible trim is preferred for all millwork in the courtrooms. The height, area, position, and relationship of the courtroom bench positions emphasizes the role of the courtroom occupants and facilitates control of the court. Refer to [Chapter 4, "Courtrooms and Associated Spaces,"](#) for additional detail on courtroom bench and furniture requirements.

The relative heights of furniture and the dimensions of work surfaces are critical to efficient courtroom operation and must be coordinated with and approved by the Judiciary prior to execution. A significant element of courthouse design is the accessibility to justice. For this reason, accessibility of courtrooms is a requirement for the design and construction of courtroom millwork. Seated work surface heights in the courtrooms should be consistent within and between courtrooms. Please refer to [Chapter 3, GSA PBS P-100](#) and applicable codes for guidance on accessibility within the courtroom.

Audiovisual and security equipment, including mobile video monitors and cameras, projectors, and audio recording/playback equipment used in the courtroom, should be accommodated in storage as well as built into ceilings, walls, or courtroom furniture. The inside panels of the bench, witness box and jury rails should allow for access to support technology cabling. The judge's bench, as well as the courtroom deputy and court reporter stations, should accommodate audio-system electronic sound-recording equipment and electronic data devices (computers or terminals), with the necessary openings in the work surfaces drilled or cored to accommodate cabling and fitted with grommets sized to the openings.

Furnishings

This section of the chapter addresses the furniture, accessories, and equipment requirements for special-function areas in the courthouse. Acquisition of furniture is typically accomplished under a separate contract.

The design team should consult with the AOUSC on furniture policies and procedures for judges and other court staff. *The Guide to Judiciary Policy*, Volume 16, Chapter 4, Furniture, Appliances and Related Services sets the Judicial Conference policies for furniture acquisition and level of furniture for all court employees.

Furniture, equipment, and accessories in the courthouse may be procured as part of the construction contract or by the courts directly. Refer to the individual RDSs included in the appendix for the funding responsibility of each furniture item. The balance of the furniture, equipment, and accessories listed on the RDSs is provided for the purpose of designing electrical infrastructure and laying out functional spaces.

Furniture Acquisition Plan (FAP)

The *Guide to Judiciary Policy*, Volume 16, Chapter 4, § 430.50.10, details the policies and procedures for FAPs.

The FAP is a formal documentation and analysis of a court's furniture requirements. All FAPs must be approved and signed by the chief judge and must include the following:

- Furniture inventory database
- Floor plans
- Budget request
- Specification for purchase
- List and cost of new furniture
- Room-by-room summary itemizing new and refurbished furniture costs
- Plan for the disposition of excess furniture
- Furniture procurement schedule

General Requirements

The design team should consult with the court and AOUSC to ensure that the new courthouse spaces can accommodate existing furniture that will be used in the new facility. Existing furniture should be used wherever possible. However, new courthouse spaces should not be adjusted to exceed the size standards set forth in the *Design Guide* in order to accommodate the existing furniture or exceed the space envelope for the court unit.

The requirements address overall goals for courthouse projects and therefore apply to the entire courthouse. A limited variety of furniture, accessories, and equipment that respond to construction cost limitations and optimize life-cycle costs should be selected for each project. Consideration should be given to using furniture within the same series to respond to variances in applications. Selections should also consider the operational flexibility of the court to move furnishings to support varying needs while maintaining a consistent design aesthetic.

Materials and products used should be durable, stain resistant, and low maintenance. The selection of furniture materials should be appropriate for the specific space uses and compatible with the project budget.

Furniture finishes selected should consider light reflectance.

All furniture should be selected to allow accessibility for all court activities. This includes ensuring that access routes are the same for persons with disabilities.

System furniture cost ceilings are provided in the *Guide to Judiciary Policy*, Volume 16, Chapter 4. Also refer to [Chapter 18, "Alternative Workplace Strategies,"](#) for examples of systems furniture configurations.

Equipment for Service Units

Sinks provided in service units are a part of the construction contract, and the location is provided in the respective space requirements. Specific equipment to be provided is listed on the millwork schedule with the service units.

Toilet Room Accessories

Toilet rooms listed on the space lists should receive the following accessories:

- **Single-Person Toilet Room** - All single-person toilet rooms listed on space lists should receive a toilet paper holder, a paper towel dispenser/disposal unit, a soap dispenser, and a mirror. Baby-changing facilities should be accommodated in public toilet rooms.
- **Multi-Person Toilet Room** - All multi-person toilet rooms should receive toilet paper holders, towel dispenser/disposal units, soap dispensers, and mirrors as appropriate for the size and capacity of the room. Baby-changing facilities should be accommodated in public toilet rooms.
- **Wellness/Lactation/Family Toilet Room** - Refer to [GSA PBS P-100](#)

Courtrooms and Associated Spaces

In spaces with millwork, wainscot, or wood trim where wood furniture or accessories will be utilized, furniture and accessories should be selected with standard finishes as close as possible to the built-in woodwork of the space.

Courtrooms

Furniture, accessories, and equipment are an integral part of courtroom design. Their durability, functionality, and sustainability should reflect the aesthetics and dignity of the courtroom.

Furniture in courtrooms should be selected to support the need for all participants to see and hear one another clearly.

Judges' seating in multi-seat benches should be the same. In courtrooms with single-judge benches, the judge should select a chair to accommodate his or her stature and comfort. In all cases, the design team should consider the color scheme and finishes.

Court seals are purchased in accordance with the *Guide to Judiciary Policy* through the GSA Great Seal Program. The seals are available in metal or polystyrene foam and come in a variety of finishes. Custom architectural seals in millwork, glass, marble, or metal are funded as part of the construction budget.

Court Reporter/Recorder

Storage areas for court reporters/recorders should be furnished to accommodate typed transcripts and both loose and boxed steno-tapes.

Attorney/Witness Room

Each room is provided with a lounge or conference furnishings.

Attorney Work Room

Appropriated court funds should not be used to furnish the space.

Public Waiting Areas

Courtroom waiting areas adjacent to courtrooms serve as extensions of public lobby and circulation areas; therefore, the furnishings utilized for these spaces should be consistent with those of the spaces they adjoin. Furnishings should be comfortable but durable, and should be fixed to the floor or walls in small groups.

Judges' Chambers Suites

In spaces with millwork, wainscot, or wood trim where wood furniture or accessories will be utilized, furniture and accessories should be selected with standard finishes as close as possible to the built-in woodwork of the space.

Furniture in the offices of a judge's support staff, including the secretary and law clerk, should be coordinated to complement the finishes used throughout the judge's chambers suite. Refer to the *Guide to Judiciary Policy*, Volume 16, Chapter 4, for furniture requirements for judges, law clerks, and chambers support staff.

Court Unit Standards for Private and Open Workstations

Court Unit Executive, Supervisory Staff, and Professional Staff Private Offices

Refer to the *Guide to Judiciary Policy*, Volume 16, Chapter 4, for furniture requirements for courtroom personnel and for private offices.

System Furniture Standards

The following standards apply to court staff work spaces throughout the courthouse, except the judges' chambers staff.

- Team Leaders - Systems furniture configuration, 96 square feet (8.9 m²)
- Court Unit Secretaries and Support Positions - Systems furniture, 64 square feet (5.9 m²)

The design team should plan and design the electrical, telephone, and data connections for systems furniture workstations to be provided through the access-floor cabling and electrical distribution systems.



INTERIOR SIGNAGE

This chapter applies to interior signage throughout U.S. federal court facilities.

Chapter Topics:

- Introduction
- Supporting Documents
- Programming and Budgetary Notes
- Design Requirements

Introduction

Signs significantly impact the functional and aesthetic quality of a court facility. Many federal courthouses are large, complex structures requiring clear and coordinated systems of signage and way-finding that allow first-time users to locate their place of involvement in the judicial process as quickly and directly as possible. Signs and signing systems should provide a coordinated and efficient system of recognition, direction, and information throughout a courthouse. The specific strategy for a building's signs should be determined early in the facility design process and developed along with other details of the design. Signage should emphasize the natural flow of the spaces in the courthouse, which should be the principal means for directing the public to elevators, clerks' offices, jury assembly areas, courtrooms, and other destinations.

Supporting Documents

A comprehensive guide to supporting documents can be found in [Chapter 2, "Courthouse Programming and Budgetary Considerations."](#) That listing includes program and design criteria, courthouse planning and related guidelines, policies, and information on many facets of the design and construction of federal courthouses. The references listed below relate specifically to this chapter.

- [Architectural Barriers Act Accessibility Standards \(ABAAS\)](#)
- [California Trial Court Facilities Standards, Judicial Council of California](#)
- [Guide to Judicial Policy, Vol. 16, Chapter 4](#)
- [National Digital Signage \(NDS\) Program](#)

Programming and Budgetary Notes

The General Services Administration (GSA) provides limited signage in federally owned and leased buildings in accordance with the terms and conditions of applicable lease agreements, occupancy agreements, and construction contracts. This scope typically includes exterior signage and the main lobby building directory in new construction projects. The design team should refer to [Facilities Standards for the Public Buildings Service \(GSA PBS P-100\)](#). GSA signage standards will be included in the architectural/engineering scope of services.

The Judiciary must fund any additional signage beyond the GSA scope. Typically, all interior signage in court spaces, including floor directories, is to be paid for by the Judiciary. Refer to the [Guide to Judicial Policy, Vol. 16, Ch. 4, Section 455](#), for a detailed explanation of the design and procurement process for interior signage.

Design Requirements

The three basic categories of signs are (1) informational, (2) direction, and (3) labels. Labels describe the function or occupant of a space. Informational signs advise of court facility activities and schedules. With the advancement of technology, the use of electronic and interactive systems may be considered when designing courthouse signage. The design team should consult with the court's IT staff to best determine how computer-based systems may be used to integrate and automate the signs.

All signage must meet the requirements of ABAAS. The U.S. Access Board is specific about parameters of design such as the location, size, color, and tactile qualities of signage. The design must coordinate with the U.S. Marshals Service (USMS) on the technical security equipment placement.

Factors to be considered in the design of signs and public information systems include the following:

- Materials, colors, and graphics
- Placement of signs and kiosks
- Handicapped accessibility
- Placement of conduit for computer-based information systems
- Cost
- Flexibility and cost for future modifications

A standardized, integrated, complementary, and comprehensive signage program should address both code-required signage (such as exit signs, exiting plans, and room numbers) and non-code-required signage (building directories, notices, etc.). The graphics and signage programs should be developed during early design stages to integrate signage with the design concept, functional program, and building circulation zones. Attractive, legible signs showing directions and information should be incorporated into the design of all public areas. The signage program should be adaptable for future change without damaging the public corridor wall finishes.

Rooms should be numbered logically and consecutively to enable visually impaired persons to make assumptions about where their destination is located. Public room numbers should be sequential and predictable. Courtroom labels should be based on a predictable sequence. For example, a second-floor courtroom should be labeled Courtroom 200.

Room label signage should be positioned at doorways, where sight-impaired persons expect to find information. Signage for building-management rooms, which are not accessible to the public, should be located in different areas than accessible signage. The following guidelines apply to signage and graphics in various locations within the building.

Building Entry - GSA Scope

Signage at the entry should be restricted to preserve a unified and attractive facade.

Building Directory - GSA Scope

A building directory should be located near the main public entrance. The directory should contain a diagram listing all the major building components. This directory, which may be integrated into an information booth or kiosk, should be located in an area seen by members of the public after they have been screened.

Floor Directory - Judiciary Scope

Smaller directories should be provided in each elevator lobby with information about the various occupants of that floor. Arrows should be grouped in similar directions to facilitate communication.

Courtroom Entry Signage - Judiciary Scope

All signs outside courtroom doors should be of uniform appearance. The courtroom numbering system should be displayed at the top and in the largest font size.

Other Signage - Judiciary Scope

A consistent, controlled system of other signs, such as restricted access warnings, directional signs, signs designating special handicapped services, and procedural guides, should be provided. If high-traffic areas such as the jury assembly room and the public counter are not immediately visible from the entry lobby, clear graphics should be prominently displayed to guide users to these areas.

Optional Electronic Signage

With the advancement of technology, the use of electronic and interactive systems may be considered when designing courthouse signage. Electronic signage and its respective infrastructure must be funded by the Judiciary if requested.

All contemporary electronic signage players, whether stand alone or embedded in a display or interactive kiosk, are Ethernet appliances that receive their information via the courts or building's network. The infrastructure needed to support electronic signage is a network drop and power for the signage player and display. Depending on the size of the display, blocking may be required in the wall to support the display and mounts.

There are four main approaches to electronic signage:

Electronic Directories and Wayfinding

The function of the electronic directories and wayfinding is to provide visitors to the building a departmental, staff, or event directory as well as assistance in locating their desired destination within the building. In addition, they may also display supplemental emergency, weather, or other notifications. The electronic signage system should be treated as supplemental to any emergency, mass notification, or visual paging system and not be relied upon as the primary life-safety or emergency visual notification system. Electronic directories are typically located in the courthouse lobby and on each floor near the primary vertical transportation (elevators, grand stair, etc.).

Electronic Docket Directory

Like the electronic building directory, an electronic docket display system displays the daily docket information and provides the location of the courtrooms, hearing rooms and other spaces used for court proceedings. Docket display systems are typically integrated with the court units' calendar and scheduling software and are configured to update automatically as changes are made to the calendar systems. In addition, docket displays are typically located in court lobbies or public waiting areas. In larger courthouses, supplementary docket displays may be located on courtroom floors.

Electronic Schedule Displays

Electronic room schedule displays are essentially electronic clipboards. Located outside courtrooms, multi-use conference spaces, and conference rooms, these display the daily docket or meeting schedule for the local room. They are typically fed from the court calendar system, or in the case of conference rooms, a room reservation system or shared calendar system like Microsoft Outlook.

Interactive Kiosks

Interactive schedule, docket, or wayfinding kiosks allow guests to the building to search for specific information. Kiosks are not always intuitive and can create bottlenecks when large numbers of visitors are looking for information at the same time. Dedicated directory and docket displays that rotate automatically through the building directory or the day's docket tend to be more efficient than interactive displays or kiosks.



ACOUSTICS

This chapter discusses acoustic design concepts and outlines specific acoustic criteria for courthouses. Criteria in this chapter focus on the court-occupied spaces. Where detailed criteria are not provided for non-courts program areas, the requirements set forth in *Facilities Standards for Public Buildings Service* (GSA PBS P-100) or the applicable occupant group design guidelines shall govern.

Chapter Topics:

- Introduction
- Supporting Documents
- Design Requirements
- Renovations and Alterations (R&A)

Chapter Figures and Tables:

Table 14.1	Room Partitioning Requirements
Table 14.2	Acoustic Performance Requirements

Introduction

The two key factors that determine the acoustic performance of spaces in a courthouse are speech intelligibility and acoustic privacy. Speech intelligibility is a measure of the ability of a listener to understand what is being said. A high standard of speech intelligibility is critical to ensure that all questions, testimony, and discussion can be clearly understood by all the participants and observers of the event. Speech privacy is a measure of speech audibility between adjacent spaces and is a function of the acoustic separation provided by the separating partition(s) and of the background noise levels in the two spaces. The acoustic performance requirements of a room are met through careful design involving acoustical engineering done to achieve specific field performance per testing standards.

Speech Intelligibility

For unamplified speech, the two key parameters that determine the level of speech intelligibility are the level of background noise and room reverberance. For amplified speech, the third key parameter that needs to be taken into account is the performance of the sound-reinforcement system.

Installation of a sound-reinforcement system can help increase the level of speech intelligibility; however, poor room acoustic design cannot be compensated for with good sound system design. Both should be considered together from the outset.

Background noise is a product of several sources. The dominant component is typically noise associated with the heating or cooling system. This may include fan noise and regenerated flow noise associated with dampers, diffusers, and other mechanical system elements. Another component is noise ingress, either from external sources such as road traffic or from internal sources such as the activity of people in adjacent spaces. Noise criteria describe the desired level of background noise.

Achieving a high level of speech intelligibility requires that the signal-to-noise ratio, that is, the speech level over the background noise level, be optimized. This should be achieved by controlling the background noise level within the courtroom and optimizing the speech level through the room's acoustic design and the design of the sound-reinforcement system.

Room reverberance is generally defined by the reverberation time, which is the time it takes for sound to decay within a room, expressed in seconds. Too much reverberance will result in late sound reflections (echoes), which will compromise speech intelligibility. Reverberation time is directly proportional to the volume of the room and inversely proportional to the amount of sound absorption within the room. Therefore, the reverberation time can be reduced by reducing the room volume and/or increasing the amount of sound absorption.

Acoustic Privacy

For any given courthouse space, it is important that speech from the activity within not be audible in adjacent spaces, and vice versa. Special attention should be paid at the earliest stages of planning to ensure that noise-producing spaces (building-systems equipment rooms, restrooms, circulation space, public lobbies, etc.) are not located directly adjacent (vertically or horizontally) to noise-sensitive spaces.

Internal partitions should be of a construction determined to achieve an appropriate level of airborne sound isolation, as measured per the ASTM E-90-99 standard. Buffer spaces and vestibules should be included where appropriate. Impact isolation, to control footfall noise from adjacent spaces, should also be considered.

Noise-sensitive spaces should be protected from external noise ingress, such as road traffic noise, airplanes passing overhead, and pedestrian activity. All facade elements (walls, glazing, roofs, etc.) should be designed to provide appropriate sound isolation.

Another fundamental consideration when the building is located above or close to significant sources of vibration, specifically subways, below-grade or tunnel roads or railways, at-grade railways, trams, and metro systems, is the need to take into account groundborne noise and vibration in the building. In these areas, vibration isolation may be required to isolate the building structure from the vibration source. Advice should be sought at the earliest available opportunity.

Supporting Documents

A comprehensive guide to supporting documents can be found in [Chapter 2, “Courthouse Programming and Budgetary Considerations.”](#) That listing includes program and design criteria, courthouse planning and related guidelines, policies, and information on many facets of the design and construction of federal courthouses. The references listed below relate specifically to this chapter.

- *American Society of Heating, Refrigerating, and Air-Conditioning Engineers (ASHRAE) Handbook of Fundamentals*
- *Sound Matters: How to Achieve Acoustic Comfort in the Contemporary Office produced by GSA Public Building Service (2011)*

Design Requirements

This section of the *Design Guide* presents a definition of the acoustic criteria applicable to courthouse buildings as well as design guidance to ensure that the necessary criteria are met.

The design team should seek the advice of an acoustic consultant to ensure that the design recommendations are successfully implemented. It should be noted that minor changes in room shape, form, and finishes can have a significant effect on the room acoustics. The same is true for variations in the building systems, equipment, facade, and other construction design. Therefore, it should not be assumed, regardless of the prior experience of the design team, that targets can be met based on previous projects if changes are considered in subsequent designs.

The following sections include components that are both performance goals and prescriptive design items. Where specific numeric acoustical goals are established, the acoustical consultant should provide documentation illustrating how the goals have been achieved including calculations where applicable.

Speech Intelligibility

Speech intelligibility is commonly measured using the Speech Transmission Index (STI). The STI uses a rating system from 0 to 1 to subjectively rate intelligibility, broken down as follows:

- < 0.40 = Poor
- 0.41–0.50 = Fair
- 0.51–0.60 = Good
- 0.61–0.75 = Very good
- 0.76–1.0 = Excellent

The design target for all critical spaces is to achieve an STI rating of > 0.6 for both unamplified and amplified speech. In spaces without a sound reinforcement system, control of background noise and reverberation time is, as outlined in the following sections, expected to provide an STI rating of fair to good. A sound-reinforcement system should be used to achieve an STI rating of very good to excellent. The STI should be measured when the audio system is completely installed, in accordance with the method laid out in IEC 60268-16 or ANSI S3.2-1995.

Room Reverberation Times

Critical spaces should be designed to achieve the reverberation times provided in [Table 14.2](#).

It should be noted that guidance elsewhere in this document regarding courtroom dimensions will result in a room reverberation time that, in the absence of sound-absorbing treatment, will exceed the targets indicated. Therefore, specific guidance should be followed to ensure that room reverberance is appropriately controlled. The relevant guidance is provided in [Table 14.2](#). In all cases, the introduction of sound-absorbing finishes should be an essential component of the room design.

Room Background Noise Levels

Room background noise levels are comprised of the noise from building systems (heating, ventilation, and air conditioning (HVAC), electrical, lighting, audiovisual systems, etc.) and noise ingress from external sources (road, rail, and air traffic; pedestrian activity; etc.) and internal sources (such as the activity of people or the operation of equipment in adjacent spaces). All sources of noise should be controlled to appropriate levels.

Acceptable levels of noise from building services systems depend on the sensitivity of the room function. In addition, constant noise such as that from HVAC systems also masks the ingress of external noise or activity noise in other areas of the building.

In accordance with the ASHRAE *Handbook of Fundamentals*, all spaces should be rated using the room criterion (RC) or noise criterion (NC) curves, that is, background noise. NC should be used for theoretical designs and RC should be used for field measurement.

If variable HVAC systems are used, the implications for the building design approach should be examined. This will also have ramifications for the design of the building facade (if used to control noise ingress from external sources) and internal room-to-room space privacy.

To maintain constant RC/NC background noise levels, it may be necessary to introduce a sound-masking system using distributed loudspeakers. The spectral shape of the sound-masking system should be carefully designed and specified such that it does not exceed the target criteria provided in [Table 14.2](#) and does not contain any tonal elements.

The increasing use of videoconferencing technology in the courtroom means that low-frequency noise needs to be adequately controlled to ensure that suitable levels of sound quality can be achieved in reproduction and recording.

External Noise Ingress

Noise from external sources may consist of road, rail, air, or pedestrian traffic or noise from the external mechanical equipment of the building or surrounding buildings. In all cases, the noise from these sources should be limited in order not to disturb court functioning.

In order to limit external noise ingress, an assessment should be made of future noise levels on the site. Step one will require that a site noise survey be conducted. An acoustic consultant should measure and record external noise at appropriate intervals during the operating hours of the court and document these as a baseline.

In the case of a new courthouse, any known future conditions, such as new or rerouted roads, new railways, airport flight paths, etc., should be reviewed and the noise impact determined. Future land use of surrounding areas may also contribute to external noise and should be reviewed with the local planning commission.

The acoustic consultant will then use this information to provide design guidance and improve the sound isolation performance of the proposed building facade using the Outdoor-Indoor Sound Transmission Class (OITC) criteria.

Internal Airborne Sound Insulation

In order to achieve the required privacy between spaces, it is important to ensure that all internal partitions, walls, floors, and ceilings, as well as doors and windows, achieve an adequate level of sound insulation.

The guidelines presented here are expressed in terms of the Noise Isolation Class (NIC), a single-number rating describing the combined performance of all building elements in isolating one room from another. The higher the NIC rating, the better the privacy between spaces. NIC is used in this guide to allow for design using both full-height and partial-height partitions as it takes into account all the isolation elements. To achieve the NIC goals in design phases, Sound Transmission Class (STC) may be used. STC for spaces' bounding partition should be at least 5 points higher than the NIC rating for the spaces. For example, spaces with an NIC goal of 55 should use STC 60 partitions. STC applies only to design of full-height partitions.

The in-field sound-level difference between adjacent spaces should be measured in accordance with ASTM E336-05 *Standard Test Method for Measurement of Airborne Sound Insulation in Buildings*, and the NIC value should be determined in accordance with ASTM E413-04 *Classification for Rating Sound Insulation*.

The level of privacy also depends on the background noise levels in the spaces. For example, a room in which the partitions have a rating of NIC 50 and a background noise level of RC/NC 35 will have the same level of privacy as a room in which the partitions have a rating of NIC 45 and a background noise level of RC/NC 40.

The required sound insulation performance (NIC) should be defined by the background noise criteria (RC/NC) and the required level of privacy, as shown in [Table 14.1](#). The levels circled in the table demonstrate a required privacy level of confidential.

Table 14.1
Room Partitioning Requirements

Privacy Levels		Background Noise (RC/NC)			
		25	30	35	40
Confidential	Noise Isolation Class (NIC)	60	55	50	45
Normal		50	45	40	35
Minimal		4	35	30	25

It is the responsibility of the architect and acoustic consultant to minimize the use of heavy internal partition construction and full-height (slab-to-slab) partitions with the exception of areas where it is a requirement. Where full-height walls are not required, the acoustical consultant may recommend the use of partial height walls that extend to a minimum of 6-inches above the ceiling used in conjunction with a properly designed ceiling with a high Ceiling Attenuation Class (CAC) and potentially sound masking. Attention should be paid to the use of acoustically neutral spaces as buffer zones between sensitive areas. Buffer zones and neutral spaces are generally defined as non-acoustically sensitive spaces that are located in between two acoustically sensitive spaces. Buffer zones and neutral spaces can be created through space planning and are not intended as a requirement of additional programmatic space. Where buffer zones or neutral spaces are used, the design team can use discretion in reducing the performance of partitions while ensuring that the subjective intent of the privacy standard is achieved. For example, a storage closet can also act as a buffer space when located between two conference rooms. The walls partitions at the storage closet could each be a slightly lower NIC so that the combined total performance of both walls meets the NIC goal. [Table 14.2](#) includes the NIC goals for specific spaces. These NIC goals apply to the wall assembly.

Doors and windows in sound-rated walls will decrease the sound isolation performance of that wall. The acoustical consultant should review the adjacencies and provide recommendations for sound-rated door assemblies, door sound seals, and window glazing assemblies. The design team should work to limit the number of sound-rated doors and glazing assemblies to limit cost. Doors located in walls of NIC 35 or below, and doors at sound locks should include a standard solid core door with a compression sound seal package. Glazing in walls of NIC 35 or less should be 1-inch insulated glass. Doors and glazing in walls over NIC 35 should be determined by the acoustical consultant based on the specific project. The door frame on sound-rated doors should be steel and should be filled with insulation or grout as appropriate to limit sound leaks. Frames provided by a sound-rated door manufacturer should be selected by the manufacturer to maintain the door performance. Frames may be covered with wood to achieve aesthetic goals.

It is recommended that trial jury and grand jury hearing rooms be located with buffer spaces and corridors adjacent and not be located adjacent to other spaces requiring confidential privacy. Furthermore, localized sound masking systems are recommended for the areas adjacent to the trial jury and grand jury hearing rooms to further increase speech privacy.

Demountable partitions may be used at the discretion of the design team. A header should be built from the top of the partition to the deck to maintain acoustic isolation where walls are required to extend to the deck. The header's isolation performance should match that of the demountable partition. Where walls are not required to extend to the deck, provide sound isolation design similar to partial height walls by using a high CAC ceiling design.

Impact Sound Isolation

The Impact Isolation Class (IIC) identifies the requirement for control of impact noise (footfall, etc.) from adjacent spaces (horizontal or vertical). IIC values for the floor-ceiling assembly above key critical spaces (courtrooms, conference rooms, study areas, jury deliberation rooms, and attorney/witness rooms) should be a minimum of 50.

IIC 50 can be achieved by using carpet as the floor finish or by using a resilient interlayer within the floor construction. Resilient interlayer materials are available from multiple manufacturers. The acoustical consultant should review the manufacturer provided independent lab test data illustrating that the IIC performance of the product achieves the IIC 50 minimum goals when tested in accordance with ASTM E492 and ASTM E989. Product(s) should be tested using the same or similar floor/ceiling construction as that of the project. The acoustical consultant should make recommendations for the specific model and thickness of interlayer required based on the floor/ceiling construction.

Raised Access Floor Systems

The design team should balance the utilization of raised access flooring against sound isolation performance very early in the design process. At the outset, building planning should try to separate sensitive spaces from each other by the use of acoustically neutral spaces (storerooms, risers, shafts, etc.).

Methods for improving the sound isolation of partitions at the head and base (e.g., pan-type floor tiles filled with lightweight concrete, packing with dense compressed mineral fiber, duct lagging or similar, use of cross-talk attenuators or similar) can also be considered. The use of access floors does not absolve the design team from achieving the required sound isolation performance, but places the onus on the design team to consider these requirements from the earliest design stages.

Vibration

Vibration limits for key sensitive areas are specified in accordance with ANSI S3.29-1983 *Guide to the Evaluation of Human Exposure to Vibration in Buildings*. Limits should be set on the basis of multiples of the relevant base curve. Appropriate multiples are as follows:

- Courtrooms: 1.4
- Other areas: 4.0

Courtrooms

The primary requirement is for high intelligibility and natural-sounding speech in the courtroom. To ensure that this is achieved, the courtroom should have the following characteristics:

- Controlled background noise from building services systems and audiovisual and other building equipment
- Appropriate room shape, form, and volume to ensure a suitable sound-reflection sequence and natural control of reverberance
- Appropriate control of room reverberance through the use of acoustic treatments
- Suitable sound isolation from all adjacent spaces

Background Noise Control

Specific NIC and NC/RC targets are provided in [Table 14.2](#). The design team should ensure that these limits are not exceeded through the use of any equipment or system within the space.

Room Shaping and Materials

Room shape and form have a fundamental effect on room acoustics and should be considered from the outset. General recommendations are as follows:

- The courtroom should not be a long or narrow rectangle finished totally with sound-reflective materials. Such conditions can cause excessive acoustic fluttering. Reducing the room length, avoiding the use of long parallel walls, and using appropriately selected absorptive finish materials can alleviate the problems.
- At the front of the room, from the judge's bench to just behind the location of the attorney teams, walls should be rectilinear and parallel to promote good distribution of lateral sound energy in the entire well area between the judge, jury, defendant, and attorney teams. Surface treatments should promote sound reflection. Some sound diffusion (through the use of surface texture or convex curvature) may be acceptable, as determined by a case-by-case evaluation. Concave curvature should be avoided in this area as it can often lead to sound-focusing issues.

Table 14.2
Acoustic Performance Requirements¹

Spaces	Privacy Level	Reverberation Time (RT) in seconds	Background Noise (RC/NC) curve	Noise Isolations Class (NIC) in decibels ⁴	Speech Intelligibility Index (STI) With sound system enhancement
Courtroom					
Courtroom	Confidential	0.6-0.7	25-30	55-60	0.75 (Very Good) ³
Judges' Chambers Suite					
Judge's Chambers Private Office	Confidential	0.4-0.6	35	50	NA
Law Clerks' Offices	Normal	0.5-0.6	35	40	NA
Judge's Chambers Conference/Reference Room	Confidential	0.5-0.6	35	50	0.75 (Very Good) ³
Courtroom Associated Spaces					
Circuit Judge's Robing Room	Normal	0.5-0.6	35	40	0.75 (Very Good) ³
District, Magistrate, and Bankruptcy Judge's Conference/Robing Room	Normal	0.5-0.6	35	40	0.75 (very Good) ³
Attorney Work Room	Normal	0.5-0.6	35	40	0.75 (Very Good) ³
District, Magistrate, and Bankruptcy Attorney/Witness Room	Confidential	0.5-0.7	30	55	0.75 (Very Good) ³
Public Waiting Areas	Normal	0.5-0.6	40	25	0.75 (very Good) ³
Jury Facilities					
Jury Assembly Suite	Normal	0.6-0.8	40	35	0.75 (Very Good) ³
Trial Jury Suite	Confidential ²	0.4-0.6	30	55	0.75 (Very Good) ³
Grand Jury Hearing Room	Confidential	0.4-0.6	30	55	0.75 (Very Good) ³

Table 14.2Acoustic Performance Requirements¹ (cont'd)

Spaces	Privacy Level	Reverberation Time (RT) in seconds	Background Noise (RC/NC) curve	Noise Isolations Class (NIC) in decibels ⁴	Speech Intelligibility Index (STI) With sound system enhancement
Other Court Units					
Library Lobby	Minimal	0.6-1.0	40	45	N/A
Library Study Room	Normal	0.4-0.6	30	55	N/A
Probation and Pretrial Services Private Interview Rooms	Confidential	0.5-0.7	30	55	N/A
Probation and Pretrial Services Private Offices	Normal	0.5-0.6	30	35	N/A
Federal Public Defender's Trial Preparation Suite	Confidential	0.5-0.7	30	55	N/A
Office of the Bankruptcy Administrator	Confidential	0.5-0.7	30	55	N/A
Office of the Pre-Argument Conference Attorney	Confidential	0.5-0.7	30	55	N/A
Shared Support Spaces					
Shared Judges Conference Room	Confidential	0.5-0.7	30	55	0.75 (Very Good) ³
Judges' Dining Area	Confidential	0.5-0.7	30	55	N/A
Conference Rooms	Confidential	0.5-0.6	30	55	0.75 (Very Good) ³

¹ All other courthouse spaces not listed reference [GSA PBS P-100](#).

² Trial jury suite and grand jury hearing rooms should include localized sound masking in the adjacent public space for further increased speech privacy. Do not locate these spaces adjacent to other confidential spaces or spaces with a RC/NC goal below 40.

³ Sound enhancement systems should provide a minimum STI of 0.75 (very good).

⁴ Refer to Internal Airborne Sound Insulation section for discussion of NIC and STC. Refer to specific room sections for additional information regarding use of full-height walls.

- It is recommended that the ceiling at the front of the room be flat and sound reflecting to maximize speech intelligibility in the well. Significant down stands, coffers, or similar elements should generally be avoided as they will reduce the effective sound-reflecting treatment area.
- At the rear of the room (between the rear of the attorney area and the main public entrance to the courtroom), room shaping may vary, being rectilinear or curved, either convex or concave. This wall area should be the primary location for sound-absorbing treatment. It should be noted that the extent to which treatment is required will depend on the shape of the walls as well as on the volume of the room. A concave curvature is likely to require the most significant area of sound-absorbing treatment, to control not only reverberance but also sound focusing.
- The ceiling at the rear of the room may require some limited area of sound-absorbing treatment to prevent late reflected sounds returning to the front of the room. This should be determined on a case-by-case basis.
- In all cases, carpet or carpet tiles should be used for the floor finish.

Sound Isolation

Soundlock lobbies or vestibules should be provided at all entrances to the courtroom. This provides an acoustic buffer zone between the courtroom and other public or nonpublic circulation spaces. Sound isolation from external noise sources, where the courtroom adjoins an external facade, should achieve the requirements of [Table 14.2](#). Internal sound isolation should be achieved by meeting the NIC performance requirements. Walls around the courtroom should be full-height. Space planning should avoid locating any noise-producing spaces (mechanical-systems rooms, toilets, public circulation areas, etc.) directly adjacent to a courtroom. All penetrations in walls to these areas should be appropriately sealed to maintain acoustic criteria set forth in this chapter.

Speech Privacy

In order to allow sidebar conversations at the judge’s bench to occur in privacy, the jury box should be located a minimum of 20 feet (6096 mm) away from the judge’s location. This will still require such conversations to be held in low voices.

To ensure speech privacy during sidebar conversations, sound masking for the jury box and audience gallery should be provided as part of the courtroom audio system. See the Administrative Office of the U.S. Court’s (AOUSC) *Technology Design Guide* for additional requirements.

Loudspeaker Type, Location, and Orientation

To maximize speech intelligibility in the room, it is important to carefully consider the type, location, orientation, and distribution of loudspeakers. The acoustic consultant should coordinate with the audiovisual consultant to assist in determining the optimal locations and types of speakers. Refer to the [Courts Technology Audiovisual Infrastructure Standard](#).

Courtroom Associated Spaces

Attorney Work Room

The primary requirement is for quiet and private working areas. Appropriate control of mechanical-systems background noise, sound isolation from adjacent spaces, and acoustic control are the key issues. Specific requirements are provided in [Table 14.2](#).

The attorney work room should be acoustically and visually separate from other areas of the building. However, the standard of sound insulation is reduced in comparison to the judges’ suites, such that a “good” standard of sound insulation is adequate.

The required reverberation time determines the degree to which acoustically absorptive finishes should be used in the attorney work room. Refer to [Table 14.2](#) for specific reverberation times.

District, Bankruptcy, and Magistrate Judge’s Attorney/Witness Room

The primary requirement is for quiet and private working areas with appropriate sound insulation from the courtroom. Appropriate control of mechanical-systems background noise, sound isolation from adjacent spaces, and acoustic control are the key issues.

Privacy is of paramount importance. All walls to these areas should achieve a high degree of sound insulation. They need not be slab-to-slab if the construction meets the required performance set out in [Table 14.2](#) and an appropriate sound-isolating ceiling is provided. Doors should be appropriately acoustically rated, with all necessary sound-isolating seals and hardware.

Internal sound isolation should be achieved by meeting the performance requirements outlined in [Table 14.2](#). All penetrations in walls to these areas should be appropriately sealed to maintain acoustic criteria set forth in this chapter. Recessed light fittings should be avoided, but where they are included they should be appropriately boxed in.

To ensure complete privacy of conversations, ducted systems should be provided with cross-talk attenuators at each wall penetration.

The required reverberation time determines the degree to which acoustically absorptive finishes should be used in the room. Refer to [Table 14.2](#) for specific reverberation times.

Public Waiting Areas

Public waiting areas should be separated acoustically from adjoining enclosed spaces. The same acoustic standards should be applied to public waiting areas as to attorney witness rooms.

Judges' Chambers Suites

The primary requirement in judges' chambers suites is for quiet and private working areas. Appropriate control of mechanical-systems background noise, sound isolation from adjacent spaces, and acoustic control are the key issues. Specific requirements are provided in [Table 14.2](#).

Privacy in the suites is of paramount importance. All walls to the judges' suites, private offices, and the judicial reference/conference room should be slab-to-slab construction. Sound isolation from external noise sources, where the courtroom adjoins an external facade, should achieve the requirements of [Table 14.2](#). Internal sound isolation should be achieved by meeting the performance requirements in [Table 14.2](#).

Room acoustics in the suites should meet the requirements of [Table 14.2](#). Proper room acoustics and background noise control is required to support the increased use of video-conferencing in judicial conference rooms.

Space planning should avoid locating any noise-producing spaces (mechanical-systems rooms, toilets, public circulation areas, etc.) directly adjacent to a chambers suite. All penetrations in walls to these areas should be appropriately sealed in accordance with the requirements of [Table 14.1](#).

All equipment serving these areas should incorporate appropriate noise- and vibration-control mountings to a distance of 10 feet (3 meters) from the perimeter of the suites to ensure complete privacy within.

To ensure complete privacy of conversations, ducted systems should be provided with cross-talk attenuators at each wall penetration.

Refer to [Table 14.2](#) for additional detail on acoustics for judges' chambers suites.

Plumbing runs should be isolated from judges' chambers and conference/reference rooms using resilient isolation clips and/or supports to limit transfer of flow and flush noise into the adjacent walls and floor/ceiling elements. Plumbing pipe penetrations of the perimeter walls or ceiling should be resilient to prevent the pipes from direct contact with studs, drywall, or other wall elements. Resilient penetrations should be coordinated with the acoustical consultant and plumbing engineer. Pipe penetrations should also be sealed air-tight with acoustical or fire caulk to limit the potential for sound transfer through penetrations. Wherever possible, locate plumbing chases and risers on walls that are not common to the judges' chambers or conference/reference room perimeter walls.

Jury Facilities

Trial Jury Assembly Suite

Proper acoustics are important in the jury assembly suite because potential jurors receive instructions regarding their obligations. To enhance acoustics in the jury assembly area, a sound system should be provided. The system should be designed so that the loudspeakers distribute the majority of energy into the direct sound field, with minimum distribution into the reverberant field. This can be accomplished by providing a highly sound-absorbent environment, with a maximum reverberation time of 0.8 seconds. The acoustic privacy requirement for the jury assembly area is "normal."

Trial Jury Suite

Trial jury suites should be acoustically enclosed. Trial jury suites adjoining other functional spaces should have sound-rated common walls. The acoustic privacy requirement is "confidential" for the entire jury suite. To ensure privacy of speech within the trial jury suite, the soundlock entry doors should be fully gasketed and sound masking included inside the soundlock and adjacent public spaces.

To ensure speech intelligibility, include acoustical finishes to meet the reverberation time and background noise goals outlined in [Table 14.2](#).

Grand Jury Hearing Room

The acoustic privacy requirement for the hearing room in the grand jury suite is "confidential."

Central Libraries

The entire library should be acoustically isolated from other court functions, including noise-generating functions within the library or adjacent spaces such as copier rooms or restrooms.

Probation and Pretrial Services Offices

All interview rooms should be acoustically separate from adjacent areas (acoustic privacy requirement: "confidential"), with 55-decibel (dB) NIC partitions, gasketed doors, and background noise levels of 30 RC/NC. Special consideration should be given to the design and fabrication of ducts to minimize acoustic problems. Refer to [GSA PBS P-100](#).

Other Court Units

Office of the Pre-Argument/Conference Attorney

Both executive offices and conference rooms should provide acoustic confidentiality.

Office of the Bankruptcy Administrator

The executive office and conference rooms for the Office of the Bankruptcy Administrator should be designed for acoustic confidentiality.

Room acoustics in the conference rooms should meet the requirements of [Table 14.2](#) to support the increased use of video-conferencing in judicial conference rooms.

Trial Preparation Suite for the Federal Public Defender

The trial preparation suite for the federal public defender's office should be designed to provide acoustic confidentiality.

Open Office Areas

Refer to GSA's *Sound Matters*.

Design Requirements for All Other Court Spaces

Refer to [GSA PBS P-100](#) and GSA's *Sound Matters*.

Fitness Areas

Fitness areas can create both airborne and structure-borne noise from the use of equipment and the dropping of weights. The impact from weights and treadmills can affect occupants in spaces below the fitness area and adjacent to the fitness area on the same floor. Typical industry standard fitness impact isolation techniques include footed acoustical tile flooring and floated concrete floors on acoustical isolation pads or springs. These techniques are effective at limiting the impact noise and vibration, but depending on the amount of weight dropped will not eliminate all the impacts. Isolation pads could be used under treadmills, ellipticals, stationary bikes, or other cardio equipment to limit impact noise, however such materials cannot be used under weight machines. Therefore, fitness areas are recommended to be located on the ground floor or in the basement. When unable to do so, the acoustical consultant should assist in the design to provide recommendations for isolation.

The fitness space should not be located next to any "confidential" spaces or office areas that require focused work.

The walls of the fitness area should be designed to achieve NIC 50. Include acoustically absorptive material over the entire ceiling to limit reverberation.

Renovations and Alterations (R&A)

Renovations and alterations to courts facilities should follow the guidelines in this chapter to achieve the levels outlined whenever possible. The various challenges for each R&A project will vary greatly based on the space, building, goals, budget, historic status, and access. An acoustical consultant should be included as part of the design team to provide direction and guidance in determining specific acoustic goals for the R&A product if goals outlined herein are not deemed practical by the consultant.

It is highly recommended that an initial study be conducted to review the potential impacts to existing and surrounding spaces. A seemingly unrelated building system or technology update could potentially impact the existing acoustical performance.

The following are items to consider with the assistance of the acoustical consultant:

Sound Insulation

- Consider if a renovation will penetrate an existing sound-rated wall and take steps to acoustically seal the penetration(s) to maintain the wall isolation.
- Consider the location of new spaces within existing buildings so that speech privacy and confidentiality may be maintained while limiting heavy construction.
- Repair, replace, or add sound seals to the existing doors where doors cannot be replaced, or sound locks added.
- Seal glazing assemblies and consider laminated and/or insulated glazing. Include a new pane of glazing over an existing pane to increase sound insulation.

Background Noise

- Choose low sound options for new building equipment system elements.
- Do not place new items over or adjacent to sensitive spaces such as courtrooms, judge's suites, trial jury rooms, grand jury hearing rooms, and conference rooms.
- Include vibration isolation on new equipment in accordance with this guide and *ASHRAE Applications Handbook*.

Reverberation Time

- Select acoustical finishes to match historic needs.
- Consider if more costly finishes, such as acoustical plaster, will be needed to control reverberation while meeting historic requirements.



BUILDING SYSTEMS

This chapter contains requirements for courthouse mechanical, electrical, lighting, communications, and raised access flooring systems. This chapter is intended to highlight specific system requirements within court-occupied spaces that are not addressed by *Facilities Standards for the Public Buildings Service* (GSA PBS P-100) or other applicable codes and standards.

Chapter Topics:

- Supporting Documents
- Mechanical Systems
- Electrical Distribution Systems
- Lighting Systems
- Communications Systems
- Renovations and Alterations (R&A)

Chapter Figures and Tables:

Table 15.1	Electrical Requirements in Courtrooms
Table 15.2	Lighting Requirements

Supporting Documents

A comprehensive guide to supporting documents can be found in [Chapter 2, “Courthouse Programming and Budgetary Considerations.”](#) That listing includes program and design criteria, courthouse planning and related guidelines, policies, and information on many facets of the design and construction of federal courthouses. The references listed below relate specifically to this chapter.

Infrastructure requirements are critical to the success of courthouse low-voltage systems (e.g., audiovisual and data and telephone communications systems). Infrastructure requirements are defined in the [Courthouse Technology Audiovisual Infrastructure Manual](#) as well as in Telecommunications Industrial Association (TIA) publications and Electrical Industry Alliance (EIA) publications.

The following supporting documents provide the design team with the details to organize and guide the design and installation process of the courthouse low-voltage systems from design development to system inspection.

- [Courthouse Technology Audiovisual Infrastructure Standard](#), most current edition
- [AV/IT Infrastructure Guidelines for Courts](#), AVIXA publication
- [GSA PBS P-100](#), Chapters 5, 6, 7, 8, and 9
- [GSA Design Guide for Operational Excellence](#), most current edition.
- [Illuminating Engineering Society of North America \(IESNA\) Lighting Handbook](#), Chapter 10, “Lighting Design Guide”, most current edition
- [Requirements and Specifications for Special Purpose and Support Space Manual](#) (USMS Publication 64), *Volume One, Courthouse Management Group Engineering and Architectural*, most current edition
- [Requirements and Specifications for Special Purpose and Support Space Manual](#) (USMS Publication 64), *Volume Two, Electronic Security and Hardware*, most current edition
- [Requirements and Specifications for Special Purpose and Support Space Manual](#) (USMS Publication 64), *Volume Three, Judicial Security Systems Requirements and Specifications*, most current edition
- [American National Standards Institute \(ANSI\)/American Society of Heating, Refrigerating, and Air-Conditioning Engineers \(ASHRAE\) Standard 62.1, Ventilation for Acceptable Indoor Air Quality](#), most current edition adopted by GSA PBS P-100.
- [ASHRAE Standard 90.1, Energy Standard for Buildings](#), most current edition adopted by GSA PBS P-100
- [Advanced Energy Design Guide for Small to Medium Office Buildings](#)

Telecommunications Cabling Standards

- [ANSI/TIA-568 Series of Telecommunications Standards](#), most current edition
- [Building Industry Consulting Service International \(BICSI\) Telecommunications Distribution Methods Manual \(TDMM\)](#), most current edition

Telecommunications Infrastructure Standards

- [ANSI/TIA-569, Commercial Building Standards for Telecommunications Pathways](#), most current edition

Governing Codes and Criteria

The General Services Administration (GSA) has established [GSA PBS P-100](#) as the basis of design criteria for building systems in federal buildings, including new courthouses. The U.S. Marshals Service (USMS) has also developed courthouse building systems criteria pertaining to prisoner holding areas and its own tenant space within the courthouse. Building codes are also used to establish baseline design criteria in U.S. court facilities. Refer to [GSA PBS P-100](#) for a comprehensive discussion of applicable codes and industry quality standards for various building systems.

Design, Procurement, and Construction Responsibilities

GSA, as the developer and lessee of buildings that house the U.S. courts, has primary responsibility to design, procure, construct, test, start up, and maintain building systems for courthouses. [Chapter 2, “Courthouse Programming and Budgetary Considerations,”](#) provides a summary of the funding responsibilities of the Judiciary, GSA, and other executive-branch agencies.

Primary building systems, such as mechanical, plumbing, electrical, emergency/standby power, and lighting services, are provided by GSA as core and shell improvements. Courthouse low-voltage systems for data, telecommunications, audiovisual, and other court technologies are designed, procured, installed, and tested by consultants engaged by GSA and funded by the Judiciary under a reimbursable work authorization or other funding. GSA, as the developer of court-occupied spaces, provides the infrastructure to support these systems as core and shell improvements. Information provided here is intended to facilitate the design of the infrastructure for these systems. Electrical, mechanical, and telecommunications rooms should be accessible directly from public/building common circulation to the maximum extent possible.

There is an increased desire for the ability to use traditionally dedicated spaces, such as courtrooms and grand jury rooms, for training and civic functions, for example, bar association meetings, law school events, or other non-traditional uses. To support these training activities and civic functions, the design team needs to consider and address potential additional audiovisual (AV) requirements for the court managed spaces. Feasibility and funding of systems to support multi-use of the spaces should be verified

prior to the design of special AV systems. Refer to the [Courtroom Technology Audiovisual Infrastructure Manual](#) for infrastructure and system requirements.

Mechanical Systems

General Design Concerns

When selecting mechanical systems and equipment for courthouses, the following factors should be considered:

- Workplace performance
- Reliability
- Maintainability
- Initial costs
- Operating costs
- Sustainability
- Acoustics

The selection of central plant equipment has a major impact on all factors, particularly initial cost and operating cost, predominately in the cooling cycle.

The number of air-handling units (AHUs) directly influences the flexibility of the building's heating, ventilating, and air-conditioning (HVAC) system, but it is also the greatest cost consideration. The zoning of air-handling systems should be in direct proportion to the occupancy of the spaces. The system design should meet the occupancy requirements during standard hours of operation and provide a means of conditioning occupied spaces used during off-hours without conditioning unoccupied adjoining spaces. Proper zoning of building air-handling systems is important for efficient and reliable operation. AHUs should be limited in size to minimize the effect of mechanical failures and maintenance. Design of the boilers, chillers, heat exchangers, and pumping systems should consider how the system capacities and turndown relate to continuous service during repairs and maintenance. The design should address normal hours, after hours, pressurization requirements, along with normal and emergency repair and maintenance.

If there will be rapid, considerable changes in occupancy, the system design team should consider providing a standard HVAC system for average expected use and a supplementary booster AHU for higher occupancy loads. This simplifies control and saves energy. Air-distribution systems, with a capacity greater than 3,000 cubic feet per minute (CFM), should have an air-side or water-side economizer.

The design of the mechanical systems should be well integrated into the architecture and respect the aesthetics of the spaces. The design should also address security concerns by locating air intakes well above the ground level to minimize the possibility of introducing

hazardous or objectionable substances. Air intakes should be compliant with [GSA PBS P-100](#) requirements. All visible parts of the system should be consistent with the finishes of the area in which they are located. Close coordination with all disciplines, particularly with the architects, is essential.

The building's systems should be properly tested and balanced to ensure optimal performance. During balancing, conditions are often uncovered that can significantly impact overall performance, the quality of installation, and the accuracy of design limits. It may be advantageous for GSA to employ a contractor, independent of the construction and design team, to thoroughly test and balance all mechanical systems in accordance with national standards. All projects should incorporate a total building commissioning process as required in [GSA PBS P-100](#).

Off-Hours

Courtsrooms may be used during extended hours. However, judges' chambers are routinely in use during evenings and weekends. Library archival storage space, audiovisual rooms, and server rooms require 24-hour climate control. Other areas that routinely require off-hours operation are the trial jury suite, grand jury suite, clerks' offices, and probation offices. The design of the HVAC plant and distribution system should be capable of sufficient system(s) to address the reduced loads associated with off-hours operations. The design should consider how to best balance the after hours request for overtime utilities, minimizing the amount of equipment that should be enabled and its energy use.

For areas with high heat gain and 24-hour operation, such as file server rooms and the USMS command and control center, a supplemental cooling system should be provided for cooling while the main systems are shut down. The supplemental system may be chilled water, split direct expansion (DX) unit, or water-cooled heat pumps, rejecting heat to the building's chilled-water system or condenser water. For chilled-water cooling, a small air-cooled chiller may be provided.

For those cooling systems that require 24-hour/seven-days-a-week utility services from the owner (GSA), the project design team should identify the utilities that need to be sub-metered to track associated energy consumption for billing purposes. Such energy sub-meters or electrical meters should be discussed with the Judiciary's project manager to be considered in the design on a case by case basis. The Judiciary's project manager will provide feedback whether to install the meters depending on project budget and utility consumption contract agreement with GSA. For additional information, refer to the [GSA Pricing Desk Guide](#).

Humidity

Along with temperature, a space's humidity level impacts occupant comfort as well as mold and mildew growth. Humidity control is crucial in the care and preservation of

furnishings, finishes, books, computer equipment, and other court property. Additional care should be taken in areas where large groups of people assemble and in climates of extreme natural humidity. Humidity can easily be reduced or increased as needed through properly sized and placed humidification equipment. In humid climates, HVAC controls should be provided to maintain appropriate humidity in the building 24-hour/seven-days-a-week, to prevent damage to finishes and to mitigate the growth of mold. Humidification should be provided as specified in [GSA PBS P-100](#). Humidity sensors should be provided in courtrooms and similar areas to control HVAC systems and maintain required humidity levels. Humidifiers should be provided to control humidity levels in building areas having extensive custom millwork and artwork.

Air Distribution

The use of variable air volume (VAV) or variable air volume with reheat (VAVR) systems provides off-hours flexibility, individual room temperature control, humidity control, good indoor air quality, and acoustic advantages. Other systems such as variable refrigerant flow (VRF) units, induction units, and chilled beams should also be evaluated to provide maximum operational flexibility and control in the individual rooms.

Controls

All court and court-related offices should have HVAC controls, monitored from a central location. Direct digital controls (DDCs) should be provided to control the mechanical systems. The DDCs should be interconnected so that they can be monitored and controlled from a central location.

Acoustic Requirements

The design team should refer to [Chapter 14, “Acoustics,”](#) for performance requirements. The implications of the mechanical system’s design on acoustic performance should be considered from the outset.

To control noise during all modes of operation and for all loading conditions, the system should be provided with one or more of the following: sound traps; low-velocity, low-static-pressure fan systems; and/or special low-noise diffusers. An acoustic consultant should review the system to determine which techniques are necessary.

Where ducts penetrate acoustically rated walls, duct and wall systems should be designed to maintain acoustic integrity. All penetrations in partitions, walls, floors, or ceilings (suspended or structural) should be appropriately sealed to maintain the sound-insulation performance of the partition. Mechanical systems designers are to coordinate with the acoustical consultant so that the proper wall and floor/ceiling detail are employed to prevent noise and vibration transmission to floors and ceilings of mechanical rooms.

Background noise in all spaces should be rated in accordance with [Chapter 14](#) and calculated by the acoustical consultant per the criteria stated in the ASHRAE handbook¹. Appropriate noise control should be achieved during all modes of operation. For mechanical systems, this will require the use of one or more of the following:

- Primary attenuators for the AHUs
- Acoustic plenums
- Sound attenuators
- Low-velocity, low-static-pressure fan systems
- Low-noise diffusers
- Noise- and vibration-isolating hangers or mounts where required

Large noise-generating equipment should be located away from acoustically sensitive areas to control noise and vibration. All major rotating equipment should be mounted to spring isolators. Flexible connections should be provided to pumps, fans, chillers, cooling towers, compressors, and other vibrating equipment. There should be 50 feet minimum of linear duct between the discharge of the air handling unit to the first air device or terminal diffuser in the judges’ chambers or courtroom spaces. Ducts should be supported from the building structure to prevent vibration. All ductwork within the mechanical room and serving courtrooms should be supported with spring isolators. Air terminal devices should not be installed in courtrooms or judges’ chambers. Air handling unit cooling coils should be selected at or below 450 fpm (2.28 m/s). Reference [GSA PBS P-100](#) for further guidance.

The ductwork should be designed to control airborne equipment noise, duct breakout noise, airflow-generated noise, and duct-borne cross-talk noise. Do not use duct lining. Double wall ducts, acoustic duct wrap, and sound attenuators are among the techniques that could be included to minimize noise. Efficient low-loss duct fittings should be used, and airflow velocity should be minimized. The design team should consider increasing the wall thickness of large ducts above the minimum Sheet Metal and Air Conditioning Contractors National Association standards. All main supply, return, and exhaust ducts serving low noise criteria spaces such as judges’ chambers, courtrooms, etc., should be sized at an air velocity less than or equal to 800 fpm. All branch ducts in the low noise criteria spaces should be sized at air velocity of equal to or less than 400 fpm.

Where possible, toilet rooms should not be located above or adjacent to noise-sensitive spaces. In unavoidable situations, consideration should be given to low-noise water closets and urinals. Siphon jet and washout type flush valves should be considered for water closets and urinals respectively over blowout type flush valves. Tank-type water closets should be considered for judges’ chambers and other areas where the number of users is limited. Acoustic wrapping should be considered on supply pipes and drain lines connected

¹ ASHRAE *HVAC Applications Handbook*, most current edition.

to water closets and urinals. Pipe sizes, materials, noise absorbing features of hangers and appurtenances, and pipe layout should also be considered. Noise transmission should be attenuated in noise-sensitive areas such as courtrooms, jury deliberation rooms, attorney/conference rooms, and judges' chambers.

Plumbing

Consideration should be given to installing future provisions that aid in the flexibility of future layouts. Provide at least one wet stack, consisting of sanitary drainage, vent, and domestic water risers with capped connections above the finished ceiling of each floor, to serve every 10,000 square feet of floor area to minimize the disruption to the building for installation of future plumbing fixtures or equipment. Wet stacks should be located near columns so they can be easily concealed with a fur out to match the adjacent architecture.

One or more floor drains (with trap seal maintenance device) should be provided in all public and private restrooms throughout the building and the floor should be sloped to the drain.

Provide bottle filling stations with or in lieu of the required drinking fountains as permitted by the governing code.

Courtrooms

System Design

Courtroom HVAC systems should also serve the following areas:

- Judges' chambers suites (when located adjacent to courtrooms)
- Trial jury suite (when located adjacent to a courtroom)
- Attorney witness rooms

Each of these areas should be provided with individual temperature control. Humidity should be controlled at the main air-supply unit. The HVAC system serving the courtroom and associated areas should function economically after hours.

Air Distribution

Within the courtroom, three HVAC zones should be provided: one for the judge and attorney area in the front of the courtroom, a second for the jury area, and a third for the spectator area in the back of the courtroom. If the courtroom is served by a fan system dedicated to more than one courtroom, the return air from each courtroom and its associated areas should be ducted directly to the unit. Temperature controls within the courtroom should only be controlled by the judge or the clerk. Thermostats located at the spectator seating and jury box should be readable-type only. Background noise from HVAC should be limited per [Chapter 14, "Acoustics,"](#) to support audio recordings. Ductwork should be treated to meet acoustic design criteria.

The spectator area is served by a separate group of diffusers, which should be sized to serve the maximum allowable seating capacity, plus 25 percent personnel count to allow for extra seating. The diffusers should meet minimum ventilation requirements at no loads, with no appreciable increase in system noise during load changes.

Plumbing

Avoid plumbing fixtures and roof drains directly above the courtroom to minimize disruption of finishes in the event of a leak or future renovation.

Judges' Chambers Suites

System Design

The system serving the judge's chambers suite should be sized to include the reference/conference room, law clerk offices, secretarial space, and reception area.

In a collocated chambers plan, HVAC in the judge's chambers suite, if adjacent to a courtroom, should be fed from the same AHU as the associated courtroom to facilitate off-hours use (e.g., evenings and weekends).

Air Distribution

Air distribution systems in the chambers should provide a high degree of individual control and acoustic privacy. Return air from the chambers suites should be ducted directly toward the return air shaft. Ductwork should be treated to meet acoustic design criteria.

Jury Facilities

System Design

Trial jury suites should be served by the same system as the associated courtrooms when located on the same floor. A separate thermostat for each trial jury suite is required.

Air Distribution

Air distribution systems in jury facilities should provide separate temperature control and a high degree of acoustic isolation, particularly in the grand jury and trial jury rooms. Return air should be ducted directly back to the return air riser. Air ducts serving the trial jury and grand jury suites should be double-walled sound-attenuating ducts for a length of at least 12 feet (3.7 meters) from the diffuser or return air intake.

Judges' Conference Rooms

System Design

Shared judges' conference rooms may be served by the same HVAC system that serves the judges' chambers suites and associated courtrooms when located on the same floor. The system should facilitate off-hours use.

Air Distribution

Air distribution systems to judges' conference rooms should provide a high degree of individual control and acoustic privacy. Return air should be ducted directly toward the return-air shaft for a minimum distance of 15 feet (4,570 mm). The system should facilitate off-hours use.

Court Libraries

System Design

HVAC controls should accommodate the library's hours of operation and environmental requirements to protect the library's collection from temperature and humidity fluctuations. Library archival storage space requires 24-hour climate control with an individual thermostatic control for the space. Technical specifications may be found in the [National Archives' NARA Information Paper Number 13 \(1997\)](#). In extreme climates, such as those found in Florida or Alaska, separate humidity and temperature controls may be required.

Central Mail Facilities

System Design

Ductless fume hood(s) for mail screening should be used (in lieu of a dedicated AHU). The unit(s) will provide a negative pressure containment system with filtration (HEPA/ULPA); one unit should be installed to meet [Architectural Barriers Act Accessibility Standards \(ABAAS\)](#) requirements. The number of hoods should be determined based on the amount of mail being regularly screened. Generally, this would amount to two or three hoods. If more than three hoods are desired by a court, the court should furnish the additional hoods and also ensure that sufficient countertop space is provided for in the design.

The mail screening hoods should be self-contained and specifically manufactured for mail opening or similar applications. The hoods should be either 115V or 220V, provided with electrostatic pre-filter, HEPA filter, and active carbon filtration. The construction should meet or exceed OSHA, ANSI, and relevant international standards for operator safety. Interior lighting should be provided. Additional features, such as filter door key, filter safety lockout, low air flow alarm, and manual speed controller should be considered.

The mail facility should be conditioned typically using a VAV box with diffuser(s) and return duct. The supply and return ductwork should have quick closing dampers that are controlled directly from a manual duress button. The damper actuators should be electrically opened and should mechanically spring closed on a loss of power by interruption of the power supply as controlled by the duress button, and not the Building Automation System (BAS), when an alarm condition occurs. The dampers should be physically located in the ductwork within the room or immediately at the ductwork as it transitions into / from the room. The dampers position should be end switch proven (only closed) and an annunciator should be physically located in the mail room(s) that provides visual indication of the damper position for both the supply and return dampers. The

dampers should provide a pressure tight seal when closed with a leakage rate in accordance with AMCA Standard 511 Pressure/Class 1A and 4 inches w.g. The return air duct should have a modulating damper installed. The modulating damper should be controlled by a differential static pressure sensor set to maintain a negative 0.05 inch water column (IWC), adjustable, between the mailroom and the corridor. The AHU that provides air distribution should have a hardware interlock as part of the duress control system in the motor starter circuit that shuts down the AHU in an alarm condition. The design should include an additional manual duress button to be located at the USMS command and control center that should perform all of the sequences as the mailroom duress button. This button should be used in case the mail room individual has become incapacitated and is unable to push the local duress button.

Plumbing

An accessible emergency shower should be provided with a temperature control valve for a maximum water-supply temperature of 80 degrees Fahrenheit and a stay-open valve that is operated by a pull rod. Activation of the shower will send a mail room emergency signal to the USMS command and control center. Posted signs next to the shower should warn the mail room occupants that use of this shower will activate emergency controls and alarms.

In the shower area, a floor drain should be provided and the floor should be sloped to the drain. The drain should be connected to one or more freestanding polyethylene holding tanks or an in ground lined tank that can be easily pumped out and cleaned by a hazardous materials team. The holding tank size should be based on the water required for each occupant in the mailroom to take a shower. The tank, once pumped by the hazardous materials team can be used to retain the water required for decontamination of the room. The tank should be marked "hazardous material." Provide cold water and hot water automatic shut off valves activated by the high level alarm to prevent the holding tank from overflow. This alarm setting should be set to approximately 80 percent of holding tank capacity. This alarm should also send a decontamination tank overflow warning to the USMS command and control center. This alarm indication should also be used during decontamination to ensure the tank does not overflow during clean up.

An accessible wash sink with hot and cold water supply should be provided with a gooseneck faucet with a built-in eye wash along with a stainless steel countertop and a storage cabinet (with finishes that can be easily decontaminated). This sink is intended for general hand washing and not decontamination. The sink should drain to the house system.

For additional guidelines, refer to [GSA PBS P-100](#).

Server Rooms

Court information technology personnel, plus staff from the Administrative Office of the U.S. Courts (AOUSC) Office of Information Technology and Space and Facilities Division telecommunications specialists should be involved in all phases of design. This involvement ensures that adequate space, adequate building infrastructure, and proper adjacencies are incorporated into the design.

Mechanical and electrical systems should meet current and future needs, including space and power for the additional computer room air-conditioning (CRAC) units required for equipment expansion. Additionally, server rooms should be on emergency power systems to prevent a lapse in service.

The stakeholders should decide on the required electrical and air conditioning power density (watts [W] for every net square foot [NSF]) on a case-by-case basis for each project. The team should also plan to allow the future expansion of cooling and electrical systems by providing basic infrastructure for the additional electrical and cooling loads (watts [W] for every net square foot [NSF]).

Design for the high-temperature alarms, leak detection, smoke detection, and AHU and CRAC unit trouble alarms should be monitored on a 24-hour/seven-days-a-week basis from the building management system (BMS). The smoke and heat sensor activation should be integrated into the building's fire and life safety system.

Server rooms should be designed to maintain the following temperature and humidity conditions. These rooms should be provided with a supplementary cooling system to provide proper air-conditioning while the main building mechanical systems are shut down.

- Temperature: 18-27° C (64-81° F) dry bulb
- Maximum relative humidity: 60 percent
- Minimum dew point: 5.5° C (42° F)
- Maximum dew point: 15° C (59° F)

Refer to [Table 11.1, Space and Ceiling Requirements for Shared Support Spaces](#), for additional information.

Telecommunication Rooms

Telecommunications and AV rooms contain equipment with high heat gain and 24-hour/seven-days-a-week operation. These rooms should be provided with a supplemental cooling system to provide proper air-conditioning while the main building mechanical systems are shut down. The design team is advised to confirm the project-specific requirements during the conceptual design phase.

Telecommunication and AV rooms should be designed to maintain the following temperature and humidity conditions:

- Temperature: 18-27° C (64-81° F) dry bulb
- Maximum relative humidity: 60 percent
- Minimum dew point: 5.5° C (42° F)
- Maximum dew point: 15° C (59° F)

Refer to [GSA PBS P-100](#) for further guidance unless otherwise specified.

Mechanical Design Criteria

All court-occupied areas share the following mechanical design criteria unless otherwise specified:

Temperature

- Summer indoor design temperature should be maintained at 75 degrees Fahrenheit (24 degrees Celsius), during occupied conditions and should be maintained at 80 degrees Fahrenheit (26.5 degrees Celsius) during unoccupied conditions.
- Winter indoor design temperature should be at 72 degrees Fahrenheit (22 degrees Celsius) during occupied conditions and should be maintained at 65 degrees Fahrenheit (18.5 degrees Celsius) during unoccupied conditions.

Humidity

- Summer design humidity should be maintained at 50 percent during occupied conditions and should be maintained at 45 percent during unoccupied conditions.
- Winter design humidity should be maintained at 30 percent in occupied mode.

Dewpoint

- The indoor dew point temperature during occupied or unoccupied conditions should be limited to 55 degrees Fahrenheit (12.8 degrees Celsius).

Outdoor Air Design Criteria

- Refer to [GSA PBS P-100](#).

Ventilation

- The minimum outdoor air volume to be provided should be in accordance with the ASHRAE 62.1 adopted by the [GSA PBS P-100](#) standards.

Air Changes per Hour

- In the occupied operating mode in courtrooms and other court-occupied areas, the minimum air changes per hour are as indicated on the room data sheets.
- In the unoccupied operating mode, the air changes per hour should be reduced to provide minimum area ventilation required by ASHRAE 62.1 Standard.
- Refer to USMS Publication 64 for all detention area's requirements.

Electrical Distribution System

General Design Concerns

Sufficient electrical capacity, supply quality, and raceway flexibility should accommodate communications equipment such as personal computers, printers, scanners, video and audio systems, video teleconferencing systems, electronic security systems, and other office equipment. In addition, the electrical capacity provided for the court facility should meet the total demand load requirements, plus capacity for future load growth. Load calculations should use an appropriate diversity factor or historical billing information, if available. For additional guidance on spare capacity, refer to the [GSA PBS P-100](#).

The electrical system should provide power for all building components that require electricity, including, but not limited to, personal computers, network servers, related data and communications hardware, and security systems. Computer and security equipment should be connected to panelboards. Security equipment should be connected to emergency power systems. Refer to USMS Publication 64 for additional information.

Each telecommunications space should have its own dedicated electrical distribution panel, separating electrical circuits that serve telecommunications equipment from those that serve lighting fixtures.

- Minimum 100A, 120/208V WYE for distributor room/telecommunications room
- Minimum 150A, 120/208V WYE for server room

When designing the technology systems, care should be taken with regard to conduit, raceway, and cable management to minimize the potential for interference between signal types. The following signals should be run in separate raceways wherever possible.

- Power, per NEC requirements
- Microphone level audio
- Line level and speaker level audio
- Digital audio, video, and low-voltage DC control
- Networked audio, video, and control (Ethernet)
- Telecommunications, non-Ethernet
- Telecommunications Ethernet
- Speaker level audio
- Security
- Building systems control

Battery Backup

Areas where emergency lighting requires local battery backup to maintain camera and direct visual surveillance in the event of power failure include the following:

- Courtrooms
- Judges' chambers
- Controlled circulation areas
- Prisoner/attorney and witness/attorney interview rooms

Grounding Systems

In addition to the building grounding system requirements prescribed by the *National Electrical Code* (NEC), all outlets, devices, and equipment of the security systems should be properly grounded. A dedicated grounding system per the *BICSI Telecommunication and Bonding, ANSI/TIA 569-C, and ANSI/TIA 607-C* standards should be provided for the telecommunications and audiovisual systems. Technology raceway and equipment enclosures should be properly grounded.

Power Outlets

Adequate power outlets should be provided throughout the judges' chambers suites and other court-related offices to accommodate a wide variety of automated and regular office equipment.

Electrical Distribution

A raised access floor system (RAF) is not required; however, if it is desired, RAF should be incorporated into the design as a building system to allow for electrical and low-voltage distribution. Typically, RAF is utilized in the well of the courtroom for wire management purposes. For additional guidelines, refer to [GSA PBS P-100](#).

Metering and Sub-metering

Metering of electrical equipment should be discussed with the court's project manager to be considered in the design on a case-by-case basis. The court's project manager will provide feedback whether to install the meters depending on the project budget and utility consumption contract agreement with GSA. Electrical sub-metering may be needed for specific equipment of the HVAC system, such as CRAC units in server rooms, that require 24/7 utility services from the owner. Refer to the "Off-Hours" paragraph under the Mechanical Systems section of Chapter 15. For additional guidelines, refer to ASHRAE 90.1 and the [GSA PBS P-100](#).

Table 15.1
Electrical Requirements in Courtrooms

	Normal	Dedicated AV	Notes
Courtroom Duplex Outlets			
Judge's Bench	2	1	
Courtroom Deputy Clerk Station	2	1	As needed
Witness Box	1	1	
Jury Box	Note 1	Note 2	
Law Clerk Station	2	1	
Court Reporter/Recorder Station	1	1	
Attorney Tables	GSA PBS P-100	Minimum 1 as needed	Depending on anticipated load, circuits may be combined per NEC
Lectern Locations	1	1	
Display Carts		1	
Projection Screens		1	
Video Projectors		1	

¹ Based on two rows of jurors. One dedicated duplex per row plus a third dedicated duplex for the transceivers in the jury distribution box behind the second row.

² One outlet per two juror seats for displays on a minimum of two circuits; additional locations may be required if jury distribution is in a central location (i.e., under the jury floor).

Courtrooms

Table 15.1 summarizes the electrical requirements for courtrooms.

Electrical Distribution

An adequate number of electrical, data, and phone outlets should be placed near anticipated locations of equipment (sound recording equipment, amplifiers, video monitors, cameras, computers, projectors, X-ray viewers, court reporter steno machines, etc.). Power capacity and distribution should accommodate future requirements and take into account center, off-center, and corner bench locations. Power in millwork should be coordinated with the architect to ensure future access to power cables and other low voltage cables, such as telecommunication cables, AV cables, etc., is available for future installation and replacement. Power should also be designed or allocated for the addition of a future lift at the judge's bench. Courtroom audiovisual systems rooms and associated courtrooms power should be on single phase to reduce risk of unknown noise as recommended by AVIXA standards.

Normal Convenience Outlets

A three-phase, four-wire panelboard should be provided to power the courtroom. The panelboard should be sized to serve the courtroom, trial jury suite, miscellaneous areas, and circulation spaces. The panelboard should serve all general power requirements. If service is obtained by a three-phase, 480-volt supply, the general 120-volt power requirements should be served from a 480-120/208 volt transformer and associated panelboard(s). The local system ground should be tied into the main building ground. The feeder serving the area should accommodate 25 percent load growth. If a panel is provided within telecommunications rooms, proper access should be provided for building personnel to access the telecommunications room. Panelboards do not need to be dedicated strictly to serve the courtroom.

Dedicated Outlets

An electrical distribution system with independent breakers should serve computer, audiovisual systems, and security-related equipment. Power for technology racks for the courtrooms should be coordinated with the telecommunications and audiovisual design. Typically, provide a dedicated receptacle for each technology rack. The receptacle type should match the rack requirements for each technology rack. Separate circuits to motorized lectern locations, one on general power and one on dedicated technology power, should be provided to isolate the motor from the courtroom technology system. Equipment racks and enclosures should be properly safety bonded per the NEC, ANSI/TIA and BICSI grounding and bonding requirements.

Designated Outlets

Minimum outlet requirements for the various components of the courtroom are as follows and in addition to those shown in [Table 15.1](#):

Attorney Tables

- Multiple quadruplex receptacles for general purposes
- Multiple computer power receptacles

Miscellaneous Requirements

- Duplex outlets located at approximately 20-foot (6,100-mm) intervals along the walls of the courtroom
- Additional outlets at appropriate locations to accommodate the use of projectors, video monitors, video recorders, and X-ray viewers
- Floor boxes for the lectern, with built-in task lighting and a microphone outlet (include a timing system for appellate courtrooms only)
- Outlets to accommodate the future location of video cameras
- An outlet for a wall-mounted clock
- Duplex outlets at the jury box for jury monitors and other audiovisual equipment

Judges' Chambers Suites

Electrical Distribution

Electrical service serving the judge's chambers suite should be obtained from a local panelboard (three-phase, four-wire) sized to serve all areas associated with the suite. The panelboard should serve all general power requirements of the suite areas. Normal lighting should be powered from a 480Y/277V panel, if possible. The capacity of the feeder serving the area should accommodate future load growth with a minimum of 25% expansion capability. An electrical distribution system should serve computer equipment connected to courthouse computer networks and security equipment.

Emergency Power Distribution

Security equipment should be connected to the emergency power supply system.

Designated Outlets

Minimum outlet requirements for the judge's private chambers are as follows:

- Three quadruplex receptacles for general and miscellaneous purposes (e.g., a table lamp)
- One dedicated computer power receptacle
- One normal duplex receptacle for the judge's printer

Minimum requirements for the reference/conference room are established by the judge. Convenience outlets spaced at a maximum on 6 feet on center should be provided along the walls.

Minimum requirements for the law clerk and secretarial workstations (per station) are as follows:

- One quadruplex receptacle for general purposes
- One dedicated computer power receptacle
- One normal duplex receptacle for a printer
- One normal duplex receptacle for mobile device charging stations (similar to a USB dock for charging phones and other handheld devices)

Outlets serving the following equipment should be located as established by the judge:

- Copy machines
- Fax machines
- Scanners and shredders
- Printers
- Computer power receptacles
- Coffee machine
- Service unit equipment: microwave, refrigerator, etc.
- Miscellaneous (TV, projector, etc.)
- One normal duplex receptacle for mobile device charging stations (similar to a USB dock for charging phones and other handheld devices)

Distributed convenience outlets should also be located in accordance with the approved plans and NEC requirements.

Note: Devices provided with dedicated power (typically computers and security equipment) should be on separate circuits.

Jury Facilities

In general, normal electrical power distribution is required for jury facilities. Convenience outlets for 120V power should be located throughout the jury facilities. Outlets on separate circuits should be provided for the service unit. In the jury assembly, grand jury hearing, and trial jury rooms, outlets on separate circuits should be provided for projection units; a television monitor and digital video disc (DVD) player; and an audiotape recorder/player. In addition, an outlet for a wall-mounted clock should be provided in each room.

Outlets for multiple monitors or projectors or audiovisual equipment should be provided in the jury assembly area.

Special outlets for computers should be provided in each grand jury suite, the jury clerk's office, and stations for court security, U.S. attorneys, and the court reporter/recorder.

All Judges' Conference Rooms

Electrical Distribution

Electrical outlets should be provided to support AV equipment, personal computers, and other equipment. If the conference room is used often for training, power outlets should also be provided to accommodate the use of laptop computers and audiovisual equipment.

Shared Judicial Conference Rooms

Electrical outlets should be provided to support audiovisual systems, video conferencing equipment, personal computers, and other equipment. Floor boxes may be required to support flexible room layouts.

Public Waiting Areas

Duplex convenience outlets and power outlets for wall-mounted clocks should be provided.

Court Libraries

Normal duplex convenience outlets should be provided throughout the library. Dedicated power outlets should be provided wherever computers and other sensitive electronic equipment are used. All study spaces should be provided with convenience outlets.

News Media Room Electrical Distribution

The room should have normal convenience power outlets. Dedicated outlets to accommodate the use of personal computers and sensitive electronic equipment should also be considered.

Lighting Systems

General Design Concerns

A lighting design engineer should participate in the early phases of design to ensure that the lighting standards required by the *Design Guide* are met in an effective and efficient manner.

The lighting design for a courthouse should take a layered approach. Each type of layer accomplishes a critical task.

- A direct lighting component is required for appropriate horizontal illuminance and facial modeling.
- An indirect layer of inter-reflection light (or bounce light) is required to avoid shadows on faces and evidence and to allow for general illumination in the courtroom. The indirect layer can be provided through the use of cove lighting,

- suspended bowl or architectural light fixtures, or wall- or cove-mounted sconces, or it can be combined with the direct layer through the use of direct/indirect light fixtures.
- The use of dark wood paneling should be avoided as it typically requires a third layer of wall washing to increase wall surface brightness. Typically, wall washing is accomplished through the use of linear LED coves and linear LED wall-wash fixtures.
- A fourth layer of task or accent lighting can be used at the judge's bench, witness station, jury box, and attorneys' tables. The addition of task lighting improves the energy efficiency and the overall aesthetic design of a courtroom or other spaces within a courthouse by allowing a more directed approach to lighting and providing illumination at higher levels where it is needed, with lower levels provided elsewhere.

The interplay and relationship between lighting perception (brightness) and the choice of wall, floor, and ceiling finishes should be addressed by the design team. For example, the majority of lighting problems arise from human perception of room brightness, which is based on the reflection of the light from horizontal and vertical surfaces. Courtrooms with wood panels at lower levels generally allow for higher wall surface reflectance and greater perceived brightness. Darker wall and floor finishes can create problems because they are less efficient at reflecting light within the courtroom, which leads to more installed light fixtures and task lighting. The design team should carefully consider the use of dark wall and floor surfaces during the design phase to ensure that the proposed design does not adversely affect the energy efficiency or brightness perception of the space.

In general, daylighting improves the quality of a courthouse and the experience of staff and visitors. The lighting engineer should take into consideration daylighting factors such as glare and heat generation when designing a facility.

The lighting engineer should follow the design priorities identified in the IESNA *Lighting Handbook*, most current edition, Chapter 10, "Lighting Design Guide." The highest design priorities (not listed in order of importance) are (1) appearance of space and light fixtures, (2) color appearance and contrast, (3) daylighting integration and control, (4) direct glare, (5) light distribution on work surfaces, (6) modeling of faces or objects, (7) source/task/eye geometry, (8) lighting system control and flexibility, (9) horizontal illuminance, and (10) vertical illuminance.

The lighting design should be evaluated and validated by the design and engineering team throughout the design phase to ensure that the proposed design meets the standards set forth in this chapter and achieves an effective and efficient result. The team should evaluate lighting schemes and horizontal and vertical surface reflections and brightness. Lighting design should also comply with energy codes, such as ASHRAE.

Courtrooms

Lighting Criteria

The lighting of the courtroom should not only satisfy recommended lighting levels but also accommodate the future introduction of video recording, evidence display, and personal computer equipment. This requires adjustable lighting units to provide vertical foot-candles (FC) toward the front of the courtroom (judge, witness, and jury) and for highlighting (flag, U.S. seal).

Caution should be exercised when using excessively bright sources due to the potential noise problem and temporary lamp failure caused by voltage drops.

The lighting system should have good color rendition and avoid bright spots on the ceiling plane. Modulation of lighting levels should be used to distinguish the courtroom well and spectator areas. The lighting systems should be coordinated with the audio visual systems design

Some judges prefer to keep the lights on during audio visual presentations. Placement of light fixtures should take into account the location of the projector screen/monitor and allow all occupants of the courtroom to still view the images even with full lighting. Camera placement for VTC and/or streaming devices should also be considered when placing the light fixtures or placement of cameras should avoid being too close to light fixtures to avoid excessive light on image captured by the camera.

A lighting mock-up should be constructed, if possible, to replicate the proposed lighting design.

Lighting Levels

Lighting levels in the courtroom vary. The system should be capable of dimming to accommodate presentation of exhibits. The dimming level is determined by the video recording and conferencing system's lowest operable light level; however, to meet the safety code, the level should not be lower than 1 FC. Refer to [Table 15.2](#) for specific information regarding lighting levels in the courtroom. The color temperature of light fixtures should be discussed between the design team and end-users (judges and/or court personnel). The design team should perform appropriate lighting calculations for both normal and emergency lighting to validate the proposed design.

Lighting Controls

Lighting controls for the courtroom at a minimum should accommodate the following conditions:

- In use, fully occupied
- In use, no spectators
- Not in use
- Use of a projector or other device requiring a dimmed or darkened courtroom

- Video conferencing
- Cleaning purposes

In addition, the lighting control system should allow the intensity and type of lighting to vary at the discretion of the presiding judge. A remote means of dimming or extinguishing the lights should be provided.

Dimming of lights within the courtroom should be carefully designed to ensure dimming to low levels of light is achievable without flickering of the lights.

Panelboards and conductors should be located in a service area outside the courtroom. Circuit-breaker panels should not be the only means to control lighting. Access to the lighting controls is limited to court personnel. The controls should not be accessible to witnesses, jurors, attorneys, litigants, or the public. Where this is unavoidable, key-controlled light switches should be installed. Dimmers and lighting control panel boards should not be located in the telecommunications or AV equipment rooms.

An override switch should be located at the judge's bench and at the courtroom deputy clerk station to allow the instantaneous overriding of all dimming controls in an emergency.

The following lighting controls can be specified, depending upon the size of the courtroom, specific lighting arrangement, and lamp types:

- A more complex lighting installation consisting of local, wall, box-type, electronic, and integrated bi-polar transistor (IGBT) dimmers.
- Remote electronic dimmers with preset lighting arrangements, for large courtrooms with high ceilings.

Emergency Lighting

Selected lighting fixtures within the courtroom should provide an uninterrupted source of lighting in the event of a power outage. Standby power for emergency lighting to the courtrooms should be provided by local battery-backup units connected to an emergency generator. The judge's bench should not be spotlighted by emergency lighting.

To permit orderly evacuation, emergency lighting facilities should maintain a specified degree of illumination throughout the means of egress for one and a half hours. During that time, the lighting level should not be less than 1 FC. At the end of that period, the illumination may decrease to 0.6 FC. The judge's bench should not have an emergency spotlight.

Judges' Chambers Suites

Lighting Criteria

Lighting systems for the judge's chambers suite are determined in consultation with an architect, engineer, or lighting designer. The installation should be designed to meet federal energy-consumption criteria.

Special considerations in lighting design include veiling reflections on reading materials, color rendition, and other ambient characteristics. Task lighting should be provided to allow for 100 FC at the work surface.

Emergency Lighting

Standby power for emergency lighting should be provided by a local battery-backup system for selected lighting units in the judge's chambers, reference/conference room, and circulation spaces.

Jury Facilities

Jury Assembly Suite

The jury assembly suite should be illuminated by direct LED lighting, with additional lighting in the lounge areas. Natural light in the assembly area, especially in the lounge, is desirable. The jury orientation room and all areas opening to it require lighting control for audiovisual presentations.

Trial Jury Suite

Lighting in the trial jury room may be a combination of direct/indirect lighting and dimmer-controlled direct units. Jurors need the direct component when reviewing written material. When exhibits are viewed on a projection screen or TV monitor, the indirect LED units can be switched off and the direct units dimmed. Sufficient residual lighting should be provided for taking notes.

Consideration for full on lighting while reviewing evidence is needed.

Grand Jury Suite

The grand jury suite should be illuminated by dimmer-controlled direct LED units.

All Judges' Conference Rooms

Lighting Criteria

If excessive brightness can be avoided and privacy/security maintained, natural lighting is recommended. When natural light is used, a means of darkening the room for audiovisual presentations should be provided.

Electrical lighting of the judge's conference room should be switch-controlled direct LED units.

Emergency lighting powered by a battery-backup system should be provided.

Court Libraries

Natural Lighting

CALR stations should not be located where there is a glare from natural light.

Natural light is not desirable for bookstacks due to the damaging effects of sunlight.

Windows allowing an exterior view and natural light are highly desirable for study spaces. For enclosed study rooms, interior windows are preferable, since users may need to darken the rooms to view video. Interior windows also allow others to determine whether the rooms are occupied.

Natural light is desirable for all offices. Interior windows are necessary so staff can monitor library activity.

Natural light is not desirable in the archival storage area. Interior windows with a view of library areas should be provided if the area is enclosed.

Natural light is desirable, assuming excessive light is controlled in the Technical Services Area. Interior windows should be provided for viewing adjoining staff areas.

Natural light is not desirable in the microform area, since readers require a controlled-light environment. Interior windows with a view of library areas should be provided if the area is enclosed.

Electrical Lighting

The lighting in the library should be switch-controlled direct LED units. Indirect LED units are allowed in areas with computer screens and microform readers. A master switch should be provided at the library staff entrance.

Study spaces should be provided with task lighting. Lights should be placed over aisles in stack areas. The archival storage area should have special lighting, depending upon room use and the sensitivity of the stored materials. In all areas where reading occurs, care should be taken to avoid glare from lighting sources.

Lighting Standards

Table 15.2 provides the IESNA lighting standards required for courtroom spaces and other courthouse spaces that are beyond the public facilities standards outlined in [GSA PBS P-100](#). Horizontal illumination describes the amount of light landing on a horizontal surface such as a desk, and vertical illumination describes the amount of light landing on a vertical surface such as a wall or face.

Table 15.2
Lighting Requirements¹

	Horizontal Illumination Foot-Candles ²	Vertical Illumination Foot-Candles		Horizontal Illumination Foot-Candles ²	Vertical Illumination Foot-Candles
Courtroom and Associated Spaces			Trial Jury Suite		
Judge's Bench ³	50-55	20-25	Soundlock, Jurors' Toilets, Coat Closet, Trial Jury Room, Service Unit, Exhibits Display, Video Equipment, and Sworn-Jury Custodian Station	20-30	5-10
Bailiff	50-55	20-25	Grand Jury Suite		
Interpreter	50-55	20-25	Entry Area, Jurors' Toilets, and Service Unit	30-40	5-10
Court Reporter	50-55	20-25	Security Workstation and Hearing Room	50-55	10-15
Jury Box	50-55	20-25	Witness Room Exhibits Display and Video Equipment	30-40	5-10
Attorney Witness Table and Lectern ³	40-50	15-20	Closet	10-20	5-10
Witness Box	40-50	15-20	Court Libraries⁴		
News Media Room	30-40	15-20	Public Entry/Lobby	20-30	5-10
Attorney Work Room	30-40	15-20	Archival Storage Area	20-30	5-10
Attorney/Witness Room	30-40	15-20	Circulation Control Area, Periodicals Stacks and Seating Area	40-50	10-15
Public Seating	40-50	5-10	Reference Desk Area	40-50	10-15
Judge's Chambers Suite			Staff Access and CALR	30-40	5-10
Judge's Chambers Private Office ³	30-50	10-15			
Chambers Support Areas: Closet, Service Unit, Vestibule, and Private Toilet	10-30	5-10			
Judicial Assistant, File Storage, Conference Room, and Law Clerks ³	30-50	10-15			
Jury Assembly Suite					
Check-In, Coat Closet, Jurors' Toilets, Service Unit, Vending Area, Juror Lounge, and Jury Assembly Area	20-30	5-10			
Supplies and Storage	10-20	5-10			

¹ All other spaces not identified should provide the lighting standards in [GSA PBS P-100](#).
² A foot-candle (FC) is a unit of illuminance; it measures the amount of light in a space.
³ Supplemental task lighting may be necessary to raise the ambient light to a horizontal illumination of 100 FC.
⁴ The lighting in the library should be switch controlled. Indirect or direct/indirect LED fixtures should be installed in all areas that have adequate ceiling height. A master switch should be provided at the library staff entrance.

Communication Systems

Voice, Data, Courtroom Audio/Video, and Low-Voltage Cabling Design

The equipment found in courthouses, such as computers, telephones, copiers, scanners, and printers, is similar to that used in other government and business organizations. The federal courts also use several technologies specifically modified and adopted for judicial purposes, such as courtroom technology and court reporting technology.

Since automation technology is constantly evolving, any installation should be adaptable to change. Efficient architectural planning, programming, and design of infrastructure should facilitate the installation and modification of these technologies and substantially reduce the costs of equipment installation and maintenance.

General Design Concerns

Registered Communications Distribution Designer

The GSA design team is responsible for the design and installation of the telecommunications infrastructure. This infrastructure consists of the pathways and spaces (conduit, cable tray, sleeves, distribution rooms, server room, etc.) that support the courts' cabling and equipment. The design team should include a registered communications distribution designer (RCDD) to assist with this effort. An RCDD is a Building Industry Consulting Service International (BICSI) certification that focuses on the design, integration, and implementation of information and communications technology systems.

The RCDD should participate in the early phases of design development of a courthouse to ensure the required infrastructure is provided to support the courts' technology systems. The RCDD should work with the AOUSC, GSA design team, and the local court space and IT and audiovisual technology staff to develop the most efficient distribution systems for all low voltage requirements. The AOUSC should also engage an RCDD to review the GSA design team's telecommunications infrastructure design to ensure that the design meets industry standards and any unique court requirements. The AOUSC's RCDD should only provide court requirements therefore the GSA design team should work with other tenant agencies to determine their requirements.

Certified Technology Specialist Designer

A certified technology specialist designer (CTS-D), an AVIXA-certified AV technology specialist in design, should be part of the design team contracted by the court unit or AOUSC. The CTS-D should participate in the early phase of design development of a courthouse to ensure that the required infrastructure is provided for the audiovisual systems. The CTS-D should work with the AOUSC (courts technology, Space and Facilities Division, information technology, and communications staff) design team and the court managers, information technology operations staff, and other staff responsible for

court technology/audiovisual systems management and deployment to develop the most efficient distribution systems for audiovisual requirements. The Judiciary is responsible for retaining the CTS-D.

Voice and Data Communications Systems

Courthouse voice and data systems require extensive low-voltage cabling. The associated cable systems require a well-designed and well-installed building infrastructure to support the routing and connecting of cabling and housing of equipment. The use of basket cable tray for horizontal cable distribution in court-occupied spaces is required. This tray should be dedicated for court use only. Pathways through inaccessible ceilings and non-court spaces should require conduit. The design team should refer to the following:

- *Courtroom Technology Audiovisual Infrastructure Manual*, most recent version
- *GSA PBS P-100*
- *Illumination Engineers of North America Lighting Handbook*, most current edition, Chapter 10, "Lighting Design Guide"

Telecommunications Cabling Standards

- *American National Standards Institute (ANSI) Telecommunications Industry Association (TIA) ANSI/TIA-568 Series of Telecommunications Standards (Most current version)*
- *ANSI/TIA TSB-162 Telecommunications Cabling Guidelines for Wireless Access Points (Most current version)*
- *Building Industry Consulting Service International (BICSI) Telecommunications Distribution Methods Manual (TDMM)*, most current edition

Telecommunications Infrastructure Standard

- *ANSI/TIA-569, Commercial Building Standards for Telecommunications Pathways*, most current edition
- *Requirements and Specifications for Special Purpose and Support Space Manual, Volume Three, Judicial Security Systems Requirements and Specifications (USMS Publication 64)*, most current edition

GSA should provide a shared demarcation room (entrance facility) to house telecommunications and data service providers' cabling infrastructure and termination equipment. In addition, GSA should provide conduit pathways from at least two separate telecommunications maintenance holes to the demarcation room. It is the responsibility of GSA to coordinate with the local service providers to have facilities (copper and fiber) extended into the building. Each tenant agency is then responsible for ordering their services from the local providers. Additionally, GSA will provide conduit pathways from the demarcation room to the court's telecommunications server room.

The Judiciary’s telecommunications server room (server room) should be sized according to the voice and data network equipment required to serve the court’s needs. The Judiciary’s IT department will provide estimated heat loads and power requirements to the GSA design team. Electrical and cooling equipment, including a dedicated 120/208v, 150A sub-panel on emergency power, should be incorporated into the space plan. A centralized UPS system may be required in larger courthouses. Dedicated conduit pathways and raceways should connect the server room to each telecommunications distribution room and the demarcation room. The server room should be secured with controlled access.

The telecommunications distribution room should be sized based on the known number of planned and future work areas. A work area is any location where a person would work at a computer or other network-connected device such as a printer, scanner, network-attached camera, or wireless access point. The minimum size for a typical telecommunications room will be 10 feet (3000 mm) by 12 feet (3600 mm). Each floor should have at least one telecommunications room which should be centralized within the area being served and account for maximum cable distance limitations (295 feet (90 meters)) to the furthest work area to be served. Dedicated conduit pathways and raceways should connect each telecommunications room vertically to the telecommunications room directly above and below and horizontally to any other telecommunications room on the same floor. The telecommunications room should be connected by dedicated conduit pathways to the telecommunications server room. Electrical and cooling equipment, including a dedicated 120/208V, 100A sub-panel on emergency power, should be incorporated into the space plan. The telecommunications room should be secured with controlled access.

The courtroom audiovisual room (AV room) should be sized based on the number of courtrooms served by the room. The minimum size for a typical AV room will be 10 feet (3000 mm) by 12 feet (3600 mm). The location of the room (adjacency and proximity to the courtroom) is more critical than the size of the room. The AV room design should not impact the acoustical envelope of the courtroom nor impact any acoustical performance in the courtroom. Dedicated conduit pathways and raceways should connect each AV room to the nearest telecommunications distribution room on the same floor. Electrical and cooling equipment, including a dedicated 120/208V, 100A power sub-panel on emergency power, should be incorporated into the space plan. The AV room should be secured with controlled access.

In multistory buildings, vertical pathways and conduits dedicated to the court’s IT and AV networks should be installed. An efficiently designed distribution system vertically aligns (stacks) the telecommunications distribution rooms on each floor directly above each other and in close proximity to the court’s server room.

All Judiciary server rooms, telecommunications distribution rooms, and AV equipment rooms are to be restricted solely for court use. The GSA design team should coordinate telecommunications requirements with other building occupants.

Courtrooms

Audio, Video and Court Technology Control Systems

Courtrooms generally require sound-reinforcement and video systems, which should be integrated with the architectural and engineering design. The design team with the CTS-D should ensure the proper design of the required infrastructure and ensure that finishes and lighting do not interfere with the performance of the audio and video systems. The design team should refer to the [Courtroom Technology Audiovisual Infrastructure Manual](#) for specific details on the design of courtroom systems; Chapter 14, “Acoustics,” of this *Design Guide*; and the [lighting section](#) of this chapter. It is important to ensure the integration of these devices into areas in the courtroom such as jury box, bench areas and counsel tables. Refer to Chapter 12, “Tenant Improvements and Furnishings” in the “Tenant Improvement - Millwork” section for more information.

Communications

Voice, data, and wireless access points outlets should be provided where required.

Court Reporter/Recorder Technology

Law, rule, or order of the court requires the production of an official record of a court’s proceedings. With the exception of video recording, all known court reporting technologies—shorthand, machine stenography, computer-aided transcription, single- and multitrack audio recording, and voice writing (also known as stenomask)—are regularly used throughout the federal judiciary. Because all the judges in large metropolitan federal courthouses will not agree to employ a single reporting method, the installation of a centralized audio or video recording facility in such a courthouse is not recommended.

The rapidly growing reliance on electronic recording of proceedings, and, in particular, multitrack audio recording, video evidence presentation, and computer-aided transcription, means that careful attention to electrical and audio facilities in the courtroom is required. Proper design considers the placement and type of microphones, the quality and location of the microphone connectors, audio wiring, integration of the audio recording system and evidence presentation system with the public audio amplification system, and the acoustic conditions of the courtroom. Microphones and speakers may be part of courtroom millwork, and planning should consider the space and personnel required for efficient operation. Some reporting technologies require networks and the installation of monitors and projection equipment in the courtroom.

Two current technological innovations in courtroom reporting are real-time stenographic transcription and voice-recognition transcription for the preparation of electronic or printed transcripts. A third advance is instantaneous transcription of trial proceedings. None of these technologies requires substantial changes in courtroom design.

For information regarding courtroom technology, refer to the [Courtroom Technology Audiovisual Infrastructure Manual](#).

Judges' Chambers Suites

Video

One or more outlets connected to the building video distribution system and cable television system should be provided in the judges' chambers and conference/reference room.

Communications

Voice, data, wireless access points, and intercom outlets should be provided where required.

Jury Facilities

Audio

A sound system should be provided in the jury assembly area. The system should allow audio inputs from video or other presentation equipment.

Assisted-listening system (ALS) controls and emitters should be permanently installed and integrated with the jury assembly area sound system. ALS controls are generally located adjacent to sound system controls. In addition, inductive loop ALS systems may be considered. If an inductive loop system is desired, the loop should be engineered and provided with the technology infrastructure.

A self-contained, portable ALS should be available for use in trial jury suites and other places where sound systems are not present.

A sound system should be provided in the grand jury hearing room. The system should allow audio inputs from video or other presentation equipment.

ALS controls and emitters should be permanently installed and integrated with the grand jury hearing room sound system. A wireless, infrared ALS provides the flexibility and privacy needed in the grand jury hearing room. If windows are provided in the room, caution should be exercised to avoid interference with infrared signals. An infrared ALS requires emitters to provide line-of-sight transmission to the entire room.

Multitrack systems in the grand jury hearing room can be used for assisted listening, simultaneous translation, and confidential tape recordings.

The grand jury foreperson/secretary station and witness box should be equipped with microphones connected to an amplification/audio recording system. The microphones should be controlled by the court reporter/recorder.

When an interpreter is used, the interpreter should be provided a microphone connected to the room's amplification/audio recording system.

In addition, a microphone connected to a sound system should be provided at the U.S. attorney station and/or lectern.

Video

In the juror lounge and assembly suite, one or more video outlets connected to the cable television system should be provided.

Communications

In the grand jury hearing room, telephone/intercom instruments should be provided at the jury clerk's office, security desk, and U.S. attorney station.

Court Libraries

Audio

A paging system is desirable in larger libraries. The system's microphone and controls should be located at the circulation/reference desk; speakers should be located throughout the public areas of the library.

Communications

All staff offices and work areas should be provided with a telephone and data outlet. In addition, all enclosed private study areas and CALR stations should be equipped with data and wireless access point outlets. Outlets used only by staff and court personnel should have intercom capability. Refer to the *Courtroom Technology Audiovisual Infrastructure Manual*.

Clerk's Office

Video

Consult with the AOUSC's communications team and refer to the *Courtroom Technology Audiovisual Infrastructure Manual*.

Communications

Consult with the AOUSC's communications and information technology staff and refer to *GSA PBS P-100*.

Office of the Chief Pre-Argument/Conference Attorney

Accommodation for videoconferencing should be provided. Consult with the AOUSC's communications staff and refer to the *Courtroom Technology Audiovisual Infrastructure Manual*.

Office of the Bankruptcy Administrator

Conference rooms should accommodate recording equipment.

Renovations and Alterations (R&A)

Certain design requirements stated in the *Design Guide* might be impractical, impossible, or cost-prohibitive because of challenging existing conditions. Stakeholders should discuss these challenges early in the project and determine how to best implement the *Design Guide* requirements to suit their specific needs and uphold the intent of the guide. Consideration and care of an occupied courthouse should be taken to seal off unoccupied areas of construction from other systems in operation.

Mechanical Systems

The extent of renovation should be in compliance with the latest edition of the *International Existing Building Code*. The applicable alteration level (1, 2, or 3) should dictate the extent of renovation or upgrade required to the mechanical systems to bring it up to current codes.

In existing courthouses, [GSA PBS P-100](#) describes minimum height criteria for the location of the air intakes. It is a security risk if the air intake is located too close to street level and is easily accessible. If the air intakes are located below the height level indicated in the [GSA PBS P-100](#), moving the air intake should be considered and/or included in GSA repair and alteration projects. In situations where structural or historic limitations make it difficult or cost prohibitive to relocate air-intakes to a higher level, other alternatives should be explored such as reducing visibility from public view and making them as inaccessible as possible.

Moving air intakes has an impact on rent, tenant space, and operations. Communication with the local court, the circuit, and AOUSC is important so that rent impact can be assessed and budgeted.

Actions to address HVAC should not compromise historic ceilings and materials. Lowering or concealing historic ceilings in historic courtrooms and lobbies in order to route mechanical systems should be avoided. Architectural elements such as soffits can often be designed or utilized to reroute ductwork without compromising historic ceilings and materials. Retain decorative elements of historic systems where possible including ornamental grilles, radiators and other decorative elements. Appropriate finishes and fixtures should be used for visible or high-profile areas.

Energy conservation methods and systems are encouraged; but it is critical that the project team understand the operational needs of the local court, which should also be considered in the design of the system.

Acoustics

Renovations, updates, or alterations to building services should consider the impact to acoustics. Refer to the R&A section in [Chapter 14, “Acoustics,”](#) for acoustical criteria and general direction. An early review of the impacted spaces by an acoustical consultant is recommended to determine the acoustical impact of the project. A seemingly unrelated building system update could potentially impact the acoustical performance of the existing building. For example, new ducts or conduit could penetrate a sound-rated wall and create a path for a noise leak or inclusion of a new terminal unit could add unwanted noise.

Court Technology

Look for opportunities to leverage seemingly unrelated R&A projects to update technology infrastructure. For example, if GSA plans sprinkler replacement, moving or replacing mechanical ductwork, or replacing light ballasts or fixtures, the ceilings will likely be opened up. This may provide opportunities for work such as updating or installing audiovisual cabling and equipment, telecommunications wiring (voice/data), or security equipment. In addition, when planning an R&A project, such as replacing the courtroom carpet, consider the condition and cyclical replacement cycle for court technology and audiovisual systems and look at upgrading the technology infrastructure in the same R&A project. It can be much more cost-effective and less disruptive to plan and coordinate the tenant work while the building is under construction.



BUILDING SECURITY

This chapter discusses the planning and design of courthouse security, including agency responsibility, security planning and design concepts, and security systems and equipment.

Chapter Topics:

- Introduction
- Supporting Documents
- Agency Responsibilities
- Security Systems and Resource Request Process
- Security Concepts
- Exterior Security
- Interior Security
- Co-tenancy with the Federal Judiciary
- Security Funding

Chapter Figures and Tables:

Figure 16.1	Appellate Panel Courtroom Security Diagram
Figure 16.2	Appellate En Banc Courtroom Security Diagram
Figure 16.3	Multi-Party Courtroom Security Diagram
Figure 16.4	District Judge Courtroom Security Diagram
Figure 16.5	Magistrate Judge Courtroom Security Diagram
Figure 16.6	Bankruptcy Judge Courtroom Security Diagram
Table 16.1	Security Funding Responsibilities

Introduction

Security is essential to the basic design of courthouses. Courthouse security is complex in that different court components and circulation patterns require varying degrees of security. In addition, federal courthouse security is the responsibility of the Judiciary, the Department of Homeland Security's Federal Protective Service (FPS), the General Services Administration (GSA), and the U.S. Marshals Service (USMS). It is critical that the architectural/engineering (A/E) team consider the security implications of every aspect of design as a high priority and coordinate with the appropriate stakeholders during the initial design phase. No amount of security equipment and personnel can effectively secure a building that has been designed without taking physical security into account.

Security concerns, including demonstrations, weapons, witness and jury intimidation, bombs, and so on, are inherent to courthouses. Optimal courthouse security is a fine balance between architectural solutions, allocation of security personnel, operational procedures, and installation of security systems and equipment. Since security planning is a basic and critical part of courthouse design, it should be factored in at the beginning of site selection and the design process. Failure to do so can result in costly and time-consuming reconfigurations.

Courthouse security systems are categorized as exterior and interior security systems. Exterior security includes considerations of site location, parking, access control, site lighting, perimeter surveillance, building access control, and intrusion-detection/ alarm systems. Interior security includes personnel security, security of property and documents, access control to interior spaces, intrusion-detection, video surveillance, personnel movement and circulation controls, security aspects of spatial arrangements, and coordination between security and fire and life safety requirements.

Supporting Documents

A comprehensive guide to supporting documents can be found in [Chapter 2, "Courthouse Programming and Budgetary Considerations."](#) That listing includes program and design criteria, courthouse planning and related guidelines, policies, and information on many facets of the design and construction of federal courthouses. The references listed below relate specifically to this chapter.

- *Design Notebook for Federal Building Lobby Security*, GSA and USMS. The goal of this publication is to illustrate how effective security screening and the related equipment and personnel can be integrated into the design of lobby spaces in new courthouses. The guide includes prototype designs as well as typical details.
- *Facilities Standards for the Public Buildings Service (GSA PBS P-100)*, General Services Administration, most current edition

- *GSA IT - Building Technologies Technical Reference Guide*
- *The Risk Management Process for Federal Facilities: An Inter-agency Security Committee Standard*, DHS, most current edition
- *Requirements and Specifications for Special Purpose and Support Space Manual (USMS Publication 64), Volume One, Construction Requirements and Volume Two, Security Products, Office of Facilities and Courthouse Construction*, most current edition
- *Requirements and Specifications for Special Purpose and Support Space Manual (USMS Publication 64), Volume Three, Judicial Security Systems Requirements and Specifications*, most current edition
- *Site Security Design Guide*, GSA, most current edition

Agency Responsibilities

Courthouse security is the joint responsibility of the Judiciary, FPS, GSA, and USMS. Decisions regarding security planning and design are made by all of these organizations.

Federal Protective Service

The FPS is responsible for law enforcement at all GSA owned and leased facilities, including all court facilities. The FPS provides security for the building perimeter and non-court-related agency space. The FPS installs perimeter closed circuit video (CCV) and intrusion-detection systems (IDS) in federal buildings. The FPS-installed IDS are monitored from a remote regional communications center. Building access systems (i.e., locks, keys, and the integrity of door hardware) and parking protection/lighting are typically the responsibility of the GSA building manager.

Physical access control systems (PACS) are computer-based systems which permit access to buildings and spaces within buildings. A modern PACS includes card readers, electronic door latches, request-to-exit devices, door status switch sets, control panels located in tele-data or security closets, the head end computer, the enrollment computer to enter cards, and the infrastructure needed for the system's operation.

In court facilities, the PACS on the perimeter doors of the building may be installed and controlled by GSA or the USMS. In court space, PACS is the responsibility of the USMS.

FPS is responsible for the protection of most federal buildings. The USMS has assumed this role in judiciary-occupied space. The USMS is also responsible for the personal security of judges, court staff, and the public. This includes the protection of judges, witnesses, jurors, and prisoners.

Court Security Committee (CSC)

Each of the 94 federal court districts has a CSC chaired by the chief district judge or the chief judge's designee. The U.S. marshal for the district serves as principal coordinator of the committee. The responsibilities of the CSC are to develop and implement a district-wide security plan, and to meet periodically to identify security problems, and develop solutions. The local CSC is responsible for addressing the security concerns of the entire judicial district or circuit, including judges, chambers staff, clerks, probation and pretrial services officers, librarians, federal public defenders, and other members of the Judiciary. This responsibility includes the security for all judicial areas within federal buildings as well as any leased space that has court staff on-site. The CSC also reviews facility and security system designs and coordinates the various agencies responsible for the design, construction, and operation of court security systems.

Facility Security Committee (FSC)

The FSC includes representatives of all tenant agencies and is chaired by the highest-ranking official of the agency occupying the most space in the building or his or her designee.

FSCs (formerly Building Security Committees) were established for each federal facility under GSA's control following the Department of Justice's recommendation in its *Vulnerability Assessment of Federal Facilities* after the April 1995 bombing of the Alfred P. Murrah Building in Oklahoma City. Unlike CSCs, which consist solely of representatives of the court and related agencies and address security issues involving the courts on a judicial district-wide basis, FSCs address the security requirements of all federal agencies that occupy multi-tenant buildings. The FSC is tasked with evaluating the building's physical security recommendations based on the Inter-agency Security Committee (ISC) standards. All security systems and equipment within judicial space should be consistent with the requirements set out in the USMS Publication 64.

U.S. Marshals Service

The USMS is responsible for protection of judges, other courts officials, witnesses, jurors, visitors, prisoners, and others. It manages fugitive investigations, assists with the location and apprehension of fugitives, manages assets forfeited due to criminal conduct, manages federal prisoners throughout the court processing system, and provides witness protection. Within the USMS are the Office of Security Systems and the Office of Construction Management.

Office of Security Systems (OSS)

The USMS physical security planning responsibilities for court space are handled by the Office of Security Systems (OSS). OSS is responsible for the planning, design, and

installation of security systems in spaces occupied by the Judiciary, including judges and their staffs, clerks of court, probation and pretrial services officers, librarians, staff attorneys, circuit and district court executives, and other members of the Judiciary. The USMS does not specify security systems for the U.S. Attorney or U.S. Trustee, as they are part of the executive branch and do not fall under the courts' jurisdiction.

In addition, OSS in conjunction with FPS are the security consultants for court buildings, designing and integrating security systems for the building perimeters. OSS retains a nationwide security systems contractor for security systems installation and service in all courthouses and space leased for court activities. The OSS security specialist should participate during Phase I of the design process. The specialist's participation will prevent expensive retrofits and ensure that the infrastructure to support the security systems and equipment is incorporated into construction documents. This will also ensure that sufficient funding is requested and allocated. Further, the USMS nationwide security systems contractor should participate in the design and construction to allow for timely installation and accessibility to conduit and junction boxes.

OSS is a part of the USMS, and their responsibilities include security systems and equipment for court-occupied and USMS operational space and is separate and distinct from the USMS Office of Construction Management.

Office of Construction Management (OCM)

The OCM oversees USMS space and construction projects. The OCM is responsible for design considerations involving secure prisoner movement, holding-cell and interview facility requirements, and USMS-occupied office and support space.

Security Systems and Resource Request Process

The USMS Office of Security Systems (OSS) and the Administrative Office of the U.S. Courts (AOUSC) Facilities and Security Office Judiciary Security Division notify court unit executives of the annual resource request (budget call) for courthouse security systems and equipment. The notification memorandum is for the budget year project requirements that will be needed to be delivered within 6 to 8 months. The projects can be as small as a control package for a judge's chambers or as large as a major renovation and alteration project. The OSS, AOUSC, circuit, court unit, JSI, and other stakeholders should work closely to develop systems and equipment requirements to ensure a secured and safe courthouse for the public and court employees from the lobby to all spaces within the courthouse. Once the process is completed, the list is submitted to the CSC for review and chief district judge's approval prior to submission to OSS.

The OSS has developed a project database that will allow the JSIs to track the status of a project from request through the USMS's prioritization and approval process. It is imperative for the JSI, OSS, AOUSC, ACEs, and other stakeholders to routinely

communicate and avoid unplanned project requirements. For example, if the ACE, AOUSC facilities program manager, and GSA are aware of expiring leases, the OSS physical security specialists and JSI must be notified of the pending requirement at minimum 24 months before the termination of the lease.

Security Concepts

Courthouse security requires coordination of architectural design, allocation of security personnel, and security systems and equipment. Basic architectural solutions to security problems are an integral part of planning and design for the courthouse. Separation of public, restricted, secure, and service circulation patterns and provision of secure prisoner holding and interview facilities are essential security design elements. Courthouse design should consider expansion and security needs to meet short- and long-term housing requirements.

Security systems and equipment can reduce the number of security personnel required; however, systems and equipment are not intended to replace all personnel. The cost of architectural solutions incorporated during planning and design—as well as the initial installation, operation, and maintenance costs of security systems and equipment—is often small compared with security personnel costs over the anticipated life of the facility.

Since the USMS may be responsible for on-site monitoring systems protecting the site, building perimeter, and non-judiciary or court-related tenants, all security systems are integrated into the USMS command and control center. Security systems monitored by the USMS typically include intrusion alarms, duress alarm devices, PACS, and CCV and audio/video switching and recording systems. All security systems and equipment should be consistent with the *Risk Management Process for Federal Facilities; An ISC Standard (with appendixes; current edition)*; USMS Publication 64; and OSS required elements.

Consistent with the standards set forth in the *Risk Management Process (RMP) for Federal Facilities*, an Interagency Security Committee (ISC) Standard, the proposed facility security level (FSL) for new courthouse construction is FSL 4. In general, U.S. courthouse facilities meet the scoring for this FSL designation based upon consideration of the scoring standards, such as occupancy, threats towards tenant agencies, and the symbolism threat directed towards the court. Additionally, and consistent with ISC criteria, each court's FSC can make this determination.

Exterior Security

Site

Building Setback

The building setback is defined in *The Risk Management Process for Federal Facilities: an Inter-agency Security Committee Standard* and is achieved using passive barriers such as bollards and planters and/or active barriers such as crash rated drop arms, movable wedge barriers, and gates. Setback can often be established with site design using berms or other aspects of crime prevention through environmental design (CPTED).

Landscaping

Special attention should be paid to the location, selection, and configuration of plants outside the building, particularly at parking and building entrances. Plants should be small and low so they cannot be used as hiding places or obstruct sight lines when initially planted or as they mature. Consideration should also be given to potential plant growth and its impact on the CCV system including plants that either interfere with lighting or obstruct CCV camera views. Landscaping can also be used to enhance security by preventing encroachment on the building setback. Loose rocks that could break glass, if thrown, should be avoided.

Site Lighting

Sufficient lighting is critical to the proper operation of the perimeter CCV and the safety of the public and employees outside the courthouse. Illumination should be provided for areas between cars and around bushes and shrubs. Higher levels of illumination are required at vehicle and pedestrian entrances. All perimeter lighting should support the operation of CCV cameras. Coordinate security lighting design with USMS Publication 64.

Separation of Vehicle Circulation

Four vehicle circulation systems are required, for (1) judges, (2) designated court employees, (3) USMS prisoner transport, and (4) service. As needed, judges and court employees may share an entrance if parking areas are physically separated with automated controls. Vehicle access to the site should be controlled at a single point with an electronic access control system, and active vehicle barriers.

CCV

CCV cameras should be installed by FPS to provide complete perimeter coverage and should be connected to the USMS command and control center. USMS will use the cameras for prisoner movement into the sally port area. Cameras should also have the capability to be connected to an FPS regional communications center for after-hours surveillance.

Parking

Restricted Judges' Parking

Restricted parking, with electronic access control, should be provided for all judges. Judges' parking should be located in a totally enclosed area under the building, or, if this is not possible, in a fenced area with no public view of the parking area or the judge's path to the building. A separate restricted entrance to the building from the parking area should be provided. The design team should refer to the Judiciary's parking policy approved by the Judicial Conference of the United States (JCUS) on March 16, 1999, for further details. A copy of the policy can be obtained from the AOUSC Space and Facilities Division.

Employee and Visitor Parking

Court-employee, juror, visitor, and non-court-employee parking areas, if provided, should be located adjacent to or outside the courthouse. These parking areas should be fenced and provided with electronic access controls. The design team should refer to the Judiciary's parking policy approved by the JCUS on March 16, 1999, for further details.

CCV

A CCV system should be provided to monitor access to restricted and secure parking areas, parking spaces, and associated building entrances. Cameras are to be monitored by the USMS command and control center.

Building Perimeter

Intrusion Detection

An intrusion-detection system covering all perimeter doors, including roof access, should be installed in the courthouse. Ground-floor or accessible windows should be protected with glass-break detectors or other sensor technology. Intrusion-detection systems are to be monitored by the FPS Mega-Center and/or USMS (on- or off-site) on a 24-hour basis.

Exterior doors in a Means of Egress Emergency Exits

Exterior doors should be self-locking and equipped with a remote alarm and interior CCV camera, both monitored by the USMS command and control center. Exterior exits should be equipped with magnetic locks or electric strikes and are permitted to have a delayed-egress electrical locking system installed, or other acceptable egress door hardware. Delayed-egress electrical locking systems on fire doors should be connected to battery-backup power and emergency generators. The systems should remain locked from the outside during a power failure. Exterior doors should not have any exterior hardware unless required to permit access (i.e., front public or employee entrances), and exposed hinges should be peened to ensure the security of the doors. A peened hinge is a hinge that has a pin that cannot be removed by pulling the pin out.

CCV

A CCV camera, also monitored by the USMS command and control center, should be installed by FPS to provide a clear view at each remote exit without having to be manipulated by the operator (no pan-tilt-zoom cameras).

Building Entrances

Elevators or stairs from the staff or public parking area should discharge at a point in front of the lobby screening station to allow weapons and contraband screening.

Public Entrance

Only one public entrance, with a lobby large enough to hold visitors during peak periods, should be provided, configured, and sized to allow security systems to be part of the architectural design and circulation path from the entrance. The security station should be placed near the building entrance, with sufficient space for queuing during peak periods, and wheelchair access should be provided. Space should be allocated for turnstiles, X-ray machines and magnetometers. In leased spaces where weapons screening is not performed at the main entrance, there should be adequate space and provisions for power to allow for appropriate screening equipment. Refer to [Chapter 3, "Planning for U.S. Courthouses,"](#) for public lobbies and atriums; *Design Notebook for Federal Building Lobby Security*; USMS Publication 64; and OSS required elements.

Security Pavilions

Some courts may require a separate but adjoining exterior structure to house the secured entry screening into a federal building or courthouse. The purpose of a security pavilion is to provide entry screening by security officers (FPS or USMS) in an area separated from the critical components of the building to prevent progressive collapse, building wide contamination, or catastrophic damage to the facility in the event an explosive device is detonated or a harmful substance is released. They should also be separated by impenetrable (ballistic rated or solid metal) doors which can be closed remotely to deny an adversary entrance into the main structure.

It should be noted that all security pavilion annexes must receive both appropriate committee and JCUS approval prior to construction. In 2013, the JCUS adopted the following policies relating to security pavilions:

- The current Circuit Rent Budget program process for approval of Component B projects should be applied to any request for construction of a security pavilion to adjoin an existing court building, so that any potential increase in rent costs can be considered along with other aspects of the project. These projects must receive approval by both the Committee on Space and Facilities and the Judicial Conference.
- The Committee on Judicial Security must review any request for construction of a security pavilion before it is considered by the rent management subcommittee of the

Committee on Space and Facilities, so that the need for the pavilion from a security standpoint, as well as the impact of the project on the court security appropriation, can be taken into account.

Employee Entry

Employees generally enter the courthouse through the public entry screening point. If the CSC or FSC determines that a separate employee entry is permitted there will generally not be screening at that entry point and employees entering through there will not be screened for weapons or other prohibited items.

Judges' Entry

Entrance from the judges' parking area to the restricted elevator via a restricted lobby should have electronic access control, a CCV camera, an intercom, and a duress alarm. The entrance should have the necessary travel cables to support security equipment. The entrance should be monitored by the USMS command and control center.

Loading Dock

A single building entry point for supplies and services should be provided by the loading dock and service area. Parking for service vehicles should be located outside the court building. Where service and delivery vehicles are parked adjacent to the court building, the area should be designed to reflect and withstand explosions.

Where a parking lot guard is provided, vehicular deliveries can be channeled past the guard post for screening. The loading-dock entry should have electrically controlled doors, with remote control and monitoring by the USMS command and control center. A metal detector and X-ray machine should be provided to screen personnel, mail, and packages entering the building. Intercom and CCV systems should be installed to alert security personnel to the arrival of delivery trucks and allow surveillance of the loading-dock area. This equipment should be monitored by the USMS security station in the public lobby or by the USMS command and control center.

Interior Security

Circulation Controls

An essential element of courthouse security design is the physical separation of public, restricted, and secure circulation systems. Trial participants should not meet until they are in the courtroom during formal court proceedings. The integrity of each circulation system should be maintained for all functions within the court facility, including service access points.

The circulation system should provide judges a means to move from restricted parking to chambers and to move between chambers, courtrooms, and other spaces through restricted corridors. Generally, access is controlled by PACS.

Jurors should be provided with a means to move between floors on restricted-access elevators without crossing public spaces or secure prisoner corridors. Elevators should accommodate movement of a jury panel and court security officer (CSO). The elevators should provide access to jury dining facilities (if provided) from trial jury suites. The elevators may need cab doors on opposite sides to serve both public and restricted corridor systems and should be provided with CCV, PACS, and appropriate-sized travel cables for support.

The building design should provide a means for the USMS to move prisoners from the vehicle sally port into central holding facilities, the grand jury hearing room, and holding cells adjacent to trial courtrooms without passing or entering public or restricted spaces.

Life Safety Systems

Life safety protection systems and emergency egress requirements are prescribed by standards found in [GSA PBS P-100](#) and local and international building, fire, and electrical codes. A fire and life safety system should be equipped with an emergency evacuation system (EVAC) regardless of the number of occupants or floors. The EVAC alerts building occupants to an emergency and instructs them as to what action to take using both voice commands and prerecorded evacuation instructions. Access to the system should be located in the USMS command and control center as well as any fire alarm monitoring stations. The components of an EVAC that are designed and tested for this are listed by Underwriters Laboratories (UL). The EVAC installed should have components that can survive an emergency situation. Life safety and security systems should be examined closely to ensure that the systems do not conflict. To coordinate security and fire-prevention measures, the design team should consult with the USMS, FPS, and the GSA regional fire protection engineer.

Emergency exit doors should open into the public entrance area under surveillance by security personnel. The public entrance area should also be designed as an exit corridor. Emergency exit doors into the lobby should not be used for normal public circulation. Emergency doors should be self-locking and equipped with either a local or remote alarm at the USMS command and control center. An interior CCV camera, monitored by the USMS command and control center, should be provided. Where permissible and as per code, emergency exits should be equipped with magnetic locks connected to delayed egress hardware or the fire alarm/sprinkler system. Electric locking systems on all doors should be connected to battery-backup power and connected to emergency generators, preferably in a security closet on each floor. The systems should remain locked during a power failure.

Security Alarms

Intrusion Detection Systems (IDS)

The first line of protection is typically the responsibility of the FPS and is accomplished through the installation of building intrusion-detection and locking systems. The USMS

installs security systems on any vault or secure room in the clerk’s office, USMS, and other court-related offices. Interior intrusion alarms should be incorporated into the USMS security system and/or FPS perimeter intrusion-detection system. In some cases, these two systems can be combined and linked off-site to more than one location.

Duress Alarm Devices

Duress alarm devices are installed as specified in USMS Publication 64 for courtrooms, libraries, judicial and court-related offices, judges’ parking areas, and other site and building locations.

Courtrooms

Entry

All public entrances should be provided with key locks. Each courtroom should be keyed separately with a submaster. Doors from restricted circulation, excluding fire exits, should have free access from restricted circulation and have PACS card readers on the courtroom side. PACS card readers will be installed on both sides of the courtroom doors where a restricted hallway serves multiple courtrooms.

Emergency Lighting

Emergency lighting in courtrooms should be provided to permit orderly evacuation in the event of an emergency. Selected lighting fixtures within the courtroom should provide an uninterrupted source of lighting in the event of a power outage. Standby power for emergency lighting to the courtrooms should be provided by local battery-backup units connected to an emergency generator. The judge’s bench should not be spotlighted by emergency lighting. Key switches should be provided in restricted corridors for testing on a regular basis.

CCV

Courtroom security cameras should be connected to the USMS video surveillance system. The security camera and courtroom audio may be connected to the central cell block for monitoring by defendants who are removed from the courtroom and placed in an isolation cell. All courtrooms should be equipped with cameras to enable USMS personnel and CSOs to monitor from the USMS command and control center activity that occurs in the well of the courtroom and at the point of judge’s ingress and egress. Conduits for CCV should be installed in all four corners of all courtrooms to accommodate current and future camera installation. Where cameras are installed, recessed housings should be provided for cameras in the wall or ceiling. Cameras should be positioned to prevent room lighting from interfering with the view or picture quality.

Ballistic-Resistant Material

The judge’s bench and courtroom deputy clerk station should be lined with ballistic-resistant material (UL Standard 752, Level III) on all vertical surfaces. The lifespan of the ballistic resistant material is approximately 10-12 years, after which the material will require replacement.

Duress Alarm Devices

Duress alarm devices should be located at the judge’s bench and courtroom deputy clerk station per USMS Publication 64. In appellate panel courtrooms, the center position of the panel should be equipped with the alarm button. Additional bench locations for alarms should be provided in en banc courtrooms. Alarms are to be connected to the USMS command and control center. All duress alarm devices in a courtroom should report as a single zone.

Weapons Screening

For trials requiring a high level of security, spectators entering the courtroom are subject to additional weapons screening. Two 20-amp, 120-volt alternating current outlets connected to the emergency generator should be located outside each courtroom. Therefore, equipment should be provided to detect firearms, bombs, and other weapons at the entrance to the spectator area from the public lobby, as described in USMS Publication 64.

Emergency Egress Doors

Public egress paths from the courtroom should be primarily through public circulation. If secondary egress is through restricted circulation, doors should be equipped with a delayed egress device interfaced with the fire alarm system. Emergency egress doors, used by judges, should have free access from restricted circulation and a key lock or electronic access control on the courtroom side.

Associated Courtroom Spaces

Entry

The judges’ conference room, robing room, and conference/robing room should have key locks or be equipped with PACS. Electronic locks should be fail-secure.

Duress Alarm Devices

The judges’ conference room, robing room, and conference/robing room should each have at least one duress alarm device. The duress alarm devices should be connected to the USMS command and control center.

CCV

A CCV camera should be provided for the public lobby areas outside each courtroom and connected to the USMS command and control center.

Judges’ Chambers Suites

Entry

An audiovisual intercom and electric door strike should be provided at the visitor entry door to restricted circulation and at the chambers suite entrance. The system should be monitored and controlled from the judicial assistant’s workstation and from one of the law clerk offices in the suite. Electronically-controlled entry doors should be fail-secure and connected to emergency backup power at designated locations.

Duress Alarm Devices

Duress alarm devices should be installed in the chambers suite under the staff person's desk that is positioned closest to the chambers entrance, judge's desk, and one law clerk's desk, with all three reporting as a single zone to the USMS command and control center.

Windows

Ballistic¹-resistant glazing (UL Standard 752, Level IV), may be considered for a judge's private office within the exterior windows of judges' chambers suites after full disclosure has been made to the court of the relevant risks, inconsistencies, costs and alternatives including, but not limited to the following:

- The risk and inconsistency with applicable blast criteria arising from the fact that ballistic resistant glazing may turn into a lethal projectile in the event of a blast.
- Emergency workers may find it difficult to break through ballistic resistant glazing during rescue efforts.
- The necessity of factoring the costs associated with structural reinforcements and materials to support ballistic resistant glazing into the overall project cost.
- The fact that windows with ballistic resistant glazing may appear different from standard windows and thereby creates a security risk by identifying a target.
- The likelihood that windows with ballistic resistant glazing will not be operable except for maintenance purposes.
- The finding by security experts that keeping a target from view, using window-coverings, architectural features, and other low-cost measures is often the most effective deterrent to a targeted on-site attack.
- The decision to install ballistic resistant glazing is subject to project funding availability.

Jury Facilities

Duress Alarm Devices

A duress alarm device should be provided at the jury check-in counter, located in the jury assembly area, and at the trial jury and grand jury suite security workstations. To enhance security and privacy in the trial jury and grand jury suites, a court security officer, deputy marshal, or sworn-jury custodian is often stationed at the entrance. A duress alarm should be provided at each security station.

Court Libraries

Entry

The public entrance to the library should be provided with a key lock. A key lock or electronic access control from the library to restricted circulation should also be provided.

¹ Ballistic glazing requirements approved by JCUS September 15, 2009.

Duress Alarm Devices

The circulation desk, library staff offices, and study areas in unstaffed libraries should be provided with duress alarm devices.

Clerk's Office (U.S. Court of Appeals, U.S. District Court, and U.S. Bankruptcy Court)

Entry

Public entrances to clerks' offices should be provided with key locks. Public access to restricted office areas is controlled with an electric lock operated at the public counter workstation. Employee access from public circulation should be controlled by key lock or PACS. Access from the clerk's office to restricted circulation, if provided, should be controlled by key lock or PACS.

Vaults

Evidence and financial vaults in the clerk's office should have keypad shunts, vault door contacts, motion detectors, and duress alarm devices monitored by the USMS command and control center.

Duress Alarm Devices

The clerk's private office, as well as the staff side of the public counter, secure storage, vaults, and other selected office areas, should be equipped with duress alarm devices. The alarms should be logically zoned and connected to the USMS command and control center.

Break-Resistant and Ballistic-Resistant Shielding

Clerks' offices located in facilities where weapons are screened for should have break-resistant (UL Standard 972) transaction windows. Clerks' offices located in facilities where weapons screening is not conducted prior to reaching the public counter should have a public counter with a ballistic-resistant (UL Standard 752, Level III) transaction window.

Ballistic-resistant transaction windows should have bullet-resistant speak-through grills or microphone/speaker systems. Access doors and hardware between the public area and the restricted office area should be ballistic-resistant (UL Standard 752, Level III). In addition, surfaces within 4 feet (1,220 mm) of the counter should have ballistic-resistant surfaces from floor to ceiling and may also include the door into the suite.

Court-Related Offices

Building security requirements are identical for all court-related offices. Although, refer to [Chapter 9, “Probation and Pretrial Services,”](#) for additional security requirements. The criteria below apply to the following:

- Office of the Circuit Executive
- Office of the District Court Executive
- Office of the Bankruptcy Appellate Panel Clerk
- Office of the Senior Staff Attorney
- Office of the Pre-Argument/Conference Attorney
- Office of the Bankruptcy Administrator
- Office of the Federal Public Defender’s trial preparation suite

Entry

The public entrance to court-related offices should be provided with a key lock. If public access to the office areas is restricted, access should be controlled with an electric lock operated at the public counter or reception workstation. Employee access from public circulation should be controlled by key lock or PACS. Access from the court-related offices to restricted circulation, if provided, should be controlled by key lock or PACS. Doors to executive offices, managers’ offices, and enclosed storage rooms should have key locks, except as otherwise noted.

Vaults

Evidence and financial vaults in the clerk’s office should have an IDS keypad, vault door contact, passive infrared detector, and duress alarm device monitored by the USMS command and control center.

Server Rooms and Telecom Closets

Access to all server rooms, tele-data closets, and related spaces should be controlled by key locks and PACS.

Duress Alarm Devices

Duress alarm devices should be placed on the staff side of transaction windows, near the receptionist at the main entrance door, near secure storage, and in other selected areas. Duress alarm devices should also be placed in interview rooms, supervisors’ offices, and offices of probation and pretrial services supervision officers. The duress alarm devices should be logically zoned and be monitored by the USMS command and control center.

Break-Resistant and Ballistic-Resistant Shielding

Court-related offices located in a facility where weapons are screened for should have break-resistant (UL Standard 972) transaction windows. Court-related offices located in a facility where weapons screening is not conducted prior to reaching the public counter should have a public counter with counter-to-ceiling ballistic-resistant (UL Standard 752,

Level III) transaction windows, where required. Access doors and hardware between the public area and the restricted office area should be ballistic-resistant (UL Standard 752, Level III). In addition, surfaces within 4 feet (1,220 mm) of the counter should be ballistic-resistant from floor to ceiling. Where appropriate in the probation and pretrial services offices, a CCV camera, monitor, and intercom can be used to screen visitors before they enter lobby areas.

Central Mail Facilities

Design

Refer to [Chapter 11, “Shared Support Spaces,”](#) and USMS Publication 64. Central mail facilities should be equipped with self-contained negative pressure table top mail opening hoods. These hoods should provide a minimum of HEPA-rated filtration and provide a see-through barrier for the operator to use as protection from contaminants that may be contained in the mail.

Entry/Egress

The entrance should be provided with PACS, an intercom, and an electric strike-controlled door. The back door should remain closed and should be opened only for emergency access by the decontamination team. The PACS should allow all controls to be overridden in an emergency. The door should have a sign that notifies personnel and the public that the door is for emergency access by the decontamination team only.

Duress Alarm

A duress alarm should be easily accessible and visible to all occupants.

CCV

CCV cameras should be installed to have coverage of the entirety of this space. The activation of the duress alarm should send a signal to the USMS command and control center. In a multi-tenant building, this control center may be referred to as the FPS control room. The duress alarm will activate cameras to monitor the activity in the entire area.

Audible Alarm

An audible alarm and a visual signal should be provided to the USMS command and control center when the decontamination tank reaches three-fourths capacity.

[Figures 16.1 through 16.6](#) are provided to identify the locations of security-related devices and equipment in the various courtroom types. Though the detailed design, specification, procurement, and installation of security systems is by the USMS, GSA funds the design and construction of the infrastructure for security systems. The information provided here will allow for the design of conduit and emergency power systems. For security equipment located in other court units, refer to the individual room data sheets located in the appendix for specific security requirements.

Co-tenancy with the Federal Judiciary

Co-tenancy with the federal judiciary can pose serious problems for court security. Some federal agencies, including but not limited to the Internal Revenue Service, Social Security Administration, and U.S. Post Office, attract large numbers of patrons, complicating security screening at building entrances. Additionally, some federal agencies draw disruptive customers, which can increase the danger to court staff and unnecessarily burden USMS staff. Ideally, such agencies would not be located within the same building as a court. In those instances where a court is located in a multi-tenant federal building, the FSC will determine and recommend the appropriate level of building access control, intrusion-detection, and surveillance. GSA and FPS will contract with approved vendors to provide and install it, except in judiciary spaces which would be handled by USMS.

Security Funding

There are several sources of funding for security projects and improvements, depending on the scope and type of project being completed and where the request for the project emanated. Refer to [Table 16.1](#) for additional information.

USMS-Funded Projects

Projects for security systems and equipment devices including PACS, CCV, duress alarms, and entry control packages in court space are funded by the USMS with funds from the court security appropriation transferred to the USMS. The USMS also funds the screening equipment and furnishings for entry screening stations staffed by court security officers and the security of judicial parking. As previously noted, these projects are requested by the USMS judicial security inspector (JSI) through their annual resource request (budget call) process. The annual resource request should be reviewed by the district's CSC before being signed by the chief district judge and submitted to the USMS headquarters. Security projects for the facility perimeter or most shared support spaces in buildings are not part of this process.

FPS Initiated Project

As the security organization for the FSC of most GSA controlled facilities, FPS is responsible for making security countermeasure recommendations to FSCs, including the FSCs of buildings still in design. These security recommendations include the initial installation, periodic improvements, and the cyclical replacement of perimeter CCV systems; IDS; and the screening equipment for entry screening stations that are staffed by FPS contract guards.

The security countermeasure recommendations made by FPS for these types of projects are voted on by the FSC and are funded by all the tenants of the facility based on their

percentage of occupancy. The court unit's share of these costs are paid by the Judiciary Security Division directly to FPS on behalf of the court units in the building. The Judiciary Security Division should be contacted prior to any vote on the implementation of an FPS-implemented security project. FPS's ability to implement projects is based on the availability of funds.

GSA Initiated Security Projects

Like projects initiated by FPS, GSA performs security projects based on countermeasure recommendations contained in facility security assessments (FSAs) conducted by the FSC's security organization (generally FPS). These projects are funded by the tenant agencies based on their percentage of occupancy in the building and paid either through a reimbursable work authorization (RWA) or a rent increase. Security projects conducted by GSA involve improvements to the facility including active vehicle barriers and fences for employee parking lots, passive vehicle barriers for buildings, and blast mitigation film for windows.

Prior to voting on these projects, court representatives should contact the offices responsible for their rent. GSA's ability to conduct security projects is based on funding availability or on the ability of tenant agencies to provide RWAs for projects.

GSA is responsible for the operation and maintenance of certain security devices on federal property including the perimeter lighting, exterior door locks, etc. In new courthouse projects, GSA is responsible for the initial funding and maintenance of entry turnstiles including the attached card reader.

Security Related Projects Funded by Court Units

Under most conditions, local funds cannot be used for funding security-related projects. There are exceptions when projects are for operational convenience and involve the use of equipment normally associated with security. Additional PACS devices (card readers, electric strikes, etc.) on doors within secure, judiciary-occupied spaces that are for operational convenience purposes may be purchased with local funds. Any project to add these devices must be coordinated with the USMS and GSA, and the USMS vendor must be used.

Table 16.1
Security Funding Responsibilities

Project Type	Funded by USMS through resource request (budget call) process	Funded by all tenants through increase in FPS security bill after vote by FSC	Funded by all tenants through increase in GSA rent bill or by tenant issued RWA after vote by FSC	Funded with local court funds
Install, repair, or replacement (including monitor replacement) of chambers entry control package (ECP)	•			
Perimeter fence around employee parking lot			•	
Repair or replacement of perimeter IDS or CCV System		•		
Ballistic resistant transaction window at clerk’s office public counter	•			
Installation of passive vehicle barriers (e.g., bollards or planters)			•	
Installation, repair or replacement of an active vehicle barrier at judicial parking entry	•			
Installation of public address access points in USMS control room			•	
Installation, repair, or replacement of duress alarms in judicial space including chambers, clerk’s offices, or other court units.	•			
Installation of blast mitigation film on windows			•	
Addition of a card reader within clerk’s office				•
Security equipment (CCV, duress, IDS, PACS, etc) for a probation/pretrial office including for relocation or IWI	•			
Ballistic glazing on windows pursuant to the JCUS policy	•			
Installation, repair, or replacement of an active vehicle barrier at employee parking entry			•	
Installation, repair, replacement, and maintenance of PACS in judiciary-occupied space	•			

Figure 16.1
Appellate Panel Courtroom Security Diagram

Legend:

- CR Card Reader
- D Duress Alarm
- I Security Intercom
- ◻◀ CCV Camera
- ◻◻◻ Future CCV Camera
- ⊖ 20 AMP, 120V AC Outlet Connected to Emergency Generator
- ◻◻◻ Portable Walk-Thru Metal Detector
- Bench Armor

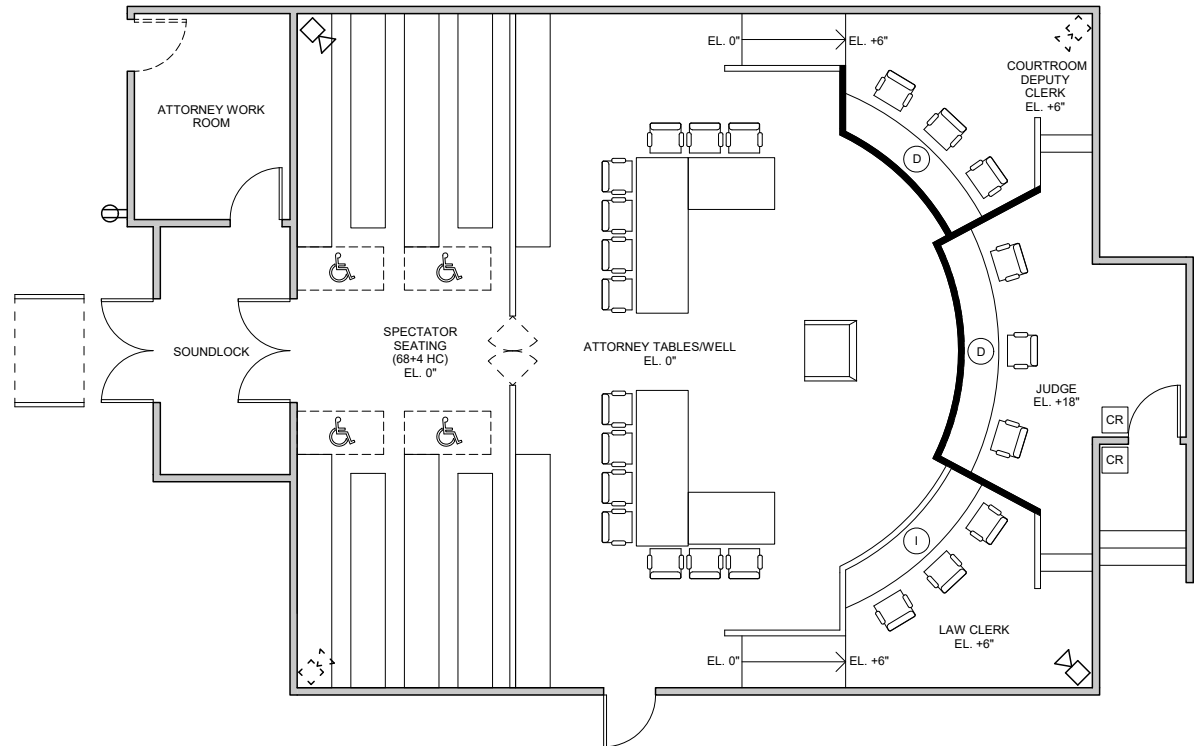

Notes:

1. Provide emergency power/lighting and coordinate lighting with the judge's bench. Judge's bench should not be spotlighted by emergency lighting.

Figure 16.2
Appellate En Banc Courtroom Security Diagram

Legend:

- CR Card Reader
- D Duress Alarm
- I Security Intercom
- ◻◻◻ CCV Camera
- ◻◻◻ Future CCV Camera
- ⊖ 20 AMP, 120V AC Outlet Connected to Emergency Generator
- ◻◻◻ Portable Walk-Thru Metal Detector
- Bench Armor

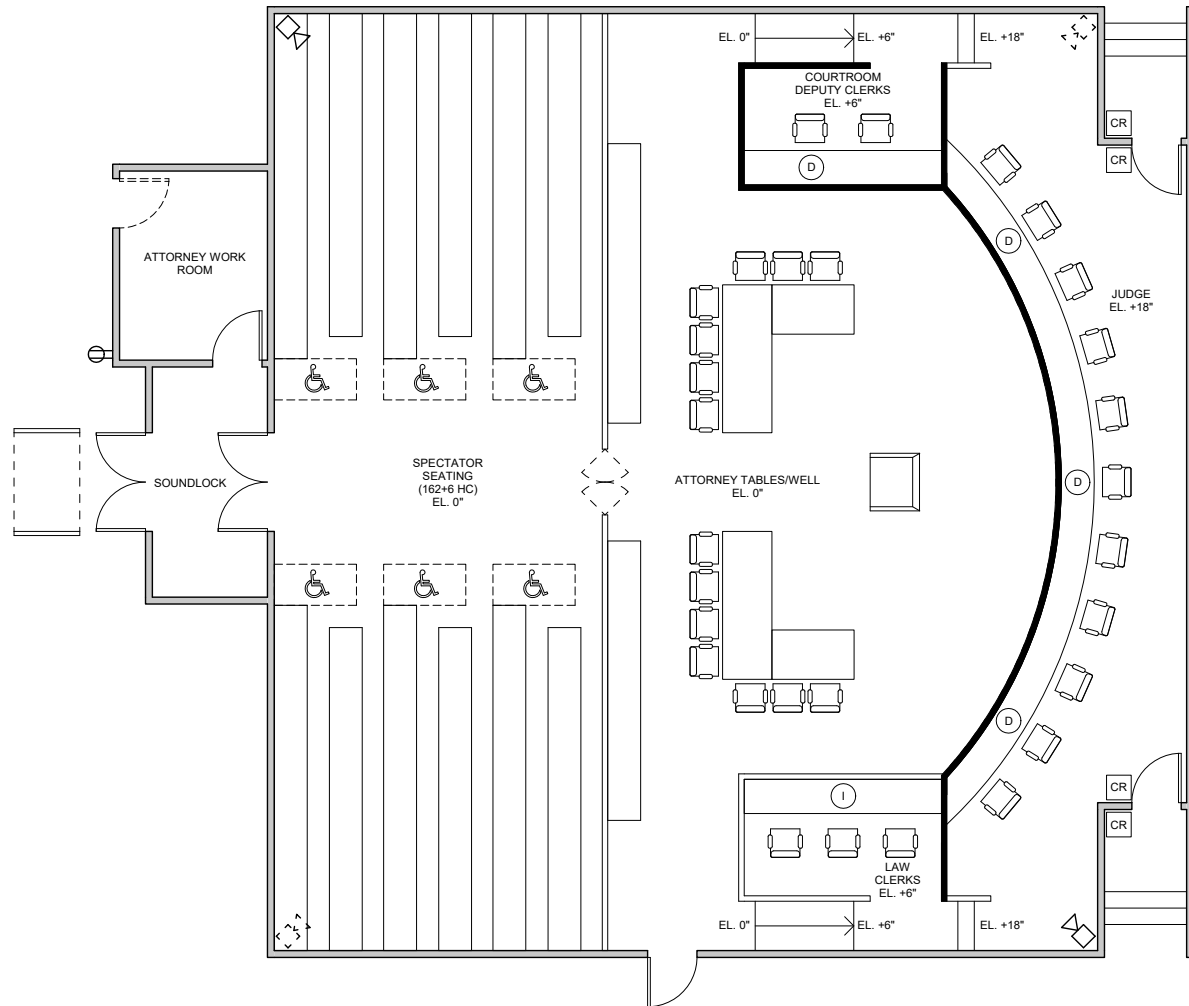

Notes:

1. Provide emergency power/lighting and coordinate lighting with the judge's bench. Judge's bench should not be spotlighted by emergency lighting.

Figure 16.3
Multi-Party Courtroom Security Diagram

Legend:

- CR Card Reader
- D Duress Alarm
- I Security Intercom
- ◀ CCV Camera
- ⌂ Future CCV Camera
- ⊖ 20 AMP, 120V AC Outlet Connected to Emergency Generator
- ▭ Portable Walk-Thru Metal Detector
- Bench Armor

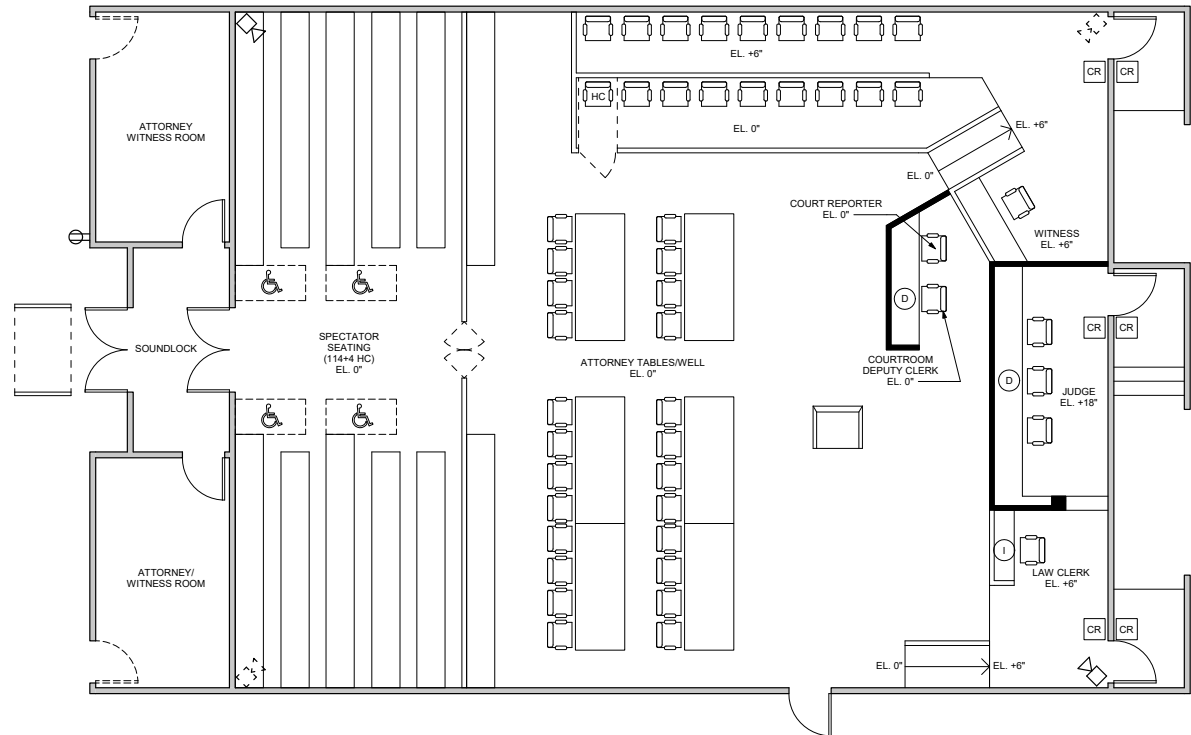









Notes:

1. Provide emergency power/lighting and coordinate lighting with the judge's bench. Judge's bench should not be spotlighted by emergency lighting.
2. USDC courtrooms may provide an audio/video (A/V) link to the cell area for remote viewing of proceedings by the defendant. A typical system may include one courtroom camera (two cameras for a multi-party courtroom) and a link from the courtroom A/V system. Also, in high-threat situations, video may be continuously monitored by the USMS or may be activated by the duress alarm system.

Figure 16.4
District Judge Courtroom Security Diagram

Legend:

-  Card Reader
-  Duress Alarm
-  Security Intercom
-  CCV Camera
-  Future CCV Camera
-  20 AMP, 120V AC
Outlet Connected to
Emergency Generator
-  Portable Walk-Thru
Metal Detector
-  Bench Armor

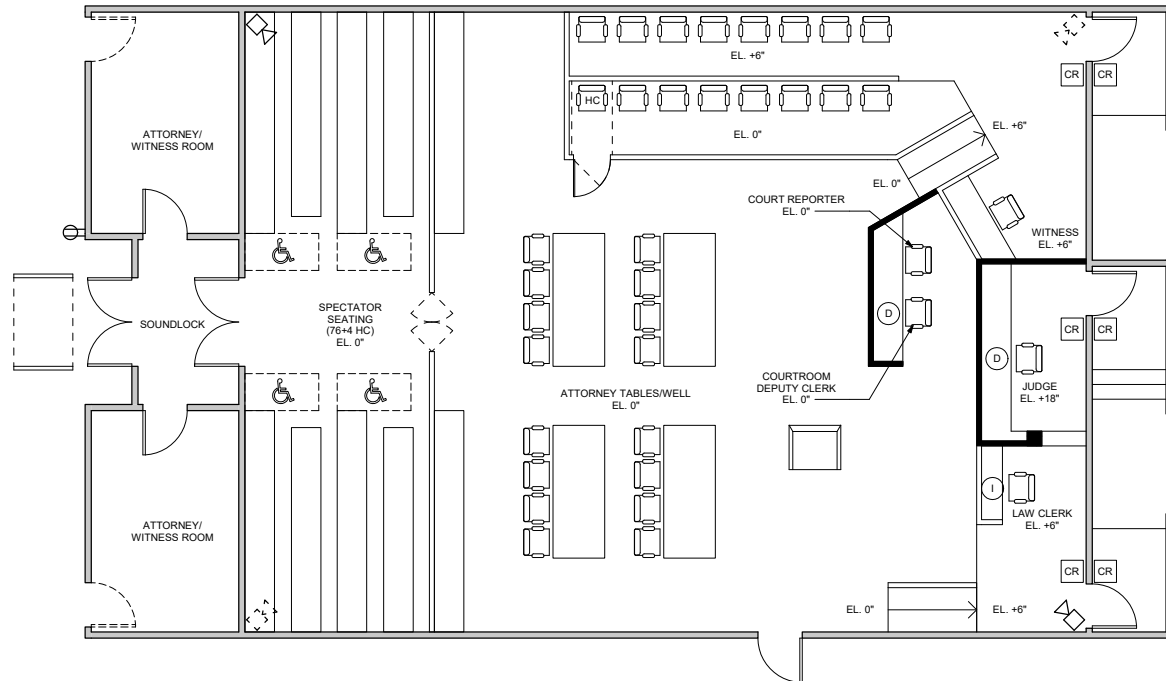

Notes:

1. Provide emergency power/lighting and coordinate lighting with the judge's bench. Judge's bench should not be spotlighted by emergency lighting.
2. USDC courtrooms may provide an audio/video (A/V) link to the cell area for remote viewing of proceedings by the defendant. A typical system may include one courtroom camera (two cameras for a multi-party courtroom) and a link from the courtroom A/V system. Also, in high-threat situations, video may be continuously monitored by the USMS or may be activated by the duress alarm system.

Figure 16.5
Magistrate Judge Courtroom Security Diagram

Legend:

- CR Card Reader
- D Duress Alarm
- I Security Intercom
- ◀ CCV Camera
- ↔ Future CCV Camera
- ⚡ 20 AMP, 120V AC Outlet Connected to Emergency Generator
- ▭ Portable Walk-Thru Metal Detector
- Bench Armor

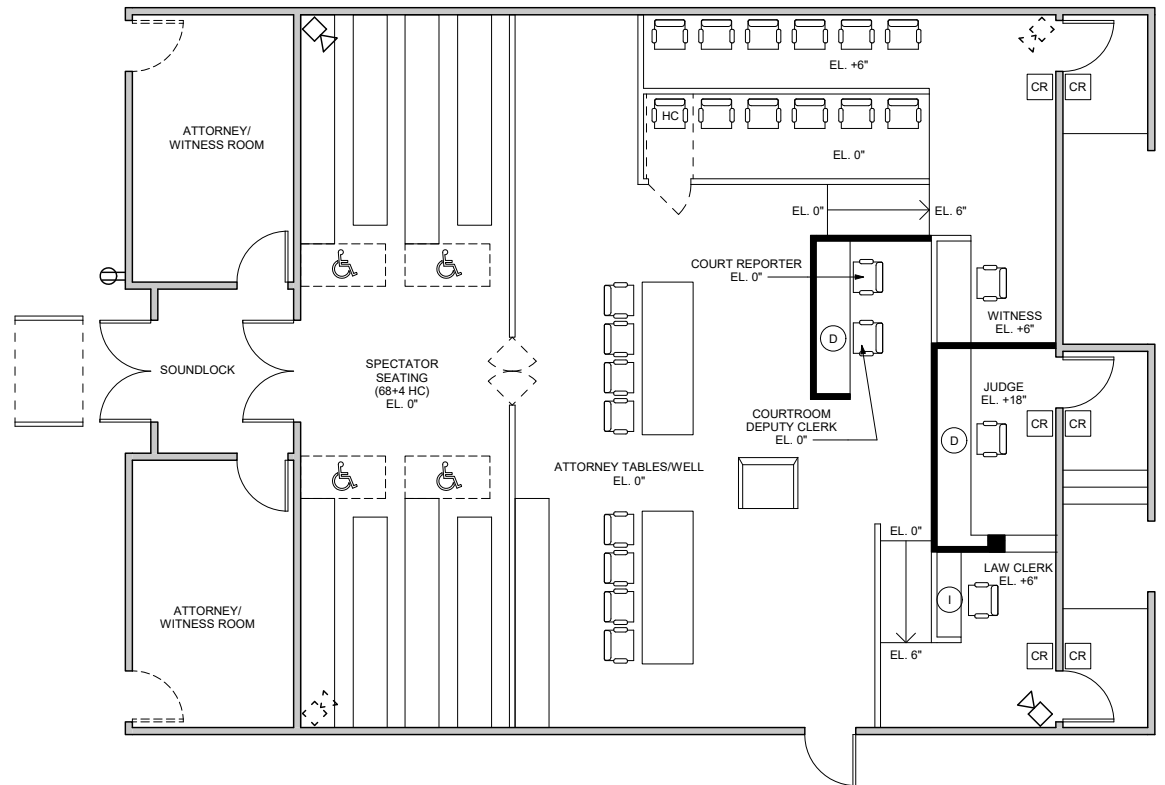

Notes:

1. Provide emergency power/lighting and coordinate lighting with the judge's bench. Judge's bench should not be spotlighted by emergency lighting.
2. USDC courtrooms may provide an audio/video (A/V) link to the cell area for remote viewing of proceedings by the defendant. A typical system may include one courtroom camera (two cameras for a multi-party courtroom) and a link from the courtroom A/V system. Also, in high-threat situations, video may be continuously monitored by the USMS or may be activated by the duress alarm system.

Figure 16.6
Bankruptcy Judge Courtroom Security Diagram

Legend:

- CR Card Reader
- D Duress Alarm
- I Security Intercom
- ◻◀ CCV Camera
- ◻◻◻◻◻ Future CCV Camera
- ⊖ 20 AMP, 120V AC Outlet Connected to Emergency Generator
- ◻◻◻◻◻ Portable Walk-Thru Metal Detector
- Bench Armor

Notes:

1. Provide emergency power/lighting and coordinate lighting with the judge's bench. Judge's bench should not be spotlighted by emergency lighting.

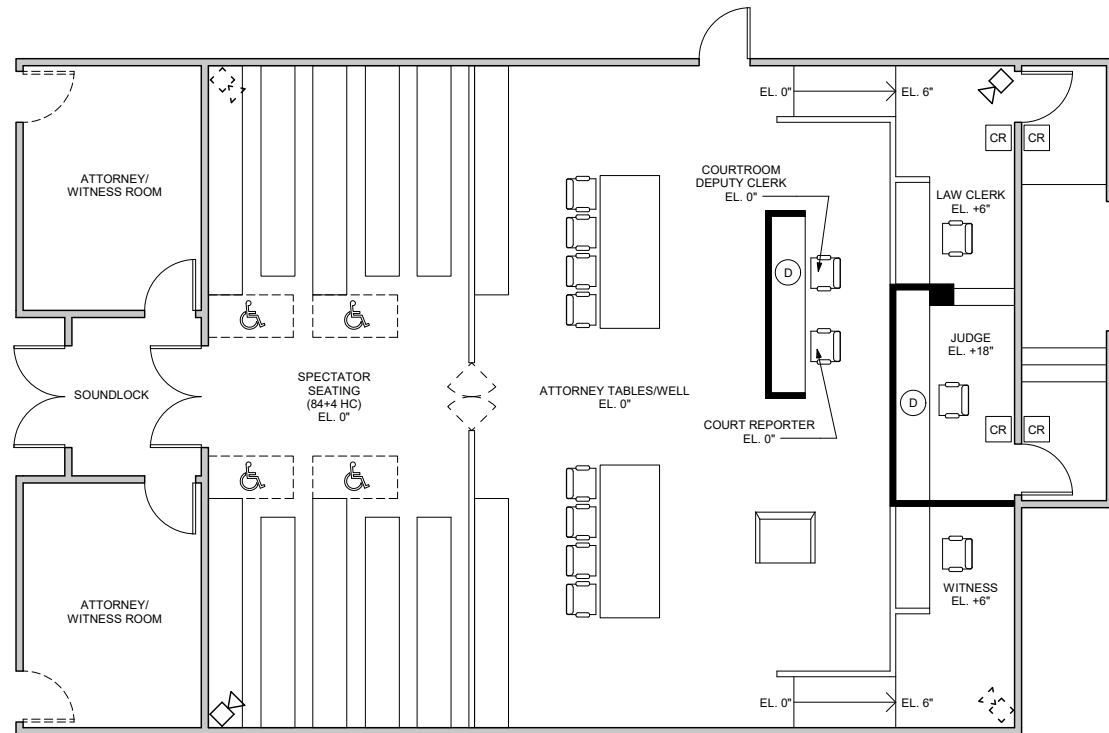



RENOVATIONS AND ALTERATIONS (R&A)

This chapter applies to major and minor renovations and alterations (R&A) in existing courthouses and individual court units that are planned either by the Judiciary or the General Services Administration (GSA). This chapter is intended to be used in conjunction with the other chapters of the *Design Guide* and establishes criteria and requirements for renovation and alteration projects.

Chapter Topics:

- Introduction
- Supporting Documents
- Programming and Budgetary Notes
- Roles and Responsibilities
- Types of R&A Projects
- Considerations and Suggested Actions

Chapter Figures and Tables:

Table 17.1 Funding Responsibilities

Introduction

This chapter has been developed to provide guidance and information for major and minor renovation and alteration projects that are planned either by the Judiciary or by the General Services Administration (GSA). The standards located in the other chapters of the *Design Guide* may not always be achievable in existing buildings. While reasonable effort should be made to meet the functional, operational, and security goals of the *Design Guide* and the *Facilities Standards for the Public Buildings Service (GSA PBS P-100)*, the scope of work will be affected by existing building conditions, availability of funding, and timing. In addition, reasonable effort should be made to address prospective deviations from the *Design Guide* during the scoping of R&A projects. In older buildings, determining the scope for design and construction can be more difficult because of hidden or unknown conditions. GSA and its consultants should conduct a thorough building evaluation assessment/report and any other tests or exploration needed to determine the existing conditions.

It should be noted that the GSA term “repair and alterations” is also termed “R&A.” The Judiciary is not responsible for the “repair” of buildings and therefore, for the purposes outlined in this document, R&A refers to renovation and alteration.

Supporting Documents

A comprehensive guide to supplementary publications can be found in [Chapter 2, “Courthouse Programming and Budgetary Considerations.”](#) That listing includes program and design criteria, courthouse planning and related guidelines, policies, and information on many facets of the design and construction of federal courthouses. The references listed below relate specifically to this chapter.

- [GSA PBS P-100](#)
- [Pricing Desk Guide, GSA Public Building Service \(PBS\), most current edition](#)
- [U.S. Courts Best Practices Guide, most current edition.](#)

Programming and Budgetary Notes

Programming and budgetary notes found throughout the *Design Guide* provide assistance with decisions to be made during the development of courthouse projects. The notes include both judicial branch policy and lessons learned from completed projects. The notes supplement the criteria in the *Design Guide*; their purpose is to provide direction in using the flexibility of the *Design Guide* to develop justifiable and cost-effective federal courthouse projects.

Space Envelope Flexibility

A total space envelope for new space will be calculated using appropriate circulation factors, allowances for support-type spaces, and the space standards described in the *Design Guide*. Courts have the flexibility to configure space within the envelope to meet their local needs. However, design and construction should be in general compliance with the square footage standards designated in the *Design Guide* in the space and ceiling requirements tables. If the court unit wishes to significantly change the space standards described in the space and ceiling requirements tables without exceeding the total envelope of space for the unit, it must seek approval from its respective circuit judicial council.

The space envelope for a respective court unit is defined as:

- Entire clerk’s office
- Entire probation office
- Entire pretrial services office
- Entire staff attorney’s office
- Entire circuit executive’s office
- All courtrooms designated by judge type (circuit judges, district judges, magistrate judges, and bankruptcy judges)
- All chambers designated by judge type (circuit judges, district judges, magistrate judges, and bankruptcy judges)

For existing space, courts have the flexibility to configure space within the existing envelope to meet their local needs. However, any significant departure from the square footage standards designated in the *Design Guide* in the space and ceiling requirements tables must be approved by the respective circuit judicial council. This does not mean that existing space must be changed to meet *Design Guide* standards. Only new construction completed as part of a renovation should be considered.

Renovations and Alterations (R&A)

Many of the construction projects conducted in the Judiciary are renovations to existing space. Although the *Design Guide* applies to these projects, it is understood that some standards in the *Design Guide* are difficult or impossible to achieve in existing space, particularly in historic buildings. Courts should consult this chapter and [GSA PBS P-100](#) for guidance in these circumstances. References to R&A guidelines are also included throughout the *Design Guide* where appropriate.

Exceptions to the *Design Guide* Standards

The *Design Guide* provides guidance on standards for courthouse construction and renovations to existing space. Any significant departure from these standards is considered an exception and must be approved by the respective authority as outlined below.

Authority of the Circuit Judicial Councils

Circuit judicial councils play an important space-management role by reviewing district-wide facility plans, approving requests for new or modified space, and enforcing adherence to design guidelines. The circuit judicial councils have authority over, and responsibility for, a circuit's space-management program (28 USC §332 and §462(b)) and for determining the need for space. As directed by the Judicial Conference of the United States (JCUS), any significant departure from the standards in the *Design Guide* must be approved by the respective circuit judicial council.

Authority of the Committee on Space and Facilities

The authority to approve the following exceptions to the *Design Guide* standards rests with the Committee on Space and Facilities: (1) exceeding the total envelope for either the court unit or the project as a whole, (2) changing the standard configurations for judges' chambers and courtrooms, and (3) exceeding the plumbing standards. If the Committee on Space and Facilities disagrees with a circuit judicial council request for one of these exceptions, the Judicial Conference will decide whether to grant the exception.

Authority of the Judicial Conference

The authority for approving any exception to prospectus-level courthouse projects that would result in additional estimated costs, including additional rent payment obligations, lies with the Judicial Conference. Approval is required, after review by the Committee on Space and Facilities, for any exception to the *Design Guide* approved by a circuit judicial council. The request must include (1) a justification for the exception and (2) a construction cost estimate. [All approved exceptions for prospectus-level projects](#) are reported to the GSA and Congress. Approved exceptions may require the project to be reauthorized by Congress if the exception had not been previously identified. Contact the Administrative Office of the U.S. Courts (AOUSC) for more detailed information.

For prospectus-level courthouse projects, if an exception is approved by the JCUS which would result in additional estimated costs, the chair of the circuit's space and facilities committee or the chief judge or other judge designated by the court that sought the exception that exceeds the *Design Guide* criteria must be willing, if requested by the Committee on Space and Facilities, to appear before Congress concerning funding for such construction.

General Programming Notes

The *Design Guide* is intended to be a performance document. Criteria for any space or grouping of spaces should be considered in conjunction with the specific needs of the court office or function for which space is being designed.

Criteria in the *Design Guide* do not represent space entitlements. The criteria apply to an array of space types that should be justified based on the specific purpose of each project. Facility plans, programs, and designs should include only the space needed to satisfy the

functional and security requirements of the court.

Differences between the space in an existing facility and the criteria in the *Design Guide* are not justification for facility alteration and expansion. In such cases, alternatives to space expansion are investigated before any additional space is requested. In addition, like-for-like space is not a guarantee. Space allocated in an existing location is not justification for the same amount of space in a new location if the space allocation is not warranted. Current needs should be evaluated when moving into new space to determine the appropriate space envelope. Any additional space must be approved by the appropriate authority. Design architects and court staff are prohibited from adding spaces not originally contemplated in the approved prospectus or design program. Increasing the floor area or building volume requires the necessary approvals.

General Budgetary Notes

Renovation and new construction occur when the court and circuit judicial council identify space needs through the Judiciary's asset management planning process and document these needs in the long-range facilities plan. GSA determines by what method the space is provided—for example, by the construction of a new building, the renovation of an existing building, a lease, or other means.

The Judicial Conference recognizes and strongly supports a pragmatic approach to design that includes the use of durable and sustainable materials. This approach ensures that courthouses constructed now will last well into the future.

Following the publication of the *2007 Design Guide*, the Judiciary introduced several cost-saving measures, such as courtroom sharing and the Integrated Workplace Initiative (IWI), that sought to provide flexibility and efficiency in court spaces while preserving the dignity of the Judiciary. Courtroom sharing for certain judge types is now a standard throughout the Judiciary, and IWI is recognized as an alternative to traditional office design. For more information on cost- and space-saving efforts and programs, contact the AOUSC Space and Facilities Division.

Roles and Responsibilities

General Services Administration (GSA)

Generally, any changes or alterations in federal buildings or leased space must be coordinated through GSA. The size and scope of the project will determine which GSA group has the primary responsibility for coordination and oversight. Projects that are primarily finishes (such as carpet and paint) and do not require substantial physical changes are coordinated at the local level by the building manager or service center. Projects that include some physical changes in tenant space, or small amounts of expansion, and require circuit judicial council approval are coordinated with the service

centers or regional offices. It is recommended that these changes are coordinated with United States Marshals Service (USMS) due to associated costs with moving wiring and security equipment contained within walls, ceiling, and beneath floors.

Larger projects that exceed the prospectus threshold and require review by the Office of Management and Budget (OMB), and authorization and appropriation from Congress, are coordinated with the GSA Central Office in Washington D.C., and managed by the GSA regions. The two primary descriptions for major work in existing buildings are modernization projects, in which the entire building is renovated to meet current codes, or repair and alteration projects, which involve selective repair or replacement work (such as mechanical, electrical, plumbing, blast, seismic, fire and life safety, accessibility, or roof work) or a substantial renovation (such as adding new courtrooms and chambers).

The Public Buildings Service (PBS) within GSA is responsible for the construction, maintenance, repair, alteration, operation, and disposal of federal buildings and courthouses. As the federal landlord, GSA assesses and determines the need for periodic repair or replacement of building systems and elements in order to provide federal tenants a safe, secure, and healthy work environment in which to carry out their missions. Funding, however, is not always sufficiently available to cover all building deficiencies or tenant improvements within one project. In addition, unanticipated emergency conditions may develop in which urgent funding measures are necessary.

GSA has the primary responsibility for back-filling vacated or vacant space with federal tenants. When courts are considering or being considered to backfill vacated space, it is important not only to assess the short-term and long-term space requirements, but to also factor in the timing, cost, and rent impact, which the Judiciary must consider for future budgeting purposes.

Local Courts

Local courts are usually contacted by the local GSA regarding GSA-initiated work in the federal building or courthouse. Local GSA offices survey building tenants prior to initiating a prospectus project involving common or joint use space to determine if there is a need for a cafeteria, building fitness center, or shared conference and training rooms. The local courts should notify the circuit executive's office and the AOUSC space staff immediately of planned work that is initiated by GSA. Any planned work should be assessed for rent impact, compliance with judiciary space and security policies, and possible impact on short-term and long-term housing needs.

A recent delegation of authority may allow local courts to contract out minor work such as paint or carpet replacement at limited funding levels. However, compliance with judiciary policies and procedures, GSA pricing policies, and federal procurement and contracting regulations is still required. Consult with the AOUSC for further guidance.

Office of the Circuit Executive

As staff to the circuit judicial council, the Office of the Circuit Executive is responsible for space criteria approvals and certain budget allotments. In some circuits, this role includes delegated responsibility for signing occupancy agreements (OAs) for all space changes, except for major projects which exceed the prospectus threshold and lease-constructs.

Administrative Office of the U.S. Courts (AOUSC)

The AOUSC is responsible for budgeting and funding the rent; reviewing and signing OAs for prospectus projects, lease-constructs and other projects for non-delegated circuits; and assisting courts and circuits with long-range facilities planning, which is used to evaluate short-term and long-term housing needs. The AOUSC also staffs the Judicial Conference Committee on Space and Facilities and the Committee on Judicial Security. Both committees have responsibilities to develop and recommend policy to the Judicial Conference in the areas of space and security.

Types of R&A Projects

Prospectus and Non-Prospectus Projects

Renovation and alteration projects fall into two primary categories: major and minor projects separated by a prospectus threshold¹, an amount set by Congress. If the project cost for federal construction or alteration, or the annual rent for lease-constructs, or alterations in leased space, exceed the applicable threshold, then line item authorization and appropriation from Congress is necessary. This will add significant time to a project, because it will become subject to federal government budget submission cycles. Typically, there are multiple sources of funding for R&A projects depending on the nature of the work. Refer to [Chapter 2, "CRB Program"](#).

Reasons for renovation and alteration projects can involve one or more of the following:

- A recently vacated courthouse is planned to be occupied by another court unit. A court of appeals or bankruptcy court may, for example, move into space vacated by a district court because existing courtrooms and chambers can be used without the need for secure prisoner circulation.
- Additional chambers and/or courtrooms should be provided to accommodate new judgeships, senior judges, or replacement judges.
- A major tenant or multiple tenants have moved out of the building and opportunities might exist for consolidation or more efficient utilization of space.
- A modernization or major repair and alteration project is planned by GSA to address aging building systems, or to upgrade to current standards and codes.

Prospectus projects, or major projects, are those above the prospectus threshold, which are usually funded by GSA through its Federal Buildings Fund (FBF), and must be authorized and appropriated by Congress. Typical major projects include:

- New chamber and courtroom combination(s) or courtroom(s) which include space such as holding cells, attorney conference rooms, jury deliberation suites, etc.
- Modernization or repair and alteration projects initiated by GSA to update and replace aging building systems, upgrade the building to current code, and/or re-stack tenants in the building.
- Backfill of existing vacated federal buildings with other federal tenants. For the Judiciary, a typical example is the court of appeals or the bankruptcy court utilizing space vacated by the district court.

Non-prospectus projects, or minor projects, are projects under the prospectus threshold and can be funded by the Judiciary or GSA pending funding availability. Typically non-prospectus projects include:

- Chambers alterations or build-out of new chambers in existing space
- Courtroom alterations or modifications
- Alterations in existing space for more efficient utilization
- Alterations addressing operational or security deficiencies
- Expansion of court space to accommodate growth
- Cyclical maintenance (e.g., flooring replacement and painting)

¹ The prospectus is a formal document prepared by the GSA which is sent to the OMB and Congress to secure project authorization. It includes project scope information, proposed housing plan, total estimated project costs, funding requested by fiscal year, and schedule. Approval of the prospectus results in authorization resolutions from both the House and Senate that approve the project (whereas an appropriations bill actually funds the project).

Project prospectuses are submitted by the GSA regional offices during the late spring as the GSA begins development of its portion of the President’s budget to be submitted to Congress the following February. The GSA Central Office coordinates and reviews the prospectuses and prepares them for submission to the OMB. Prospectus projects take more time principally because congressional authorization must be secured.

R&A Funding Responsibilities

When the Judiciary initiates work in space that it already occupies and pays rent on, it is responsible for funding any changes to the space. If work is required in new or expansion space on which the Judiciary does not currently pay rent, this is called an initial space acquisition (ISA). ISA tenant improvement projects are typically funded by GSA within certain allowances if funds are available. According to the GSA pricing policy, a general tenant improvement allowance is a dollar amount per usable square foot set to cover the cost of typical office build-out. A customization tenant improvement allowance is intended to cover the difference between a typical or vanilla office space, and the specialized needs of the individual agency. Different agency spaces are assigned a tier level which determines the amount allotted to the customization portion of the tenant improvement allowance. For example, the tier level for a courtroom build-out will be more than the build-out of a probation office. Consult with GSA or judiciary space staff for the most current amounts allotted to the different tier levels.

These tier levels should not be used to estimate a project cost as existing conditions and build-out requirements will vary. When building out new courtrooms and chambers, GSA or the judiciary space staff can provide construction benchmark estimates, which are a more accurate indicator of average costs adjusted to localities for these types of spaces. However, projects in existing buildings will have many different factors, so such benchmarks should not be used as the final estimate since the estimate might not be reasonable. These estimates can be helpful though in determining average costs.

The funding responsibilities for different aspects of R&A projects are summarized in [Table 17.1](#).

Implementation of R&A Projects

Successful projects start with a well-defined scope of work, project delivery approach, and schedule. A typical project development process includes four phases. Refer to [Chapter 2, “Courthouse Programming and Budgetary Considerations”](#) for additional information.

For some non-prospectus projects, these four phases are performed by circuit, district, or local court staff. Depending on the complexity or scope of the project, GSA provides access to a range of architecture/engineering (A/E) firms, specialty consultants, and construction firms, or contractors, who have been previously screened to meet government procurement regulations and performance criteria. They become term contractors under this pre-qualification for indefinite delivery, indefinite quantity (IDIQ) contracts and can provide design and construction services through GSA. The AOUSC Space and Facilities Division also retains a limited number of pre-qualified A/E firms and specialty consultants for limited design and related services for courts when planning facilities projects. Either of these resources can be utilized for a wide range of smaller, non-prospectus projects.

Table 17.1
Funding Responsibilities

Building/Tenant Component	GSA	Judiciary	USMS
Asbestos Remediation	The funding responsibility of asbestos abatement, regardless of agency initiated project, is wholly the responsibility of GSA. Refer to the <i>GSA Pricing Desk Guide</i> .		
Carpet/Paint/Millwork and other related tenant improvement (TI) work	If space is an initial space acquisition (ISA), space that the Judiciary does not currently pay rent on, GSA typically funds (if available) as part of the tenant improvement allowance and the cost is amortized into rent.	If judiciary-initiated and the work is in space the Judiciary already pays rent on, the Judiciary funds lump sum.	
Courtroom Technology - Audiovisual	Infrastructure (conduit, electrical), if part of prospectus projects or ISA.	The design, purchase, and installation of the AV system. Also infrastructure, if the work is in existing space.	
Telecommunications - Voice/Data	Infrastructure, if part of prospectus project or ISA.	The design, purchase, installation of telecommunications equipment, and wiring. Also the infrastructure if the work is in existing space.	
Security	Infrastructure, if part of prospectus project or ISA.		Equipment and installation. Also infrastructure if work is in existing space.
Moves	If the terms of the OA exceed a planned event.	If judiciary-initiated or GSA-planned events (R&A projects that impacts tenants) with sufficient notice from GSA.	
Tenant improvements (TIs) for swing space	Consult with GSA and AOUSC	If judiciary-initiated or GSA-planned events (R&A projects that impacts tenants) with sufficient notice from GSA.	

Courts often have smaller projects in which design and construction expertise, as well as detailed technical information, are also important and necessary. Larger projects benefit from a large group of technical experts. However, smaller projects are often underestimated for complexity and fewer resources are typically assigned. Sufficient time, communication, and cooperation among all parties are key factors for the successful implementation of any project regardless of size.

The *Design Guide* and [GSA PBS P-100](#) are to be used in conjunction when scoping, costing, and implementing an R&A project. The [GSA PBS P-100](#) describes applicable building standards while the *Design Guide* describes the space requirements for the Judiciary. Detailed and specific information such as floor plans, elevations, and specifications are necessary even for smaller projects, in order for the scope of work to be described accurately, documented, appropriately estimated, and built-out satisfactorily. If the scope is poorly defined or not clearly understood, then the construction cost estimate can be inadequate or over-inflated to cover unknown conditions or unnecessary work. A detailed estimate should include line item costs for all building materials and labor, applicable GSA overhead fees, and sufficient information so that over-inflated prices and unnecessary or missing work can be identified.

Considerations and Suggested Actions

Project Planning

When planning an R&A project, there are many important considerations that can impact the success of the effort. The following are examples of issues that typically arise during project planning and execution that can impact the cost and schedule:

Scope of Work

Accurate and complete descriptions using industry standard architectural and construction terms are critical in order for the work to be clearly understood and accurately estimated.

Estimates

Accurate estimates are based on a number of factors: the level of detail describing the scope of work, determination of when work will be completed, limitations on access to site, additional qualifications and specialties needed (e.g., engineering), locality, quantity and availability of pre-qualified contractors, and levels of experience and knowledge of the estimator. Quantities of material and labor should be detailed sufficiently so that the scope of work is thoroughly reflected. Detailed information or explanation should be requested for items that are unclear or appear high in cost. Refer to the [GSA PBS P-120](#) for cost estimating and management requirements.

Procurement

There are different procurement methodologies that can be used by GSA to provide design and construction services. If requested, GSA should explain the different procurement options that are available, along with pros, cons, regulations, and limitations, so that the chosen procurement methodology and timeline are understood.

Security Screening in Federal Buildings

Contractors are required to submit information on all their workers and sub-contractors so that security clearance can be obtained prior to performing any work in a federal building. GSA has the primary responsibility to coordinate this effort. If weekend or off-hours work is requested, then additional fees may be incurred for security personnel to be present during these off-hours. This is paid through security work authorizations (SWAs) to the Federal Protective Service (FPS), and must be budgeted as part of the project.

Coordinating and Scheduling

Communication through status reports and meetings is critical so that responsibilities are defined and understood, schedules are coordinated, security coverage is addressed, affected tenants are notified, progress is reported, and issues are discussed and addressed.

Reimbursable Work Authorizations (RWAs)

RWAs are used to document and transmit funding obligations for services through the GSA. Check current judiciary policies for the different levels of authority for signing funding obligations. For certain budget codes and funding levels, circuit judicial council approval may be required. GSA pricing policies also have regulations and restrictions that must be followed.

GSA Overhead and Fees

All projects, whether funded by RWAs or paid through rent, include GSA overhead or fees which are added to the project cost. The overhead and fees vary in types and amounts depending on the services needed; whether the work is in federally owned space or leased space; whether the work is planned as part of an initial space acquisition or in existing, occupied space; and whether the payment is lump sum via RWA or amortized in the rent. The most common types of fees include the RWA fee and PBS lease fee. On smaller projects in particular, these fees can add a substantial amount to the total cost. Therefore, it is important to understand these fees, what services are expected to be provided, and how they are calculated. Detailed information is available in the *GSA Pricing Desk Guide*; the GSA project manager or coordinator should also provide information to facilitate thorough understanding of the fees and overhead.

USMS

Keep the local USMS informed and involved so that security is coordinated and the court security officers are aware of pending projects and construction activity.

Historic Preservation

Many spaces in the GSA-owned inventory are located in historic buildings. The historic nature of a building may limit the options available to the designer and present challenges in complying fully with *Design Guide* requirements. It is critical to understand the historic nature of the spaces that are included in a project as early as possible in planning.

Design teams undertaking feasibility studies, repairs, alterations, or new construction within or adjoining historic properties should include a historical architect, architectural conservator, or preservation specialist, as applicable, who meets U.S. Department of Interior professional qualification standards and GSA qualification requirements. The performance level to be met within the standards will be determined by the historical architect or preservation specialist, who should be integrally involved in the design and analysis of all alternatives affecting restoration or rehabilitation zones as defined in the building preservation plan or historic structure report. Designs should follow applicable GSA technical guidelines and requirements for historic buildings in [GSA PBS P-100](#).

Feasibility Studies

GSA is responsible for developing feasibility studies which define basic requirements of projects and for examining viable alternatives and estimating costs to determine the best housing solution (preferred alternative) for federal tenants and the best long-term value for the government. For judiciary-generated needs, GSA is notified after circuit judicial council and Judicial Conference approvals to start a more in-depth investigation through a feasibility study, which is required for every prospectus-level project.

Feasibility studies include customer agency programs or operational requirements, building evaluation reports (BERs), seismic reports, security studies (blast and progressive collapse), National Environmental Policy Act (NEPA) studies, and any other studies that support the alternatives. The feasibility study also serves as the primary source of information to support the project in response to inquiries from the OMB and Congress. Therefore, information such as project scope, budget, schedule, implementation strategies, and financial viability are necessary and important in order to produce an accurate feasibility study. Feasibility studies are required for all prospectus-level projects.

Creative solutions should be explored in the feasibility study. Numerous factors will determine the best housing and operational solution for the courts, including:

- Court operations, court unit types, and projected growth
- Condition, age, and capacity of existing buildings
- Site location and expansion capacity and/or availability of adjacent land or property
- Overall housing needs of federal agencies in a particular location
- Market conditions

Project Design and Construction

A simple or small alteration or renovation project can be more complex than originally contemplated or planned. While GSA is ultimately responsible for coordinating and contracting the work, judiciary space staff (local, circuit, or AOUSC) can share their valuable technical expertise, and support.

Projects which are under-scoped and under-estimated often take more time to fix and cost more than originally planned and budgeted. Whether adding a room or a single wall, some of the most commonly overlooked factors when developing the scope include:

Affected Surfaces/Elements

Any changes that touch the ceiling and floors may affect surrounding elements and building systems. Creating a new room or adding a wall can affect the ceiling, light fixture layout, sprinklers, HVAC vents for supply and return air, paint/wall-covering, floor coverings, and possibly fire and life safety codes.

Wall Types

The *Design Guide* provides information about different acoustical criteria for room/wall types based on function, and includes technical information about wall types to obtain these acoustical levels. For example, judges' private offices and conference rooms require higher degree of sound isolation and acoustic privacy. This should be described in industry standard terms and detailed in order to attain the acoustical properties appropriate for the use and user. Uninsulated interior walls that do not extend to the structure above the ceiling provide limited acoustic privacy. Refer to [Chapter 14, "Acoustics,"](#) for strategies to improve isolation when walls cannot extend to deck and for the use of furniture walls.

Acoustics

Acoustical criteria are detailed in [Chapter 14, "Acoustics,"](#) but some projects may not be able to meet these criteria due to historic preservation requirements or other project limitations. Acoustical goals shall be established based on Chapter 14 but adjusted in accordance with the project limitations as directed by an acoustical consultant. For example, sound seals may be added to a historic wooden door when said door cannot be replaced by a sound-rated assembly. Likewise, acoustical finishes shall compliment historic requirements.

Electrical Outlets and Light Fixtures

New outlets and light fixtures should be specifically located so that the electrician can check for capacity at the electrical panels and provide the necessary infrastructure and controls.

Voice/Data or Audiovisual (AV)

Voice/data or audiovisual (AV) cabling and equipment installation are the responsibility of the courts, so coordination with the telecommunications/AV designer and installer, electrician, and contractor is necessary so that infrastructure is planned and provided,

and work is coordinated. Refer to the specific space sections of this guide and the *Courts Technology Audiovisual Infrastructure Standard* for technology requirements.

Heating, Ventilation, and Air Conditioning (HVAC)

Heat load for equipment, particularly for the telecommunications rooms, AV rooms and server rooms that require 24/7 cooling, is important to calculate and design adequate cooling and ventilation. HVAC is important in renovations even beyond needs for dedicated units. Load calculations are important to avoid hot/cold issues or airflow issues that can occur if not addressed even in simple/small projects. Additional performance criteria can be found in the *Design Guide*.

Door Hardware and Locks

Building standards exist, but additional functions such as special locks or card readers may require electrical connections and should be specified up front and, when necessary, coordinated with the USMS.

Furniture and Equipment

The location of furniture and equipment documented on a plan is useful for locating electrical and voice/data outlets, light fixtures, and supply and return vents.

Paint/wall-covering

Changes to a wall or room affect surrounding or connected finishes and patch work can result in unsatisfactory results. Clear delineations, corners, or break-points (angles where walls come together) should be identified on the plans so that existing space is minimally affected by newly built and painted or resurfaced areas.

Carpet and Wall Base

Whenever a wall is demolished or newly built, the existing base and carpet may not be reusable and will likely need to be replaced. If this is not specified early, it may require additional cost later. New floor coverings may not match existing floor coverings and many manufacturers discontinue products.

Fire and Life Safety Codes

Alterations can affect exit routes, exit signs, emergency lighting, smoke/fire alarms, and sprinklers. These are a few examples of critical elements that must be checked by the GSA regional fire protection engineer or the landlord.

Plumbing

If planned work requires plumbing changes, the distance and location of existing plumbing lines will determine the cost and difficulty of providing new plumbing connections.

Floor Loads

Heavy items such as condensed filing systems may require higher levels of floor loading than what exists. Structural analysis will be needed.

Swing Space

Temporary work environments are often necessary to house the operations of a court unit during an R&A project. Court units should look internally at their existing portfolio and externally for swing space so day to day operations are not greatly impacted. Since every court unit has different requirements, consideration in the project funding and schedule should be given to altering swing space prior to occupation.

Other Considerations

Coordination with court operations, egress, and public circulation are items often overlooked.

18

ALTERNATIVE WORKPLACE STRATEGIES

This chapter applies to the following court units: Court of Appeals Clerk’s Office, District Clerk’s Office, Bankruptcy Clerk’s Office, Probation and Pretrial Services Office, Circuit Executive’s Office, Bankruptcy Appellate Panel Clerk’s Office, Senior Staff Attorney’s Office, Pre-Argument/Conference Attorney’s Office, and Bankruptcy Administrator’s Office. It describes alternative workplace strategies that result in the more efficient use of space than traditional office/cubicle layouts and complement a mobile work force, collaborative work environments, and modern information technologies. The use of alternative workplace strategies for court projects is not mandatory but highly recommended.

Chapter Topics:

- Introduction
- Background
- Supporting Documents
- Programming and Budgetary Notes
- Functions and Activities
- Alternative Workplace Strategies Concepts
- Workplace Settings
- Neighborhoods
- Alternative Workplace Strategies Programming and Planning
- Alternative Workplace Strategies Design

Chapter Figures and Tables:

Figure 18.1	Neighborhood Adjacency Diagram
Figure 18.2	Dedicated Individual Workspace - Executive Office
Figure 18.3	Dedicated Individual Workspace - Enclosed Office
Figure 18.4	Dedicated Individual Workspace - Open Workstation
Figure 18.5	Mobile Individual Workspace - Enclosed Office
Figure 18.6	Mobile Individual Workspace - Open Workstation
Figure 18.7	Mobile Individual Workspace - Getaway Booth
Figure 18.8	Mobile Individual Workspace - Touchdown Area
Figure 18.9	Mobile Individual Workspace - Personal Storage Area
Figure 18.10	Collaborative Workspace - Training Room
Figure 18.11	Collaborative Workspace - Conference Room
Figure 18.12	Collaborative Workspace - Huddle Area
Figure 18.13	Collaborative Workspace - Work Lounge
Figure 18.14	Modular Design Example
Table 18.1	Alternative Workplace Strategies: Workplace Setting Space Standards
Table 18.2	Alternative Workplace Strategies: Referenced Space Standards

Introduction

Space programming and design of alternative workplace strategies (AWS) differ significantly from the prescriptive approach described in other chapters of the *Design Guide*. Alternative workplace strategies tailor work settings to work modes of staff instead of providing a dedicated office or workstation for each staff member. Alternative workplace strategies create quality workplace environments that are flexible and efficient. These are important characteristics for courts to consider given the limited resources the Judiciary has for rent and related operational costs.

Although space and rent reduction are major drivers for the Judiciary's inclusion of alternative workplace strategies in its *Design Guide*, an equally important reason is the need to update facilities to support a technically adept and mobile workforce. New technologies, such as videoconferencing, cloud computing, wireless local area network (WLAN), smart phones, touch-screen tablets, and electronic records management all have empowered and liberated employees to work in new ways and be more productive than ever. The use of new technologies and a workplace designed to enhance collaboration is essential to better support operations. Technology has created exciting opportunities to reimagine and open the traditional workplace.

It is important to emphasize that implementing AWS has implications beyond space. It is a new way of managing space that also requires a perception change among employees over ownership of personal and shared space. The implementation of desk-sharing and increased telework programs are necessary components that go side by side in a successful AWS workplace.

Employees also need to consider how to conduct work in the most productive way using the wider choices of spaces and workplace technology provisions given to them. Many tasks that have traditionally been done in the office can be done remotely using the new technology described above. Offices with staff that frequently travel or perform field work, such as probation supervision officers, can readily incorporate alternative workplace strategies.

When implementing an AWS workplace, the stakeholders determine the degree of implementation based on the nature of the work being conducted and the regional and office culture. In order to best facilitate this process, it is important that consideration for AWS be discussed at the very beginning of the project. The Administrative Office of the U.S. Courts (AOUSC) has additional reference materials related to AWS, success case studies, and organizational change management resources to help court leaders, managers, and employees make informed decisions and successfully transition into an AWS environment – refer to the Supporting Documents section that follows.

Background

Since the mid 1990s, the Judiciary has implemented a series of initiatives to limit space and rent growth, cognizant of the impact ever-increasing rent has on the ability to hire and retain staff. Those efforts have achieved significant gains, but more is needed given the realities of decreasing congressional appropriations.

In September 2013, the Judicial Conference of the United States (JCUS) endorsed policy that caps space growth, sets goals for space reduction, and establishes a framework for space management. The policy continues the trend of standardizing space management that began with the circuit judicial council.

The development of alternative workplace strategies is an outgrowth of the Judiciary's Integrated Workplace Initiative (IWI), a program that began in 2011 with the goal of identifying innovative management, technology, and space planning to better support court operations. It is both an opportunity to align the workplace to how modern-day employees desire to work, and a way to efficiently manage cost associated with rent escalation. The IWI serves as a foundation for alternative workplace strategies, referencing data from surveys of over 3,000 court employees from 25 district/circuit courts and proof-of-concept studies for a variety of court projects.

Supporting Documents

A comprehensive guide to supporting documents can be found in [Chapter 2, "Courthouse Programming and Budgetary Considerations."](#) That listing includes program and design criteria, courthouse planning and related guidelines, policies, and information about many facets of the design and construction of federal courthouses.

Other references are listed below. The following chapters within this *Design Guide* should also be referenced for general planning parameters, design standards for space types not mentioned under this chapter, and for building performance requirements.

U.S. Courts Design Guide

- [Chapter 3: Planning for U.S. Courthouses](#)
- [Chapter 8: Clerk's Office](#)
- [Chapter 9: Probation and Pretrial Services Offices](#)
- [Chapter 10: Other Court Units](#)
- [Chapter 12: Tenant Improvements and Furnishings](#)
- [Chapter 14: Acoustics](#)
- [Chapter 15: Building Systems](#)

In addition, *Facility Standards for the Public Buildings Service (GSA PBS P-100)* also provides information pertaining to the workplace performance attributes and the requirements. Please reference the following [GSA PBS P-100](#) chapters:

- Chapter 3.7: Workplace Performance Requirements
- Chapter 3.8: Workplace Performance Attributes

Policy

- *No Net New*, by Circuit on an annual basis
- *Three Percent Space (USF) Reduction*, reduction target by the end of FY2018
- *Circuit Space Management Plans*
- *Circuit Rent Budget (CRB)*
- *Guide to Judiciary Policy, Volume 12, Chapter 10: Telework*
- *Guide to Judiciary Policy, Volume 15, Chapter 3, § 330.70: Connecting Wireless Local Area Networks (WLANs) to Private Judiciary Networks*
- *Guide to Judiciary Policy, Volume 16, Chapter 4: Furniture, Appliances, and Related Services*

Tools

- *Circuit Space Management Plan Template Package*
- *Alternative Workplace Strategies - Quick Reference*
- *Work Mode Survey Forms*

Other Resources

- *Integrated Workplace Initiative (IWI) JNET Webpage*
- *Organizational Change Management (OCM) Toolkit*
- *Furniture Blanket Purchase Agreements (BPAs)*
- [GSA, Workplace Utilization and Allocation Benchmark](#)
- [GSA, Leveraging Mobility, Managing Place](#)
- [GSA, The New Federal Workplace](#)
- [GSA, Sound Matters](#)
- [GSA PBS P-100](#)
- U.S. Marshals Service, *Judicial Security Systems Requirements and Specifications, Volume Three*, (USMS Publication 64)

Programming and Budgetary Notes

Programming and budgetary notes found throughout the *Design Guide* provide assistance with decisions to be made during the development of courthouse projects. The notes include both judicial branch policy and lessons learned from completed projects. The notes supplement the criteria in the *Design Guide*; their purpose is to provide direction in

using the flexibility of the *Design Guide* to develop justifiable and cost-effective federal courthouse projects.

Space Envelope Flexibility

A total space envelope for new space will be calculated using appropriate circulation factors, allowances for support-type spaces, and the space standards described in the *Design Guide*. Courts have the flexibility to configure space within the envelope to meet their local needs. However, design and construction should be in general compliance with the square footage standards designated in the *Design Guide* in the space and ceiling requirements tables. If the court unit wishes to significantly change the space standards described in the space and ceiling requirements tables without exceeding the total envelope of space for the unit, it must seek approval from its respective circuit judicial council.

The space envelope for a respective court unit is defined as:

- Entire clerk's office
- Entire probation office
- Entire pretrial services office
- Entire staff attorney's office
- Entire circuit executive's office
- All courtrooms designated by judge type (circuit judges, district judges, magistrate judges, and bankruptcy judges)
- All chambers designated by judge type (circuit judges, district judges, magistrate judges, and bankruptcy judges)

For existing space, courts have the flexibility to configure space within the existing envelope to meet their local needs. However, any significant departure from the square footage standards designated in the *Design Guide* in the space and ceiling requirements tables must be approved by the respective circuit judicial council. This does not mean that existing space must be changed to meet *Design Guide* standards. Only new construction completed as part of a renovation should be considered.

Renovations and Alterations (R&A)

Many of the construction projects conducted in the Judiciary are renovations to existing space. Although the *Design Guide* applies to these projects, it is understood that some standards in the *Design Guide* are difficult or impossible to achieve in existing space, particularly in historic buildings. Courts should consult [Chapter 17, "Renovations and Alterations \(R&A\),"](#) and [GSA PBS P-100](#) for guidance in these circumstances. References to R&A guidelines are also included throughout the *Design Guide* where appropriate.

Exceptions to the *Design Guide* Standards

The *Design Guide* provides guidance on standards for courthouse construction and renovations to existing space. Any significant departure from these standards is considered an exception and must be approved by the respective authority as outlined below.

Authority of the Circuit Judicial Councils

Circuit judicial councils play an important space-management role by reviewing district-wide facility plans, approving requests for new or modified space, and enforcing adherence to design guidelines. The circuit judicial councils have authority over, and responsibility for, a circuit's space-management program (28 USC §332 and §462(b)) and for determining the need for space. As directed by the JCUS, any significant departure from the standards in the *Design Guide* must be approved by the respective circuit judicial council.

Authority of the Committee on Space and Facilities

The authority to approve the following exceptions to the *Design Guide* standards rests with the Committee on Space and Facilities: (1) exceeding the total envelope for either the court unit or the project as a whole, (2) changing the standard configurations for judges' chambers and courtrooms, and (3) exceeding the plumbing standards. If the Committee on Space and Facilities disagrees with a circuit judicial council request for one of these exceptions, the Judicial Conference will decide whether to grant the exception.

Authority of the Judicial Conference

The authority for approving any exception to prospectus-level courthouse projects that would result in additional estimated costs, including additional rent payment obligations, lies with the Judicial Conference. Approval is required, after review by the Committee on Space and Facilities, for any exception to the *Design Guide* approved by a circuit judicial council. The request must include (1) a justification for the exception and (2) a construction cost estimate. [All approved exceptions for prospectus-level projects](#) are reported to the General Services Administration (GSA) and Congress. Approved exceptions may require the project to be reauthorized by Congress if the exception had not been previously identified. Contact the AOUSC for more detailed information.

For prospectus-level courthouse projects, if an exception is approved by the JCUS which would result in additional estimated costs, the chair of the circuit's space and facilities committee or the chief judge or other judge designated by the court that sought the exception that exceeds the *Design Guide* criteria must be willing, if requested by the Committee on Space and Facilities, to appear before Congress concerning funding for such construction.

General Programming Notes

The *Design Guide* is intended to be a performance document. Criteria for any space or grouping of spaces should be considered in conjunction with the specific needs of the court office or function for which space is being designed.

Criteria in the *Design Guide* do not represent space entitlements. The criteria apply to an array of space types that should be justified based on the specific purpose of each project. Facility plans, programs, and designs should include only the space needed to satisfy the functional and security requirements of the court.

Differences between the space in an existing facility and the criteria in the *Design Guide* are not justification for facility alteration and expansion. In such cases, alternatives to space expansion are investigated before any additional space is requested. In addition, like-for-like space is not a guarantee. Space allocated in an existing location is not justification for the same amount of space in a new location if the space allocation is not warranted. Current needs should be evaluated when moving into new space to determine the appropriate space envelope. Any additional space must be approved by the appropriate authority. Design architects and court staff are prohibited from adding spaces not originally contemplated in the approved prospectus or design program. Increasing the floor area or building volume requires the necessary approvals.

General Budgetary Notes

Renovation and new construction occur when the court and circuit judicial council identify space needs through the Judiciary's asset management planning process and document these needs in the long-range facilities plan. GSA determines by what method the space is provided—for example, by the construction of a new building, the renovation of an existing building, a lease, or other means.

The Judicial Conference recognizes and strongly supports a pragmatic approach to design that includes the use of durable and sustainable materials. This approach ensures that courthouses constructed now will last well into the future.

Following the publication of the *2007 Design Guide*, the Judiciary introduced several cost-saving measures, such as courtroom sharing and the Integrated Workplace Initiative (IWI), that sought to provide flexibility and efficiency in court spaces while preserving the dignity of the Judiciary. Courtroom sharing for certain judge types is now a standard throughout the Judiciary, and IWI is recognized as an alternative to traditional office design. For more information on cost- and space-saving efforts and programs, contact the AOUSC Space and Facilities Division.

Functions and Activities

The Judiciary's adoption of new technologies including videoconferencing, cloud computing, WLAN, smart phones, touch-screen tablets, and electronic records management has altered the functions or court unit processes described in Chapters 8, 9, and 10 of the *Design Guide*.

In addition, efforts by the Judiciary to reduce its space footprint and related rent increasingly encourage court units to alter operations to accommodate telework and mobile work within the office.

Alternative Workplace Strategies Concepts

Work Modes

Alternative workplace strategies require analysis of employee work modes to determine the types and quantities of work settings that best support operations. This analysis is conducted through interactive means, such as staff surveys, interviews, focus groups, workshops, and technological means, such as chair or infrared sensors. Determining the amount of time spent in various work modes is important for implementing alternative workplace strategies because the number and types of offices, workstations, conference rooms, etc., depends on hours of occupancy as opposed to number of employees. Work modes can be described in different terms but generally include the following categories:

Focused

Focused work modes include “heads-down” work such as reading, writing, data entry, and filing. Focused work can be accomplished in an enclosed office or open workstation depending on the level of concentration needed for a particular task. Employees primarily assigned focused work and who function independently without hands-on supervision are ideal candidates for mobile work.

Employees that perform focused work but require periodic or frequent supervision may require dedicated offices or workstations.

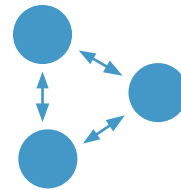

Collaborative

Collaborative work modes include formal and informal meetings of all types, from gatherings of a few employees to large group conferences. Alternative workplace strategies support collaborative work by incorporating space programs with multiple, open and enclosed, small meeting areas as opposed to few, large conference rooms. Large conference and training rooms should be designed to be subdivided with multiple entrances, and reconfigurable tables and seating so they can be subdivided into multiple, small meeting rooms.

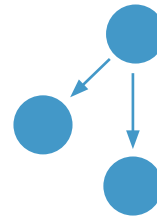

Learning

Learning work modes include individual and small group mentoring, formal classroom-style training, study, and testing. Learning work modes are more prevalent in offices transitioning to and maintaining a mobile- and technology-based business model. Learning work modes can be accomplished in an enclosed office, open workstation, collaborative spaces and specially design training room.

Mobility Scenarios

Mobility scenarios are a convenient way of categorizing and describing the potential for office/workstation sharing. Measuring existing telework and mobile work within the office is a good starting point for determining an appropriate mobility scenario. Changes to policy, management, technology, training, and facilities offer opportunities to implement a more advanced mobility scenario. More advanced mobility scenarios can be used to reduce space or accommodate staff growth within existing facilities.

Low Mobility

- Job requirements necessitate that 80% of staff report to the office daily.
- 20% of staff telework or mobile work within the office 1-2 days a week.

Moderate Mobility

- Job requirements necessitate that 60% of staff report to the office daily.
- 40% of staff telework or mobile work within the office 1-2 days a week.

High Mobility

- Job requirements necessitate that 40% of staff report to the office daily.
- 60% of staff telework or mobile work within the office 2-3 days a week.

Very High Mobility

- Job requirements necessitate that 30% of staff report to the office daily.
- 70% of staff telework or mobile work within the office 3-5 days a week.

Workplace Settings (Refer to Table 18.1)

Workplace settings are spaces designed to accommodate the different work modes used by either mobile or non-mobile staff. They include offices, workstations, conference rooms, and training rooms. They also include spaces unique to alternative workplace strategies design, which are described below:

Dedicated Individual Workspace

Dedicated individual workspace includes enclosed offices and open workstations designed for one or more employees (a shared office) on a full-time basis. The size of dedicated offices and workstations cannot exceed the space standards described in Chapters 8, 9, and 10 of the *Design Guide*. Courts are encouraged to consider reducing the standard size of dedicated offices and workstations when applying alternative workplace strategies. For example, offices may not need to include space for small group meetings if shared meeting rooms are easily accessible and available. Refer to Table 18.1 for full listing of space types and settings, their size specifications, intended user/work modes, and design features.

Mobile Individual Workspace

Mobile individual workspace includes enclosed offices or open workstations shared by multiple employees and used on an as-needed basis. The terms “free addressing” and “touchdown” are commonly used to describe this type of space. Mobile individual workspace differs from dedicated individual workspace in that ownership is not permanent. Mobile individual workspace can be reserved through an electronic concierge system or used on an impromptu, drop-in basis. Mobile individual workspace relies heavily on robust technology provisions, including, WLAN, plug- and-play data connections, and electronic records management. Refer to Table 18.1 for full listing of space types and settings, their size specifications, intended user/work modes, and design features. Below are additional descriptions of new settings that are specifically designed for an alternative workplace.

Getaway Booths

Getaway booths are small, enclosed alcoves for one or two individuals, providing space for tasks that require quiet, concentration, and/or confidentiality. They are used on an impromptu first-come, first-served basis, without reservation. Use is limited to 1-2 hours. Getaway booths are typically outfitted with a desk or table and chair or, as an alternative, with one or two chairs and an occasional table.

Touchdown Areas

Touchdown areas are clustered, open workstations for mobile workers who do not need workspace on a full-time basis. For example, mobile workers can use touchdown areas before or between meetings. Touchdown areas are used on an impromptu first-come, first-serve basis, without reservation for a few hours or few days per week. They can be designed with visual privacy screens and storage.

Personal Storage Areas

Personal storage areas include lockers, cabinets, and/or drawer pedestals for mobile workers. Personal storage areas can be used for work materials or items such as purses, briefcases, coats, etc. Ideally, personal storage areas are located near mobile office space (enclosed offices, open workstations, and touchdown areas). Personal storage areas can be assigned or used on a first-come, first-serve basis.

Collaborative Workspace

Collaborative workspace includes conference rooms, training rooms, and other spaces configured for small or large group activities. Typically, alternative workplace strategies include more and different types of collaborative space than traditional offices to promote general staff interaction, information sharing, and problem solving. Collaborative space can be reserved through an electronic concierge system and equipped with WLAN, plug-and-play data connections, speaker phones, presentation monitors, white boards, and other presentation materials. Refer to Table 18.1 for full listing of space types and settings, their size specifications, intended user/work modes, and design features. Below are additional descriptions to new settings that are specifically designed for an alternative workplace.

Huddle Areas

Huddle areas are meeting spaces for two to five individuals. They are used on an impromptu first-come, first-served basis, without reservation. Use is limited to 1-2 hours. Huddle areas are typically outfitted with a “smart table,” chairs, WLAN, plug-and-play data connections, presentation monitors, and other presentation materials as may be appropriate (white boards, etc.).

Work Lounges

Work lounges serve as a change of scenery for individuals or groups to stimulate ideas and foster collaboration and learning. Work lounges are ideally designed as iconic spaces with attractive features such as exterior views, comfortable furniture, counters with sinks, and break room type appliances to encourage use. Alternative workplace strategies design typically has a higher circulation factor than traditional office designed to accommodate the inclusion of work lounges.

Support Space

Support space standards are described in Chapters 8, 9, and 10 of the *Design Guide*. Support space include reception/waiting areas, records storage areas, copy rooms, staff toilet rooms, and special space specific to probation and pretrial services functions. Although demountable walls are typically used with alternative workplace strategies, security, acoustical, and plumbing requirements may necessitate standard gypsum board walls for reception/waiting areas, interview rooms, toilet rooms, and testing labs. Electronic files can significantly reduce the amount of support space needed for records storage.

Probation/Pretrial Services Interview Rooms

Interview rooms for probation and pretrial services offices should be designed per standards described in [Chapter 9](#), “[Probation and Pretrial Services Offices](#),” and the “[Probation and Pretrial Services Security](#)” chapter in the USMS Publication 64. Demountable wall and door systems, if used, should conform to acoustical requirements in [Chapter 14](#) of the *Design Guide* and be able to accommodate security wiring for duress alarms. Door options should include vision panels. Criteria for the number of interview rooms to provide are listed in [Chapter 9](#) of the *Design Guide*.

Public Space

Public spaces for clerks’ offices are described in [Chapters 8](#) and [10](#) of the *Design Guide*. Public spaces include intake counter, queuing, pay copier, record exam, and public access computer areas. Although demountable walls are typically used with alternative workplace strategies, security and acoustical requirements may necessitate standard gypsum board walls and built-in counters to separate staff space from public space.

Neighborhoods (Refer to [Figure 18.1](#))

A key concept in alternative workplace design is that of neighborhoods: the grouping together of workplace settings to support a variety of work modes, promote internal mobility within the office, and provide flexibility to employees. Although a neighborhood can be configured to support a department, similar to a traditional office, it is most effective when set up to encourage multidisciplinary teamwork and exchange of ideas. The following summarizes neighborhood categories often used in alternative workplace strategies design.

Public Neighborhood

A public neighborhood includes areas where clients and visitors have free or supervised access, such as lobbies, reception rooms, intake areas, record viewing rooms, interview rooms, urinalysis toilet rooms, etc. This neighborhood may be only partially constructed using alternative workplace strategies techniques (demountable walls) due to plumbing, acoustics, and security concerns.

Professional Neighborhood

A professional neighborhood includes dedicated and mobile offices and workstations, touchdown areas, huddle areas, and getaway booths, which support focused and collaborative work modes. It also includes personal storage areas for mobile workers. Professional neighborhoods are configured to encourage staff interaction.

Interactive Neighborhood

An interactive neighborhood includes training rooms, conference rooms, and huddle areas for group activities which support collaborative and learning work modes. It can also include getaway booths for self-paced learning, teleconferences, and video conferences. Informal seating areas should be provided for time before and after meetings. This neighborhood often has direct access to public areas to support sharing with other court units and programs with court clients.

AV technology infrastructure should be provided to support collaborative conferencing microphones, voice amplification audio systems, as needed, bring your own device (BYOD) presentation sources, and interactive displays (portable or fixed).

Informal Neighborhood

An informal neighborhood includes a work lounge, touchdown areas, and getaway booths that provide change-of-scenery workspace which supports focused, collaborative, and learning work modes. The neighborhood also includes service areas with counters and sinks to accommodate coffee and other beverages. Informal neighborhoods are outfitted with café style tables and chairs, booths, and other types of informal furnishings.

AV technology infrastructure should be provided to support collaborative conferencing microphones, voice amplification audio systems, as needed, BYOD presentation sources, and interactive displays (portable or fixed).

Alternative Workplace Strategies Programming and Planning

In addition to the following notes, refer to [Chapter 2](#) and [Chapter 3](#) of this *Design Guide* and the space programming tool (AnyCourt).

Space Standards for Office Personnel

Space standards for office personnel should be allocated according to benchmark occupational groups described in the Judiciary’s *Human Resources Manual* and should not exceed office space requirements described in [Chapters 8](#), [9](#), and [10](#) of the *Design Guide*. Space standards for alternative workplace strategies are listed in [Table 18.1](#).

Baseline Space Program

Court units opting to use alternative workplace strategies can expect to use 20-30 percent less space than that currently occupied. Larger workplaces generally yield better space efficiencies due to economies of scale.

Seat Counts

The maximum number of employees that an office with an alternative workplace strategies design can accommodate is determined by a seat count. Dedicated and mobile offices and workstations typically have a seat count of one. A larger office can have a higher seat count if more than one employee can use it at the same time. Getaway booths, touchdown areas, collaborative space, and work lounges can also contribute to an office's seat count, for example, when all-hands activities are scheduled. Please refer to [Table 18.1](#) for recommendations

Number/Types of Total Individual Spaces

The number/types of office spaces needed should be determined by a work modes survey.

Modularity

Modularity in design allows the space to adapt to the changes in staff and organizational structure well into the future, without the need for frequent major renovations that are costly and disruptive. For example, a 100-square-foot enclosed space can be used as a mobile or dedicated enclosed office, as well as a small conference room. It is recommended to apply this design approach to the following workplace settings.

- 100 net square feet: dedicated enclosed office, mobile enclosed office, conference room for four people, huddle area for four people
- 48 net square feet: dedicated open workstation and mobile open workstation

In both cases above, the work settings can be easily converted and re-purposed with minimal changes to the furnishings and/or without changes. A similar approach can be applied to other types of spaces, wherever relevant. Refer to [Table 18.1](#) for full list of Workplace Settings and [Figure 18.14](#) for a visual example of modular design.

Adjacencies and Circulation

[Chapter 3, "Planning for U.S. Courthouses,"](#) includes interior circulation requirements for traditionally designed (non-mobile) court space. Space programming for alternative workplace strategies includes more circulation space than traditional designs to create an open and spacious workplace environment that accommodates additional collaborative space, and to allow informal meeting space to be incorporated into designs.

While the amount of interior circulation varies with each facility's specific design, up to 60 percent of the net programmed space can be added to determine the total usable area of an alternative workplace strategies project (i.e., the estimated total usable area is equal to the sum of all the net programmed spaces plus 60 percent) provided the usable area calculated for a baseline space program is not exceeded.

Chapters [8](#), [9](#), and [10](#) of the *Design Guide* describe specific adjacency requirements for clerk's offices, probation and pretrial services offices, and other court units discussed in this chapter. Those requirements should be adjusted, to the extent possible given operational realities, to fit the neighborhood concept recommended for alternative workplace strategies. Refer to [Figure 18.1](#).

Sharing of Space

Courts and court units are encouraged to share facilities if operations or security are not compromised. Sharing should especially be considered when courts are collocated in the same building, on the same floor, and in adjacent space. Spaces often shared by court units include training rooms, conference rooms, break rooms, staff toilet rooms, and computer server rooms. Court units implementing alternative workplace strategies may also want to consider sharing space such as reception areas and mobile office space as described above, depending on security and operational conditions.

Alternative Workplace Strategies Design

Alternative workplace strategies design creates an open, spacious environment for all staff by turning traditional workplace design inside out, placing offices in the central core of a floor plan and workstations adjacent to windows. This approach allows natural light to flow through an entire space rather than be blocked by office walls. Workstation partitions are lower than traditional cubicles contributing to natural light and views through a space. Similarly, enclosed offices and collaboration rooms have glass walls to the extent possible.

Demountable Walls

Although metal studs and gypsum board walls may be required in some areas for acoustical, security, and cost implications, most space in an alternative workplace strategies design is defined using demountable walls. Demountable walls are constructed using proprietary framing systems with options such as wall-mounted storage tracks, sliding doors, acoustical insulation, and modular wiring harnesses. They can be clad with a variety of materials including glass, fabric, white board, and wood. Demountable walls can reduce build-out times for new space and provide flexibility for changing operational needs.

Refer to [Chapter 15, "Building Systems,"](#) for all electrical, AV, and telecommunication requirements for demountable wall systems.

Note: The potential impact of light transmission through glass walls and related glare on computer and presentation monitors should be considered when choosing demountable wall cladding materials. In cases where monitors cannot be positioned to avoid glare, cladding with opaque finishes or a combination of opaque finishes and glass should be used.

Finishes

Chapter 12, “[Tenant Improvements and Furnishings](#),” sets quality standards for finishes that can be applied to alternative workplace strategies design. In general, finishes for flooring, ceilings, and gypsum board walls in alternative workplace strategies projects should complement material selections for demountable walls and systems furniture. Flooring should be compatible with the large, open areas in alternative workplace strategies design. Carpet tiles should be used for alternative workplace strategies projects. Broadloom carpeting is impractical for large open spaces and typically needs to be replaced when alterations are made.

Furniture

Chapter 12, “[Tenant Improvements and Furnishings](#),” sets quality standards for furniture that can be applied to alternative workplace strategies design. Furniture for alternative workplace strategies projects should be selected to allow for easy configuration in a variety of spaces and for a variety of purposes. For example, conference and training tables should be movable and connectible to allow collaboration space to be rearranged when necessary. Consider options for integrating new technologies and related electrical needs in applicable desks and tables. Note, in AWS design, more attention should be made to furniture selection—sizes are typically more compact and the intended work modes and mobility scenarios are considered in reviewing the design features. Refer to [Table 18.1](#) for typical AWS furnishing specifications and design features.

Acoustics

Chapter 14, “[Acoustics](#),” sets quality standards for acoustical performance of courthouse space including public waiting areas, probation/pretrial services interview rooms, conference spaces, private offices and open office areas. This chapter outlines strategies and designs to achieve acoustical goals through the use of partial height walls, demountable partitions, glazed partitions, doors and sound masking systems. GSA’s publication, [Sound Matters](#), describes acoustical problems, remedies, and best practice standards for the “contemporary office” or alternative workplace strategies designed project. Sound masking systems should be part of the project design and should be used to augment acoustical properties of demountable walls, doors, and other materials used in an alternative workplace strategies design.

Electrical Distribution Systems

Chapter 15, “[Building Systems](#),” sets quality standards for electrical distribution systems that can be applied to alternative workplace strategies.

Lighting Systems

Chapter 15, “[Building Systems](#),” sets quality standards for lighting systems that can be applied to alternative workplace strategies design. More specific information can be found in Chapter 6, “[Electrical Engineering](#),” in the [GSA PBS P-100](#). For lighting in the individual’s work settings and collaborative space, the luminance at desk height (30 inches above the floor) from fixed luminaries should average a minimum of 30 foot-candles (FC). The luminance at desk height from a combination of fixed luminaries and task lighting should average 45 FC. Task lighting is recommended for systems furniture workstations and other work areas where practical. Lighting levels should be confirmed during design using simulation software.

Voice and Data Communications Systems

Chapter 15, “[Building Systems](#),” sets quality standards for voice and data communications systems that can be applied to alternative workplace strategies design. Demountable walls, systems furniture workstations, and conference tables (“smart tables”) can typically accommodate network wiring and outlet devices. Outlet device faceplates may be proprietary products of partition and furniture manufacturers. Compatibility of faceplates and network wiring should be confirmed by court information technology staff.

Security Systems and Equipment

Chapter 16, “[Building Security](#),” sets quality standards for security systems and equipment that can be applied to alternative workplace strategies design. Demountable walls are not practical in reception and intake areas requiring ballistic-resistant walls, doors, and transaction counters. Systems furniture for reception or intake counters that require break-resistant transaction windows may not be practical due to the weight of window assemblies. The ability to route low voltage security wiring in demountable walls should be confirmed with manufacturer’s technical representatives.

Ceiling Heights

Ceiling heights should comply with standards described in Chapters 8, 9, and 10 of the [Design Guide](#). Ceiling elements such as soffits, perimeter coves, recesses, and reveals should be harmoniously integrated with HVAC ducts, light fixtures, sprinkler lines, and other building utilities. Ceiling designs should complement energy efficient lighting.

Table 18.1
Alternative Workplace Strategies: Workplace Setting Space Standards

Workplace Setting	NSF	Nm ²	User/Work Modes	Design Features	Ref.
Dedicated Individual Workspace					
Executive Office	180	16.7	Office for non-mobile work unit executive or deputy unit executive supporting focused and collaborative work modes.	Use demountable walls and sliding door. Include desk, desk chair, desk return, credenza, wall-mounted storage, task lighting, and table for group meetings of 2-4 people.	Fig. 18.2
Enclosed Office	100	9.3	Office for non-mobile work manager, supervisor, or professional supporting focused and collaborative work modes.	Use demountable walls and sliding door. Include desk, desk chair, desk return, credenza, wall-mounted storage, task lighting, and guest seating for two.	Fig. 18.3
Open Workstation	48	4.5	Workstation for non-mobile work general staff supporting focused work modes.	Include workstation with seated privacy screens, desk chair, storage, task lighting, and optionally guest seating for one.	Fig. 18.4
Mobile Individual Workspace					
Enclosed Office	100	9.3	Office for mobile work manager, supervisor, or professional supporting focused work modes. Use electronic concierge system to reserve.	Use demountable walls and sliding door. Include desk, desk chair, desk return or credenza, storage for personal and work materials brought in daily, and guest seating for 1-2 people.	Fig. 18.5
Open Workstation	48	4.5	Workstation for mobile work general staff supporting focused work modes. Use electronic concierge system to reserve.	Include workstation with seated privacy screens, desk chair, task lighting, and storage for personal and work materials brought in daily.	Fig. 18.6
Getaway Booth	48	4.5	Small enclosed room for mobile work staff supporting focused work modes. Use limited to 1-2 hours.	Use demountable walls and sliding door. Include desk or table, task lighting, and 1-2 chairs.	Fig. 18.7
Touchdown Area	36	3.3	Small workspace for mobile work staff supporting focused and collaborative work modes. Use on a drop-in or ad-hoc basis.	Include work surface, desk chair, task lighting, and storage for personal and work materials brought in daily.	Fig. 18.8
Personal Storage Area	2	0.2	Single or clustered storage unit for mobile work staff. Can be assigned to an individual staff member or used on a drop-in or ad-hoc basis.	Use lockers, storage cabinets, and mobile pedestals with keyless locking hardware (push buttons, dial locks etc.)	Fig. 18.9

Table 18.1

Alternative Workplace Strategies: Workplace Setting Space Standards (cont'd)

Workplace Setting	NSF	Nm ²	User/Work Modes	Design Features	Ref.
Collaborative Workspace					
Training Room	35/seat 200 min.	3.3/seat 18.6 min.	Enclosed, computer or occupation training space supporting learning work modes. Use electronic concierge system to reserve.	Use demountable walls and sliding doors. Large rooms should have folding partitions to subdivide space. Include multimedia lectern, movable training tables with plug-and-play data connections, WLAN, wall-mounted presentation monitors, and light dimming.	Fig. 18.10
Conference Room	25/seat 100 min.	2.3/seat 9.3 min.	Enclosed, meeting space for six or more individuals supporting collaborative work modes. Use electronic concierge system to reserve.	Use demountable walls and sliding doors. Large rooms should have folding partitions to subdivide space. Include movable “smart tables” with plug-and-play data connections, WLAN, wall-mounted presentation monitors, and light dimming.	Fig. 18.11
Huddle Area	100	9.3	Enclosed or open meeting space for 2-5 individuals supporting collaborative work modes. Use limited to 1-2 hours.	Use demountable walls and sliding doors for enclosed huddle room areas. Include “smart table” with plug-and-play data connections, WLAN, wall-mounted presentation monitors, and 2-5 chairs.	Fig. 18.12
Work Lounge	25/seat	2.3/seat	Open, informal space supporting focused and collaborative work modes and lunch/work breaks.	Can include break room type appliances, sink, seated or standing counter space, café style tables, casual seating, and/or booth style seating.	Fig. 18.13

Note: Table 18.1 includes workplace space standards appropriate for alternative workplace strategies planning, based on space programs developed for alternative workplace strategies pilot projects, which may replace standards described in Chapters 8, 9, and 10 of the *Design Guide*.

Table 18.2

Alternative Workplace Strategies: Referenced Space Standards

Support Space (Refer to Chapters 8, 9 and 10)

Table 8.1, Space and Ceiling Requirements for Court of Appeals Clerk's Offices

Table 8.2, Space and Ceiling Requirements for District and Bankruptcy Court Clerk's Offices

Table 9.1, Space and Ceiling Requirements for Probation and Pretrial Services Offices

Table 10.1, Space and Ceiling Requirements for Other Court Offices

- Circuit and District Executive's Offices
- Bankruptcy Appellate Panel Clerk's Offices
- Senior Staff Attorney Offices
- Pre-Argument/Conference Attorney Offices
- Bankruptcy Administrator Offices

Support Space (Refer to Chapters 8 and 10)

Table 8.1, Space and Ceiling Requirements for Court of Appeals Clerk's Offices

Table 8.2, Space and Ceiling Requirements for District and Bankruptcy Court Clerk's Offices

Table 10.1, Space and Ceiling Requirements for Other Court Offices

- Circuit and District Executive's Offices
- Bankruptcy Appellate Panel Clerk's Offices
- Senior Staff Attorney Offices
- Pre-Argument/Conference Attorney Offices
- Bankruptcy Administrator Offices

Note: Table 18.2 includes space standards listed in Chapters 8, 9, and 10 that are applicable to alternative workplace strategies projects for the following workplace settings categories.

Figure 18.1
Neighborhood Adjacency Diagram

Colors Legend:

- Informal Neighborhood
- Professional Neighborhood
- Interactive Neighborhood
- Public Neighborhood

Symbols Legend:

- Public Circulation
- Restricted Circulation
- Circulation Access Control Point

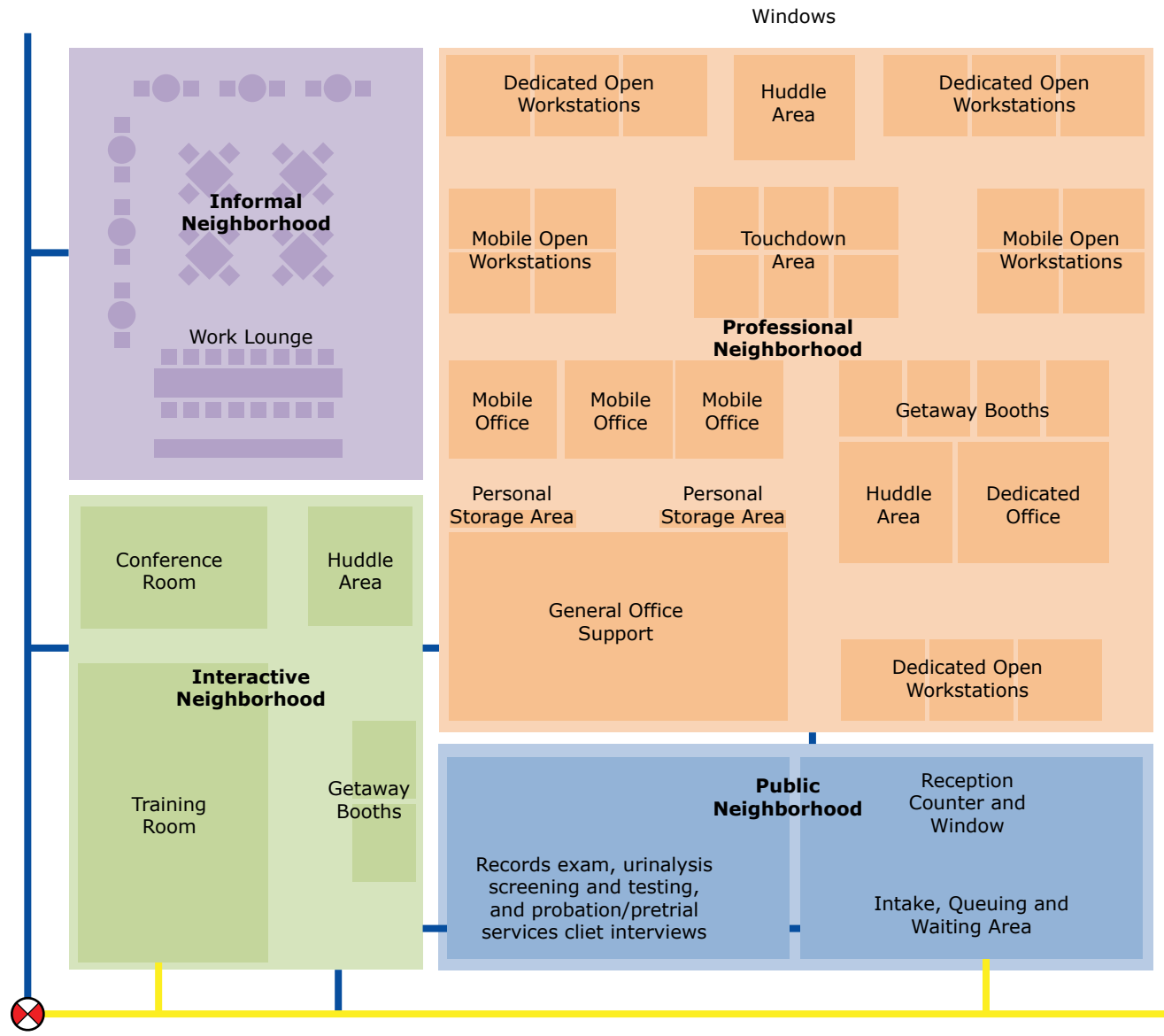

Note: The adjacency diagram is intended only as an illustration.

Figure 18.2

Dedicated Individual Workspace - Executive Office

Executive Office

180 NSF (16.7 Nm²)

Legend:

- ① Demountable Walls
- ② Wall-Mounted Cabinets
- ③ U-Shaped Desk
- ④ Glass Panels
- ⑤ Sliding Door
- ⑥ Collaboration Table

Architectural:

General Requirements:

Security Level: Restricted Access, Direct Access Control/Key Lock
 Adjacent to: Within Professional Neighborhood

Architectural Features:

- Glass Panels with Sliding Door
- Demountable Walls

Fixtures, Furniture, and Equipment (FFE) Options

- (1) U-Shaped Desk or (1) Credenza and Return
- (1) Collaboration Table with (4) Chairs
- (4) Chairs for Guest Seating
- Wall-Mounted Storage Cabinets

Notes:

1. Workplace setting should be compatible with existing conditions and court operations.
 The dimensional layout and furniture placement of the examples on this page can be modified as necessary.

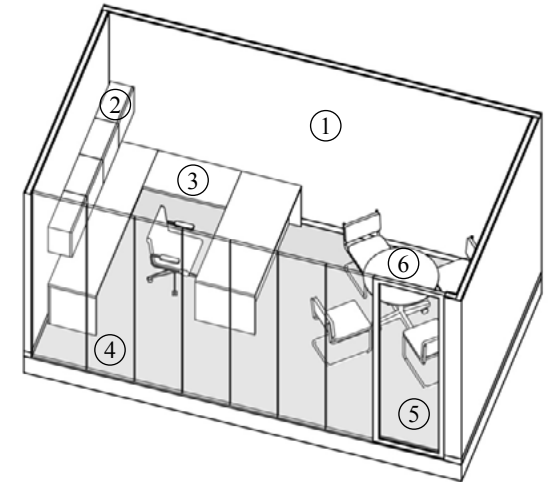

Axonometric Diagram (Example 1)

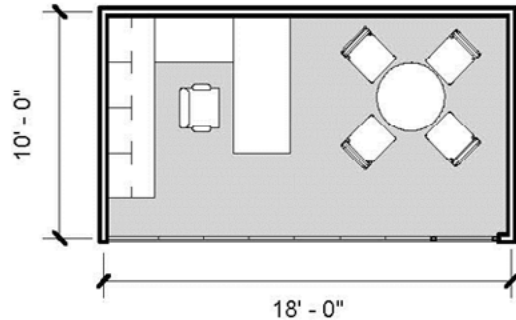

Example 1: U-shaped desk with collaboration table and seating

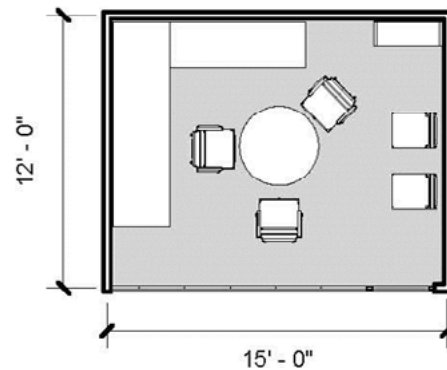

Example 2: Credenza and return with collaboration table and guest seating

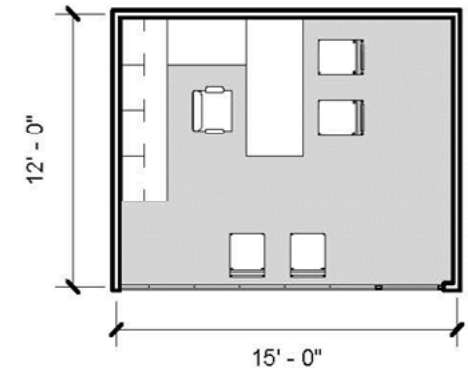

Example 3: U-shaped desk with guest seating

Figure 18.3

Dedicated Individual Workspace - Enclosed Office

Enclosed Office

100 NSF (9.3 Nm²)

Legend:

- ① Demountable Walls
- ② Wall-Mounted Cabinets
- ③ Credenza
- ④ Glass Panels
- ⑤ Sliding Door

Architectural:

General Requirements:

Security Level: Restricted Access, Direct Access Control/Key Lock
 Adjacent to: Within Professional Neighborhood

Architectural Features:

- Glass Panels with Sliding Door
- Demountable Walls

Fixtures, Furniture, and Equipment (FFE) Options

- (1) U-Shaped Desk or (1) Desk with Credenza
- (1) Collaboration Table with (3) Chairs
- (2) Chairs for Guest Seating
- Wall-Mounted Storage Cabinets

Notes:

1. Workplace setting should be compatible with existing conditions and court operations.
 The dimensional layout and furniture placement of the examples on this page can be modified as necessary.

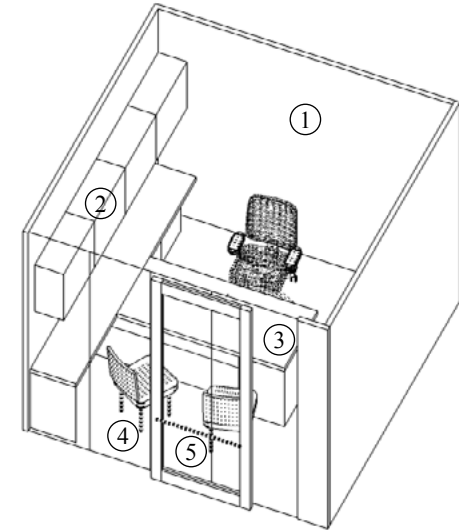

Axonometric Diagram (Example 1)

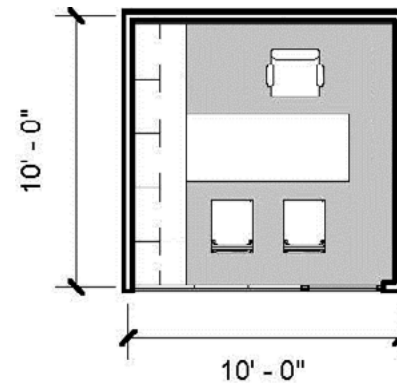

Example 1: Credenza and wall-mounted storage cabinet with guest seating

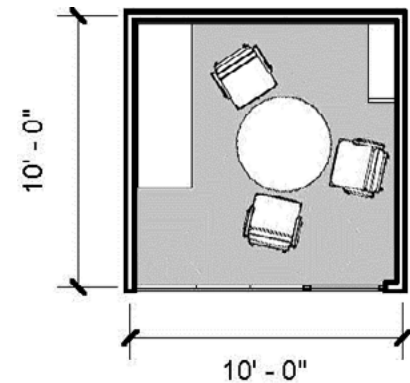

Example 2: Linear desk, round table, small credenza with guest seating

Figure 18.4

Dedicated Individual Workspace - Open Workstation

Open Workstation

48 NSF (4.5 Nm²)

Legend:

- ① Panel Mounted Storage
- ② Guest Seating
- ③ Storage Pedestal
- ④ Privacy Screen

Architectural:

General Requirements:

Security Level: None
Adjacent to: Within Professional Neighborhood

Architectural Features:

- Seated Privacy Screen

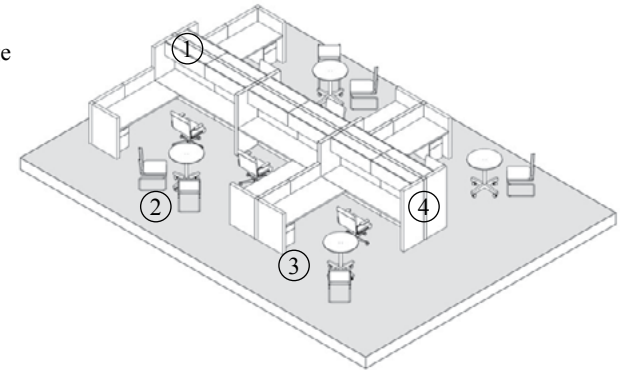

Axonometric Diagram (Example 3)

Fixtures, Furniture, and Equipment (FFE) Options

- (1) Desk Workstation with Bench Seat
- (1) U-Shaped Workstation
- (1) L-Shaped Workstation with Table
- (1) Optional Guest Chairs

Notes:

1. Workplace setting should be compatible with existing conditions and court operations.
The dimensional layout and furniture placement of the examples on this page can be modified as necessary.

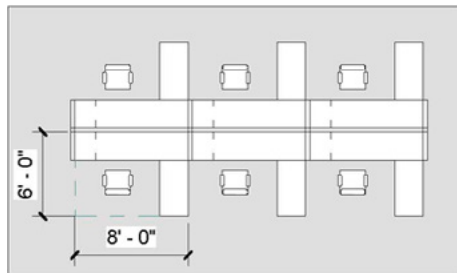

Example 1: Desk workstation with bench seat

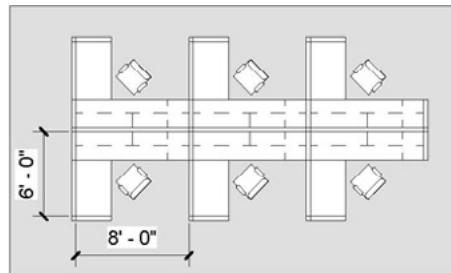

Example 2: L-shaped workstation

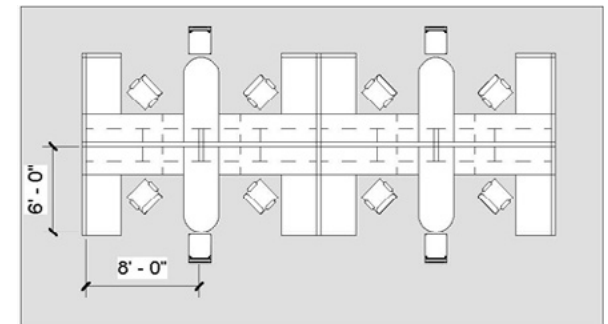

Example 3: U-shaped workstation with guest seat

Figure 18.5

Mobile Individual Workspace - Enclosed Office

Enclosed Office

100 NSF (9.3 Nm²)

Legend:

- ① Demountable Walls
- ② L-Shaped Desk
- ③ Glass Panels
- ④ Sliding Door

Architectural:

General Requirements:

Security Level: Restricted Access, Uncontrolled
 Adjacent to: Within Professional Neighborhood

Architectural Features:

- Glass Panels with Sliding Door
- Demountable Walls

Fixtures, Furniture, and Equipment (FFE) Options

- (1) L-Shaped Desk with (2) Guest Chairs
- (1) Linear Desk, (1) Round Table with (1) Guest Chair
- (1) Small Linear Desk, (1) Round Table with (2) Guest Chairs
- Wall-Mounted Storage Cabinets

Notes:

1. Workplace setting should be compatible with existing conditions and court operations.
 The dimensional layout and furniture placement of the examples on this page can be modified as necessary.

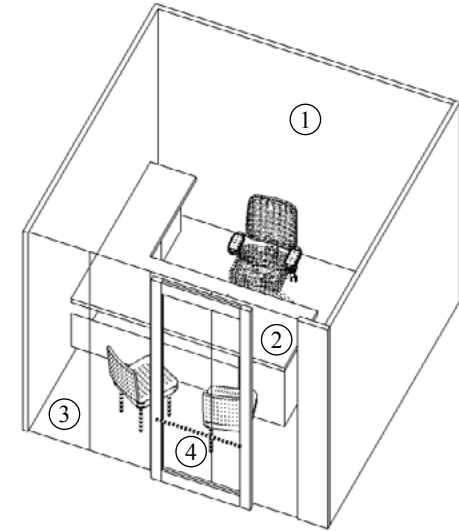

Axonometric Diagram (Example 1)

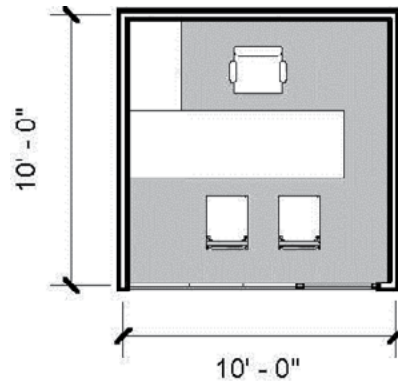

Example 1: L-shaped desk with guest seating

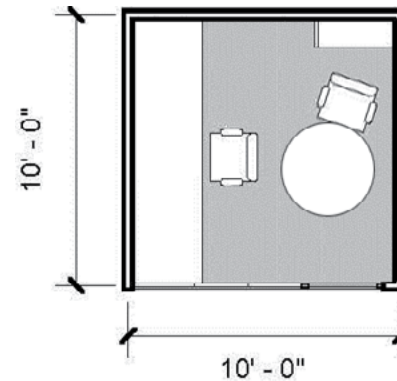

Example 2: Linear desk and round table with guest seating

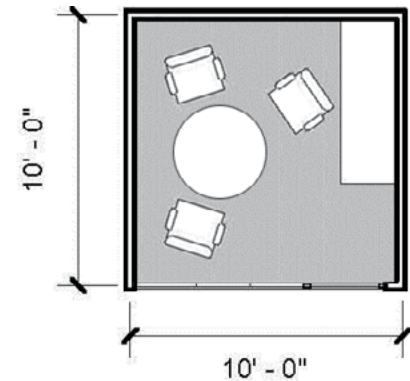

Example 3: Small linear desk and round with guest seating

Figure 18.6

Mobile Individual Workspace - Open Workstation

Open Workstation

48 NSF (4.5 Nm²)

Legend:

- ① Desk Workstation
- ② Bench Seat/Storage
- ③ Storage Pedestal
- ④ Privacy Screen

Architectural:

General Requirements:

Security Level: None
Adjacent to: Within Professional Neighborhood

Architectural Features:

- Seated Privacy Screen

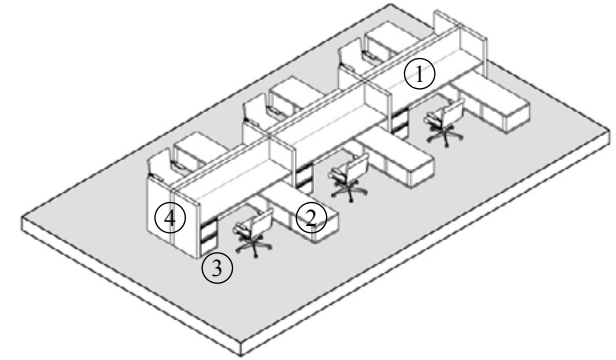

Axonometric Diagram (Example 1)

Fixtures, Furniture, and Equipment (FFE) Options

- (1) Desk Workstation with Bench Seat
- (1) U-Shaped Workstation
- (1) L-Shaped Workstation
- (1) Optional Guest Chairs

Notes:

1. Workplace setting should be compatible with existing conditions and court operations.
The dimensional layout and furniture placement of the examples on this page can be modified as necessary.

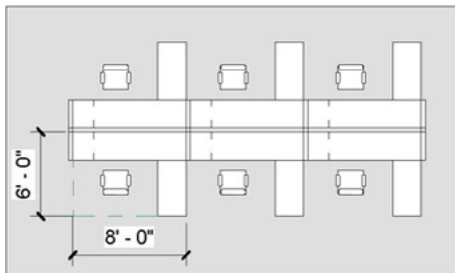

Example 1: Desk workstation with bench seat

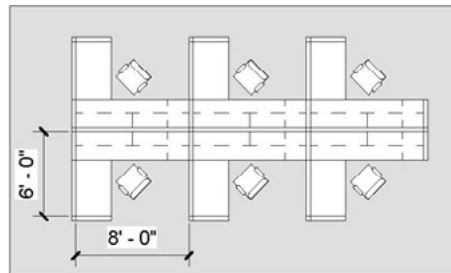

Example 2: L-shaped workstation

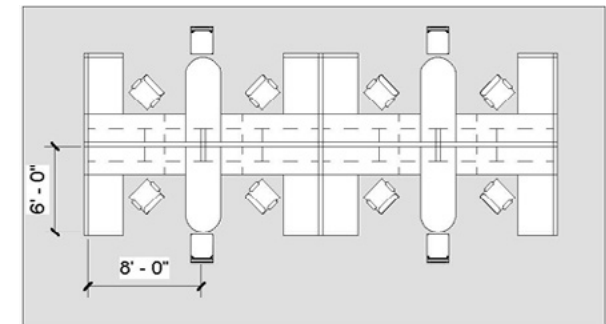

Example 3: U-shaped workstation with guest seat

Figure 18.7

Mobile Individual Workspace - Getaway Booth

Getaway Booth

48 NSF (4.5 Nm²)

Legend:

- ① Demountable Walls
- ② Presentation Monitor
- ③ Movable “Smart” Table
- ④ Glass Panels
- ⑤ Sliding Door

Architectural:

General Requirements:

Security Level: Restricted Access, Uncontrolled
Adjacent to: Within Interactive or Professional Neighborhood

Architectural Features:

- Glass Panels with Sliding Door
- Demountable Walls

Fixtures, Furniture, and Equipment (FFE) Options

- (1) Wall Monitor and (1) Linear Desk with Chair
- (1) Small Table and (2) Chairs
- (1) L-Shaped Desk with Chair

Notes:

1. Workplace setting should be compatible with existing conditions and court operations.
The dimensional layout and furniture placement of the examples on this page can be modified as necessary.

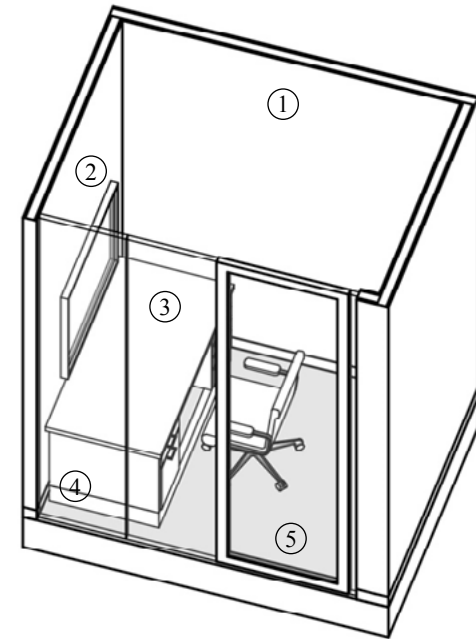

Axonometric Diagram (Example 1)

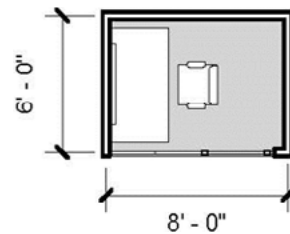

Example 1:
Videoconferencing

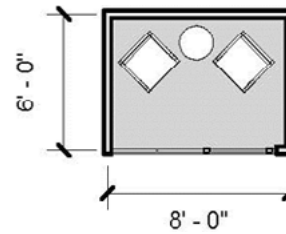

Example 2: Informal
Seating

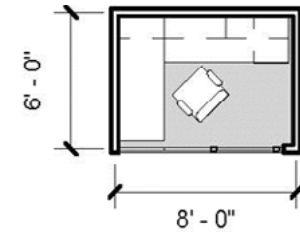

Example 3: L-Shaped
Workstation

Figure 18.8

Mobile Individual Workspace - Touchdown Area

Touchdown Area

36 NSF (3.3 Nm²)

Legend:

① Desk with Storage Pedestals

Architectural:

General Requirements:

Security Level:

None

Adjacent to:

Within Professional Neighborhood

Fixtures, Furniture, and Equipment (FFE) Options

- (1) Round Table with Chair
- (1) 120 Degree Desk with Chair
- (1) Linear Desk with Storage Pedestal in Alcove

Notes:

1. Workplace setting should be compatible with existing conditions and court operations.
The dimensional layout and furniture placement of the examples on this page can be modified as necessary.

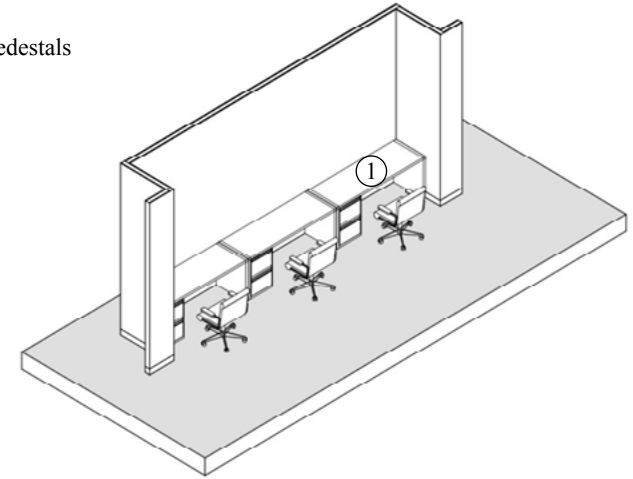

Axonometric Diagram (Example 1)

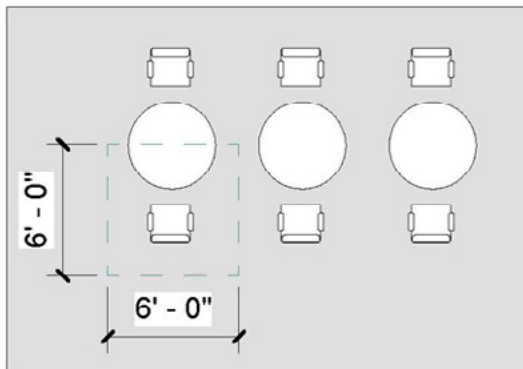

Example 1: Round tables

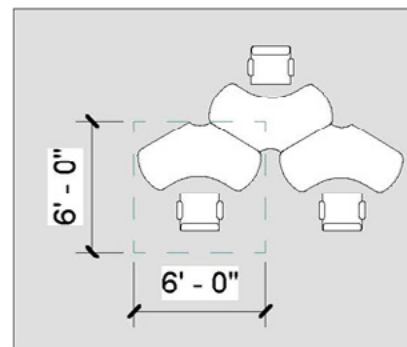

Example 2: 120-degree clusters

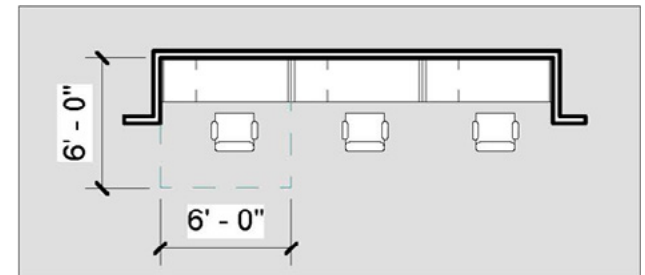

Example 3: Desk in Alcove

Figure 18.9

Mobile Individual Workspace - Personal Storage Area

Personal Storage Area

2 NSF (.2 Nm²)

Legend:

- ① Wall-Mounted Storage
- ② Mobile Storage Pedestals

Architectural:

General Requirements:

Security Level: None
Adjacent to: Within Professional Neighborhood

Fixtures, Furniture, and Equipment (FFE) Options

- Mobile Pedestal Garage
- Double-Stacked Lockers
- 4-High Lateral Files

Notes:

1. Workplace setting should be compatible with existing conditions and court operations. The dimensional layout and furniture placement of the examples on this page can be modified as necessary.

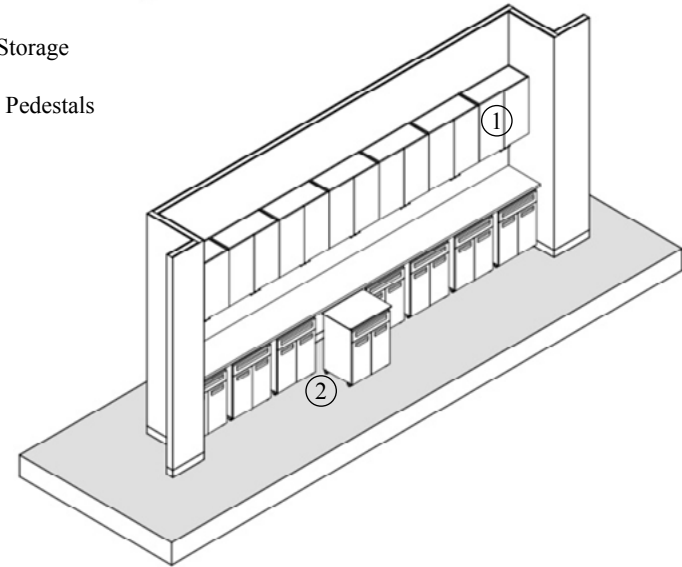

Axonometric Diagram (Example 1)

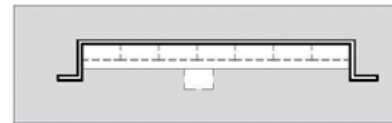

Example 1: Mobile pedestal garage



Example 2: Double-stacked lockers



Example 3: 4-high lateral files

Figure 18.10

Collaborative Workspace - Training Room

Training Room

35 NSF/Seat, 200 min.
(3.3 Nm²/Seat, 18.6 min.)

Architectural:

General Requirements:

Security Level: Restricted Access, Direct Access Control/Key Lock
Adjacent to: Within Interactive Neighborhood

Architectural Features:

- Glass Panels with Sliding Door
- Demountable Walls
- Folding Partition for large spaces

Illumination

- Light dimming

Fixtures, Furniture, and Equipment (FFE)

- (1) Multimedia Lectern
- Movable Training Tables with plug-and-play data connections and WLAN
- Wall-Mounted Presentation Monitors
- Electronic Concierge Touch-Screen Monitor

Notes:

1. Workplace setting should be compatible with existing conditions and court operations. The dimensional layout and furniture placement of the examples on this page can be modified as necessary.

Legend:

- ① Demountable Walls
- ② Presentation Monitor
- ③ Movable Training Table
- ④ Multimedia Lectern
- ⑤ Sliding Door

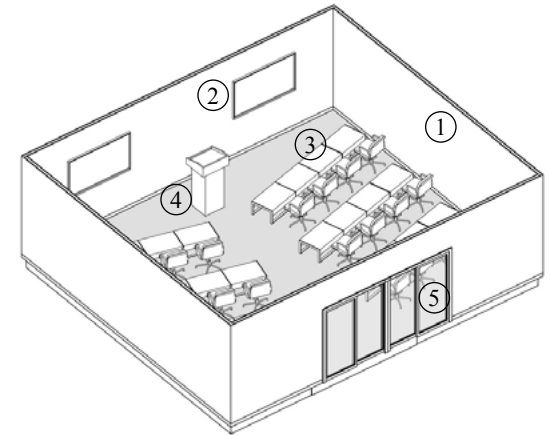

Axonometric Diagram

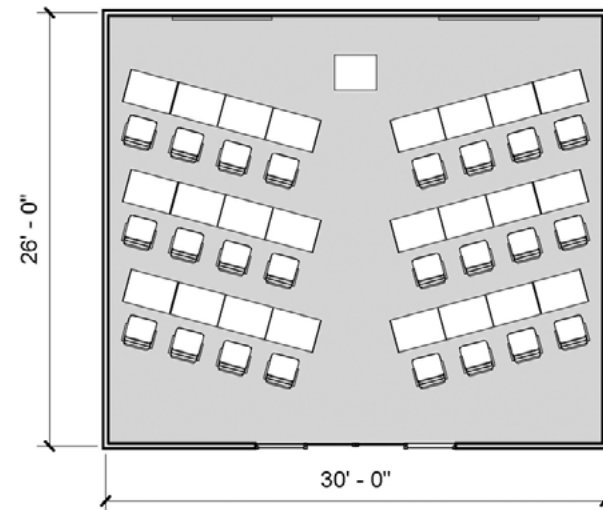

Example 1: Chevron style setup

Figure 18.11

Collaborative Workspace - Conference Room

Conference Room

25 NSF/Seat, 100 min.
(2.3 Nm²/Seat, 9.3 min.)

Architectural:

General Requirements:

Security Level: Restricted Access, Direct Access Control/Key Lock
Adjacent to: Within Interactive Neighborhood

Architectural Features:

- Glass Panels with Sliding Door
- Demountable Walls
- Folding Partition for large spaces

Illumination

- Light dimming

Fixtures, Furniture, and Equipment (FFE)

- Movable “Smart” Tables with plug-and-play data connections and WLAN
- Wall-Mounted Presentation Monitors
- Electronic Concierge Touch-Screen Monitor

Notes:

1. Workplace setting should be compatible with existing conditions and court operations. The dimensional layout and furniture placement of the examples on this page can be modified as necessary.

Legend:

- ① Demountable Walls
- ② Presentation Monitor
- ③ Movable “Smart” Table
- ④ Glass Panels
- ⑤ Sliding Door

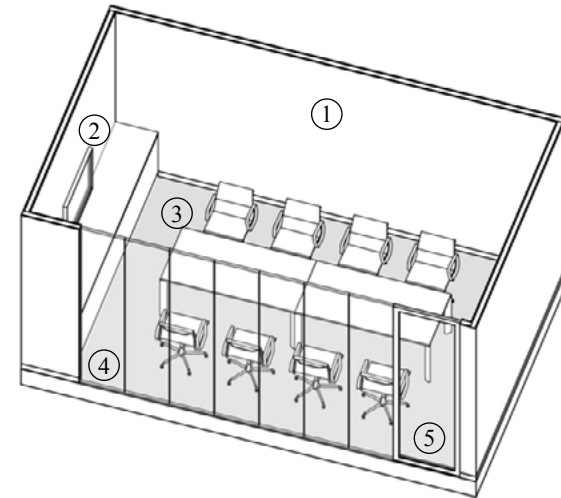

Axonometric Diagram (Example 2)

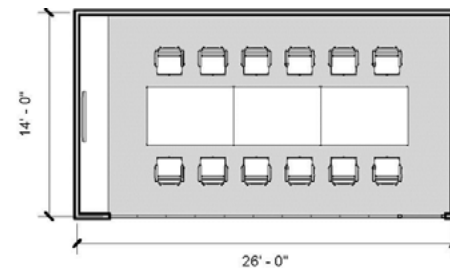

Example 1: Three, six foot tables (364 NSF)

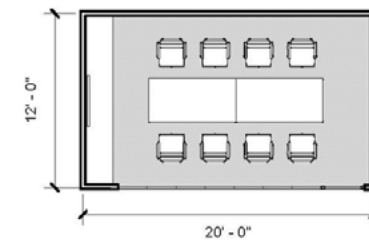

Example 2: Two, six foot tables (240 NSF)

Figure 18.12
Collaborative Workspace - Huddle Area

Huddle Area

100 NSF (9.3 Nm²)

Architectural:

General Requirements:

Security Level: Restricted Access, Uncontrolled (Enclosed Space) or Unrestricted Access (Open Area)
Adjacent to: Within Interactive or Professional Neighborhood

Architectural Features:

- Enclosed or open meeting space
- Glass Panels with Sliding Door (Enclosed Space)
- Demountable Walls (Enclosed Space)

Fixtures, Furniture, and Equipment (FFE) Options

- (1) Movable “Smart” Table with plug-and-play data connections and WLAN
- (2-5) Chairs
- (1) Wall-Mounted Presentation Monitor
- (1) White board

Notes:

1. Workplace setting should be compatible with existing conditions and court operations. The dimensional layout and furniture placement of the examples on this page can be modified as necessary.

Legend:

- ① Demountable Walls
- ② Presentation Monitor
- ③ Movable “Smart” Table
- ④ Glass Panels
- ⑤ Sliding Door

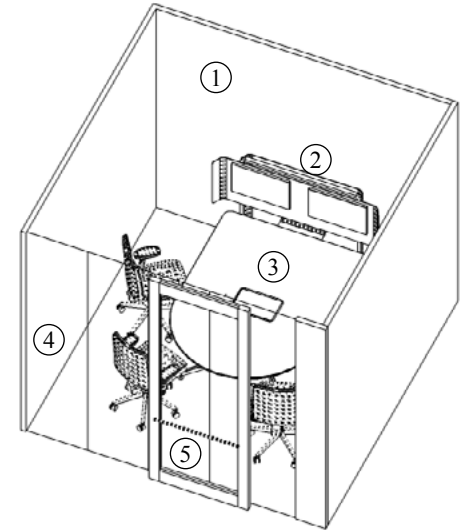

Axonometric Diagram (Example 1)

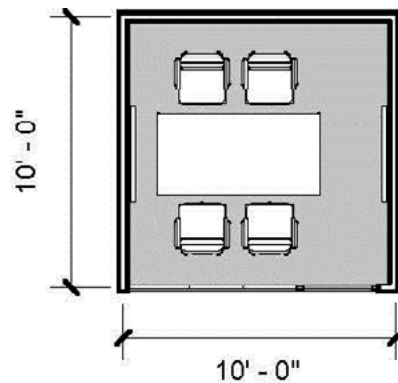

Example 1: Enclosed area with table, monitor, and white board

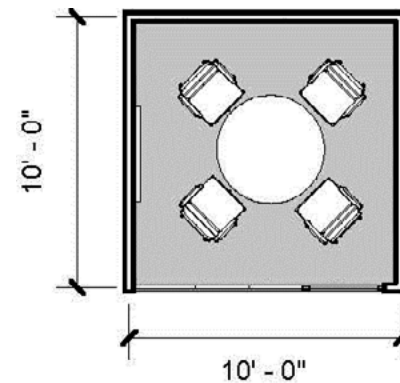

Example 2: Enclosed area with round table, monitor, and white board

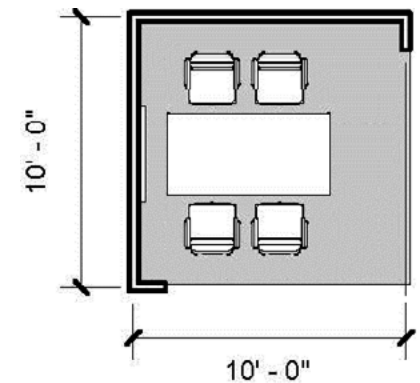

Example 3: Open area with table and monitor or white board

Figure 18.13

Collaborative Workspace - Work Lounge

Work Lounge

25 NSF/Seat (2.3 Nm²/Seat)

Architectural:

General Requirements:

Security Level: None
Adjacent to: Within Informal Neighborhood

Architectural Features:

- Built-In Booth Seating
- Standing or seated counter space

Fixtures, Furniture, and Equipment (FFE) Options

- Cafe Seating with (1) Table and (4) Chairs
- Stools for seated counter space
- Break room appliances (sinks, refrigerators, microwaves, etc)
- Other informal seating arrangements

Notes:

1. Workplace setting should be compatible with existing conditions and court operations. The dimensional layout and furniture placement of the examples on this page can be modified as necessary.

Legend:

- ① Informal Seating
- ② Cafe-Style Seating
- ③ Booth Seating
- ④ Stool-Height Seating

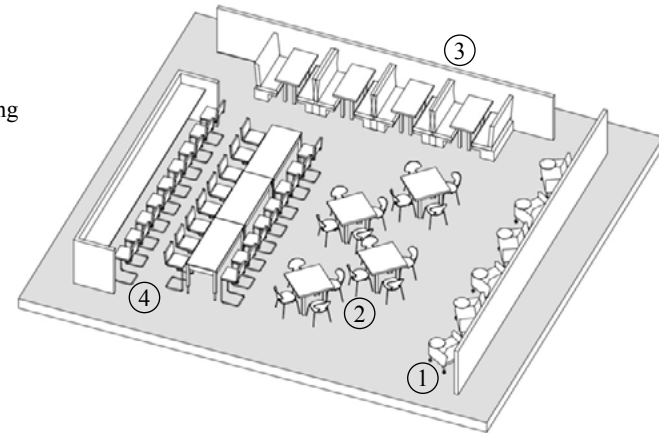

Axonometric Diagram

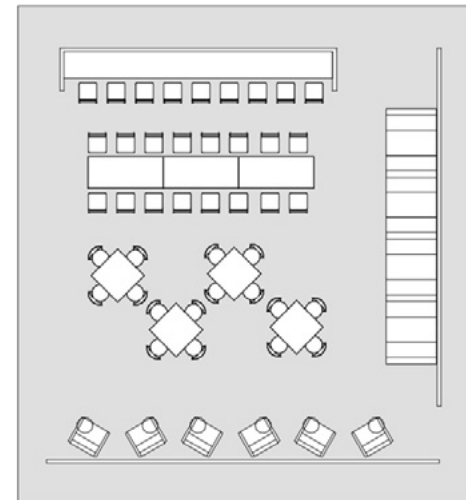

Example 1: Stool-height, booth, cafe-style, and informal seating

Figure 18.14
Modular Design Example

Dedicated Individual Workspace:
Enclosed Offices

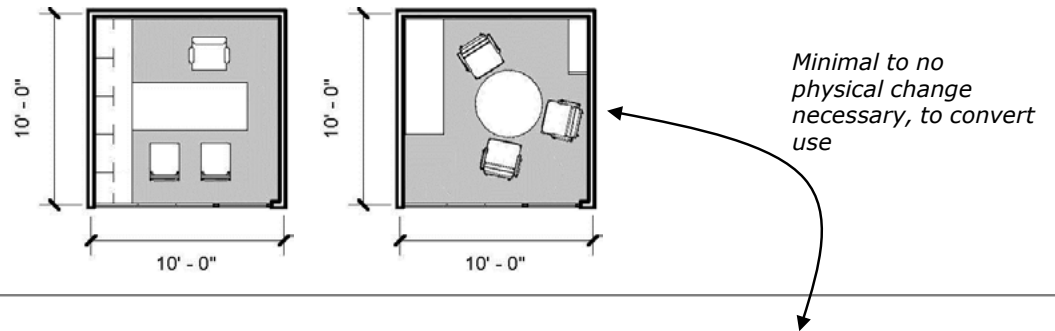

Mobile Individual Workspace:
Enclosed Offices

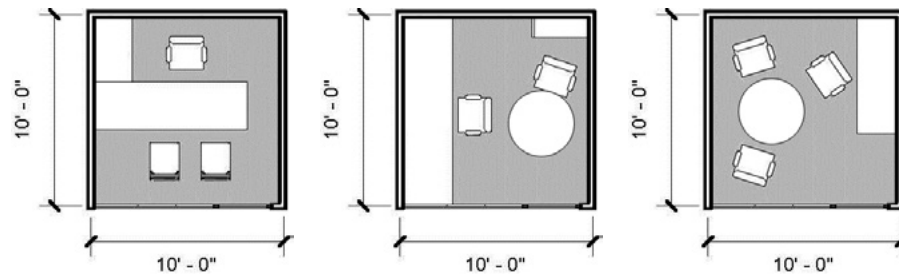

Collaborative Workspace:
Huddle Area

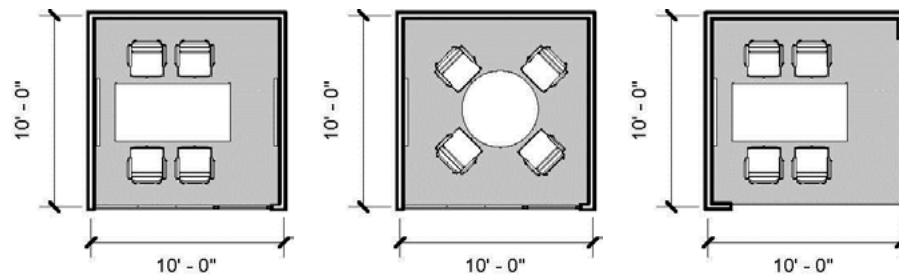

Note: Figure 18.14 demonstrates the benefits of modular design, using a 100 net SF enclosed room. Over time, the enclosed room can be adapted for various functions and uses without costly major renovations. Please refer to “Modularity” under the “[Alternative Workplace Strategies Programming and Planning](#)” section of this chapter for full description.



APPENDIX: ROOM DATA SHEETS

The following room data sheets (RDSs) are a compilation of information contained in the *Design Guide* that identify spatial and programmatic requirements by space type. For simplification and clarity purposes, some spaces have been combined into a single RDS.

Topics:

General	Courthouse Spaces
Chapter 4	Courtrooms
Chapter 5	Jury Assembly Suite
Chapter 6	Judges' Chambers Suites
Chapter 7	Court Library Spaces
Chapter 8	Associated Appeals Clerks' Office Spaces
Chapter 9	Associated Probation and Pretrial Services Office Spaces
Chapter 10	Associated Other Court Unit Office Spaces
Chapter 11	Shared Support Spaces

General Notes:

- The graphics on the RDS are not to scale and are for illustrative purposes only.
- The RDS are meant to be used as a guideline. It is essential that the user obtain additional information from the court, the General Services Administration (GSA), and other participants and users to tailor the design response to the specific court requirements.
- The RDS should be used in conjunction with other facility design standards including but not limited to: The *U.S. Courts Design Reference Manual* and applicable [GSA PBS P-100](#).
- The interpretation and application of the information provided in the RDS into specific design solutions will require the overall review & confirmation of the design by the court, the Administrative Office of the U.S. Courts (AOUSC), the GSA, and the United States Marshals Service (USMS).
- The design architect is responsible for the coordination and conformance with the *Design Guide*, and all applicable laws, codes regulations, and governmental facility standards.
- Finishes indicated on the RDS show a range of acceptable finishes per space; however, this list should not be considered comprehensive. Final finish selection should be determined by the design architect and project stakeholders.
- Fixtures, furniture, and equipment (FFE) requirements should be determined on a project-to-project basis to satisfy the local needs. FFE shown on the graphics is notional and should not be considered comprehensive.
- Furniture, accessories, and equipment indicated with an asterisk (*) is funded by GSA.
- Furniture shown in the RDS are general guidelines of potential layouts. Final furniture design and procurement will be determined by individual project requirements.

Definitions, Legends and Symbols

Security Definitions

- Public 1 - Unscreened Public Access
- Public 2 - Screened Public Access
- Public 3 - Screened Public Access, Locked When Not in Use
- Restricted 1 - Restricted Access, Uncontrolled
- Restricted 2 - Restricted Access, Remote Access Control
- Restricted 3 - Restricted Access, Direct Access Control/Key Lock
- Restricted 4 - Restricted Access, Counter/Window Service
- P - Privacy Lock
- Secure 1 - Secure Access, Authorized Staff
- Secure 2 - Secure Access, Prisoner/Security Staff

Symbols



Handicap Spectator Seating



5'-0" Wheelchair Turning Radius

Finish Legend

Abbreviation	Material
ACP	Acoustical Ceiling Panel or Tile
AWP	Acoustical Wall Panel
CPT	Carpet
CR	Chair Rail
CT	Ceramic Tile
FWC	Fabric Wall Covering
GL	Glass
GWB	Gypsum Wall Board
MTL	Metal
PLAS	Plaster
PLY	Plywood on MTL Studs
PNT-1	Latex paint with eggshell finish. Preferred Finish, unless noted otherwise.
PNT-2	Latex paint with semi-gloss finish. To be used in wet areas such as service units and restroom wet walls.
PNT-3	Water-based catalyzed epoxy or equivalent. To be used for the urinalysis lab.
RAF	Raised Access Floor
ST	Stone
SVT	Solid/Premium Vinyl Tile
SV	Sheet Vinyl
TZ	Terrazzo
VCT	Vinyl Composition Tile
V/RB	Vinyl/Rubber Base

Finish Legend (cont.)

Abbreviation	Material
WD	Wood
WD Wainscot	Wood Wainscot

Room Data Sheet Space Nomenclature

The space nomenclature is used for the General Courthouse Spaces section and denotes a space type followed by a square footage for the space. The remaining Room Data Sheet sections are chapter specific and are noted with the corresponding chapter.

Abbreviation	Space Type
CR	Conference Room
OS	Office Support (Shared space ie., Copier, Printer, Faxes)
PO	Private Office
REC	Reception
SL	Soundlock
ST	Storage
SU	Service Unit
VT	Vault
WS	Workstation

This page intentionally left blank.

General Courthouse Spaces

Space and Ceiling Requirements

REC - 15

Reception/Waiting, per person
Minimum Area Required

15 NSF (1.4 Nm²)
150 NSF (13.9 Nm²)

Architectural:

General Requirements:

Security Level: Public 3, Restricted 1, 4
Adjacent to: Public & Restricted Circulation, Counter
Ceiling Height: 10'-0"
Acoustics: NIC 25 - Normal

Finishes:

Wall: PNT-1
Floor: CPT
Base: V/RB
Ceiling: ACP

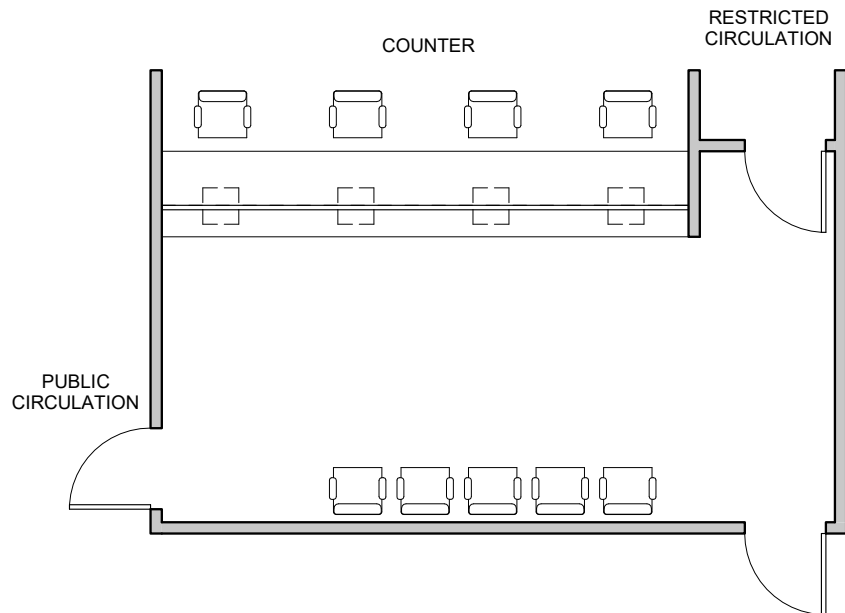

General Courthouse Spaces

Space and Ceiling Requirements

REC - 105

Reception/Waiting Area

105 NSF (9.8 Nm²)

Architectural:

General Requirements:

Security Level: Public 3, Restricted 1, 4
Adjacent to: Public & Restricted Circulation, Counter
Ceiling Height: 10'-0"
Acoustics: NIC 25 - Normal

Finishes:

Wall: PNT-1
Floor: CPT
Base: V/RB
Ceiling: ACP

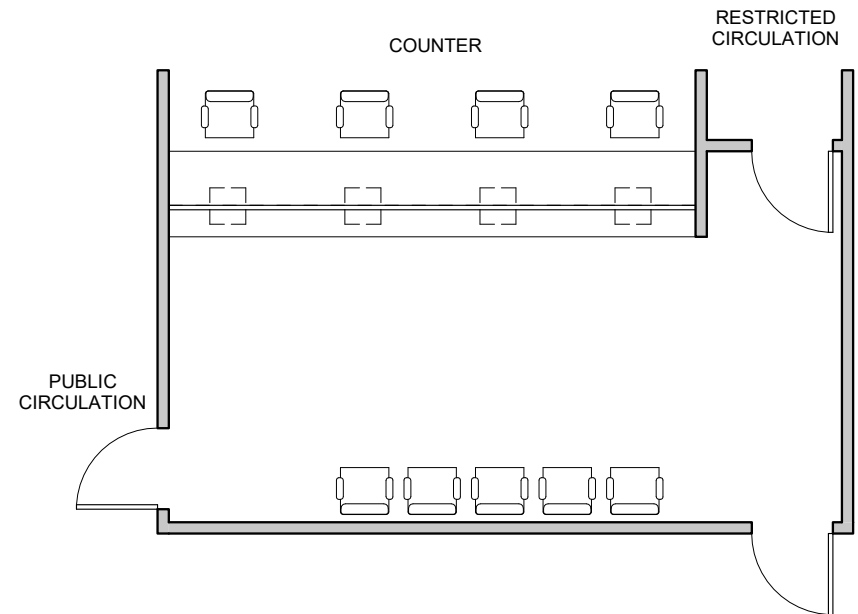

General Courthouse Spaces

Space and Ceiling Requirements

REC - 150

Reception/Waiting Area

150 NSF (14 Nm²)

Architectural:

General Requirements:

Security Level: Public 3, Restricted 1, 4
Adjacent to: Public & Restricted Circulation, Counter
Ceiling Height: 10'-0"
Acoustics: NIC 25 - Normal

Finishes:

Wall: PNT-1
Floor: CPT
Base: V/RB
Ceiling: ACP

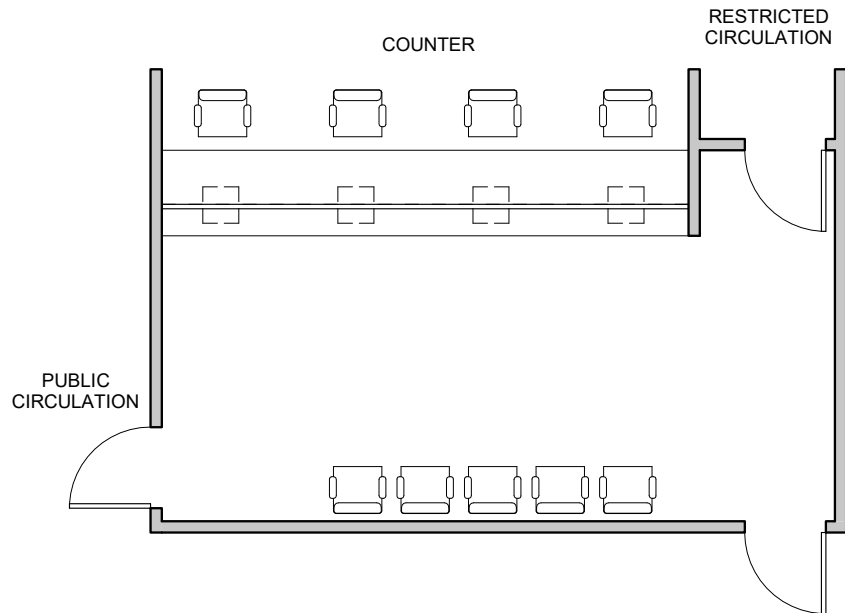

General Courthouse Spaces

Space and Ceiling Requirements

SL - 50

Soundlock

50 NSF (4.6 Nm²)

Architectural:

General Requirements:

Security Level: Restricted 3
Ceiling Height: 10'-0"
Acoustics: NIC 55-60 - Confidential

Finishes:

Wall: PNT-1
Floor: CPT, WD
Base: WD, V/RB
Ceiling: ACP, PNT-1

Building Systems:

Illumination:

Horizontal: 30-40 fc
Vertical: 5-10 fc
Lighting Control: No

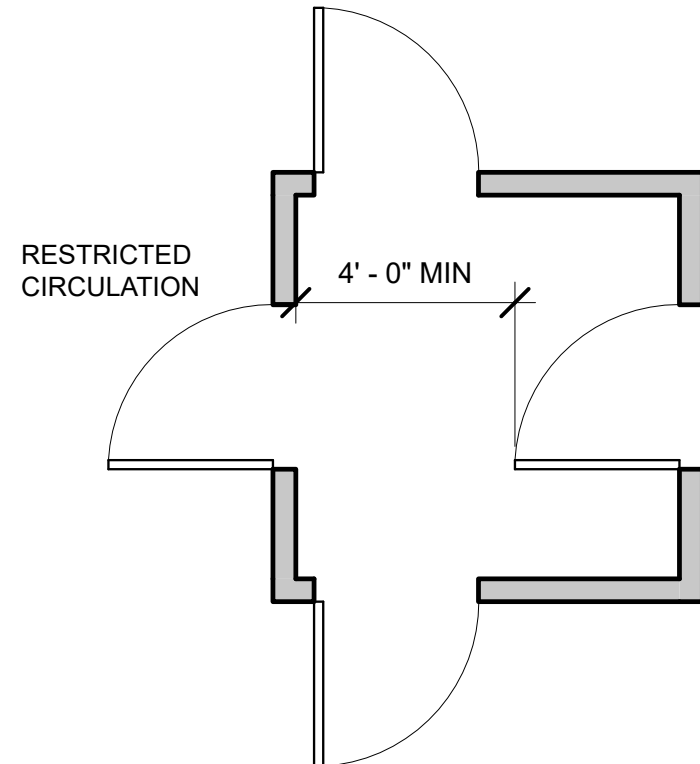

General Courthouse Spaces

Space and Ceiling Requirements

SL - 80

Soundlock

80 NSF (7.4 Nm²)

Architectural:

General Requirements:

Security Level: Public 3
Ceiling Height: 10'-0"
Acoustics: NIC 55-60 - Confidential

Finishes:

Wall: WD, ST, MTL, AWP, PLAS, PNT-1
Floor: CPT, WD
Base: WD, V/RB
Ceiling: WD, MTL, ACP, PNT-1

Building Systems:

Illumination:

Horizontal: 30-40 fc
Vertical: 5-10 fc
Lighting Control: Yes

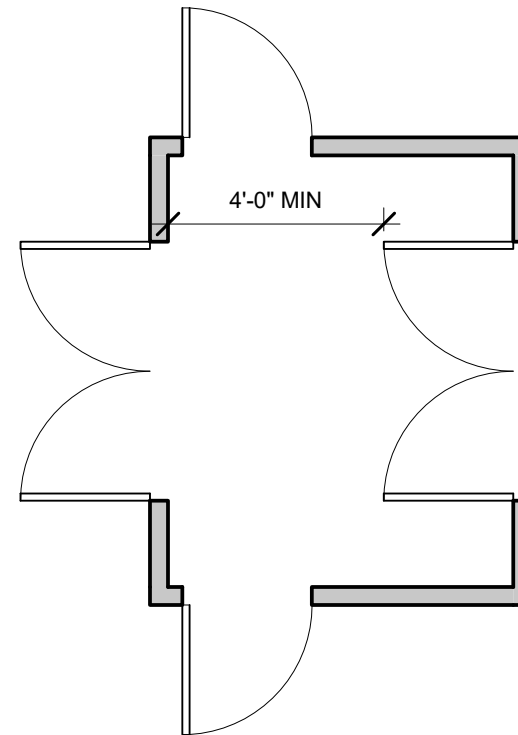

General Courthouse Spaces

Space and Ceiling Requirements

ST - 09

Storage, per shelf unit

9 NSF (0.84 Nm²)

Architectural:

General Requirements:

Security Level: Restricted 3
Ceiling Height: 10'-0"

Finishes:

Wall: Varies (based on location)
Floor: Varies (based on location)
Base: Varies (based on location)
Ceiling: Varies (based on location)

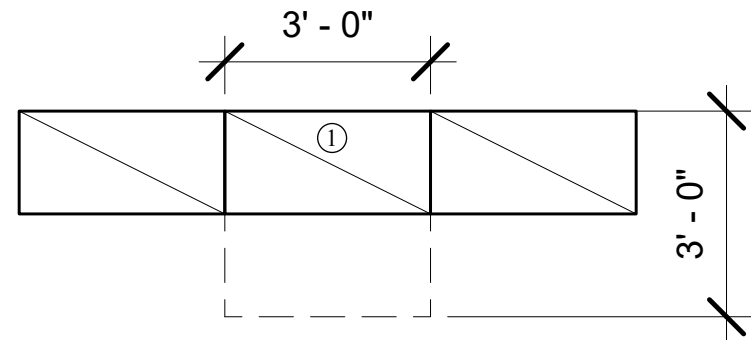

Legend:

① File Cabinets

General Courthouse Spaces

Space and Ceiling Requirements

ST - 20

Coat Closet

20 NSF (1.9 Nm²)

Architectural:

General Requirements:

Security Level: Restricted 1
Ceiling Height: 10'-0"

Finishes:

Wall: PNT-1
Floor: CPT
Base: V/RB
Ceiling: ACP, PNT-1

Space Notes:

1. Provide three linear inches of coats space (75mm) per juror (jury facilities).

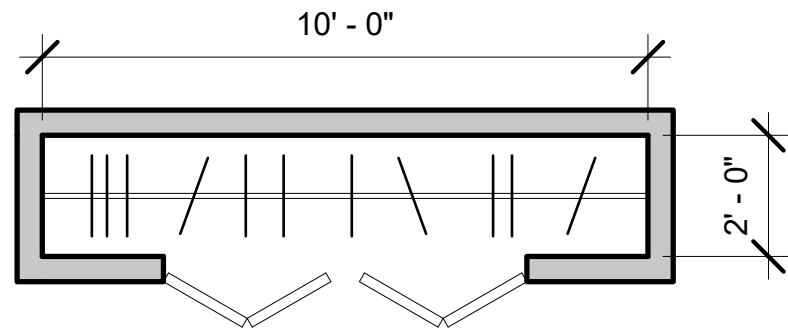

General Courthouse Spaces

Space and Ceiling Requirements

ST - 50

Storage

50 NSF (4.7 Nm²)

Architectural:

General Requirements:

Security Level: Restricted 3
Ceiling Height: 10'-0"

Finishes:

Wall: PNT-1
Floor: VCT
Base: V/RB
Ceiling: ACP

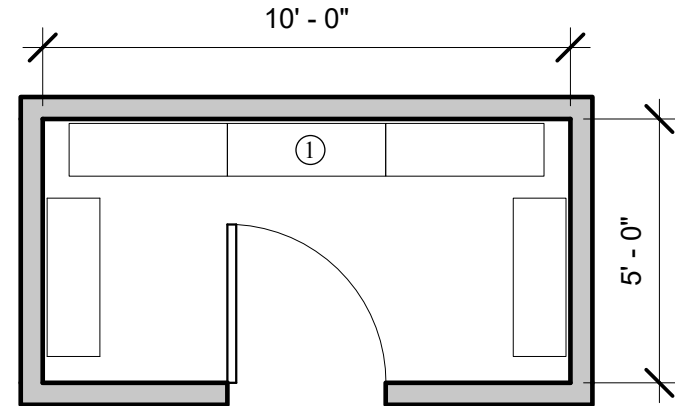

Legend:

① Shelves

General Courthouse Spaces

Space and Ceiling Requirements

ST - 80

Storage

80 NSF (7.4 Nm²)

Architectural:

General Requirements:

Security Level: Restricted 3
Ceiling Height: 10'-0"

Finishes:

Wall: PNT-1
Floor: VCT
Base: V/RB
Ceiling: ACP

Fixtures, Furniture, and Equipment (FFE)

- Shelves: Open shelves 18" (450 mm) deep on 2-3 walls, movable or fixed

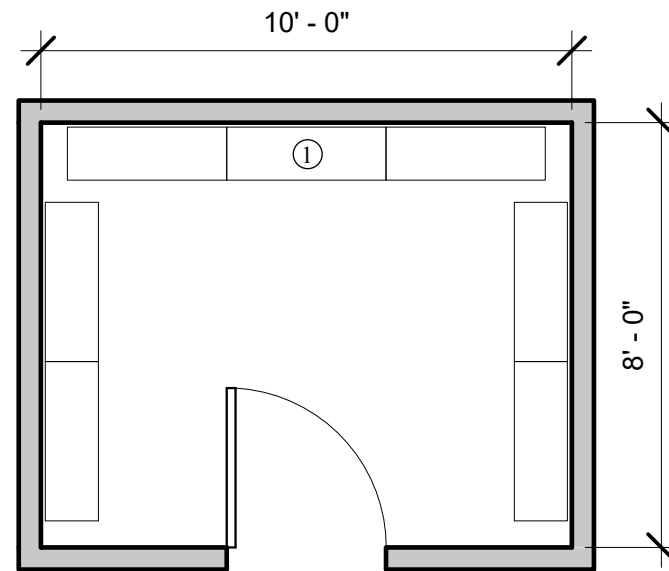

Legend:

① Shelves

General Courthouse Spaces

Space and Ceiling Requirements

ST - 100

Storage Room

100 NSF (9.3 Nm²)

Architectural:

General Requirements:

Security Level: Restricted 3
Ceiling Height: 10'-0"

Finishes:

Wall: PNT-1
Floor: VCT
Base: V/RB
Ceiling: ACP

Fixtures, Furniture, and Equipment (FFE)

- Shelves: Open shelves 18" (450 mm) deep on 2-3 walls, movable or fixed

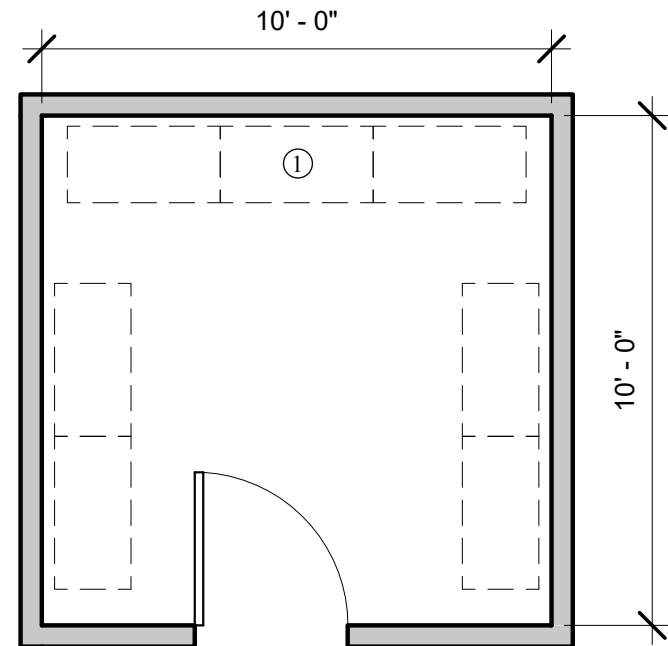

Legend:

① Movable Shelves

General Courthouse Spaces

Space and Ceiling Requirements

ST - 150

Storage Room

150 NSF (13.9 Nm²)

Architectural:

General Requirements:

Security Level: Restricted 3
Ceiling Height: 10'-0"

Finishes:

Wall: PNT-1
Floor: VCT
Base: V/RB
Ceiling: ACP

Fixtures, Furniture, and Equipment (FFE)

- Shelves: Open shelves 18" (450 mm) deep on 2-3 walls, movable or fixed

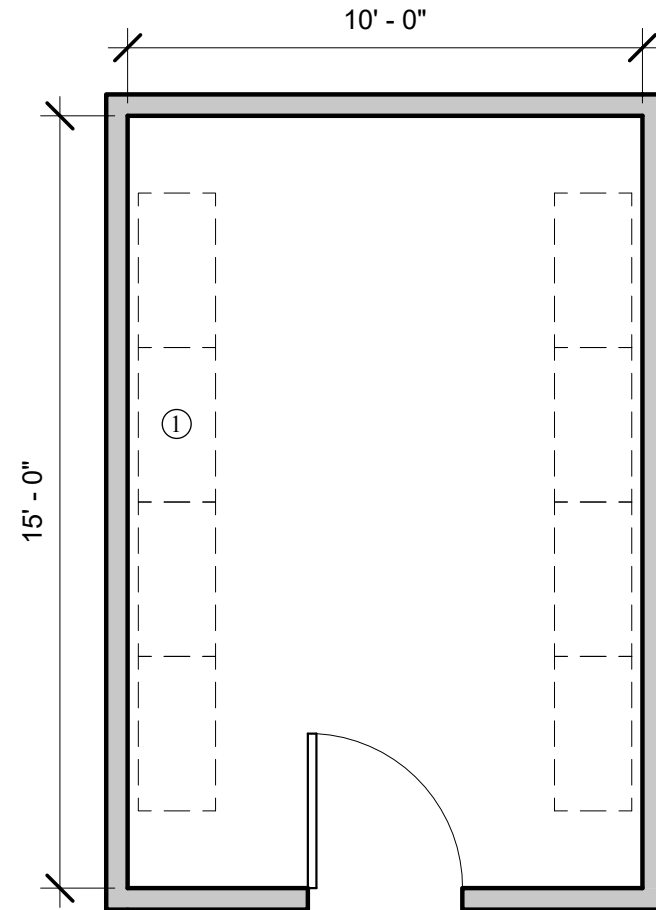

Legend:

① Movable Shelves

General Courthouse Spaces

Space and Ceiling Requirements

WS - 45

Counter Workstations

45 NSF (4.2 Nm²)

Architectural:

General Requirements:

Security Level: Restricted 4
 Adjacent to: Reception/Waiting

Finishes:

Wall: PNT-1
 Floor: CPT
 Base: V/RB
 Ceiling: ACP

Millwork:

- Durable work surface with a divider to the floor below. Accommodate computer monitor, keyboard, and mouse at staff side of counter.
- Where ballistic and break-resistant glass is provided, counter should accommodate document-size deal tray transaction opening for each station.

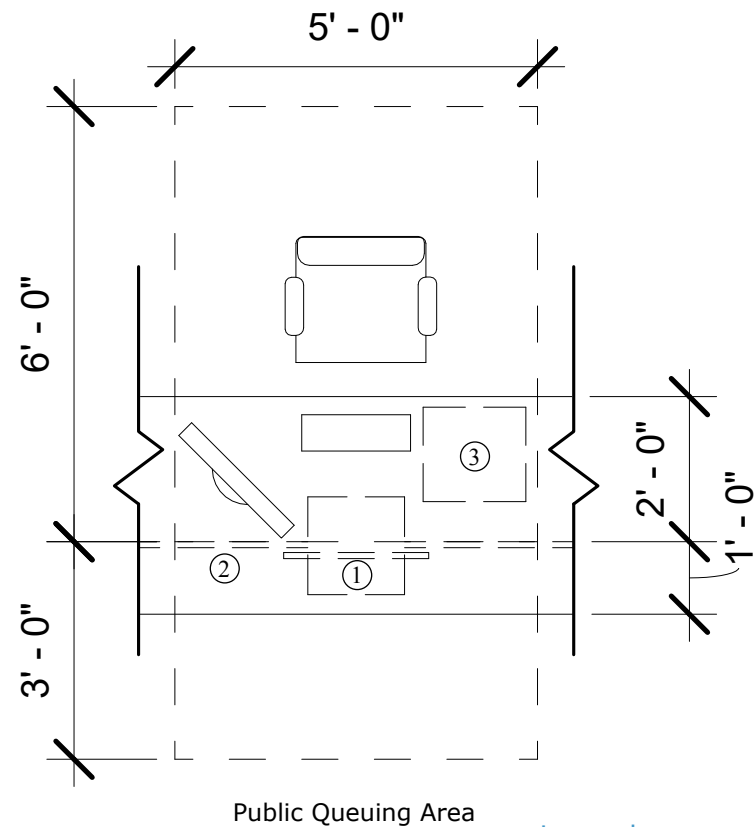

Legend:

- ① Transaction Tray
- ② Security Glazing with Natural Voice Communication
- ③ Cash Drawer

General Courthouse Spaces

Space and Ceiling Requirements

WS - 48

Workstation

48 NSF (4.5 Nm²)

Architectural:

General Requirements:

Security Level: Restricted 1

Finishes:

Wall: Varies (based on location)

Floor: Varies (based on location)

Base: Varies (based on location)

Ceiling: Varies (based on location)

Fixtures, Furniture, and Equipment (FFE)

- 6' x 8' systems furniture workstation
- Chair

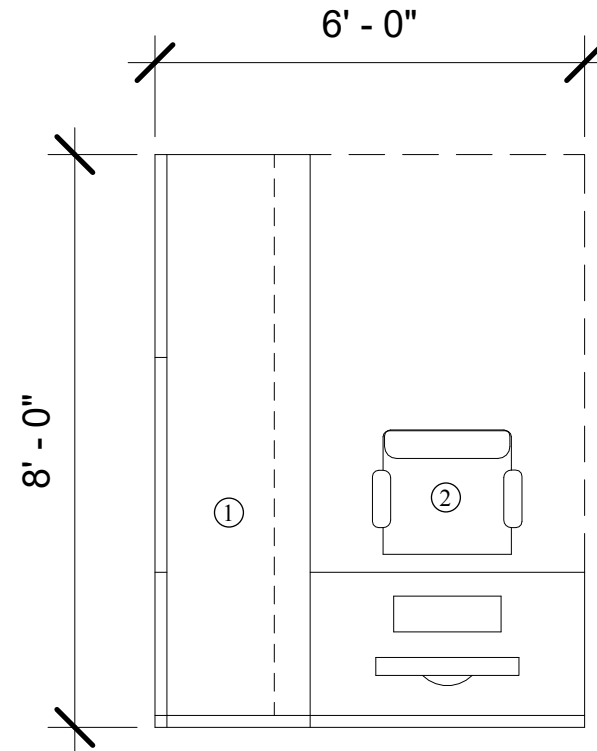

Legend:

① Systems Furniture

② Chair

General Courthouse Spaces

Space and Ceiling Requirements

WS - 64

Workstation

64 NSF (5.8 Nm²)

Architectural:

General Requirements:

Security Level: Restricted 1

Finishes:

Wall: Varies (based on location)
Floor: Varies (based on location)
Base: Varies (based on location)
Ceiling: Varies (based on location)

Fixtures, Furniture, and Equipment (FFE)

- 8' x 8' systems furniture workstation
- Chair

Building Systems:

Security:

- Security intercom (associated chamber space)
- Duress alarm (associated chamber space)
- CCV monitor (associated chamber space)
- Remote door - release mechanism (associated chamber space)

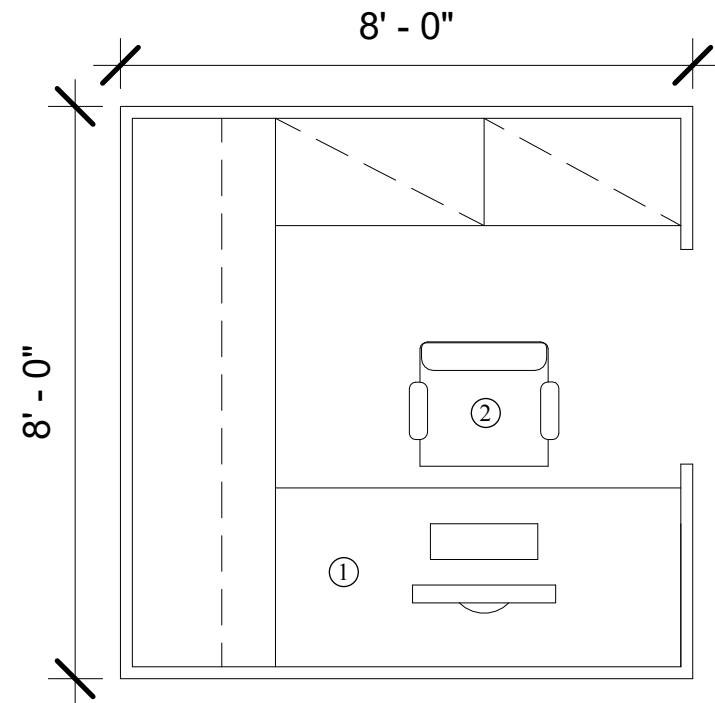

Legend:

- ① Systems Furniture
- ② Chair

General Courthouse Spaces

Space and Ceiling Requirements

WS - 96

Workstation

96 NSF (8.9 Nm²)

Architectural:

General Requirements:

Security Level: Restricted 1

Finishes:

Wall: Varies (based on location)

Floor: Varies (based on location)

Base: Varies (based on location)

Ceiling: Varies (based on location)

Fixtures, Furniture, and Equipment (FFE)

- 8' x 12' systems furniture workstation
- Chair

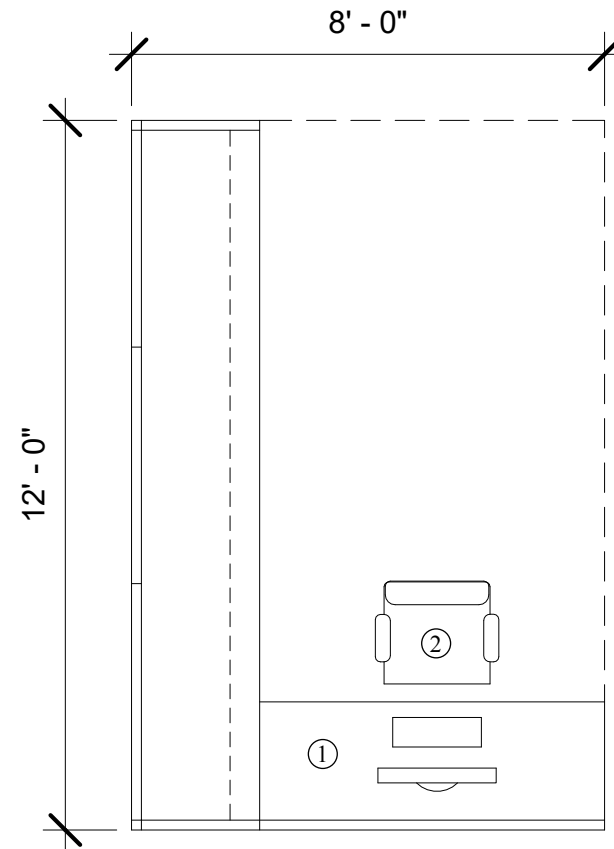

Legend:

① Systems Furniture

② Chair

General Courthouse Spaces

Space and Ceiling Requirements

WS - 170

Executive Secretary

170 NSF (15.8 Nm²)

Architectural:

General Requirements:

Security Level: Restricted 1
Adjacent to: Unit Executive Private Office

Finishes:

Wall: PNT-1
Floor: CPT
Base: V/RB
Ceiling: ACP

Building Systems:

Security:

- Duress alarm

Fixtures, Furniture, and Equipment (FFE)

- 6' x 8' systems furniture workstation
- Chair

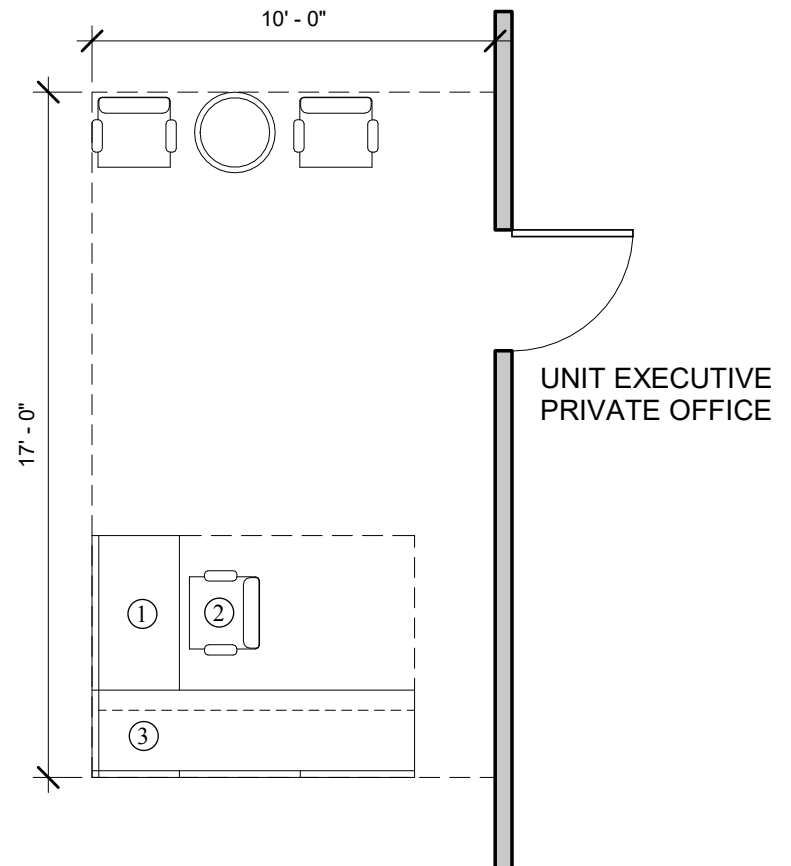

Legend:

- ① Systems Furniture
- ② Chair
- ③ Duress Alarm

General Courthouse Spaces

Space and Ceiling Requirements

PO - 100

Private Office

100 NSF (9.3 Nm²)

Architectural:

General Requirements:

Security Level: Restricted 1
Ceiling Height: 9'-0"
Acoustics: NIC 35 - Normal

Finishes:

Wall: PNT-1, CR (Judge's Chambers Suite)
Floor: CPT
Base: V/RB
Ceiling: ACP

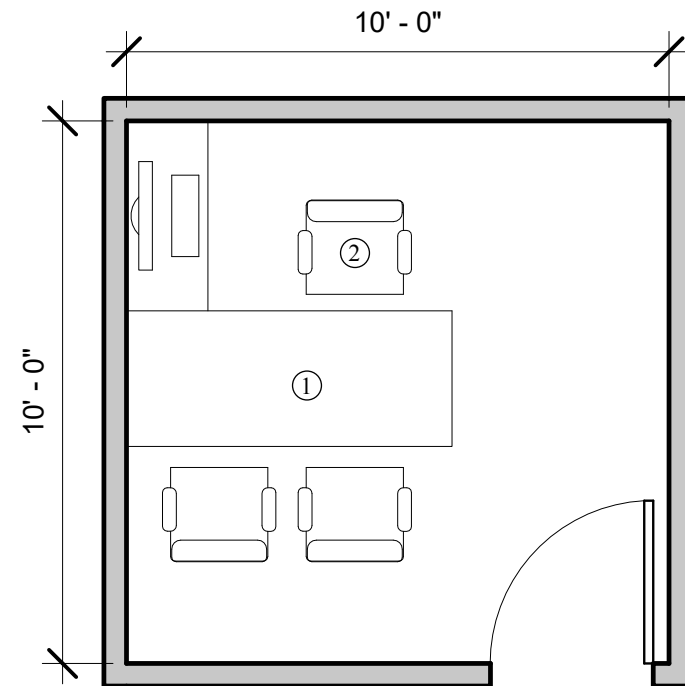

Legend:

- ① Desk
- ② Chair

General Courthouse Spaces

Space and Ceiling Requirements

PO - 120

Private Office

120 NSF (13.9 Nm²)

Architectural:

General Requirements:

Security Level: Restricted 1
Adjacent to:
Ceiling Height: 9'-0"
Acoustics: NIC 35 - Normal (Probation and Pretrial Services Offices)

Finishes:

Wall: PNT-1, CR (Judge's Chambers Suite)
Floor: CPT
Base: V/RB
Ceiling: ACP

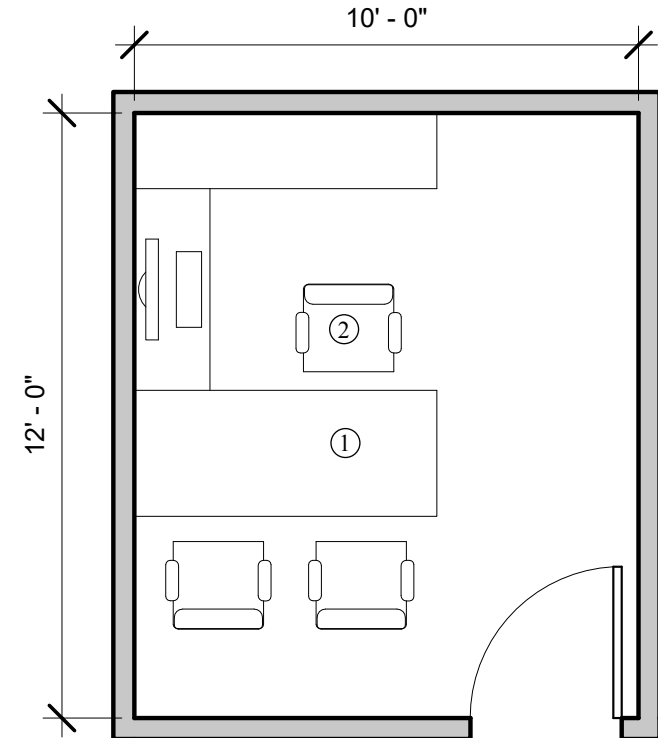

Legend:

- ① Desk
- ② Chair

General Courthouse Spaces

Space and Ceiling Requirements

PO - 150

Private Office

150 NSF (13.9 Nm²)

Architectural:

General Requirements:

Security Level:	Restricted 3
Ceiling Height:	9'-0"
Acoustics	NIC 35 - Normal (Probation and Pretrial Services Offices) NIC 40 - Normal (Court of Appeals Clerks' Offices) NIC 55 - Confidential (Federal Public Defender's Trial Preparation)

Finishes:

Wall:	PNT-1, CR (Judge's Chambers Suite)
Floor:	CPT
Base:	V/RB
Ceiling:	ACP

Building Systems:

Security:

- CCV monitor (law clerk office)
- Duress alarm (law clerk office, professional staff)
- Security intercom (law clerk office)
- Remote door - release mechanism (law clerk office)

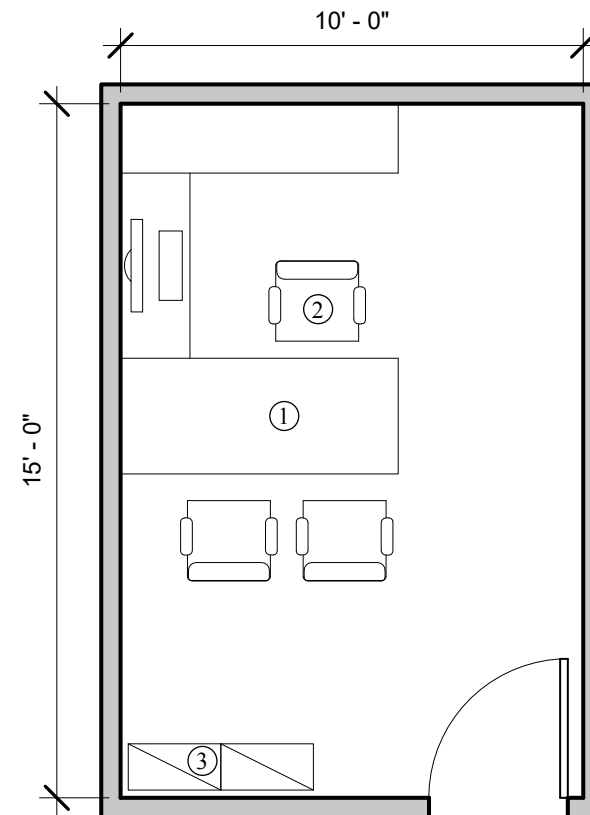

Legend:

- ① Desk
- ② Chair
- ③ File Cabinet

General Courthouse Spaces

Space and Ceiling Requirements

PO - 180

Private Office

180 NSF (16.7 Nm²)

Architectural:

General Requirements:

Security Level:	Restricted 3
Ceiling Height:	9'-0"
Acoustics	NIC 35 - Normal (Probation and Pretrial Services Offices) NIC 40 - Normal (Court of Appeals Clerks' Offices) NIC 55 - Confidential (Pre-Argument/Conference Attorney)

Finishes:

Wall:	PNT-1, CR (Judge's Chambers Suite)
Floor:	CPT
Base:	V/RB
Ceiling:	ACP

Building Systems:

Security:

- Duress alarm (deputy circuit librarian)

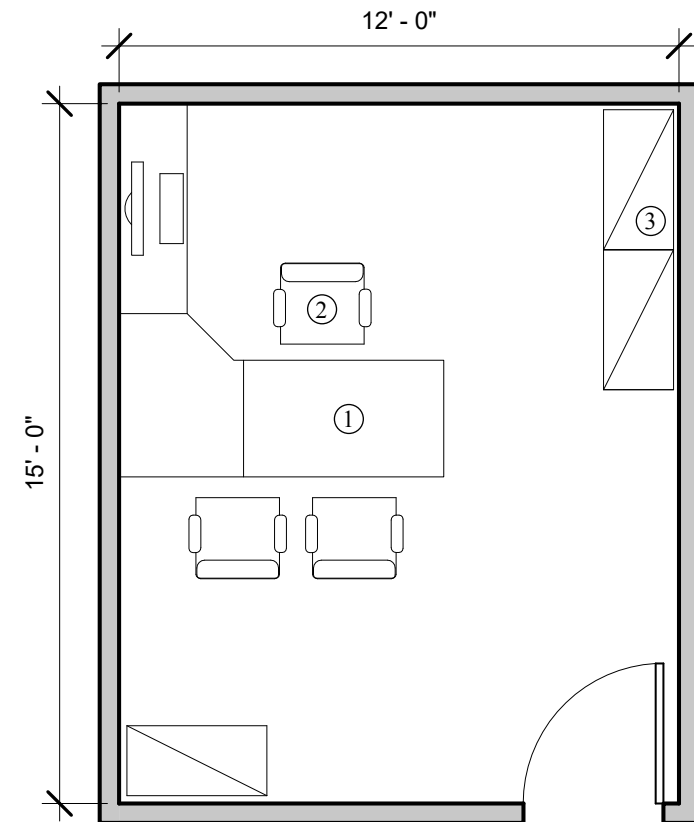

Legend:

① Desk

② Chair

③ File Cabinet

General Courthouse Spaces

Space and Ceiling Requirements

PO - 240

Private Office

240 NSF (22.3 Nm²)

Architectural:

General Requirements:

Security Level:	Restricted 3
Ceiling Height:	9'-0"
Acoustics	NIC 35 - Normal (Probation and Pretrial Services Offices) NIC 40 - Normal (Court of Appeals Clerks' Offices) NIC 55 - Confidential (Pre-Argument/Conference Attorney and Bankruptcy Administrator)

Finishes:

Wall:	PNT-1, CR (Judge's Chambers Suite)
Floor:	CPT
Base:	V/RB
Ceiling:	ACP

Building Systems:

Security:

- Duress alarm (circuit librarian)

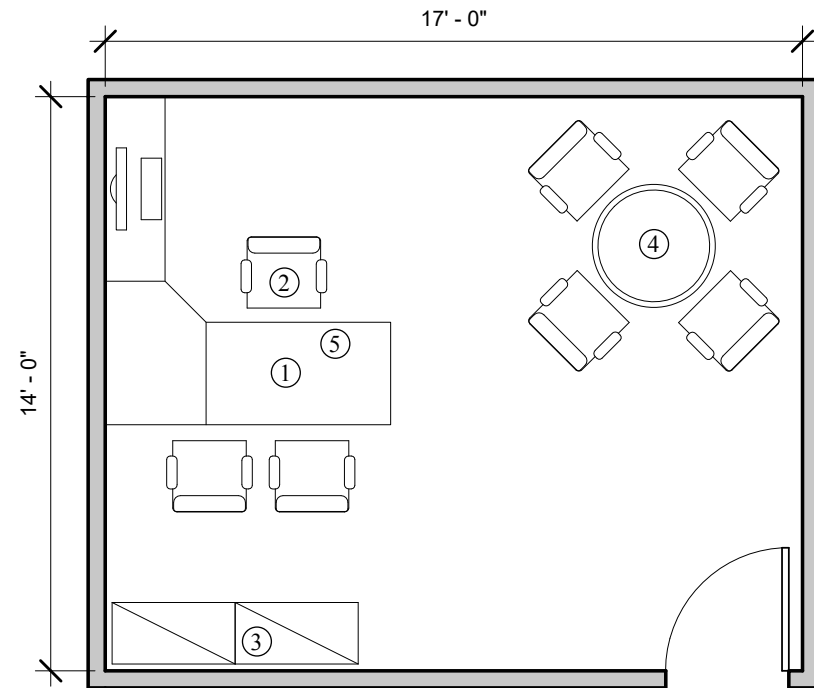

Legend:

- | | |
|----------------|----------------|
| ① Desk | ④ Table |
| ② Chair | ⑤ Duress Alarm |
| ③ File Cabinet | |

General Courthouse Spaces

Space and Ceiling Requirements

VT - 20

Safe or Vault

20 NSF (1.6 Nm²)

Architectural:

Finishes:

Wall:	Varies (based on location)
Floor:	Varies (based on location)
Base:	Varies (based on location)
Ceiling:	Varies (based on location)

Space Notes:

- Partition construction:
 - Slab to slab, (2) layers 5/8" type X GWB both sides, 3-5/8" 18-GA steel studs 16" o.c
 - Maximum security steel mesh (ASM.50-13F) provided on the inner side of wall board
 - Security screen attached to floor slab and structure above, welded together on studs to form a continuous barrier against entry
- Door construction:
 - UL-labeled class B, 18-gauge, metal fire doors constructed with 14-gauge hardware reinforcements
 - 16-gauge steel frames with three hinges, high quality, three-tumbler combination lock to secure the door for after-hours protection
 - Key lock to be provided for business hours after the alarm has been turned off and combination lock is dialed in., emergency egress hardware
- Reference GSA PBS P-100 for HVAC, telecom, fire alarm, data, and security system requirements

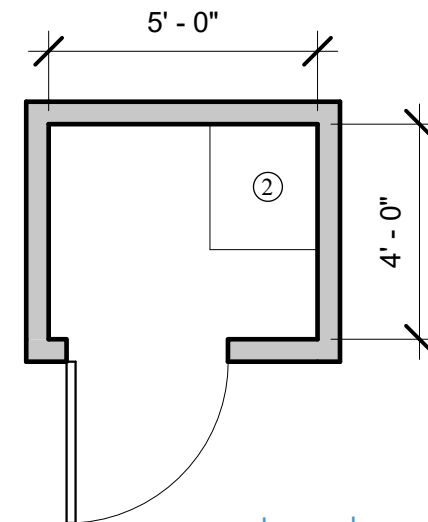
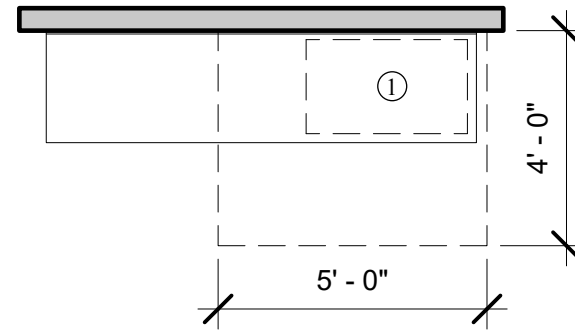

Legend:

- ① Under-Counter Safe
- ② Standalone Safe

General Courthouse Spaces

Space and Ceiling Requirements

VT - 80

Vault

80 NSF (7.4 Nm²)

Architectural:

General Requirements:

Security Level: Restricted 3
Adjacent to: Restricted Corridor
Ceiling Height: 9'-0"

Finishes:

Wall: PNT-1
Floor: VCT
Base: V/RB
Ceiling: PNT-1

Building Systems:

Life Safety:

Fire Rating: 2 hour partition

Security:

Duress Alarm: Yes

Space Notes:

- Partition construction:
 - Slab to slab, (2) layers 5/8" type X GWB both sides, 3-5/8" 18-GA steel studs 16" o.c
 - Maximum security steel mesh (ASM.50-13F) provided on the inner side of wall board
 - Security screen attached to floor slab and structure above, welded together on studs to form a continuous barrier against entry
- Door construction:
 - UL-labeled class B, 18-gauge, metal fire doors constructed with 14-gauge hardware reinforcements
 - 16-gauge steel frames with three hinges, high quality, three-tumbler combination lock to secure the door for after hours protection
 - Key lock to be provided for business hours after the alarm has been turned off and combination lock is dialed in., emergency egress hardware
- Reference GSA PBS P-100 for HVAC, telecom, fire alarm, data, and security system requirements

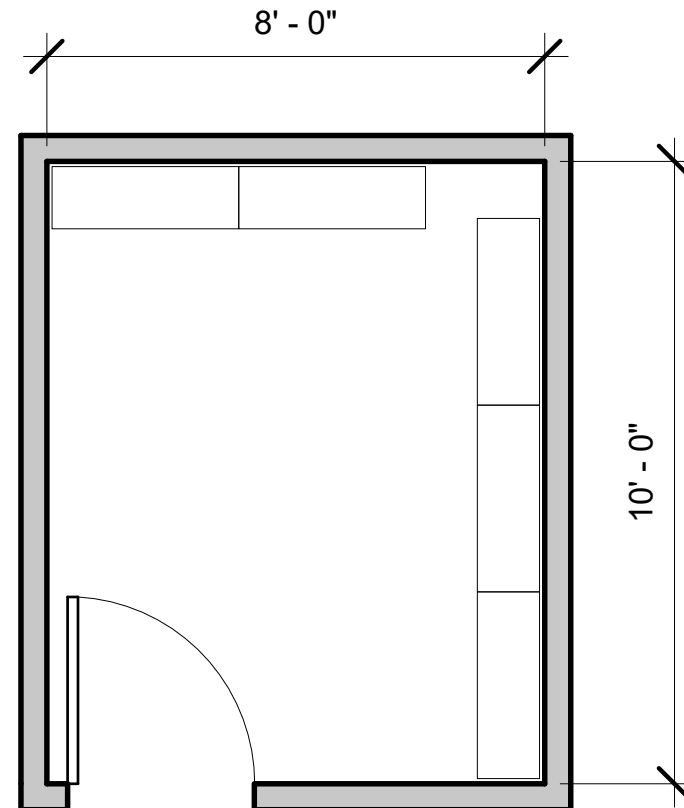

General Courthouse Spaces

Space and Ceiling Requirements

VT - 150

Vault

150 NSF (14 Nm²)

Architectural:

General Requirements:

Security Level: Restricted 3
Adjacent to: Restricted Corridor
Ceiling Height: 9'-0"

Finishes:

Wall: PNT-1
Floor: VCT
Base: V/RB
Ceiling: ACP

Building Systems:

Security:

Duress Alarm: Yes

Space Notes:

- Partition construction:
 - Slab to slab, (2) layers 5/8" type X GWB both sides, 3-5/8" 18-GA steel studs 16" o.c., 2-hour rated wall
 - Maximum security steel mesh (ASM.50-13F) provided on the inner side of wall board
 - Security screen attached to floor slab and structure above, welded together on studs to form a contiguous barrier against entry
- Door construction:
 - UL-labeled class B, 18-gauge, metal fire doors constructed with 14-gauge hardware reinforcements
 - 16-gauge steel frames with three hinges, high quality, three-tumbler combination lock to secure the door for after hours protection
 - Key lock to be provided for business hours after the alarm has been turned off and combination lock is dialed in., emergency egress hardware
- Reference GSA PBS P-100 for HVAC, telecom, fire alarm, data, and security system requirements

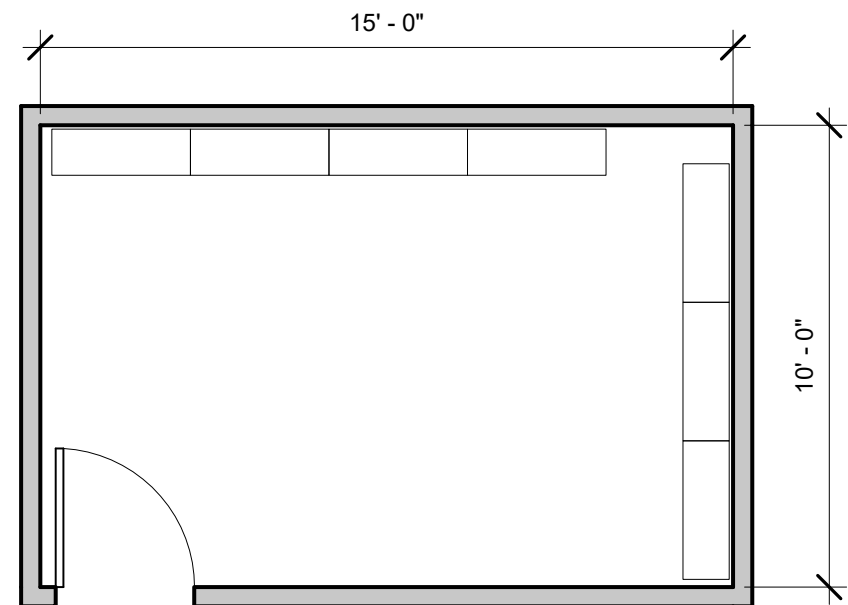

General Courthouse Spaces

Space and Ceiling Requirements

CR - 300

Conference Room

300 NSF (27.9 Nm²)

Architectural:

General Requirements:

Security Level: Restricted 3
Ceiling Height: 10'-0"
Acoustics: NIC 55 - Confidential

Finishes:

Wall: PNT-1
Floor: CPT
Base: V/RB
Ceiling: ACP

Building Systems:

Illumination:

Horizontal: 30-50 fc
Vertical: 10-15 fc
Lighting Control: Yes
Emergency Lighting: Yes

Mechanical:

Air Changes: 8/hour

Space Notes:

1. Conference room for meetings with fewer than 20 occupants.

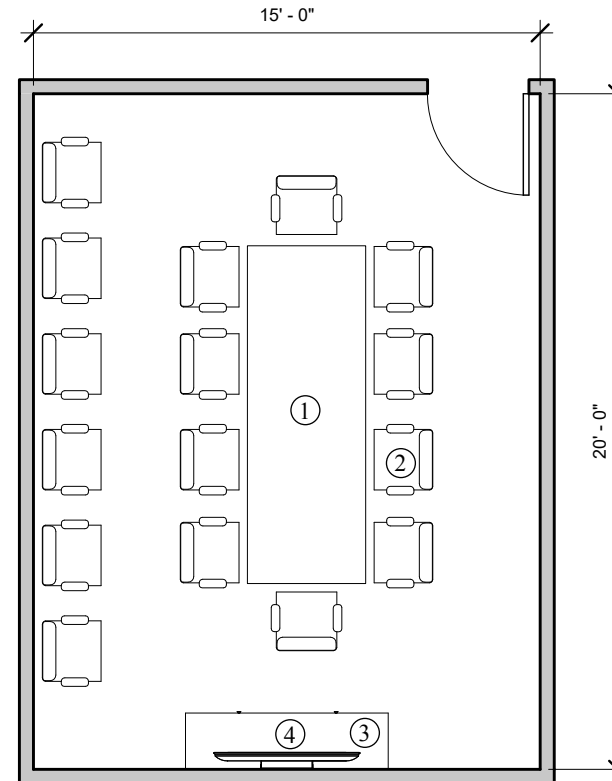

Legend:

- ① Table
- ② Chairs
- ③ Credenza
- ④ Monitor

General Courthouse Spaces

Space and Ceiling Requirements

CR - 400

Conference Room

400 NSF (37.2 Nm²)

Architectural:

General Requirements:

Security Level: Restricted 3
Ceiling Height: 10'-0"
Acoustics: NIC 55 - Confidential

Finishes:

Wall: PNT-1
Floor: CPT
Base: V/RB
Ceiling: ACP

Building Systems:

Illumination:

Horizontal: 30-50 fc
Vertical: 10-15 fc
Lighting Control: Yes
Emergency Lighting: Yes

Mechanical:

Air Changes: 8/hour

Space Notes:

1. Conference room for meeting with more than 20 or more occupants.

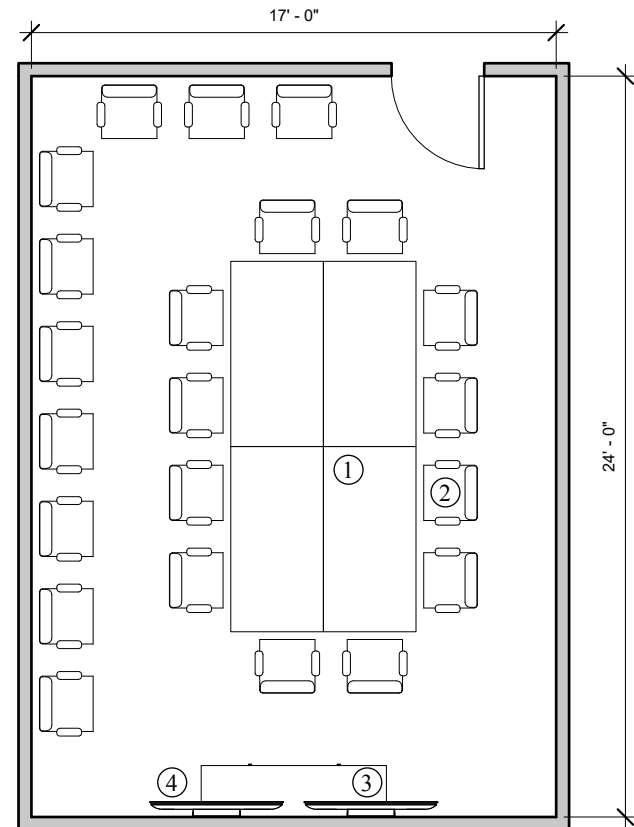

Legend:

- ① Table
- ② Chairs
- ③ Credenza
- ④ Monitor

General Courthouse Spaces

Space and Ceiling Requirements

SU - 20

Service Unit

20 NSF (1.9 Nm²)

Architectural:

General Requirements:

Security Level: Restricted Corridor
Ceiling Height: 10'-0"

Finishes:

Wall: PNT-2
Floor: VCT
Base: V/RB
Ceiling: ACP

Building Systems:

Illumination:

Horizontal: 20-30 fc
Vertical: 5-10 fc
Lighting Control: Yes

Fixtures, Furniture, and Equipment (FFE)

- (1) Optional full-size refrigerator for jurors who bring their own food (jury facilities).

Space Notes:

- Accommodate a sink, a microwave, a coffeemaker, and potentially vending machines.

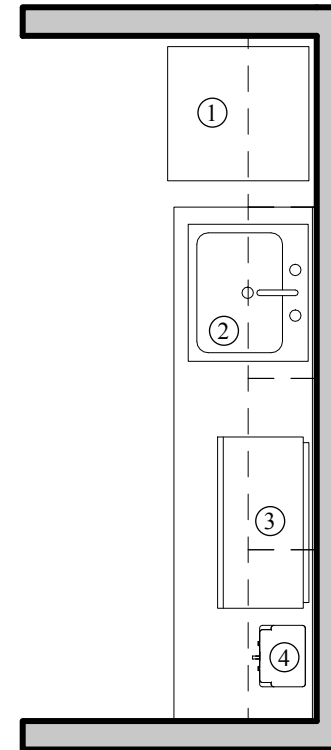

Legend:

- ① Full-Size Refrigerator
- ② Sink
- ③ Microwave
- ④ Coffeemaker

General Courthouse Spaces

Space and Ceiling Requirements

SU - 100

Service Unit

100 NSF (9.3 Nm²)

Architectural:

General Requirements:

Security Level: Restricted Corridor
Ceiling Height: 10'-0"

Finishes:

Wall: PNT-2
Floor: VCT
Base: V/RB
Ceiling: ACP

Building Systems:

Illumination:

Horizontal: 20-30 fc
Vertical: 5-10 fc
Lighting Control: Yes

Fixtures, Furniture, and Equipment (FFE)

-(1) Optional full-size refrigerator

Space Notes:

1. Accommodate a sink, a microwave, a coffeemaker, and potentially vending machines.

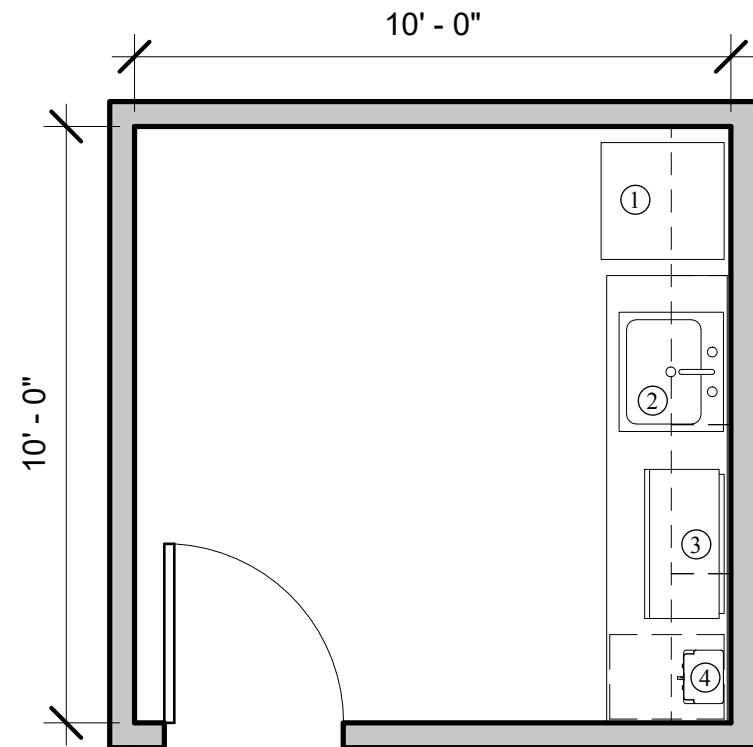

Legend:

- ① Full-Size Refrigerator
- ② Sink
- ③ Microwave
- ④ Coffeemaker

General Courthouse Spaces

Space and Ceiling Requirements

SU - 200

Staff Break Room 200 Min-600 Max NSF (18.6-55.8 Nm²)

Architectural:

General Requirements:

Adjacent to: Restricted Corridor
Ceiling Height: 10'-0"

Finishes:

Wall: PNT-2
Floor: VCT
Base: V/RB
Ceiling: ACP

Building Systems:

Illumination:

Horizontal: 20-30 fc
Vertical: 5-10 fc
Lighting Control: Yes

Space Notes:

1. Allocate 25 NSF (2.32 Nm²) for every three staff members, plus 20 NSF (1.9 Nm²) for a service unit.
2. Accommodate a sink, a microwave, a coffeemaker, and potentially vending machines.

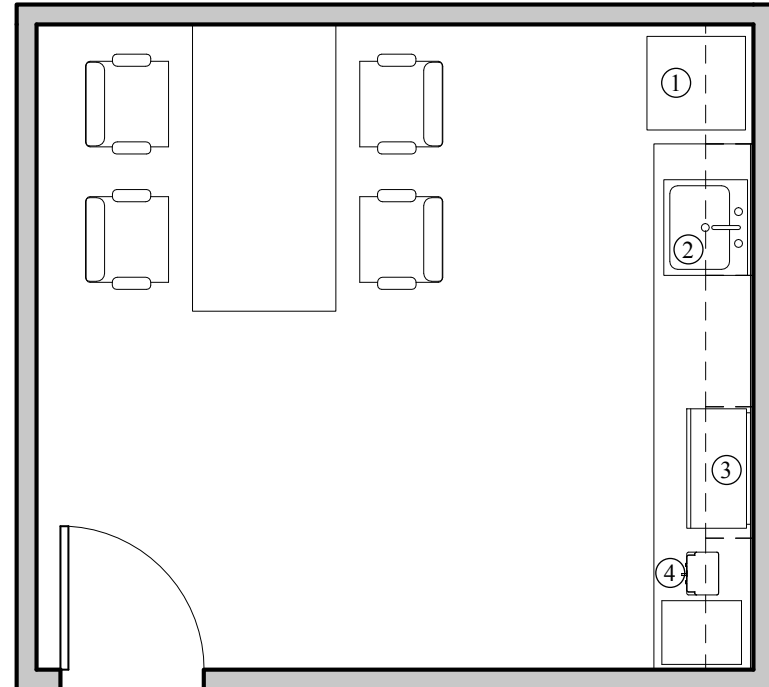

Legend:

- ① Full-size refrigerator
- ② Sink
- ③ Microwave
- ④ Coffeemaker

General Courthouse Spaces

Space and Ceiling Requirements

OS - 01

Printer/Copier/Fax Area Shredder

60 NSF (5.6 Nm²)
25 NSF (2.3 Nm²)

Architectural:

General Requirements:

Adjacent to: Workstations

Finishes:

Wall: Varies (based on location)
Floor: Varies (based on location)
Base: Varies (based on location)
Ceiling: Varies (based on location)

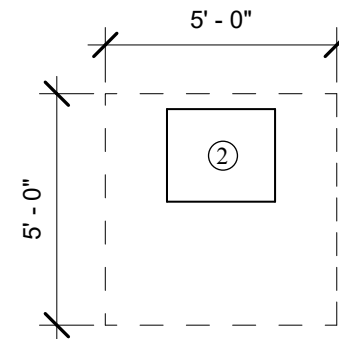
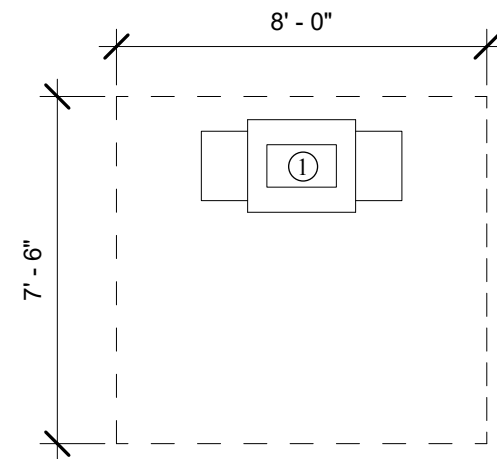

Legend:

- ① Printer, Copier, Fax
- ② Shredder

General Courthouse Spaces

Space and Ceiling Requirements

OS - 02

Public: Print/Copier/Scanner

100 NSF (9.3 Nm²)

Staff: Print/Copier/Scanner

50 NSF (4.7 Nm²)

Architectural:

General Requirements:

Security Level: Public 2 (Public Print/Copier/Scanner)
Restricted 2 (Staff Print/Copier/Scanner)

Ceiling Height: 10'-0"

Finishes:

Wall: Varies (based on location)
Floor: Varies (based on location)
Base: Varies (based on location)
Ceiling: Varies (based on location)

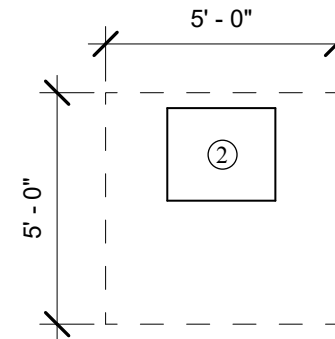
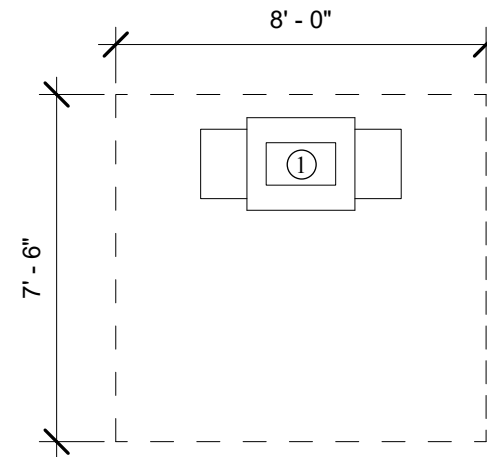

Legend:

- ① Printer, Copier, Fax
- ② Shredder

General Courthouse Spaces Space and Ceiling Requirements

Copier, Low Volume	50 NSF (4.7 Nm²)
Copier, Medium Volume	80 NSF (7.4 Nm²)
Copier, High Volume	120 NSF (11.2 Nm²)

Architectural:

General Requirements:

Adjacent to: Workstations
Ceiling Height: 10'-0"

Finishes:

Wall: PNT-1
Floor: VCT
Base: V/RB
Ceiling: ACP

Fixtures, Furniture, and Equipment (FFE)

- Work Surface: copier, work surface, supplies storage (staff print/copier/scanner)
- Storage: to accommodate supplies, 12" (300-mm) D shelves (staff printer/copier/scanner)

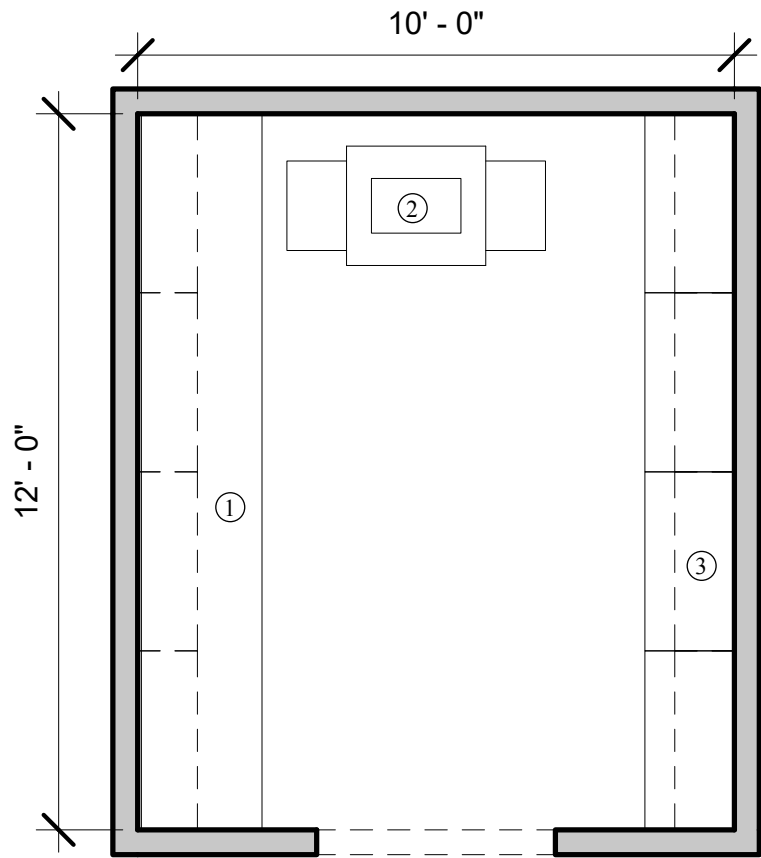

Legend:

- ① Counter
- ② Copier
- ③ Storage

General Courthouse Space

Space and Ceiling Requirements

OS - 04

Work Area

Minimum

195 NSF (18.1 Nm²)

Architectural:

General Requirements:

Security Level: Restricted 1
Ceiling Height: 9'-0"

Finishes:

Wall: PNT-1
Floor: VCT
Base: V/RB
Ceiling: ACP

Space Notes:

1. Assign 15 NSF (1.4 Nm²) per staff member. Minimum area is 195 NSF (18.1 Nm²).
2. Work area is inclusive of NSF allotted for a work table.

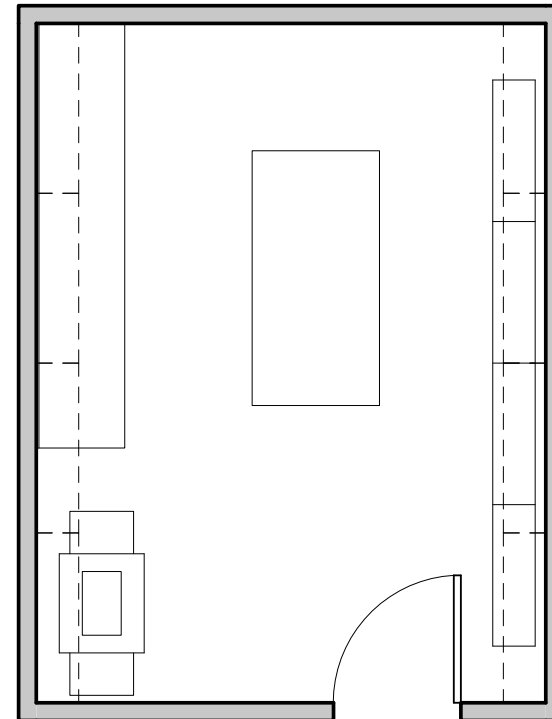

Courtrooms

Space and Ceiling Requirements

En Banc Courtroom

3,000 NSF (278.7 Nm²)

Architectural:

General Requirements:

Security Level:	Public 3, Restricted 2
Adjacent to:	Public Waiting Area
Ceiling Height:	18'-0"
Acoustics	NIC 55-60 - Confidential

Finishes:

Wall:	WD, ST, MTL, AWP, PLAS, PNT-1
Floor:	CPT, WD, RAF
Base:	WD, V/RB
Ceiling:	WD, MTL, ACP, PNT-1

Building Systems:

Illumination (Horizontal/Vertical):

Judge's Bench	50-55 fc / 20-25 fc
Court Reporter	50-55 fc / 20-25 fc
Jury Box	50-55 fc / 20-25 fc
Attorney Witness Area	40-50 fc / 15-20 fc
Witness Box	40-50 fc / 15-20 fc
News Media Room	30-40 fc / 15-20 fc
Attorney Work Room	30-40 fc / 15-20 fc
Attorney/Witness Room	30-40 fc / 15-20 fc
Public Seating	40-50 fc / 5-10 fc

Lighting Control:	Yes
Emergency Power:	Yes
Emergency Lighting:	Yes

Mechanical:

Air Changes:	6-8/hour
--------------	----------

Building Systems (con't):

Security:

- CCV camera
- Duress alarm
- Card reader
- Walk-through metal detector
- Ballistic-resistant material capability at judge's bench and deputy clerk station
- (2) 120-volt outlets connected to emergency generators outside of courtroom

Millwork:

- Judge's bench(es)
- (1-2) Deputy clerk station
- Recording equipment cabinet
- (3) Law clerk station
- Lectern (fixed or movable), accommodate a clock/timer, microphone, and task lighting
- (120-150 & 5 wheelchair) Spectator seating

Furniture and Equipment:

- Judge's bench chair(s), swivel, tilt
- (6) Task chair
 - (2) Deputy clerks
 - (3) Law clerks
 - (1) Bailiff
- Chair (attorney): (4) chairs per attorney table, extra chairs to be stored outside of courtroom
- (4) Tables for attorneys and litigants*
- (1) Clock

Courtrooms

Space and Ceiling Requirements

En Banc Courtroom

3,000 NSF (278.7 Nm²)

Legend:

- ① Spectator Seating
- ② Movable Rail
- ③ Movable "Smart" Table
- ④ Deputy Clerk Station
- ⑤ Law Clerk Station
- ⑥ Judge's Bench
- ⑦ Lectern

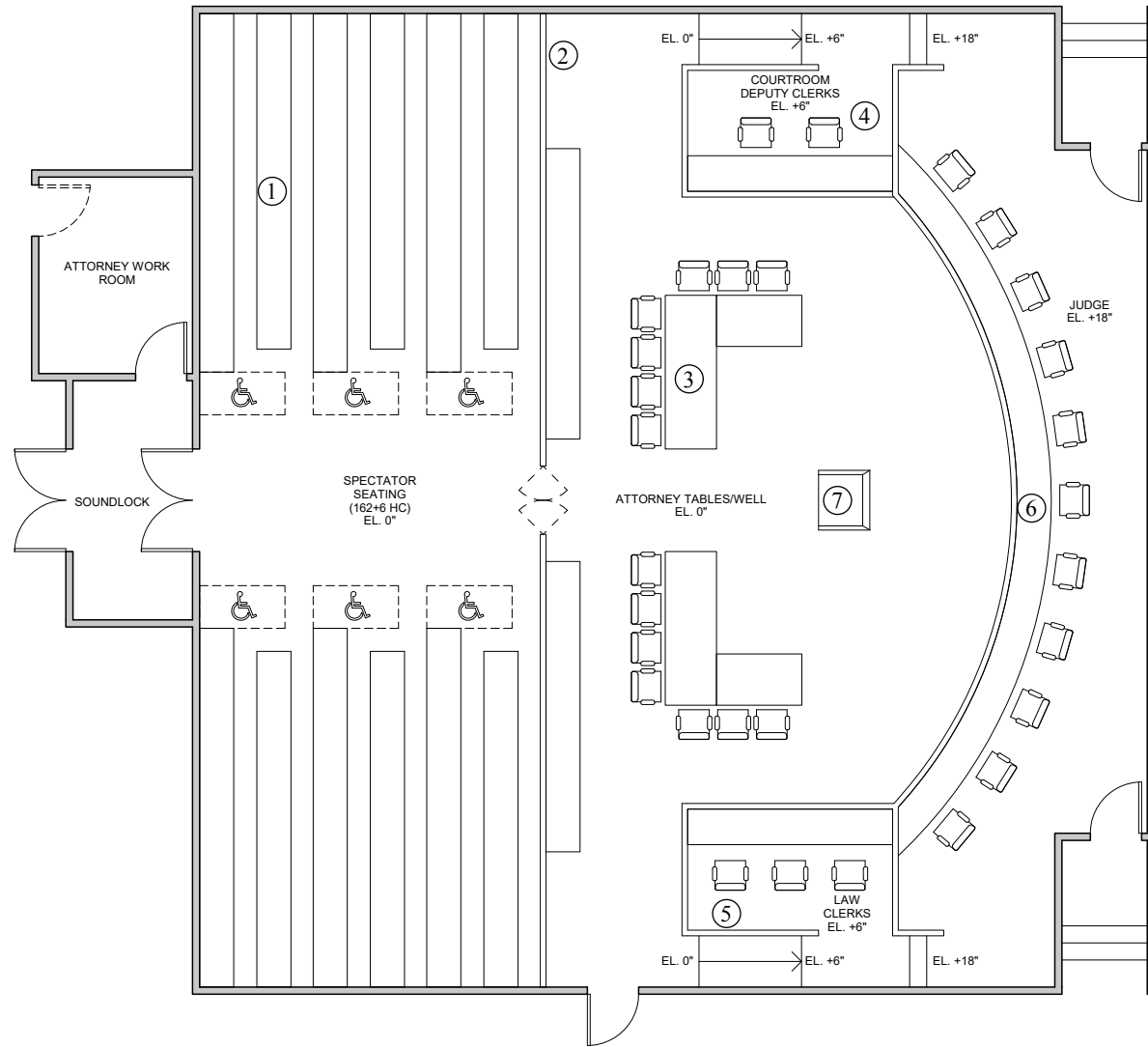

Courtrooms
Space and Ceiling Requirements

Panel Courtroom **1,800 NSF (167.2 Nm²)**

Architectural:

General Requirements:

Security Level:	Public 3, Restricted 2
Adjacent to:	Public Waiting Area
Ceiling Height:	16'-0"
Acoustics	NIC 55-60 - Confidential

Finishes:

Wall:	WD, ST, MTL, AWP, PLAS, PNT-1
Floor:	CPT, WD, RAF
Base:	WD, V/RB
Ceiling:	WD, MTL, ACP, PNT-1

Building Systems:

Illumination (Horizontal/Vertical):

Judge's Bench	50-55 fc / 20-25 fc
Court Reporter	50-55 fc / 20-25 fc
Jury Box	50-55 fc / 20-25 fc
Attorney Witness Area	40-50 fc / 15-20 fc
Witness Box	40-50 fc / 15-20 fc
News Media Room	30-40 fc / 15-20 fc
Attorney Work Room	30-40 fc / 15-20 fc
Attorney/Witness Room	30-40 fc / 15-20 fc
Public Seating	40-50 fc / 5-10 fc

Lighting Control:	Yes
Emergency Power:	Yes
Emergency Lighting:	Yes

Mechanical:

Air Changes:	6-8/hour
--------------	----------

Building Systems (con't):

Security:

- CCV camera
- Duress alarm
- Card reader
- Walk-through metal detector
- Ballistic-resistant material capability at judge's bench and deputy clerk station
- (2) 120-volt outlets connected to emergency generators outside of courtroom

Millwork:

- (3) Judge's benches
- (1-2) Courtroom deputy clerk station
- Recording equipment cabinet
- (3) Law clerk station
- Lectern (fixed or movable), accommodate a clock/timer, microphone, and task lighting
- (40-80 & 4 wheelchair) Spectator seating

Furniture and Equipment:

- (3) Judge's chair: swivel, tilt
- (6) Task chair: swivel
 - (2) Deputy clerks
 - (3) Law clerks
 - (1) Bailiff
- Chair (attorney): (4) chairs per table max, extra chairs to be stored outside of courtroom
- (4) Tables for attorneys and litigants*
- (1) Clock

Courtrooms
Space and Ceiling Requirements

Panel Courtroom

1,800 NSF (167.2 Nm²)

Legend:

- ① Spectator Seating
- ② Movable Rail
- ③ Movable “Smart” Table
- ④ Deputy Clerk Station
- ⑤ Law Clerk Station
- ⑥ Judge’s Bench
- ⑦ Lectern

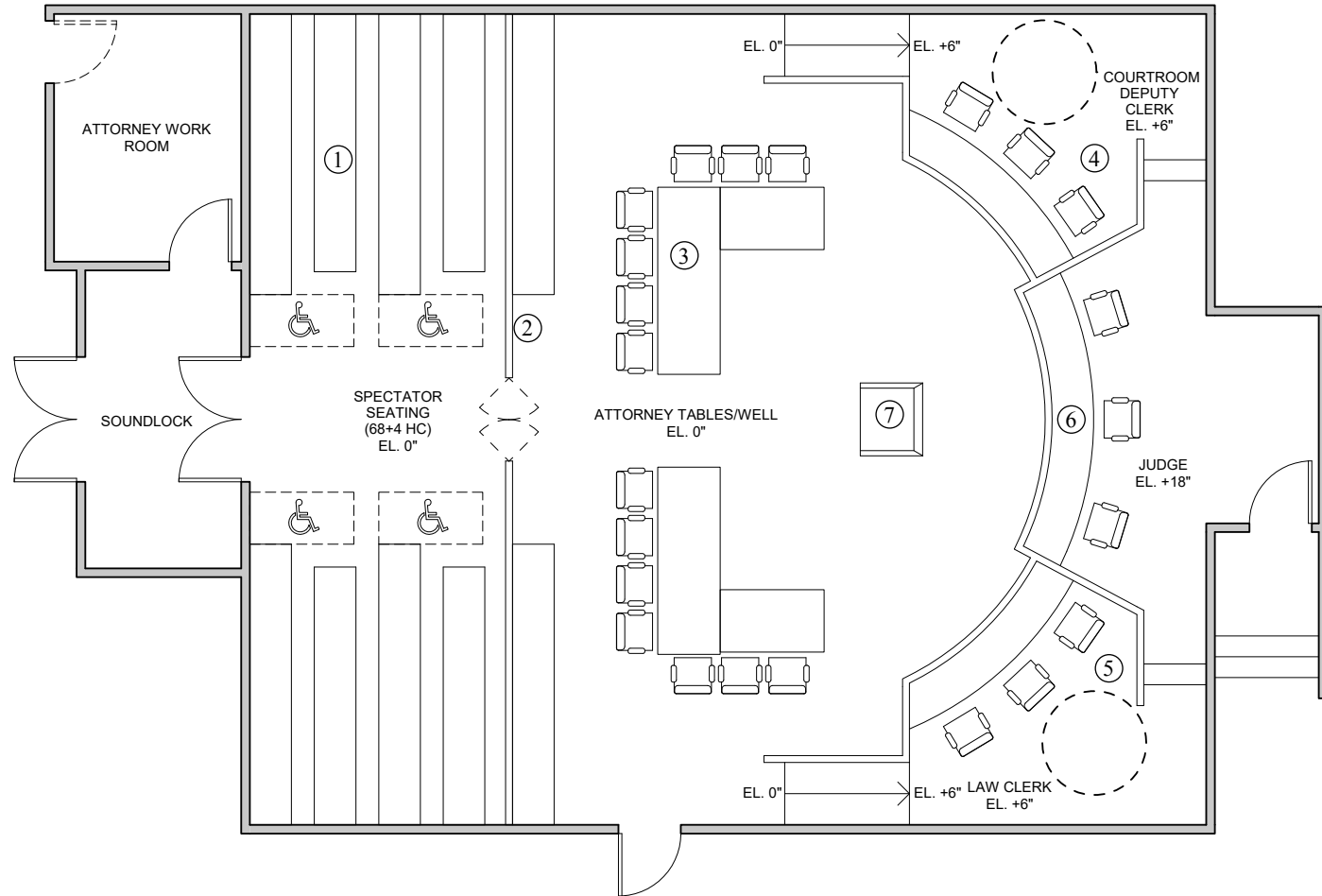

Courtrooms

Space and Ceiling Requirements

Multi-Party Courtroom

3,000 NSF (278.7 Nm²)

Architectural:

General Requirements:

Security Level:	Public 3, Restricted 3, Secure 2
Adjacent to:	Public Waiting Area
Ceiling Height:	18'-0"
Acoustics	NIC 55-60 - Confidential

Finishes:

Wall:	WD, ST, MTL, AWP, PLAS, PNT-1
Floor:	CPT, WD
Base:	WD, V/RB
Ceiling:	WD, MTL, ACP, PNT-1

Building Systems:

Illumination (Horizontal/Vertical):

Judge's Bench	50-55 fc / 20-25 fc
Court Reporter	50-55 fc / 20-25 fc
Jury Box	50-55 fc / 20-25 fc
Attorney Witness Area	40-50 fc / 15-20 fc
Witness Box	40-50 fc / 15-20 fc
News Media Room	30-40 fc / 15-20 fc
Attorney Work Room	30-40 fc / 15-20 fc
Attorney/Witness Room	30-40 fc / 15-20 fc
Public Seating	40-50 fc / 5-10 fc

Lighting Control:	Yes
Emergency Power:	Yes
Emergency Lighting:	Yes

Mechanical:

Air Changes:	6-8/hour
--------------	----------

Building Systems (con't):

Security:

- CCV camera
- Duress alarm
- Card reader
- Walk-through metal detector (only for trials with high security)
- Ballistic-resistant material capability at judge's bench and deputy clerk station
- (2) 120-volt outlets connected to emergency generators outside of courtroom

Millwork:

- (1-3) Judge's benches
- (1-2) Deputy clerk station
- Evidence cabinet
- (1) Court reporter/recorder station
- Recording equipment cabinet
- (1) Law clerk station
- (1-2) Witness box
- (18) Jury Box
- Lectern (movable), accommodate a microphone and task lighting
- (100-120 & 4-5 wheelchair spaces) Spectator Seating

Furniture and Equipment:

- Judge's chair: swivel, tilt
- (4) Task chair: swivel
 - (2) Deputy clerks
 - (1) Court reporter/recorder
 - (1) Law clerk
- (1) Chair (interpreter): swivel, movable
- (1) Chair (witness): swivel, movable
- (18) Chair (jury): swivel, fixed, (2) removable*
- Chairs (attorney and litigant): (4) seats per table, extra chairs to be stored outside of courtroom
- Chairs (USMS personnel): movable, as needed
- (6) Tables for attorneys and litigants*
- (1) Clock

Courtrooms

Space and Ceiling Requirements

Multi-Party Courtroom

3,000 NSF (278.7 Nm²)

Legend:

- ① Spectator Seating
- ② Movable Rail
- ③ Movable "Smart" Table
- ④ Jury Box
- ⑤ Witness Box
- ⑥ Judge's Bench
- ⑦ Law Clerk Station
- ⑧ Court Reporter/Deputy Clerk Station
- ⑨ Lectern

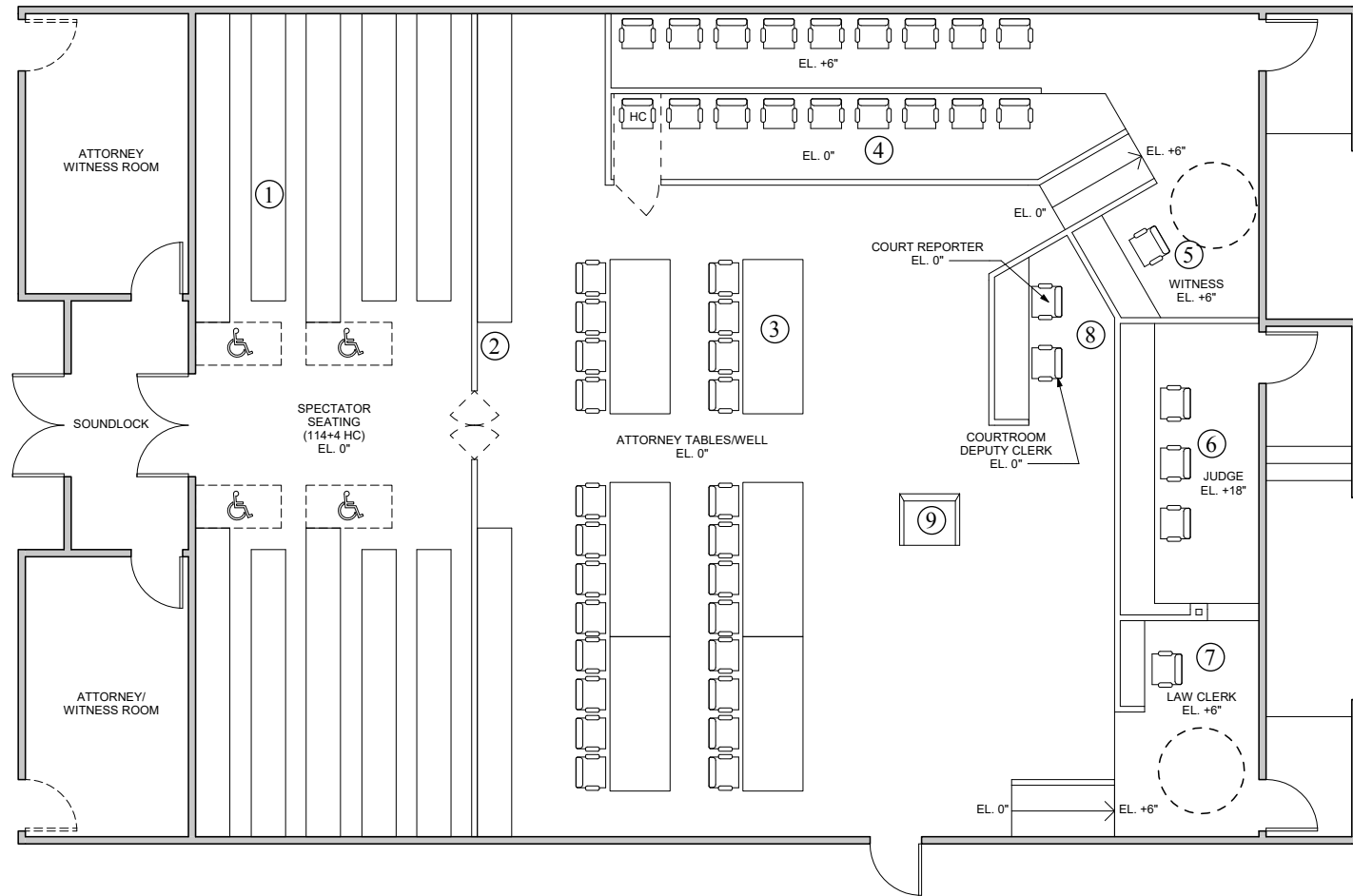

Courtrooms

Space and Ceiling Requirements

District Judge Courtroom

2,400 NSF (223 Nm²)

Architectural:

General Requirements:

Security Level: Public 3, Restricted 3, Secure 2
 Adjacent to: Public Waiting Area
 Ceiling Height: 16'-0"
 Acoustics: NIC 55-60 - Confidential

Finishes:

Wall: WD, ST, MTL, AWP, PLAS, PNT-1
 Floor: CPT, WD, RAF
 Base: WD, V/RB
 Ceiling: WD, MTL, ACP, PNT-1

Building Systems:

Illumination (Horizontal/Vertical):

Judge's Bench 50-55 fc / 20-25 fc
 Court Reporter 50-55 fc / 20-25 fc
 Jury Box 50-55 fc / 20-25 fc
 Attorney Witness Area 40-50 fc / 15-20 fc
 Witness Box 40-50 fc / 15-20 fc
 News Media Room 30-40 fc / 15-20 fc
 Attorney Work Room 30-40 fc / 15-20 fc
 Attorney/Witness Room 30-40 fc / 15-20 fc
 Public Seating 40-50 fc / 5-10 fc

Lighting Control: Yes
 Emergency Power: Yes
 Emergency Lighting: Yes

Mechanical:

Air Changes: 8-10/hour

Building Systems (con't):

Security:

- CCV camera
- Duress alarm
- Card reader
- Walk-through metal detector (only for trials with high security)
- Ballistic-resistant material capability at judge's bench and deputy clerk station
- (2) 120-volt outlets connected to emergency generators outside of courtroom

Millwork:

- (1) Judge's bench
- (1-2) Courtroom deputy clerk station
- Evidence cabinet
- (1) Court reporter/recorder station
- Recording equipment cabinet
- (1) Law clerk station
- (1-2) Witness box
- (16) Jury Box
- Lectern (movable), accommodate a microphone and task lighting
- (65-85 & 4 wheelchair) Spectator Seating

Furniture and Equipment:

- Judge's chair: swivel, tilt
- (4) Task chair (deputy clerk): swivel
 - (2) Deputy clerks
 - (1) Court reporter/recorder
 - (1) Law clerk
- (1) Chair (interpreter): swivel, movable
- (1) Chair (witness): swivel, movable
- (16) Chair (jury): swivel, fixed, (2) removable*
- Chairs (attorney and litigants): (4) seats per table max, extra chairs to be stored outside of courtroom
- Chairs (USMS personnel): movable
- (4) Tables for attorneys and litigants*
- (1) Clock

Courtrooms

Space and Ceiling Requirements

District Judge Courtroom

2,400 NSF (223 Nm²)

Legend:

- ① Spectator Seating
- ② Movable Rail
- ③ Movable "Smart" Table
- ④ Jury Box
- ⑤ Witness Box
- ⑥ Judge's Bench
- ⑦ Law Clerk Station
- ⑧ Court Reporter/Deputy Clerk Station
- ⑨ Lectern

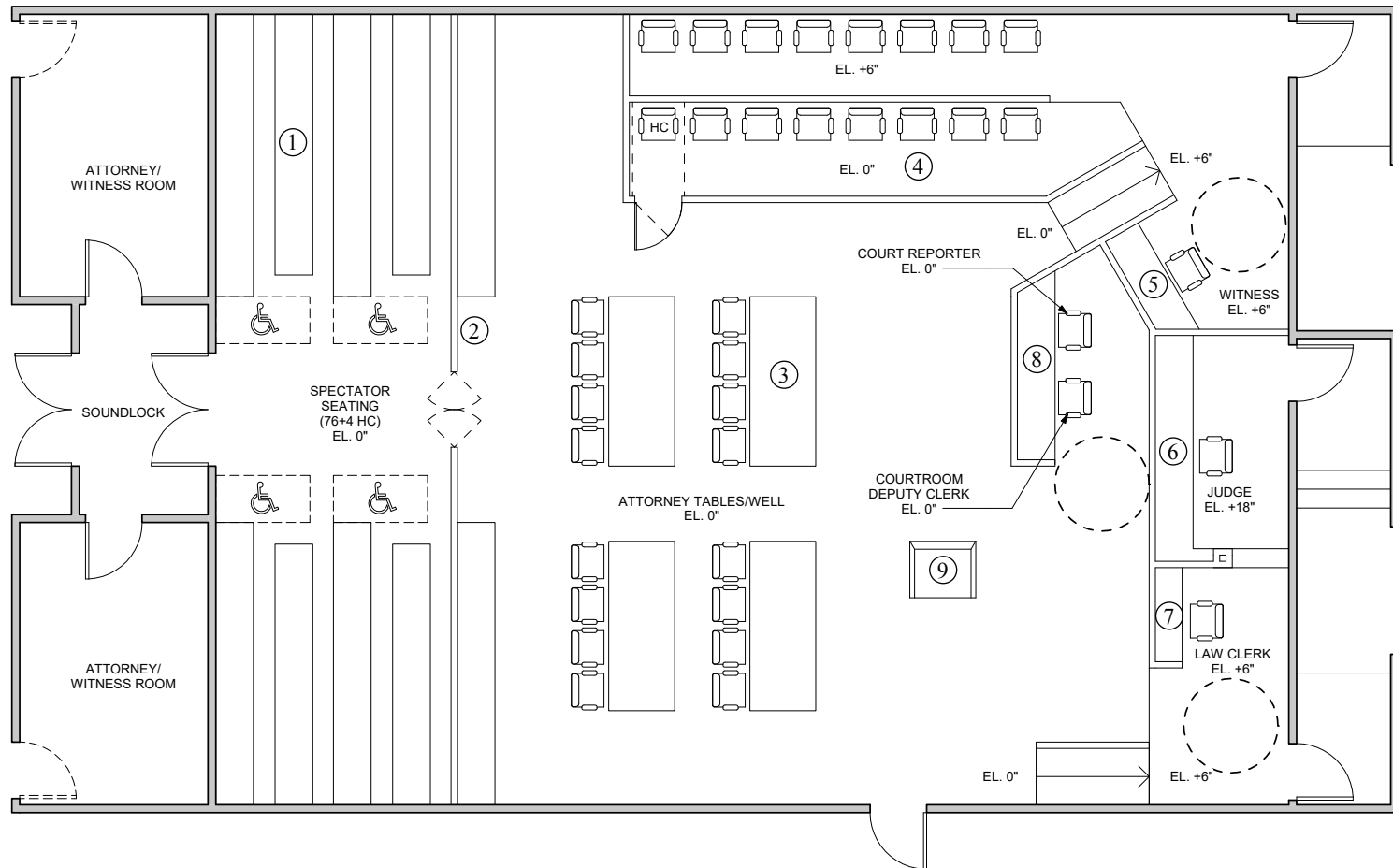

Courtrooms

Space and Ceiling Requirements

Magistrate Judge Courtroom 1,800 NSF (167.2 Nm²)

Architectural:

General Requirements:

Security Level:	Restricted 3, Public 3
Adjacent to:	Public Waiting Area
Ceiling Height:	16'-0"
Acoustics	NIC 55-60 - Confidential

Finishes:

Wall:	WD, ST, MTL, AWP, PLAS, PNT-1
Floor:	CPT, WD, RAF
Base:	WD, V/RB
Ceiling:	WD, MTL, ACP, PNT-1

Building Systems:

Illumination (Horizontal/Vertical):

Judge’s Bench	50-55 fc / 20-25 fc
Court Reporter	50-55 fc / 20-25 fc
Jury Box	50-55 fc / 20-25 fc
Attorney Witness Area	40-50 fc / 15-20 fc
Witness Box	40-50 fc / 15-20 fc
News Media Room	30-40 fc / 15-20 fc
Attorney Work Room	30-40 fc / 15-20 fc
Attorney/Witness Room	30-40 fc / 15-20 fc
Public Seating	40-50 fc / 5-10 fc

Lighting Control:	Yes
Emergency Power:	Yes
Emergency Lighting:	Yes

Mechanical:

Air Changes:	8-10/hour
--------------	-----------

Building Systems (con’t):

Security:

- CCV camera
- Duress alarm
- Card reader
- Walk-through metal detector (only for trials with high security)
- Ballistic-resistant material capability at judge’s bench and deputy clerk station
- (2) 120-volt outlets connected to emergency generators outside of courtroom

Millwork

- (1) Judge’s bench
- (1-2) Deputy clerk station
- Evidence cabinet
- (1) Court reporter/recorder station
- Recording equipment cabinet
- (1) Law clerk station
- (1-2) Witness box
- (12) Jury Box
- Lectern (movable), accommodate a microphone and task lighting (55-60 & 4 wheelchair) Spectator Seating

Furniture and Equipment

- (1) Judge’s chair: swivel, tilt
- (4) Task chair: swivel
 - (2) Deputy clerks
 - (1) Reporter/recorder
 - (1) Law clerk
- (1) Chair (interpreter): swivel, movable
- (1) Chair (witness): swivel, movable
- (12) Chair (jury): swivel, fixed, 2 removable*
- (2) Tables for attorneys and litigants*
- Chairs (attorney and litigant) (4) chairs per table max, extra chairs to be stored outside of courtroom
- Chairs (USMS personnel): movable
- (1) Clock

Courtrooms

Space and Ceiling Requirements

Magistrate Judge Courtroom

1,800 NSF (167.2 Nm²)

Legend:

- ① Spectator Seating
- ② Movable Rail
- ③ Movable “Smart” Table
- ④ Jury Box
- ⑤ Witness Box
- ⑥ Judge’s Bench
- ⑦ Law Clerk Station
- ⑧ Court Reporter/Deputy Clerk Station
- ⑨ Lectern

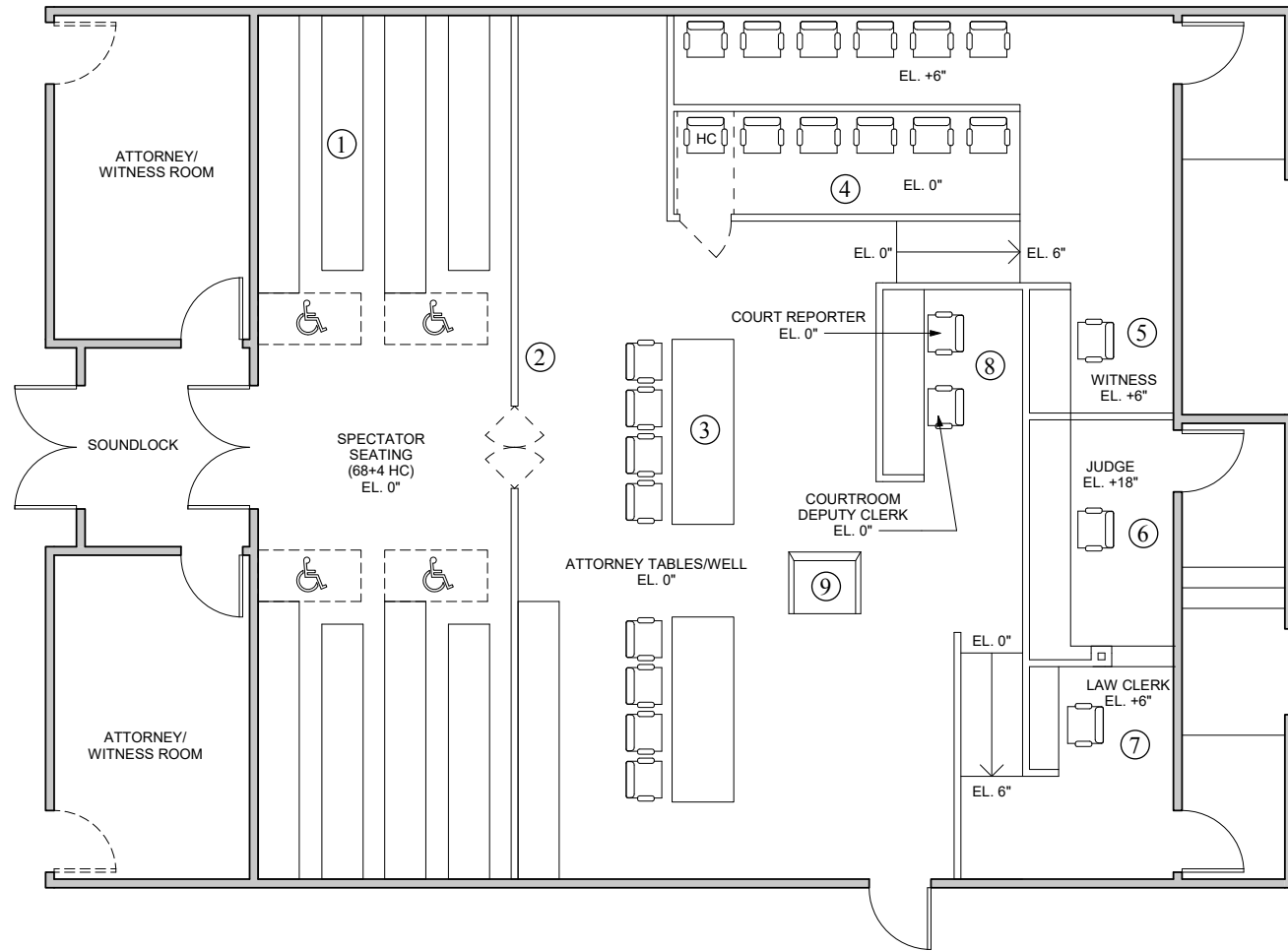

Courtrooms

Space and Ceiling Requirements

Bankruptcy Judge Courtroom 1,800 NSF (167.2 Nm²)

Architectural:

General Requirements:

Security Level:	Public 3, Restricted 3
Adjacent to:	Public Waiting Area
Ceiling Height:	16'-0"
Acoustics	NIC 55-60 - Confidential

Finishes:

Wall:	WD, ST, MTL, AWP, PLAS, PNT-1
Floor:	CPT, WD, RAF
Base:	WD, V/RB
Ceiling:	WD, MTL, ACP, PNT-1

Building Systems:

Illumination (Horizontal/Vertical):

Judge's Bench	50-55 fc / 20-25 fc
Court Reporter	50-55 fc / 20-25 fc
Jury Box	50-55 fc / 20-25 fc
Attorney Witness Area	40-50 fc / 15-20 fc
Witness Box	40-50 fc / 15-20 fc
News Media Room	30-40 fc / 15-20 fc
Attorney Work Room	30-40 fc / 15-20 fc
Attorney/Witness Room	30-40 fc / 15-20 fc
Public Seating	40-50 fc / 5-10 fc

Lighting Control:	Yes
Emergency Power:	Yes
Emergency Lighting:	Yes

Mechanical:

Air Changes:	6-8/hour
--------------	----------

Building Systems (con't):

Security:

- CCV camera
- Duress alarm
- Card reader
- Walk-through metal detector (only for trials with high security)
- Ballistic-resistant material capability at judge's bench and deputy clerk station
- (2) 120-volt outlets connected to emergency generators outside of courtroom

Millwork

- (1) Judge's bench
- (1-2) Deputy clerk station
- (1) Court reporter/recorder station
- Recording equipment cabinet
- (1) Law clerk station
- (1-2) Witness box
- Lectern (movable), accommodate a microphone and task lighting
- (75-82 and four wheelchairs) Spectator seating

Furniture and Equipment

- (1) Judge's chair: swivel, tilt
- (4) Task chair: swivel
 - (2) Deputy clerks
 - (1) Court reporter/recorder
 - (1) Law clerk
- (1) Chair (interpreter): swivel, movable
- (1) Chair (witness): swivel, movable
- (2) Tables for attorneys and litigant*
- Chair (attorney and litigants): (4) chairs per table, extra chairs to be stored outside of courtroom
- (1) Clock

Courtrooms

Space and Ceiling Requirements

Bankruptcy Judge Courtroom 1,800 NSF (167.2 Nm²)

Legend:

- ① Spectator Seating
- ② Movable Rail
- ③ Movable “Smart” Table
- ④ Witness Box
- ⑤ Judge’s Bench
- ⑥ Law Clerk Station
- ⑦ Court Reporter/Deputy Clerk Station
- ⑧ Lectern

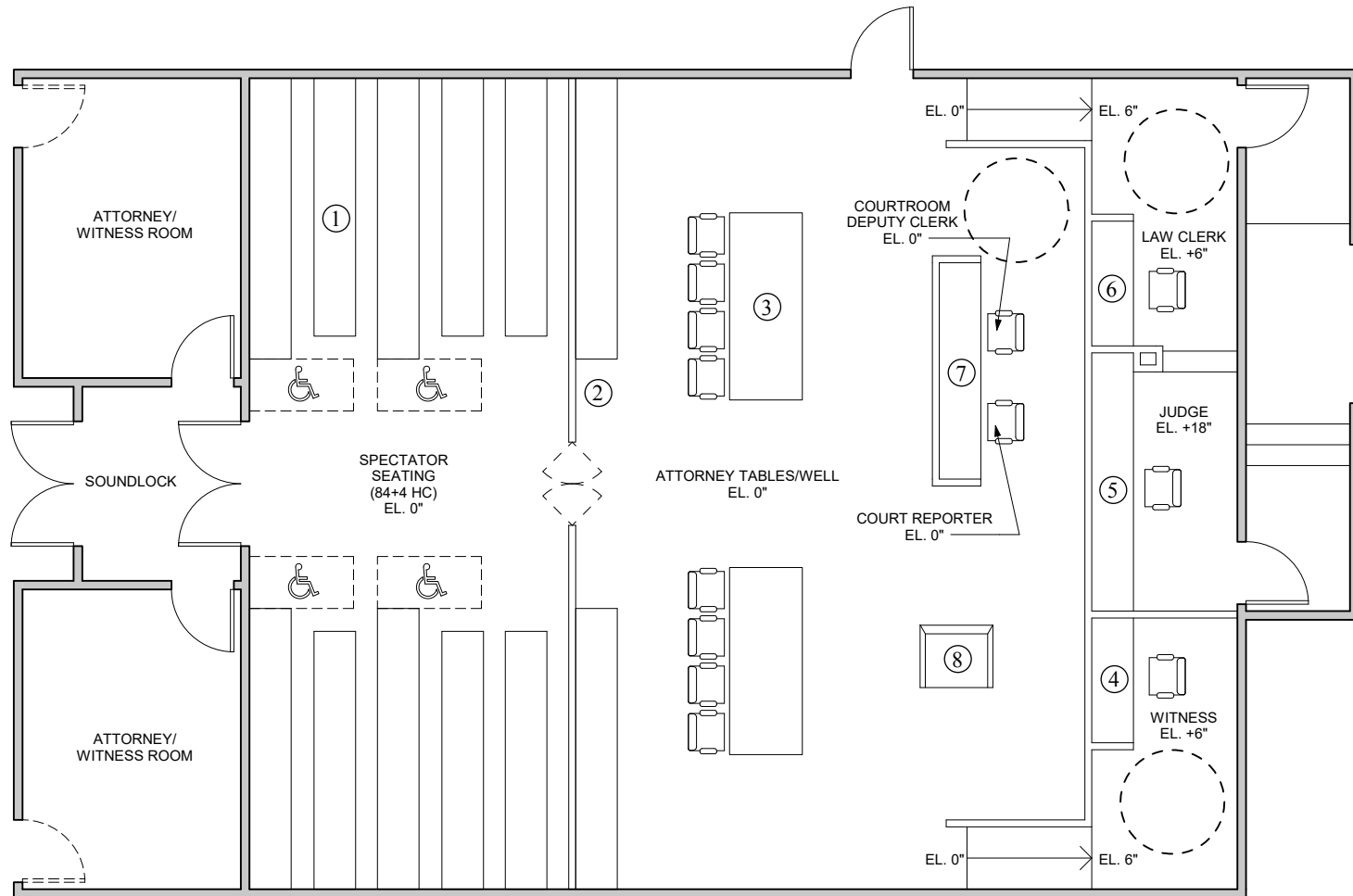

Associated Courtroom Spaces

Space and Ceiling Requirements

CH. 4

Public Waiting Area

400 NSF (37.2 Nm²)

Architectural:

General Requirements:

Security Level: Public 2
Adjacent to: Courtroom
Acoustics: NIC 25 - Normal

Finishes:

Wall: ST, WD, GL, MTL, PNT-1
Floor: TZ, ST
Base: TZ, ST
Ceiling: ACP, WD, MTL, PNT-1

Building Systems:

Security:

- CCV camera

Fixtures, Furniture, and Equipment (FFE):

- (TBD) Benches

Space Notes:

1. The design and furnishings for the public waiting areas should be consistent with the design intent of the public lobby and public circulation.

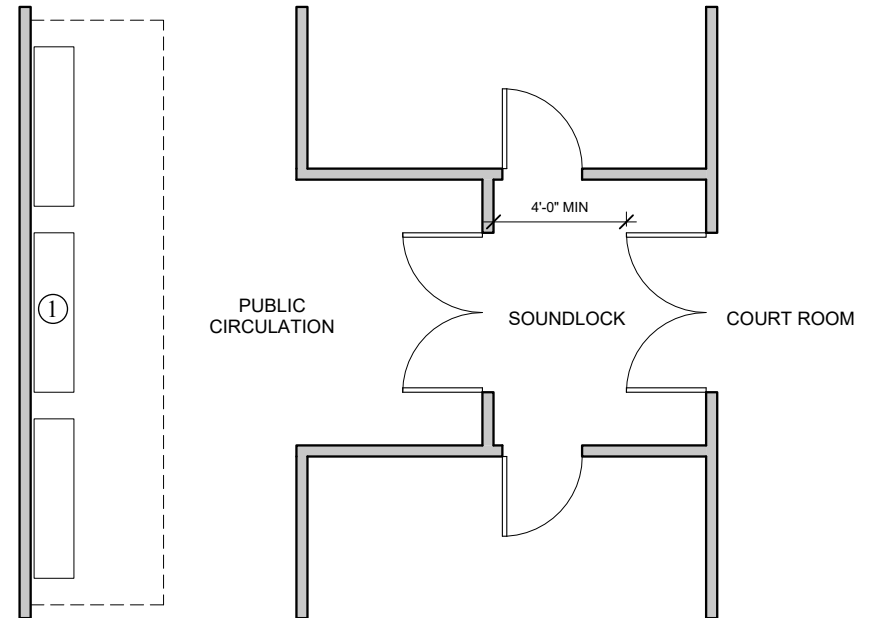

Legend:

① Benches

Associated Courtroom Spaces

Space and Ceiling Requirements

CH. 4

Judges' Conference Room

250 NSF (23.3 Nm²)

Architectural:

General Requirements:

Security Level: Restricted 3
 Adjacent to: Robing Room
 Ceiling Height: 10'-0"
 Acoustics: NIC 55 - Confidential

Finishes:

Wall: WD, PNT-1, FWC
 Floor: CPT, WD
 Base: WD, V/RB
 Ceiling: ACP, PNT-1

Building Systems:

Illumination:

Horizontal: 30-50 fc
 Vertical: 10-15 fc
 Lighting Control: Yes
 Emergency Lighting: Yes

Mechanical:

Air Changes: 8/hour

Security:

- (2) Duress alarms
- Door Contact

Fixtures, Furniture, and Equipment (FFE)

- Service unit: (1) sink, (1) microwave, and (1) refrigerator
- (TBD) Conference table
- (TBD) Chairs

Space Notes:

1. Allocation of 250 NSF (23.3 Nm²) includes a service unit.

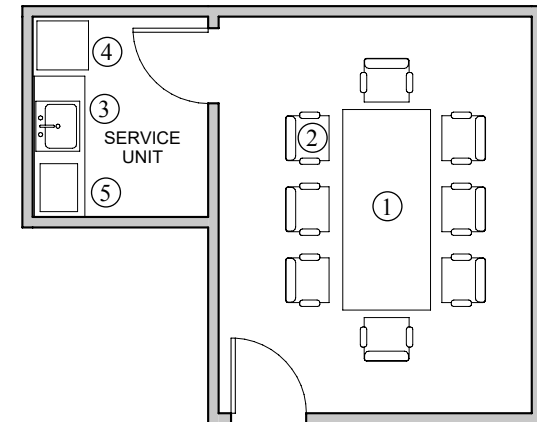
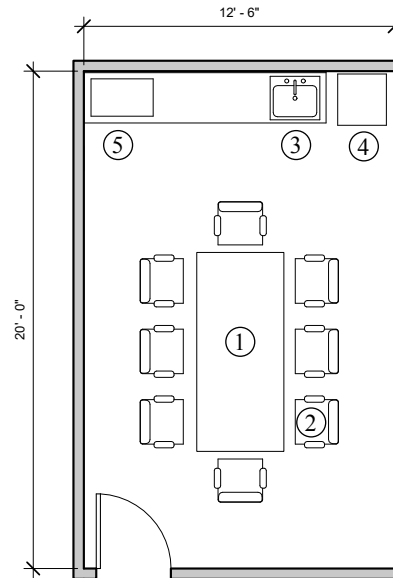

Legend:

- ① Conference Table
- ② Chairs
- ③ Sink
- ④ Refrigerator
- ⑤ Microwave

Associated Courtroom Spaces
Space and Ceiling Requirements

Judges' Robing Room

Soundlock	80 NSF (7.4 Nm²)
Toilet 1	50 NSF (4.7 Nm²)
Toilet 2	50 NSF (4.7 Nm²)

Architectural:

General Requirements:

Security Level:	Restricted 3, Restricted 1
Adjacent to:	Courtroom, Judge's Conference Room
Ceiling Height:	10'-0"
Acoustics	NIC 40 - Normal

Finishes:

Wall:	WD, PNT-1, FWC
Floor:	CPT, WD
Base:	WD, V/RB
Ceiling:	ACP, PNT-1

Building Systems:

Illumination:

Horizontal:	20-30 fc
Vertical:	5-10 fc
Lighting Control:	Yes

Mechanical:

Air Changes:	8/hour
--------------	--------

Security

- Duress alarm
- Door control

Space Notes:

1. Allocate 100 NSF (9.3 Nm²) plus 25 NSF (2.3 Nm²) per judge for judges' robing room.

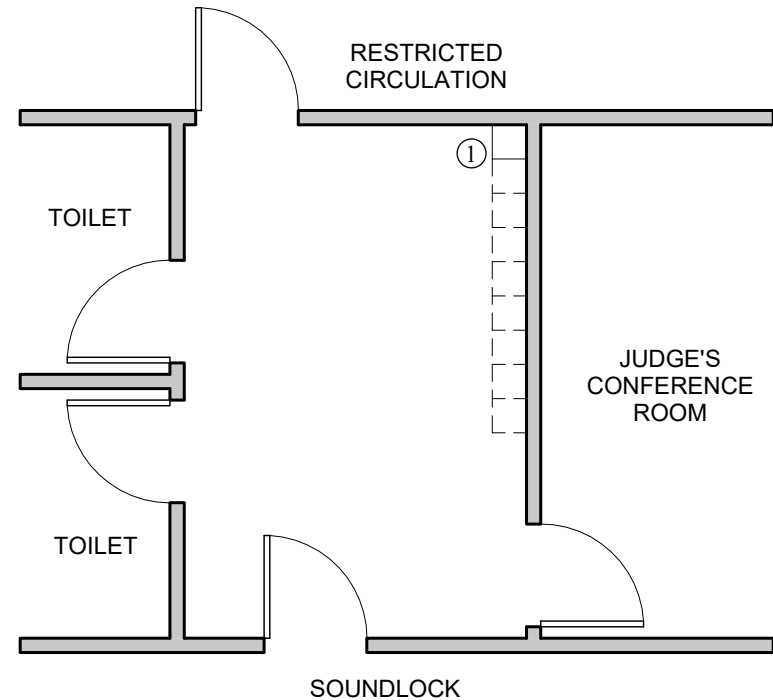

Legend:

- ① Full-Height Locker (quantity based on number of judges)

Associated Courtroom Spaces

Space and Ceiling Requirements

CH. 4

Attorney Waiting Area Attorney Work Room

100 NSF (9.3 Nm²)
250 NSF (23.3 Nm²)

Architectural:

General Requirements:

Security Level:	Public 2
Adjacent to:	Public Waiting Area
Ceiling Height:	10'-0"
Acoustics:	NIC 40 - Normal

Finishes:

Wall:	PNT-1
Floor:	CPT
Base:	V/RB
Ceiling:	ACP

Building Systems:

Illumination:

Horizontal:	30-40 fc
Vertical:	15-20 fc
Lighting Control:	Yes

Fixtures, Furniture, and Equipment (FFE):

- (TBD) Benches

Space Notes:

1. Furniture for the attorney work area shall not be funded by Judiciary.
2. Only one per courthouse, not per courtroom.
3. Attorney work area and attorney waiting area may be combined into one space.

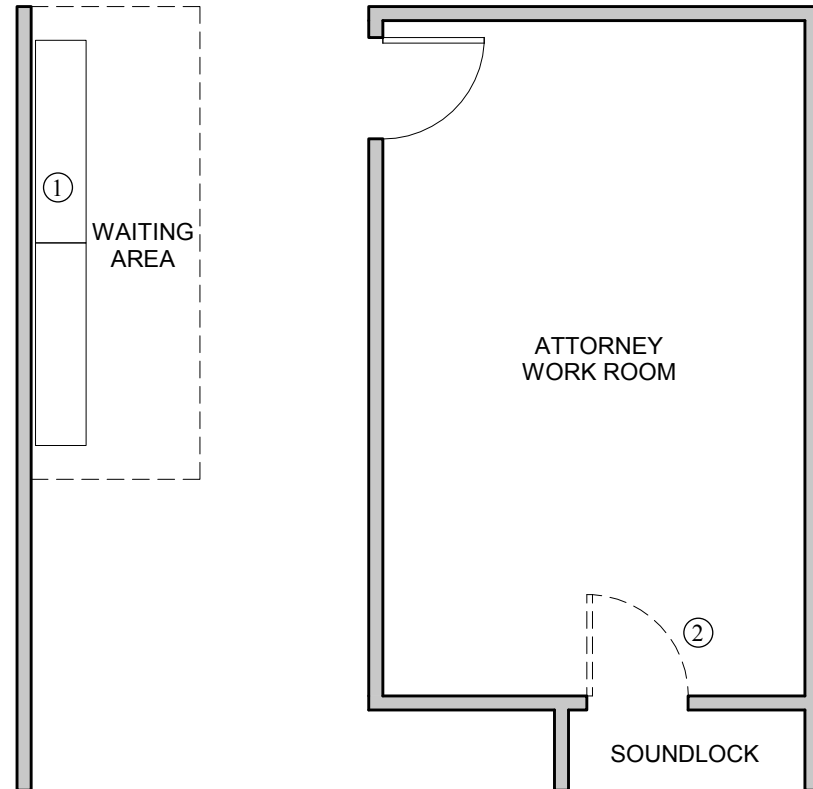

Legend:

- ① Benches
- ② (Optional) Entry to Courtroom Soundlock

Associated Courtroom Spaces

Space and Ceiling Requirements

Judges' Conference/Robing Room 200 NSF (18.6 Nm²)

Architectural:

General Requirements:

Security Level:	Restricted 3
Adjacent to:	Courtroom
Ceiling Height:	10'-0"
Acoustics	NIC 40 - Normal

Finishes:

Wall:	WD, PNT-1, FWC
Floor:	CPT, WD
Base:	WD, V/RB
Ceiling:	ACP, PNT-1

Building Systems:

Illumination:

Horizontal:	30-50 fc
Vertical:	10-15 fc
Lighting Control:	Yes
Emergency Lighting:	Yes

Mechanical:

Air Changes:	8/hour
--------------	--------

Security:

- Duress alarm
- Door Control

Fixtures, Furniture, and Equipment (FFE)

- Lockers, quantity to be determined by court: individual full-sized lockers, 12"W x 12"D x 72"H, with one shelf and coat rod

Space Notes:

1. Provide judges' conference/robing room when chambers are located on a separate floor (collegial design).

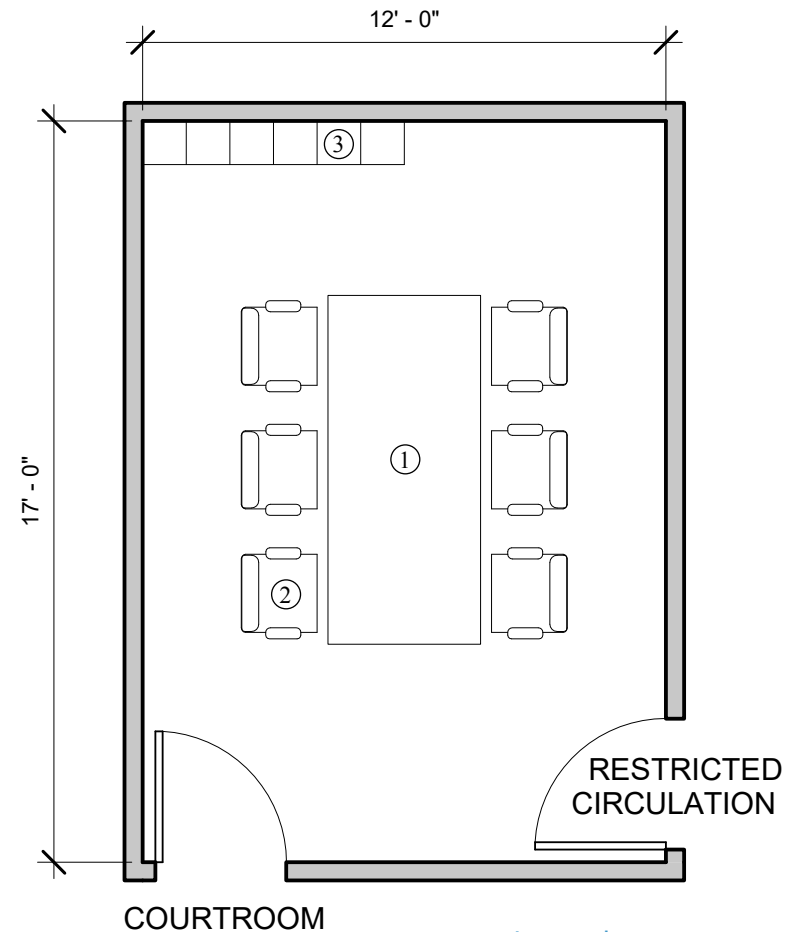

Legend:

- ① Table
- ② Chair
- ③ Full-Height Locker

Associated Courtroom Spaces

Space and Ceiling Requirements

CH. 4

Attorney/Witness Room

150 NSF (14.0 Nm²)

Architectural:

General Requirements:

Security Level:	Public 2
Adjacent to:	Soundlock, Public Waiting Area
Ceiling Height:	10'-0"
Acoustics:	NIC 55 - Confidential

Finishes:

Wall:	PNT-1, CR
Floor:	CPT
Base:	V/RB, WD
Ceiling:	ACP

Building Systems:

Illumination:

Horizontal:	30-40 fc
Vertical:	15-20 fc
Lighting Control:	Yes

Fixtures, Furniture, and Equipment (FFE)

- (1) Small conference table
- (4) Arm chairs

Space Notes:

1. Provide occupancy indicator for each attorney/witness room.

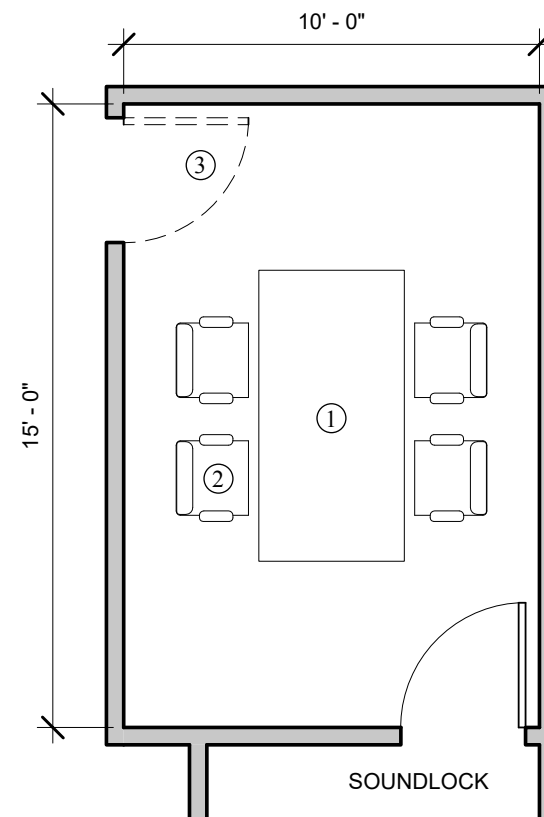

Legend:

- ① Table
- ② Chair
- ③ (Optional) Door into Public Corridor

Associated Courtroom Spaces

Space and Ceiling Requirements

CH. 4

Shared Workroom

100 NSF (9.3 Nm²)

Architectural:

General Requirements:

Security Level: Restricted 1
Adjacent to: Reporter/Recorder Office

Finishes:

Wall: PNT-1
Floor: VCT
Base: V/RB
Ceiling: ACP

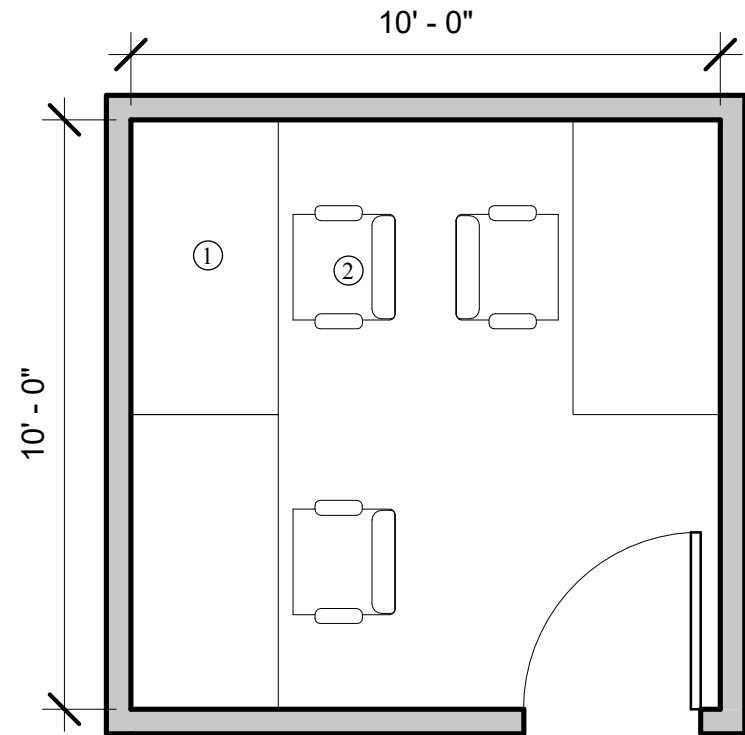

Legend:

- ① Desk
- ② Chair

Associated Courtroom Spaces

Space and Ceiling Requirements

CH. 4

Audiovisual Equipment Room

120 NSF (11.1 Nm²)

Architectural:

General Requirements:

Security Level: Restricted 3
Adjacent to: Courtroom

Finishes:

Wall: PNT-1
Floor: VCT
Base: V/RB
Ceiling: ACP, Open

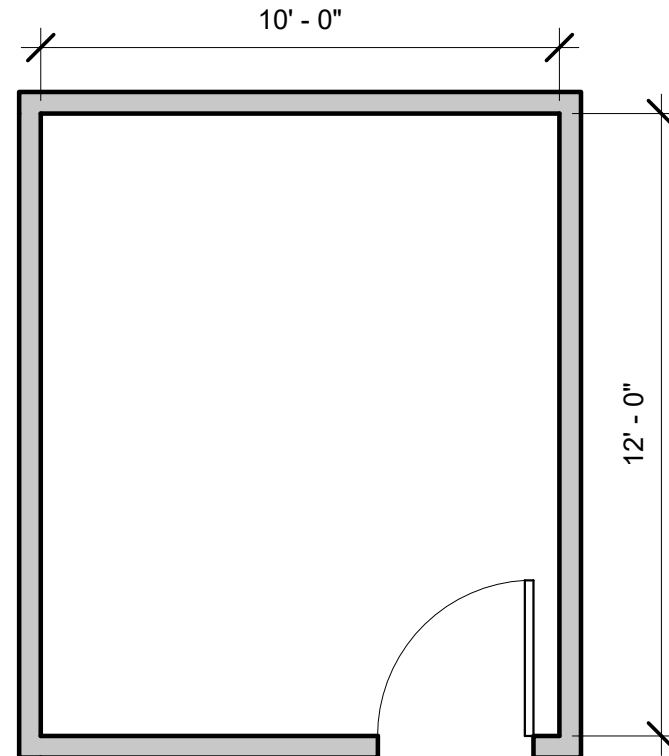

Jury Assembly Suite

Space and Ceiling Requirements

CH. 5

Check-In

100 NSF (9.3 Nm²)

Architectural:

General Requirements:

Security Level:	Public 3
Adjacent to:	Reception
Ceiling Height:	10'-0"
Acoustics	NIC 35 - Normal

Finishes:

Wall:	PNT-1
Floor:	CPT
Base:	V/RB
Ceiling:	ACP

Building Systems:

Illumination:

Horizontal:	30-40 fc
Vertical:	5-10 fc
Lighting Control:	Yes

Mechanical:

Air Changes:	8/hour
--------------	--------

Security:

Duress Alarm:	Yes
---------------	-----

Fixtures, Furniture, and Equipment (FFE)

- (1) Transaction Counter
 - Glass security window with transaction tray

Space Notes:

- Outlet for wall-mounted clock.
- Check-in has direct visual observation of assembly room and jury assembly suite front door.
- Ballistic-resistant transaction windows may be required.

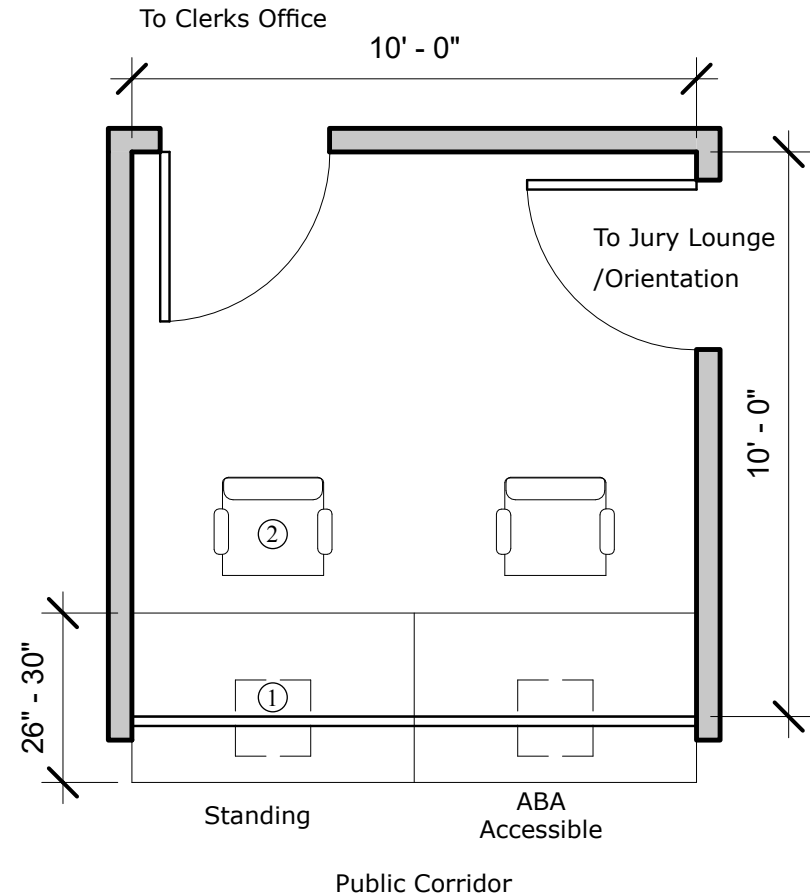

Legend:

- ① Transaction Counter
- ② Chair

Jury Assembly Suite

Space and Ceiling Requirements

CH. 5

Vending Area

Per machine

15 NSF (1.4 Nm²)

Architectural:

General Requirements:

Security Level:	Restricted 1
Adjacent to:	Service Unit
Ceiling Height:	10'-0"
Acoustics	NIC 35 - Normal

Finishes:

Wall:	PNT-2
Floor:	VCT
Base:	V/RB
Ceiling:	ACP

Building Systems:

Illumination:

Horizontal:	30-40 fc
Vertical:	5-10 fc
Lighting Control:	No

Mechanical:

Air Changes:	8/hour
--------------	--------

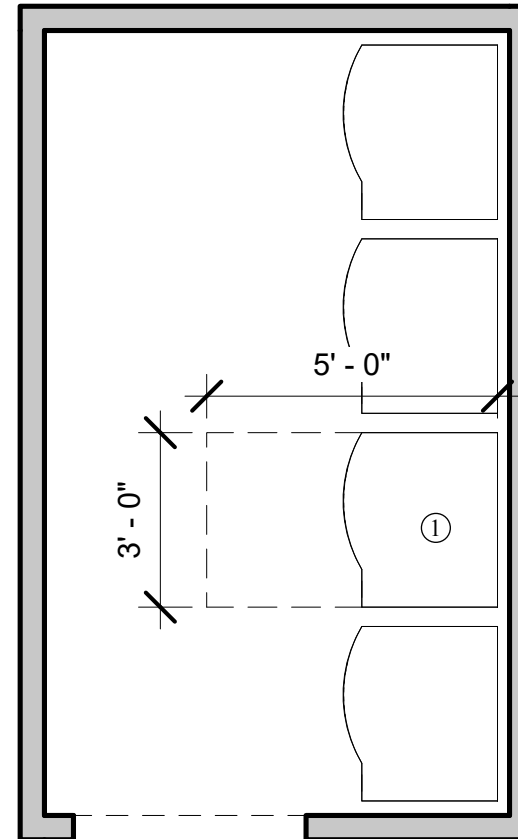

Legend:

① Vending Machines

Jury Assembly Suite
Space and Ceiling Requirements

Juror Lounge, per person 20 NSF (1.9 Nm²)

Architectural:

General Requirements:

Security Level:	Restricted 1
Adjacent to:	Assembly Area
Ceiling Height:	10'-0" (Recommended)
Acoustics	NIC 35 - Normal

Finishes:

Wall:	WD, MTL, WP, PNT-1
Floor:	CPT
Base:	V/RB, WD
Ceiling:	EXP, ACP, WD, MTL, ACP, PNT-1

Building Systems:

Illumination:

Horizontal:	30-40 fc
Vertical:	5-10 fc
Lighting Control:	Yes

Mechanical:

Air Changes:	8/hour
--------------	--------

Fixtures, Furniture, and Equipment (FFE)

- Lounge Seating: Comfortable armchairs and/or modular sectional sofas. (Judiciary)
- Chairs: A movable chair should be provided at counter. (Judiciary)
- Magazine racks: A wall-mounted magazine & book rack should be provided near lounge areas. (Judiciary)
- (1) Mounted TV monitor (Judiciary)

Space Notes:

1. Jury lounge space for 20 percent of jurors.
2. Natural light is desirable.

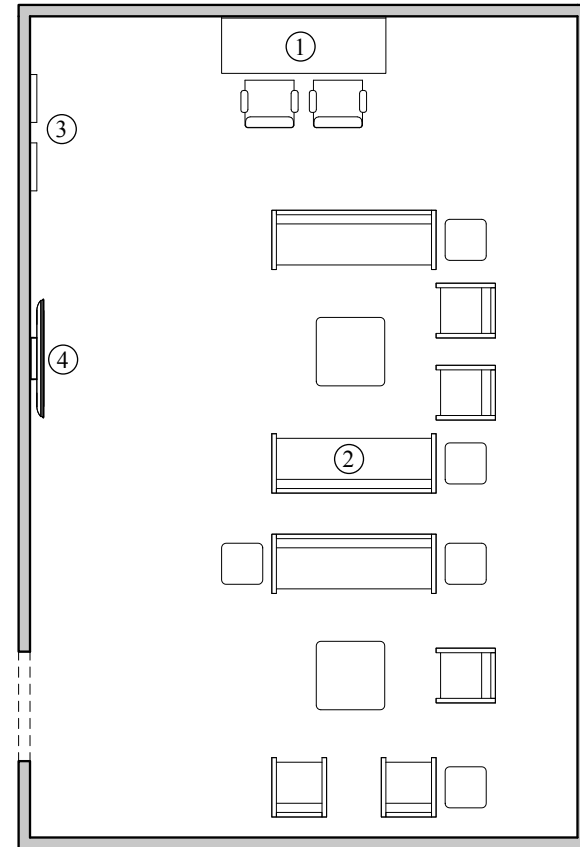

Legend:

- | | |
|---|-------------------------------|
| ① Counter with Telephone/Data and movable seating | ③ Wall Mounted Magazine Racks |
| ② Lounge Seating | ④ Mounted TV Monitor |

Jury Assembly Suite

Space and Ceiling Requirements

CH. 5

Orientation Area, per person

10 NSF (0.93 Nm²)

Architectural:

General Requirements:

Security Level: Restricted 1
 Ceiling Height: 12'-0"
 Acoustics: NIC 35 - Normal

Finishes:

Wall: WD, MTL, WP, PNT-1
 Floor: CPT
 Base: V/RB, WD
 Ceiling: EXP, ACP, WD, MTL, ACP, PNT-1

Building Systems:

Illumination:

Horizontal: 30-40 fc
 Vertical: 5-10 fc
 Lighting Control: Yes

Mechanical:

Air Changes: 8/hour

Fixtures, Furniture, and Equipment (FFE)

- Chairs: Armchairs with fold-up tablet arms may be provided for prospective jurors. (Judiciary). A movable chair should be provided at each carrel. (Judiciary)
- Tables: Movable tables, at least 36"x36" (925mm x 925mm) required. Min one table should be accessible by a wheelchair. (Judiciary)
- (1) Lectern (Judiciary)
- (TBD) TV stand(s), TV monitor(s), screen(s). (Judiciary)

Space Notes:

1. Outlets for monitors, projectors, or audiovisual equipment should be provided; orientation room and all areas opening to it require lighting control for audiovisual presentations.

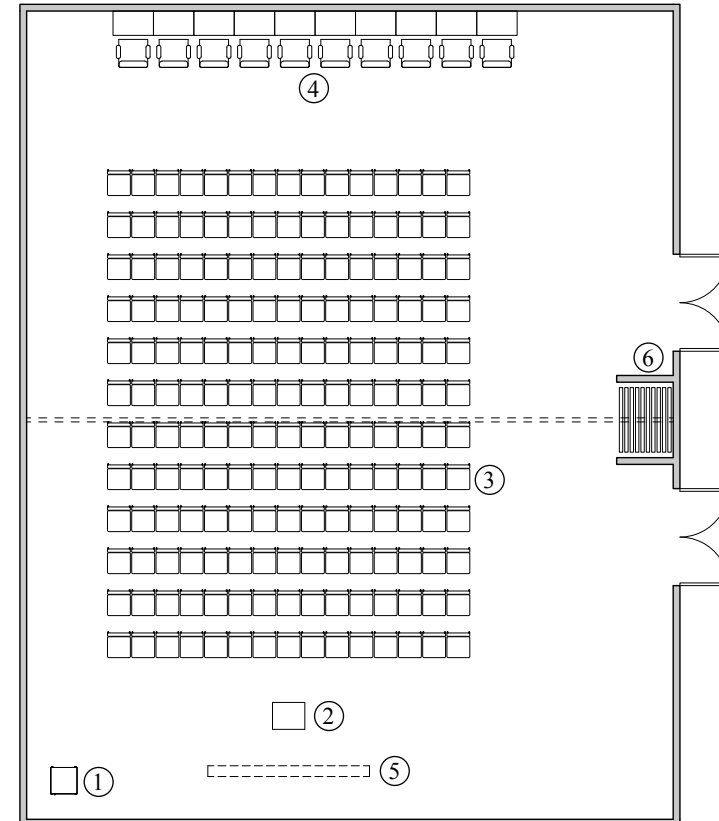

Legend:

- | | |
|---|---|
| ① Optional cart-mounted video projection system | ④ Carrel seating with Internet |
| ② Movable Podium | ⑤ Optional projection screen or rear projection screen (verify) |
| ③ Seating | ⑥ Movable Partition |

Trial Jury Suite
Space and Ceiling Requirements

Multi-Party	500 NSF (46.4 Nm²)
District Judge	350 NSF (32.5 Nm²)
Magistrate Judge	250 NSF (23.2 Nm²)

Architectural:

General Requirements:

Security Level:	Restricted 1
Ceiling Height:	10'-0" (Recommended)
Acoustics	NIC 55 - Confidential (Entire Jury Suite)

Finishes:

Wall:	PNT-1
Floor:	CPT
Base:	V/RB, WD
Ceiling:	ACP

Building Systems:

Illumination:

Horizontal:	30-40 fc
Vertical:	5-10 fc
Lighting Control:	No

Mechanical:

Air Changes:	8/hour
--------------	--------

Fixtures, Furniture, and Equipment (FFE)

- (TBD) Visual display board: Screen, tackboard, magnetic whiteboard (Judiciary)
- (TBD) Video monitor station: Provision for video reproduction equipment, movable. (Judiciary)
- (1) Conference table (Judiciary)
- (7-18) Conference chairs: Swivel base with arms, movable. (Judiciary)
- (1) Visual display board: Wall-mounted screen, tackboard, whiteboard (magnetic), 18"x24" (450mm x 600mm). (Judiciary)

Space Notes:

1. One jury deliberation room at 500 NSF (46.4Nm²) should be provided for every four district judge courtrooms. In courthouses with fewer than four district courtrooms, one of the jury deliberation rooms to be constructed should be 500 NSF (46.4 Nm²). If a multi-party courtroom is planned, the 500 NSF (46.4Nm²) jury deliberation room should be adjacent.
2. Combination of direct/indirect lighting. Jurors need direct component when reviewing reading material. When exhibits are viewed on a projection screen or TV monitor, the indirect units can be switched off, & the direct units dimmed, leaving sufficient residual lighting to take notes.
3. Provide additional 10 NSF (0.93 Nm²) for video equipment closet.
4. FFE requirements should be determined on a project-to-project basis to satisfy the local needs. FFE shown on the graphic is notional.

Trial Jury Suite

Space and Ceiling Requirements

CH. 5

Multi-Party
District Judge
Magistrate Judge

500 NSF (46.4 Nm²)
350 NSF (32.5 Nm²)
250 NSF (23.2 Nm²)

Legend:

- ① Projection Screen, Whiteboard & Display Board Rail (Exhibits Display)
- ② Coat Closet
- ③ Service Unit
- ④ TV/Video Monitor on Cart
- ⑤ High Window, sill @ 6'-0" min with sun control (if provided) & black out shade

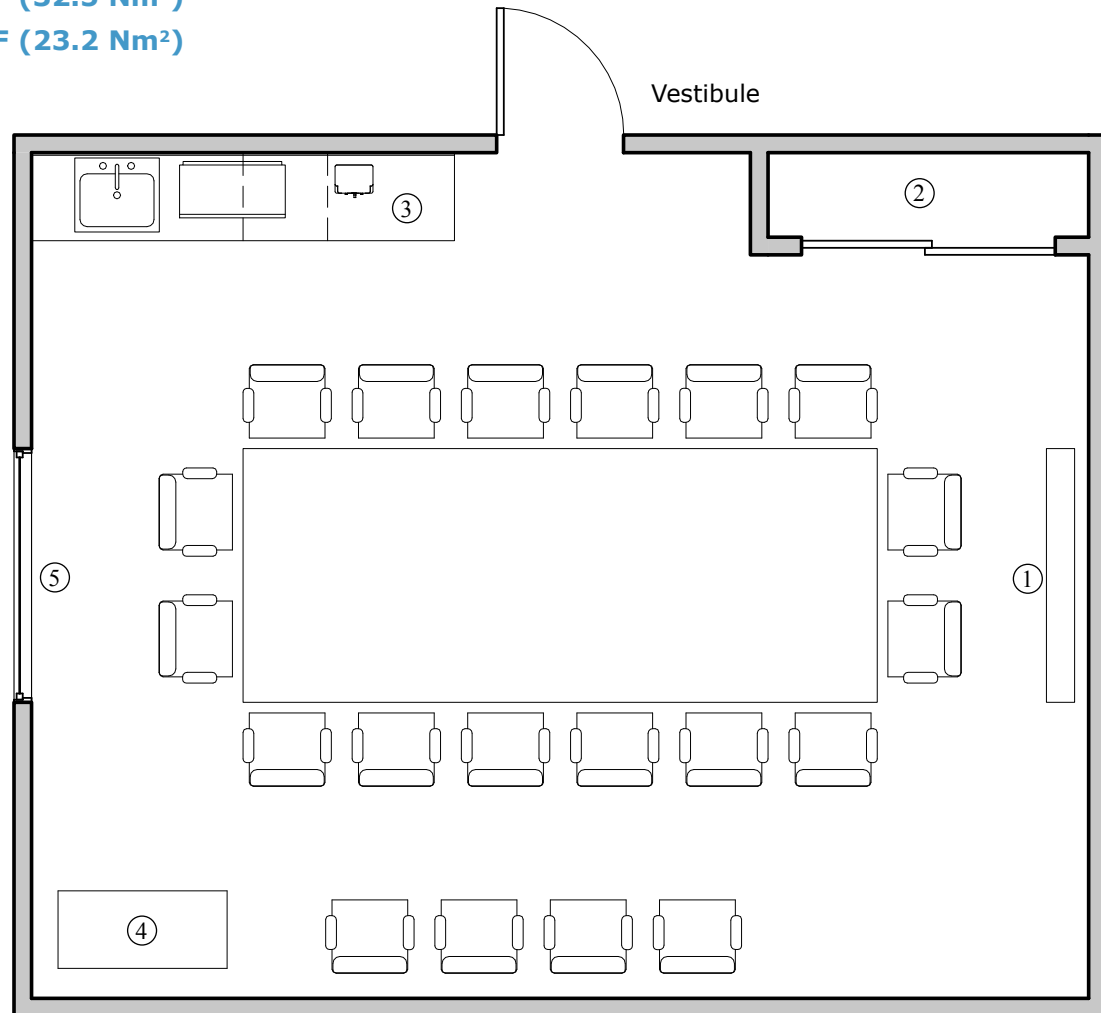

Grand Jury Suite

Space and Ceiling Requirements

CH. 5

Witness Room

Minimum

120 NSF (18.6 Nm²)

Maximum

200 NSF (18.6 Nm²)

Architectural:

General Requirements:

Security Level: Restricted 1
Acoustics: NIC 55 - Confidential

Finishes:

Wall: PNT-1, CR
Floor: CPT
Base: V/RB, WD
Ceiling: ACP

Building Systems:

Illumination:

Horizontal: 30-40 fc
Vertical: 5-10 fc
Lighting Control: Dimmer

Mechanical:

Air Changes: 8/hour

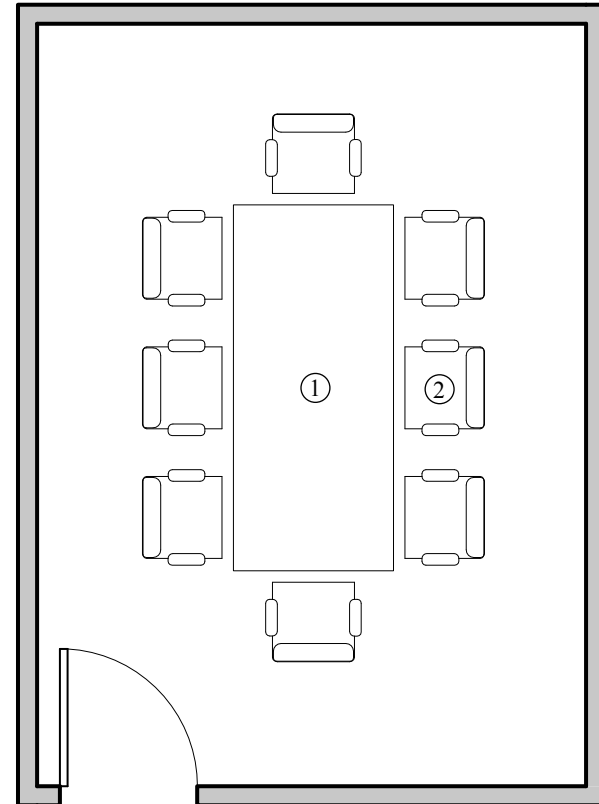

Legend:

① Table

② Chair

Grand Jury Suite

Space and Ceiling Requirements

Hearing Room

700 NSF (65 Nm²)

Architectural:

General Requirements:

Security Level: Restricted 3 - Secure 1
 Adjacent to: Restricted Circulation
 Ceiling Height: 11'-0"
 Acoustics: NIC 55-60 - Confidential

Finishes:

Wall: PNT-1
 Floor: CPT
 Base: V/RB
 Ceiling: ACP

Building Systems:

Illumination:

Horizontal: 50-55 fc
 Vertical: 10-15 fc
 Lighting Control: Dimmer

Mechanical:

Air Changes: 8/hour

Security:

- Duress alarm, at U.S. Attorney's table

Fixtures, Furniture, and Equipment (FFE)

- (16-23) Chairs: Fixed-base swivel armchairs. Provide writing surface, either table arms on the chairs or separate tables or counters. The writing table should not exceed 18" (450mm) in depth with modesty panel. (GSA)
- (TBD) Chairs: With arms, swivel base, movable, for attorney, grand jury foreperson, grand jury secretary, witness, interpreter, & court reporter/recorder.
- (TBD) Visual display board: Wall-mounted screen, tackboard, whiteboard (magnetic), 18" (450mm) by 24" (600mm). (Judiciary)
- Verify with court regarding need for fixed seating, movable seating & tiered seating.
- Ceiling to be 10'-0" above the highest tier of juror seating.

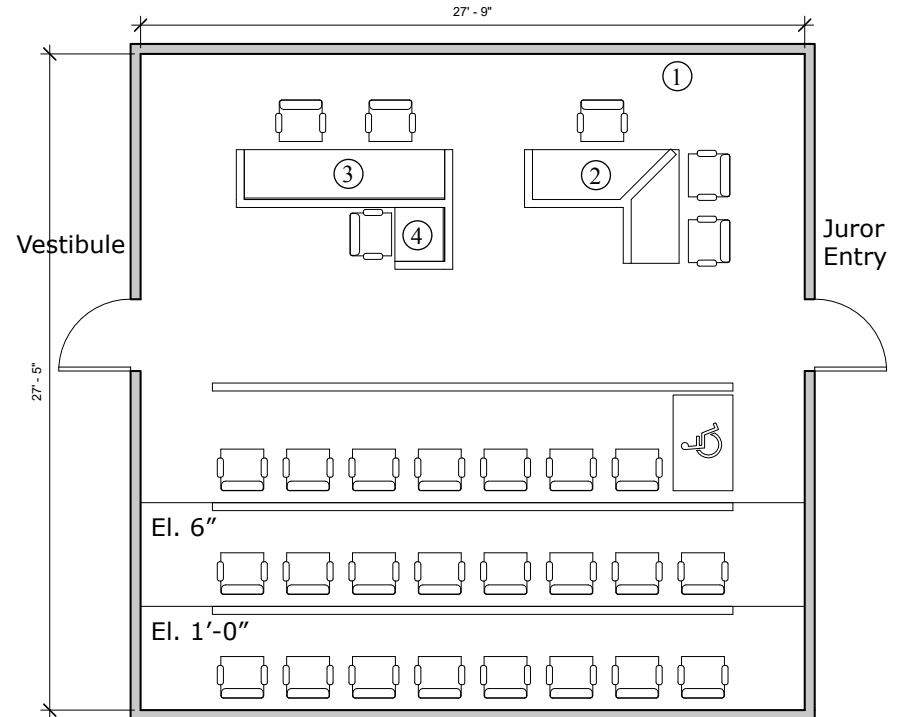

Legend:

- ① Exhibits/Display
- ② Witness
- ③ U.S. Attorney's Table w/ Duress Alarm
- ④ Court Reporter

Associated Jury Suite Spaces

Space and Ceiling Requirements

Video Equipment Closet

50 NSF (4.7 Nm²)

Architectural:

General Requirements:

Security Level:

Finishes:

Wall: PNT-1
Floor: CPT, VCT
Base: V/RB
Ceiling: ACP

Building Systems:

Illumination:

Horizontal: 30-40 fc
Vertical: 5-10 fc
Lighting Control: Dimmer

Mechanical:

Air Changes: 8/hour

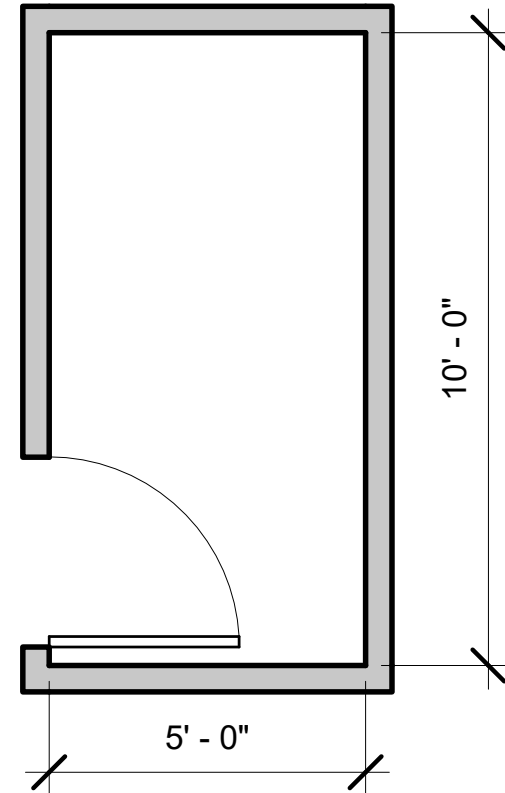

Judges' Chambers Suites

Space and Ceiling Requirements

CH. 6

Circuit Judge's Chambers Office

600 NSF (55.8 Nm²)

Architectural:

General Requirements:

Security Level:	Restricted 1, 3
Adjacent to:	Conference/Reference Room, Reception Area, Vestibule
Ceiling Height:	10'-0"
Acoustics:	NIC 50 - Confidential

Finishes:

Wall:	WD, PNT-1, FWC, WD Wainscot
Floor:	CPT, WD
Base:	V/RB, WD
Ceiling:	ACP, PNT-1

Building Systems:

Illumination:

Horizontal:	30-50 fc
Vertical:	10-15 fc
Lighting Control:	Yes
Emergency Power:	Yes
Emergency Lighting:	Yes

Security:

- Duress alarm

Millwork:

- Bookshelves: 3LF x 10" D: 25, per suite

Space Notes:

1. Ballistic-resistant exterior windows per USMS.
2. Location and quantity of bookshelves are at the judge's discretion.

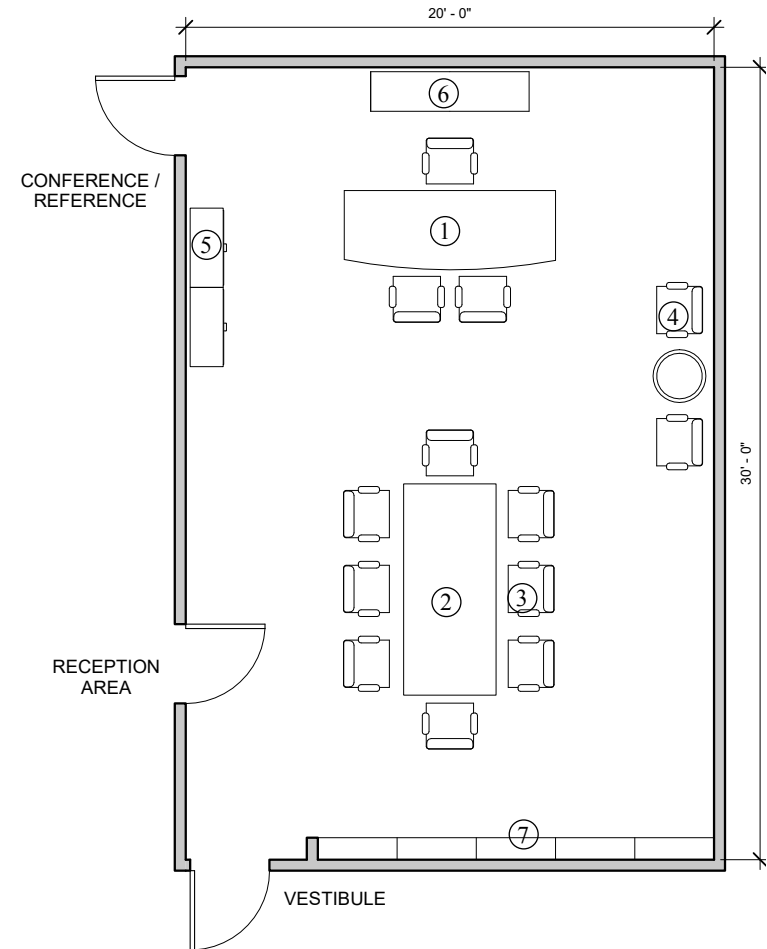

Legend:

- | | | |
|---------|----------------------|---------------|
| ① Desk | ④ Additional Seating | ⑦ Bookshelves |
| ② Table | ⑤ Filing Cabinet | |
| ③ Chair | ⑥ Credenza | |

Judges' Chambers Suites

Space and Ceiling Requirements

CH. 6

District Judge's Chambers Office

500 NSF (46.5 Nm²)

Architectural:

General Requirements:

Security Level:	Restricted 1, 3
Adjacent to:	Conference/Reference Room, Reception Area, Vestibule
Ceiling Height:	10'-0"
Acoustics	NIC 50 - Confidential

Finishes:

Wall:	WD, PNT-1, FWC, WD Wainscot
Floor:	CPT, WD
Base:	V/RB, WD
Ceiling:	ACP, PNT-1

Building Systems:

Illumination:

Horizontal:	30-50 fc
Vertical:	10-15 fc
Lighting Control:	Yes
Emergency Power:	Yes
Emergency Lighting:	Yes

Security:

- Duress alarm

Millwork:

- Bookshelves: 3LF x 10" D: 20, per suite

Space Notes:

1. Ballistic-resistant exterior windows per USMS.
2. Location and quantity of bookshelves are at the judge's discretion.

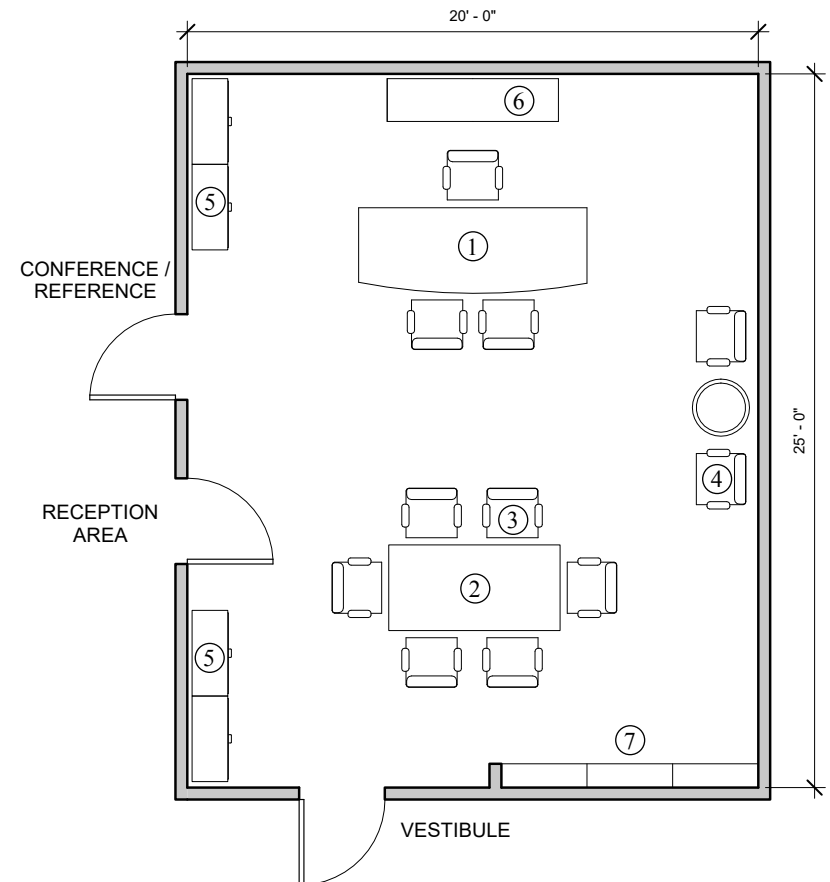

Legend:

- | | | |
|---------|----------------------|---------------|
| ① Desk | ④ Additional Seating | ⑦ Bookshelves |
| ② Table | ⑤ Filing Cabinet | |
| ③ Chair | ⑥ Credenza | |

Judges' Chambers Suites

Space and Ceiling Requirements

CH. 6

Magistrate Judge's Chambers Office 400 NSF (37.2 Nm²)

Architectural:

General Requirements:

Security Level:	Restricted 1, 3
Adjacent to:	Conference/Reference Room, Judicial Assistant, Vestibule
Ceiling Height:	10'-0"
Acoustics	NIC 50 - Confidential

Finishes:

Wall:	WD, PNT-1, FWC, WD Wainscot
Floor:	CPT, WD
Base:	V/RB, WD
Ceiling:	ACP, PNT-1

Building Systems:

Illumination:

Horizontal:	30-50 fc
Vertical:	10-15 fc
Lighting Control:	Yes
Emergency Power:	Yes
Emergency Lighting:	Yes

Security:

- Duress alarm

Millwork:

- Bookshelves: 3LF x 10" D: 10, per suite

Space Notes:

1. Ballistic-resistant exterior windows per USMS.
2. Location and quantity of bookshelves are at the judge's discretion.

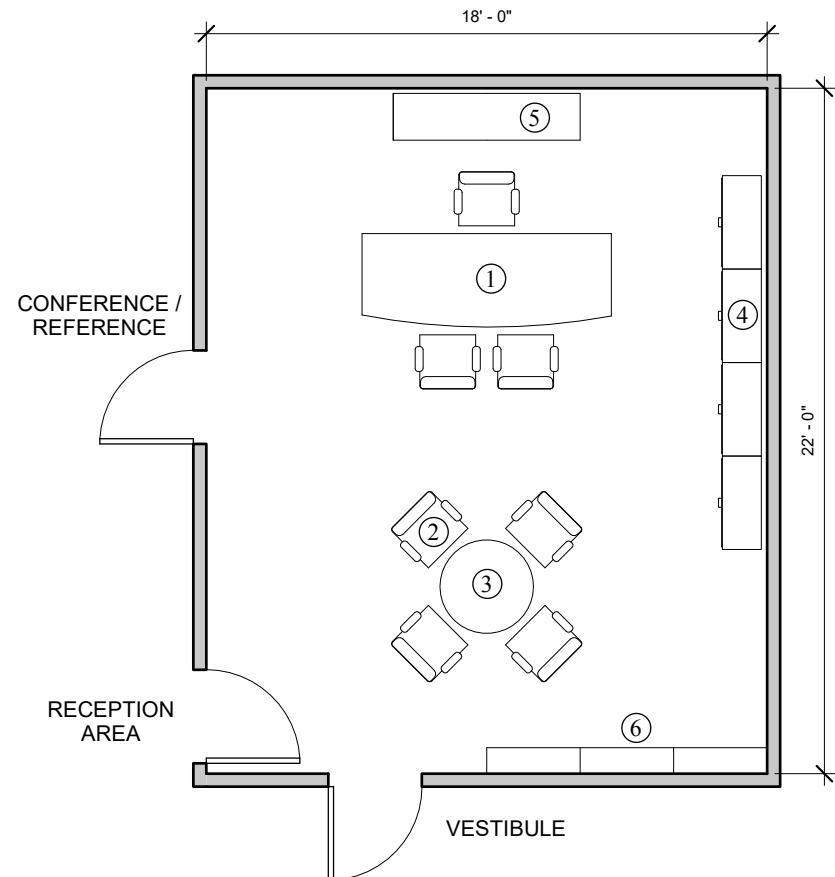

Legend:

- | | |
|---------|------------------|
| ① Desk | ④ Filing Cabinet |
| ② Table | ⑤ Credenza |
| ③ Chair | ⑥ Bookshelves |

Judges' Chambers Suites

Space and Ceiling Requirements

CH. 6

Circuit Judges' Non-Resident Office 240 NSF (22.3 Nm²)

Architectural:

General Requirements:

Security Level:	Restricted 1, 3
Adjacent to:	Reception Area, Vestibule
Ceiling Height:	10'-0"
Acoustics	NIC 50 - Confidential

Finishes:

Wall:	WD, PNT-1, FWC, WD Wainscot
Floor:	CPT, WD
Base:	V/RB, WD
Ceiling:	ACP, PNT-1

Building Systems:

Illumination:

Horizontal:	30-50 fc
Vertical:	10-15 fc
Lighting Control:	Yes
Emergency Power:	Yes
Emergency Lighting:	Yes

Security:

- Duress alarm

Millwork:

- Bookshelves: 3LF x 10" D: 3, per suite

Space Notes:

1. Ballistic-resistant exterior windows per USMS.
2. Location and quantity of bookshelves are at the judge's discretion.

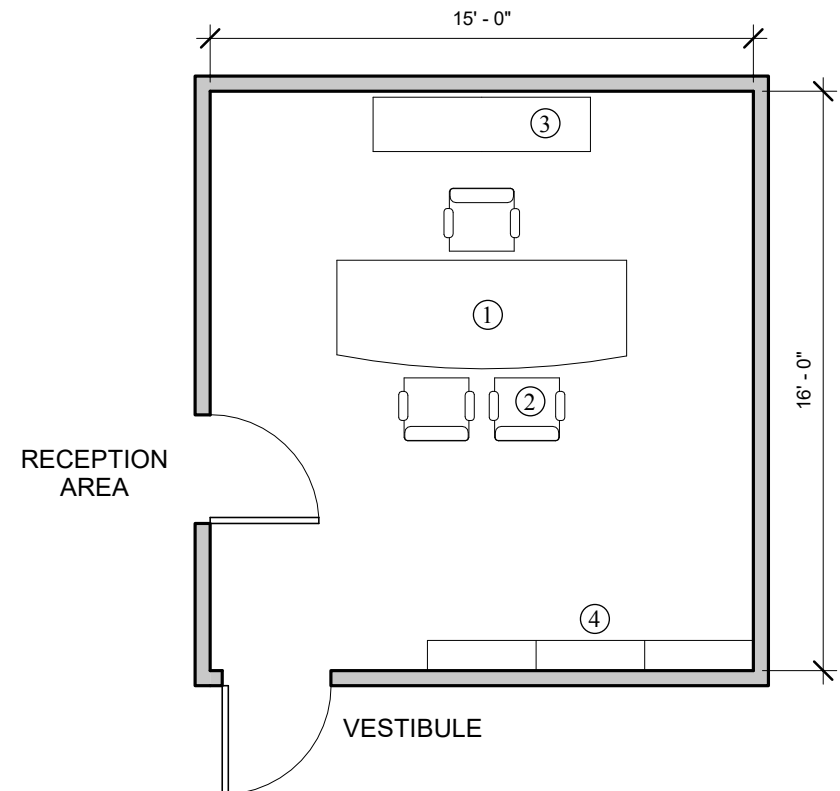

Legend:

- ① Desk
- ② Chair
- ③ Credenza
- ④ Bookshelves

Associated Chamber Space

Space and Ceiling Requirements

CH. 6

Judge's Private Toilet

56 NSF (5.2 Nm²)

Architectural:

General Requirements:

Security Level: Privacy Lock
Adjacent to: Vestibule
Ceiling Height: 10'-0"

Finishes:

Wall: PNT-2, CT Wainscot
Floor: CT
Base: CT
Ceiling: PNT-2

Building Systems:

Illumination:

Horizontal: 20-30 fc
Vertical: 5-10 fc
Lighting Control: Yes

Space Notes:

1. Designed to be adaptable for judges with a disability.
2. A cabinet should accommodate a sink and a drawer with storage below.

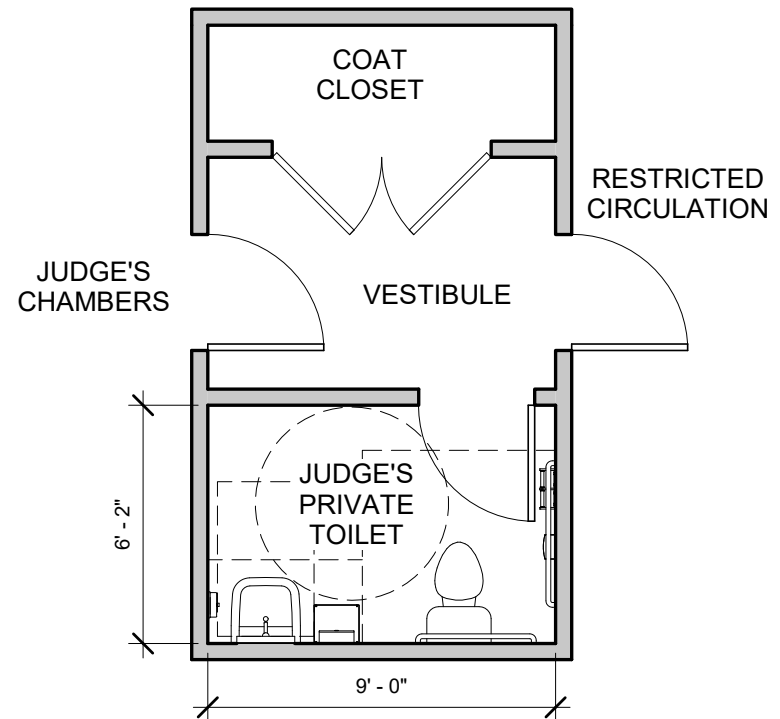

Associated Chamber Space

Space and Ceiling Requirements

Filing Room

140 NSF (13.0 Nm²)

Architectural:

General Requirements:

Security Level: Restricted 3
Adjacent to: Near Judicial Assistant
Ceiling Height: 10'-0"

Finishes:

Wall: PNT-1
Floor: CPT, VCT
Base: V/RB
Ceiling: ACP

Building Systems:

Illumination:

Horizontal: 30-50 fc
Vertical: 10-15 fc
Lighting Control: Yes

Space Notes:

1. Storage, copier, fax, files, and service unit may be combined into a single space.

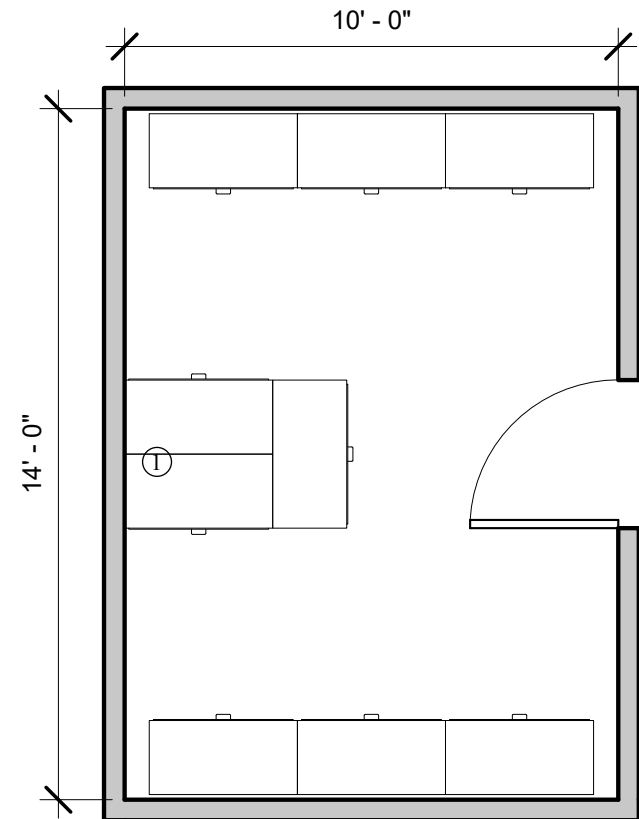

Legend:

① File Cabinets

Associated Chamber Space

Space and Ceiling Requirements

CH. 6

Conference/Reference Room

240 NSF (22.3 Nm²)

Architectural:

General Requirements:

Security Level: Restricted 3
Adjacent to: Judge's Chambers, Staff Circulation
Ceiling Height: 10'-0"
Acoustics: NIC 50 - Confidential

Finishes:

Wall: WD, PNT-1, FWC
Floor: CPT/WD
Base: V/RB, WD
Ceiling: ACP, PNT-1

Building Systems:

Illumination:

Horizontal: 30-50 fc
Vertical: 10-15 fc
Lighting Control: Yes
Emergency Lighting: Yes

Mechanical:

Air Changes: 8/hour

Security:

- Duress alarm
- Door Control

Space Notes:

1. Location and quantity of bookshelves at judge's discretion.

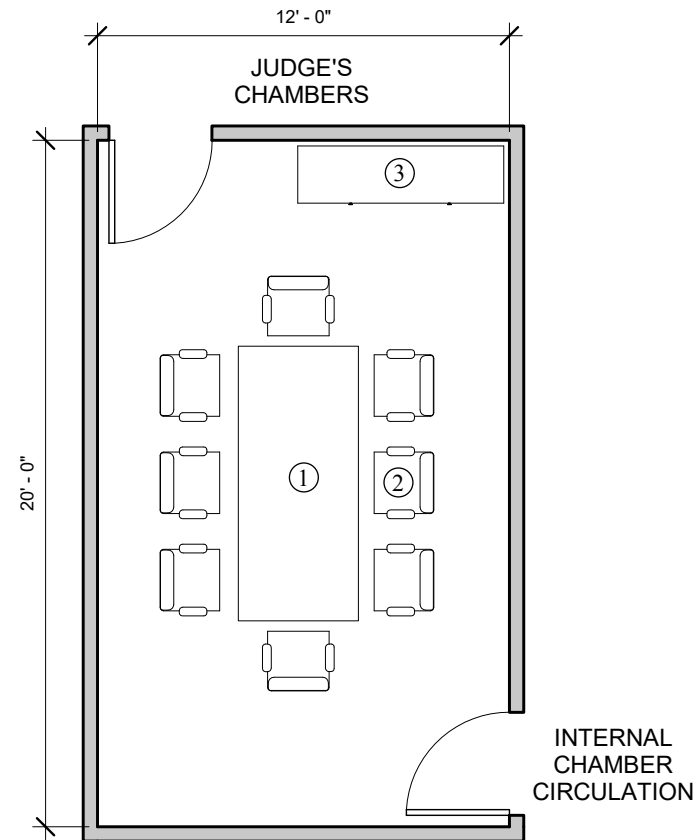

Legend:

- ① Table
- ② Chair
- ③ Credenza

Associated Chamber Space
Space and Ceiling Requirements

Reception Area

100 NSF (9.3 Nm²)

Architectural:

General Requirements:

Security Level: Restricted 1, 2
 Adjacent to: Restricted Circulation
 Ceiling Height: 10'-0"

Finishes:

Wall: WD, PNT-1, FWC
 Floor: CPT, WD
 Base: V/RB, WD
 Ceiling: ACP, PNT-1

Building Systems:

Illumination:

Horizontal: 20-30 fc
 Vertical: 5-10 fc
 Lighting Control: Yes
 Emergency Lighting: Yes

Security:

- CCV camera (outside of entry to reception)
- Security intercom (outside of entry to reception)
- Card reader

Space Notes:

1. Judicial assistant work space shown within reception area.
2. Flooring for light commercial traffic.

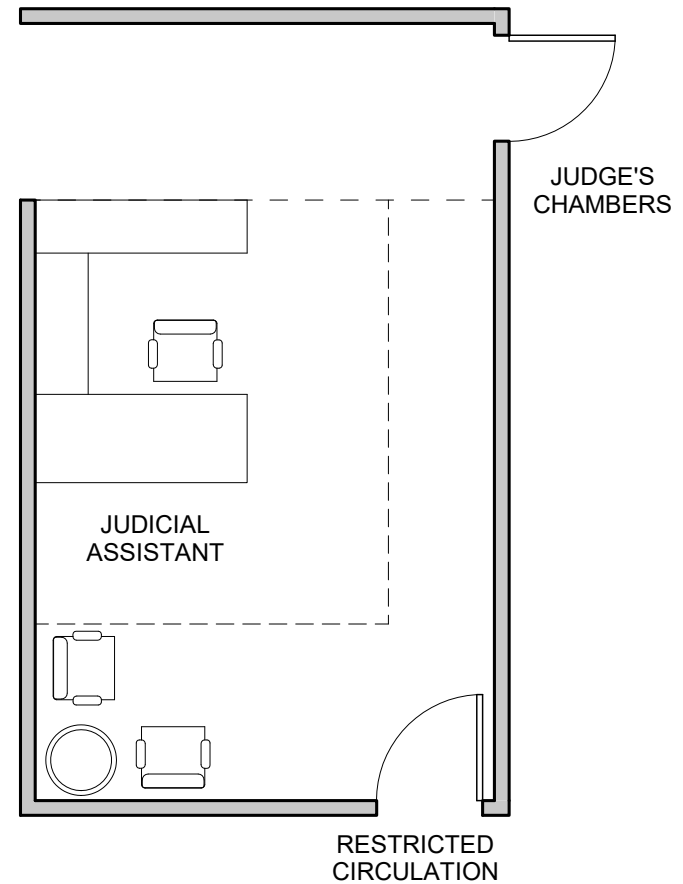

Associated Chamber Space

Space and Ceiling Requirements

CH. 6

Judicial Assistant Work Space

120 NSF (11.2 Nm²)

Architectural:

General Requirements:

Security Level: Restricted 1
Adjacent to: Reception
Ceiling Height: 10'-0"

Finishes:

Wall: PNT-1
Floor: CPT, WD
Base: V/RB, WD
Ceiling: ACP

Building Systems:

Illumination:

Horizontal: 30-50 fc
Vertical: 10-15 fc
Lighting Control: Yes
Emergency Lighting: Yes

Security:

- CCV monitor
- Duress alarm
- Security intercom
- Door Contact
- Remote Door - Release Mechanical

Space Notes:

1. Reception area is included in NSF for non-resident chambers suites.
2. Flooring for light commercial traffic.

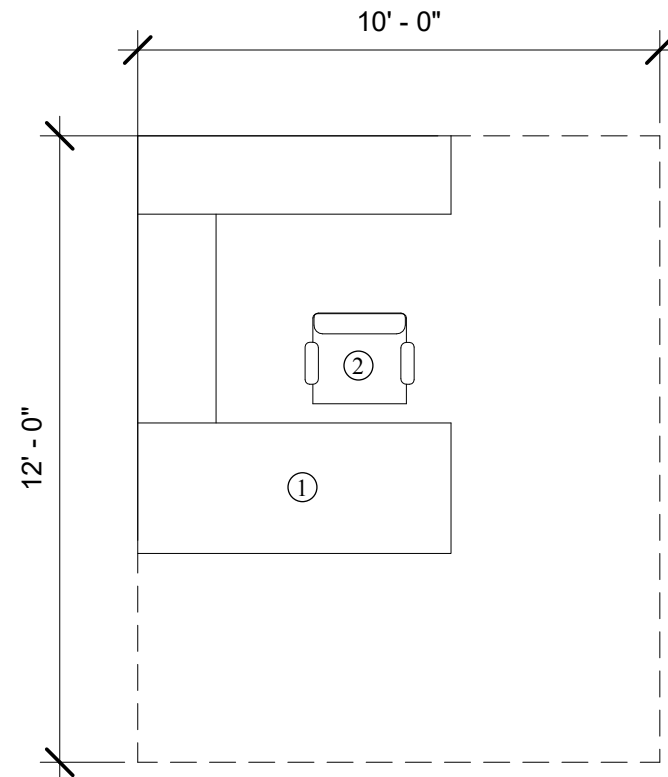

Legend:

- ① Systems Furniture
- ② Chair

Court Library Spaces
Space and Ceiling Requirements

Public Entry/Lobby

Circuit HQ **200 NSF (18.6 Nm²)**

Satellite **100 NSF (9.3 Nm²)**

Architectural:

General Requirements:

Security Level: Circuit HQ - Public 2,3 Restricted 3
Satellite - Public 2,3, Restricted 3

Adjacent to:
Ceiling Height: 10'-0"
Acoustics: NIC 45 - Minimal

Finishes:

Wall: PNT-1
Floor: CPT
Base: V/RB, WD
Ceiling: ACP

Building Systems:

Illumination:

Horizontal: 20-30 fc
Vertical: 5-10 fc
Lighting Control: Yes

Mechanical:

Air Changes: 8/hour

Security:

- Card reader

Furniture and Equipment

- (TBD) Seating: lounge, movable
- (TBD) Library shelves: 36" (925 mm) W x 10" (250 mm) D metal shelving. End panels with wood veneer finish to match wood trim and library (doors). Cantilever-type shelving preferred if seismic anchoring is required. Reference materials.*
- (TBD) Card catalog
- (TBD) Computer workstation: to support computerized catalog, movable
- (TBD) Chair: For use at card catalog workstation, movable
- (TBD) Book carts
- (TBD) Clock: wall-mounted

Court Library Spaces
Space and Ceiling Requirements

Public Entry/Lobby

Circuit HQ

Satellite

200 NSF (18.6 Nm²)

100 NSF (9.3 Nm²)

Legend:

① Additional Seating

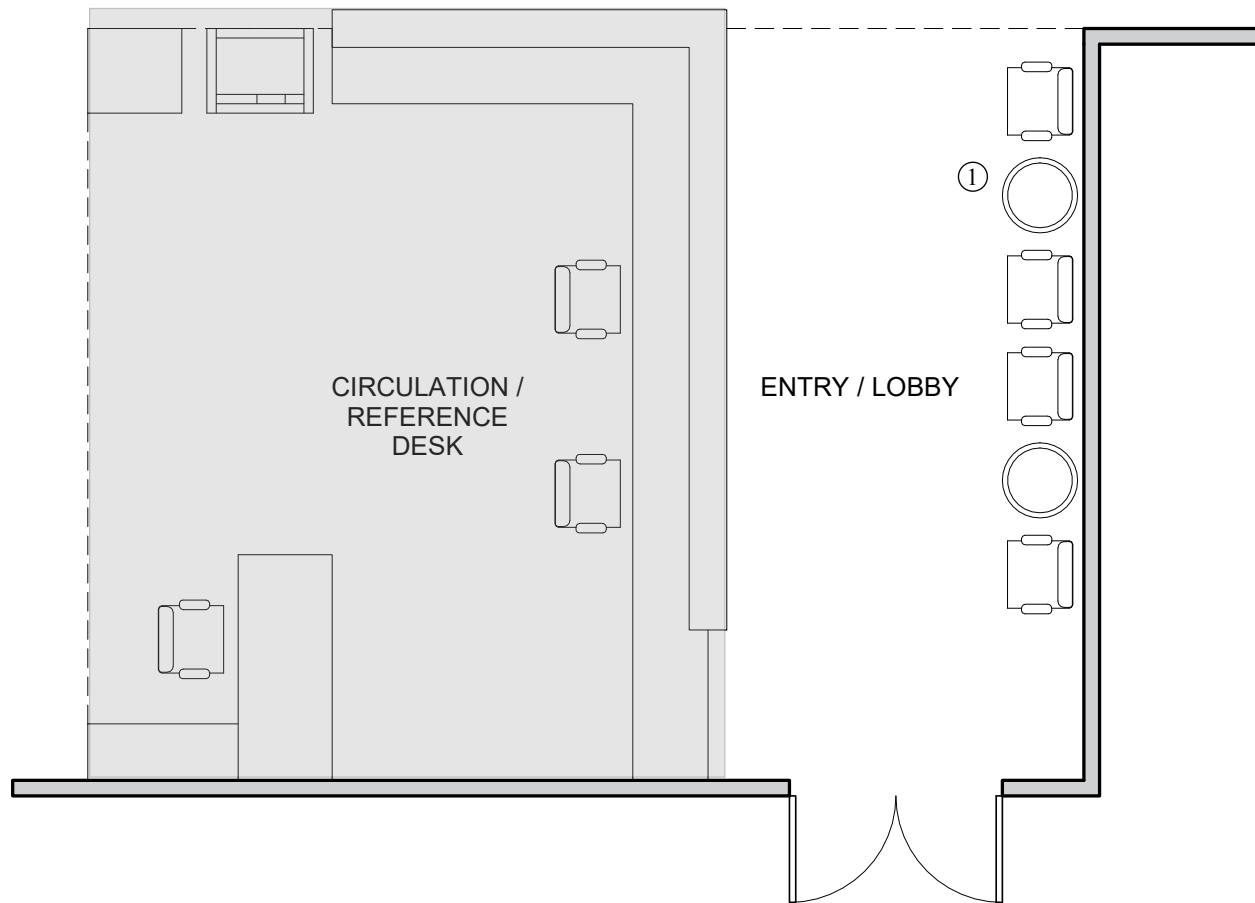

Court Library Spaces
Space and Ceiling Requirements

Circulation/Reference Desk

Circuit HQ	500 NSF (46.5 Nm²)
Satellite	200 NSF (18.6 Nm²)

Architectural:

General Requirements:

Security Level:	Circuit HQ - Public 2, Restricted 1 Satellite - Public 2, Restricted 1
Adjacent to:	Public Entry
Ceiling Height:	10'-0"

Finishes:

Wall:	PNT-1
Floor:	CPT
Base:	V/RB, WD
Ceiling:	ACP

Building Systems:

Illumination:

Horizontal:	40-50 fc
Vertical:	10-15 fc
Lighting Control:	Yes

Mechanical:

Air Changes:	8/hour
--------------	--------

Security:

- Duress alarm

Millwork

- Circulation/Reference Desk:
 - Circuit HQ - 20'-0" (6,100 mm) L maximum
 - Satellite - 12'-0" (3,700 mm) L maximum

Fixtures, Furniture, and Equipment (FFE)

- Book drop space for a book cart and compressible shelf.

Space Notes:

1. Counter to accommodate a computer, printers, on-line computerized library catalog (OCLC) terminals, printer/copier/fax equipment.

Court Library Spaces

Space and Ceiling Requirements

Circulation/Reference Desk

Circuit HQ

Satellite

500 NSF (46.5 Nm²)

200 NSF (18.6 Nm²)

Legend:

- ① Circulation Desk/Counter
- ② Book Drop
- ③ Printer/Copier

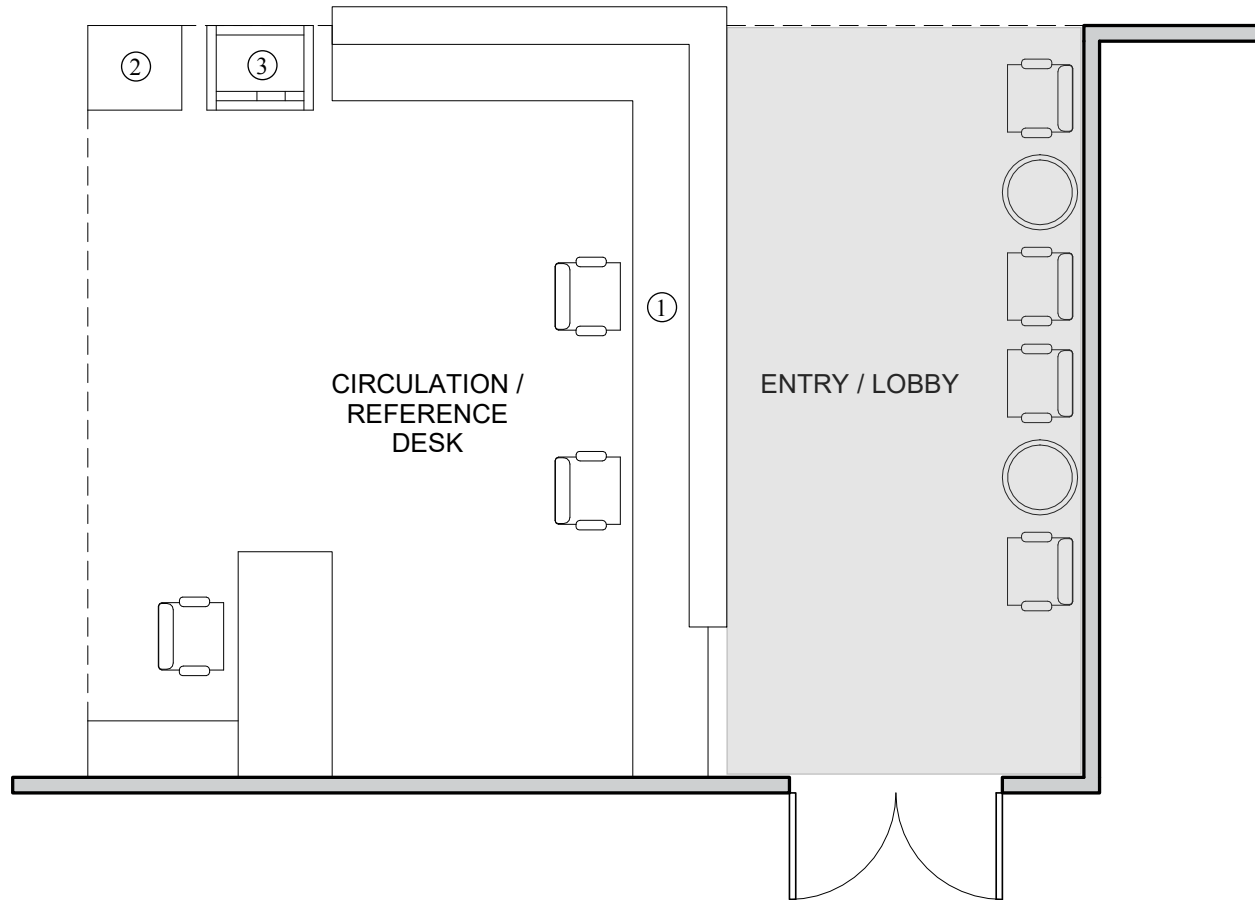

Court Library Spaces
Space and Ceiling Requirements

Periodical Area

Circuit HQ	200 NSF (18.6 Nm²)
Satellite	200 NSF (18.6 Nm²)
Unstaffed	100 NSF (9.3 Nm²)

Architectural:

General Requirements:

Security Level:	Circuit HQ - Public 2 Satellite - Public 2 Unstaffed - Restricted 1
Adjacent to:	Circulation, Reading Area
Ceiling Height:	10'-0"

Finishes:

Wall:	PNT-1
Floor:	CPT
Base:	V/RB, WD
Ceiling:	ACP

Building Systems:

Illumination:

Horizontal:	40-50 fc
Vertical:	10-15 fc
Lighting Control:	Yes

Mechanical:

Air Changes:	8/hour
--------------	--------

Fixtures, Furniture, and Equipment (FFE)

- (TBD) Shelves: periodical shelving, movable
- (TBD) Newspaper racks
- (TBD) Magazine displays
- (TBD) Lounge chairs
- (TBD) Side tables

Court Library Spaces

Space and Ceiling Requirements

CH. 7

Periodical Area

Circuit HQ

200 NSF (18.6 Nm²)

Satellite

200 NSF (18.6 Nm²)

Unstaffed

100 NSF (9.3 Nm²)

Legend:

- ① Shelves
- ② Lounge Chairs
- ③ Side Tables

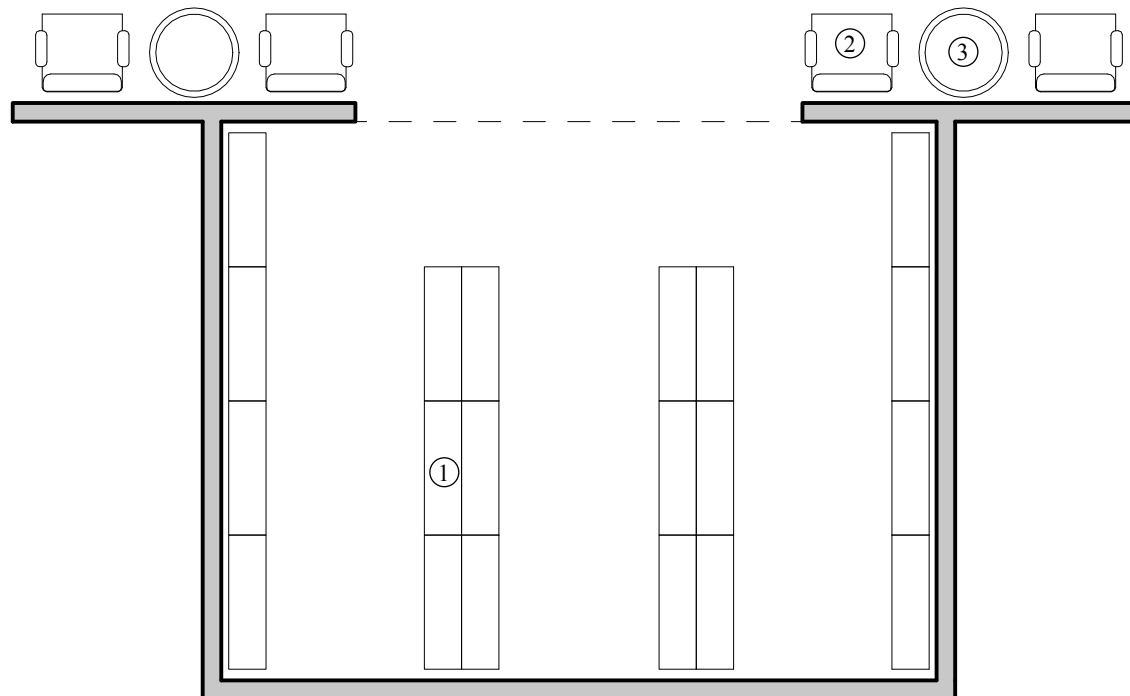

Court Library Spaces

Space and Ceiling Requirements

Computer-Assisted Legal Research (CALR) and Library Catalog: Public

Circuit HQ	292 NSF (27.1 Nm²)
Satellite	96 NSF (8.9 Nm²)

Architectural:

General Requirements:

Security Level:	Circuit HQ - Public 2 Satellite - Public 2
Adjacent to:	
Ceiling Height:	10'-0"

Finishes:

Wall:	PNT-1
Floor:	CPT
Base:	V/RB, WD
Ceiling:	ACP

Building Systems:

Illumination:

Horizontal:	30-40 fc
Vertical:	5-10 fc
Lighting Control:	Yes

Mechanical:

Air Changes:	8/hour
--------------	--------

Fixtures, Furniture, and Equipment (FFE)

- (TBD) Workstation: L- or U-shaped work surface enclosed by acoustic panels with enough space to accommodate shelving
- (TBD) Task chair: swivel base with short arms
- (TBD) Bookshelf: for use in workstation
- (TBD) Bookshelf: for manuals and aids in the CALR area
- (TBD) Clock: wall-mounted

Court Library Spaces
Space and Ceiling Requirements

**Computer-Assisted Legal Research (CALR) and
Library Catalog: Public**

Circuit HQ
Satellite

292 NSF (27.1 Nm²)
96 NSF (8.9 Nm²)

Legend:

- ① Workstation
- ② Task Chair
- ③ Bookshelf

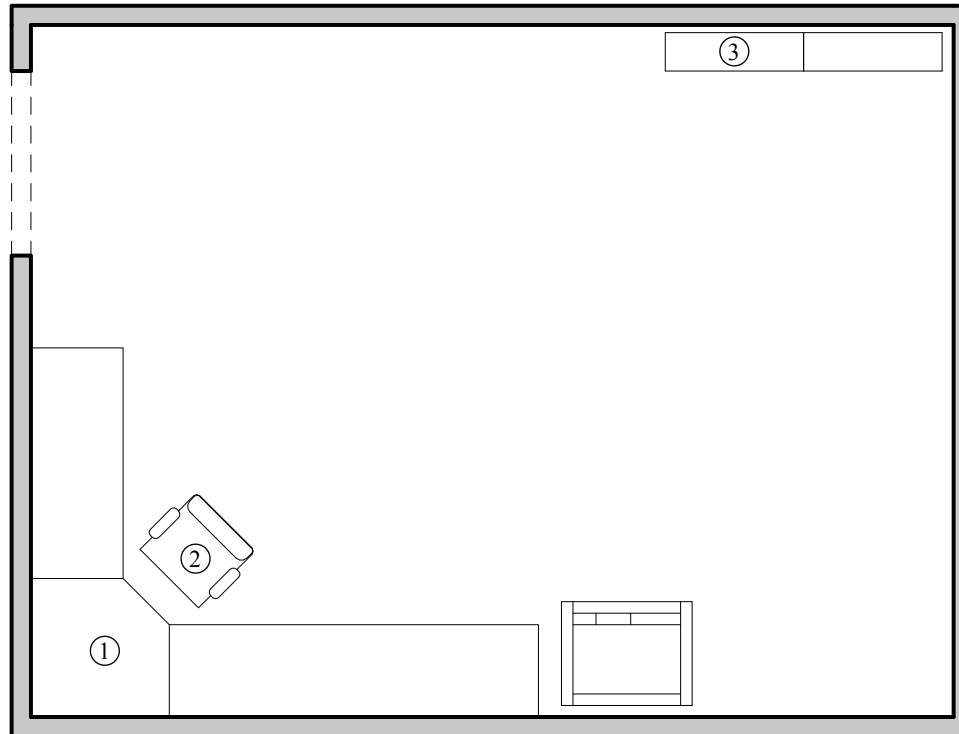

Court Library Spaces

Space and Ceiling Requirements

Stack Area (9 NSF/21 LF Shelves)

Circuit HQ	5,000 NSF (465 Nm²)
Satellite	1,500 NSF (139.5 Nm²)
Unstaffed	500 NSF (46.5 Nm²)

Architectural:

General Requirements:

Security Level:	Circuit HQ - Public 2 Satellite - Public 2 Unstaffed - Restricted 3
-----------------	---

Adjacent to:

Ceiling Height:	10'-0"
Acoustics	NIC 55 - Normal

Finishes:

Wall:	PNT-1
Floor:	CPT
Base:	V/RB
Ceiling:	ACP

Building Systems:

Illumination:

Horizontal:	40-50 fc
Vertical:	10-15 fc
Lighting Control:	Yes

Mechanical:

Air Changes:	8/hour
--------------	--------

Fixtures, Furniture, and Equipment (FFE)

- Bookshelves: 3'-0" (915mm) wide x 7'-0" (2134mm) high. Each row should be no more than (7) or (8) units long.

Court Library Spaces

Space and Ceiling Requirements

Stack Area (9 NSF/21 LF Shelves)

Circuit HQ

5,000 NSF (465 Nm²)

Satellite

1,500 NSF (139.5 Nm²)

Unstaffed

500 NSF (46.5 Nm²)

Legend:

- ① Shelves
- ② Stack Area
- ③ Study Area/Seating Area

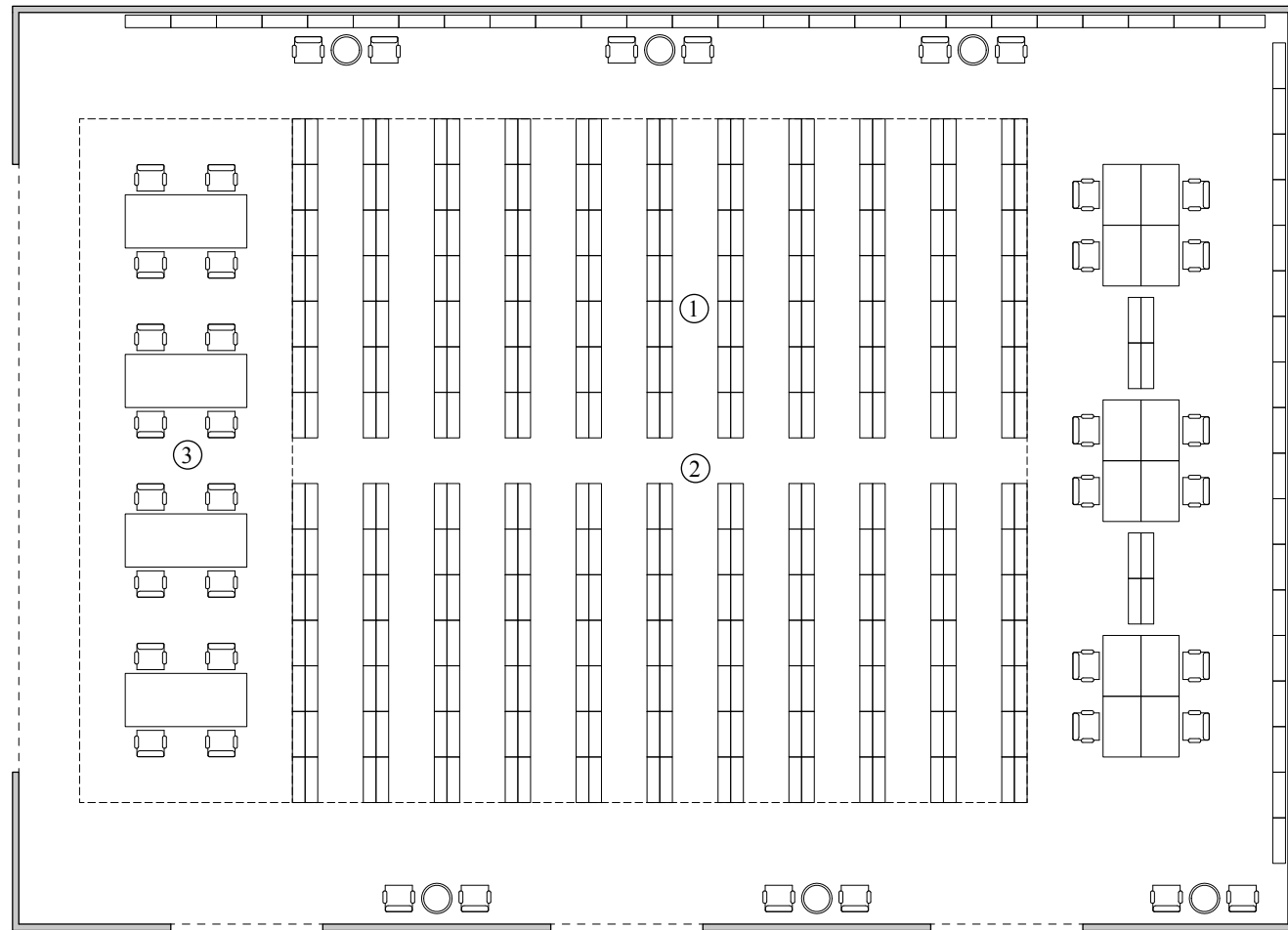

Court Library Spaces
Space and Ceiling Requirements

Study Area/Seating Area

Circuit	700 NSF (65.1 Nm²)
Satellite	408 NSF (37.9 Nm²)
Unstaffed	204 NSF (18.9 Nm²)

Architectural:

General Requirements:

Security Level:	Within Stack Area
Adjacent to:	Reference Area
Ceiling Height:	10'-0"
Acoustics	NIC 55 - Normal

Finishes:

Wall:	PNT-1
Floor:	CPT
Base:	V/RB, WD
Ceiling:	ACP

Building Systems:

Illumination:

Horizontal:	40-50 fc
Vertical:	10-15 fc
Lighting Control:	Yes

Mechanical:

Air Changes:	8/hour
--------------	--------

Security:

- Duress alarm (unstaffed only)

Fixtures, Furniture, and Equipment (FFE)

- (TBD) Table: 4'-0" x 8'-0" (1,225 mm x 2,425 mm)
- (4) Chairs
- (TBD) Clock: wall-mounted

Space Notes:

1. Courts have the flexibility to determine the appropriate amount of study and seating areas to meet their local need. However courts should not exceed the square footage listed.
2. Allocate 35 NSF (3.3 Nm²) per seat for Seating Areas. The maximum number of seats in a seating area is 20.

Court Library Spaces

Space and Ceiling Requirements

Study Area/Seating Area

Circuit	700 NSF (65.1 Nm²)
Satellite	408 NSF (37.9 Nm²)
Unstaffed	204 NSF (18.9 Nm²)

Legend:

- ① Table
- ② Chair

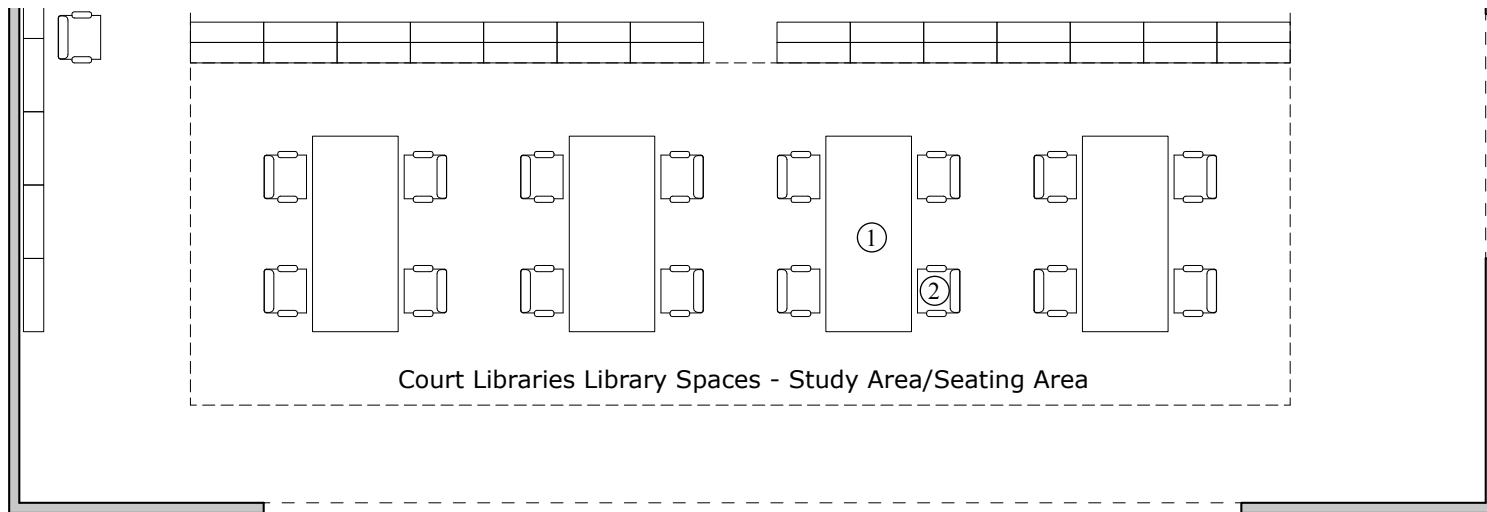

Court Libraries Spaces

Space and Ceiling Requirements

**Microform Area: Public & Staff 35 NSF (3.3 Nm²)/
Machine 15 NSF, (1.4 Nm²)/Cabinet)**

Circuit HQ 200 NSF (18.6 Nm²)

Satellite 100 NSF (9.3 Nm²)

Architectural:

General Requirements:

Security Level: Circuit HQ - Public 2
Satellite - Public 2
Adjacent to: Reference Area
Ceiling Height: 10'-0"

Finishes:

Wall: PNT-1
Floor: VCT
Base: V/RB
Ceiling: ACP

Building Systems:

Illumination:

Horizontal: 30-40 fc
Vertical: 5-10 fc
Lighting Control: Yes

Mechanical:

Air Changes: 8/hour

Fixtures, Furniture, and Equipment (FFE):

- (TBD) Carrel: to support microform reader/printer, chair microform storage cabinets
- (TBD) Chair
- (1) Storage cabinet: to store microforms

Space Notes:

1. Coordinate equipment selection and location early in planning process to account for structural implications.

Court Libraries Spaces

Space and Ceiling Requirements

CH. 7

**Microform Area: Public & Staff 35 NSF (3.3 Nm²)/
Machine 15 NSF, (1.4 Nm²)/Cabinet)**

Circuit HQ 200 NSF (18.6 Nm²)

Satellite 100 NSF (9.3 Nm²)

Legend:

- ① Carrel
- ② Chair
- ③ Microform Storage Cabinet
- ④ Copier

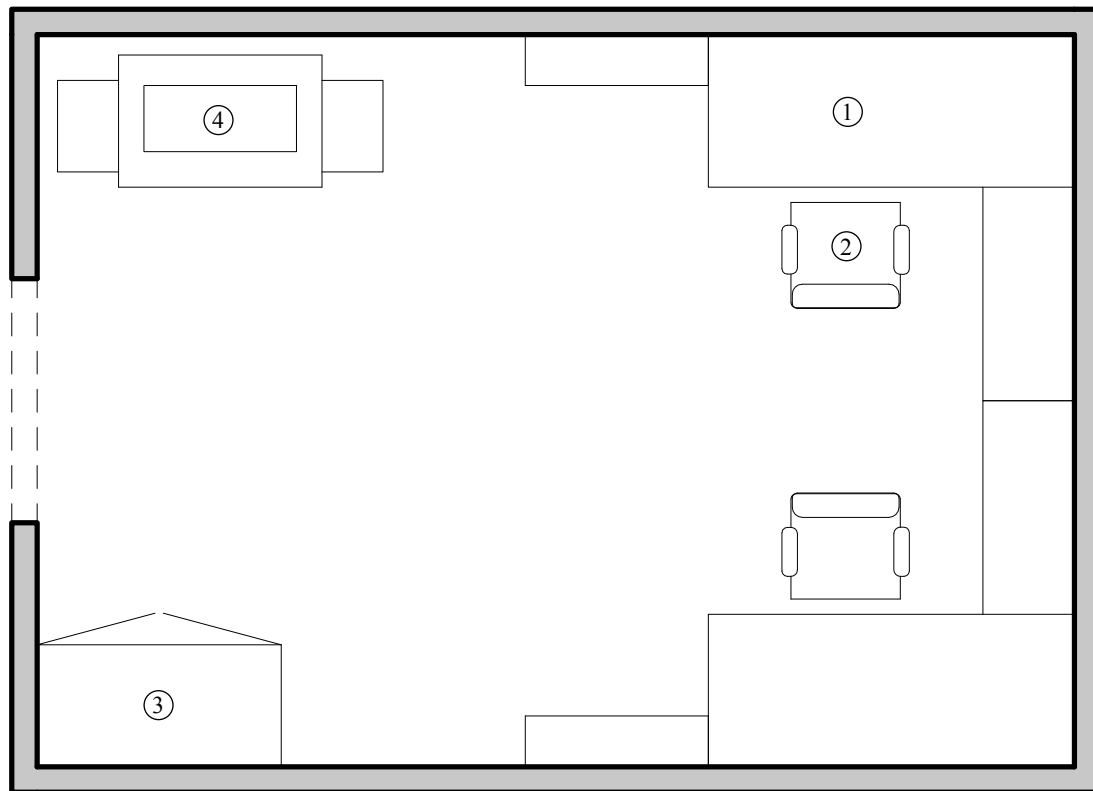

Court Library Spaces
 Space and Ceiling Requirements

Archival Storage

Architectural:

General Requirements:

Security Level: Restricted 3
 Ceiling Height: 10'-0"

Finishes:

Wall: PNT-1
 Floor: VCT
 Base: VRB
 Ceiling: ACP

Building Systems:

Illumination:

Horizontal: 20-30 fc
 Vertical: 5-10 fc
 Lighting Control: Yes

Mechanical:

Air Changes: 8/hour

Space Notes:

1. Natural light is not desirable in the archival storage area. Interior windows with a view of library areas should be provided if the area is enclosed.
2. In extreme climates library archival storage space requires 24-hour climate control with an individual thermostatic control for the space. Technical specifications may be found in the *National Archives' NARA Information Paper Number 13* (1997).
3. Provide humidity sensors.

This page intentionally left blank.

Court Libraries Spaces
Space and Ceiling Requirements

Technical Services Area

Circuit HQ	400 NSF (37.2 Nm²)
Satellite	200 NSF (18.6 Nm²)

Architectural:

General Requirements:

Security Level:	Circuit HQ - Restricted 3 Satellite - Restricted 3
Ceiling Height:	10'-0"

Finishes:

Wall:	PNT-1
Floor:	VCT
Base:	V/RB
Ceiling:	ACP

Building Systems:

Illumination:

Horizontal:	30-40 fc
Vertical:	5-10 fc
Lighting Control:	Yes

Mechanical:

Air Changes:	8/hour
--------------	--------

Security:

- Duress alarm

Millwork

- Technical services area counter: accommodate a sink

Furniture and Equipment

- (1) Book cart
- (1) Storage cabinet: to accommodate supplies, 12" (300-mm) D shelves
- (TBD) File cabinet
- (TBD) 18" (450-mm) depth shelves

Court Libraries Spaces
Space and Ceiling Requirements

Technical Services Area

Circuit HQ

400 NSF (37.2 Nm²)

Satellite

200 NSF (18.6 Nm²)

Legend:

- ① Counter with Sink
- ② Storage Cabinets
- ③ Shelving
- ④ Workstations

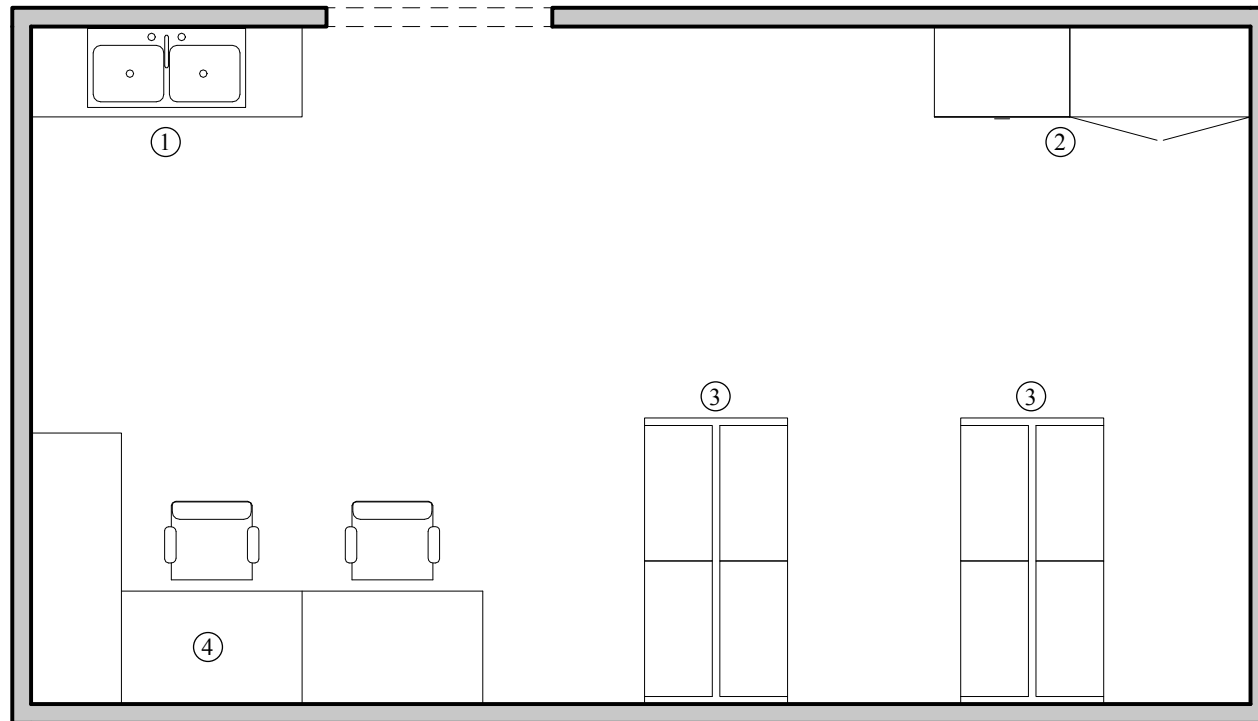

Court Libraries Other Spaces
 Space and Ceiling Requirements

Freight Mail Receiving (9 NSF/Shelf)

Circuit HQ	200 NSF (18.6 Nm²)
Satellite	100 NSF (9.3 Nm²)

Architectural:

General Requirements:

Security Level:	Circuit HQ - Restricted 1 Satellite - Restricted 1
Adjacent to:	Technical Services Area, Mail Room
Ceiling Height:	10'-0"

Finishes:

Wall:	PNT-1
Floor:	VCT
Base:	V/RB
Ceiling:	ACP

Building Systems:

Mechanical:

Air Changes:	8/hour
--------------	--------

Fixtures, Furniture, and Equipment (FFE)

- (TBD) Sorting tables, mail slots

Court Libraries Spaces

Space and Ceiling Requirements

CH. 7

Shelving Area

Circuit HQ

500 NSF (46.5 Nm²)

Satellite

250 NSF (23.2 Nm²)

Architectural:

General Requirements:

Security Level: Circuit HQ - Restricted 3
Satellite - Restricted 3
Adjacent to: Technical Services Area
Ceiling Height: 10'-0"

Finishes:

Wall: PNT-1
Floor: VCT
Base: V/RB
Ceiling: ACP

Building Systems:

Mechanical:

Air Changes: 8/hour

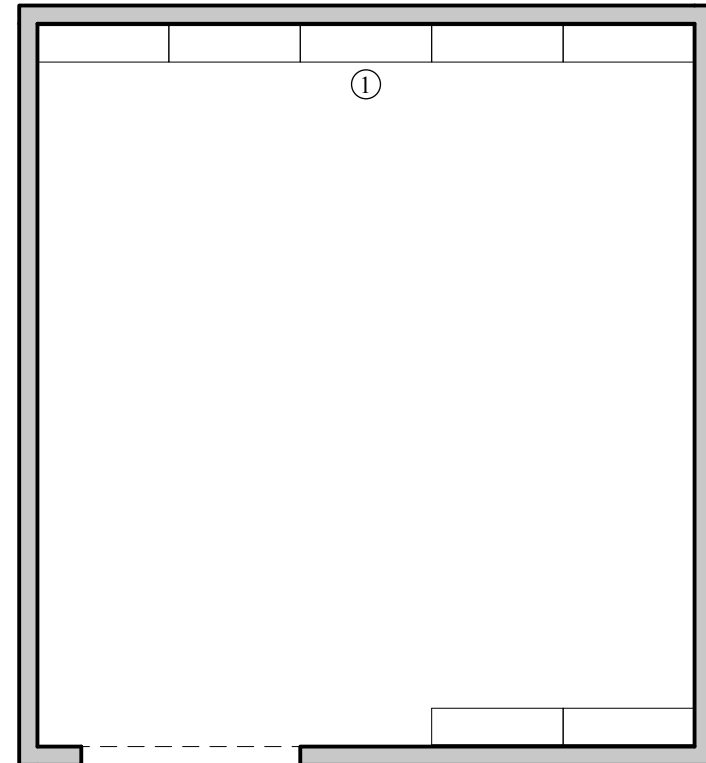

Legend:

① Shelves

Associated Appeals Clerks' Office Spaces

Space and Ceiling Requirements

Queuing/Work Area

105 NSF (9.8 Nm²)

Architectural:

General Requirements:

Security Level: Public 3
Adjacent to: Public Corridor
Ceiling Height: 12'-0"

Finishes:

Wall: PNT-1
Floor: VCT, CT
Base: V/RB, WD
Ceiling: ACP

Space Notes:

1. Assign 15 NSF (1.4 Nm²) per staff member. Minimum area is 105 NSF (9.8 Nm²)
2. In some courthouses ballistic-resistant transaction windows may be required to separate public and staff areas.

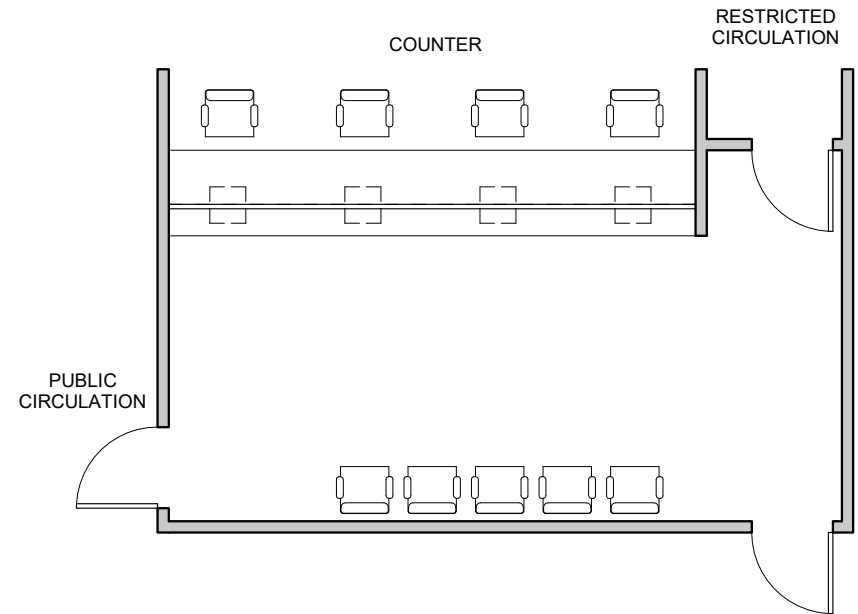

Associated Appeals Clerks' Office Spaces

Space and Ceiling Requirements

CH. 8

Public Counter (including Cashier Station), per person 5 LF (1,525 mm)

Architectural:

General Requirements:

Security Level: Restricted 1
Adjacent to: Reception/Waiting
Ceiling Height: 12'-0"

Finishes:

Wall: PNT-1
Floor: CPT, TZ, ST
Base: V/RB, TZ, ST
Ceiling: ACP

Building Systems:

Security:

- Key Locks
- Duress alarm

Millwork:

- Durable work surface with a divider to the floor below. Accommodate computer monitor, keyboard, and mouse at staff side of counter.
- Where ballistic and break-resistant glass is provided counter should accommodate document-size deal tray transaction opening for each station.

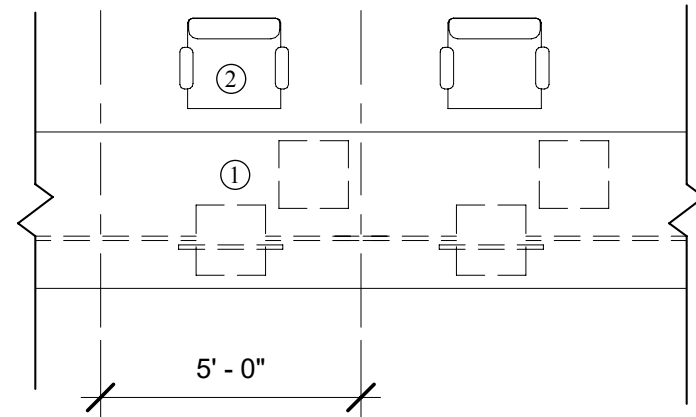

Legend:

- ① Counter
- ② Chair

Associated Appeals Clerks' Office Spaces

Space and Ceiling Requirements

CH. 8

Accessory Stand-up Work Counter **25 NSF (2.3 Nm²)**
per person

Accessory Stand-up Work Counter **100 NSF (9.3 Nm²)**
Open Area

Architectural:

General Requirements:

Security Level: Public 2
Adjacent to: Public Queuing
Ceiling Height: 12'-0"

Finishes:

Wall: PNT-1
Floor: CPT, TZ, ST
Base: V/RB, TZ, ST
Ceiling: ACP

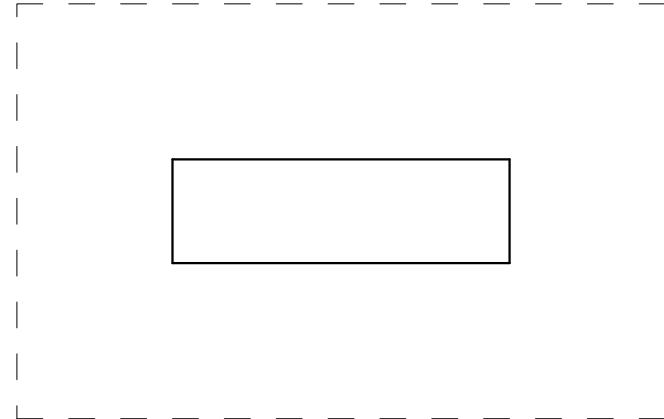

Associated Appeals Clerks' Office Spaces

Space and Ceiling Requirements

CH. 8

Records Exam Area **25 NSF (2.3 Nm²) plus open area per person**

Records Exam Open Area **125 NSF (11.6 Nm²)**

Architectural:

General Requirements:

Security Level: Public 2, Restricted 4
Adjacent to: Public Queuing
Ceiling Height: 12'-0"

Finishes:

Wall: PNT-1
Floor: CPT
Base: V/RB, WD
Ceiling: ACP

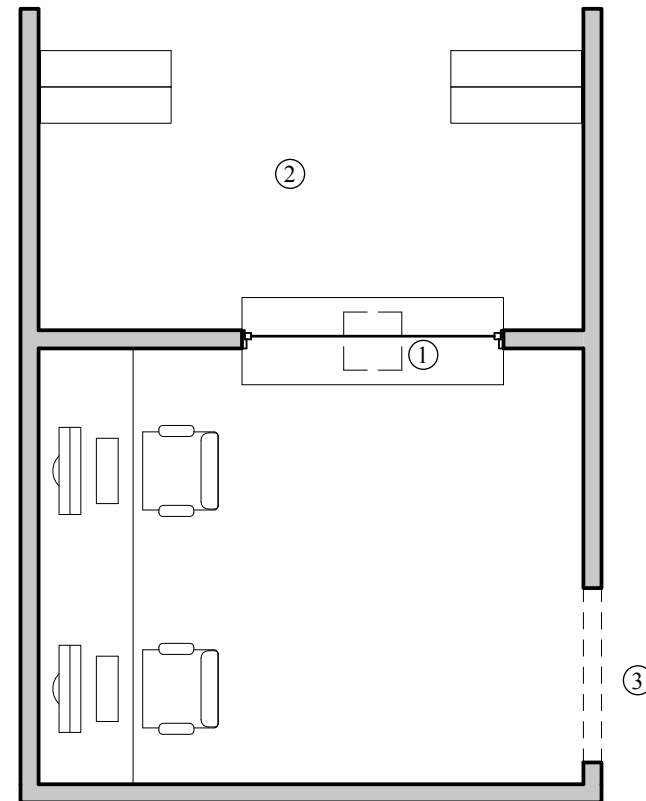

Legend:

- ① Public Transaction Counter
- ② Active Records Area
(number varies per Jurisdiction)
- ③ Public Queuing

Associated Appeals Clerks' Office Spaces

Space and Ceiling Requirements

CH. 8

Public Access Computer Station

35 NSF (3.3 Nm²)

Architectural:

General Requirements:

Security Level: Public 2
Adjacent to: Public Queuing
Ceiling Height: 12'-0"

Finishes:

Wall: PNT-1
Floor: CPT, TZ, ST
Base: V/RB, TZ, ST
Ceiling: ACP

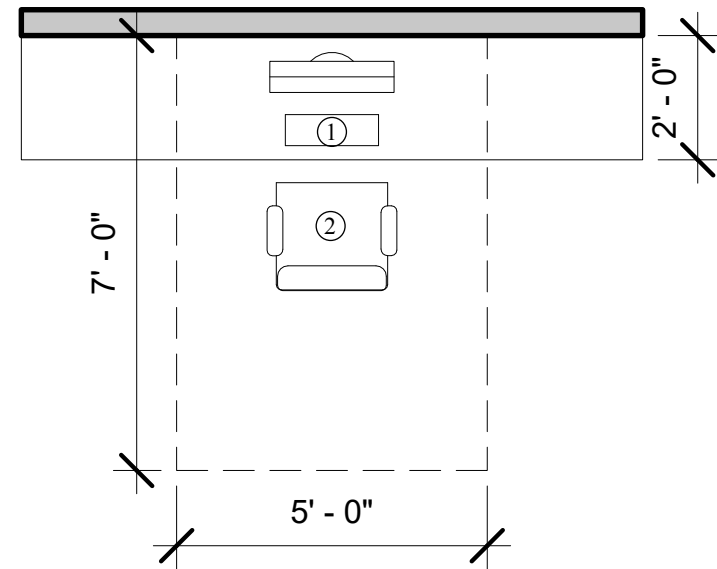

Legend:

- ① Computer
- ② Chair

Associated District & Bankruptcy Clerks' Office Spaces

Space and Ceiling Requirements

CH. 8

Public Counter & Clerk Workstation,

Small Courthouse 100 NSF (9.3 Nm²)

Medium Courthouse 150 NSF (14 Nm²)

Large Courthouse 250 NSF (18.6 Nm²)

Architectural:

General Requirements:

Security Level: Public 3, Restricted 4
Adjacent to: Public Queuing & Clerks Offices
Ceiling Height: 12'-0"

Finishes:

Wall: PNT-1
Floor: CPT, TZ, ST
Base: V/RB, TZ, ST
Ceiling: ACP, GWB

Building Systems:

Security:

- Key Locks
- Duress alarm

Space Notes:

1. Small courthouse = five courtrooms or fewer. Provide 10 LF of counter space.
Medium courthouse = 6-12 courtrooms. Provide 15 LF of counter space.
Large courthouse = 13 or more courtrooms. Requires 25 LF of counter space.
2. Counter space @ 10'-0" depth.
3. Area includes cashier station

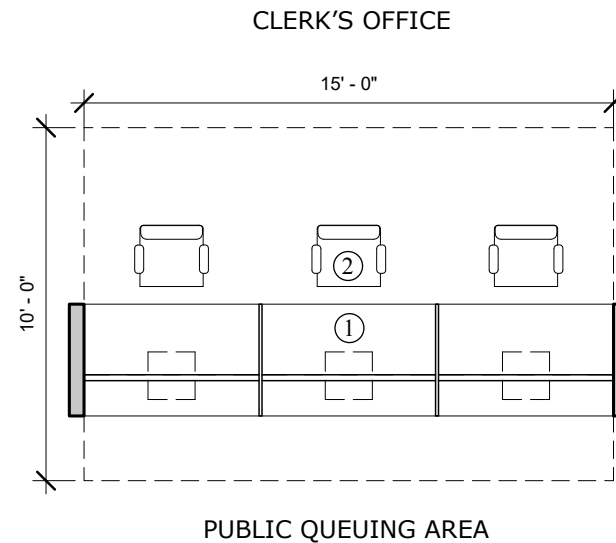

Legend:

- ① Workstation Countertop
- ② Chair

Associated District & Bankruptcy Clerks' Office Spaces

Space and Ceiling Requirements

Public Pay Copier & Scanning Workstation

Small Courthouse **128 NSF (11.8 Nm²) + Open Area**

Medium Courthouse **192 NSF (17.7 Nm²) + Open Area**

Large/Extra-Large Courthouse **320 NSF (29.5 Nm²) + Open Area**

Open Area **110 NSF (10.3 Nm²)**

Architectural:

General Requirements:

Security Level: Public 2
Adjacent to: Public Queuing
Ceiling Height: 10'-0"

Finishes:

Wall: PNT-1
Floor: VCT
Base: V/RB
Ceiling: ACP

Space Notes:

1. Small courthouse = five courtrooms or fewer. Provide two open workstations
Medium courthouse = 6-12 courtrooms. Provide three open workstations
Large/extra-large courthouse = 13 or more courtrooms. Provide five open workstations
Each workstation = 64 NSF (51.1Nm²)

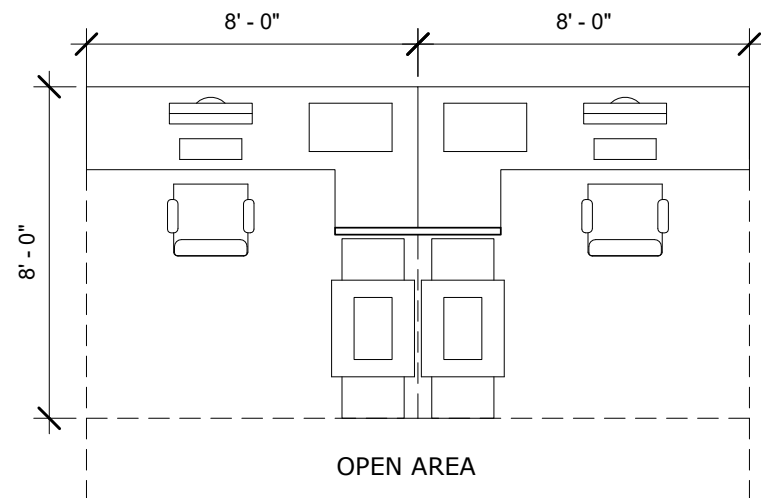

Associated District & Bankruptcy Clerks' Office Spaces

Space and Ceiling Requirements

CH. 8

Records Exam Area

Small Courthouse 100 NSF (9.3 Nm²)

Medium Courthouse 150 NSF (14 Nm²)

Large/Extra-Large Courthouse 180 NSF (16.7 Nm²)

Architectural:

General Requirements:

Security Level: Public 2, Restricted 4
Adjacent to: Public Queuing
Ceiling Height: 10'-0"

Finishes:

Wall: PNT-1
Floor: CPT
Base: V/RB
Ceiling: ACP

Space Notes:

1. Area includes computer access station.
2. In some courthouses ballistic-resistant transaction windows may be required to separate public and staff areas.

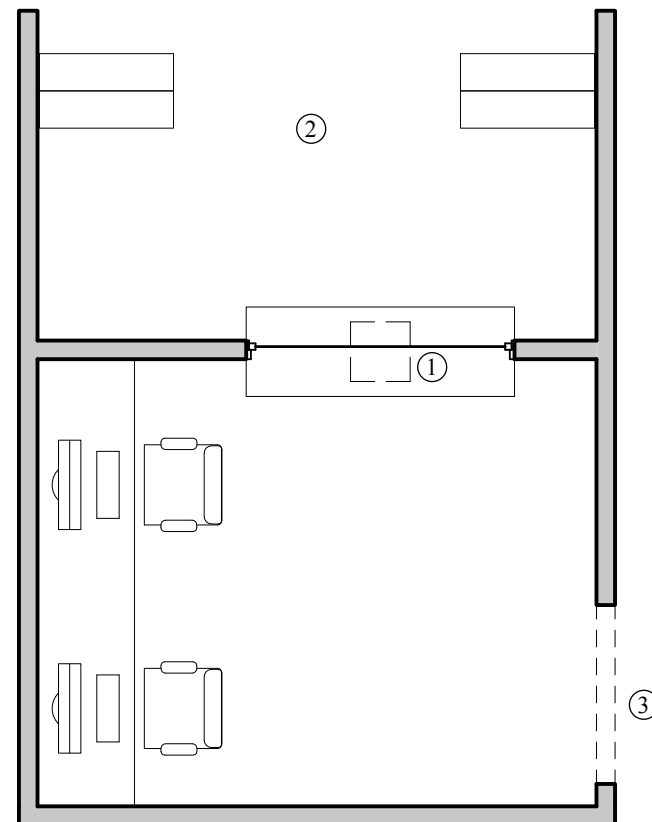

Legend:

- ① Public Transaction Counter
- ② Active Records Area (number varies per Jurisdiction)
- ③ Public Queuing

Associated District & Bankruptcy Clerks' Office Spaces

Space and Ceiling Requirements

Access Station

35 NSF (3.3 Nm²)

Architectural:

General Requirements:

Security Level: Public 2
Adjacent to: Queuing Area
Ceiling Height: 10'-0"

Finishes:

Wall: PNT-1
Floor: CPT
Base: V/RB
Ceiling: ACP

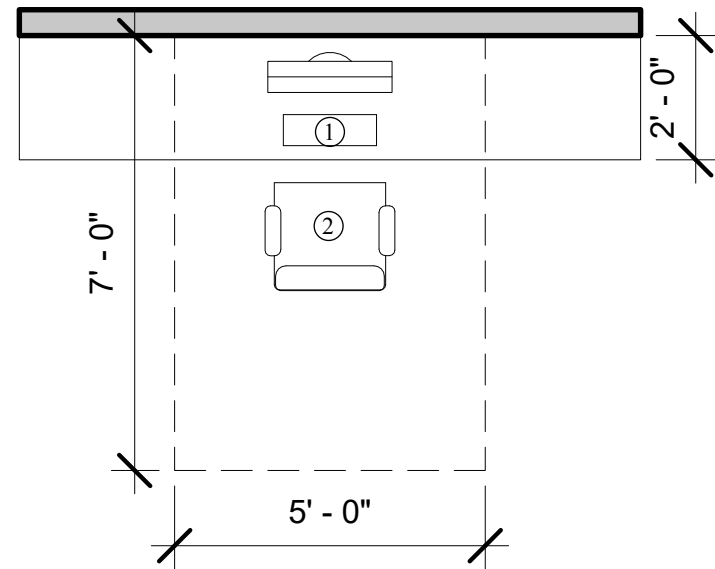

Legend:

- ① Computer
- ② Chair

Associated District & Bankruptcy Clerks' Office Spaces

Space and Ceiling Requirements

CH. 8

Queuing Area

Small Courthouse 100 NSF (9.3 Nm²)

Medium Courthouse 150 NSF (14 Nm²)

Large/Extra-Large Courthouse 180 NSF (16.7 Nm²)

Architectural:

General Requirements:

Security Level: Public 3, Restricted 4
Adjacent to: Counters, Record Exam
Ceiling Height: 10'-0"

Finishes:

Wall: PNT-1
Floor: CPT, TZ, ST
Base: V/RB, TZ, ST
Ceiling: ACP, GWB

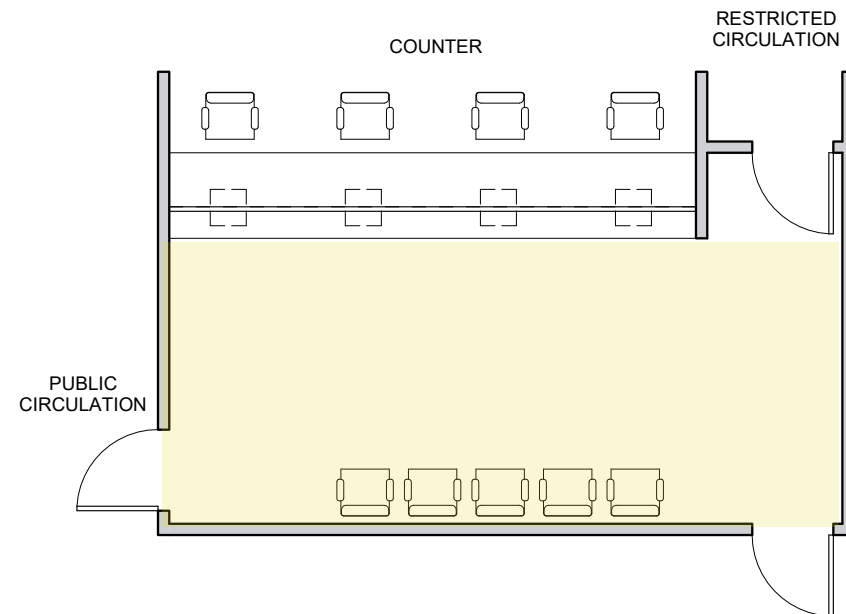

Associated Clerks' Office Spaces

Space and Ceiling Requirements

CH. 8

FAC ID Room

120 NSF (11.2 Nm²)

Architectural:

General Requirements:

Security Level: Restricted 3
Adjacent to: Restricted Circulation
Ceiling Height: 10'-0"

Finishes:

Wall: PNT-1
Floor: CPT
Base: V/RB
Ceiling: ACP

Building Systems:

Security:

- Duress alarm

Fixtures, Furniture, and Equipment (FFE)

- (1) Secure storage for ID media.
- (TBD) Badging station.

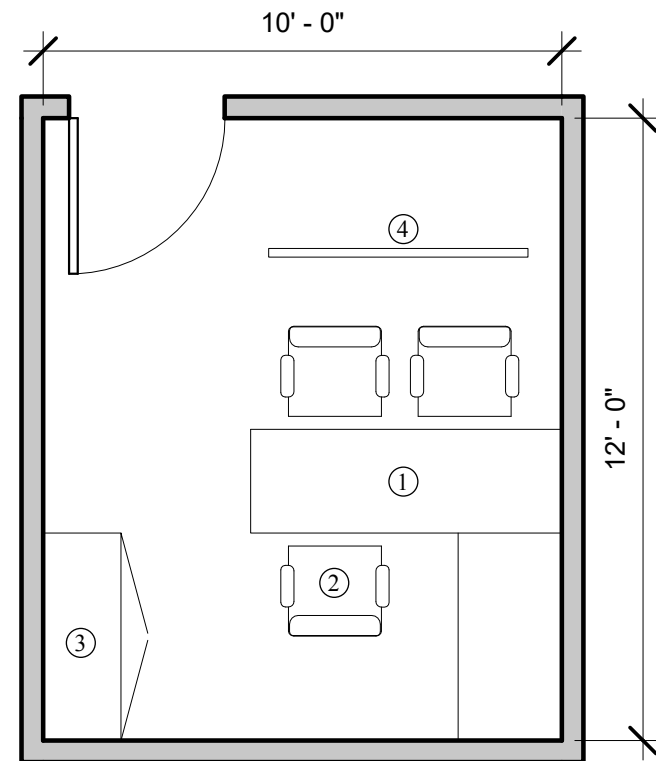

Legend:

- | | |
|---------------|----------------------|
| ① Workstation | ③ Secure Storage |
| ② Chair | ④ Retractable Screen |

This page intentionally left blank.

Associated Clerks' Office Spaces
Space and Ceiling Requirements

Computer Training Room	
Small/Medium Courthouse	200 NSF (18.6 Nm²)
Large Courthouse	300 NSF (27 Nm²)

Architectural:

General Requirements:

Security Level:	Restricted 3
Adjacent to:	Restricted Corridor
Ceiling Height:	12'-0"

Finishes:

Wall:	PNT-1
Floor:	VCT
Base:	V/RB, WD
Ceiling:	ACP

Space Notes:

1. FFE requirements should be determined on a project-to-project basis to satisfy the local needs. FFE shown on the graphic is notional.

Associated Clerks' Office Spaces
Space and Ceiling Requirements

Computer Training Room
Small/Medium Courthouse
Large Courthouse

200 NSF (18.6 Nm²)

300 NSF (27 Nm²)

Legend:

- ① Visual Display Board
- ② Shared Printers
- ③ Projection Screen
- ④ Instructor Workstation
- ⑤ Secure Storage
- ⑥ Ceiling Mounted Projector

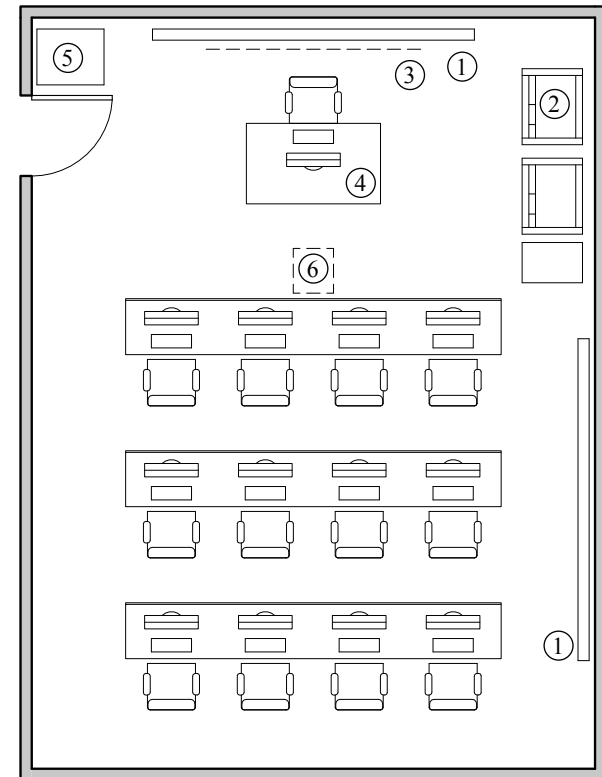
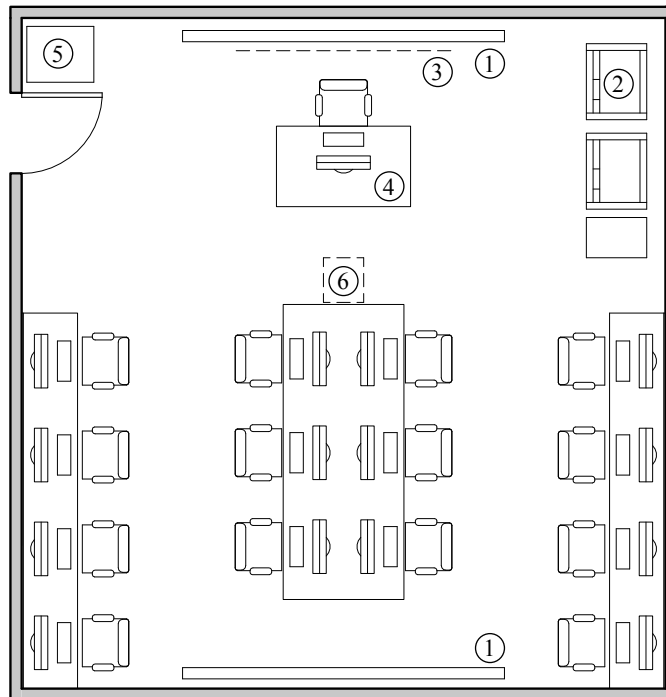

Associated Clerks' Office Spaces

Space and Ceiling Requirements

Mail Work Area

100 NSF (9.3 Nm²)

Architectural:

General Requirements:

Security Level: Restricted 1
Adjacent to: Restricted Corridor
Ceiling Height: 12'-0"

Finishes:

Wall: PNT-1
Floor: VCT
Base: V/RB
Ceiling: ACP

Building Systems:

Security:

- Duress alarm

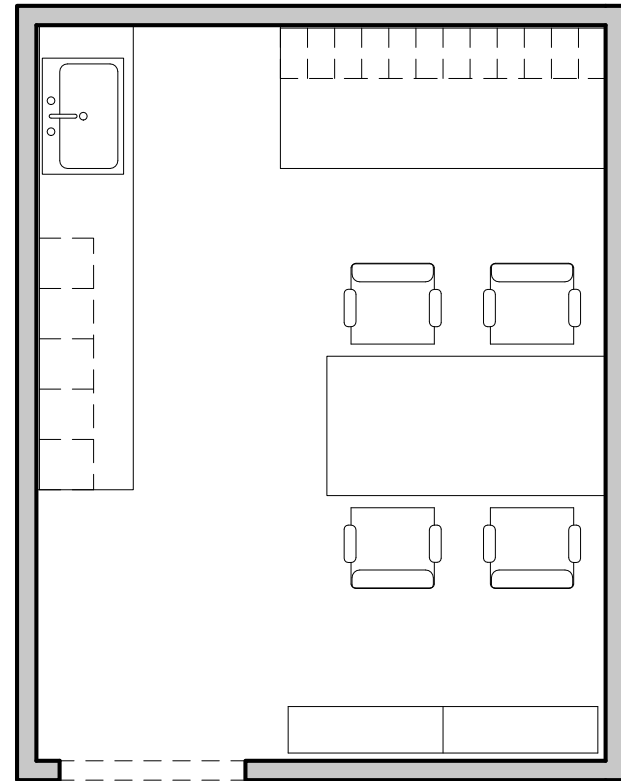

Associated Probation and Pretrial Services Office Spaces

Space and Ceiling Requirements

CH. 9

Shared Interview Room

120 NSF (11.1 Nm²)

Architectural:

General Requirements:

Security Level: Restricted 1, 3
Adjacent to: Reception/Waiting
Ceiling Height: 10'-0"
Acoustics: NIC 55 - Confidential

Finishes:

Wall: PNT-1
Floor: CPT
Base: V/RB
Ceiling: ACP

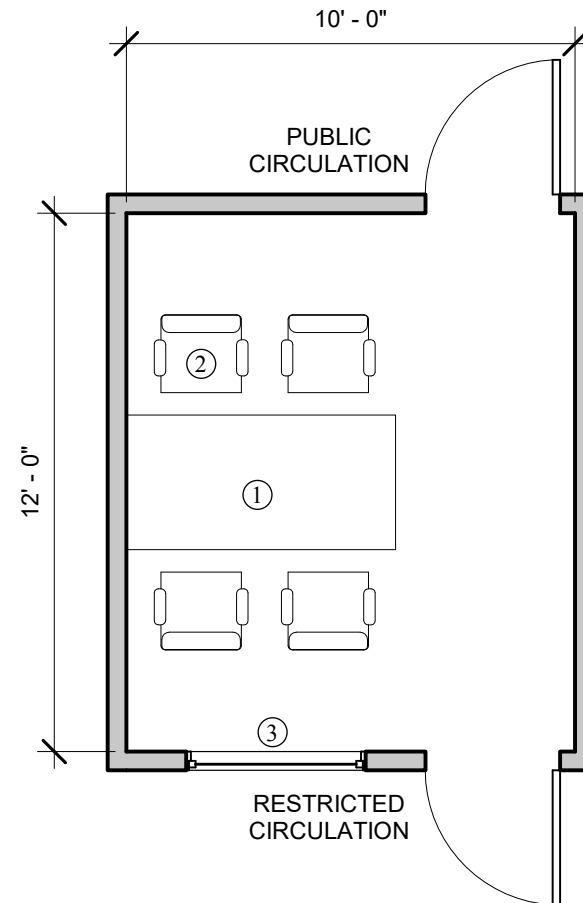

Legend:

- ① Systems Furniture
- ② Chair
- ③ Window (One-Way Glass)

Associated Probation and Pretrial Services Office Spaces

Space and Ceiling Requirements

CH. 9

Counter/Screening, per staff position **5 LF (1,525 mm)**

Architectural:

General Requirements:

Security Level: Restricted 1
Adjacent to: Reception/Waiting
Ceiling Height: 10'-0"

Finishes:

Wall: PNT-1
Floor: CPT, TZ, ST
Base: V/RB, TZ, ST
Ceiling: ACP

Millwork:

- Durable work surface with a divider to the floor below. Accommodate computer monitor, keyboard, and mouse at staff side of counter.
- Where ballistic and break-resistant glass is provided counter should accommodate document-size deal tray transaction opening for each station.

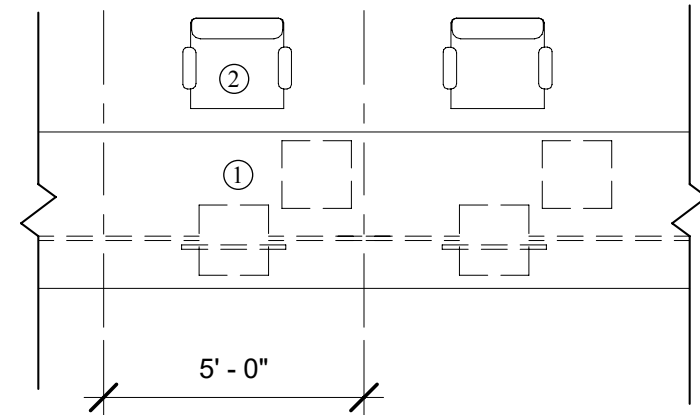

Legend:

- ① Counter
- ② Chair

Associated Probation and Pretrial Services Office Spaces

Space and Ceiling Requirements

CH. 9

Microform Reader/Printer 35 NSF (3.3 Nm²)
Microform Storage Cabinet, per cabinet 12 NSF (1.1 Nm²)

Architectural:

General Requirements:

Security Level: Restricted 1
Ceiling Height: 10'-0"

Finishes:

Wall: PNT-1
Floor: VCT
Base: V/RB
Ceiling: ACP

Space Notes:

1. Coordinate equipment selection and location early in planning process to account for structural implications.

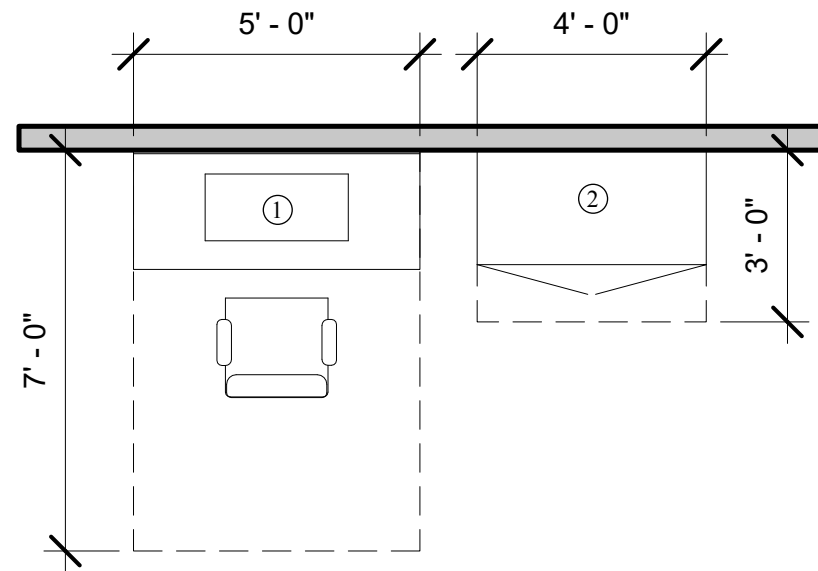

Legend:

- ① Microform Reader/Printer
- ② Microform Storage Cabinet

Associated Probation and Pretrial Services Office Spaces

Space and Ceiling Requirements

CH. 9

Toilet for Urinalysis Sample Collection 56 NSF (5.2 Nm²)

Architectural:

General Requirements:

Security Level: Restricted 3
Adjacent to: Urinalysis Test Lab and Specimen Storage Room
Ceiling Height: 10'-0"

Finishes:

Wall: PNT-2, CT Wainscot
Floor: CT
Base: CT
Ceiling: ACP

Fixtures, Furniture, and Equipment (FFE)

- wall-mounted flip down table (optional)
- occupied light/sign (optional)

Space Notes:

1. Urinalysis toilet rooms are secured and supervised. Each room should accommodate both the person providing the specimen and an officer to visually monitor the collection process, either directly or through the use of an observation mirror mounted in the room which provides a clear line of sight.
2. Urinalysis collection observation may be from an adjoining room through a window. The officer observation point should be equipped with a duress alarm.
3. Barrier-free access should be provided to each room, ideally through two doors. One door is to be used by the offender from the unsecured public waiting room, and the other door for the officer from the secured private office space. If space planning allows only one room access point, it is preferred that it be from the unsecured public waiting room.

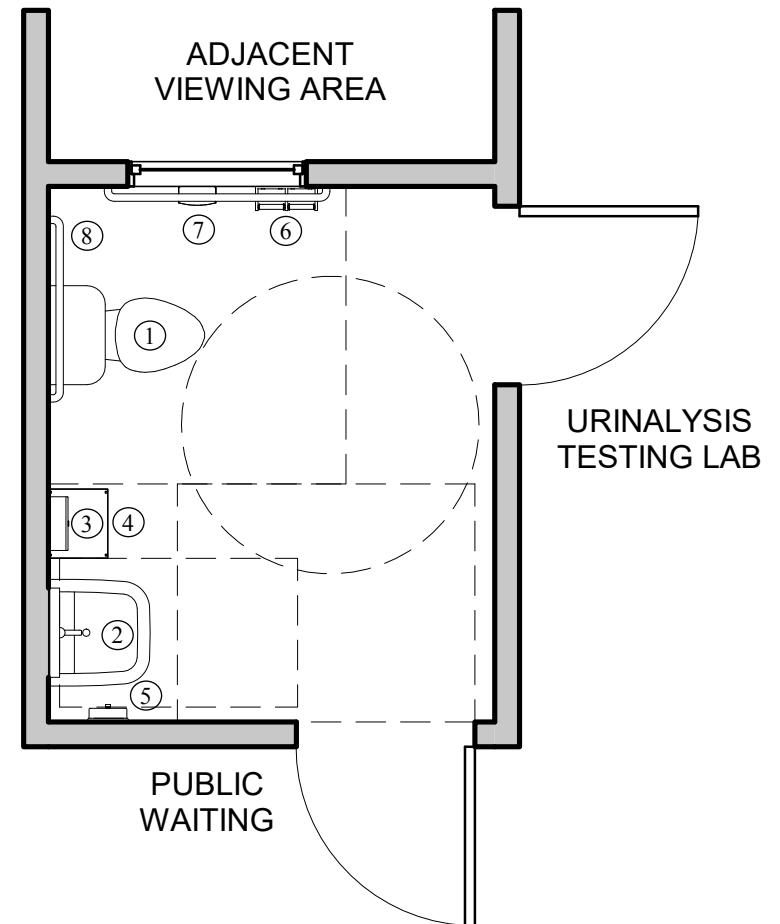

Legend:

- | | | |
|-------------------------|-----------------------|----------------------------|
| ① Toilet | ④ Waste Bin | ⑤ Sanitary Napkin Disposal |
| ② Sink | ⑤ Soap Dispenser | ⑥ Grab Bar |
| ③ Paper Towel Dispenser | ⑥ Toilet Paper Holder | ⑦ Observation Window |

Associated Probation and Pretrial Services Office Spaces

Space and Ceiling Requirements

CH. 9

Urinalysis Supplies Storage

25 NSF (2.3 Nm²)

Architectural:

General Requirements:

Security Level: Restricted 3
Adjacent to: Urinalysis Test Lab and Specimen Storage Room
Ceiling Height: 10'-0"

Finishes:

Wall: PNT-1
Floor: VCT, SV
Base: V/RB
Ceiling: ACP

Space Notes:

1. Should be securable; partitions should span from floor slab to floor slab above.

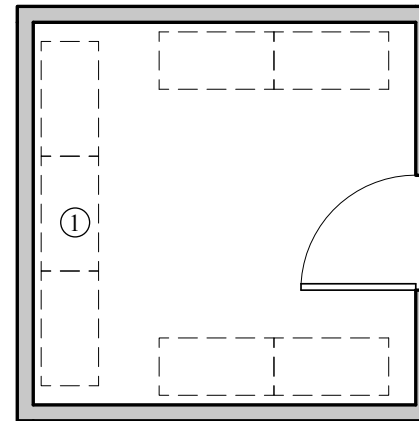

Legend:

① Shelves

Associated Probation and Pretrial Services Office Spaces

Space and Ceiling Requirements

CH. 9

Urinalysis Testing/EMIT Lab & Sample Storage

200 NSF (18.6 Nm²)

Architectural:

General Requirements:

Security Level: Restricted 3
 Adjacent to: Urinalysis Toilet, Urinalysis Supply Storage
 Ceiling Height: 10'-0"

Finishes:

Wall: PNT-3
 Floor: VCT
 Base: V/RB
 Ceiling: ACP

Fixtures, Furniture, and Equipment (FFE)

- Trash disposal
- (2) Operator Stools
- double stainless steel sink set in millwork base cabinets @ 44" high
- (2) Full-size refrigerators with freezers
- (2) Countertop EMIT machines @ 44" high

Space Notes:

1. Wall paint to be water-based catalyzed epoxy paint or another equally cleanable, durable material.
2. Chemical-resistant, laboratory-type finishes on all countertops.

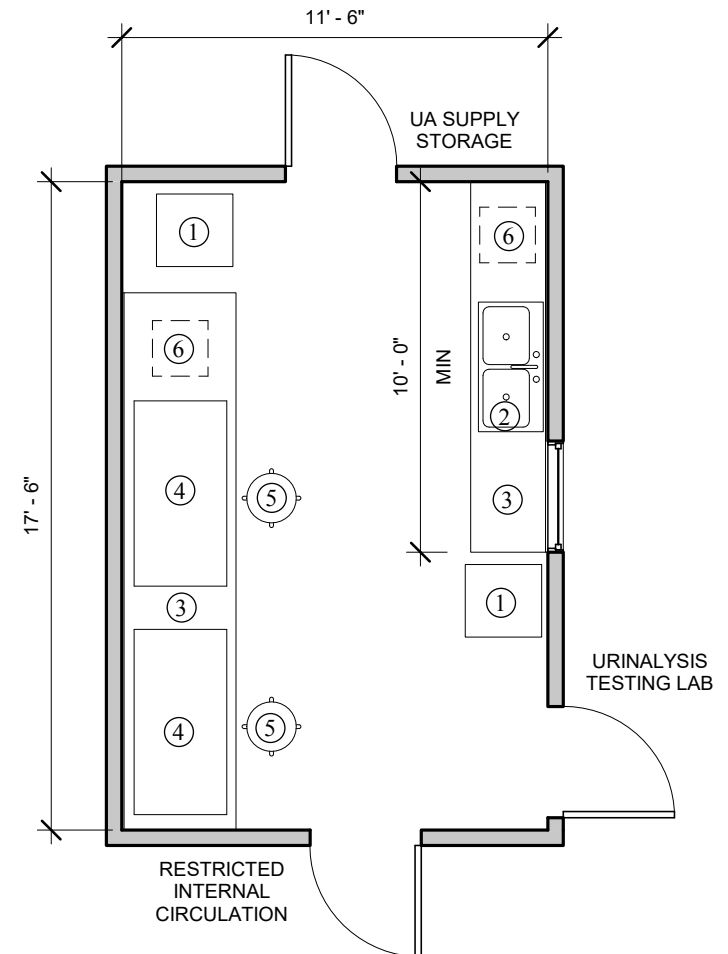

Legend:

- | | |
|--|-----------------------------|
| ① Full-Size Refrigerator | ④ EMIT Machine |
| ② Sink | ⑤ Operator Stool |
| ③ Chemical-Resistant Laboratory-Type Finished Countertop | ⑥ Trash Disposal Countertop |

Associated Probation and Pretrial Services Office Spaces

Space and Ceiling Requirements

CH. 9

Electronic Monitoring Equipment Storage/Repair Room

95 NSF (8.8 Nm²)

Architectural:

General Requirements:

Security Level: Restricted 3
Adjacent to: Restricted Internal Circulation
Ceiling Height: 10'-0"

Finishes:

Wall: PNT-1
Floor: CPT
Base: VCT
Ceiling: ACP

Millwork

- Upper and Base Cabinets; 8'-0" min in length
- 44" high counter

Furniture and Equipment

- Stainless Steel Shelving Units
- Work Table: durable for equipment repair

Space Notes:

1. Secure room controlled by a physical access control system (PACS) and monitored by an intrusion detection system (IDS) and closed circuit video (CCV). The room should be secured by a door with an electric strike and lock.
2. Should accommodate gun storage lockers, ammunition storage, a gun clearing station and a standalone gun vault (if required).
3. Walls are recommended to consist of either CMU block or metal stud and dry wall construction with heavy gauge metal mesh located on one side of the wall.
4. Walls are required to span from floor slab to floor slab. Floor slab should accommodate the additional structural load.

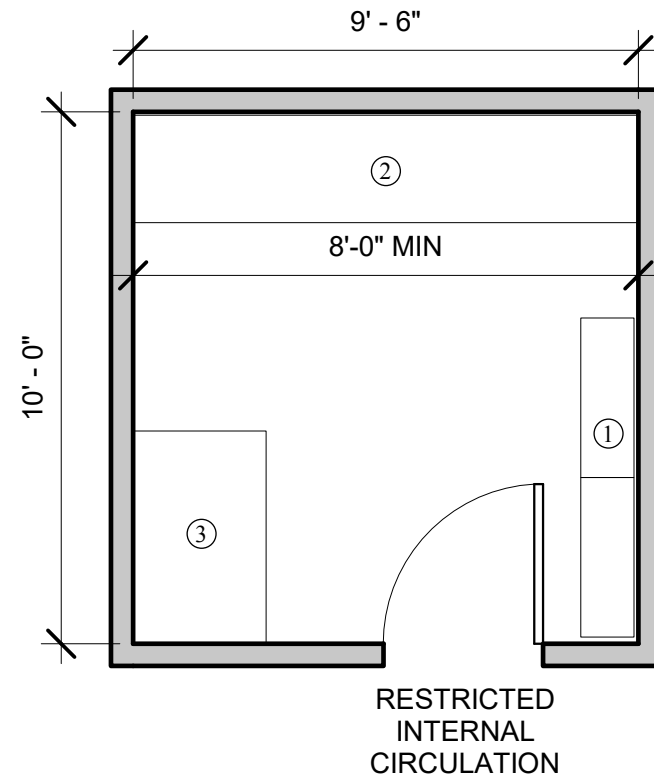

Legend:

- ① Shelves
- ② 44" high Counter
- ③ Table

Associated Probation and Pretrial Services Office Spaces

Space and Ceiling Requirements

CH. 9

Secure Computer Terminal/ Printer Room and LAN Server

150 NSF (13.9 Nm²)

Architectural:

General Requirements:

Security Level: Restricted 3
Adjacent to: Restricted Internal Circulation
Ceiling Height: 10'-0"

Finishes:

Wall: PNT-1
Floor: CPT
Base: V/RB
Ceiling: ACP

Space Notes:

1. Walls should be slab to slab to eliminate access through ceiling plenum, pipe chase, etc.
2. Door to be equipped with secure cipher lock, card reader, or keypad.

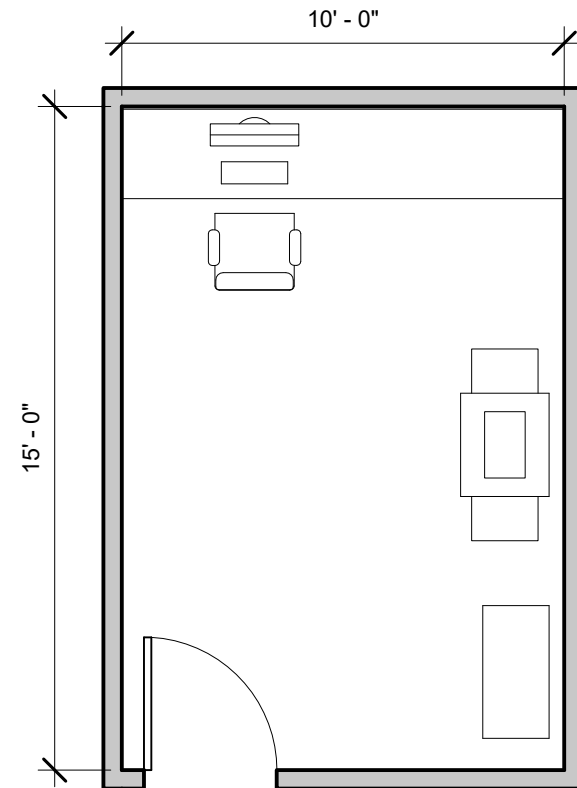

Associated Probation and Pretrial Services Office Spaces

Space and Ceiling Requirements

CH. 9

Gun Locker Room

100 NSF (9.3 Nm²)

Architectural:

General Requirements:

Security Level: Restricted 3
Ceiling Height: 10'-0"

Finishes:

Wall: PNT-1
Floor: CPT, SVT, SV, VCT
Base: V/RB
Ceiling: ACP

Space Notes:

1. Gun locker should be located within a securable space.

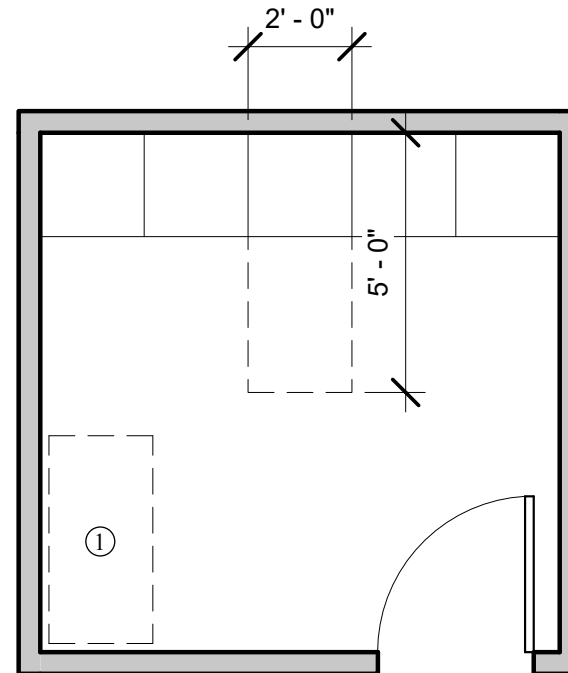

Legend:

① Discharge/Cleaning Area

Associated Probation and Pretrial Services Office Spaces

Space and Ceiling Requirements

CH. 9

Multipurpose Room

400 NSF (37.1 Nm²)

Architectural:

General Requirements:

Security Level: Restricted 3
Ceiling Height: 10'-0"

Finishes:

Wall: PNT-1
Floor: CPT
Base: V/RB
Ceiling: ACP

Fixtures, Furniture, and Equipment (FFE)

- Furniture should be movable.

Space Notes:

- A movable partition might be desired to divide the space depending on what functions this space will serve.

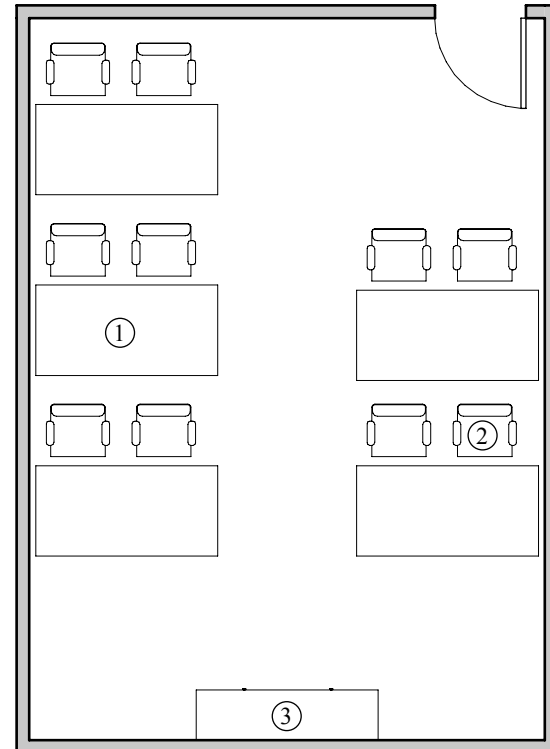

Legend:

- ① Table
- ② Chairs
- ③ Credenza

Associated Other Court Unit Office Spaces

Space and Ceiling Requirements

CH. 10

Queuing

105 NSF (9.8 Nm²)

Architectural:

General Requirements:

Security Level: Public 3
Adjacent to: Public & Restricted Circulation, Counter

Finishes:

Wall: PNT-1
Floor: VCT
Base: V/RB
Ceiling: ACP

Space Notes:

1. Assign 15 NSF (1.4 Nm²) per staff member. Minimum area is 105 NSF (9.8 Nm²)
2. In some courthouses ballistic-resistant transaction windows may be required to separate public and staff areas.

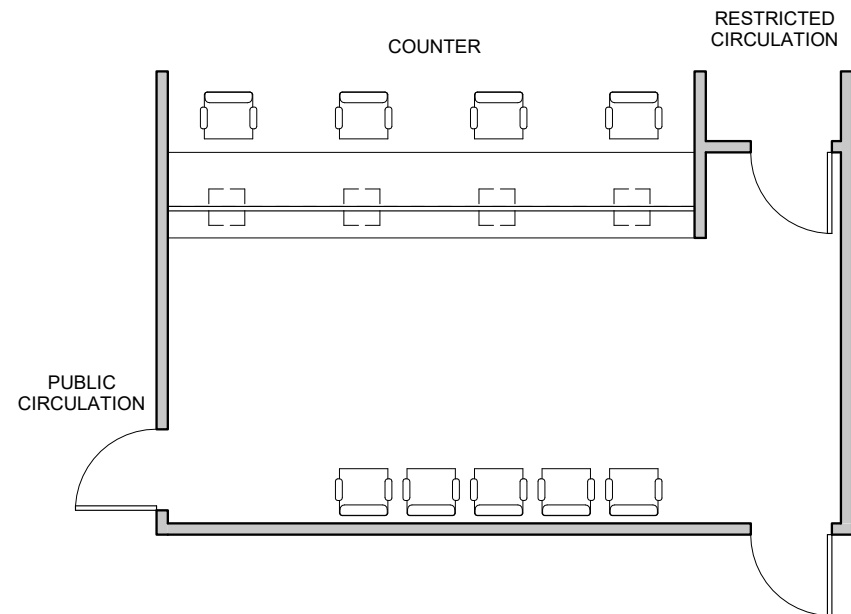

Associated Other Court Unit Office Spaces

Space and Ceiling Requirements

CH. 10

Accessory Stand-up Work Counter 100 NSF (9.3 Nm²)

Architectural:

General Requirements:

Security Level: Restricted 1, 4
Adjacent to: Intake Counter, Deputy Clerks
Ceiling Height: 10'-0"

Finishes:

Wall: PNT-1
Floor: CPT, TZ, ST
Base: V/RB, TZ, ST
Ceiling: ACP

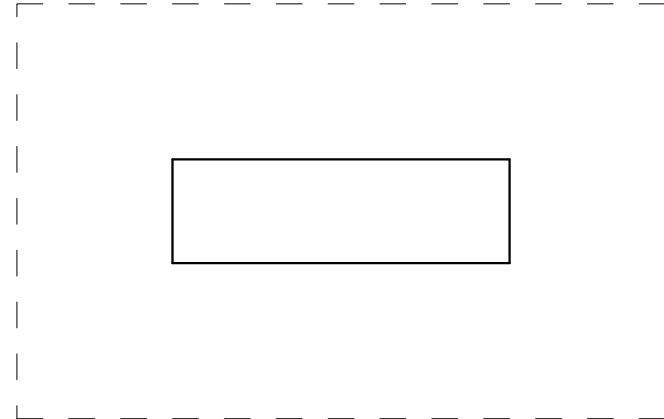

Associated Other Court Unit Office Spaces

Space and Ceiling Requirements

CH. 10

Records Examination Workstation

35 NSF (3.3 Nm²)

Architectural:

General Requirements:

Security Level: Public 2, Restricted 4
Adjacent to: Public Queuing
Ceiling Height: 10'-0"

Finishes:

Wall: PNT-1
Floor: CPT, TZ, ST
Base: V/RB, TZ, ST
Ceiling: ACP

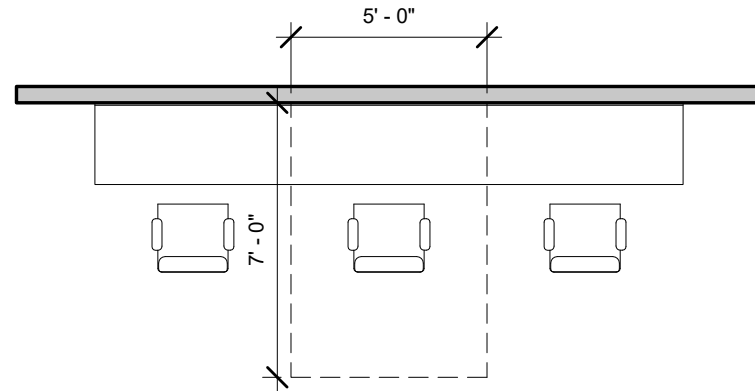

Associated Other Court Unit Office Spaces

Space and Ceiling Requirements

CH. 10

Public Access Computer Stations

35 NSF (3.3 Nm²)

Architectural:

General Requirements:

Security Level: Public 3, Restricted 3
Adjacent to: Public Corridor
Ceiling Height: 10'-0"

Finishes:

Wall: PNT-1
Floor: CPT, TZ, ST
Base: V/RB, TZ, ST
Ceiling: ACP

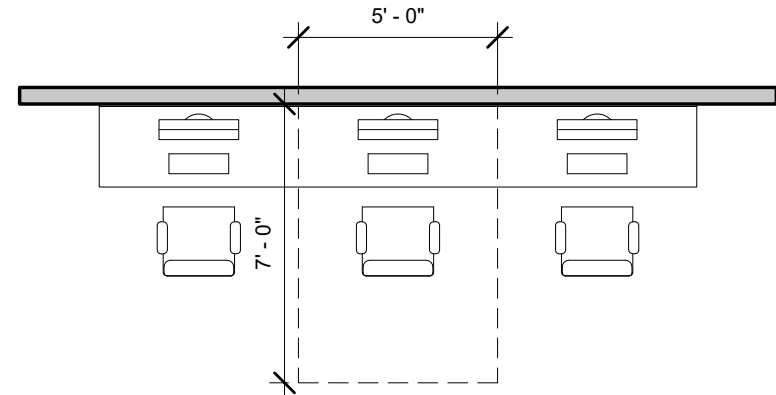

Associated Other Court Unit Office Spaces

Space and Ceiling Requirements

CH. 10

Records, Copier,

Work Room & Storage

350 NSF (32.6 Nm²)

Architectural:

General Requirements:

Security Level: Restricted 3
Adjacent to: Restricted Corridor
Ceiling Height: 10'-0"

Finishes:

Wall: PNT-1
Floor: VCT
Base: V/RB
Ceiling: ACP

Space Notes:

1. Provide record storage areas of 150 psf live load. Confer with clerk staff prior to the design of this area.

Associated Other Court Unit Spaces

Space and Ceiling Requirements

CH. 10

Catalog Library

Architectural:

General Requirements:

Security Level:	Restricted 1
Adjacent to:	Restricted Corridor
Ceiling Height:	10'-0"

Finishes:

Wall:	PNT-1
Floor:	CPT
Base:	V/RB
Ceiling:	ACP

Space Notes:

1. For executive's office only - Space allowance: 9 NSF (0.8 Nm²) for every 21 linear feet of catalogs. Add 25 NSF (2.3 Nm²) per person, & 64 NSF (5.9 Nm²) per CALR station.

Associated Other Court Unit Spaces

Space and Ceiling Requirements

CH. 10

Mail Work Area

100 NSF (9.3 Nm²)

Architectural:

General Requirements:

Security Level: Restricted 1
Adjacent to: Restricted Corridor
Ceiling Height: 10'-0"

Finishes:

Wall: PNT-1
Floor: VCT
Base: V/RB
Ceiling: ACP

Building Systems:

Security:

- Duress alarm

Space Notes:

1. Area includes a copier.

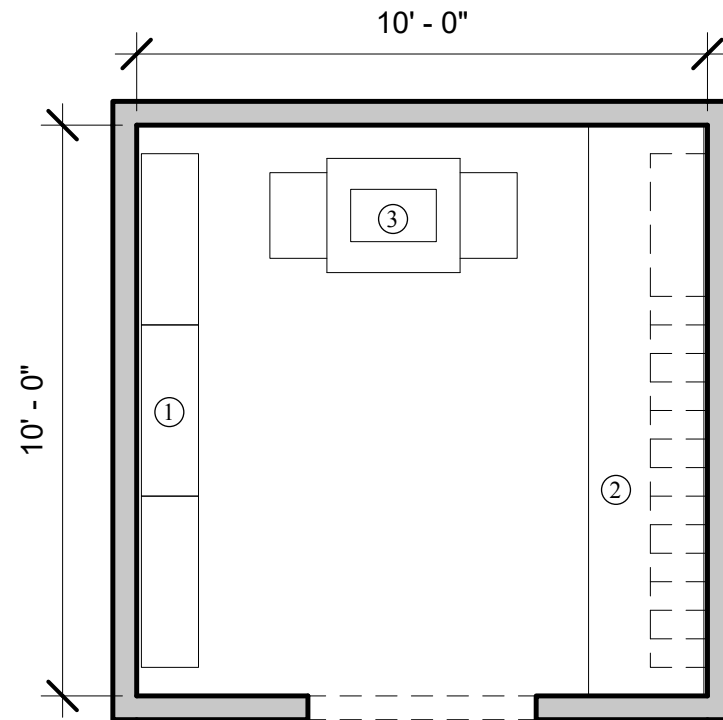

Legend:

- ① Shelves
- ② Counter
- ③ Copier

Associated Other Court Unit Spaces

Space and Ceiling Requirements

CH. 10

Conference/Reception/Waiting Room 100 NSF (9.3 Nm²)

Architectural:

General Requirements:

Security Level: Public 3, Restricted 1
Adjacent to: Public Corridor
Ceiling Height: 10'-0"

Finishes:

Wall: PNT-1
Floor: CPT
Base: V/RB
Ceiling: ACP

Associated Other Court Unit Spaces

Space and Ceiling Requirements

CH. 10

Creditor Meeting Room (341) 1,500 NSF (139.9 Nm²)

Architectural:

General Requirements:

Security Level: Restricted 2
Adjacent to: Restricted Corridor
Ceiling Height: 10'-0"

Finishes:

Wall: PNT-1
Floor: CPT
Base: V/RB
Ceiling: ACP

Shared Support Spaces
Space and Ceiling Requirements

Shared Judges' Conference Room

Minimum 200 NSF (18.6 Nm²)
Maximum 800 NSF (74.3 Nm²)

Architectural:

General Requirements:

Security Level: Restricted 3
Adjacent to: Restricted Circulation
Ceiling Height: 10'-0"
Acoustics: NIC 55 - Confidential

Finishes:

Wall: PNT-1, WD, WD Wainscot, AWP
Floor: CPT
Base: V/RB, WD
Ceiling: ACP

Building Systems:

Illumination:

Horizontal: 30-50 fc
Vertical: 10-15 fc
Lighting Control: Yes
Emergency Power: Yes
Emergency Lighting: Yes

Mechanical:

Air Changes: 8/hour

Security:

- Duress alarm
- Door Control

Space Notes:

1. Conference room at 100 NSF (9.2 Nm²) plus 25 NSF/judge (2.3 Nm²/judge). Square footage allocation for minimum and maximum is inclusive of 20 NSF (1.9 Nm²) for a service unit.

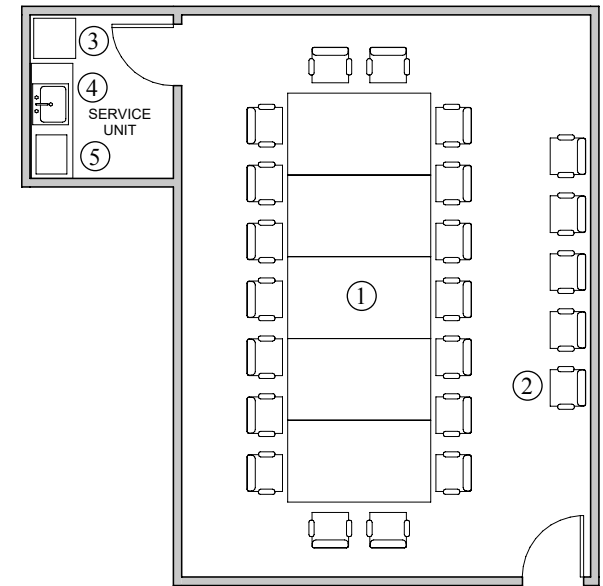
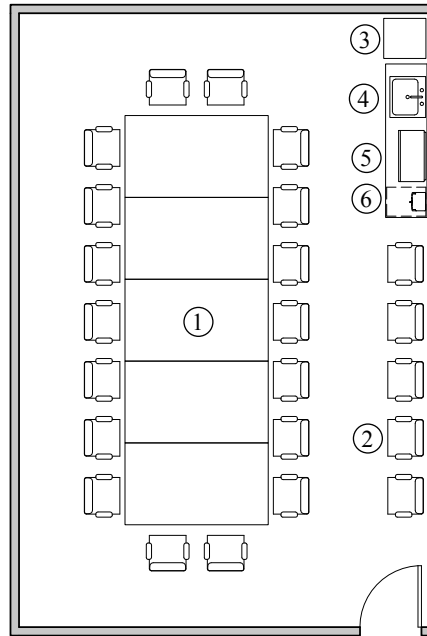

Legend:

- ① Table
- ② Chair
- ③ Refrigerator
- ④ Sink
- ⑤ Microwave
- ⑥ Coffeemaker

Shared Support Spaces

Space and Ceiling Requirements

CH. 11

Judges' Dining Area

Minimum	200 NSF (18.6 Nm²)
Maximum	400 NSF (37.2 Nm²)

Architectural:

General Requirements:

Security Level:	Restricted
Adjacent to:	Service Unit
Ceiling Height:	10'-0"
Acoustics	NIC 55 - Confidential

Finishes:

Wall:	PNT-1, WD Wainscot
Floor:	VCT, SVT
Base:	V/RB
Ceiling:	ACP

Fixtures, Furniture, and Equipment (FFE):

- (TBD) Table
- (TBD) Chair

Space Notes:

1. Dining area allocation is 15 NSF (1.4 Nm²) per judge plus 20 NSF (1.9 Nm²) service unit. The minimum allocation is 200 NSF (18.6 Nm²) and the maximum allocation is 400 NSF (37.2 Nm²) inclusive of the service unit.

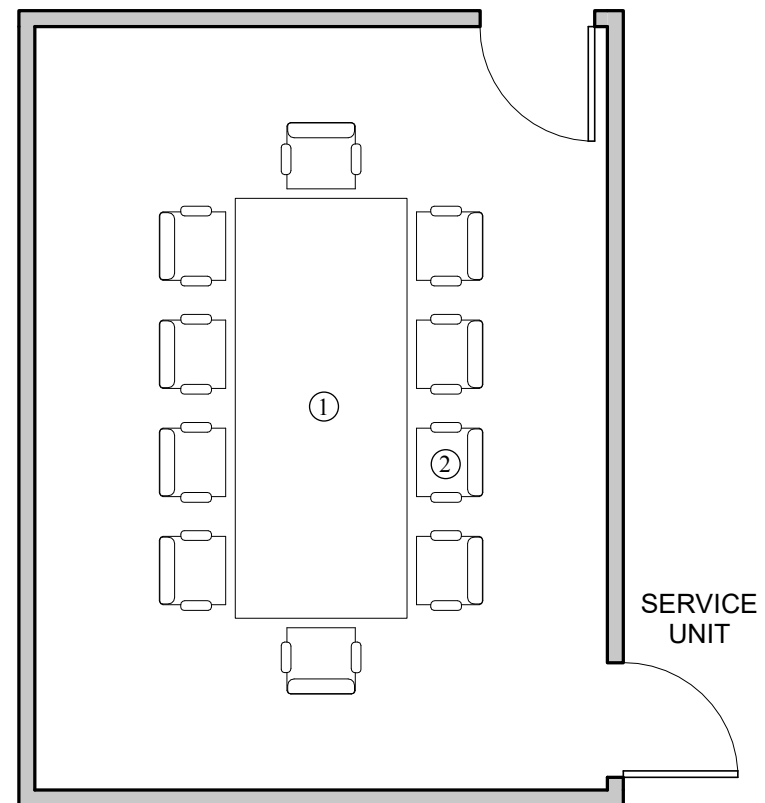

Legend:

- ① Table
- ② Chair

Shared Support Spaces
Space and Ceiling Requirements

News Media Room

Small	150 NSF (13.9 Nm²)
Medium	250 NSF (23.2 Nm²)
Large	450 NSF (37.1 Nm²)
Extra-Large	600 NSF (55.7 Nm²)

Architectural:

General Requirements:

Security Level: Public 3, Restricted 3
 Ceiling Height: 10'-0"

Finishes:

Wall: PNT-1
 Floor: CPT, VCT
 Base: V/RB
 Ceiling: ACP

Building Systems:

Illumination:

Horizontal: 30 fc
 Vertical: 5 fc
 Lighting Control: Yes

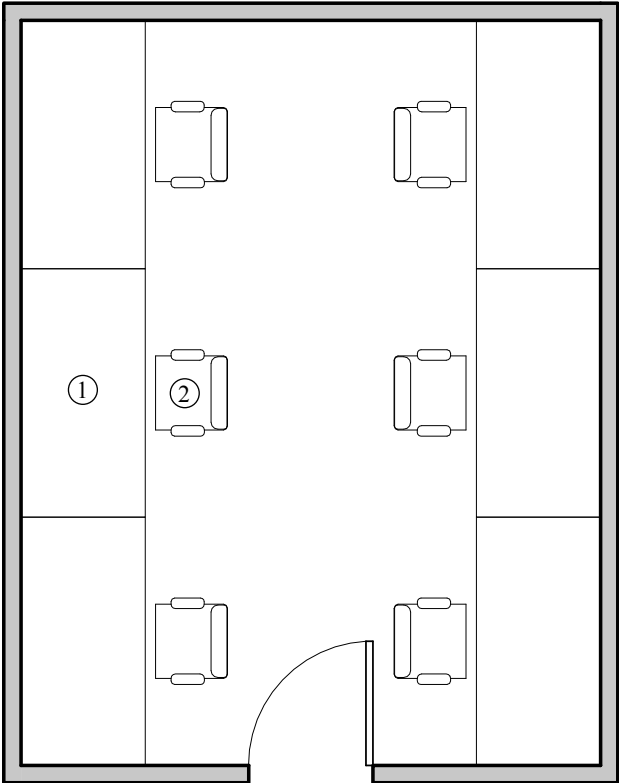

Legend:

- ① Table
- ② Chair

Shared Support Spaces

Space and Ceiling Requirements

CH. 11

Central Mail Facility

Small/Medium

800 NSF (81.7 Nm²)

Large/Extra-Large

1,100 NSF (102.1 Nm²)

Architectural:

General Requirements:

Security Level: Public 3, Restricted 1, 2
Adjacent to: Loading Dock, Screening Station
Ceiling Height: 10'-0"

Finishes:

Wall:
Floor:
Base:
Ceiling:

Building Systems:

Illumination:

Horizontal: 50 fc
Vertical: 10 fc
Lighting Control: Yes
Emergency Power: Yes
Emergency Lighting: Yes

Security:

- CCV camera
- Duress alarm
- Security intercom
- Door contact
- Card reader
- Audible alarm

Millwork

- Counter with sink and eyewash, upper and lower storage for personal protection supplies and equipment such as gloves, gowns, etc.

Furniture and Equipment

- Sorting Tables
- Chairs
- Mail Slots
- Storage Unit: for supplies and equipment
- Isolation Tubs: with "tight seal" lid

Space Notes:

1. Areas given are exclusive of the mail and package screening area on the loading dock. Only one central mail facility is funded for new construction.



Glossary

The following is an alphabetized list of specialized terms and abbreviations with their definitions referred to within the U.S. Courts Design Guide.

Glossary

341 conference room: conference room provided for a debtor to meet with the bankruptcy attorney and creditors

ABA: Architectural Barriers Act

ABAAS: Architectural Barriers Act Accessibility Standards

AC: alternating current

ACH: air changes per hour

ACT: acoustic ceiling tile

ADA: Americans with Disabilities Act

ADAAG: Americans with Disabilities Act Accessibility Guidelines

ADR: alternative dispute resolution

A/E: architecture/engineering

AFF: above finished floor

AFWP: acoustic fabric wrapped panel

AHU: air-handling unit

AI: articulation index

ALS: assisted-listening system

AMP: asset management plan amp: ampere, an electrical unit

ANSI: American National Standards Institute, the major standards organization in the United States and the publisher of the BOMA Standards, the NAHB Residential Standard, and ISO 9836 International Standard (www.ansi.org)

AnyCourt: US Courts questionnaire and software used to establish program of requirements for US Courts projects

AOUSC: Administrative Office of the U.S. Courts

AP: acoustic plaster

ASHRAE: American Society of Heating, Refrigerating, and Air-Conditioning Engineers

ASTM: American Society for Testing and Materials, a U.S. standards organization that publishes the IFMA Standard (www.astm.org)

AV: audiovisual (equipment)

A/V: audio/video

AWI: American Woodworking Institute

BAP: bankruptcy appellate panel

Berm: a mound or wall of earth, typically at the top or bottom of a slope

Bollard: a short vertical post, typically refers to permanent physical security elements which are established to control access to the site

BOMA: Building Owners and Managers Association

BOMA Standard: Either the Standard Method for Measuring Floor Area in Office Buildings or the Standard Methods for Measuring Floor Area in Industrial Buildings, depending on the occupancy of a property. It is clearer to refer to the BOMA Office Standard or the BOMA Industrial Standard, and clearer yet to specify the publication year. The Office Standard in particular has been modified and republished many times, and it is likely that the Industrial Standard will be also.

BOP: Bureau of Prisons

Brooks Act (40 USC Sections 541–544) legislation that establishes the requirement for a technical quality-based procurement of professional design services (rather than low price)

BSC: Building Security Committee

C: Celsius

CAB: cabinet

CALR: computer-assisted legal research

CAT: computer-aided transcription

CCMG: Central Courthouse Management Group

CCP: GSA's Center for Courthouse Programs

CCTV: closed-circuit television

CD-ROM: compact disc read-only memory

CFM: cubic feet (of air) per minute

CIRC: circulation

CITES: Convention on International Trade in Endangered Species

CL or CLOS: closet

CM/ECF: case management/electronic case filing

CMU: concrete masonry unit

CONF: conference

CONT. CIR.: controlled circulation

CPT: carpet

CPTT: carpet tile
CRI: Carpet and Rug Institute
CSC: Court Security Committee
CSO: court security officer
CT: ceramic tile
CTB: ceramic tile base
CTRM: courtroom
CUST or CUSTOD: custodian
custom grade: millwork standard of quality
CWT: ceramic wall tile
D: deep; direct (lighting)
dB: decibel
DDC: direct digital control
DHS: Department of Homeland Security
DOJ: Department of Justice
Double-loaded corridors: corridors with offices or spaces on both sides
DUSM: deputy U.S. Marshal
DVD: digital video disc
ELEC: electrical
ELEV: elevator
EMIT: enzyme multiplied immunoassay technique (machine)
en banc courtroom: panel courtroom where judges hear cases together
EPA: Environmental Protection Agency
EQUIP: equipment
ERS: electronic recording system
EVAC: emergency evacuation system
EXEC: executive
EXHIB: exhibit
F: Fahrenheit
FAP: furniture acquisition plan
FINANC: financial

FIT: Fitness in Total (program)
FLUOR: fluorescent (lighting)
FPD: federal public defender
FPMR: Federal Property Management Regulations
FPS: Federal Protective Service
FT: feet
FC: foot-candles
FWC: fabric wall covering
ga: gauge
Gm2: gross square meters
GSA: General Services Administration
GSA P-100: GSA's Facilities Standards for the Public Buildings Service
GSF: Gross square feet represents the floor area within the inside perimeter of the exterior walls of the building under consideration, exclusive of vent shafts and courts, without deduction for corridors, stairways, closets, the thickness of interior walls, columns, or other features. The floor area of a building, or portion thereof, not provided with surrounding exterior walls shall be the usable area under the horizontal projection of the roof or floor above. The gross floor area shall not include shafts with no openings or interior courts.
HC: handicapped
HI: high
HVAC: heating, ventilating, and air-conditioning
I: indirect (lighting)
ID: identification
IEC: International Electrotechnical Commission, sets standards and conformity assessment for Government business and for all electrical, electronic and related technologies.
IIC: Impact Isolation Class
IN: inches
INCAN: incandescent (lighting)
ISC: Interagency Security Committee
JCUS: Judicial Conference of the United States
JSS: Judicial Security Systems

kg: kilograms
L: liters
LAN: local area network
LF: linear feet
LG: large
LIN.FT.: linear feet
LIN.IN.: linear inches
Ln: linoleum
L/s: liters per second
lx: lux
m: meters
m²: square meters
MAG: magistrate judge
MATV: master antenna television (system)
max.: maximum
MDF: main distribution frame
MED: medium
Metric Conversion Act of 1975: The Metric Conversion Act of 1975 (later amended by the Omnibus Trade and Competitiveness Act of 1988, the Savings in Construction Act of 1996, and the Department of Energy High-End Computing Revitalization Act of 2004) designated the metric system as the preferred system of weights and measures for U.S. trade and commerce, and directed federal agencies to convert to the metric system to the extent feasible, including in the construction of federal facilities.
min.: minimum
mm: millimeters
NC: noise criteria
NEC: National Electrical Code
NFPA: National Fire Protection Association
NIC: Noise Isolation Class
Nm²: net square meters
NRC: noise reduction coefficient

NSF: Net square feet represents the actual occupied area of a floor, not including accessory unoccupied areas (stairs, elevator and HVAC shafts, mechanical rooms, etc.) or the thickness of walls.
OCLC: online computerized library catalog
OCM: Office of Courthouse Management
OFC: office
Omnibus Trade Act of 1988
OP: operated
OSHA: Occupational Safety and Health Administration
OSS: Office of Security Systems
oz: ounces
Pa: pascals
PA: public address (system)
PBS: Public Buildings Service
PC: personal computer
PDS: Prospectus Development Study
peened: Hinge pin ends are peened, or flattened, in order to prevent pin removal. Hinges may be peened as a security measure.
Pln: paneling
PNT: Paint 1: latex, eggshell finish
PNT: Paint 2: latex, semigloss finish
PO: probation office
PRIV: private
PROF: professional
PSF: pounds per square foot
PSO: pretrial services office
PT1: paint color 1
PTR: printer
RASTI: Rapid Speech Transmission Index
RC: Room criterion is an acoustic measurement of background noise.
RCDD: registered communications distribution designer
RDR: reader

REC or RECEIPT: reception
REP/REC: reporter/recorder
REQ: requirement
REQ'D: required
REVERB: reverberation
RM: room
RSF: rentable square feet
S: standard ceiling height of 8–10 feet; summer
SCR: silicone-controlled rectifier
SEC: security
SECR: secretary
SF: square feet
SHRED: shredder
SI: Système international d'unités, or International System of Units (also known as the metric system)
SL: soundlock
SRAC: spatial relationship, accessibility, and circulation (diagram)
ST or STOR: storage
STC: Sound Transmission Class
STI: Speech Transmission Index
SUP: supply
TDD: telecommunications device for the deaf
TEL: telephone
TEMP: temperature
TERM: terminal
TI: tenant improvement
TL: transmission loss
TLT: toilet
UA: urinalysis
UFAS: Uniform Federal Accessibility Standards
UL: Underwriters Laboratories

UPS: uninterrupted power supply
USBC: U.S. Bankruptcy Court
USCA: U.S. Court of Appeals
USDC: U.S. District Court
USF: Usable square feet represents the BOMA Office Standard connoting the sum of office, store, and building common areas on a floor.
USMS: U.S. Marshals Service
USMS Publication 64: *Requirements and Specifications for Special Purpose and Support Space Manual, Volume Three, Judicial Security Systems Requirements and Specifications*
V/RB: vinyl/rubber base
V: volt
VAV: variable air volume
VB: vinyl base
VCR: videocassette recorder
VCT: vinyl composition tile
VDT: video display terminal
VEST: vestibule
VIT: vinyl inset tile
VOL: volume
W: wide; winter; watts
WAN: wide area network
WB or WDB: wood base
WC: water closet
WD: wood
WD Pln: wood paneling
WD Wnst: wood wainscot
WK: work
WKRM: work room
WKSTA: workstation
Wnst: wainscot
x: time(s) or by



Index

A

Accessibility

See Barrier free access

Acoustics

See Chapter 14, “Acoustics”

Adjacency and Circulation

Appellate Courtrooms, 4-9

Bankruptcy Judge Courtroom, 4-21

Clerks’ Office, 8-9

Common Building Spaces, 11-7

Court Libraries, 7-9

District Judge Courtroom, 4-13

Judges’ Chambers Suites, 6-8

Jury Facilities, 5-7

Magistrate Judge Courtroom, 4-18

Other Court Units, 10-8

Probation and Pretrial Services Offices, 9-9

Adjacency Relationships

Clerk’s Office

Bankruptcy, 8-11

Court of Appeals, 8-10

District, 8-11

Common Building Support Spaces, 11-8

Court Libraries

Circuit Headquarters, 7-10

Satellite, 7-11

Unstaffed, 7-12

Courtrooms

Appellate, 4-10

Magistrate Judge, 4-19

U.S. Bankruptcy Court, 4-23

U.S. District Court, 4-14

Judges’ Chamber Suites

Circuit Judge’s Non-resident/Visiting Chambers, 6-10

Circuit Resident Judge’s Chambers, 6-9

District Judge’s Resident Chamber, 6-11

District, Magistrate or Bankruptcy Judge’s Visiting Chambers, 6-12

Magistrate or Bankruptcy Judge’s Resident Chambers, 6-13

Jury Facilities

Grand Jury Suite, 5-10

Jury Assembly Suite, 5-8

Trial Jury Suite, 5-9

Other Court Units

Bankruptcy Administrator, Office of the, 10-13

Bankruptcy Appellate Panel (BAP) Clerk, Office of the, 10-10

Circuit Executive, Office of the, 10-9

District Court Executive, Office of the, 10-9

Federal Defender’s Trial Preparation Suite, Office of the, 10-14

Pre-Argument/Conference Attorney, Office of the, 10-12

Senior Staff Attorney, Office of the, 10-11

Probation and Pretrial Services Offices, 9-10

Air distribution

See Chapter 15 “Building Systems”

Alternative Workplace Strategies, 1-6

Amplifiers

See Chapter 15 “Building Systems”

Appellate Courtrooms, 4-8, 4-9, 4-10

Assisted listening systems (ALSs), 3-7

Attorney and Litigant Station, 4-13, 4-18, 4-21

Attorney Station, 4-8

Attorney Table

See Counsel Table

Attorney/witness conference rooms, 3-6

Attorney/Witness Room, 4-4, 4-6, 4-12, 4-15, 4-17, 4-18, 4-22, 14-6, 14-8, 15-14

Attorney Work Area, 4-6, 4-9, 4-12, 4-17, 4-22

Attorney Work Room, 4-4, 4-8, 4-11, 4-15, 4-18, 4-22, 14-6, 14-8, 15-14

Audio

See Chapter 15 “Building Systems”

Automation

Voice, Data, Courtroom Audio/Video, and Low-Voltage Cabling Design, 15-15

B

Bailiff, 15-14

Bailiff’s station, 3-6

Bankruptcy Administrator, Office of the, 1-6, 10-1, 10-4, 10-7, 10-13, 14-7, 14-10, 15-18, 16-9, 18-1, 18-12

Bankruptcy Appellate Panel Clerk, Office of the, 10-1, 10-4, 10-5, 10-6, 10-8, 10-10, 18-1, 18-12

Bankruptcy Judge Courtrooms, 4-6, 4-20, 4-22

Barrier free access, 4-8

Bench

See Judges’ Bench

Benchmarking, 2-4

BOMA, 3-8

Break-resistant glass

See Chapter 16, “Building Security”

Budget

See Chapter 2 “Courthouse Programming and Budgetary Considerations”; *See also* Costs

Building circulation

See “Adjacency and Circulation”

Building entrances

See Chapter 16, “Building Security”

Building Security Committee, 3-5

Building support areas, 12-6

Building support functions, 11-5

Bullet-resistant glazing

See Chapter 16 “Building Security”

C

Cafeteria, 11-4, 11-7

CALR, 7-7, 7-9, 10-8, 15-13, 15-14, 15-18

Ceiling Height

Common Building Spaces, 11-6

Court Libraries, 7-5

Courtrooms and Associated Spaces, 4-6

Judges’ Chambers Suites, 6-4

Other Court Units, 10-5

Probation and Pretrial Services, 9-5

Ceiling heights

See Space and Ceiling Requirements

Cell block, 16-7

Circuit Executive, Office of the

See Chapter 10 “Other Court Units”

Circuit Judicial Councils, 1-3, 3-3, 4-3, 5-2, 6-2, 7-2, 8-2, 9-3, 10-2, 11-2, 17-3, 18-4

Circulation

See Adjacency and Circulation

Clean power

See Chapter 15, “Building Systems”

Clerk’s Office

See Chapter 8, “Clerk’s Office”

Building Security, 16-7, 16-8, 16-12

Communication Systems, 15-18

Other, 1-7, 1-8, 1-9, 1-10, 2-6, 3-5, 3-12, 3-13, 3-14, 5-6, 6-5, 6-7, 6-11, 6-12, 6-13, 9-4, 10-8

Tenant Improvements and Furnishings, 12-4, 12-6

Clock

See Chapter 12 “Tenant Improvements and Furnishings”

Closed-circuit television

See Chapter 16, “Building Security”

Committee on Space and Facilities, 1-3, 2-8, 3-3, 4-3, 4-20, 5-2, 6-2, 7-2, 8-2, 9-3, 10-2, 11-3, 16-5, 17-3, 18-4

Communications

See Chapter 15, “Building Systems”

Computer-Assisted Legal Research (CALR)

See CALR

Control room

See Chapter 15, “Building Systems”

Costs

Benchmarking, 2-4

Construction, 2-4, 2-7, 2-9, 2-12, 2-13, 12-2, 12-3, 17-7
Cost-Control, 2-4, 2-5
Funding Responsibilities, 2-5, 2-12, 2-14, 2-15, 2-16, 2-17, 12-10, 12-11, 15-2
Life-Cycle cost, 2-2, 2-4, 2-6, 12-3, 12-11
Value Engineering, 2-6
Counsel table, 4-8, 4-11, 4-13, 4-15, 4-17, 4-18
Counter
 See Public counters
Courthouse Management Group (CCMG), 2-3, 11-2, 12-2, 15-2
Courthouse Project Development, 2-7
Court of Appeals, U.S., 1-7, 1-8, 3-5, 3-12, 4-2, 6-4, 7-4, 8-4, 8-6, 8-8, 8-10, 16-8, 18-12
 See also Chapter 4, “Courtroom and Associated Spaces”
Court-related offices, 2-5, 3-2, 8-4, 9-4, 9-7, 10-3, 15-4, 15-8, 16-7, 16-9
 See also Chapter 10, “Other Court Units”
Court Reporter/Recorder, 4-11, 4-12, 4-15, 4-16, 4-17, 4-18, 4-20, 4-21, 4-22, 5-5, 8-4, 12-11, 12-12, 15-11, 15-14, 15-16, 15-17
Courtroom deputy clerk, 2-15, 4-4, 4-8, 4-11, 4-15, 4-16, 4-18, 4-20, 4-22, 6-5, 6-7, 6-11, 6-12, 6-13
Courtroom Technology Manual, 2-3, 3-4, 4-2, 4-6, 11-2
Court Security Committee (CSC)
 See Chapter 16 “Building Security”
Court security officers
 See Chapter 16 “Building Security”

D

Defender
 See Federal public defender
Definitions
 See “Glossary”
Departures, approval for
 See Approval for departures from the Design Guide
Deputy U.S. Marshal
 See Security
Design process, 1-2, 2-4, 13-2, 14-5, 16-2, 16-3
Design Requirements
 Acoustics, 14-3, 14-10
 All Courtrooms, 4-4, 4-6
 Appellate Courtrooms, 4-8

Bankruptcy Judge Courtrooms, 4-20
Building Systems, 15-18
Clerk’s Office, 8-5
Common Building Spaces, 11-5
Court Libraries, 7-5
District Judge Courtrooms, 4-11
Interior Finishes, 12-3
Interior Signage, 13-2
Judges’ Chambers Suites, 6-4, 6-8
Jury Facilities, 5-5
Magistrate Judge Courtrooms, 4-16
Millwork, 12-10
Other Court Units, 10-4
 Probation and Pretrial Services Offices, 9-5
disposal, 9-6, 11-6, 11-7, 12-11
District Court Executive, Office of the
 See Chapter 10, “Other Court Units”
District Judge Courtrooms, 4-11, 4-12, 4-15
Doors
 See Chapter 12, “Tenant Improvements and Furnishings”
Duress alarms
 See Chapter 16, “Building Security”

E

Electrical System
 See Chapter 15, “Building Systems”
Electric door strike
 See Chapter 16, “Building Security”
Electronic case management/electronic case filing
 See CM/ECF
Emergency lighting
 See Chapter 15, “Building Systems”, and 16, “Building Security”
Emergency power
 See Chapter 15, “Building Systems”, and 16, “Building Security”
En Banc Courtrooms, 4-6, 4-9, 4-10, 16-14
Energy considerations
 See Chapter 15, “Building Systems”
Engineering systems
 See Chapter 15, “Building Systems”

Equipment (copiers, fax machines, modems, telephones, computers)

See Chapter 12, “Tenant Improvements and Furnishings”

Equipment rooms

See Chapter 11, “Common Building Spaces”, and 15, “Building Systems”

Evacuation Systems

See Chapter 15, “Building Systems”

Exhibits

Display, 4-5, 4-12, 4-16, 4-20, 4-21, 5-6, 15-12, 15-13, 15-14

Storage, 4-9, 4-11, 4-12, 4-16, 4-17, 4-22, 5-4, 5-5

Expansion, 2-5, 2-6, 2-9, 2-11, 15-3, 15-7, 16-4, 17-5, 17-8

Explosives

See Chapter 16, “Building Security”

F

Facilities Standards for the Public Buildings Service

See General Services Administration, GSA P-100

Federal Court System, 1-4, 1-5

Federal Defender, Office of the

See Chapter 10, “Other Court Units”

File storage, 2-6, 6-6, 15-14

Finishes, design requirements

See Chapter 12, “Tenant Improvements and Furnishings”

Foreperson/secretary station

Grand jury station, 15-17

Functions (and Activities)

All Courtrooms, 4-4

Alternate Workplace Strategies, 18-5

Appellate, 4-8

Bankruptcy Judge Courtrooms, 4-20

Clerk’s Office, 8-4

Common Building Spaces, 11-4

Court Libraries, 7-4

District Judge Courtrooms, 4-11

Judges’ Chambers Suites, 6-4

Jury Facilities, 5-4

Magistrate Judge Courtrooms, 4-15

Other Courts Units, 10-4

Probation and Pretrial Services, 9-4

Furniture Acquisition Plan (FAP), 2-14, 12-10, 12-11

Furniture/Furnishings and Equipment

See Chapter 12, “Tenant Improvements and Furnishings”

G

General area network

See Automation, Data communications networks

General building service areas

See Chapter 11, “Common Building Spaces”

General Services Administration (GSA)

Benchmarking, 2-4

GSA-P100

See P-100

Governing codes and criteria, 15-2

See also Supporting Documents

Grand Jury, 1-5, 2-5, 2-6, 3-6, 5-4, 5-5, 5-6, 5-7, 5-10, 12-8, 14-6, 14-7, 14-9, 15-3, 15-5, 15-11, 15-13, 15-17, 16-8

Grounding

See Electrical systems

GSA

See General Services Administration

GSA P-100

See P-100

Guide to Judiciary Policy, 2-3, 2-15, 2-17, 6-3, 12-2, 12-11, 12-12, 18-3

H

Handicapped access

See Barrier-free access

Hearing impaired

See Barrier-free access

Heating, ventilating, and air-conditioning systems

See Chapter 15, “Building Systems”

Heat sensor, 15-7

Human Resources Manual

See Chapter 12, “Tenant Improvements and Furnishings”

HVAC

See Heating, ventilating, and air-conditioning

I

- Image projection, 4-6, 15-9, 15-10, 15-11, 15-17
 - See also* Chapter 12, “Tenant Improvements and Furnishings”
- Interagency Security Committee (ISC), 2-3
- Intercoms
 - See* Chapter 16, “Building Security”
- Interior finishes, 12-2, 12-3
- Interior security
 - See* Chapter 16, “Building Security”
- Interior Signage
 - See* Chapter 13, “Interior Signage”
- Interns/externs
 - See* Chapter 6, “Judges’ Chambers Suites”
- Intrusion-detection systems
 - See* Chapter 16, “Building Security”

J

- Judges’ bench
 - See* Chapter 4, “Courtrooms and Associated Spaces”
- Judges’ bench, 4-8
- Judges’ Chambers Suites
 - See* Chapter 6, “Judges’ Chambers Suites”
- Judges’ robing rooms, 3-5, 4-8, 4-9, 4-11
- Judicial Conference of the United States (JCUS), 1-2, 1-3, 2-3, 2-4, 2-8, 3-3, 4-3, 5-2, 6-2, 7-2, 8-2, 9-3, 10-2, 11-3, 12-2, 16-5, 17-3, 18-4
- Judicial Security Systems (JSS), 2-3, 3-4, 9-9, 11-2, 11-7, 12-2, 15-2, 15-8, 16-2, 16-3, 16-4, 16-5, 16-7, 18-3, 18-7
- Judiciary-related offices
 - See* Chapter 10, “Other Court Units”
- Jury assembly area
 - See* Chapter 5, “Jury Facilities”
- Jury box, 4-13, 4-16, 4-21
- Jury facilities
 - See* Chapter 5, “Jury Facilities”

K

- Key locks
 - See* Chapter 16, “Building Security”

L

- Landscaping
 - See* Chapter 16, “Building Security”
- Law clerks’ office
 - See* Chapter 6, “Judges’ Chambers Suites”
- Law clerk’s station, 2-15
- Lectern, 12-10
 - See* Chapters 4, “Courtrooms and Associated Spaces”
- Library
 - See* Chapter 7, “Court Libraries”
- Life-cycle costing
 - See* Costs
- Life Safety Systems, 16-6
- Lighting design and systems
 - See* Chapter 15, “Building Systems”
- Litigant table
 - See* Counsel table
- Loading docks
 - See* Chapter 11, “Common Building Space” and Chapter 16, “Building Security”
- Lobby
 - Public, 2-2, 2-14, 3-4, 3-5, 3-7, 4-4, 7-7, 12-3, 12-4, 12-6, 12-12, 13-2, 13-3, 15-14, 16-5, 16-6, 16-7, 16-8, 16-9
- Local Area Network (LAN)
 - See* Chapter 15, “Building Systems”
- Lounge
 - Staff, 10-8
 - Work, 18-6, 18-7
- Low-voltage, 15-8, 15-15

M

- Magistrate Judge Courtroom, 4-15, 4-16, 4-17, 4-18
- Magistrate judges’ chambers suites, USDC
 - See* Chapter 6, “Judges’ Chambers Suites”
- Mail room, 7-9, 8-5, 11-4, 11-7, 16-9
- Main library
 - See* Library
- Master antenna television (MATV)
 - See* Glossary

Mechanical systems, 15-3, 15-4, 15-7, 15-16, 15-18
Metal detectors
 See Security
Millwork (tenant improvement)
 See Chapter 12, “Tenant Improvements and Furnishings”
Motion detectors
 See Security
Multi-tenant, 1-2, 1-5, 16-3, 16-9, 16-10

N

Networks
 See Automation, Data communications networks
Noise criteria value
 See Chapter 14, “Acoustics”

P

Perimeter security
 See Chapter 16, “Building Security”
Personnel security
 See Chapter 16, “Building Security”
Plumbing, noise reduction
 See Chapter 14, “Acoustics”
Pre-argument/Conference Attorney, Office of the
 See Chapter 10, “Other Court Units”
Pretrial services office
 See Judiciary-related offices
Privacy
 See Chapter 14, “Acoustics”
Probation Office, U.S.
 See Judiciary-related offices and U.S. Probation Office
Programming process
 See Chapter 2, “Courthouse Programming and Budgetary Considerations”; *See* Chapter 3, “Planning for U.S. Courthouses”
Project process
 See Chapter 2, “Courthouse Programming and Budgetary Considerations”; *See* Chapter 3, “Planning for U.S. Courthouses”
Property and documents
 See Security

Prospectus Development Study (PDS)
 See Glossary
Public lobby
 See Lobby, public
Public Waiting Areas, 3-4, 3-5, 3-7, 4-4, 4-9, 4-12, 4-17, 4-22, 12-12, 13-3, 14-6, 14-8, 15-11, 18-9

R

Raised Access Flooring, 12-3, 14-5, 15-8, 15-9
Relocation, 2-5, 7-5
Renovation of existing courthouses
 See Chapter 2, “Courthouse Programming and Budgetary Considerations”
Reverberation time
 See Chapter 14, “Acoustics”
Robing room, 3-5, 4-8, 4-9, 4-11, 4-12, 4-15, 4-16, 4-18, 4-20, 4-22, 12-8, 14-6, 16-7

S

Sally port
 See Chapter 16, “Building Security”
Satellite library
 See Chapter 7, “Court Libraries”
Security concepts
 See Chapter 16, “Building Security”
Senior Staff Attorney, Office of the
 See Chapter 10, “Other Court Units”
Service unit
 See Chapter 12, “Tenant Improvements and Furnishings”
Settlement director
 See Pre-argument/Conference Attorney, Office of the
Shared courtrooms, 2-5, 4-11, 4-16, 4-20
Signage, 1-6, 2-15, 3-7, 4-4, 13-2, 13-3
Site, 2-2, 2-3, 2-5, 2-6, 2-9, 2-13, 2-14, 4-8, 9-6, 14-4, 16-2, 16-4, 16-7, 16-8, 17-7, 17-8
Skylights, 2-6, 4-5
Smart table
 See counsel table

Soundlock

See Chapter 4, “Courtrooms and Associated Spaces”

Space Requirements

Appellate Courtrooms, 4-9

Bankruptcy Judge Courtrooms, 4-22

Clerk’s Office, 8-6

Common Building Spaces, 11-6

Court Libraries, 7-7

District Judge Courtrooms, 4-12

Judges’ Chambers Suites, 6-6

Jury Facilities, 5-2

Jury Facility, 5-6

Magistrate Judge Courtrooms, 4-17

Other Court Units, 10-5

Probation and Pretrial Services, 9-8

Special Facilities, 12-9

Spectator area, 2-12, 4-4, 4-5, 4-13, 4-17, 15-5, 15-12, 16-7

Speech intelligibility

See Chapter 14, “Acoustics”

Stacking

See Program Tacking

Staff Attorney, Office of the Senior

See Judiciary-related offices

Staff Breakroom, 8-4, 8-6, 8-8, 9-4, 9-7, 9-8, 9-9, 10-3, 10-6, 10-7, 10-8

Staff lounges

See Staff Breakroom

Staff Toilets

See Toilets

STI, 14-3, 14-6, 14-7

Storage

See tables throughout the Design Guide

Structure, 2-2, 2-4, 2-5, 2-6, 2-9, 2-14, 11-6, 12-3, 12-4, 12-10, 13-2, 14-2, 14-10, 15-4, 16-5, 17-8, 18-8

Supporting Documents

Acoustics, 14-2

Building Security, 16-2

Building Systems, 15-2

Clerks’ Offices, 8-2

Court Libraries, 7-2

Courtrooms, 4-2

Judges’ Chambers Suites, 6-2

Other Court Units, 10-2

Planning for U.S. Courthouses, 3-4

Probation and Pretrial Services, 9-2

Shared Support Spaces, 11-2

Tenant Improvements and Furnishings, 12-2

Support Space, 2-3, 2-5, 2-6, 2-12, 3-4, 3-8, 3-10, 6-6, 7-9, 9-4, 9-9, 11-1, 11-2, 12-2, 15-2, 15-8, 16-2, 16-3, 16-4, 16-7

Supreme Court, 1-4, 1-5

T

Temperature

See Chapter 15, “Building Systems”

Tenant alterations, above standard, 18-4

Tenant Improvements, 1-6, 2-4, 2-5, 2-13, 2-14, 4-4, 9-6, 12-2, 12-3, 12-10, 16-7, 17-4, 17-6, 18-2, 18-9

Toilets, 2-6, 3-8, 4-9, 4-11, 4-12, 4-15, 4-17, 4-18, 4-22, 5-6, 6-8, 8-4, 8-6, 8-8, 9-4, 9-7, 9-8, 10-3, 10-4, 12-6, 14-8, 14-9, 15-14

Training, 2-5, 4-4, 4-8, 5-3, 7-9, 8-3, 8-4, 8-6, 8-8, 9-4, 9-7, 10-3, 11-4, 15-2, 15-11, 17-4, 18-5, 18-6, 18-7, 18-8, 18-9, 18-11, 18-22

Trial deliberation room

See Chapter 5, “Jury Facilities”

U

Uninterrupted power supply

See Chapter 15, “Building Systems”

Unstaffed library

See Chapter 7, “Central Court Libraries”

urinalysis facilities, 9-6

U.S. Attorney Grand Jury Suite, 5-4, 5-5, 5-7

U.S. Attorney, Office of the, 2-5, 3-2, 3-6, 10-4, 10-8

U.S. Bankruptcy Court (USBC), 1-2, 1-9, 3-6, 3-14, 4-2, 4-23, 5-3, 6-4, 8-4, 10-4, 16-8

U.S. Court of Appeals (USCA), 1-2, 1-7, 3-5, 3-12, 4-2, 6-4, 7-4, 8-4, 16-8

U.S. District Court (USDC), 1-2, 1-8, 2-12, 3-6, 3-13, 4-2, 4-14, 5-3, 6-4, 8-4, 10-4, 16-8

Users and Capacities

- Appellate Courtrooms, 4-8
- Bankruptcy Judge Courtrooms, 4-20
- Clerk's Office, 8-4
- Court Libraries, 7-5
- District Judge Courtrooms, 4-11
- General Requirements for all Courtrooms, 4-4
- Judges' Chambers Suites, 6-4
- Jury Facilities, 5-5
- Magistrate Judge Courtrooms, 4-15
- Other Court Units, 10-4
- Planning for U.S. Courthouses, 3-6
- Probation and Pretrial Services Offices, 9-5
- Shared Support Spaces, 11-5
- U.S. Marshals, deputy
 - See* Chapter 16, "Building Security"
- U.S. Marshals Service
 - See* Chapter 16, "Building Security"
- U.S. Probation Office
 - See* Chapter 9, "Probation and Pretrial Offices"

V

- Value engineering, 2-4, 2-6, 2-7
- Vault
 - See* tables throughout the Design Guide
- VAV
 - See* Chapter 15, "Building Systems"
- Vehicle barriers
 - See* Chapter 16, "Building Security"
- Vehicle entry
 - See* Chapter 16, "Building Security"
- Video
 - See* Chapter 15, "Building Systems"
- Visually impaired
 - See* Barrier-free access

W

- Weapons, 4-4, 9-4, 9-5, 9-7, 9-9, 16-2, 16-5, 16-6, 16-7, 16-9
- Wide area network (WAN), 15-16
- Witness box
 - Courtroom, 2-15, 4-11, 4-12, 4-15, 4-16, 4-20, 4-21, 12-11, 15-9, 15-14
 - Grand jury room, 15-17

Z

- Zoning
 - See* Courthouse Zoning; *See* Mechanical systems and Chapter 15, "Building Systems"

