

NASA/TM-2016-219345

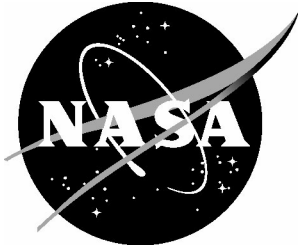

# Design Requirements for Unmanned Rotorcraft used in Low-Risk Concepts of Operation

*Kelly J. Hayhurst, Jeffrey M. Maddalon, and Natasha A. Neogi  
Langley Research Center, Hampton, Virginia*

*Harry A. Verstynen  
Whirlwind Engineering LLC, Poquoson, Virginia*

October 2016

## NASA STI Program . . . in Profile

Since its founding, NASA has been dedicated to the advancement of aeronautics and space science. The NASA scientific and technical information (STI) program plays a key part in helping NASA maintain this important role.

The NASA STI program operates under the auspices of the Agency Chief Information Officer. It collects, organizes, provides for archiving, and disseminates NASA's STI. The NASA STI program provides access to the NASA Aeronautics and Space Database and its public interface, the NASA Technical Report Server, thus providing one of the largest collections of aeronautical and space science STI in the world. Results are published in both non-NASA channels and by NASA in the NASA STI Report Series, which includes the following report types:

- **TECHNICAL PUBLICATION.** Reports of completed research or a major significant phase of research that present the results of NASA programs and include extensive data or theoretical analysis. Includes compilations of significant scientific and technical data and information deemed to be of continuing reference value. NASA counterpart of peer-reviewed formal professional papers, but having less stringent limitations on manuscript length and extent of graphic presentations.
- **TECHNICAL MEMORANDUM.** Scientific and technical findings that are preliminary or of specialized interest, e.g., quick release reports, working papers, and bibliographies that contain minimal annotation. Does not contain extensive analysis.
- **CONTRACTOR REPORT.** Scientific and technical findings by NASA-sponsored contractors and grantees.

- **CONFERENCE PUBLICATION.** Collected papers from scientific and technical conferences, symposia, seminars, or other meetings sponsored or co-sponsored by NASA.
- **SPECIAL PUBLICATION.** Scientific, technical, or historical information from NASA programs, projects, and missions, often concerned with subjects having substantial public interest.
- **TECHNICAL TRANSLATION.** English-language translations of foreign scientific and technical material pertinent to NASA's mission.

Specialized services also include creating custom thesauri, building customized databases, and organizing and publishing research results.

For more information about the NASA STI program, see the following:

- Access the NASA STI program home page at <http://www.sti.nasa.gov>
- E-mail your question via the Internet to [help@sti.nasa.gov](mailto:help@sti.nasa.gov)
- Fax your question to the NASA STI Help Desk at 443-757-5803
- Phone the NASA STI Help Desk at 443-757-5802
- Write to:  
NASA STI Help Desk  
NASA Center for AeroSpace Information  
7115 Standard Drive  
Hanover, MD 21076-1320

NASA/TM-2016-219345

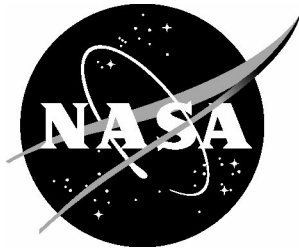

# Design Requirements for Unmanned Rotorcraft used in Low-Risk Concepts of Operation

*Kelly J. Hayhurst, Jeffrey M. Maddalon, and Natasha A. Neogi  
Langley Research Center, Hampton, Virginia*

*Harry A. Verstynen  
Whirlwind Engineering LLC, Poquoson, Virginia*

National Aeronautics and  
Space Administration

Langley Research Center  
Hampton, Virginia 23681-2199

October 2015

Disclaimer: Trade names or trademarks used in the report are for identification only. This usage does not constitute an official endorsement, either expressed or implied, by NASA.

Available from:

NASA Center for AeroSpace Information  
7115 Standard Drive  
Hanover, MD 21076-1320  
443-757-5802

## **Acknowledgement**

The research described in this report was conducted as part of NASA's Unmanned Aircraft Systems Integration in the National Airspace Systems Project. This work is supported by space act agreements between NASA Langley Research Center and Dragonfly Pictures, Inc. (SAA1-17902) and the University of North Dakota (SAA1-17878).



## Table of Contents

1.	Introduction.....	1
2.	Scope.....	2
3.	First Research Study on Unmanned Precision Agriculture .....	3
3.1.	Overview of the ConOps for Precision Aerial Application .....	4
3.2.	Results of the First Research Study .....	5
3.3.	Low-Risk Extensions .....	6
3.4.	Similar ConOps.....	7
4.	Second Research Study on Unmanned Cargo Delivery .....	8
4.1.	Overview of the ConOps for Cargo Delivery .....	8
4.2.	Results of the Second Research Study.....	10
5.	Lessons Learned .....	12
5.1.	Lesson Learned about Hull Loss.....	12
5.2.	Lesson Learned about the Safety Role for the Pilot and Crew .....	13
5.3.	Lesson Learned about Communication Systems and Equipment .....	14
5.4.	Lesson Learned about Vehicle Weight .....	15
5.5.	Lesson Learned about Access to the Operational Volume .....	15
5.6.	Lesson Learned about Operational Altitude.....	16
6.	Summary.....	16
7.	References.....	18
	Appendix A: Concept of Operations for Unmanned Cargo Delivery through Uninhabited Corridors .....	20
A1.	Characteristics and Assumptions .....	21
A2.	Example Use Case.....	23
A3.	Flight Operations.....	24
A3.1	Takeoff and Climb .....	24
A3.2	En route Operations .....	24
A3.3	Descent and Landing .....	24
A4.	Systems Description.....	24
A4.1	Unmanned Aircraft .....	25
A4.2	Ground Control Station (GCS) .....	26
A4.3	Command and Control (C2) Equipment.....	26
A4.4	Auxiliary Systems and Equipment .....	26
A4.5	Payload-Related Equipment .....	27
	Appendix B: Suggested Design Requirements Supporting Unmanned Cargo Delivery .....	28
	Appendix C: Assessment of FAR Part 27 Requirements for Unmanned Cargo Delivery .....	44

## Acronyms and Abbreviations

ALTREV	Altitude reservation
ATC	Air Traffic Control
BVLOS	Beyond Visual Line-of-Sight
C2	Command and Control
CMS	Controllability, Maneuverability, and Stability
ConOps	Concept of Operations
EASA	European Aviation Safety Agency
FAA	Federal Aviation Administration
FARs	Federal Aviation Regulations
FCC	Federal Communications Commission
ft	feet
GA	General Aviation
GBDAA	Ground-Based Detection and Avoidance System
GCS	Ground Control Station
GPS	Global Positioning System
HIRF	High Intensity Radiated Fields
IFR	Instrument Flight Rules
JARUS	Joint Authorities for Rulemaking on Unmanned Systems
lb	pound
mph	miles per hour
NASA	National Aeronautics and Space Administration
NOTAM	Notice to Airmen
OSHA	Occupational Safety and Health Administration
PPS	Powerplant and Supporting Systems
RLOS	Radio Line-of-Sight
SI	Structural Integrity
SWAP	Size, Weight, and Power
UA	Unmanned Aircraft
UAS	Unmanned Aircraft System
US	United States
VFR	Visual Flight Rules
VHF	Very High Frequency
VLOS	Visual Line-of-Sight
V <sub>NE</sub>	Never Exceed Speed



## Executive Summary

This technical report presents the results of the second of two research studies on design and performance requirements supporting airworthiness certification of midrange unmanned aircraft systems (UAS) intended for commercial use. The two studies focused attention on UAS in the middle of the multi-dimensional spectrum of UAS; that is, UAS with attributes and capabilities exceeding the criteria to operate under Part 107 of the Federal Aviation Regulations (FARs), but without the design or operational capabilities to comply with the airworthiness standards for commercially-operated manned aircraft. The goal of the two studies was to help address the gap in airworthiness standards for some UAS that fall between the extremes.

Both studies investigated the effect of a concept of operations (ConOps) on design requirements for midrange UAS that will need some degree of airworthiness certification. The first study focused attention on a ConOps for precision agriculture (precise spot treatment) using a midrange unmanned rotorcraft with maximum takeoff weight of 1000 lb. This report provides a brief summary of the first research study and its extensions (see pp. 3-8); a complete description of the first study, including the ConOps and design requirements, is provided in [9]. The second study investigated the extent to which the design requirements from the first study might change when the same unmanned rotorcraft is used for cargo delivery instead of precision agriculture.

The second study started with the production of the ConOps for cargo delivery through uninhabited corridors (see Appendix A). Next, a functional and operational hazard assessment was conducted using that ConOps to produce a list of hazards relevant to airworthiness (see Section 4.2). Minimum design and performance requirements necessary to mitigate the cargo delivery hazards were then derived from a detailed analysis of FAR Part 27 (Airworthiness Standards: Normal Category Aircraft) and the set of UAS design requirements produced under the first study. The difference between the set of UAS design requirements for the precision agriculture ConOps and the cargo delivery ConOps is quite small: only 17 total changes (see pp. 12). Changes in the design requirements were needed to account for (1) conveying cargo, (2) operating beyond visual line-of-sight, and (3) operating at a higher altitude and speed than needed for agricultural operations. These changes most notably affect requirements related to vehicle loads and to systems and equipment supporting the safety roles for the pilot and crew.

### Findings and Results

The second study produced two main products in addition to the ConOps: (1) a set of design and performance requirements for midrange unmanned rotorcraft performing cargo delivery in an uninhabited corridor, and (2) lessons learned about the impact of operational context on design criteria for midrange UAS.

The design and performance criteria for unmanned cargo delivery comprise 86 requirements. Of FAR Part 27's original 260 requirements, 77 were adopted as written or with some modification and 103 were excluded. Of the remaining 130 requirements, 80 had their intent abstracted or "rolled up" into four, less prescriptive requirements addressing (1) controllability, maneuverability and stability; (2) structural integrity; and (3) powerplant and supporting systems. For each of these topics, related requirements from Part 27 were aggregated and replaced with more abstract requirements appropriate for a UAS. The rolled-up requirements change the principal aim of the requirements from preventing hull loss to preserving the rotor system and preventing explosion to avoid the possibility of releasing high energy parts that could injure people. For any particular design, an applicant and the regulator would need to refine the abstracted requirements into specific, concrete requirements for the UAS presented for certification.

Five suggested requirements for new and novel technology not covered in Part 27 are also included in the design requirements. The requirements for novel technology address hazards related to (1) containing the vehicle to a defined operational volume, (2) detecting and avoiding other aircraft, (3) detecting and avoiding ground-based obstacles, (4) command and control links, and (5) systems and equipment needed

to support the safety role of the pilot and crew. Requirements for the first four topics were originally developed in the first study and refined in the second study. Requirements for the fifth topic were produced as part of the second study in response to increased likelihood and severity of hazards related to situational awareness. Because there is little UAS-specific data available yet on these five topics, all of the suggested requirements are deliberately general in nature and written without prescribing a particular implementation.

Documentation of the design and performance requirements is in the appendices. Appendix B provides the proposed list of design and performance requirements for a midrange unmanned rotorcraft operating in compliance with the cargo delivery ConOps. UAS developers and integrators interested in detailed design criteria may benefit most from that list. Appendix C contains the assessment of each one of the Part 27 requirements, including an indication of whether that paragraph is included in the set of design requirements (as is, modified, or rolled up), or whether the paragraph is deemed unnecessary and excluded. A brief rationale is included for each paragraph to explain the assessment. The assessment in Appendix C may be of interest to regulators, researchers, or others interested in application of existing standards to UAS.

The results of the two research studies taken together provided a number of lessons learned (see Section 5) that may be useful in establishing airworthiness standards for UAS.

- (1) Operating environments can have a substantial effect on the likelihood and severity of hazards and, hence, on the design and performance requirements for UAS, more so than for conventional aircraft. Therefore, critical characteristics of the operation and operational environment must be considered in determining appropriate design criteria for UAS.
- (2) For some civil operations, hull loss may not be a safety concern, provided that sufficient systems and equipment assure that the UA remains within an operational area that precludes harm to people and unacceptable harm to property.
- (3) For many concepts of operations, especially where hull loss is not a concern, vehicle weight has a minimal influence on design and performance requirements.
- (4) A clearly defined safety role for the pilot and crew is essential to determining the systems and equipment needed for ensuring safety of flight. The roles and corresponding equipment may differ substantially across different types of UAS and operations.
- (5) Airworthiness requirements for communications links are impacted by (a) the means by which the communications link is implemented and (b) the location and nature of the parties communicating.
- (6) For UAS operations confined to an uninhabited operational volume, the ability to control access to that volume by parties not connected to the operation significantly impacts the airworthiness requirements.
- (7) Increasing operational altitude increases the likelihood and severity of hazards associated with the ejection of high-energy parts and hazards associated with loss of separation from other aircraft.

These lessons learned indicate the effects that different types of UAS operations and environments can have on design and performance requirements for airworthiness. Moreover, the two studies demonstrate the importance of exploring a wide range of ConOps to better understand what is essential to regulating UAS to ensure safe operations, and what barriers remain for integration of UAS into the airspace system.

## 1. Introduction

Regulations governing the design, production, operation, and crew for commercial unmanned aircraft systems (UAS) are essential to growth of that nascent industry. In August 2016, the first UAS regulations in the United States (US) officially went into effect. These regulations are formally known as Part 107 of the Federal Aviation Regulations (FARs) [1]. Part 107 enables a suite of commercial uses for small UAS weighing less than 55 lb, operating in visual line-of-sight (VLOS), operating under 400 ft above ground level or within 400 ft of a structure, and restricted from operating over any persons not directly involved in the operation. According to the Federal Aviation Administration (FAA), more than 600,000 drones will be flying in the first year after the rule is in place [2]. To continue expansion of the UAS industry, additional regulatory actions are needed for UAS flights with larger, more capable UAS operating in non-segregated airspace and beyond visual line-of-sight (BVLOS) of a remote pilot. Exemptions or waivers from the current regulations may be used as an interim means to facilitate expansion until new UAS-specific standards and regulations can be developed [3]. This report focuses attention on research to support development of new standards for airworthiness certification of UAS that do not meet the criteria of Part 107.

Airworthiness can be generally thought of as the suitability for safe flight of an aircraft. In civil aviation regulations, a conventional aircraft (i.e., one with an onboard pilot) is considered airworthy if the aircraft is compliant with relevant technical requirements governing its design and manufacture and is in a condition for safe flight. Airworthiness standards cover all aspects of the design, manufacture, and maintenance of the aircraft, including its structure, engines, and systems and equipment. Compliance with those standards has been an accepted means of mitigating the risk to people and property (both in the aircraft and on the ground) from inadequate vehicle design or maintenance. While an airworthiness certificate is required for operation of most conventional aircraft, airworthiness certificates are not required for all commercial UAS.

Part 107, for example, allows many types of commercial UAS operations without requiring airworthiness certification [1]. In lieu of airworthiness certification, Part 107 imposes substantial operational limitations to mitigate risk to people and property. In cases where the operational limitations of Part 107 are not sufficient to mitigate risk, some degree of airworthiness certification may be required. For many UAS, the degree of airworthiness certification needed will be tied to their operation and operational environment. The need for operation-centric requirements based on “the level of risks inherent to the category of operation” has only recently been recognized [4]. No such requirements currently exist. Lack of regulations for unmanned systems is often cited as the biggest barrier to commercial deployment [5-7].

This report summarizes final results of two research studies investigating airworthiness requirements for UAS operating in low-risk environments, wherein risk to people or high-value assets is limited by inherent characteristics of the environment, such as remoteness, lack of inhabitants, etc. The goal of the research was to help fill the void in operation-centric airworthiness requirements. This work directly supports the FAA’s incremental approach to gaining airworthiness approvals by “developing design standards tailored to a specific UAS application and proposed operating environment” [8] and the European Aviation Safety Agency’s (EASA’s) efforts to regulate UAS via a classification scheme heavily influenced by operational characteristics [4].

This report is organized as follows. Section 2 describes the constraints used to narrow the scope of the two studies. Section 3 provides a brief summary of the first research study, described in more detail in [9]. The first study comprised the development of a concept of operations (ConOps) and draft set of design and performance requirements for an unmanned tandem rotorcraft used for precision aerial application (i.e., spot treatment of crops). The second research study was designed to examine the extent to which the design requirements from the first study might change when the same unmanned rotorcraft is used in a different ConOps. Section 4 describes a ConOps for transporting cargo through uninhabited corridors and the impact that change in operation has on suggested UAS design and performance

requirements. Lessons learned from the two research studies are presented in Section 5 and a brief summary is given in Section 6. Lastly, the appendices contain documentation of the ConOps and design and performance requirements for the unmanned cargo delivery study. The ConOps for unmanned cargo delivery is described in detail in Appendix A. The corresponding set of suggested design and performance requirements for an unmanned rotorcraft operating in compliance with that ConOps is given in Appendix B. Appendix C contains the results and rationale used to determine the set of design requirements given in Appendix B.

## 2. Scope

There are many dimensions that contribute to the extraordinary diversity of unmanned aircraft (UA) types and operations; for example, size (micro to large), speed (hovering to hypersonic), and endurance (minutes to weeks). Across this multi-dimensional spectrum, there are tradeoffs between the use of airworthiness certification requirements and operational limitations to reach a desired level of safety. The safety of some UAS operations, especially those that pose little risk to people and property, may be managed with only operational limitations; that is, compliance with airworthiness standards is not necessary. Other UAS operations that pose more substantial risk to people and property will likely be managed by some combination of design and performance requirements for airworthiness, in addition to operational limitations. The degree to which operational limitations and airworthiness-related requirements are stipulated depends on the hazards associated with the operation to be performed and the operational environment. That is, to assign appropriate airworthiness requirements, the UAS type cannot be separated from its operational context. Specifying airworthiness requirements for the breadth of UAS types and their potential operations is very challenging. Consequently, a number of constraints were imposed to focus the research studies reported here.

The first constraint limited the studies to UAS used for civil operation versus public use. Under the FARs, aircraft operated for civil use are treated different from those operated for public use. Civil use refers to aircraft operation by a private individual or company, such as for recreational or commercial purposes. The FAA is responsible for ensuring that aircraft for civil use are airworthy or officially exempted from airworthiness requirements. Public use refers to aircraft that are operated for governmental purposes, such as military operations, border patrol, law enforcement, or scientific research. The government agency that is conducting a public use operation must provide its own assurance (or self-certification) that its aircraft is airworthy.

A second constraint limited the studies to UAS that are obligated to meet *some* design and performance requirements, but could not meet *all* of the airworthiness standards established for conventional aircraft. For instance, UAS operating in compliance with Part 107 were not considered in the studies because they are exempt from airworthiness certification. Large UAS intended for civil use within the same airspace as conventional aircraft (i.e., full participants in the airspace) also were not considered because they will not likely receive any significant relief from existing airworthiness regulations. In between these two extremes are *midrange* UAS that have physical attributes or operational needs beyond those allowed under Part 107, but lack the design and operational capabilities to be full participants in the airspace. Today's midrange UAS face challenges to complying with existing airworthiness standards since they are often built using commercial off-the-shelf or hobbyist-grade components for size, weight, power, and cost reasons. Hence, the research studies focused on midrange UAS that must operate under some operational limitations.

A third constraint limited the studies to UAS that are remotely piloted, as opposed to autonomous aircraft. The International Civil Aviation Organization (ICAO) only considers remotely-piloted aircraft as suitable for standardized international civil operations at this time [10]. ICAO's current policy is binary in nature, and solely discriminates based on whether a human can interact with the UA during the operation. The

research studies reported here only include UAS that allow pilot intervention in the management of the flight. In particular, the pilot-in-command must have a defined safety role.

With a fourth constraint, the studies focused on missions or operations that take place in low-risk environments. In such environments, harm to people or high-value assets from direct impact or collateral damage is considered improbable, though not impossible. Examples include operations over large tracts of farmland or backcountry, where people are not typically expected. Low-risk operations were chosen to enlarge the set of achievable commercial operations beyond those possible under in Part 107, by extending only a few dimensions in the UAS trade space at a time. For example, the studies assume operations with a UA in the 1000-lb weight range, operating at times BVLOS (exceeding Part 107 criteria), but with no intentional overflight of third parties and constraints to minimize risk to other aircraft. The core concept was to take a reasonable, incremental step beyond Part 107 toward standards for operations with increased safety risk.

The final constraint limited the studies to the determination of high level design and performance requirements at the level of typical airworthiness standards (e.g., FAR Part 27, Airworthiness Standards: Normal Category Rotorcraft) [11]. This level of requirements is used when establishing a type certification basis for an aircraft in a traditional certification program. This is an initial step among many needed to obtain an actual airworthiness certificate. Investigation of suitable integrity requirements along with reliability and design assurance requirements was beyond the scope of the study.

Both research studies examined the same representative UAS platform (an unmanned rotorcraft with maximum takeoff weight of 1000 lb), but in different ConOps. Each study started with a functional and operational hazard assessment to derive the primary hazards to be mitigated via design criteria. Next, a set of high level design requirements sufficient to mitigate those hazards was developed based on existing airworthiness standards for normal rotorcraft in FAR Part 27 and the UAS-tailored version of Part 27 from the Joint Authorities for Rulemaking on Unmanned Systems (JARUS) [12]. Finally, additional high-level requirements were suggested for hazards not managed by existing standards, such as those related to systems and equipment unique to UAS. Figure 1 shows the primary research tasks used in investigating design and performance requirements.

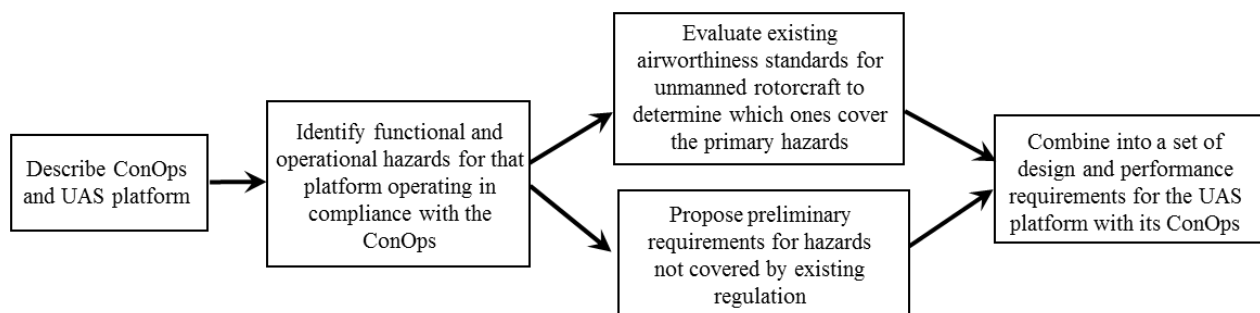

Figure 1. Overview of Research Tasks

An overview of each research study and its results is provided in the following two sections.

### 3. First Research Study on Unmanned Precision Agriculture

The first research study investigated some of the airworthiness requirements needed to support UAS operations that take place in environments with a low safety risk, such as precision agriculture. The specific objective of the study was to propose design criteria for a midrange unmanned rotorcraft (about

1000-lb maximum takeoff weight) used for commercial precision aerial application (i.e., spot treatment) of agricultural inputs (e.g., fertilizers and pesticides). Precision aerial application was selected for the operational concept because of the low-risk nature of the operation and a well-documented interest in using UAS for agricultural work [13]. A midrange platform was selected because it would enable the application of a sufficient amount of agricultural input necessary for the economic viability of the operation, but would exceed the provisions of Part 107 and exemptions under Section 333. Type certification was assumed to be necessary.

Midrange UAS represent a class of UAS that rely to some degree on commercial-off-the-shelf components instead of aviation-grade components to meet size, weight, power, and cost constraints. The project used the Dragonfly Pictures, Inc. DP-14 model unmanned model rotorcraft as its representative platform (shown in Figure 2). The DP-14 weighs approximately 1000 lb, has a payload capacity of 430 lb, and has an endurance of approximately 2.4 hours. The DP-14 is operated remotely from a ground control station (GCS).



Figure 2. Dragonfly Pictures' DP-14 Model UAS Configured for Precision Aerial Application

### 3.1. Overview of the ConOps for Precision Aerial Application

The ConOps for precision aerial application focuses on spot treatment of crops in fields up to 160 acres, or quarter sections, in rural, sparsely populated areas. The general concept is to have an unmanned rotorcraft apply agricultural inputs to relatively small areas in a field of crops (see Figure 3).

Treatment needs may be determined by any number of means including satellite (e.g., Landsat) imagery, aerial imaging (from manned or unmanned aircraft), or ground data collection. This concept is compatible with established precision agriculture principles: applying the right chemical in the right amount to the right place at the right time [14]. Such an operation might be undertaken to eradicate a fungal, weed, or pest infestation before it encompasses an entire field, or correct a nutrient imbalance before permanent damage occurs to the crop. In this ConOps, flights are generally confined to a designated operational boundary around the field (Figure 3, yellow lines) and are prohibited from exceeding an absolute containment boundary just beyond the operational boundary (Figure 3, red lines). The containment volume includes an altitude limit of 400 ft. Operational procedures and supporting systems and equipment are used to ensure that no one is in the field during operations. Therefore, crashing an unmanned vehicle within the containment boundary is generally an economic concern, instead of a safety or regulatory concern.





Figure 3. Concept of Operations for Precision Aerial Application with an Unmanned Aircraft

The containment boundary was established to mitigate the risk of fly-away events that could result in the vehicle entering an area in which it is not permitted to operate, or behaving in a manner that is hazardous to other aircraft or persons on the ground. An assured means of containing the operation to a well-defined volume, restricted in altitude and inhabitants, is key to limiting risk to other aircraft and to people and property in proximity to the operation. The reliability and dependability of most current geofencing systems, especially those embedded in an autopilot, are likely insufficient to meet the safety requirements for this ConOps [15, 16]. A detailed description of the ConOps is provided in [9].

### 3.2. Results of the First Research Study

In the precision agriculture ConOps, sufficient systems, equipment, and procedures must be in place to keep nonparticipants outside of the operational volume, keep the vehicle within the volume, and ensure ground impact hazards are mitigated. If that can be done, then many of the airworthiness regulations for conventional aircraft, necessary to protect the physical aircraft (as a proxy for protecting the people onboard), may not be necessary for an unmanned rotorcraft used in compliance with the precision agriculture ConOps. Therein lies the potential for reducing the effort needed to certify UAS built for operations similar to the precision agriculture ConOps.

Table 1 lists the primary hazards identified for unmanned precision aerial application that may result in an undesirable situation (e.g., death, injury, etc.) to first, second, or third parties. Only those hazards whose consequence was considered major or worse (hazardous or catastrophic) were included in the list. These hazards drive the safety-oriented airworthiness requirements. Once the hazards were identified, design requirements were developed to mitigate them. To identify those requirements, two sets of design criteria for rotorcraft were evaluated for applicability to the hazards in Table 1: (1) Part 27 of the FARs (i.e., airworthiness standards for normal category rotorcraft) and (2) the UAS-tailored version of Part 27 from JARUS [11, 12]. Part 27 contains 260 numbered design and performance requirements for rotorcraft. Of those, only 11 were considered applicable as written in Part 27; 119 were considered not applicable; and, 56 were considered applicable with slight modification. The remaining 74 requirements were abstracted or “rolled up” into four less prescriptive requirements suitable for UAS—two for controllability, stability, maneuverability, one for structural integrity, and one for powerplant and supporting systems.

Novel design requirements were also formulated to mitigate hazards not covered in Part 27. The new requirements address (1) vehicle containment within authorized boundaries, (2) detecting and avoiding other aircraft, (3) detecting and avoiding ground-based obstacles, and (4) safety-critical command and control (C2) links. The full set of requirements is presented in [9] as a mock type certification basis for the DP-14. The mock type certification basis was documented using the FAA’s issue paper format, to provide an example of the form of artifacts typical to aircraft certification [17].

Table 1. Primary Hazards for Unmanned Precision Agriculture Spraying

<b>Hazards affecting the crew’s ability to perform their safety role</b>	<b>Hazards that pose harm to any person</b>	<b>Hazards that affect aircraft safety margins and functional capabilities</b>
<ul style="list-style-type: none"> <li>• Loss of command and control (C2) link used for contingency management (e.g., flight termination)</li> <li>• Loss of or degraded electrical power in the ground control station for contingency and emergency functions</li> <li>• Loss of or degraded electrical power subsystems on the UA for contingency and emergency functions</li> <li>• Loss or degradation of ground control station capability (e.g., loss of displays) required for contingency and emergency functions</li> <li>• Loss of pilot situational awareness</li> <li>• Loss of or degraded communication between pilot and crew</li> </ul>	<ul style="list-style-type: none"> <li>• Loss of or inadequate structural integrity, especially of the rotor system (that could lead to release of high energy parts)</li> <li>• Failure to detect, alert or warn, and avoid intruder aircraft</li> <li>• Failure to detect, alert or warn, and avoid dynamic or other obstacles on the ground (including people or high-valued assets)</li> <li>• Explosion in the powerplant or fuel system</li> </ul>	<ul style="list-style-type: none"> <li>• Failure to recognize and avoid adverse environmental conditions</li> <li>• Failure to stay within authorized operational area</li> <li>• Failure to maintain adequate controllability, maneuverability, and stability</li> <li>• Loss of UAS position and anti-collision lights (loss of means to be seen by other aircraft and observers)</li> <li>• Interference of spray system with required UAS function</li> </ul>

### 3.3. Low-Risk Extensions

The mock type certification basis described above was created to be specific to the attributes of the DP-14. As such, the mock type certification basis did not include some of the requirements in Part 27 that address common rotorcraft attributes. To extend the applicability of the first study, the Part 27 requirements were re-evaluated for unmanned rotorcraft with the following attributes not found on the DP-14.

- single rotor
- reciprocating engine
- systems and equipment for flight in icing conditions
- multiple engines
- landing gear with skids, skis, or floats

Based on the re-evaluation, the original set of requirements in the mock type certification basis was extended to cover unmanned rotorcraft having these attributes as well as those of the DP-14. That is, the set of design requirements were extended to be applicable to a broader range of rotorcraft types. Table 2 describes the changes made to the original mock type certification basis for these extensions. For example, the text of §27.411 and §27.427 from Part 27 was modified in the original mock type certification basis because the DP-14 does not have a single rotor. Those requirements were included as originally written in Part 27 in the extended design set that includes rotorcraft with a single rotor.



Overall, only eight changes were needed to extend the original mock type certification basis to serve a broader range of unmanned rotorcraft that might be used for ConOps similar to precision agriculture. The extensions did not change the fact that many of the Part 27 requirements are not suitable without significant modification for an unmanned rotorcraft used in low-risk environments. The changes made for the low-risk extensions are reflected in the design requirements produced in the second study.

Table 2. Design Requirements Affected by Rotorcraft Attribute

<b>Requirements Affected by Change in the ConOps</b>	<b>Assessment of the Requirement for the Original ConOps</b>	<b>Assessment of the Requirement for Low-risk Extension</b>
Requirements related to Single Rotors §27.411 Ground clearance: tail rotor guard §27.427 Unsymmetrical loads	Modified	As is (i.e., reverted to original Part 27 text)
Requirements related to Reciprocating Engines §27.1557 Miscellaneous markings and placards	Modified	Further Modified
Requirements Related to Multiengines §27.1309 Equipment, systems, and installations §27.1321 Arrangement and visibility	Modified	Further Modified
Requirements Related to Icing §27.1325 Static pressure systems	Modified	Further Modified
§27.1419 Ice protection	Excluded	Rolled Up
Requirements related to Skis/Skids/Floats §27.1399 Riding light	Excluded	Modified

### 3.4. Similar ConOps

Although the operational context for the first study was specific to precision agriculture, a number of potential commercial applications share similar operational characteristics and, most importantly, similar hazards. Those applications may be able to use the same design and performance requirements as a starting point for setting type certification criteria. The following operational characteristics were most influential in the evaluation of hazards and design requirements. These characteristics can help group together ConOps with similar operational risks.

- Contained: Flight is contained with a high degree of certainty within a pre-defined, bounded volume of airspace.
- Unpopulated: The operational volume is uninhabited. No people are expected within the operational volume.
- Access controlled: Operational procedures and controls are implemented for keeping people out of the operational volume of airspace while the UA is in flight.
- Low altitude: Maximum flight altitude is less than 500 ft, with limited expected air traffic.
- Permission granted for overflight: Flight operations have explicit authorization from the property owner.
- Population density in proximity: The population density just beyond the operational volume is sparse.

- Pilot visual locality: VLOS<sup>1</sup>
- Pilot radio locality: Radio line-of-sight (RLOS)

Commercial applications that possibly share these operational characteristics include:

- Agriculture: non-precision treatment of crops (e.g., rice fields, cranberry bogs) including treatments such as spraying orange groves (or other produce) with water to produce ice coverings to protect the produce from freezing temperatures
- Aerial surveying or mapping for
  - future construction sites using specialized (heavy) survey equipment
  - inspection of large-scale infrastructure such as dams or bridges (temporarily closed for inspection) that may require heavy equipment or sensors
  - limited wilderness areas
  - limited herd management
- Cargo and heavy lift transport: on ranches or farms or confined industrial settings such as mining camps

Even though one application may seem similar to another, a clearly defined concept of operations is crucial to identifying hazards and developing suitable design and performance criteria for airworthiness certification of UAS. The operation and UAS must be considered in tandem in order to derive the relevant hazards to be mitigated.

## 4. Second Research Study on Unmanned Cargo Delivery

The second research study was designed to investigate the impact that changes to the ConOps could have on design and performance requirements for a midrange unmanned rotorcraft. That is, how much might the design requirements established in the first study change if the DP-14 is used for a different purpose? To answer that question, low-volume cargo delivery by unmanned rotorcraft through uninhabited corridors was selected as the ConOps for the second study. The motivating business case was to allow delivery of cargo (e.g., goods or supplies generally weighing less than 400 lb) in remote locations, when other means of transportation are not possible or practical. Urgent or sporadic use cases might include delivery of emergency supplies to remote ranches or lodges when local roads become impassable due to unexpected severe weather. More frequent use cases might include delivery of goods and emergency supplies to small villages or outposts, such as those in Alaska or Canada, that are not easily reached during winter months by conventional ground, water, or air transportation or during summer months due to the melting of ice roads.

The operational concept relies heavily on the general seclusion of the area within the corridor to ensure the absence of humans and critical infrastructure. Within that operational environment, the UAS would be allowed to crash (as it was in the precision agriculture ConOps), without safety impact (barring the release of high energy parts). The cargo delivery ConOps effectively extends both the range and altitude of the operational volume beyond that assumed in the precision agriculture ConOps, while limiting risk to people and property within the corridor.

### 4.1. Overview of the ConOps for Cargo Delivery

In this ConOps, a limited corridor consists of a pre-defined volume of airspace purposely situated over unpopulated areas (to avoid overflight of people) and designed to avoid critical ground assets (e.g., power

---

<sup>1</sup> The precision agriculture study examined four different scenarios: two in VLOS conditions and two where the pilot was in the same location, but visibility was obscured due to weather conditions (e.g. fog). The degree to which the pilot has VLOS throughout the operation affects the automation that must be onboard the UA.

lines). A corridor may be positioned over land or water, as long as access can be managed in some manner. Flights takeoff from pre-approved launch sites within the designated corridor, transit through the corridor over relatively short distances (< 60 statute miles) confined to Class G airspace, and arrive at an approved landing zone within the corridor to deliver or retrieve cargo. Figure 4 illustrates the general concept.

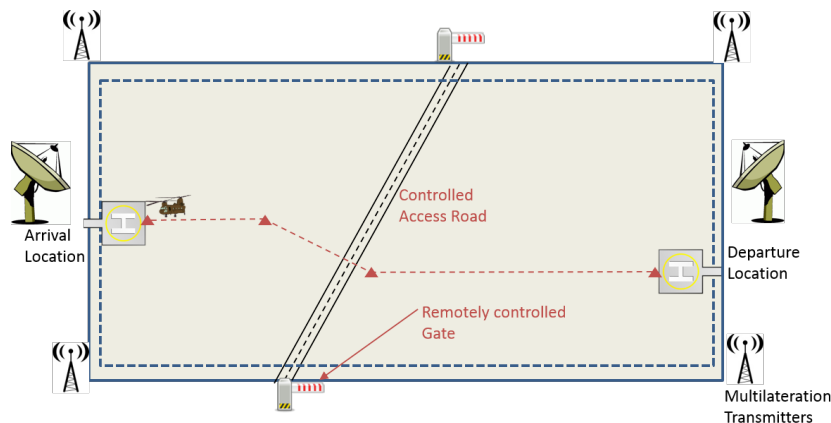

Figure 4. Illustration of a Limited Corridor for Unmanned Cargo Delivery

The essential attributes of a limited corridor include the following:

- The geographical area within the corridor is uninhabited; i.e., there is no recognized human presence within the corridor during the period of UA operations.
- Access to the corridor by humans is limited; e.g., by fences, warning signs, or gates at the boundaries, or by general inaccessibility to the area.
- The geographical area within the corridor does not include high-value assets such as dams, nuclear power plants, and environmentally sensitive areas. However, communal infrastructure, such as power lines and roads, may be included provided flight path planning minimizes the exposure of such assets.
- Hull loss (or crashing) within the corridor is not considered an aviation safety event, though it may have economic implications.
- Permission to operate within the corridor has been explicitly authorized. The geographical area within the corridor may be owned by the UAS operator, or the UAS operator may have overflight permission from the property owners.
- The boundaries of the corridor are geospatially fixed. The maximum altitude is determined by the upper boundary of Class G airspace or by the range limitations of supporting ground-based systems (e.g., datalinks, radars, and navigation systems), whichever is lower. The lower boundary is determined by terrain, obstructions, and line-of-sight limitations of supporting ground-based systems.

These corridor attributes are generally consistent with those from the precision agriculture ConOps. The primary differences between the precision agriculture and limited corridor ConOps are:

- The nominal flight altitude, ceiling, and vehicle speed for corridor operations are higher than for precision agriculture (where flights were typically slow and low, close to crop height, and limited to 400 ft).

- The ability to control access to the corridor is weaker for corridor operations than for precision agriculture because the range is substantially larger.
- The crew may not be in the same general vicinity for corridor operations, as they are in precision agriculture operations. For example, some crewmembers may be located at the takeoff site, while other crewmembers may be at the destination.
- There is more variability in payload considerations for corridor operations (e.g., both internal and external cargo) than for precision agriculture.

A detailed description of the cargo delivery ConOps is given in Appendix A. That description includes a case in point of cargo delivery through a limited corridor between Nuiqsut and Deadhorse, Alaska. A description of the DP-14 and required systems and equipment is also included.

## **4.2. Results of the Second Research Study**

The steps taken in the second study to identify reasonable design requirements proceeded in similar fashion as those in the original study. A functional and operational hazard assessment was conducted using the information in the cargo delivery ConOps and system description of the DP-14, along with hazard severity definitions tailored for UAS [9] and the hazard assessment from the first study. Hazards that could cause harm to people or property were identified, including UAS-specific hazards associated with the failure of aircraft functions and operational hazards associated with the cargo delivery operation and crew. Traditional aircraft hazards such as loss of control and loss of navigation were considered. Operational hazards related to the ConOps, such as loss of situational awareness (i.e., knowing what is happening with the UA especially when it is BVLOS), were also considered.

The goal of the hazard assessment was not a definitive assessment of severity for each hazard, but a broader evaluation of whether the potential consequences of a hazard necessitate a design or performance standard comparable to those in Part 27. Only those hazards whose consequence was considered major, hazardous, or catastrophic were included on the list of hazards that should be mitigated by design and performance requirements for airworthiness certification. The primary hazards for the cargo delivery ConOps, listed in Table 3, are essentially the same as those shown in Table 2 for the precision agriculture ConOps, with a few modifications. For example, interference from the spray system is a hazard in the precision agriculture ConOps. The comparable hazard for cargo delivery is interference or failure of cargo-carrying equipment, such as a hook used to carry sling loads. Also, loss of or inadequate data needed for the crew to perform their safety-critical functions was identified as a primary hazard for the cargo delivery ConOps, given that the vehicle is BVLOS for most of the flight.

As in the first study, design requirements were identified to mitigate the hazards in Table 3. Part 27 and the extended set of design requirements and rationale from the first study were used to produce the set of design and performance requirements for the cargo delivery ConOps. Because the hazards are similar for the precision agriculture and cargo delivery ConOps, most of the design requirements are also similar. There are some differences, however. Changes in the design requirements were obviously needed to safely convey cargo. Other changes can largely be attributed to differences between the two ConOps regarding operational range, altitude ceiling, and speed. In particular, operations clearly BVLOS and with an altitude ceiling extending several hundred feet above ground level likely need design and performance requirements for controllability, maneuverability and stability, airspeed, and situational awareness beyond those needed for ConOps where range is within VLOS, with a limited altitude ceiling.

Table 3. Primary Hazards for Unmanned Cargo Delivery through Uninhabited Corridors

<b>Hazards affecting the crew’s ability to perform their safety role</b>	<b>Hazards that pose harm to any person</b>	<b>Hazards that affect aircraft safety margins and functional capabilities</b>
<ul style="list-style-type: none"> <li>• Loss of C2 link used for contingency management (e.g., flight termination)</li> <li>• Loss of or degraded electrical power in the ground control station for contingency and emergency functions</li> <li>• Loss of or degraded electrical power subsystems on the UA for contingency and emergency functions</li> <li>• Loss or degradation of ground control station capability (e.g., loss of displays) required for contingency and emergency functions</li> <li>• Loss of or inadequate data for safety critical functions</li> <li>• Loss of pilot situational awareness</li> <li>• Loss of or degraded communication between pilot and crew</li> </ul>	<ul style="list-style-type: none"> <li>• Loss of or inadequate structural integrity in flight, especially of the rotor system (that could lead to release of high energy parts)</li> <li>• Failure to detect, alert or warn, and avoid intruder aircraft</li> <li>• Failure to detect, alert or warn, and avoid dynamic or other obstacles on the ground</li> <li>• Explosion in the powerplant or fuel system in flight (that could lead to release of high energy parts)</li> </ul>	<ul style="list-style-type: none"> <li>• Failure to recognize and avoid adverse environmental conditions</li> <li>• Failure to stay within authorized operational area (failure of flight containment function)</li> <li>• Failure to maintain adequate controllability, maneuverability, and stability (e.g., loss of vehicle attitude control)</li> <li>• Loss of UAS position and anti-collision lights (loss of means to be seen by other aircraft and crew)</li> <li>• Failure of cargo-carrying equipment or its interference with required UAS function.</li> </ul>

In total, only 15 of the Part 27 requirements were changed between the design set identified for unmanned precision agriculture and unmanned cargo delivery. Two noteworthy modifications were also made to the novel requirements—those not originating from Part 27. For example, additions were made to the novel requirement for the safety-critical C2 links to address relay mechanisms and additional performance concerns due to the extended range. An additional requirement was also created to address systems and equipment to support pilot and crew safety roles. This novel requirement was motivated by hazards affecting situational awareness. In the cargo delivery ConOps, the pilot and crew are dependent on data provided by the UA and other supporting equipment for knowledge of the UA’s status, much more so than for precision agriculture. Table 4 lists the significant differences between the set of design requirements developed for the precision agriculture study and the cargo delivery study.

In summary, of the 260 numbered regulations in Part 27, only 17 were included as written in the set of design and performance requirements for unmanned cargo delivery; 104 regulations were excluded outright; 59 were slightly modified; and 80 were rolled-up by intent into the 4 less prescriptive requirements for controllability/stability/maneuverability, structural integrity, and powerplant and supporting systems. The original 4 novel requirements from precision agriculture were also included, along with an additional novel requirement covering systems and equipment to support pilot and crew safety roles. Appendix B contains the complete list of design and performance requirements for the unmanned cargo delivery operation. Appendix C contains the assessment of each individual paragraph in Part 27, including rationale for the assessment.

Table 4. Changes in the Design Set between Precision Agriculture and Cargo Delivery

Requirements Affected by Change in the ConOps	Assessment of the Requirement for Unmanned Precision Agriculture	Assessment of the Requirement for Unmanned Cargo Delivery
§27.691 Autorotation control mechanism §27.917 Design (Rotor Drive System)	Modified	As is (i.e., reverted to original Part 27 text)
§27.1027 Transmission and gearboxes §27.1303 Flight and navigation instruments §27.1305 Powerplant limitations §27.1583 Operating limitations	Modified	Further Modified
§27.873 Ballast provisions §27.1503 Airspeed limitations: general	Excluded	As is (i.e., reverted to original Part 27 text)
§27.31 Removable ballast §27.787 Cargo and baggage compartments §27.855 Cargo and baggage compartments (fire protection) §27.865 External Loads §27.1327 Magnetic direction indicator §27.1505 Never-exceed speed	Excluded	Modified
§27.1545 Airspeed indicator	Excluded	Rolled-up
Safety-critical command and control links	Newly created	Modified
Systems and equipment to support pilot and crew safety roles	Not applicable	Newly created

## 5. Lessons Learned

The overarching lesson learned from the cargo delivery study is the same as from the precision agriculture study; namely that imposing current airworthiness standards on UAS is not straightforward. Differences in operating environments, even where risk is minimal, can affect design and performance requirements. In particular, this study showed that the increased distance traveled under BVLOS conditions and the higher altitude ceiling affected the degree of controllability, maneuverability, and stability needed to remain within its authorized operational volume, especially in contingency situations. Those factors also affected the system’s dependence on automated systems and equipment needed to provide sufficient data to the pilot and crew for situational awareness to perform their safety roles. The following subsections describe additional lessons learned in the course of investigating design requirements to support the airworthiness of unmanned rotorcraft used in low-risk operational environments.

### 5.1. Lesson Learned about Hull Loss

*For some civil operations, hull loss may not be a safety concern, provided that sufficient systems and equipment assure that the UA remains within an operational area that precludes harm to people and property.*

Most airworthiness standards for conventional aircraft are intended to ensure that hull loss or other aircraft-specific failures that could entail harm to onboard passengers and crew are extremely improbable. Since no humans will be aboard an unmanned aircraft in the foreseeable future, the loss of the UA does not necessarily equate to human injuries or loss of life. Whether or not a safety hazard exists is determined instead by whether the loss of the unmanned aircraft poses harm to persons or unacceptable

harm to property on the ground or in other aircraft. The application of this observation to defining airworthiness requirements for civilian UA that do not comply with the criteria of Part 107 is somewhat new. In cases where persons and property both in the air and on the ground can be protected from impact risks, hull loss may be considered acceptable from a safety perspective. In those cases, it is not necessary to expect unmanned aircraft to have the same levels of safety and reliability as conventional aircraft. This approach allows the focus of airworthiness certification to shift from the vehicle and associated systems to equipment and operational procedures that ensure that persons and property in the air and on the ground remain reliably separated from the UA under normal and contingency conditions.

In both studies, the safety of the UAS operations, even with a hull loss, was contingent on three conditions. First, the operation of the UA must stay within a well-defined volume of airspace that is over an unpopulated area (see section 5.5 for discussion of population). Second, the UA, like all aircraft must maintain separation from other airspace users (e.g., conventional airplanes or rotorcraft, other UA, and manned free balloons), because the operation cannot ensure that other aircraft will not enter the operational volume. Finally, people and property outside, but nearby, the operational area must not be harmed by the UA operation, even in contingency or failure scenarios. This includes situations where the aircraft's condition degrades such that high-energy parts could be ejected with sufficient force to exit the operational area. Certain control system, powerplant or structural failures in flight could result in release of high energy parts, as could impact with ground-based obstacles (e.g., trees, power lines, or silos.). Release of high energy parts upon ground impact can be mitigated by designing an appropriate buffer within the containment boundary.

Under these conditions, both research studies showed the potential for a significant reduction in airworthiness requirements for a midrange UA engaged in a civil application. Ensuring that the UA remained separated from persons and property in the air and on the ground required attention to:

- equipment and procedures that assure containment of the vehicle to a predefined operational area that is unpopulated,
- equipment and procedures that assure separation from other aircraft, and
- equipment and procedures that assure separation from high-value ground-based assets that could be harmed.

There are no airworthiness requirements in Part 27 that address these items since they represent functions that are typically the responsibility of the pilot in a conventional aircraft. Hence, these issues were suggested as topics for novel airworthiness requirements, as proposed in Appendix B.

It is important to note that hull loss may be an unacceptable economic prospect in some cases. If this is true, trade-offs may be made between higher levels of reliability required of the UA to prevent hull loss and the equipment requirements and operational limitations that result from an expendable vehicle approach.

## **5.2. Lesson Learned about the Safety Role for the Pilot and Crew**

*A clearly defined safety role for the pilot and crew is essential to determining the systems and equipment needed for ensuring safety of flight.*

The overall safety of any UAS operation depends on the ability of the pilot and other crewmembers to perform their safety roles in an effective and efficient manner. This straightforward observation is specifically captured in the hazard severity definition for a catastrophic consequence that includes “failure conditions that are expected to result in ... complete loss of the UAS crew’s ability to perform their safety role.” [9] In conventional aviation, there is an expectation that the pilot’s role will be largely the same regardless of aircraft type or operation. Changes to the pilot’s role due to differences in aircraft type or operation are viewed as additions to the core set of knowledge and skills that all pilots are expected to possess (e.g., license endorsements). In airworthiness regulations, this can be seen in that the most

sophisticated modern aircraft still retain the ability of the pilot to take manual control and the resulting regulations for these sophisticated systems ensures the controls behave in the conventional manner. The challenge for UAS is that, due to the nascent nature of the UAS technology, the “conventional” way to operate one has yet to be defined. In addition, the wide variety of system architectures and operational requirements may mean that no single pilot interface for all UAS and all operations is possible.

For the foreseeable future, UAS stakeholders, including UAS designers, integrators, infrastructure providers, operators and customers, will make decisions that act to define the safety roles for the pilot, other crewmembers, and automated systems. These decisions will be based on the risk profile of the intended operation and the design features of the aircraft, as well as economic concerns. For example, tradeoffs can be made between the quality (or even presence) of communication links and software sophistication (i.e., autonomous capabilities).

At this point in the development of UAS, it is unclear what core set of knowledge and skills pilots (and other crewmembers) will need to operate any UAS. Part 107 provides one set of pilot qualifications that could be a starting point for developing this core set of UAS piloting knowledge and skills [1]. However, these regulations are predicated on VLOS operations. It is unclear if this core set of knowledge and skills will transfer to BVLOS operations, or, in a larger sense, if a single set of knowledge and skills will ever exist for all UAS. Thus, at this point, and perhaps in the future, as part of the definition of the operation, the pilot and other crewmembers must have a clearly specified safety role. This safety role encompasses the decisions to be made, the actions to be taken, and, critically, the information upon which these decisions are based. With these safety roles clearly delineated, training material for pilot and crew can be developed, along with more detailed requirements on the systems and equipment to support these roles.

### **5.3. Lesson Learned about Communication Systems and Equipment**

*Airworthiness requirements for communications links are impacted by (1) the means by which the communications link is implemented and (2) the location and nature of the parties communicating.*

General aviation (GA) aircraft flying under Visual Flight Rules (VFR) in certain classes of airspace can operate without a very high frequency (VHF) radio for voice communications with air traffic control (ATC). Since these radios are not required, a GA aircraft can obtain an airworthiness certificate without one. Pilots are permitted to obtain a non-certified radio to communicate with ATC, although these radios must still comply with regulations related to general radio transmissions [18]. In addition, pilots communicating with ATC over any radio (airworthiness certified or not) are still required to use a particular form for information being transmitted (e.g., specific air traffic phraseology) that is rigorously proscribed by FAA regulation (e.g., by FAA Joint Order 7110.65W [19]). Data link communication between aircraft and ground facilities is far more regulated (e.g., FAA Advisory Circulars 20-140B and 20-149B) [20, 21]. In this case, both the form of the information being transmitted, as well as the means by which it is transmitted is regulated. One of the primary features that distinguish datalink communication from voice ATC communication is that datalink communication generally occurs between two automated agents.

In both research studies, the distinction between human and automated communication was found to be more relevant than the distinction between air and ground communication. Communications in UAS operations may occur in several different ways; e.g., between human-automation, automation-automation and human-human pairs. The FAA’s current communication philosophy described above was mirrored in determining requirements for the various UAS communications. That is, design requirements were proposed for systems and equipment supporting communications between humans (the crew, which is ground based) and automation (the UA) or automation-to-automation. But, no design requirements were proposed for communication between human agents (crew)—although they are still subject to operational requirements.



For instance, the ability of the pilot-in-command to have adequate state and intent knowledge of the UA for BVLOS cargo delivery relies heavily on the quality and bandwidth of the communications link between the UA and the GCS. Since the UA and GCS represent two automated agents, one of which is airborne, design requirements were specified on the type of information, as well as the means by which the information is transmitted (see the requirement for Safety-critical C2 links in Table B2 in Appendix B). However, for extended VLOS operations in precision agriculture spraying, visual observers can directly observe the UA and then communicate the state of the UA and surrounding airspace to a pilot-in-command. This communication may utilize means such as walkie-talkies to transmit vehicle state and environmental information between two human agents. In both studies, an assumption was made that these communications devices may be subject to Federal Communications Commission (FCC) standards, but they may not be subject to airworthiness regulation. That assumption should be validated as more data becomes available. Note that there may still be operational requirements on the type of information to be transmitted (e.g., phraseology), but that was beyond the scope of the studies.

#### **5.4. Lesson Learned about Vehicle Weight**

*For many concepts of operations, vehicle weight has a minimal influence on design and performance requirements.*

Generally speaking, the severity of an incident or accident of a conventional aircraft increases with the weight of the aircraft, since aircraft weight correlates with the number of potential passengers onboard. For that reason, weight is a primary factor in designating safety-related standards (like airworthiness) for different categories of conventional aircraft. Weight, or weight combined with airspeed in a kinetic energy assessment, has also been proposed as a primary factor used in assigning risk classes to UAS [22]. For UAS, however, the connection between vehicle weight or kinetic energy and harm to persons is not quite the same as for conventional aircraft, since UAS have no persons onboard.

An unmanned aircraft can pose physical harm to persons in three main ways: (1) by colliding or causing an incident or accident with a conventional aircraft, (2) by colliding directly with persons or objects (e.g., buildings) affecting persons on the ground, or (3) by releasing high-energy parts that strike persons or property on the ground. All three instances require the vehicle to be in flight and in proximity to people or high-value assets. For some types of UAS missions, however, flights may be limited (e.g., through operational limitations or automated systems) to a geospatial area that is unpopulated; that is, flight is not in direct proximity to people. Using UAS for precision agriculture or cargo transport through uninhabited corridors, as described in the research studies, are examples of UAS applications that can be successfully conducted in unpopulated areas. For those ConOps, neither weight nor kinetic energy had a noteworthy influence on the assessment of design and performance criteria. Instead, the primary influences were operational characteristics—specifically, the fact that the operational environment was constrained to a defined volume of airspace over an unpopulated area with limited public access and limited expected air traffic. These results support an operation-centric approach to assigning risk classes to UAS and highlight the impact of geospatial containment on airworthiness considerations for UAS.

It is important to note that weight does have a significant impact on the business cases. If more cargo or agricultural inputs can be carried, the operation often becomes more economically efficient. Fewer flights with heavier aircraft may subject the general public to less noise, emissions, and other inconveniences.

#### **5.5. Lesson Learned about Access to the Operational Volume**

*For UAS operations confined to an uninhabited operational volume, the ability to control access to that volume by parties not connected to the operation significantly impacts the airworthiness requirements.*

Airworthiness requirements for UAS operations should be based on the risk that they present to the general public. For highly controlled operations, such as precision agricultural spraying, where the UA

can be confined to a fixed volume of compact size, it may be possible to clear the area of human presence. While the UA is in operation, operational procedures can be used to ensure the overflowed area remains clear of persons, and thus crashing the vehicle is no longer a hazard (as described in section 5.1). Thus, the ability to control access to the operational volume dominates the risk posed to the general public, and not any particular characteristic of the vehicle itself (nor its airworthiness). This is conditional upon the assumption that the UA remains contained in its predefined volume.

However, once access to the operational volume is relaxed, such as through porous boundaries or large (non-compact) areas where access is difficult to restrict, the risk posed to the general public by a crash of the vehicle increases. In ConOps where crashing is considered acceptable, individuals who enter into the operational volume during vehicle operations are at a higher risk of harm, thereby increasing public risk. Thus, additional means of area clearance and boundary control must be enacted through operational procedures or restrictions, or design requirements must be employed to decrease the risk that a vehicle crash may cause harm to persons on the ground. Determining the level of acceptable risk to the public requires research and validation beyond the scope of this study.

## **5.6. Lesson Learned about Operational Altitude**

*Increasing operational altitude increases the likelihood and severity of hazards associated with the ejection of high-energy parts and the hazard associated with loss of separation with other aircraft.*

The UA's operational altitude directly impacts vehicle structural requirements, stability, controllability and maneuverability requirements, as well as powerplant and supporting systems requirements. For UA flying low to the ground prior to a crash or explosion event, any parts ejected will have a low potential energy, which will result in a smaller crash footprint than if the vehicle were flying at a significantly higher altitude. In the precision agriculture study, where the UA nominally operates in close proximity to the ground, only a small fixed set of design requirements pertaining to structural and controls issues were proposed to mitigate the risk posed by limited flight at higher altitudes to circumnavigate obstacles.

For cargo delivery in class G airspace, the vehicle is more likely to maintain a higher altitude during flight, thereby requiring further design requirements (and possibly autorotative capability) to mitigate hazards that lead to releasing high energy parts. In general, for flights at higher altitude, the risk posed by the ejection of high energy parts may not appreciably increase beyond a certain threshold. However, the risk posed by the interaction of the vehicle with other air traffic increases greatly as altitude increases. Thus, some demarcation of altitude within class G airspace (low to the ground vs. substantial elevation above ground height) may be useful in determining the need for design requirements related to risks associated with the ejection of high energy parts. Such a demarcation may not be useful for hazards associated with loss of separation with other aircraft. For those hazards, understanding of traditional operational heights for conventional aircraft (above 500 ft for rotorcraft and above 1000 ft for fixed wing) may be more useful.

## **6. Summary**

In the pursuit of enabling UAS to routinely access the national airspace system, much attention has been devoted to two ends of the multi-dimensional spectrum of UAS. At one end are small UAS weighing less than 55 lb that pose limited risk to people and property. For those UAS, regulatory requirements such as those in Part 107 concentrate on operational limitations. At the other end of the spectrum are large UAS intended for more traditional aircraft operations with risk equivalent to conventional aircraft. Regulatory requirements for those UAS are expected to be similar to certification criteria for conventional aircraft with additions for communication links and detect and avoid systems. That leaves a gap in attention to those UAS that fall in between these two extremes; i.e., UAS with substantial capability, but with size,

weight, and power limitations and reliance on non-pedigreed components. A primary goal of the airworthiness studies described in this report was to help address that gap.

There is a growing recognition that the risk associated with UAS that fall within this gap is very dependent on the operational context. That is, risk to people and property from a UAS performing one type of operation may be very different from the same UAS performing that same or similar operation in a different environment. Understanding the operational hazards is essential. Hence, regulatory requirements need to be operation specific or specific to categories of operations that share the same or similar hazards and mitigation obligations. Toward that end, the principal contribution from the two airworthiness studies is a unified set of design and performance requirements for midrange unmanned rotorcraft operating in a low-risk environment. These requirements could be used as a starting point for industry and regulators to establish specific requirements for UAS operations similar to and including precision agriculture and cargo delivery—where all operations are within an unpopulated operational volume.

This work also includes two detailed concepts of operations, one for precision agriculture and one for cargo delivery. These ConOps are sufficiently detailed to enable hazard analysis to be performed, design requirements to be developed, and the safety roles for pilot and crew to be defined. These ConOps may also provide a framework for the development of other low-risk ConOps, such as railroad or pipeline inspection with midrange UAS that may share similar hazards.

Other notable contributions from this work include:

- Identification of vehicle and operational factors that may be useful in the eventual classification of UAS [23].
- Identification of hazards for unmanned rotorcraft (namely, loss of rotor system integrity and powerplant explosion) that can lead to release of high energy parts that could pose harm to people, and specification of preliminary design and performance requirements to mitigate those hazards. While these hazards are covered in the design requirements for conventional rotorcraft, they may not be readily acknowledged as important in low-risk operations.
- Specification of preliminary design and performance requirements for novel UAS technologies, including requirements for
  - Remaining within a designated operational volume
  - Systems and equipment that support the safety role of the pilot and crew
  - Detecting and avoiding other aircraft
  - Detecting and avoiding ground-based obstacles
  - Safety-critical command and control links

Altogether, the research results from the two airworthiness studies support a small step in advancing the development of standards and regulation for UAS that fall in the ill-defined middle of the multi-dimensional spectrum of UAS.

## 7. References

- [1] United States Government, (undated), Title 14 Code of Federal Regulations, Part 107, Small Unmanned Aircraft Systems, [Online], Available: <http://www.ecfr.gov/cgi-bin/text-idx?SID=ae4f72f9345bad959a0d89dc3084918f&mc=true&node=pt14.2.107&rgn=div5>
- [2] Warwick, Graham, “Unmanned Unleashed”, Aviation Week & Space Technology, September 12-25, 2016, pp. 34-35.
- [3] United States House of Representative, FAA Modernization and Reform Act of 2012, Report 112-381, 112th Congress, 2d Session, Conference Report to accompany H.R. 658, February 1, 2012. [Online], Available: [https://www.faa.gov/uas/media/Sec\\_331\\_336\\_UAS.pdf](https://www.faa.gov/uas/media/Sec_331_336_UAS.pdf)
- [4] European Aviation Safety Agency, ‘Prototype’ Commission Regulation of Unmanned Aircraft Operations, 22 August 2016, [Online], Available: <https://www.easa.europa.eu/system/files/dfu/UAS%20Prototype%20Regulation%20final.pdf>
- [5] Nonami, K., Prospect and recent research & development for civil use autonomous unmanned aircraft as UAV and MAV. Journal of System Design and Dynamics, Vol. 1, No. 2, 2007, pp. 120-128.
- [6] Turner, J. M., Kenkel, P. L., Holcomb, R. B., and Arnall, D. B., “Economic potential of unmanned aircraft in agricultural and rural electric cooperatives”. Southern Agricultural Economics Association Annual Meeting, February 2016, San Antonio, TX.
- [7] Marsh Aviation and Aerospace Practice, “Dawning of the Drones: The Evolving Risk of Unmanned Aerial Systems”, June 2015, [Online], Available: <https://www.marsh.com/content/dam/marsh/Documents/PDF/US-en/Dawning%20of%20the%20Drones-06-2015.pdf>
- [8] Federal Aviation Administration, Integration of Civil Unmanned Aircraft Systems (UAS) in the National Airspace System (NAS) Roadmap, First Edition – 2013.
- [9] Hayhurst, Kelly J., Maddalon, Jeffrey M., Neogi, Natasha A., Verstynen, Harry A., Buelow, Barry, and McCormick, G. Frank, Mock Certification Basis for an Unmanned Rotorcraft for Precision Agricultural Spraying, NASA/TM-2015-218979, November 2015
- [10] International Civil Aviation Organization, Unmanned Aircraft Systems (UAS), Cir 328, 2011.
- [11] United States Government, (undated), Title 14 Code of Federal Regulations, Electronic Code of Federal Regulation, Part 27—Airworthiness Standards: Normal Category Rotorcraft, [Online], Available: <http://www.ecfr.gov/cgi-bin/ECFR?page=browse>
- [12] Joint Authorities for Rulemaking on Unmanned Systems (JARUS) Working Group -3 Airworthiness, Certification Specification for Light Unmanned Rotorcraft Systems (CS-LURS), Version 1.0, October 30, 2013.
- [13] Jenkins, D., and Vasigh, B., The economic impact of unmanned aircraft systems integration in the United States, Association for Unmanned Vehicle Systems International, 2013.
- [14] Plant, R. E., Site-specific management: The application of information technology to crop production. Computers and Electronics in Agriculture, 300, 2001, pp 9-29.
- [15] Hayhurst, K., Maddalon, J., Neogi, N., Verstynen, H., A Case Study for Assured Containment,” International Conference on Unmanned Aircraft Systems, Denver, CO, June 2015.
- [16] Stevens, Mia M., and Atkins, Ella M., Multicopter Geofencing System, 16<sup>th</sup> AIAA Aviation Technology, Integration, and Operations Conference, Washington D.C., June 2016.

- [17] Federal Aviation Administration, FAA Order 8110.112, Standardized Procedures for Usage of Issue Papers and Development of Equivalent Levels of Safety Memorandums, June 15, 2010.
- [18] United States Government, (undated), Title 47 Code of Federal Regulations, Part 87.133, Frequency Stability, [Online], Available: [http://www.ecfr.gov/cgi-bin/text-idx?SID=9476a957ef9f465d470ec3b3440722fa&mc=true&node=pt47.5.87&rgn=div5#se47.5.87\\_1133](http://www.ecfr.gov/cgi-bin/text-idx?SID=9476a957ef9f465d470ec3b3440722fa&mc=true&node=pt47.5.87&rgn=div5#se47.5.87_1133)
- [19] Federal Aviation Administration, FAA Joint Order 7110.65, Air Traffic Control, October 27, 2015.
- [20] Federal Aviation Administration, FAA Advisory Circular 20-140B, Guidelines for Design Approval of Aircraft Data Link Communication Systems Supporting Air Traffic Services, September 27, 2012.
- [21] Federal Aviation Administration, FAA Advisory Circular 20-149B, Installation Guidance for Domestic Flight Information Service-Broadcast, December 21, 2015.
- [22] Ryan, Wes, "Certification of UAS: Overview of UAS Type Certification Policy & Certification Efforts", presented at the Unmanned Aerial Systems Technical Analysis and Applications Center 2015 meeting, December 9, 2015.
- [23] Maddalon, J. M., Hayhurst, K. J., Neogi, N. A., Verstynen, H. A., and Clothier, R. A., Expanding the Envelope of UAS Certification: What it Takes to Type Certify a UAS for Precision Agricultural Spraying, AUVSI Xponential 2016 Conference, New Orleans, LA, May 2016.

## Appendix A: Concept of Operations for Unmanned Cargo Delivery through Uninhabited Corridors

This concept of operations (ConOps) describes aircraft and operational aspects of cargo delivery through uninhabited corridors in remote or sparsely-populated areas using a midrange unmanned rotorcraft. The economic objective is to allow for the delivery or retrieval of goods or supplies in remote locations, when other means of transportation are not possible or practical. This ConOps was based on the ConOps for unmanned precision agriculture used in the first airworthiness research study [9]. A cornerstone of the precision agriculture ConOps was reliably containing a UA's operation within a well-defined volume of airspace that was restricted in altitude and inhabitants. The cargo delivery ConOps effectively extends both the vehicle's operational range and altitude beyond that assumed in the precision agriculture ConOps (i.e., extending the operational volume). Characteristics that are critical to limiting risk to aircraft, people, and property in proximity to the operation are also retained (e.g., the operational volume is unpopulated, has limited access, etc.).

The limited cargo delivery operation described here assumes a UAS that employs systems and equipment appropriate for midrange UAS and ground-based equipment for sense-and-avoid, containment, and command and control. The limited corridor consists of a volume of airspace purposely designed to avoid overflight of people and high-value ground assets. Corridors extend from designated (pre-approved) launch sites to designated landing zones, through Class G airspace only. Figure A1 illustrates a generic limited corridor with associated ground equipment to support detection of intruder aircraft and assured containment of the UA.

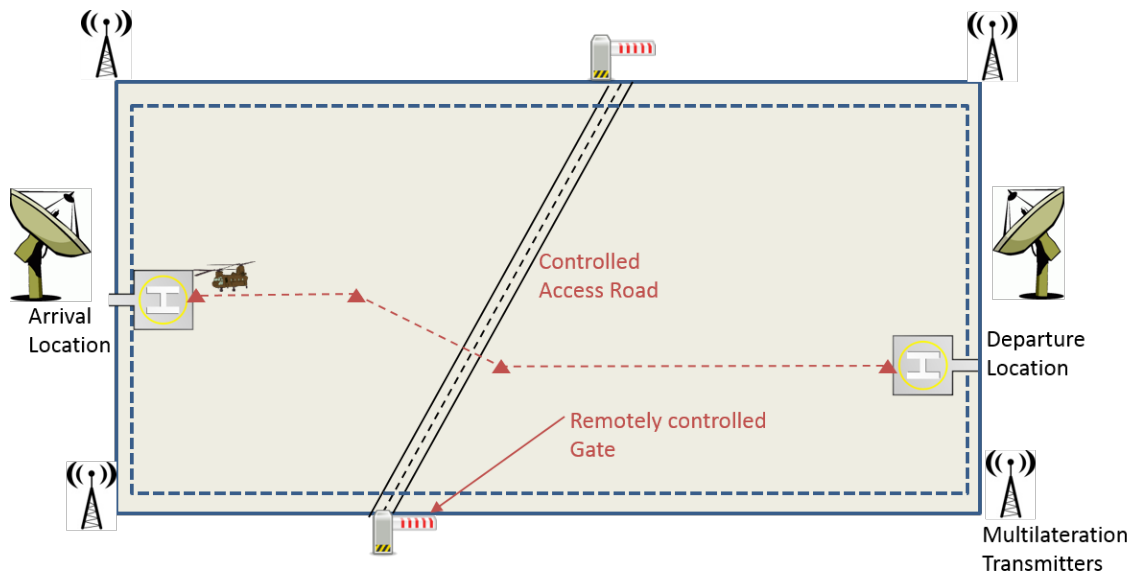

Figure A1. Illustration of the ConOps for Unmanned Cargo Delivery

The concept relies heavily on the general remoteness of the area to reduce the likelihood of humans and critical infrastructure in the corridor. The concept allows traditional methods, such as fences, to restrict physical access in areas where people may be close to the corridor. Gates or checkpoints can be used at common access points (e.g., roads) to limit entry. While the case illustrated in Figure A1 has a single origin-destination pair, additional pickup and drop-off locations are allowed within the corridor provided each location meets the equipment and/or personnel requirements assumed in the hazard analysis.

The objective of this ConOps is to provide a sufficient description of the proposed UAS, its operation, and the operational environment to allow identification of relevant aviation safety hazards and their mitigation.

## A1. Characteristics and Assumptions

This ConOps assumes that the UAS will require an airworthiness certificate. That is, the UAS and its operation are assumed to exceed criteria necessary to conduct commercial operations under FAR Part 107 or Section 333 exemptions (e.g., weight, speed, BVLOS operations, etc.). A commercial service provider will operate the UAS, similar in concept to conventional package delivery services. The service provider will be responsible for (1) using an appropriately certificated UAS, (2) obtaining appropriate operational approvals from relevant federal, state, and local authorities, and (3) selecting, training, and maintaining qualifications for all crewmembers required by the operating certificate. Characteristics and assumptions about the UAS, the pilot and crew, the cargo delivery operation, and the operational environment are listed in Table A1.

Table A1. Characteristics and Assumptions Important to the Cargo Delivery ConOps

<b>Characteristics and Assumptions about the UAS based on the DP-14</b>
<p><u>Aircraft</u></p> <ul style="list-style-type: none"> <li>• The UA will be a rotorcraft (conventional design) with tandem rotors and a single turbine engine.               <ul style="list-style-type: none"> <li>– Weight Range &gt; 55 lb</li> <li>– Payload Capacity up to 400 lb</li> </ul> </li> <li>• The UA will be capable of takeoff, flight and landing in the designated corridor, at design maximum weights and speeds, including the ability to operate in the elevations, winds, wind gusts, and temperature ranges associated with the operational environment.</li> </ul>
<p><u>Ground Control Station</u></p> <ul style="list-style-type: none"> <li>• Computer with displays that allow the pilot to monitor the progress of the vehicle along its flight path</li> <li>• Stationary, enclosed or unenclosed</li> <li>• Control Station-to-Aircraft Ratio: 1:1</li> </ul>
<p><u>Communication Links</u></p> <ul style="list-style-type: none"> <li>• Radio Line of Sight (RLOS)</li> <li>• Terrestrial or satellite relays</li> </ul>
<p><u>Auxiliary Equipment</u></p> <ul style="list-style-type: none"> <li>• Both the arrival and departure locations are equipped with ground-based radars that provide a ground-based detection and avoidance (GBDAA) capability to provide protection against collisions with other aircraft. These radars are situated to provide complete coverage of the surrounding area such that avoidance action can be taken by the UA prior to a loss of separation.</li> <li>• The vehicle design includes an onboard obstruction detection system that senses temporary, unplanned, or unknown obstructions. That system autonomously executes a simple hover-in-place or similar avoidance maneuver until the pilot can clear the UA to resume navigation. Complex avoidance maneuvers are not included in the design. Fixed or known obstructions are preprogrammed into the vehicle's navigation database.</li> <li>• Navigation is based upon redundant onboard GPS-based systems. All inner loop stabilization and control of the vehicle occurs onboard without provisions for human intervention.</li> <li>• A highly reliable onboard automatic system that uses ground-based sensors that form an independent (from the navigation system) position determination system is used to support containment. Other components necessary for this system to function, such as power supplies, computational resources, and activation systems are also independent of the UA's primary systems.</li> </ul>
<p><u>Payload</u></p> <ul style="list-style-type: none"> <li>• The payload may be carried internally, externally (including sling loads), or a combination of both.</li> <li>• Cargo will be limited to non-hazardous substances and liquids. Cargo hazards to be avoided include EMI that could affect the UA's systems, explosion hazards, hazmat materials, and packaging that could result in unacceptable dynamic behavior for external loads. External cargo cannot be intentionally jettisoned.</li> </ul>
<b>Characteristics and Assumptions relevant to the Pilot &amp; Crew</b>

- Operations are generally BVLOS of the pilot and crew, except at the arrival and departure locations.
- Crew may be located at both the takeoff and the landing locations.
- The pilot-to-aircraft ratio is 1:1.
- The pilot can only provide outer-loop control actions, e.g., return to base, pause operation, etc. Direct stick-to-servo control (comparable to a model aircraft) is not required in any mode of operation.
- Safety roles for the pilot and other crewmembers will be established by the applicant. The safety role may include aspects related to cargo loading and unloading.

#### **Characteristics and Assumptions about the Operational/Environmental Context**

- Operational Area
  - The UA will operate only within a predefined, bounded containment zone or operational volume. The boundaries of the corridor are geospatially fixed and based on coverage of ground equipment installations. The containment zone includes an operational area plus a buffer to allow for uncontrolled UA flight termination maneuvers and the subsequent dispersion of high-energy parts upon ground contact. Enforcement of the containment zone is independent of the vehicle’s primary navigation system. Takeoff and landing areas at the departure and destination will be inside of the containment area and well clear of humans, obstacles, and other aviation activities.
  - The length of the corridor may extend up to 60 statute miles, or longer depending on the coverage of required ground-support equipment.
  - The terrain or surface area within the operational volume may be land or water. The terrain or surface area must be
    - uninhabited (i.e., no permanent human habitats) and contain no high-value or safety-critical assets such as dams, nuclear power plants, and environmentally sensitive areas. Some assets, such as power lines and pipelines, may be included provided flight path planning minimizes the exposure of such assets to UA contingency events.
    - owned by the service provider, or the service provider must have permission of the owners.
  - Access to the overflown area by humans is restricted at the boundaries by fences, “no trespassing”, “danger,” or similar signs, or by the general remoteness of the area and harshness of the weather.
    - The population density surrounding the operational area is sparse (i.e., rural area).
    - Operational procedures will be used to make sure the area is clear of humans and critical ground infrastructure. Avoidance can include temporal avoidance of hazards by scheduling of flights around known presence of humans or infrastructure within the corridor.
  - Air traffic density within the operational volume is expected to be sparse.
    - Local air traffic is possible; but the corridor is not on a known air traffic route or published airway.
    - There are no active airports within the operational volume.
  - Operations are conducted only in Class G airspace. The maximum altitude for operations is determined by the upper boundary of Class G airspace or by the range limitations of supporting ground-based systems (e.g., datalinks, ground-based radars, multilateration system), whichever is lower.
  - Hull loss from ground impact within the containment zone is not considered a safety concern. The buffer between the operational area and the containment boundaries will be sufficient to protect people and property from energetic release of parts or pieces. Hull loss that is intentional and in compliance with operational approvals (such as a contingency landing or crash within a predetermined safe area) is considered nonhazardous. Release of high-energy parts in flight is not protected by the buffer zone but is avoided by the imposition of regulatory requirements designed to prevent inflight breakup of the vehicle.
- Operations are conducted in Day/Night/VMC and IMC conditions BVLOS.
- Weather conditions for operation range from benign to icing, with no operation allowed in thunderstorms, lightning, or high wind conditions.
- A Notice to Airmen (NOTAM) and/or altitude reservation (ALTREV) may be filed depending upon FAA notification requirements and the locations of other aviation activities.



## A2. Example Use Case

Delivery of goods and emergency supplies to small villages or outposts, such as those in Alaska or Canada, is an example of a use case that could be supported under this ConOps. Some areas of Alaska and Canada are not reachable by conventional transportation during winter months, while others are not reachable in summer months due to melting of the ice roads that service these locations during the winter months.

To provide operational clarity, a specific hypothetical use case is presented here. Goods and emergency supplies are currently provided to the Alaskan village of Nuiqsut (population 425) today by way of Deadhorse, AK, primarily by manned aircraft. An unmanned rotorcraft could carry those supplies to and from Nuiqsut via the corridor illustrated in a map-based view in Figure A2. The corridor was designed to overlay only uninhabited areas and avoid airports by 5 miles, as expected by the FAA. Two small radars located at each end of the corridor could provide overlapping coverage of the corridor for ground-based detection of other aircraft (assuming a 30 statute mile range for the radars). Small transmitters located at each corner of the corridor could provide an independent multilateration capability for the assured containment system. Since the corridor lies in an area of Class G airspace (up to overlying Class E at 1200 ft), UAS operations would be limited to 1200 ft above ground level. This maximum altitude would provide adequate terrain clearance and maneuvering room for the UA to avoid obstacles and weather.

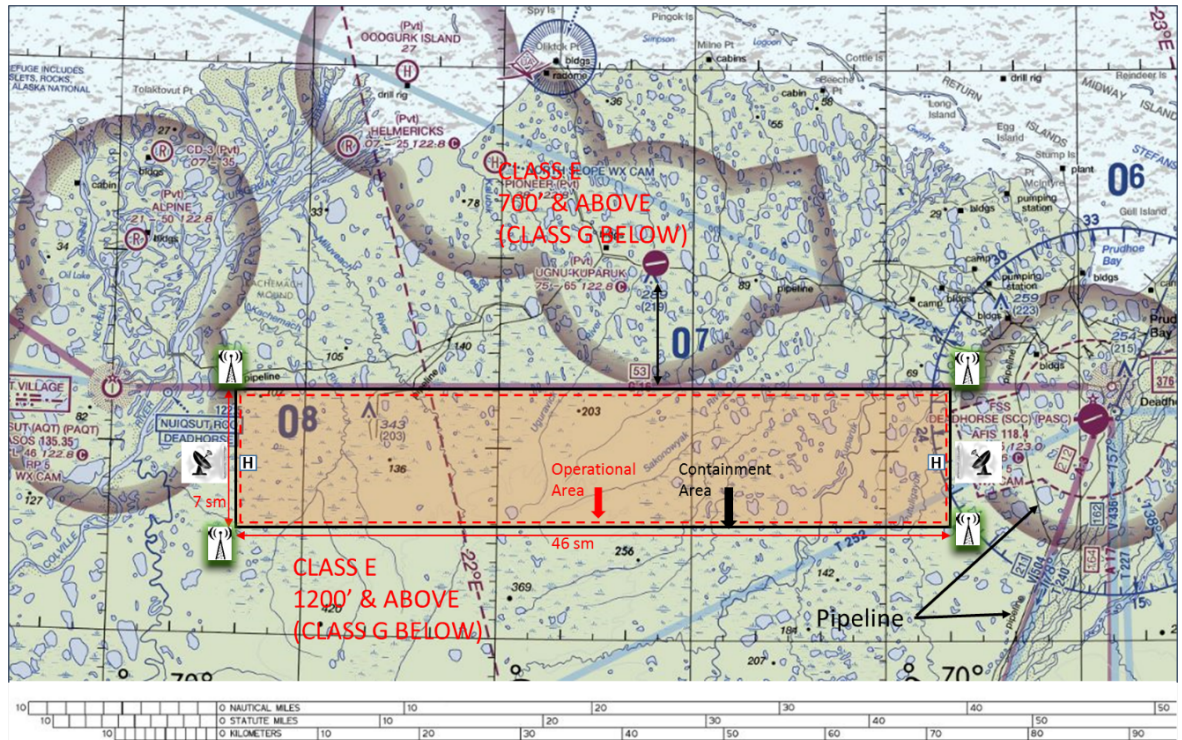

Figure A2. Hypothetical corridor for resupply of small Alaskan village.

The corridor as designed avoids all areas of implied human presence. The eastern end of the corridor, however, comes near a pipeline and a road associated with the pipeline. The road associated with the pipeline implies the possibility of human presence at certain times to conduct inspections and repairs of the pipeline. Physical barriers, such as fences or gates, signage near the road or other areas of human presence, plus the general remoteness of the area should provide adequate protection to non-participants from the UAS operations.

### **A3. Flight Operations**

The cargo operation proceeds in the following fashion. After the corridor has been established and the ground based equipment has been deployed, tested and configured as required by the certification basis, the mission planning phase begins. Mission planning activities include, but are not limited to assessing the airworthiness of the UA, selecting a compliant flight plan, notifying the FAA and local officials of the intent to fly, checking relevant weather forecasts, and loading relevant flight information (e.g., corridor containment boundaries, etc.). The mission planning phase is followed by the preflight phase, which occurs on the day of flight. Preflight activities include operational equipment checks, and loading the flight plan. The vehicle is then positioned at the takeoff location, and the takeoff and climb phase commences upon the authorization of the pilot-in-command.

#### **A3.1 Takeoff and Climb**

On the pilot's command, the UA lifts automatically to a low hover, if final checks to confirm stability and flight readiness are required. If the payload is being carried on a sling, the pilot commands the UA to a high hover so that sling load stability can be checked. When checks are complete, the pilot in command authorizes the aircraft to initiate the preprogrammed navigation path.

#### **A3.2 En route Operations**

The UA follows the preplanned flight path, typically without intervention from the pilot. Exceptions include certain contingency situations in which the pilot commands the aircraft to execute preplanned actions, such as a hover, a landing, or a return to base. The containment systems independently monitor the UA flight path, constantly calculating time to the boundaries. If a time to boundary crossing exceeds a predetermined value, an automatic contingency maneuver is executed to prevent flight outside of the corridor boundary. Activation of the GBDAA or dynamic obstacle systems could also cause the execution of a temporary maneuver to ensure safety, but the vehicle may continue on the prescribed path once the hazard has passed.

The onboard health management system constantly monitors the status of safety-critical systems onboard the UA. That system can automatically swap in backup systems when needed and available, activate preprogrammed contingency maneuvers when safety margins are permanently lost, and notify the pilot of changes in vehicle state.

The pilot cannot update the flight plan while in the en route phase. The only command options available to the pilot are hover (at altitude or low hover), land, continue to destination, return to base, or fly to a contingency point (if determined) and terminate flight.

#### **A3.3 Descent and Landing**

When the UA has completed the programmed path and is in proximity to the destination, the pilot checks with the destination location to ensure that the landing zone is clear and that they are ready to receive the aircraft. Once the clearance is obtained, an approach to the designated landing zone is initiated. This signals the start of the descent and landing phase. Depending on the cargo configuration, the vehicle may enter a hover at the landing location, release the cargo, and return to base. Alternatively, the vehicle may land, then personnel at the landing zone may offload the cargo and prepare the vehicle to make its return trip.

### **A4. Systems Description**

The UAS includes the UA, ground control station (GCS), safety-related ground and airborne sensors and systems (e.g., GBDAA and containment systems), and command and control (C2) links. This section describes the equipment and functionality of the major elements of the physical system that would be subject to design and performance requirements. Other aspects important to the UAS, including crew qualifications and operational procedures and requirements are beyond the scope the research study.

## A4.1 Unmanned Aircraft

### A4.1.1 Configuration

The corridor operation assumes an unmanned tandem-rotor rotorcraft in the 1000 lb. gross takeoff weight category. A sketch of the DP-14, used here as a representative platform, is shown in Figure A3. However, the certification basis resulting from this ConOps will also cover single-rotor helicopters at a variety of weights above 55 lb.

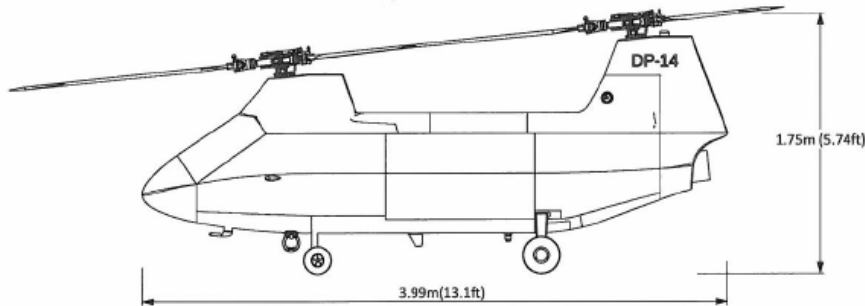

Figure A3. DP-14 from Dragonfly Pictures, Inc.

### A4.1.2 Design and Construction

The vehicle is constructed of aluminum, fiberglass, composites, and high-strength steel. The vehicle carries fuel internally. Cargo is carried in side-mounted pods or externally on a sling load mount under the center fuselage. The rotor blades are driven and synchronized by a central transmission that links to the powerplant through a clutch-like device that allows the rotor system to continue rotation in the event of an engine failure. The powerplant is a small turbine engine. The vehicle is not designed for ground taxiing or rolling takeoffs or landings.

### A4.1.3 Flight Control and Navigation

Control and stabilization of the vehicle is achieved exclusively through redundant onboard automatic systems. Vehicle start-up, takeoff, transitions to and from forward flight, forward flight, and landing are fully automatic or initiated by high-level commands from the GCS or onboard contingency management systems. The design will also include an external emergency shutdown switch.

Redundant onboard GPS-based systems augmented by inertial or other sensors as required are used for position determination. Navigation and guidance commands are generated by an onboard, preprogrammed Flight Management System (FMS). Intervention via pilot selection of specific maneuvers (such as return to base) or onboard contingency management systems is allowed. There are no provisions for direct inner loop control by the pilot in any mode of operation.

### A4.1.4 State Determination and Monitoring Equipment

The vehicle is equipped with a health management or similar system to monitor changes in vehicle system states in response to component and subsystem failures and report of vehicle health to the pilot. The monitoring system may activate preprogrammed contingency actions when necessary and notify the pilot of actions taken.

The UA is equipped with a direct height measuring system, such as a radio or laser altimeter.

A UA pitot-static system will be installed if required by the installed flight control system (air data and attitude heading and reference system plus the autopilot). Vehicle airspeed will not be reported to the GCS unless the safety role of the pilot requires monitoring airspeed.

The UA is not equipped to detect or avoid weather. Instead, the preflight planning process checks for icing and convective conditions that should be avoided.

#### A4.1.5 Night Flight Equipment

The UA is equipped with anti-collision lights so it can be seen by other aircraft. The UA also has navigation lights and landing lights (as required), as well as associated systems for remote control of onboard lights.

### **A4.2 Ground Control Station (GCS)**

The GCS consists of a computer with displays that allow the pilot to monitor the progress of the vehicle along its flight path. The GCS equipment will also include a warning system from the GBDAA system, a warning from the onboard containment systems, a warning from the Object Detection System, and notifications from the health management and contingency management systems. Suitable controls for the pilot to activate in the event of a warning or a need for pilot action independent of the warnings are provided. The GCS allows the pilot to resume the UA's flight path once select warnings no longer apply. The GCS will also contain controls to allow release of the cargo if external load operations are used and/or startup/shutdown sequences if landing is required to deliver cargo. The GCS also contains interfaces to the C2 links and displays for monitoring the C2 link status.

Since the GCS is an integral part of the UAS, power backup, fire protection, and other safety systems necessary for safe operations of the GCS are subject to design and performance requirements.

### **A4.3 Command and Control (C2) Equipment**

Safe operation of the UA requires reliable and continuous C2 communications between the GCS and the UA. Uplinks and downlinks require redundant transmitters and receivers in both the UA and on the ground.

The limited length of the corridor under this ConOps, along with strategic placement of antennae, may allow the UA to stay within direct RLOS of the departure or arrival locations for the entirety of the flight. If corridor dimensions, height restrictions, or terrain prevent direct RLOS, ground relay stations may be employed, or satellite relays may be used.

The equipment used to provide safety-critical C2 links to the UA is subject to design and performance requirements.

### **A4.4 Auxiliary Systems and Equipment**

#### A4.4.1 Containment System Equipment

The containment system senses lateral aircraft position via multilateration from ground-based transmitters positioned to provide complete corridor coverage. The UA receives these signals through receivers independent of the primary navigation system and triangulates to determine current position. An independent onboard processor processes the position data to determine a projected time to crossing of the corridor boundary. If the UA primary navigation system does not take sufficient action to adjust its path to avoid crossing the boundary, the containment system will terminate flight (e.g., by shutting a fuel valve) prior to crossing the boundary. The containment system also incorporates an independent vertical containment capability that utilizes an independent direct height or altitude measurement system.

#### A4.4.2 Aircraft Collision Avoidance Equipment

A ground-based detection and avoidance (GBDAA) system is used to avoid midair collisions with other aircraft. The GBDAA system uses pedestal-mounted radars at each end of the corridor. The radars taken

together have sufficient coverage both within and beyond the corridor to provide a timely warning for an intruder entering the corridor. Upon notification of an intruder, the pilot in command sends a command to the UA that initiates a contingency response (to hover or land), or an automatic contingency response may be initiated onboard the aircraft. The UA is always the burdened aircraft responsible for taking action, if necessary, to avoid a loss of separation with another aircraft.

#### A4.4.3 Terrain Avoidance Equipment

The UA avoids terrain by operating at a fixed height above the terrain using a radio/laser altimeter or similar height sensing system or by flying at a fixed altitude, which was guaranteed to be greater than some specified offset above all obstacles in the terrain. The primary navigation system may also include the use of a terrain database.

#### A4.4.4 Dynamic Obstacle Avoidance System

The main means of avoiding obstacles is through a database in the primary navigation system. In addition, the UA is equipped with a low-cost system that can detect ground-based obstacles and execute a predetermined maneuver. The primary means of avoiding obstacles is through a database in the primary navigation system. Flight may resume once the PIC determines the obstacle is clear of the vehicle.

### **A4.5 Payload-Related Equipment**

Figure A4 shows configurations of the DP-14 for external and internal cargo.



Figure A4. The DP-14 configured for internal and external cargo.

Payloads will be limited to non-hazardous items and may be carried internally, externally, or both. Payloads carried externally for off-loading from a hover (sling loads) will require equipment, or ground personnel, to ensure that the unloading zone is clear of humans and obstacles. Jettisoning of payloads is not allowed under this ConOps. Equipment to control movement of internal cargo and equipment to capture and release external cargo are subject to design and performance requirements.

## **Appendix B: Suggested Design Requirements Supporting Unmanned Cargo Delivery**

This appendix presents one view of possible design and performance requirements that might serve as a starting point for establishing airworthiness standards for a midrange unmanned rotorcraft used for cargo delivery through unpopulated corridors, as described in Appendix A. The design and performance requirements listed in Table B2 were proposed specifically for unmanned rotorcraft with the physical and operational characteristics given in Table B1. The contents of Table B2 should not be considered separate from Table B1. That is, the design and performance requirements suggested in Table B2 may not be appropriate for UAS that do not have the characteristics given in Table B1.

Most of the requirements in Table B2 are based on an assessment of the extent to which existing airworthiness standards for normal category (manned) rotorcraft, as given in Part 27 of the FARs, may apply. Each requirement in Table B2 that is based on a requirement in Part 27 is marked with the appropriate Part 27 reference. See Appendix C for the full assessment of Part 27 requirements.

Five of the requirements in Table B2, listed under the label “Suggested Requirements Abstracted from FAR Part 27,” were developed in the course of the airworthiness studies, as described in section 4.2. Those requirements include:

- Design characteristics for autopilot control
- Ancillary support systems for controllability, maneuverability, and stability
- Design characteristics for structural integrity
- Powerplant explosion prevention

Table B2 also includes requirements for systems and equipment needed to mitigate UAS-specific hazards that are not addressed in Part 27. Suggested text for new technology requirements is provided under the label “Suggested Requirements for Novel UAS Technologies”. Requirements under that label include:

- Containment in a designated operational volume
- Detect and avoid intruder aircraft
- Detect and avoid ground-based obstacles
- Safety-critical command and control (C2) links
- Systems and equipment to support pilot and crew safety roles

Table B1. Characteristics of an Unmanned Rotorcraft Operated for Cargo Transport through Unpopulated Corridors

UAS	
Aircraft	<ul style="list-style-type: none"> <li>• Rotorcraft (Conventional Design)               <ul style="list-style-type: none"> <li>– Single or Multiple Rotors</li> <li>– Single or Multiple Engines</li> <li>– Turbine or Reciprocating Engines (excludes electric-powered engines)</li> <li>– Conventional landing gear, including Wheels/Skids/Skis/Floats</li> <li>– Weight Range &gt; 55 lb</li> </ul> </li> </ul>
Ground Control Station	<ul style="list-style-type: none"> <li>• Stationary</li> <li>• Enclosed or unenclosed</li> <li>• Control Station-to-Aircraft Ratio: 1:1</li> </ul>
Communication Links	<ul style="list-style-type: none"> <li>• Minimum of one safety-critical C2 link</li> <li>• Radio Line of Sight</li> <li>• Terrestrial or satellite relays</li> </ul>
Auxiliary Equipment	<ul style="list-style-type: none"> <li>• Detection and Avoidance of Other Aircraft</li> <li>• Detection and Avoidance of Ground-based Obstacles</li> <li>• Containment</li> </ul>
Payload	<ul style="list-style-type: none"> <li>• Internally or externally carried, or a combination of both</li> <li>• Non-hazardous</li> </ul>
<b>Pilot &amp; Crew</b>	<ul style="list-style-type: none"> <li>• BVLOS</li> <li>• Pilot-to-Aircraft Ratio: 1:1</li> <li>• Some crew may be located at both the takeoff and the landing locations</li> <li>• Pilot control authority: Outer loop only (i.e., no direct stick-to-servo control; highly automated primary flight control system)</li> </ul>
<b>Operational/Environmental Context</b>	<ul style="list-style-type: none"> <li>• Operational Area               <ul style="list-style-type: none"> <li>– Contained (UA must operate within a designated, authorized operational volume or corridor that extends to the ground)                   <ul style="list-style-type: none"> <li>○ Takeoff and landing is within the operational volume</li> <li>○ Range &lt; 60 sm</li> </ul> </li> <li>– Surface Area within the operational volume (includes both land and water)                   <ul style="list-style-type: none"> <li>○ Uninhabited</li> <li>○ Contains no high-value or safety-critical assets</li> <li>○ Access is limited and controlled</li> </ul> </li> <li>– Air traffic density within the operational volume: Sparse                   <ul style="list-style-type: none"> <li>○ Possible local air traffic; that is, not on a known air traffic route or published airway</li> <li>○ No active airports within the operational volume</li> </ul> </li> <li>– Permission of property owners for overflight and landing (including flight termination)</li> <li>– Airspace: Class G only</li> <li>– Hull loss is acceptable within the operational volume                   <ul style="list-style-type: none"> <li>○ In flight breakups are not acceptable due to potentially large scatter volume of high energy parts.</li> </ul> </li> </ul> </li> <li>• Visual Conditions: VMC-Day, VMC-Night, and IMC-Day/Night</li> <li>• Population Density Surrounding the Operational Area: Sparse/Rural</li> <li>• Weather: Benign to Icing (no thunderstorms, lightning, or high wind conditions)</li> </ul>

Table B2. Suggested Type Design Requirements for an Unmanned Rotorcraft with Table B1 Characteristics

<b>Subpart A—General</b>
<b>Applicability (Modified version of §27.1)</b> This set of requirements prescribes airworthiness standards for the issue of type certificates, and changes to those certificates, for unmanned rotorcraft with the characteristics given in Table B1.
<b>Subpart B—Flight</b>
<b>General</b>
<b>Proof of compliance (Modified version of §27.21)</b> Each requirement of this set must be met. This must be shown by tests upon a rotorcraft of the type for which certification is requested, or by calculations based on, and equal in accuracy to, the results of testing.
<b>Removable ballast (Modified version of §27.31)</b> Removable ballast may be used in showing compliance with applicable flight requirements.
<b>Ground and Water Handling Characteristics</b>
<b>Ground resonance (Same as §27.241)</b> The rotorcraft may have no dangerous tendency to oscillate on the ground with the rotor turning.
<b>Subpart C—Strength Requirements</b>
<b>Flight Loads</b>
<b>Ground clearance: tail rotor guard ( Same as §27.411)</b> (a) It must be impossible for the tail rotor to contact the landing surface during a normal landing. (b) If a tail rotor guard is required to show compliance with paragraph (a) of this section— (1) Suitable design loads must be established for the guard; and (2) The guard and its supporting structure must be designed to withstand those loads.
<b>Unsymmetrical loads ( Same as §27.427)</b> (a) Horizontal tail surfaces and their supporting structure must be designed for unsymmetrical loads arising from yawing and rotor wake effects in combination with the prescribed flight conditions. (b) To meet the design criteria of paragraph (a) of this section, in the absence of more rational data, both of the following must be met: (1) One hundred percent of the maximum loading from the symmetrical flight conditions acts on the surface on one side of the plane of symmetry, and no loading acts on the other side. (2) Fifty percent of the maximum loading from the symmetrical flight conditions acts on the surface on each side of the plane of symmetry but in opposite directions. (c) For empennage arrangements where the horizontal tail surfaces are supported by the vertical tail surfaces, the vertical tail surfaces and supporting structure must be designed for the combined vertical and horizontal surface loads resulting from each prescribed flight condition, considered separately. The flight conditions must be selected so the maximum design loads are obtained on each surface. In the absence of more rational data, the unsymmetrical horizontal tail surface loading distributions described in this section must be assumed.
<b>Subpart D—Design and Construction</b>
<b>General</b>
<b>Design (Modified version of §27.601)</b> (a) The UAS may have no design features or details that experience has shown to be hazardous. (b) For each questionable design detail whose failure could adversely affect safety, the suitability of each questionable design detail and part must be established by tests.
<b>Critical Parts (Modified §27.602)</b> (a) Critical part. A critical part is a part, the failure of which could have a catastrophic effect upon the UAS, and for which critical characteristics have been identified which must be controlled to ensure the required level of integrity. (b) If the type design includes critical parts, a critical parts list shall be established. Procedures shall be established to define the critical design characteristics, identify processes that affect those characteristics, and identify the design change and process change controls necessary for showing compliance with the quality assurance requirements of part 21 of this chapter.
<b>Materials ( Same as §27.603)</b> The suitability and durability of materials used for parts, the failure of which could adversely affect safety, must—



<p>(a) Be established on the basis of experience or tests;</p> <p>(b) Meet approved specifications that ensure their having the strength and other properties assumed in the design data; and</p> <p>(c) Take into account the effects of environmental conditions, such as temperature and humidity, expected in service.</p>
<p><b>Protection of structure (Modified version of §27.609)</b></p> <p>Each part of the structure, whose failure could adversely affect safety, must—</p> <p>(a) Be suitably protected against deterioration or loss of strength in service due to any cause, including—</p> <ol style="list-style-type: none"> <li>(1) Weathering;</li> <li>(2) Corrosion; and</li> <li>(3) Abrasion; and</li> </ol> <p>(b) Have provisions for ventilation and drainage where necessary to prevent the accumulation of corrosive, flammable, or noxious fluids.</p>
<p><b>Lightning and static electricity protection (Modified version of §27.610)</b></p> <p>The electrical bonding and protection against static electricity must—</p> <ol style="list-style-type: none"> <li>(1) Minimize the accumulation of electrostatic charge;</li> <li>(2) Minimize the risk of electric shock to crew, and service and maintenance personnel using normal precautions;</li> <li>(3) Provide an electrical return path, under both normal and fault conditions, on rotorcraft having grounded electrical systems; and</li> <li>(4) Reduce to an acceptable level the effects of static electricity on the functioning of essential electrical and electronic equipment.</li> </ol>
<p><b>Inspection provisions (Modified version of §27.611)</b></p> <p>There must be means to allow the close examination of each part, whose failure could adversely affect safety, that requires—</p> <ol style="list-style-type: none"> <li>(a) Recurring inspection;</li> <li>(b) Adjustment for proper alignment and functioning; or</li> <li>(c) Lubrication.</li> </ol>
<p><b>Flutter ( Same as §27.629)</b></p> <p>Each aerodynamic surface of the rotorcraft must be free from flutter under each appropriate speed and power condition.</p>
<p><b>Control Systems</b></p>
<p><b>Autorotation control mechanism ( Same as §27.691)</b></p> <p>Each main rotor blade pitch control mechanism must allow rapid entry into autorotation after power failure.</p>
<p><b>Personnel and Cargo Accommodations</b></p>
<p><b>Cargo and baggage compartments (Modified version of §27.787)</b></p> <p>If cargo is carried,</p> <ol style="list-style-type: none"> <li>(a) Each cargo and baggage compartment must be designed for its placarded maximum weight of contents and for the critical load distributions at the appropriate maximum load factors corresponding to the specified flight conditions.</li> <li>(b) There must be means to prevent the contents of any compartment from becoming a hazard by shifting under the loads specified in paragraph (a) of this section.</li> </ol>
<p><b>Fire Protection</b></p>
<p><b>Cargo and baggage compartments (Modified version of §27.855)</b></p> <p>If cargo is carried, no cargo compartment may contain any controls, wiring, lines, equipment, or accessories whose damage or failure would affect safe operation, unless those items are protected so that—</p> <ol style="list-style-type: none"> <li>(1) They cannot be damaged by the movement of cargo in the compartment; and</li> <li>(2) Their breakage or failure will not create a fire hazard.</li> </ol>
<p><b>Fire protection of structure, controls, and other parts (Modified version of §27.861)</b></p> <p>Each part of the structure, controls, rotor mechanism, and other parts essential to preventing loss of containment or ejection of high energy parts that would be affected by powerplant fires must be fireproof or protected so they can perform their essential functions for at least 5 minutes under any foreseeable powerplant fire conditions.</p>
<p><b>Flammable fluid fire protection (Modified version of §27.863)</b></p> <p>In each area where flammable fluids or vapors might escape by leakage of a fluid system, there must be means for controlling or extinguishing a fire, such as stopping flow of fluids, shutting down equipment, fireproof containment, or use of extinguishing agents provided either by the type design or through operational requirements and provisions.</p>
<p><b>External Loads</b></p>
<p><b>External loads (Modified version of §27.865)</b></p>

- (a) It must be shown by analysis, test, or both, that the rotorcraft external load attaching means for rotorcraft-load combinations to be used for nonhuman external cargo applications can withstand a limit static load sufficient to maintain safe operations.
- (b) A placard or marking must be installed next to the external-load attaching means clearly stating any operational limitations and the maximum authorized external load.
- (c) Fatigue evaluation does not apply to rotorcraft-load combinations to be used for nonhuman external cargo except for the failure of critical structural elements that would result in a hazard to the crew.

**Miscellaneous**

**Ballast provisions (Same as §27.873)**

Ballast provisions must be designed and constructed to prevent inadvertent shifting of ballast in flight.

**Subpart E—Powerplant**

**General**

**Engines (Modified version of §27.903)**

Turbine engine installation. For turbine engine installations, the powerplant systems associated with engine control devices, systems, and instrumentation must be designed to give reasonable assurance that those engine operating limitations that adversely affect turbine rotor structural integrity will not be exceeded in service.

**Engine vibration (Modified version of §27.907)**

No part of the rotor drive system may be subjected to excessive vibration stresses.

**Rotor Drive System**

**Design (Same as §27.917)**

- (a) Each rotor drive system must incorporate a unit for each engine to automatically disengage that engine from the main and auxiliary rotors if that engine fails.
- (b) Each rotor drive system must be arranged so that each rotor necessary for control in autorotation will continue to be driven by the main rotors after disengagement of the engine from the main and auxiliary rotors.
- (c) If a torque limiting device is used in the rotor drive system, it must be located so as to allow continued control of the rotorcraft when the device is operating.
- (d) The rotor drive system includes any part necessary to transmit power from the engines to the rotor hubs. This includes gear boxes, shafting, universal joints, couplings, rotor brake assemblies, clutches, supporting bearings for shafting, any attendant accessory pads or drives, and any cooling fans that are a part of, attached to, or mounted on the rotor drive system.

**Rotor brake (Same as §27.921)**

If there is a means to control the rotation of the rotor drive system independently of the engine, any limitations on the use of that means must be specified, and the control for that means must be guarded to prevent inadvertent operation.

**Shafting critical speed (Same as §27.931)**

- (a) The critical speeds of any shafting must be determined by demonstration except that analytical methods may be used if reliable methods of analysis are available for the particular design.
- (b) If any critical speed lies within, or close to, the operating ranges for idling, power on, and autorotative conditions, the stresses occurring at that speed must be within safe limits. This must be shown by tests.
- (c) If analytical methods are used and show that no critical speed lies within the permissible operating ranges, the margins between the calculated critical speeds and the limits of the allowable operating ranges must be adequate to allow for possible variations between the computed and actual values.

**Shafting joints (Same as §27.935)**

Each universal joint, slip joint, and other shafting joints whose lubrication is necessary for operation must have provision for lubrication.

**Turbine engine operating characteristics (Modified version of §27.939)**

For governor-controlled engines, it must be shown that there exists no hazardous torsional instability of the drive system associated with critical combinations of power, rotational speed, and control displacement.

**Fuel System**

**Fuel tank expansion space (Same as §27.969)**

Each fuel tank or each group of fuel tanks with interconnected vent systems must have an expansion space of not less than 2 percent of the tank capacity. It must be impossible to fill the fuel tank expansion space inadvertently with the rotorcraft in the normal ground attitude.

**Fuel tank filler connection (Modified version of §27.973)**

- (a) Each fuel tank filler connection must prevent the entrance of fuel into any part of the rotorcraft other than the tank itself during

normal operations. In addition—

- (1) Each filler must be marked as prescribed in §27.1557;
- (2) Each recessed filler connection that can retain any appreciable quantity of fuel must have a drain that discharges clear of the entire rotorcraft; and
- (3) Each filler cap must provide a fuel-tight seal under the fluid pressure expected in normal operation.

(b) Each filler cap or filler cap cover must warn when the cap is not fully locked or seated on the filler connection.

**Fuel tank vents (Modified version of §27.975)**

(a) Each fuel tank must be vented from the top part of the expansion space so that venting is effective under all normal flight conditions. Each vent must minimize the probability of stoppage by dirt or ice.

(b) The venting system must be designed to minimize spillage of fuel through the vents to an ignition source in the event of a rollover during landing or ground operation.

**Oil System**

**Transmission and gearboxes (Modified version of §27.1027)**

The lubrication system for components of the rotor drive system that require continuous lubrication must be sufficiently independent of the lubrication systems of the engine(s) to ensure lubrication during autorotation.

**Subpart F—Equipment**

**General**

**Function and Installation (Modified version of §27.1301)**

Each item of installed equipment, whose failure could adversely affect safety, must—

- (a) Be of a kind and design appropriate to its intended function;
- (b) Be labeled as to its identification, function, or operating limitations, or any applicable combination of these factors;
- (c) Be installed according to limitations specified for that equipment; and
- (d) Function properly when installed.

**Flight and navigation instruments (Modified version of §27.1303)**

The applicant must demonstrate that sufficient information is provided to the pilot to monitor and control the flight path of the rotorcraft within the approved operational envelope and operational (containment) volume. Considerations should include, but are not limited to the following flight and navigation instruments:

- (a) An airspeed indicator.
- (b) An altimeter.
- (c) A magnetic direction indicator.
- (d) A vehicle position indicator.
- (e) A vehicle health status indicator.

**Powerplant limitations (Modified version of §27.1305)**

The applicant must demonstrate that sufficient information is provided to the pilot to monitor the powerplant to avoid failures that adversely affect safety. Considerations should include, but are not limited to the following for all engines, tanks, and pumps:

- (a) Oil temperature, pressure, and quantity.
- (b) Rotor and engine r.p.m.
- (c) Gas temperature.
- (d) Ferromagnetic particle detection.

**Miscellaneous equipment (Modified version of §27.1307)**

The following is required miscellaneous equipment if its failure could adversely affect safety:

- (a) A master switch arrangement.
- (b) An adequate source of electrical energy, where electrical energy is necessary for operation of the rotorcraft.
- (c) Electrical protective devices for those items with safety effects.

**Equipment, systems, and installations (Modified version of §27.1309)**

(a) The equipment, systems, and installations whose functioning is required by this set of requirements must be designed and installed to ensure that they perform their intended functions under any foreseeable operating condition.

(b) The equipment, systems, and installations of a multiengine rotorcraft must be designed to prevent hazards to the rotorcraft in the event of a probable malfunction or failure.

(c) The equipment, systems, and installations of single-engine rotorcraft must be designed to minimize hazards in the event of a probable malfunction or failure.

**High-intensity Radiated Fields Protection (Modified version of §27.1317)**

Each electrical and electronic system that performs a function whose failure could adversely affect safety must be designed and installed so that they comply with HIRF considerations (to be determined and recorded in Appendix B) determined to affect UAS.

#### **Instruments: Installation**

##### **Arrangement and visibility (Modified version of §27.1321)**

- (a) Each flight, navigation, and powerplant instrument required for the pilot in command must be easily visible to him.
- (b) For each multiengine rotorcraft, identical powerplant instruments must be located so as to prevent confusion as to which engine each instrument relates.
- (c) If a visual indicator is provided to indicate malfunction of an instrument or system, that indicator must be effective under all probable operating conditions.

##### **Warning, caution, and advisory lights (Modified version of §27.1322)**

If warning, caution or advisory lights required by the type design are installed in the ground control station, they must, unless otherwise approved by the Administrator, be—

- (a) Red, for warning lights (lights indicating a hazard which may require immediate corrective action);
- (b) Amber, for caution lights (lights indicating the possible need for future corrective action);
- (c) Green, for safe operation lights; and
- (d) Any other color, including white, for lights not described in paragraphs (a) through (c) of this section, provided the color differs sufficiently from the colors prescribed in paragraphs (a) through (c) of this section to avoid possible confusion.

##### **Static pressure systems (Modified version of §27.1325)**

If a static system is used in a safety-critical function,

- (a) Each instrument with a static air sensor must be vented so that the influence of rotorcraft speed, airflow variation, and moisture or other foreign matter does not seriously affect its accuracy.
- (b) Each static pressure port must be designed and located in such manner that the correlation between air pressure in the static pressure system and true ambient atmospheric static pressure is not altered when the rotorcraft encounters icing conditions. An anti-icing means or an alternate source of static pressure may be used in showing compliance with this requirement.

##### **Magnetic direction indicator (Modified version of §27.1327)**

If a magnetic direction indicator is included in the type design, then

- (a) Except as provided in paragraph (b) of this section—
  - (1) Each magnetic direction indicator must be installed so that its accuracy is not excessively affected by the rotorcraft's vibration or magnetic fields; and
  - (2) The compensated installation may not have a deviation, in level flight, greater than 10 degrees on any heading.
- (b) A magnetic nonstabilized direction indicator may deviate more than 10 degrees due to the operation of electrically powered systems such as electrically heated windshields if either a magnetic stabilized direction indicator, which does not have a deviation in level flight greater than 10 degrees on any heading, or a gyroscopic direction indicator, is installed. Deviations of a magnetic nonstabilized direction indicator of more than 10 degrees must be placarded.

##### **Automatic pilot system (Modified version of §27.1329)**

The system must be designed and adjusted so that, within the range of adjustment available to the pilot, it cannot produce hazardous loads on the rotorcraft or create hazardous deviations in the flight path under any flight condition appropriate to its use.

#### **Electrical Systems and Equipment**

##### **General (Modified version of §27.1351)**

- (a) Electrical system capacity. Electrical equipment whose failure could adversely affect safety must be adequate for its intended use. In addition—
  - (1) Electric power sources, their transmission cables, and their associated control and protective devices must be able to furnish the required power at the proper voltage to each load circuit essential for safe operation; and
  - (2) Compliance with paragraph (a)(1) of this section must be shown by an electrical load analysis, or by electrical measurements that take into account the electrical loads applied to the electrical system, in probable combinations and for probable durations.
- (b) Function. For each safety-critical electrical system, the following apply:
  - (1) Each system, when installed, must be—
    - (i) Free from hazards in itself, in its method of operation, and in its effects on other parts of the rotorcraft; and
    - (ii) Protected from fuel, oil, water, other detrimental substances, and mechanical damage.
  - (2) Electric power sources must function properly when connected in combination or independently.
  - (3) No failure or malfunction of any source may impair the ability of any remaining source to supply load circuits essential for safe operation.
  - (4) Each electric power source control must allow the independent operation of each source.

- (c) Instruments. There must be means to monitor the electric power system quantities essential for safe operation of the system.
- (d) External power. If provisions are made for connecting external power to the rotorcraft, and that external power can be electrically connected to equipment other than that used for engine starting, means must be provided to ensure that no external power supply having a reverse polarity, or a reverse phase sequence, can supply power to the rotorcraft's electrical system.

**Storage battery design and installation (Modified version of §27.1353)**

For equipment whose failure could adversely affect safety:

- (a) Each storage battery must be designed and installed as prescribed in this section.
- (b) Safe cell temperatures and pressures must be maintained during any probable charging and discharging condition. No uncontrolled increase in cell temperature may result when the battery is recharged (after previous complete discharge)—
  - (1) At maximum regulated voltage or power;
  - (2) During a flight of maximum duration; and
  - (3) Under the most adverse cooling condition likely to occur in service.
- (c) Compliance with paragraph (b) of this section must be shown by test unless experience with similar batteries and installations has shown that maintaining safe cell temperatures and pressures presents no problem.
- (d) No explosive or toxic gases emitted by any battery in normal operation, or as the result of any probable malfunction in the charging system or battery installation, may accumulate in hazardous quantities within the rotorcraft.
- (e) No corrosive fluids or gases that may escape from the battery may damage surrounding structures or adjacent essential equipment.
- (f) Each nickel cadmium battery installation capable of being used to start an engine or auxiliary power unit must have provisions to prevent any hazardous effect on structure or essential systems that may be caused by the maximum amount of heat the battery can generate during a short circuit of the battery or of its individual cells.
- (g) Nickel cadmium battery installations capable of being used to start an engine or auxiliary power unit must have—
  - (1) A system to control the charging rate of the battery automatically so as to prevent battery overheating;
  - (2) A battery temperature sensing and over-temperature warning system with a means for disconnecting the battery from its charging source in the event of an over-temperature condition; or
  - (3) A battery failure sensing and warning system with a means for disconnecting the battery from its charging source in the event of battery failure.

**Circuit protective devices (Modified version of §27.1357)**

For equipment whose failure could adversely affect safety:

- (a) Protective devices, such as fuses or circuit breakers, must be installed in each electrical circuit other than—
  - (1) The main circuits of starter motors; and
  - (2) Circuits in which no hazard is presented by the omission of protective devices.
- (b) A protective device for a circuit essential to flight safety may not be used to protect any other circuit.
- (c) Each resettable circuit protective device (“trip free” device in which the tripping mechanism cannot be overridden by the operating control) must be designed so that—
  - (1) A manual operation is required to restore service after tripping; and
  - (2) If an overload or circuit fault exists, the device will open the circuit regardless of the position of the operating control.
- (d) If the ability to reset a circuit breaker or replace a fuse is essential to safety in flight, that circuit breaker or fuse must be located and identified so that it can be readily reset or replaced in flight.
- (e) If fuses are used, there must be one spare of each rating, or 50 percent spare fuses of each rating, whichever is greater.

**Master switch (Modified version of §27.1361)**

For equipment whose failure could adversely affect safety:

- (a) There must be a master switch arrangement to allow ready disconnection of each electric power source from the main bus. The point of disconnection must be adjacent to the sources controlled by the switch.
- (b) Load circuits may be connected so that they remain energized after the switch is opened, if they are protected by circuit protective devices, rated at five amperes or less, adjacent to the electric power source.
- (c) The master switch or its controls must be installed so that the switch is easily discernible and accessible to a crewmember.

**Electric cables (Modified version of §27.1365)**

For equipment whose failure could adversely affect safety:

- (a) Each electric connecting cable must be of adequate capacity.
- (b) Each cable that would overheat in the event of circuit overload or fault must be at least flame resistant and may not emit dangerous quantities of toxic fumes.
- (c) Insulation on electrical wire and cable installed in the rotorcraft must be self-extinguishing when tested.

**Switches (Modified version of §27.1367)**

For equipment whose failure could adversely affect safety:

Each switch must be—

- (a) Able to carry its rated current;
- (b) Accessible to the crew; and
- (c) Labeled as to operation and the circuit controlled.

**Lights**

**Instrument lights (Modified version of §27.1381)**

For each display or other presentation of data required for systems whose failure adversely affects safety, that display or presentation must—

- (a) Make each relevant device, display, or presentation easily readable; and
- (b) Be installed so that no objectionable reflections or illumination levels render required data unintelligible to the pilot in normal operations.

**Landing lights and supplemental lighting for night operations (Modified version of §27.1383)**

Each landing or hovering light or supplemental ground or airborne light required for approved night rotorcraft operations must be approved.

**Color specifications (Same as §27.1397)**

Each position light color must have the applicable International Commission on Illumination chromaticity coordinates as follows:

- (a) Aviation red—
  - $y$  is not greater than 0.335; and
  - $z$  is not greater than 0.002.
- (b) Aviation green—
  - $x$  is not greater than  $0.440 - 0.320y$ ;
  - $x$  is not greater than  $y - 0.170$ ; and
  - $y$  is not less than  $0.390 - 0.170x$ .
- (c) Aviation white—
  - $x$  is not less than 0.300 and not greater than 0.540;
  - $y$  is not less than  $x - 0.040$  or  $y_c - 0.010$ , whichever is the smaller; and
  - $y$  is not greater than  $x + 0.020$  nor  $0.636 - 0.400x$ ;

Where  $y_c$  is the  $y$  coordinate of the Planckian radiator for the value of  $x$  considered.

**Riding light (Modified version of §27.1399)**

- (a) Each riding light required for water operation must be installed so that it can—
  - (1) Show a white light, appropriate for safe operations, at night under clear atmospheric conditions; and
  - (2) Show a maximum practicable unbroken light with the rotorcraft on the water.
- (b) Externally hung lights may be used.

**Anticollision light system (Modified version of §27.1401)**

- (a) General. If certification for night operation is requested, the rotorcraft must have an anticollision light system that—
  - (1) Consists of one or more approved anticollision lights located so that their emitted light will not impair the crew's vision or detract from the conspicuity of the position lights; and
  - (2) Meets the requirements of paragraphs (b) through (f) of this section.
- (b) Field of coverage. The system must consist of enough lights to illuminate the vital areas around the rotorcraft, considering the physical configuration and flight characteristics of the rotorcraft. The field of coverage must extend in each direction within at least 30 degrees below the horizontal plane of the rotorcraft, except that there may be solid angles of obstructed visibility totaling not more than 0.5 steradians.
- (c) Flashing characteristics. The arrangement of the system, that is, the number of light sources, beam width, speed of rotation, and other characteristics, must give an effective flash frequency of not less than 40, nor more than 100, cycles per minute. The effective flash frequency is the frequency at which the rotorcraft's complete anticollision light system is observed from a distance, and applies to each sector of light including any overlaps that exist when the system consists of more than one light source. In overlaps, flash frequencies may exceed 100, but not 180, cycles per minute.
- (d) Color. Each anticollision light must be aviation red and must meet the applicable requirements of §27.1397.
- (e) Light intensity. The minimum light intensities in any vertical plane, measured with the red filter (if used) and expressed in terms of “effective” intensities, must meet the requirements of paragraph (f) of this section. The following relation must be assumed:

$$I_e = \frac{\int_{t_1}^{t_2} I(t) dt}{0.2 + (t_2 - t_1)}$$

View or download PDF

where:

$I_e$ =effective intensity (candles).

$I(t)$ =instantaneous intensity as a function of time.

$t_2-t_1$ =flash time interval (seconds).

Normally, the maximum value of effective intensity is obtained when  $t_2$  and  $t_1$  are chosen so that the effective intensity is equal to the instantaneous intensity at  $t_2$  and  $t_1$ .

(f) Minimum effective intensities for anticollision light. Each anticollision light effective intensity must equal or exceed the applicable values in the following table:

Angle above or below the horizontal plane	Effective intensity (candles)
0° to 5°	150
5° to 10°	90
10° to 20°	30
20° to 30°	15

(g) A means must be provided to activate or deactivate the anticollision lights in any flight phase.

### Safety Equipment

#### General (Modified version of §27.1411)

(a) Required safety equipment to be used by the crew in an emergency must be readily accessible.

#### Flight data recorders (Modified version of §27.1459)

Each flight recorder required by the operating approval associated with the vehicle specified in this type design must meet the data recording requirements specified by the Administrator.

#### Equipment containing high energy rotors (Modified version of §27.1461)

- (a) Equipment whose failure adversely affects safety and contains high energy rotors must meet paragraph (b), (c), or (d) of this section.
- (b) High energy rotors contained in equipment must be able to withstand damage caused by malfunctions, vibration, abnormal speeds, and abnormal temperatures. In addition—
- (1) Auxiliary rotor cases must be able to contain damage relevant to Paragraph (a) of this section and caused by the failure of high energy rotor blades; and
  - (2) Equipment control devices, systems, and instrumentation must reasonably ensure that no operating limitations affecting the integrity of high energy rotors will be exceeded in service.
- (c) It must be shown by test that equipment containing high energy rotors can, without directly causing one or more of the failure conditions addressed in Paragraph (a) of this section, contain any failure of a high energy rotor that occurs at the highest speed obtainable with the normal speed control devices inoperative.
- (d) Equipment containing high energy rotors must be located where rotor failure will not adversely affect continued safe flight.

### Subpart G—Operating Limitations and Information

#### General (Modified version of §27.1501)

Each operating limitation required by the Administrator and other limitations and information necessary for safe operation must be established and made available to the crewmembers.

### Operating Limitations

#### Airspeed limitations: general (Same as §27.1503)

- (a) An operating speed range must be established.
- (b) When airspeed limitations are a function of weight, weight distribution, altitude, rotor speed, power, or other factors, airspeed limitations corresponding with the critical combinations of these factors must be established.

#### Never-exceed speed (Modified version of §27.1505)

The never-exceed speed,  $V_{NE}$ , must be established.

#### Minimum crew (Modified version of §27.1523)

The minimum crew must be established so that it is sufficient for safe operation, considering—

- (a) The workload on and safety roles of individual crewmembers; and
- (b) The kinds of operation authorized under §27.1525.

<p><b>Kinds of operations (Modified version of §27.1525)</b> The kinds of operations (such as VLOS, BVLOS, VFR, IFR, day, night, or icing) for which the UAS is approved are established by demonstrated compliance with the applicable certification requirements and by the installed equipment.</p>
<p><b>Maximum operating altitude (Modified version of §27.1527)</b> The maximum altitude up to which operation is allowed, as limited by flight, structural, powerplant, functional, safety, or equipment characteristics, must be established.</p>
<p><b>Instructions for Continued Airworthiness (Same as §27.1529)</b> The applicant must prepare Instructions for Continued Airworthiness in accordance with appendix A to this part that are acceptable to the Administrator. The instructions may be incomplete at type certification if a program exists to ensure their completion prior to delivery of the first rotorcraft or issuance of a standard certificate of airworthiness, whichever occurs later.</p>
<p><b>Markings and Placards</b></p>
<p><b>General (Modified version of §27.1541)</b> (a) The UAS must contain—  (1) The markings and placards specified in this set of requirements, and  (2) Any additional information, instrument markings, and placards required for the safe operation of UAS with unusual design, operating or handling characteristics.  (b) Each marking and placard prescribed in paragraph (a) of this section—  (1) Must be displayed in a conspicuous place; and  (2) May not be easily erased, disfigured, or obscured.</p>
<p><b>Control markings (Modified version of §27.1555)</b> Each emergency control must be red and must be marked as to method of operation.</p>
<p><b>Miscellaneous markings and placards (Modified version of §27.1557)</b> (a) Payload, cargo compartments, and ballast location. Each payload and cargo compartment and each ballast location must have a placard stating any limitations on contents, including weight, that are necessary under the loading requirements.  (b) Fuel and oil filler openings. The following apply:  (1) Fuel filler openings must be marked at or near the filler cover with—  (i) The word “fuel”;  (ii) For reciprocating engine powered rotorcraft, the minimum fuel grade;  (iii) For turbine engine powered rotorcraft, the permissible fuel designations; and  (iv) For pressure fueling systems, the maximum permissible fueling supply pressure and the maximum permissible defueling pressure.  (2) Oil filler openings must be marked at or near the filler cover with the word “oil”.</p>
<p><b>Limitations placard (Modified version of §27.1559)</b> There must be a placard in clear view of the pilot that specifies the kinds of operations (such as VLOS, BVLOS, VFR, IFR, day, night, or icing) for which the UAS is approved.</p>
<p><b>Safety equipment (Modified version of §27.1561)</b> (a) Each required safety equipment control to be operated by the crew in emergency must be plainly marked as to its method of operation.  (b) Each location, such as a locker or compartment, that carries any fire extinguishing, signaling, or other life saving equipment, must be so marked.</p>
<p><b>Tail Rotor (Same as §27.1565)</b> Each tail rotor must be marked so that its disc is conspicuous under normal daylight ground conditions.</p>
<p><b>Rotorcraft Flight Manual and Approved Manual Material</b></p>
<p><b>General (Modified version of §27.1581)</b> (a) Furnishing information. A Rotorcraft Flight Manual must be furnished with each rotorcraft, and it must contain the following:  (1) Information required for UAS functions whose failure could adversely affect safety, and  (2) Other information that is necessary for safe operation because of design, operating, or handling characteristics.  (b) Approved information. Each part of the manual that is furnished, verified, and approved under its associated type certificate, must be segregated, identified, and clearly distinguished from each unapproved part of that manual.  (c) Table of contents. Each Rotorcraft Flight Manual must include a table of contents if the complexity of the manual indicates a need for it.</p>
<p><b>Operating Limitations (Modified version of §27.1583)</b></p>



A Rotorcraft Flight Manual must contain operating limitations for each of the following, as relevant to safety-critical functions, including, but not limited to:

- (a) Airspeed and rotor limitations—must be furnished. The significance of each limitation must be explained.
- (b) Powerplant limitations. The following information must be furnished:
  - (1) Limitations necessary to maintain powerplant and rotor system integrity.
  - (2) Explanation of the limitations, when appropriate.
- (c) Weight and loading distribution. The weight and center of gravity limits must be furnished. If the variety of possible loading conditions warrants, instructions must be included to allow ready observance of the limitations specifically for takeoffs.
- (d) UAS crew. When a crew of more than one is required, the number and functions of the minimum crew determined under §27.1523 must be furnished.
- (e) Kinds of operation. Each kind of operation for which the rotorcraft and its equipment installations are approved must be listed.
- (f) Altitude. The altitude established under §27.1527 and an explanation of the limiting factors must be furnished.

**Operating procedures (Modified version of §27.1585)**

- (a) Parts of the manual containing operating procedures must have information concerning any normal and emergency procedures and other information necessary for safe operation, including takeoff and landing procedures. The manual must contain any pertinent information including—
  - (1) The kind of takeoff surface used in the tests and each appropriate climbout speed; and
  - (2) The kind of landing surface used in the tests and appropriate approach and glide airspeeds.
- (b) For each rotorcraft showing compliance with §27.1353 (g)(2) or (g)(3), the operating procedures for disconnecting the battery from its charging source must be furnished.
- (c) Information on the total quantity of usable fuel for each fuel tank must be furnished.

**Appendix A—Instructions for Continued Airworthiness**

**General (Modified version of A§27.1)**

- (a) This appendix specifies requirements for the preparation of Instructions for Continued Airworthiness as required by §27.1529.
- (b) The Instructions for Continued Airworthiness for each UAS must include the Instructions for Continued Airworthiness for each engine and rotor (hereinafter designated ‘products’), for each appliance required by this chapter, and any required information relating to the interface of those appliances and products with the UAS. If Instructions for Continued Airworthiness are not supplied by the manufacturer of an appliance or product installed in the UAS, the Instructions for Continued Airworthiness for the UAS must include the information essential to the continued airworthiness of the UAS.
- (c) The applicant must submit to the FAA a program to show how changes to the Instructions for Continued Airworthiness made by the applicant or by the manufacturers of products and appliances installed in the UAS will be distributed

**Format (Same as A§27.2)**

- (a) The Instructions for Continued Airworthiness must be in the form of a manual or manuals as appropriate for the quantity of data to be provided.
- (b) The format of the manual or manuals must provide for a practical arrangement.

**Content (Modified version of A§27.3)**

The contents of the manual or manuals must be prepared in the English language. The Instructions for Continued Airworthiness must contain the following manuals or sections, as appropriate, and information:

- (a) UAS maintenance manual or section.
  - (1) Introduction information that includes an explanation of the UAS’s features and data to the extent necessary for maintenance or preventive maintenance.
  - (2) A description of the UAS and its systems and installations including its engines, rotors, and appliances.
  - (3) Basic control and operation information describing how the UAS components and systems are controlled and how they operate, including any special procedures and limitations that apply.
  - (4) Servicing information that covers details regarding servicing points, capacities of tanks, reservoirs, types of fluids to be used, pressures applicable to the various systems, location of access panels for inspection and servicing, locations of lubrication points, the lubricants to be used, equipment required for servicing, tow instructions and limitations, mooring, jacking, and leveling information.
- (b) Maintenance instructions.
  - (1) Scheduling information for each part of the UAS and its engines, auxiliary power units, rotors, accessories, instruments and equipment that provides the recommended periods at which they should be cleaned, inspected, adjusted, tested, and lubricated, and the degree of inspection, the applicable wear tolerances, and work recommended at these periods. However, the applicant may refer to an accessory, instrument, or equipment manufacturer as the source of this information if the applicant shows the item has an exceptionally high degree of complexity requiring specialized maintenance techniques, test equipment, or expertise. The recommended overhaul periods and necessary cross references to the Airworthiness Limitations section of the manual must also be included. In addition, the applicant must include an inspection program that includes the

- frequency and extent of the inspections necessary to provide for the continued airworthiness of the UAS.
- (2) Troubleshooting information describing problem malfunctions, how to recognize those malfunctions, and the remedial action for those malfunctions.
  - (3) Information describing the order and method of removing and replacing products and parts with any necessary precautions to be taken.
  - (4) Other general procedural instructions including procedures for system testing during ground running, symmetry checks, weighing and determining the center of gravity, lifting and shoring, and storage limitations.
- (c) Diagrams of structural access plates and information needed to gain access for inspections when access plates are not provided.
  - (d) Details for the application of special inspection techniques including radiographic and ultrasonic testing where such processes are specified.
  - (e) Information needed to apply protective treatments to the structure after inspection.
  - (f) All data relative to structural fasteners such as identification, discarded recommendations, and torque values.
  - (g) A list of special tools needed.

**Airworthiness Limitations section (Same as A§27.4)**

The Instructions for Continued Airworthiness must contain a section, titled Airworthiness Limitations that is segregated and clearly distinguishable from the rest of the document. This section must set forth each mandatory replacement time, structural inspection interval, and related structural inspection procedure required for type certification. If the Instructions for Continued Airworthiness consist of multiple documents, the section required by this paragraph must be included in the principal manual. This section must contain a legible statement in a prominent location that reads: “The Airworthiness Limitations section is FAA approved and specifies inspections and other maintenance required under §43.16 and §91.403 of the Federal Aviation Regulations unless an alternative program has been FAA approved.”

**Appendix B— HIRF Environments and Equipment HIRF Test Levels**

**HIRF Environments and Equipment HIRF Test Levels (Modified version of Part 27 Appendix D)**

This appendix specifies the HIRF environments and equipment HIRF test levels for electrical and electronic systems under §27.1317. The field strength values for the HIRF environments and laboratory equipment HIRF test levels must be established.

**Suggested Requirements Abstracted from FAR Part 27**

**Design characteristics for autopilot control (New Suggested Requirement)**

The applicant must establish stability, controllability, and maneuverability design margins that prevent

- (a) contact of the vehicle rotors with the ground, other parts of the vehicle structure, or obstacles in normal and non-normal operations and
- (b) any other condition that could compromise rotor system integrity, resulting in the ejection of high energy parts in flight.
- (c) The applicant must demonstrate that the proposed control system design and installation meets or exceeds these requirements. Considerations include but are not limited to the following:
  - (1) critical values of design parameters including weight, center of gravity, rotor speed, speed, density altitude, and height-speed envelope,
  - (2) normal operations such as takeoff, landing, and cargo attachment and removal (possibly in flight), as well as critical values of operational parameters such as winds (both steady and gusts), temperatures, terrain slopes, etc. for which operational approval is sought, and
  - (3) non-normal operations such as autorotation, unintended cargo shift or release, and contingency maneuvers.

Note: the following requirements from Part 27 may be relevant: §27.25, §27.27, §27.33, §27.51, §27.71, §27.75, §27.87, §27.141, §27.143, §27.151, §27.173, §27.175, §27.177, §27.231, §27.321, §27.337, §27.671, §27.672, §27.735, §27.1151(a) only, §27.1323, §27.1419, §27.1519, §27.1545, §27.1587, and §27.1589.

**Ancillary support systems for controllability, maneuverability, and stability (New Suggested Requirement)**

The applicant must ensure that flight control commands from all sources (stability augmentation system, autopilot, control station, etc.) are passed to the appropriate flight control surfaces without hazardous flexure, slop, friction, jamming, interference or other hazards that would lead to loss of rotor system integrity. Considerations include but are not limited to the following:

- (a) electrical and mechanical aspects of the control system, and includes control of engines, rotor brakes, and other elements of the design that involve automated or remote operation of the vehicle controls,
- (b) normal operational conditions, such as those encountered during takeoff, landing, and cargo attachment and removal (possibly in flight), and
- (c) non-normal operational conditions that may reasonably be expected in service.

Note: the following requirements from Part 27 may be relevant: §27.307, §27.309, §27.391, §27.395, §27.605, §27.607, §27.621, §27.623, §27.625, §27.671, §27.675, §27.679, §27.681, §27.683, §27.685, §27.687, and §27.695.

**Design characteristics for structural integrity (New Suggested Requirement)**

- (a) The applicant must establish design, inspection, fabrication, and materials requirements, safety margins, and limitations of the

structure of the rotor, hub, and drive systems to prevent in-flight loss of rotor system integrity. Considerations should include

- (1) any secondary structure whose failure could adversely affect the rotor system,, and
- (2) primary load paths and supporting structure affecting the rotor system.

(b) The design, safety margins, and limitations should cover all conditions likely to be encountered in normal and non-normal operations.

(c) Design considerations include but are not limited to static analysis, dynamic analysis, and fatigue analysis and testing at critical conditions of weight, center of gravity, engine/rotor speed, engine/rotor torque, ground resonance, and any other safety-critical conditions.

Note: the following requirements from Part 27 may be relevant: §27.25, §27.27, §27.33, §27.51, §27.75, §27.87, §27.141, §27.251, §27.307, §27.309, §27.321, §27.337, §27.361, §27.391, §27.547, §27.549, §27.571, §27.573, §27.605, §27.613, §27.621, §27.623, §27.625, §27.653, §27.659, §27.661, §27.663, §27.681, §27.927, §27.1151 (a only), §27.1193, §27.1323, §27.1419, §27.1509, and §27.1545.

#### **Powerplant explosion prevention (New Suggested Requirement)**

The rotorcraft powerplant, powerplant installation, and associated systems (e.g., fuel, oil, ventilation, exhaust, and air induction systems), including relevant elements of the ground support equipment, must be designed to prevent in-flight explosion or release of high energy parts that could cause serious injury. Considerations include, but are not limited to:

- (a) showing by analysis or test that the probability of releasing high energy parts that could cause injury is minimized, and
- (b) providing supplemental protection to the ground crew during servicing and inspection of the rotorcraft for preflight, post-flight, and thru-flight servicing (e.g., loading and unloading cargo).

Note: the following requirements from Part 27 may be relevant: §27.963, §27.965, §27.967, §27.993, §27.995, §27.997(c) only, §27.999(b)(2) only, §27.1013, §27.1015, §27.1017, §27.1021, §27.1041, §27.1091, §27.1121, §27.1123, §27.1141(d) and (e) only, §27.1163, §27.1183, §27.1185, §27.1187, §27.1189, §27.1191, §27.1193, §27.1337, and §27.1521.

#### **Suggested Requirements for Novel UAS Technologies**

##### **Containment in a designated operational volume (New Suggested Requirement)**

A means to detect and avoid transgression of any containment boundaries (or boundaries of a designated operational volume) must be designed and installed on the vehicle. This includes the following considerations:

- (a) The accuracy of the estimation of the unmanned aircraft's position relative to the containment boundaries must be sufficient to ensure that the aircraft will not exit a containment boundary.
- (b) Situational awareness of the unmanned aircraft's location relative to the containment boundaries should be maintained at all times during all flight operations.
- (c) Failure of infrastructure not part of the UAS (e.g., GPS, cellular telephone) must not significantly interfere with the determination of the location of the unmanned aircraft for purposes of containment.
- (d) Means of detection should:
  - (1) have complete and unobstructed surveillance of any established containment boundaries, at all times during all flight operations in all weather conditions (e.g., lighting and visibility conditions) for which operations are approved; and
  - (2) be able to determine impending violations of any established boundary, in sufficient time for action to avoid crossing the boundary.
- (e) If action by the pilot in command is required to ensure the unmanned aircraft does not cross any established containment boundary, quick acting means must be provided to alert the pilot in command.
  - (1) Timing thresholds for alerts should consider the time needed (i) to transmit data via radios or other means of communication, (ii) for ground control station processing and annunciation, and (iii) for human response, as relevant.
- (f) Means of avoidance must be sufficient to ensure the aircraft remains within the established containment boundaries at all times.
  - (1) Latency and availability of any command and control datalink or other communication links required for avoidance should be considered in establishing timing thresholds for avoidance maneuvers and shown to be acceptable for ensuring an avoidance maneuver can be executed to maintain containment.
  - (2) Activation of an avoidance maneuver from on board the aircraft must be communicated to the pilot in command in a timely manner.
  - (3) Confirmation of the completion of any avoidance maneuver must be communicated to the pilot in command in a timely manner.
- (g) The containment system design must consider events wherein release of high energy parts may constitute a hazard to bystanders outside the containment area.
- (h) The performance of the containment system must not be degraded by any form of interference under any foreseeable operating condition. Considerations should include, but are not limited to:
  - (1) electromagnetic interference caused by any other unmanned aircraft systems,
  - (2) electromagnetic interference external to the aircraft, and
  - (3) interference via acoustic, thermal, vibrational, chemical, or metallurgical means.

##### **Detect and avoid intruder aircraft (New Suggested Requirement)**

A means to detect and avoid other aircraft that may intrude on the containment or designated operational volume or otherwise pose a threat to loss of separation with the unmanned aircraft shall be provided.

- (a) Means of detecting other aircraft will:
  - (1) be able to detect other airborne vehicles
    - (i) at a sufficient range beyond the operational volume to allow time for an avoidance maneuver. Range considerations may include, but are not limited to, environment and topology, characteristics of the aircraft fleets at surrounding airports, and radar characteristics
    - (ii) with sufficient accuracy to ensure safe separation is maintained;
  - (2) have complete and unobstructed coverage of the containment volume, and
  - (3) be active at all times during all flight operations in all weather, lighting, and visibility conditions for which operations are approved.
- (b) If action by the pilot in command is required to avoid loss of separation with an airborne vehicle, quick acting means must be provided to alert the pilot in command.
  - (1) Timing thresholds for alerts should consider the time needed
    - (i) to transmit data via radios or other means of communication,
    - (ii) for ground control station processing and annunciation, and
    - (iii) for human response, as relevant.
- (c) Means of avoidance must be sufficient to ensure the UA maintains sufficient separation from other aircraft at all times.
  - (1) Latency and availability of any command and control datalink or other communication links required for avoidance should be considered in establishing timing thresholds for avoidance maneuvers and shown to be acceptable for ensuring an avoidance maneuver can be executed to maintain separation.
  - (2) The avoidance maneuver must maintain separation from all other aircraft throughout its execution duration.
  - (3) Confirmation of any avoidance maneuver must be communicated to the pilot in command.
  - (4) Clearance distances from containment boundaries should be established and maintained for avoidance maneuvers to avoid harm to persons on the ground.
  - (5) Normal operations may only resume when the UA is well clear of all other aircraft.
- (d) The performance of the aircraft detection and avoidance system must not be degraded by any form of interference under any foreseeable operating conditions. Considerations include, but are not limited to:
  - (1) electromagnetic interference caused by any other UA systems,
  - (2) electromagnetic interference external to the UA, and
  - (3) interference via acoustic, thermal, vibrational, chemical or metallurgical means.

**Detect and avoid ground-based obstacles (New Suggested Requirement)**

The applicant must provide a means to detect and avoid persons and objects within the containment or designated operational volume during flight operations.

- (a) Means of detection will:
  - (1) have sufficient range in the direction of UA travel to permit a simple avoidance maneuver (e.g., hovering or landing), and
  - (2) provide detection during all flight operations in all weather, lighting, and visibility conditions for which operations are approved.
- (b) If action by the pilot in command is required to avoid collision or remain a safe distance from persons or objects to prevent harm, quick acting means will be provided to alert the pilot in command.
  - (1) Timing thresholds for alerts should consider the time needed (i) to transmit data via radios or other means of communication, (ii) for ground control station processing and annunciation, and (iii) for human response, as relevant.
- (c) Means to suspend operation or provide an otherwise safe state shall be provided.
  - (1) Latency and availability of any command and control datalink or other communication links required for avoidance should be considered in establishing timing thresholds for avoidance maneuvers and shown to be acceptable.
  - (2) Minimum clearances should be established.
  - (3) Confirmation of any avoidance maneuver should be communicated to the pilot in command in a timely manner.
  - (4) Normal operations may only resume when the situation has been judged to be sufficiently safe to continue the flight path.
- (d) The performance of the detection and avoidance system must not be degraded by any form of interference under any foreseeable operating conditions. Considerations include, but are not limited to:
  - (1) electromagnetic interference caused by any other UA systems,
  - (2) electromagnetic interference external to the UA, and
  - (3) interference via acoustic, thermal, vibrational, chemical or metallurgical means, and
  - (4) environmental conditions (e.g., atmospheric reflection or refraction, light scattering due to water or ice features, etc.).

**Safety-critical command and control (C2) links (New Suggested Requirement)**

The applicant must include at least one safety-critical C2 link for use by the pilot to command the UA to a safe state and for providing safety-critical data from the UA to the pilot. Any datalink referred to below is assumed to be safety-critical.

- (a) The C2 link shall:
  - (1) be available in all vehicle attitudes under all foreseeable operating conditions throughout the containment volume, and
  - (2) enable communication for safety-critical data at all points throughout the entire containment volume.

- (b) Uplink and downlink status shall
  - (1) be indicated to the pilot during all flight operations, and
  - (2) include the status of any intervening communication equipment (e.g., relays, etc.).
- (c) The uplink(s) used to communicate the pilot commands to the UA shall:
  - (3) adhere to appropriate standards of integrity, availability, continuity, reliability, and security (see assumption 3);
  - (4) cause operations to cease if thresholds for latency or for error rates are not met; and
  - (5) be active at all times during all flight operations, including during all weather, lighting, and visibility conditions for which operations are approved.
- (d) The downlink(s) used to communicate safety-critical vehicle information to the pilot in command shall:
  - (1) adhere to standards of integrity, availability, continuity, reliability, and security;
  - (2) meet established standards for error rates; and
  - (3) be capable of communicating data from the UA at all times during all flight operations in all weather, lighting, and visibility conditions for which operations are approved.
- (e) The performance of the C2 link (e.g., availability and quality of service) must not be degraded by any form of interference under any foreseeable operating conditions. Considerations include, but are not limited to:
  - (1) electromagnetic interference caused by any other UA system,
  - (2) electromagnetic interference external to the UA,
  - (3) ionospheric, atmospheric, or rain attenuation,
  - (4) quality of any relay mechanisms, including the guaranteed quality ratio of the signal received to that of the signal propagated, as well as any voting mechanisms used to distinguish between multiple signals (e.g., at the signal distance),
  - (5) passive (random) reflection, groundwave propagation, temperature inversion, refraction through the earth's atmosphere, anomalous and/or multipath propagation, Rayleigh fading and finite absorption,
  - (6) malicious interference/spoofing or link takeover,
  - (7) frequency access scheme, link budget, bandwidth characteristics and frequency assignment planning criteria of the C2 link,
  - (8) adjacent or shared frequencies, and
  - (9) interference related to shared resources (e.g., power).

**Systems and equipment to support pilot and crew safety roles (New Suggested Requirement)**

Equipment intended for crewmembers' use in the operation of the UA must be shown, individually and in combination with other equipment, to be designed so that qualified crewmembers can safely perform their tasks associated with its intended function.

- (a) Equipment to support both the presentation of information and the controls necessary to act on that information in the accomplishment of safety tasks must be provided.
  - (1) Sufficient information and control authority must be provided to monitor and control the flight path of the rotorcraft within the approved operational envelope and operational volume. Considerations should be given to, but are not limited to: an airspeed indicator, an altimeter, a magnetic direction indicator, a vehicle position indicator, and a vehicle health status indicator.
  - (2) Sufficient information and control authority must be provided to monitor and control the powerplant to avoid failures that adversely affect safety. Considerations should be given to, but not limited to, the following for all engines, tanks, and pumps: temperature, pressure, and quantity, rotor and engine r.p.m., and ferromagnetic particle detector.
  - (3) Each means to control the rotorcraft's flight path or associated systems (e.g., waypoint control, return-to-base, etc.) must be accessible and usable by the crew for the intended function with the required urgency.
- (b) Flight controls and information intended for crew use must:
  - (1) Be presented in a clear and unambiguous form, at resolution and precision appropriate to the task.
  - (2) Be accessible and usable by the crew in a manner consistent with the urgency, frequency, and duration of their tasks, and
  - (3) Enable crew awareness, if awareness is required for safe operation, of the effects on the rotorcraft resulting from crew actions.
- (c) Operationally-relevant behavior of the equipment must be:
  - (1) Predictable and unambiguous, and
  - (2) Designed to enable the crew to intervene in a manner appropriate to the task.
- (d) To the extent practicable, equipment must enable the crew to manage errors resulting from the kinds of crew interactions with the equipment that can be reasonably expected in service, assuming the crew is acting in good faith. This subparagraph (d) does not apply to skill-related errors associated with control of the UA.
- (e) Equipment, markings, and lighting to support crewmembers' general situational awareness, such as ground-based area lighting, aural warnings for start-up and landing, etc. must be provided.
- (f) Equipment to effectively support safety-critical communication between crewmembers, if such communication is needed for safe operation, must be provided.

## Appendix C: Assessment of FAR Part 27 Requirements for Unmanned Cargo Delivery

This appendix contains the assessment of each individual Part 27 requirement with respect to inclusion in the set of suggested design and performance requirements for a midrange unmanned rotorcraft used for cargo delivery listed in Table B1.

Table C1 lists each paragraph in Part 27 and indicates whether the requirement (1) applies as written (“as is”), (2) applies with some modification (“modified”), (3) does not apply at all (“excluded”), or (4) whether the requirement is “rolled up” into a less prescriptive, abstract requirement. The full text of all applicable requirements is given. A brief summary is given for all requirements that are not included. Suggested additions to the original text from Part 27 are indicated in ***bold italic face***, and deletions are indicated by striking through the text (e.g., ~~text~~). The suggested text to replace each group of rolled-up requirements is listed under the label “Suggested Requirements Abstracted from FAR Part 27” near the end of the table. The five new requirements suggested to mitigate UAS-specific hazards not covered in Part 27 are listed under the label “Suggested Requirements for Novel UAS Technologies”. Rationale for the disposition of each requirement is given.

Just as with the list of design requirements in Table B2, the contents of C2 should not be considered separate from the UAS characteristics listed in Table B1.

Table C1. Assessment of FAR Part 27 for an Unmanned Rotorcraft with Table B1 Characteristics

<b>14 CFR Part 27, Subpart A—General</b>
<p><b>§27.1 Applicability -- Modified</b></p> <p>(a) This <del>part</del> <b>set of requirements</b> prescribes airworthiness standards for the issue of type certificates, and changes to those certificates, for <b>unmanned normal category</b> rotorcraft with the characteristics given in Table B1 <del>maximum</del> weights of 7,000 pounds or less and nine or less passenger seats.</p> <p>(b) <del>Each person who applies under Part 21 for such a certificate or change must show compliance with the applicable requirements of this part.</del></p> <p>(c) <del>Multiengine rotorcraft may be type certified as Category A provided the requirements referenced in appendix C of this part are met.</del></p> <p><del>Summary: This paragraph describes the types of rotorcraft subject to Part 27</del></p> <p><del>Rationale: (a) is modified to indicate that the requirements specified in this set are only intended to be applicable to those UAS with the characteristics given in Table B1. (b) is deleted because it is out of scope (c) is deleted on the assumption that Category A operations will not be required for a rotorcraft that has no humans onboard and operates in a context where hull loss is acceptable under most conditions.</del></p>
<p><b>§27.2 Special retroactive requirements -- Excluded</b></p> <p><del>Summary: This paragraph describes special considerations for (a) rotorcraft manufactured after Sept 16, 1992 related to seats and (b) type certified prior to October 18, 1999.</del></p> <p><del>Rationale: Not relevant to a UAS. The UAS will not need seats. Furthermore, any vehicle operating under this set of requirements will be certified after October 18, 1999.</del></p>
<b>14 CFR Part 27, Subpart B—Flight</b>
<b>General</b>
<p><b>§27.21 Proof of compliance -- Modified</b></p> <p>Each requirement of this <del>subpart</del> <b>set</b> must be met. <del>at each appropriate combination of weight and center of gravity within the range of loading conditions for which certification is requested. This must be shown</del></p> <p><del>(a) By tests upon a rotorcraft of the type for which certification is requested, or by calculations based on, and equal in accuracy to, the results of testing; and</del></p> <p><del>(b) By systematic investigation of each required combination of weight and center of gravity if compliance cannot be reasonably inferred from combinations investigated.</del></p> <p>Rationale: “Subpart” was changed to “set” because the original subpart, as a whole, is not applicable to UAs with the characteristics given in Table B1. The intent of this paragraph is that requirements included in the set must be verified by testing and analysis of the rotorcraft as applicable. Only those loading conditions that could lead to loss of structural integrity of the rotor system are of concern. The requirement for test and/or analysis for all of the weight and center of gravity combinations called for in Part 27 was simplified because the unmanned rotorcraft has fewer loading conditions that are safety critical. Therefore, language requiring test and/or analysis at all weight/cg combinations was deleted. Furthermore, weight and center of gravity are not the only important parameters that may affect loading conditions. The applicant should determine which parameters, including weight and center of gravity, are critical to structural integrity of the rotor system and demonstrate through test and analysis that the aircraft can handle these parameters with adequate safety margins. Weight and center of gravity are rolled up along with other critical parameters in the requirements proposed for structural integrity (SI) and for controllability, maneuverability, and stability (CMS) in this table under the heading for Suggested Requirements Abstracted from Part 27 for the FARs.</p>

<p><b>§27.25 Weight limits -- Rolled up to suggested CMS(a) &amp; SI requirements</b></p> <p>Summary: This paragraph establishes requirements for determining maximum, minimum, and total weights including jettisonable payloads for manned helicopters.</p> <p>Rationale: Weight, weight distribution, and inflight changes in weight can affect vehicle moments of inertia and control margins, affecting CMS. For a single purpose UAS design, detailed establishment of all of the weights called for in Part 27 might be unnecessary. The suggested CMS(a) requirement specifies that the applicant determine which weight and loading conditions are critical to vehicle CMS and to demonstrate that the vehicle control system can handle these weights with adequate safety margins. These weights also have a direct effect on structural strength requirements for the rotor system, the drive system, and supporting structure. The suggested SI requirement specifies that the applicant determine which weight and loading conditions are critical to vehicle structural requirements, affecting rotor system integrity, and demonstrate that the vehicle design and fabrication can handle these weights with adequate safety margins.</p>
<p><b>§27.27 Center of gravity limits -- Rolled up to the suggested CMS(a) and SI requirements</b></p> <p>Summary: This paragraph requires the applicant to establish various centers of gravity, especially at the extremes (forward, aft, lateral).</p> <p>Rationale: The requirements of this paragraph are reasonable for a UAS design in a restricted operational context as described in Table B1. However, because the requirements are tied to the weights established under §27.25, this paragraph was rolled up with §27.25 into the suggested CMS(a) requirement. The generalized requirement is for the applicant to establish which center of gravity limits are critical and ensure that the vehicle is safely controllable and maneuverable for this range of values. Because the loading on rotors is affected by center of gravity locations and the center of gravity is generally related to the weights established under §27.25, a generalized requirement was included in the suggested SI requirement for the applicant to establish which center of gravity limits are critical and ensure that the vehicle design provides adequate safety margins for this range of values.</p>
<p><b>§27.29 Empty weight and corresponding center of gravity -- Excluded</b></p> <p>Summary: This paragraph requires establishing empty weight and center of gravity used for stability analysis.</p> <p>Rationale: This requirement is not directly relevant to a primary hazard identified in the hazard analysis. Loss of the vehicle within containment is not hazardous. The CMS(a) and SI requirements refer to §27.25, which deals with weight and center of gravity issues that should be sufficient.</p>
<p><b>§27.31 Removable ballast -- Modified</b></p> <p>Removable ballast may be used in showing compliance with the <i>applicable</i> flight requirements of this subpart.</p> <p>Rationale: Ballast may be necessary for some types of UAS operations, e.g., cargo operations.</p>
<p><b>§27.33 Main rotor speed and pitch limits -- Rolled up to the suggested CMS(a) and SI requirements</b></p> <p>Summary: This paragraph requires the applicant to establish main rotor speed and pitch limits used in determining centripetal, bending, and other critical loads applied to the rotors.</p> <p>Rationale: Main rotor speed and pitch limits relate primarily to structural integrity requirements of the rotor system and are rolled up in the suggested SI requirement. However, main rotor speed and pitch limits can also affect CMS considerations at limiting conditions, such as at max gross weights, takeoffs and landings at max slope limits, and at the never exceed speed (<math>V_{NE}</math>). This paragraph was rolled up into the suggested CMS(a) requirement to require the applicant to consider these factors in designing the vehicle control and stabilizations systems.</p>
<p><b>Performance</b></p>
<p><b>§27.45 General -- Excluded</b></p> <p>Summary: This paragraph prescribes how performance requirements are to be interpreted.</p> <p>Rationale: This requirement is not directly relevant to a primary hazard identified in the hazard analysis.</p>
<p><b>§27.49 Performance at minimum operating speed -- Excluded</b></p> <p>Summary: This paragraph requires an applicant to determine performance at minimum operating speed.</p> <p>Rationale: Failure to meet performance criteria at minimum operating speed does not map to a primary hazard for this operational context.</p>
<p><b>§27.51 Takeoff -- Rolled up to the suggested CMS(a) and SI requirements</b></p> <p>Summary: This paragraph establishes minimum requirements for controllability and performance of the vehicle during takeoff with critical values of weight and center of gravity.</p>



Rationale: While the controllability requirement is stated in terms of pilot skill requirements, that are not applicable for the UAS, the requirement that the takeoff not require exceptionally favorable conditions is applicable to the UAS autopilot design. Therefore this requirement was included in the suggested CMS(a) and SI requirements. Subparagraph (b) that requires that the vehicle be capable of a safe landing following an engine failure during the takeoff profile also was deemed applicable but only where the inability to land safely represents a risk to persons or property on the ground. The suggested requirements include language that makes clear that requirements such as this paragraph are only applicable under some circumstances, thus opening the door for operational or other mitigations to the hazards to persons and property on the ground.

**§27.65 Climb: all engines operating -- Excluded**

Summary: This paragraph requires an applicant to establish the steady rate of climb under various conditions.

Rationale: This requirement is not directly relevant to a primary hazard identified in the hazard analysis for this operational context. Note: Requirements for avoiding obstacles are suggested in the novel technologies section of this table under Detect & Avoid Dynamic Obstacles.

**§27.67 Climb: one engine inoperative -- Excluded**

Summary: This paragraph, applicable to multiengine rotorcraft, requires establishing steady rate of climb with one engine out.

Rationale: Documenting engine out performance is not necessary since loss of vehicle is not a safety hazard in this operational context.

**§27.71 Autorotation performance -- Rolled up to the suggested CMS(a) requirement**

Summary: This requires the establishment of the best angle of glide and minimum rate of sink speeds in autorotation for single and certain multiengine rotorcraft.

Rationale: Unsuccessful entry into autorotation would likely result in destruction of the rotor system and release of high energy parts at altitude. Thus, autorotation is included in the suggested CMS(a) requirement as one of the critical conditions that the applicant must identify and mitigate.

**§27.75 Landing -- Rolled up to the suggested CMS(a) and SI requirements**

Summary: This paragraph, similar in intent to paragraph §27.51, requires single and multiengine vehicles be capable of being landed smoothly without exceptional pilot skill or exceptionally favorable conditions during both a normal approach and an autorotative approach.

Rationale: Using the same logic as the takeoff case, the pilot skill requirement does not apply since there is no direct inner loop control by a pilot, but the requirement that a smooth landing be made without exceptionally favorable conditions may be directly applicable to the autopilot design. The general sense of the paragraph was included in the suggested CMS(a) and SI requirements.

**§27.87 Height-speed envelope -- Rolled up to the suggested CMS(a) and SI requirements**

Summary: This paragraph requires that any combinations of height and forward speed for which a safe landing cannot be made must be established for the relevant power failure condition. This limiting condition is sometimes known as the “Dead Man’s Curve”.

Rationale: Engine failure from a height/speed combination that does not allow a successful autorotation would likely result in destruction of the rotor system and release of high energy parts. This paragraph, especially (b)(1) which requires full autorotation for a single engine helicopter, was included in the suggested CMS(a) requirement as one of the critical conditions that the applicant must identify and mitigate.

**Flight Characteristics**

**§27.141 General -- Rolled up to the suggested CMS(a) and SI requirement**

Summary: This paragraph requires that the vehicle be capable of maintaining any required flight condition and be able to transition smoothly between flight conditions without exceptional pilot skill and without danger of exceeding limiting load factors. A list of parameters for which critical conditions must be tested, including weights, center of gravity, altitudes, temperatures, engine failure conditions, etc., are specified.

Rationale: While the exceptional piloting skill requirement would not be applicable to a vehicle with no provisions for inner loop pilot control, the same requirements would apply to the autopilot design and implementation.

Subparagraph (c) also requires that the vehicle possess any required flight characteristic necessary for night or instrument flight, if certification for such conditions is requested. Since the operational context includes night and limited visibility operations, this subparagraph was included in the suggested CMS(a) and SI requirements.

<p><b>§27.143 Controllability and maneuverability -- Rolled up to the suggested CMS(a) requirement</b></p> <p>Summary: This paragraph requires that the vehicle be safely controllable and maneuverable for a specified set of normal operations, such as takeoff, landing, and steady flight, and for non-normal conditions, such as autorotation and power-on recoveries. The paragraph also specifies that adequate control margins exist at <math>V_{NE}</math> for critical values of relevant parameters. The paragraph further specifies wind and density altitudes for which the vehicle must be safely controllable and maneuverable and critical values of other parameters.</p> <p>Rationale: The general requirement that the vehicle be safely controllable and maneuverable over a relevant set of conditions with critical values of other parameters, such as <math>V_{NE}</math>, weight, center of gravity, rotor speed, and power condition under both normal and non-normal conditions would be a necessary precondition for maintaining rotor system integrity.</p>
<p><b>§27.151 Flight controls -- Rolled up to the suggested CMS(a) requirement</b></p> <p>Summary: This paragraph sets limits on breakout forces, friction, and preloads, and requires that the control system be designed and installed such that the vehicle responds directly and smoothly to control system inputs.</p> <p>Rationale: Although the UAS has no inner-loop control by a human operator, this requirement may be applicable to the autopilot design and was included in the suggested requirement in CMS(a).</p>
<p><b>§27.161 Trim control -- Excluded</b></p> <p>Summary: This paragraph requires that the rotorcraft be capable of being trimmed for the longitudinal, lateral, and collective controls.</p> <p>Rationale: Out of scope of the vehicle context in Table B1. Since the pilot does not have inner loop control, the inner loop is controlled exclusively by an autopilot, so trim forces are not relevant.</p>
<p><b>§27.171 Stability: general -- Excluded</b></p> <p>Summary: This paragraph requires an applicant to consider pilot fatigue and strain in designing stability characteristics.</p> <p>Rationale: This requirement is irrelevant to a UAS by the design or operational characteristics in Table B1, because a remote pilot would not be subject to physical fatigue or strain due to the stability characteristics of the UA.</p>
<p><b>§27.173 Static longitudinal stability -- Rolled up to the suggested CMS(a) requirement</b></p> <p>Summary: This paragraph specifies requirements for design and testing for static longitudinal stability throughout the full range of altitude allowed under the rotorcraft's certification.</p> <p>Rationale: There should be no requirements on static stability for a completely automatic control system. The requirement for testing across the full range of altitude is overly burdensome. However, this requirement may be applicable to the autopilot, thus design and testing should be considered with §27.175 and §27.177 in CMS(a).</p>
<p><b>§27.175 Demonstration of static longitudinal stability -- Rolled up to the suggested CMS(a) requirement</b></p> <p>Summary: This paragraph specifies requirements for testing static longitudinal stability in different phases of flight, under different conditions.</p> <p>Rationale: Same logic as §27.151. There should be no requirements on static stability for a completely automatic control system. However, this requirement may be applicable to the autopilot design, and should be considered for the suggested CMS(a) requirement.</p>
<p><b>§27.177 Static directional stability -- Rolled up to the suggested CMS(a) requirement</b></p> <p>Summary: This paragraph relates to sense and direction of motion of the vehicle in response to movement of the directional controls.</p> <p>Rationale: There should be no requirements on static directional stability for a completely automatic control system. However, this requirement may be applicable to the autopilot design and considered for the suggested CMS(a) requirement.</p>
<p><b>Ground and Water Handling Characteristics</b></p>
<p><b>§27.231 General -- Rolled up to the suggested CMS(a) requirement</b></p> <p>Summary: This paragraph relates primarily to "handling characteristics." Most handling characteristics are pilot perceptions of the controllability and maneuverability of the vehicle.</p> <p>Rationale: Handling characteristics are not applicable to a UAS that is not under direct control of a human operator. However, the paragraph also states that the vehicle must be free from uncontrollable tendencies in any condition expected in operation. This may be a relevant requirement for protecting rotor system integrity and was included in</p>

the suggested CMS(a) requirement.
<p><b>§27.235 Taxiing condition -- Excluded</b>  Summary: This paragraphs deals with withstanding loads related to taxiing the rotorcraft.  Rationale: Out of scope of the operational context in Table B1.</p>
<p><b>§27.239 Spray characteristics -- Excluded</b>  Summary: This paragraph deals with mitigating the possibility of spray (from water operation) that can obscure a pilot's vision.  Rationale: The hazard that underlies this requirement is relevant to a UAS with characteristics as in Table B1, but not to the same degree as for a Part 27 rotorcraft. In this case, the pilot is not likely in proximity of the spray.</p>
<p><b>§27.241 Ground resonance -- As is</b>  The rotorcraft may have no dangerous tendency to oscillate on the ground with the rotor turning.  Rationale: This paragraph was included because of potential hazards from ground resonance to the (ground) crew in proximity during takeoff and landing.</p>
<p><b>Miscellaneous Flight Requirements</b></p>
<p><b>§27.251 Vibration -- Rolled up to the suggested SI requirement</b>  Summary: This paragraph requires that the vehicle be free of excessive vibration for applicable speed and power conditions.  Rationale: While vibration can affect structural strength and fatigue requirements the requirement is of interest only as it might affect rotor system integrity. Since the relationship between vibration and rotor system structural integrity might have many dimensions, including inspection types and frequencies, lifetime limits on parts, etc., this requirement would best be addressed as a part of the overall considerations to ensure rotor system integrity in the suggested SI requirement.</p>
<p><b>14 CFR Part 27, Subpart C—Strength Requirements</b></p>
<p><b>General</b></p>
<p><b>§27.301 Loads -- Excluded</b>  Summary: This paragraph requires loads affecting structural strength requirements to be in equilibrium with inertia forces.  Rationale: This requirement is not directly relevant to a primary hazard identified in the hazard analysis for this operational context.</p>
<p><b>§27.303 Factor of safety -- Excluded</b>  Summary: This paragraph specifies the factor of safety to be used with loads.  Rationale: This requirement is not directly relevant to a primary hazard identified in the hazard analysis for this operational context. The requirement in §27.602 addresses design requirements for critical parts.</p>
<p><b>§27.305 Strength and deformation -- Excluded</b>  Summary: This paragraph requires tests to ensure that structure does not permanently deform or fail under load conditions.  Rationale: This requirement is not directly relevant to a primary hazard identified in the hazard analysis for this operational context.</p>
<p><b>§27.307 Proof of structure -- Rolled up to the suggested CMS(b) &amp; SI requirements</b>  Summary: This paragraph requires that an applicant show by analysis or other tests that the structure meets the strength and deformation requirements of the subpart.  Rationale: Since the requirements specifically include limit load tests of the control system including control surfaces, this paragraph was rolled up into the suggested CMS(b) and SI requirements.</p>
<p><b>§27.309 Design limitations -- Rolled up to the suggested CMS(b) and SI requirements</b>  Summary: This paragraph sets values for parameters considered critical for showing compliance with the structural requirements.  Rationale: Parameters such as rotor speed and forward, rearward, and sideward speeds, affect the control system requirements and should be considered in the suggested CMS(b) and SI requirements. The suggested requirements</p>

allow the applicant to establish which parameters are critical, as opposed to explicitly specifying them in the requirement.

### **Flight Loads**

#### **§27.321 General -- Rolled up to the suggested CMS(a) and SI requirements**

Summary: This paragraph specifies assumptions about flight load factors and provides general guidance for complying with flight load requirements in Part 27.

Rationale: Since load factors are induced by control movements, the general requirement to address flight loads with respect to controllability and structural integrity should be considered. This may drive design requirements on the autopilot. This requirement was included in the suggested CMS(a) and SI requirements.

#### **§27.337 Limit maneuvering load factor -- Rolled up to the suggested CMS(a) and SI requirements**

Summary: This paragraph specifies a range of limiting load factors in terms of the probability of being exceeded as shown by analysis and flight tests.

Rationale: Since load factors are induced by control movements, this may be considered as a design requirement on the autopilot and thus was included in the suggested CMS(a) and SI requirements.

#### **§27.339 Resultant limit maneuvering loads -- Excluded**

Summary: This paragraph describes assumptions about how loads from limit maneuvering load factors should act and defines a rotor tip speed ratio.

Rationale: This paragraph provides supporting information for §27.337. Because §27.337 may be interpreted or applied in different ways for UAS, this paragraph is not necessary.

#### **§27.341 Gust loads -- Excluded**

Summary: This paragraph requires rotorcraft to withstand loads from vertical wind gusts.

Rationale: Out of scope of the operational context in Table B1. In addition, the hazard that underlies this requirement is relevant to a UAS with characteristics as in Table B1, but not to the same degree as for a Part 27 rotorcraft.

#### **§27.351 Yawing conditions -- Excluded**

Summary: This paragraph specifies requirements for designing for loads under various conditions in unaccelerated flight with zero and maximum achievable yaw.

Rationale: Out of scope of the operational context in Table B1. In addition, the hazard that underlies this requirement is relevant to a UAS with characteristics as in Table B1, but not to the same degree as for a Part 27 rotorcraft.

#### **§27.361 Engine torque -- Rolled up to the suggested SI requirement**

Summary: This paragraph specifies minimum values for limit torque for different engine types that must be used in structural tests and demonstrations required by other paragraphs.

Rationale: The limiting torque values determine the structural loads that must be used to ensure rotor system and related supporting structure integrity. Other paragraphs referenced by this paragraph are also rolled up to the suggested SI requirement.

### **Control Surface and System Loads**

#### **§27.391 General -- Rolled up to the suggested CMS(b) & SI requirements**

Summary: This paragraph establishes what elements of the control system fall under the subsequent paragraphs that specify design requirements.

Rationale: The elements specified (auxiliary rotors, fixed or movable control surfaces, and each system operating any flight control) might require the application of the specified airworthiness considerations in some form and thus were rolled up to the suggested CMS(b) and SI requirements.

#### **§27.395 Control system -- Rolled up to the suggested CMS(b) requirement**

Summary: This paragraph establishes the maximum loads that the control system must be designed to handle.

Rationale: The requirements are expressed primarily in terms of pilot-applied loads, which would not be relevant, but also covers loads from power actuators, which are relevant. The paragraph also specifies other conditions that must be considered in control system design. These include friction, jamming, fatigue, inertias, and gusts, which would be relevant to maintaining the integrity of the rotor control system. This paragraph was rolled up into the

suggested CMS(b) requirement to ensure that the applicant addresses power actuator loads and the various other design requirements that would ensure rotor system integrity.

**§27.397 Limit pilot forces and torques -- Excluded**

Summary: This paragraph specifies limit pilot forces.

Rationale: This requirement is irrelevant to a UAS by the design or operational characteristics in Table B1.

**§27.399 Dual control system -- Excluded**

Summary: This paragraph places requirements on dual flight control systems to withstand loads associated with specified pilot forces.

Rationale: This requirement is irrelevant to a UAS by the design or operational characteristics in Table B1.

**§27.411 Ground clearance: tail rotor guard -- As is**

(a) It must be impossible for the tail rotor to contact the landing surface during a normal landing.

(b) If a tail rotor guard is required to show compliance with paragraph (a) of this section—

(1) Suitable design loads must be established for the guard; and

(2) The guard and its supporting structure must be designed to withstand those loads.

Rationale: The crew may be in proximity to the rotorcraft during landing, even if they are outside of any containment boundary. Thus a loss of rotor hub integrity may result in crew impact from any ejected parts (high energy or not). Furthermore, since there is likely a physical connection between the tail rotor and the main rotor, damage to the tail rotor might cause damage to the main rotor, leading to a further ejection of high energy parts.

**§27.427 Unsymmetrical loads -- As is**

(a) Horizontal tail surfaces and their supporting structure must be designed for unsymmetrical loads arising from yawing and rotor wake effects in combination with the prescribed flight conditions.

(b) To meet the design criteria of paragraph (a) of this section, in the absence of more rational data, both of the following must be met:

(1) One hundred percent of the maximum loading from the symmetrical flight conditions acts on the surface on one side of the plane of symmetry, and no loading acts on the other side.

(2) Fifty percent of the maximum loading from the symmetrical flight conditions acts on the surface on each side of the plane of symmetry but in opposite directions.

(c) For empennage arrangements where the horizontal tail surfaces are supported by the vertical tail surfaces, the vertical tail surfaces and supporting structure must be designed for the combined vertical and horizontal surface loads resulting from each prescribed flight condition, considered separately. The flight conditions must be selected so the maximum design loads are obtained on each surface. In the absence of more rational data, the unsymmetrical horizontal tail surface loading distributions described in this section must be assumed.

Rationale: (a) Given the critical loading profile determined in §27.21 and/or CMS(a) and (b), a demonstration of structural integrity of the rotor hub under maximal loading applied at both full and half moments of inertia for the rotor disc is regarded as being sufficient to prevent the frequent ejection of high energy parts from the containment area under asymmetric loading conditions.

(b) Given the critical loading profile determined in §27.21 and/or CMS(a) and (b), empennage tail rotor surfaces must further assure structural rotor hub integrity under combined longitudinal and lateral maximal loading profiles for each critical flight condition, unless it can be demonstrated that lower values are only ever achieved. This will sufficiently mitigate the ejection of high energy parts from the containment area under maximal lateral and longitudinal loading conditions.

**Ground Loads**

**§27.471 General -- Excluded**

Summary: This paragraph provides general guidance for what is meant by limit ground loads (external loads), and guidance for selecting critical centers of gravity with respect to maximum load on the landing gear.

Rationale: The hazard that underlies this requirement is relevant to a UAS with characteristics as in Table B1, but not to the same degree as for a Part 27 rotorcraft.

**§27.473 Ground loading conditions and assumptions -- Excluded**

Summary: This paragraph sets requirements for establishing design maximum weight used in determining strength requirements for ground loads.

<p>Rationale: The hazard that underlies this requirement is relevant to a UAS with characteristics as in Table B1, but not to the same degree as for a Part 27 rotorcraft.</p>
<p><b>§27.475 Tires and shock absorbers -- Excluded</b>  Summary: This paragraph states assumptions on tire and shock absorber positions for landing, to be used in determining strength requirements.  Rationale: The hazard that underlies this requirement is relevant to a UAS with characteristics as in Table B1, but not to the same degree as for a Part 27 rotorcraft.</p>
<p><b>§27.477 Landing gear arrangement -- Excluded</b>  Summary: This paragraph specifies how the wheels of a landing gear should be arranged with respect to the center of gravity for paragraphs related to taxiing and some load characteristics.  Rationale: The hazard that underlies this requirement is relevant to a UAS with characteristics as in Table B1, but not to the same degree as for a Part 27 rotorcraft.</p>
<p><b>§27.479 Level landing conditions -- Excluded</b>  Summary: This paragraph specifies landing load conditions to be considered in establishing strength requirements.  Rationale: The hazard that underlies this requirement is relevant to a UAS with characteristics as in Table B1, but not to the same degree as for a Part 27 rotorcraft.</p>
<p><b>§27.481 Tail-down landing conditions -- Excluded</b>  Summary: This paragraph specifies tail down landing conditions to be considered in establishing strength requirements.  Rationale: The hazard that underlies this requirement is relevant to a UAS with characteristics as in Table B1, but not to the same degree as for a Part 27 rotorcraft.</p>
<p><b>§27.483 One-wheel landing conditions -- Excluded</b>  Summary: This paragraph specifies one wheel landing conditions to be considered in establishing strength requirements.  Rationale: The hazard that underlies this requirement is relevant to a UAS with characteristics as in Table B1, but not to the same degree as for a Part 27 rotorcraft.</p>
<p><b>§27.485 Lateral drift landing conditions -- Excluded</b>  Summary: This paragraph specifies lateral drift landing conditions to be considered in establishing strength requirements.  Rationale: The hazard that underlies this requirement is relevant to a UAS with characteristics as in Table B1, but not to the same degree as for a Part 27 rotorcraft.</p>
<p><b>§27.493 Braked roll conditions -- Excluded</b>  Summary: This paragraph specifies braked roll conditions to be considered in establishing strength requirements.  Rationale: The hazard that underlies this requirement is relevant to a UAS with characteristics as in Table B1, but not to the same degree as for a Part 27 rotorcraft.</p>
<p><b>§27.497 Ground loading conditions: landing gear with tail wheels -- Excluded</b>  Summary: This paragraph specifies ground loading conditions for rotorcraft with tail wheels.  Rationale: The hazard that underlies this requirement is relevant to a UAS with characteristics as in Table B1, but not to the same degree as for a Part 27 rotorcraft.</p>
<p><b>§27.501 Ground loading conditions: landing gear with skids -- Excluded</b>  Summary: This paragraph specifies ground loading conditions for rotorcraft with landing gear with skids.  Rationale: The hazard that underlies this requirement is relevant to a UAS with characteristics as in Table B1, but not to the same degree as for a Part 27 rotorcraft.</p>
<p><b>§27.505 Ski landing conditions -- Excluded</b>  Summary: This paragraph specifies ground loading conditions for rotorcraft with skis.  Rationale: The hazard that underlies this requirement is relevant to a UAS with characteristics as in Table B1, but not to the same degree as for a Part 27 rotorcraft.</p>
<p><b>Water Loads</b></p>

**§27.521 Float landing conditions -- Excluded**

Summary: This paragraph specifies loading conditions for rotorcraft certificated for float operation.

Rationale: The hazard that underlies this requirement is relevant to a UAS with characteristics as in Table B1, but not to the same degree as for a Part 27 rotorcraft.

**Main Component Requirements**

**§27.547 Main rotor structure -- Rolled up to the suggested SI requirement**

Summary: This paragraph specifies conditions and values for which each main rotor system must be designed.

Rationale: The specific conditions and values should be screened with respect to the specific risks associated with an unmanned vehicle in the operational context in Table B1, especially given that the safety issue is limited to rotor system integrity under a very narrow set of operating conditions. Thus, the paragraph was rolled up to the suggested SI requirement where critical conditions related to rotor system integrity could be substituted for the specific requirements of the paragraph.

**§27.549 Fuselage, landing gear, and rotor pylon structures -- Rolled up to the suggested SI requirement**

Summary: This paragraph specifies conditions and values for which the fuselage, landing gear, and rotor pylons must be designed by reference to numerous other paragraphs.

Rationale: As in §27.547, specific conditions and values should be screened with respect to the specific risks associated with an unmanned vehicle in the operational context in Table B1, especially given that the safety issue is limited to rotor system integrity under a very narrow set of operating conditions. Thus, the paragraph, like §27.547, was rolled up to the suggested requirement for SI.

**Emergency Landing Conditions**

**§27.561 General-- Excluded**

Summary: This paragraph specifies load factors that must be considered in structural design to protect rotorcraft occupants during emergency landings.

Rationale: This requirement is irrelevant to a UAS by the design or operational characteristics in Table B1. This requirement is not directly relevant to a primary hazard identified in the hazard analysis for this operational context.

**§27.562 Emergency landing dynamic conditions -- Excluded**

Summary: This paragraph specifies many factors related to occupants seats and restraints that must be considered in structural design to protect occupants during emergency landings.

Rationale: This requirement is irrelevant to a UAS by the design or operational characteristics in Table B1. This requirement is not directly relevant to a primary hazard identified in the hazard analysis for this operational context.

**§27.563 Structural ditching provisions -- Excluded**

Summary: This paragraph describes factors that must be considered in structural design during emergency landings that take place in water (ditching).

Rationale: The hazard that underlies this requirement is relevant to a UAS with characteristics as in Table B1, but not to the same degree as for a Part 27 rotorcraft.

**Fatigue Evaluation**

**§27.571 Fatigue evaluation of flight structure -- Rolled up to the SI requirement**

Summary: This paragraph establishes requirements for the elements of the flight structure that must be identified and evaluated with respect to fatigue considerations, including rotor system and drive components. The paragraph further specifies procedures and measurement techniques that must be used to determine loads and stresses and fatigue tolerances.

Rationale: While fatigue considerations were considered important in ensuring the rotor system integrity, the specifics of this paragraph were considered too detailed to be applicable as written to an unmanned rotorcraft in a very limited operational circumstance. Thus, the requirements of the paragraph were rolled up to the SI requirements.

**§27.573 Damage Tolerance and Fatigue Evaluation of Composite Rotorcraft Structures -- Rolled up to the SI requirement**

Summary: This paragraph specifies requirements and methodology for evaluating composite rotorcraft structures for with damage tolerance standards.

Rationale: The possibility of entrainment of ground debris into the rotor wake and subsequent impingement on

rotorcraft structure must be considered. The specifics of this paragraph were considered too detailed to be applicable as written to an unmanned rotorcraft in a very limited operational circumstance. Thus, the requirements of the paragraph were rolled up into the more general statement of SI requirement.

#### 14 CFR Part 27, Subpart D—Design and Construction

##### General

###### §27.601 Design -- Modified

(a) The ~~UAS rotorcraft~~ may have no design features or details that experience has shown to be hazardous or unreliable.

(b) *For each questionable design detail whose failure could adversely affect safety*, the suitability of each questionable design detail and part must be established by tests.

Rationale: The entire system (i.e., the GCS and other components, not just the UA) must be free from hazardous features and details. A feature is hazardous if, in the operational context, it could lead to death or serious injury of any person or lead to a large reduction in safety margin. UAS design details that may be deemed conventionally questionable, such as the unqualified use of commercial-off-the-shelf components, unpedigreed sensors and actuators etc., must only be considered with respect to their safety effects.

###### §27.602 Critical Parts -- Modified

(a) Critical part. A critical part is a part, the failure of which could have a catastrophic effect upon the ~~rotorcraft~~ *UAS*, and for which critical characteristics have been identified which must be controlled to ensure the required level of integrity.

(b) If the type design includes critical parts, a critical parts list shall be established. Procedures shall be established to define the critical design characteristics, identify processes that affect those characteristics, and identify the design change and process change controls necessary for showing compliance with the quality assurance requirements of part 21 of this chapter.

Rationale: A critical part is one whose failure results in a catastrophic failure for the UAS. Critical parts might be found in the containment system, ground control station, receivers, etc.—not just in the rotorcraft itself. A critical parts list should include those parts whose failure is considered catastrophic (e.g., results in the ejection of high energy parts from containment area or a fly away event).

###### §27.603 Materials -- As is

The suitability and durability of materials used for parts, the failure of which could adversely affect safety, must—

(a) Be established on the basis of experience or tests;

(b) Meet approved specifications that ensure their having the strength and other properties assumed in the design data; and

(c) Take into account the effects of environmental conditions, such as temperature and humidity, expected in service.

Rationale: Only safety critical systems need to meet this standard (all other systems need not comply and/or degrade gracefully). The provision that this only applies “for parts, the failure of which could adversely affect safety” is part of the Part 27 text. This phrase is included elsewhere since it is particularly relevant to UAS with the characteristics given in Table B1.

###### §27.605 Fabrication methods -- Rolled up to the suggested CMS(b) and SI requirements

Summary: This paragraph relates primarily to production methods, requiring methods that produce consistently sound structures and a test program to substantiate those methods.

Rationale: This requirement is felt to be applicable to control system fabrication as well as other structures and so is included in the suggested CMS(b) and SI requirements.

###### §27.607 Fasteners -- Rolled up to the suggested CMS(b) requirement

Summary: This paragraph establishes a requirement for locking devices for bolts, screws, nuts, pins, etc. used in any critical application that could jeopardize safe operations.

Rationale: This paragraph was felt to be particularly applicable to control systems and so was rolled up into the suggested CMS(b) requirement to force consideration of fasteners and their role in maintaining rotor system integrity.

###### §27.609 Protection of structure -- Modified

Each part of the structure, *whose failure could adversely affect safety*, must—



(a) Be suitably protected against deterioration or loss of strength in service due to any cause, including—

- (1) Weathering;
- (2) Corrosion; and
- (3) Abrasion; and

(b) Have provisions for ventilation and drainage where necessary to prevent the accumulation of corrosive, flammable, or noxious fluids.

Rationale: Only parts of the UAS structure that affect overall UAS system safety need meet this standard. However, parts of the system other than the UA might also affect safety and thus need to be considered. Safety considerations should include effects on the crew.

#### **§27.610 Lightning and static electricity protection -- Modified**

~~(a) The rotorcraft must be protected against catastrophic effects from lightning.~~

~~(b) For metallic components, compliance with paragraph (a) of this section may be shown by—~~

- ~~(1) Electrically bonding the components properly to the airframe; or~~
- ~~(2) Designing the components so that a strike will not endanger the rotorcraft.~~

~~(c) For nonmetallic components, compliance with paragraph (a) of this section may be shown by—~~

- ~~(1) Designing the components to minimize the effect of a strike; or~~
- ~~(2) Incorporating acceptable means of diverting the resulting electrical current so as not to endanger the rotorcraft.~~

(d) The electrical bonding and protection against lightning and static electricity must—

- (1) Minimize the accumulation of electrostatic charge;
- (2) Minimize the risk of electric shock to crew, passengers, and service and maintenance personnel using normal precautions;
- (3) Provide an electrical return path, under both normal and fault conditions, on rotorcraft having grounded electrical systems; and
- (4) Reduce to an acceptable level the effects of static electricity on the functioning of essential electrical and electronic equipment.

Rationale: The operational context does not include operations during weather conditions in which lightning typically occurs. Items (a-c) are not applicable as the lightning strike hazard is controlled operationally. Item (d) is mostly kept because details relevant to static electricity must be considered. Static electricity can electrocute a crewmember, so buildup must be mitigated. Neither lightning nor passengers need to be considered in (d).

#### **§27.611 Inspection provisions -- Modified**

There must be means to allow the close examination of each part, *whose failure could adversely affect safety*, that requires—

- (a) Recurring inspection;
- (b) Adjustment for proper alignment and functioning; or
- (c) Lubrication.

Rationale: Only safety-critical UAS parts need meet this standard (all other systems parts need not comply).

#### **§27.613 Material strength properties and design values -- Rolled up to the suggested SI requirement**

Summary: This paragraph specifies the materials and structural strength required for the vehicle.

Rationale: Material strength would likely be a factor in maintaining rotor system integrity. This paragraph was included in the suggested SI requirement.

#### **§27.619 Special factors -- Excluded**

Summary: This paragraph increases the factor of safety prescribed for bearings, fittings and castings for parts whose strength is variable, uncertain, or likely to deteriorate in service before normal replacement.

Rationale: The hazard that underlies this requirement is relevant to a UAS with characteristics as in Table B1, but not to the same degree as for a Part 27 rotorcraft. The requirement in §27.602 addresses design requirements for critical parts.

#### **§27.621 Casting factors -- Rolled up to the suggested CMS(b) and SI requirements**

Summary: This paragraph establishes manufacturing, inspection, and testing requirements for critical castings.

Rationale: Since any castings used in the control system would likely be critical to maintaining rotor system integrity, this paragraph was included in the suggested CMS(b) and SI requirements.

<p><b>§27.623 Bearing factors -- Rolled up to the suggested CMS(b) and SI requirements</b></p> <p>Summary: This paragraph specifies requirements for parts that have clearances and are subjected to pounding or vibration.</p> <p>Rationale: Rotorcraft are known to have such forces in their control systems and the bearing surfaces are also known to require specific clearances to control friction and binding in the system. The requirements of this paragraph were rolled up to the suggested CMS(b) and SI requirements.</p>
<p><b>§27.625 Fitting factors -- Rolled up to the suggested CMS(b) and SI requirements</b></p> <p>Summary: This paragraph establishes a fitting factor of 1.15 and specifies the parts to which the factor applies if strength is not established in other acceptable ways.</p> <p>Rationale: Because the control system requires fitting of parts but the exact fitting factor may be different, this requirement was rolled up to the suggested CMS(b) and SI requirements.</p>
<p><b>§27.629 Flutter -- As Is</b></p> <p>Each aerodynamic surface of the rotorcraft must be free from flutter under each appropriate speed and power condition.</p> <p>Rationale: Flutter must not impact rotor system integrity.</p>
<p><b>Rotors</b></p>
<p><b>§27.653 Pressure venting and drainage of rotor blades -- Rolled up to the suggested SI requirement</b></p> <p>Summary: This paragraph establishes requirements for rotor blade pressure relief and drainage for rotor blades that are not sealed.</p> <p>Rationale: This paragraph relates to rotor system integrity and could be relevant depending on rotor blade design.</p>
<p><b>§27.659 Mass balance -- Rolled up to the suggested SI requirement</b></p> <p>Summary: This paragraph establishes requirements (1) for rotor mass balance to prevent excessive vibration at speeds out to the maximum forward speed and (2) for substantiation of the structural integrity of the mass balance.</p> <p>Rationale: Rotor mass balance affects structural integrity, but the definitions of “excessive” and “maximum forward speed” for a UAS in the operational context in Table B1 may differ from Part 27 rotorcraft. The paragraph was included in the more generalized requirements suggested for SI.</p>
<p><b>§27.661 Rotor blade clearance -- Rolled up to the suggested SI requirement</b></p> <p>Summary: This paragraph establishes a requirement that the rotor blades not contact any part of the structure during any operating condition.</p> <p>Rationale: While this requirement relates to maintaining rotor system integrity under most conditions, there might be exceptions related to autorotation away from the operational boundaries where the vehicle could sustain damage or loss without hazard to persons or property. The requirement was included in the suggested SI requirement to allow discussion of tailoring the requirement to the specific design and operations of the UAS.</p>
<p><b>§27.663 Ground resonance prevention means -- Rolled up to the suggested SI requirement</b></p> <p>Summary: This paragraph establishes requirements on the means incorporated in the rotorcraft design to avoid ground resonance and a requirement that failure of any single means will not cause ground resonance.</p> <p>Rationale: Avoidance of ground resonance was considered an important aspect of maintaining rotor system integrity, particularly near (ground) crewmembers involved in the servicing the vehicle. The requirements for establishing the reliability of such systems, however, might be different for unmanned vehicles than for manned vehicles, so the paragraph was rolled up to the suggested SI requirement.</p>
<p><b>Control Systems</b></p>
<p><b>§27.671 General -- Rolled up to the suggested CMS (a and b) requirements</b></p> <p>Summary: This paragraph establishes requirements on smoothness of the control systems and a requirement that they be designed or marked to minimize probability of incorrect assembly.</p> <p>Rationale: Requirements for smoothness of the control system are dictated by the design and power of the automatic control system and its servos, which must satisfy the flight requirements of CMS(a). The design and marking requirements to minimize incorrect assembly are covered in CMS(b).</p>
<p><b>§27.672 Stability augmentation, automatic, and power-operated systems -- Rolled up to the suggested CMS(a) requirement</b></p>

<p>Summary: This paragraph requires that any automatic stabilization or automatic control systems must be able to continue to a safe landing after any single failure in the system. The paragraph further specifies that the controllability and maneuverability requirements previously specified continue to be met within a “practical operational envelope”. Other parts of the paragraph relate to warning systems and pilot skill and strength requirements.</p> <p>Rationale: The requirements for controllability and maneuverability were rolled up to the suggested CMS(a) requirement with the expectation that the applicant and regulatory authority will determine the applicable requirements for the automatic flight control system.</p>
<p><b>§27.673 Primary flight control -- Excluded</b></p> <p>Summary: Defines what a primary flight control is relative to a pilot.</p> <p>Rationale: Out of scope of the operational context in Table B1. The pilot does not have inner-loop control.</p>
<p><b>§27.674 Interconnected controls -- Excluded</b></p> <p>Summary: Ensures that safe flight can continue after a jam or other malfunction of an auxiliary interconnected flight control.</p> <p>Rationale: Out of scope of the vehicle context in Table B1. Interconnected auxiliary controls are not expected in a UAS with the characteristics given in Table B1.</p>
<p><b>§27.675 Stops -- Rolled up to the suggested CMS(b) requirement</b></p> <p>Summary: This paragraph specifies that the control system must contain stops that limit the range of control motion and conditions that must be considered in setting the stops.</p> <p>Rationale: While a UAS will not have traditional pilot controls and thus the need for stops to limit pilot control inputs, there still exists a requirement to ensure that the control system actuators cannot produce commands that would cause a failure condition in the control system and thus jeopardize rotor system integrity. This requirement generally applies and was included in the suggested CMS(b) requirement.</p>
<p><b>§27.679 Control system locks -- Rolled up to the suggested CMS(b) requirement</b></p> <p>Summary: This paragraph establishes requirements for control system locks if they are part of the design.</p> <p>Rationale: Although the operational context would not likely dictate a requirement for control system locks, the requirement for ground transportability could possibly dictate a requirement and was included in the suggested CMS(b) requirement.</p>
<p><b>§27.681 Limit load static tests -- Rolled up to the suggested CMS(b) and SI requirements</b></p> <p>Summary: This paragraph establishes the conditions under which compliance with control system limit loads must be shown.</p> <p>Rationale: Since the integrity of the control system is essential to maintaining the integrity of the rotor system, this paragraph may be generally applicable and was included in the suggested requirements for CMS(b) and SI.</p>
<p><b>§27.683 Operation tests -- Rolled up to the suggested CMS(b) requirement</b></p> <p>Summary: This paragraph specifies that the control system must be free of jamming, excessive friction, and excessive deflection when operated from the pilot compartment to the loads specified for the system.</p> <p>Rationale: While the UAS does not have an on board pilot compartment, the spirit of the rule is that the control system be free of the specified characteristics when operated by power actuators. What constitutes “excessive” might vary for an automatic control system compared with a manual control system and would probably be limited by required control system performance.</p>
<p><b>§27.685 Control system details -- Rolled up to the suggested CMS(b) requirement</b></p> <p>Summary: This paragraph specifies a number of miscellaneous requirements for control system functioning to prevent jamming, chafing, and interference from cargo, passengers, loose objects or the freezing of moisture. This applies primarily to pulley and cable systems. Special design factors for push-pull and cable systems are also specified.</p> <p>Rationale: The general intent that the control system design should consider jamming, chafing and interference applies in general. Applicability of the specific details in the paragraph will depend on implementation of the control system.</p>
<p><b>§27.687 Spring devices -- Rolled up to the suggested CMS(b) requirement</b></p> <p>Summary: This paragraph requires that spring devices whose failure could compromise safe flight need to be</p>

reliable and must be shown as such by demonstrations simulating service conditions.  
Rationale: Failure of spring devices in the control system could result in flutter or other unsafe conditions and thus could represent a threat to control system and rotor system integrity. The paragraph was rolled up to the suggested CMS(b) requirement to ensure that the applicant considers the requirements on spring devices to the extent they are included in the design.

**§27.691 Autorotation control mechanism – As is**

Each main rotor blade pitch control mechanism must allow rapid entry into autorotation after power failure.  
Rationale: The autorotation function is required in the given operational context in Table B1 to maintain structural integrity of the rotor system.

**§27.695 Power boost and power-operated control system -- Rolled up to the suggested CMS(b) requirement**

Summary: This paragraph specifies requirements for an alternate control system to provide continued safe flight in the event of a failure of a power actuator or any of the elements supporting the actuator, such as pumps, valves, and lines. The paragraph includes requirements on the reliability of mechanical parts and actuators.  
Rationale: The requirements of this paragraph are generally applicable given the likely use of servos in the primary flight control system, although only to the extent that failure to meet the requirements would jeopardize rotor system integrity or jeopardize containment. The paragraph was rolled up to the suggested requirement in CMS(b) as a consideration in control system design and installation.

**Landing Gear**

**§27.723 Shock absorption tests -- Excluded**

Summary: This paragraph describes conditions for executing the required shock absorption tests.  
Rationale: The hazard that underlies this requirement is relevant to a UAS with characteristics as in Table B1, but not to the same degree as for a Part 27 rotorcraft.

**§27.725 Limit drop test -- Excluded**

Summary: This paragraph describes the impulsive load the landing gear is capable of withstanding without collapse.  
Rationale: This requirement is not directly relevant to a primary hazard identified in the hazard analysis for this operational context.

**§27.727 Reserve energy absorption drop test -- Excluded**

Summary: This paragraph describes the amount of impact energy the landing gear must be capable of absorbing without collapse.  
Rationale: This requirement is not directly relevant to a primary hazard identified in the hazard analysis for this operational context.

**§27.729 Retracting mechanism -- Excluded**

Summary: This paragraph describes the requirements for retractable landing gear.  
Rationale: Does not map to a hazard. This assumes there are no other hazards associated with retractable landing gear beyond ground resonance, which is handled under §27.663.

**§27.731 Wheels -- Excluded**

Summary: This paragraph describes wheel requirements for the landing gear.  
Rationale: This requirement is not directly relevant to a primary hazard identified in the hazard analysis for this operational context.

**§27.733 Tires -- Excluded**

Summary: This paragraph describes the performance requirements of the tires in the landing gear.  
Rationale: This requirement is not directly relevant to a primary hazard identified in the hazard analysis for this operational context.

**§27.735 Brakes -- Rolled up to the suggested CMS(a) requirement**

Summary: This paragraph establishes functional requirements for the brakes including design requirements related to startup, shutdown, landing, and while parked on a 10 degree slope.  
Rationale: If equipped with a wheel system, this requirement mitigates the hazard of the vehicle unintentionally rolling out of the operational area under the required conditions.

**§27.737 Skis -- Excluded**

Summary: This paragraph describes limit loading for landing on skis.

Rationale: The hazard that underlies this requirement is relevant to a UAS with characteristics as in Table B1, but not to the same degree as for a Part 27 rotorcraft.

**Floats and Hulls**

**§27.751 Main float buoyancy -- Excluded**

Summary: This paragraph describes buoyancy requirements on the vehicle.

Rationale: The hazard that underlies this requirement is relevant to a UAS with characteristics as in Table B1, but not to the same degree as for a Part 27 rotorcraft.

**§27.753 Main float design -- Excluded**

Summary: This paragraph describes design requirements on buoyancy elements.

Rationale: The hazard that underlies this requirement is relevant to a UAS with characteristics as in Table B1, but not to the same degree as for a Part 27 rotorcraft.

**§27.755 Hulls -- Excluded**

Summary: This paragraph describes the buoyancy requirements on the vehicle in the case of hull damage.

Rationale: The hazard that underlies this requirement is relevant to a UAS with characteristics as in Table B1, but not to the same degree as for a Part 27 rotorcraft.

**Personnel and Cargo Accommodations**

**§27.771 Pilot compartment -- Excluded**

Summary: This paragraph deals with the accommodations necessary for an onboard pilot.

Rationale: This requirement is not directly relevant to a primary hazard identified in the hazard analysis for this operational context.

**§27.773 Pilot compartment view -- Excluded**

Summary: This paragraph deals with the accommodations necessary for an onboard pilot.

Rationale: This requirement is not directly relevant to a primary hazard identified in the hazard analysis for this operational context.

**§27.775 Windshields and windows -- Excluded**

Summary: This paragraph deals with the accommodations (windshields and windows) necessary for an onboard pilot to see outside of the aircraft.

Rationale: This requirement is not directly relevant to a primary hazard identified in the hazard analysis for this operational context.

**§27.777 Cockpit controls -- Excluded**

Summary: This paragraph deals with locating the cockpit controls so that they are convenient for an onboard pilot to control the aircraft.

Rationale: This requirement is not directly relevant to a primary hazard identified in the hazard analysis for this operational context.

**§27.779 Motion and effect of cockpit controls -- Excluded**

Summary: This paragraph deals with the accommodations necessary for motion relevant to cockpit controls for an onboard pilot.

Rationale: This requirement is not directly relevant to a primary hazard identified in the hazard analysis for this operational context.

**§27.783 Doors -- Excluded**

Summary: This paragraph deals with external doors necessary for onboard persons to safely exit the aircraft.

Rationale: This requirement is not directly relevant to a primary hazard identified in the hazard analysis for this operational context.

**§27.785 Seats, berths, litters, safety belts, and harnesses -- Excluded**

Summary: This paragraph deals with the seating accommodations (e.g., seatbelts, seats, or harnesses) necessary for onboard persons.

Rationale: This requirement is not directly relevant to a primary hazard identified in the hazard analysis for this operational context.

**§27.787 Cargo and baggage compartments – Modified**

***If cargo is carried,***

(a) Each cargo and baggage compartment must be designed for its placarded maximum weight of contents and for the critical load distributions at the appropriate maximum load factors corresponding to the specified flight ~~and ground load conditions, except the emergency landing conditions of §27.561.~~

(b) There must be means to prevent the contents of any compartment from becoming a hazard by shifting under the loads specified in paragraph (a) of this section.

~~(c) Under the emergency landing conditions of §27.561, cargo and baggage compartments must —~~

~~(1) Be positioned so that if the contents break loose they are unlikely to cause injury to the occupants or restrict any of the escape facilities provided for use after an emergency landing; or~~

~~(2) Have sufficient strength to withstand the conditions specified in §27.561 including the means of restraint, and their attachments, required by paragraph (b) of this section. Sufficient strength must be provided for the maximum authorized weight of cargo and baggage at the critical loading distribution.~~

~~(d) If cargo compartment lamps are installed, each lamp must be installed so as to prevent contact between lamp bulb and cargo.~~

Rationale: If the operational context requires cargo to be carried, then the cargo compartments should prevent shifting of the cargo to avoid changed in the center of gravity. Item (c) was deleted because it concerns the potential of the cargo to injure occupants of the aircraft. Item (d) was deleted because fire is not a primary safety hazard, since there are no people onboard.

**§27.801 Ditching -- Excluded**

Summary: This paragraph deals with the accommodations necessary for the safety onboard persons in the event of ditching.

Rationale: This requirement is not directly relevant to a primary hazard identified in the hazard analysis for this operational context.

**§27.805 Flight crew emergency exits -- Excluded**

Summary: This paragraph deals with the accommodations necessary for emergency exits (onboard) for the flight crew.

Rationale: This requirement is not directly relevant to a primary hazard identified in the hazard analysis for this operational context.

**§27.807 Emergency exits -- Excluded**

Summary: This paragraph deals with the accommodations necessary for emergency exits for onboard passengers.

Rationale: This requirement is not directly relevant to a primary hazard identified in the hazard analysis for this operational context.

**§27.831 Ventilation -- Excluded**

Summary: This paragraph deals with the accommodations necessary for the ventilation system to prevent fuel fumes and carbon monoxide from harming onboard persons.

Rationale: Does not map to a hazard.

**§27.833 Heaters -- Excluded**

Summary: This paragraph requires approval of any combustion heaters necessary for the accommodation of onboard persons.

Rationale: This requirement is not directly relevant to a primary hazard identified in the hazard analysis for this operational context.

**Fire Protection**

**§27.853 Compartment interiors -- Excluded**

Summary: This paragraph deals with onboard fire protection for compartments used by crew or passengers.

Rationale: This requirement is not directly relevant to a primary hazard identified in the hazard analysis for this operational context.

**§27.855 Cargo and baggage compartments -- Modified**

*If cargo is carried,*

~~(a) Each cargo and baggage compartment must be constructed of, or lined with, materials that are at least—~~

- ~~(1) Flame resistant, in the case of compartments that are readily accessible to a crewmember in flight; and  
(2) Fire resistant, in the case of other compartments.~~

~~(b) No cargo compartment may contain any controls, wiring, lines, equipment, or accessories whose damage or failure would affect safe operation, unless those items are protected so that—~~

- ~~(1) They cannot be damaged by the movement of cargo in the compartment; and  
(2) Their breakage or failure will not create a fire hazard.~~

Rationale: Fire is a secondary hazard (in the sense that the hazard that underlies this requirement is relevant to a UAS with characteristics as in Table B1, but not to the same degree as for a Part 27 rotorcraft), but there is a concern about the possibility of shifting cargo damaging important controls, wiring, etc.

**§27.859 Heating systems -- Excluded**

Summary: This paragraph deals with onboard fire and carbon monoxide protection related to heating systems.

Rationale: This requirement is not directly relevant to a primary hazard identified in the hazard analysis for this operational context.

**§27.861 Fire protection of structure, controls, and other parts -- Modified**

Each part of the structure, controls, rotor mechanism, and other parts essential **to preventing loss of containment or ejection of high energy parts** ~~a controlled landing~~ that would be affected by powerplant fires must be fireproof or protected so they can perform their essential functions for at least 5 minutes under any foreseeable powerplant fire conditions.

Rationale: Need fire protection sufficient to mitigate safety-critical hazards. The time requirement may need further consideration.

**§27.863 Flammable fluid fire protection -- Modified**

~~(a) In each area where flammable fluids or vapors might escape by leakage of a fluid system, there must be means to minimize the probability of ignition of the fluids and vapors, and the resultant hazards if ignition does occur.~~

~~(b) Compliance with paragraph (a) of this section must be shown by analysis or tests, and the following factors must be considered:~~

- ~~(1) Possible sources and paths of fluid leakage, and means of detecting leakage.  
(2) Flammability characteristics of fluids, including effects of any combustible or absorbing materials.  
(3) Possible ignition sources, including electrical faults, overheating of equipment, and malfunctioning of protective devices.  
(4) Means available for controlling or extinguishing a fire, such as stopping flow of fluids, shutting down equipment, fireproof containment, or use of extinguishing agents **provided either by the type design or through operational requirements and provisions.**  
(5) Ability of rotorcraft components that are critical to safety of flight to withstand fire and heat.~~

~~(c) If action by the flight crew is required to prevent or counteract a fluid fire (e.g. equipment shutdown or actuation of a fire extinguisher) quick acting means must be provided to alert the crew.~~

~~(d) Each area where flammable fluids or vapors might escape by leakage of a fluid system must be identified and defined.~~

Rationale: The control of the flammable fluid hazard is not related to the act of fire protection for onboard crew and passengers of the rotorcraft, but instead is included to mitigate the risk of a ground or inflight explosion that could result in the release of high-energy parts outside of the operational area thus representing a risk to the UAS crew and bystanders.

**External Loads**

**§27.865 External loads -- Modified**

(a) It must be shown by analysis, test, or both, that the rotorcraft external load attaching means for rotorcraft-load combinations to be used for nonhuman external cargo applications can withstand a limit static **load sufficient to maintain safe operations.** ~~equal to 2.5, or some lower load factor approved under §§27.337 through 27.341, multiplied by the maximum external load for which authorization is requested. It must be shown by analysis, test, or both that the rotorcraft external load attaching means and corresponding personnel carrying device system for~~

rotorcraft load combinations to be used for human external cargo applications can withstand a limit static load equal to 3.5 or some lower load factor, not less than 2.5, approved under §§27.337 through 27.341, multiplied by the maximum external load for which authorization is requested. The load for any rotorcraft load combination class, for any external cargo type, must be applied in the vertical direction. For jettisonable external loads of any applicable external cargo type, the load must also be applied in any direction making the maximum angle with the vertical that can be achieved in service but not less than 30°. However, the 30° angle may be reduced to a lesser angle if—

- (1) An operating limitation is established limiting external load operations to such angles for which compliance with this paragraph has been shown; or
- (2) It is shown that the lesser angle can not be exceeded in service.

(b) The external load attaching means, for jettisonable rotorcraft load combinations, must include a quick release system to enable the pilot to release the external load quickly during flight. The quick release system must consist of a primary quick release subsystem and a backup quick release subsystem that are isolated from one another. The quick release system, and the means by which it is controlled, must comply with the following:

- (1) A control for the primary quick release subsystem must be installed either on one of the pilot's primary controls or in an equivalently accessible location and must be designed and located so that it may be operated by either the pilot or a crewmember without hazardously limiting the ability to control the rotorcraft during an emergency situation.
- (2) A control for the backup quick release subsystem, readily accessible to either the pilot or another crewmember, must be provided.
- (3) Both the primary and backup quick release subsystems must—
  - (i) Be reliable, durable, and function properly with all external loads up to and including the maximum external limit load for which authorization is requested.
  - (ii) Be protected against electromagnetic interference (EMI) from external and internal sources and against lightning to prevent inadvertent load release.
    - (A) The minimum level of protection required for jettisonable rotorcraft load combinations used for nonhuman external cargo is a radio frequency field strength of 20 volts per meter.
    - (B) The minimum level of protection required for jettisonable rotorcraft load combinations used for human external cargo is a radio frequency field strength of 200 volts per meter.
  - (iii) Be protected against any failure that could be induced by a failure mode of any other electrical or mechanical rotorcraft system.
- (e) For rotorcraft load combinations to be used for human external cargo applications, the rotorcraft must—
  - (1) For jettisonable external loads, have a quick release system that meets the requirements of paragraph (b) of this section and that—
    - (i) Provides a dual actuation device for the primary quick release subsystem, and
    - (ii) Provides a separate dual actuation device for the backup quick release subsystem;
  - (2) Have a reliable, approved personnel carrying device system that has the structural capability and personnel safety features essential for external occupant safety;
  - (3) Have placards and markings at all appropriate locations that clearly state the essential system operating instructions and, for the personnel carrying device system, the ingress and egress instructions;
  - (4) Have equipment to allow direct intercommunication among required crewmembers and external occupants; and
  - (5) Have the appropriate limitations and procedures incorporated in the flight manual for conducting human external cargo operations.
- (d) The critically configured jettisonable external loads must be shown by a combination of analysis, ground tests, and flight tests to be both transportable and releasable throughout the approved operational envelope without hazard to the rotorcraft during normal flight conditions. In addition, these external loads must be shown to be releasable without hazard to the rotorcraft during emergency flight conditions.
- (be) A placard or marking must be installed next to the external-load attaching means clearly stating any operational limitations and the maximum authorized external load as demonstrated under §27.25 and this section.
- (cf) The fatigue evaluation of §27.571 of this part does not apply to rotorcraft-load combinations to be used for nonhuman external cargo except for the failure of critical structural elements that would result in a hazard to the *crew* rotorcraft. For rotorcraft load combinations to be used for human external cargo, the fatigue evaluation of §27.571 of this part applies to the entire quick release and personnel carrying device structural systems and their attachments.

Rationale: If the operation or mission requires carrying an external load, then it is important to ensure that the means of attaching the external load is sufficient to carry that load and that the limitations and are clearly identified. It is also important that the means of attaching the external load do not fail due to fatigue, especially during takeoff



and landing, when crewmembers may be proximate.

#### Miscellaneous

##### §27.871 Leveling marks -- Excluded

Summary: This paragraph requires marking in order to level the rotorcraft to affect stability (for loading conditions)

Rationale: This requirement is not directly relevant to a primary hazard identified in the hazard analysis for this operational context.

##### §27.873 Ballast provisions – As is

Ballast provisions must be designed and constructed to prevent inadvertent shifting of ballast in flight.

Rationale: Ballast may be necessary for some types of UAS operations, e.g., cargo operations.

#### 14 CFR Part 27, Subpart E—Powerplant

#### General

##### §27.901 Installation -- Excluded

Summary: This paragraph defines powerplant installation and establishes high-level safety requirements for continued operations between inspections/overhauls, electrical connections, accessibility, etc., and requires installation in accordance with Part 33 requirements.

Rationale: The hazard that underlies this requirement is relevant to a UAS with characteristics as in Table B1, but not to the same degree as for a Part 27 rotorcraft. The high-level safety requirements were, in part, established to provide safety for onboard occupants, which would not apply to a UAS. Use of a Part 33 certified engine is not required, and thus Part 33 installation requirements would not apply. Minimum safety requirements relevant to the UAS powerplant are covered adequately in other paragraphs and the suggested PPS requirement.

##### §27.903 Engines -- Modified

~~(a) *Engine type certification.* Each engine must have an approved type certificate. Reciprocating engines for use in helicopters must be qualified in accordance with §33.49(d) of this chapter or be otherwise approved for the intended usage.~~

~~(b) *Engine or drive system cooling fan blade protection.* (1) If an engine or rotor drive system cooling fan is installed, there must be a means to protect the rotorcraft and allow a safe landing if a fan blade fails. This must be shown by showing that—~~

~~(i) The fan blades are contained in case of failure;~~

~~(ii) Each fan is located so that a failure will not jeopardize safety; or~~

~~(iii) Each fan blade can withstand an ultimate load of 1.5 times the centrifugal force resulting from operation limited by the following:~~

~~(A) For fans driven directly by the engine—~~

~~(1) The terminal engine r.p.m. under uncontrolled conditions; or~~

~~(2) An overspeed limiting device.~~

~~(B) For fans driven by the rotor drive system, the maximum rotor drive system rotational speed to be expected in service, including transients.~~

~~(2) Unless a fatigue evaluation under §27.571 is conducted, it must be shown that cooling fan blades are not operating at resonant conditions within the operating limits of the rotorcraft.~~

~~(c) *Turbine engine installation.* For turbine engine installations, the powerplant systems associated with engine control devices, systems, and instrumentation must be designed to give reasonable assurance that those engine operating limitations that adversely affect turbine rotor structural integrity will not be exceeded in service.~~

~~(d) *Restart capability.* A means to restart any engine in flight must be provided.~~

~~(1) Except for the in-flight shutdown of all engines, engine restart capability must be demonstrated throughout a flight envelope for the rotorcraft.~~

~~(2) Following the in-flight shutdown of all engines, in-flight engine restart capability must be provided.~~

Rationale: Subparagraph (a) is deleted because a certified engine is not required, as hull loss inside the containment region is not catastrophic. Subparagraph (b) is deleted because the unmanned rotorcraft does not need to be protected if a fan blade fails, as hull loss in the containment area is not catastrophic. Subparagraph (c) is kept because it helps mitigate hazards associated with high energy parts exiting the containment area. Subparagraph (d) is deleted because restart capability is not required as hull loss in the containment area is not catastrophic.

**§27.907 Engine vibration -- Modified**

- (a) Each engine must be installed to prevent the harmful vibration of any part of the engine or rotorcraft.
- ~~(b) The addition of the rotor and the rotor drive system to the engine may not subject the principal rotating parts of the engine to excessive vibration stresses. This must be shown by a vibration investigation.~~
- ~~(c) No part of the rotor drive system may be subjected to excessive vibration stresses.~~

Rationale: Subparagraphs (a) and (b) were deleted because engine integrity itself is not needed. Subparagraph (c) was kept because rotor drive integrity must be protected from destructive vibration, as this may lead to the hazard of high energy parts being ejected from the containment area.

**Rotor Drive System**

**§27.917 Design -- As is**

- (a) Each rotor drive system must incorporate a unit for each engine to automatically disengage that engine from the main and auxiliary rotors if that engine fails.
- (b) Each rotor drive system must be arranged so that each rotor necessary for control in autorotation will continue to be driven by the main rotors after disengagement of the engine from the main and auxiliary rotors.
- (c) If a torque limiting device is used in the rotor drive system, it must be located so as to allow continued control of the rotorcraft when the device is operating.
- (d) The rotor drive system includes any part necessary to transmit power from the engines to the rotor hubs. This includes gear boxes, shafting, universal joints, couplings, rotor brake assemblies, clutches, supporting bearings for shafting, any attendant accessory pads or drives, and any cooling fans that are a part of, attached to, or mounted on the rotor drive system.

Rationale: Subparagraphs (a) and (d) are kept because rotors must be protected from engine seizures/failures to prevent high energy parts from being ejected from the containment area. Subparagraph (b) is retained because autorotation is a required function to prevent loss of rotor system integrity. Subparagraph (c) is retained to ensure control is maintained during autorotation.

**§27.921 Rotor brake -- As is**

If there is a means to control the rotation of the rotor drive system independently of the engine, any limitations on the use of that means must be specified, and the control for that means must be guarded to prevent inadvertent operation.

Rationale: A rotor brake engaging inadvertently could lead to rotor integrity being compromised.

**§27.923 Rotor drive system and control mechanism tests -- Excluded**

Summary: This paragraph establishes specific hourly or cycle requirements for testing of rotor systems and associated components.

Rationale: Testing requirements such as these would not be directly applicable when hull loss is acceptable under this operational context.

**§27.927 Additional tests -- Rolled up to the suggested SI requirement**

Summary: This paragraph defines additional rotor system tests that apply if the torque going from the engine to the transmission is not under direct pilot control and other conditions specific to multi-engine turbine installations.

Rationale: Rotor system torque is not under direct control of the pilot in this operational context. Over-torque conditions would represent a hazard to rotor system integrity and thus the testing requirements are rolled up to the suggested SI requirement as part of the overall protection of the rotor system.

**§27.931 Shafting critical speed -- As is**

- (a) The critical speeds of any shafting must be determined by demonstration except that analytical methods may be used if reliable methods of analysis are available for the particular design.
- (b) If any critical speed lies within, or close to, the operating ranges for idling, power on, and autorotative conditions, the stresses occurring at that speed must be within safe limits. This must be shown by tests.
- (c) If analytical methods are used and show that no critical speed lies within the permissible operating ranges, the margins between the calculated critical speeds and the limits of the allowable operating ranges must be adequate to allow for possible variations between the computed and actual values.

Rationale: This requirement is important to maintain rotor drive shaft system integrity.

**§27.935 Shafting joints -- As is**

Each universal joint, slip joint, and other shafting joints whose lubrication is necessary for operation must have

provision for lubrication.

Rationale: This requirement is important to maintain rotor drive shaft system integrity.

**§27.939 Turbine engine operating characteristics -- Modified**

~~(a) Turbine engine operating characteristics must be investigated in flight to determine that no adverse characteristics (such as stall, surge, or flameout) are present, to a hazardous degree, during normal and emergency operation within the range of operating limitations of the rotorcraft and of the engine.~~

~~(b) The turbine engine air inlet system may not, as a result of airflow distortion during normal operation, cause vibration harmful to the engine.~~

(c) For governor-controlled engines, it must be shown that there exists no hazardous torsional instability of the drive system associated with critical combinations of power, rotational speed, and control displacement.

Rationale: Subparagraphs (a) and (b) were excluded because they do not relate to a hazard. However, subparagraph (c) is relevant because the hazard of over-torque of the transmission/rotor system from loss of governor control should be mitigated to prevent loss of rotor system integrity.

**Fuel System**

**§27.951 General -- Excluded**

Summary: This paragraph establishes requirements for fuel system design and installation to ensure continued operation of the engine.

Rationale Continued operation of the engine is not a safety issue in this operational context provided that the device required by §27.917(a) is installed. Hull loss is not a safety hazard, but loss of rotor system integrity is.

**§27.952 Fuel system crash resistance -- Excluded**

Summary: This paragraph establishes design and testing requirements for fuel tanks.

Rationale: The hazard that underlies this requirement is relevant to a UAS with characteristics as in Table B1, but not to the same degree as for a Part 27 rotorcraft. The fuel tank does not need to meet crashworthiness requirements for manned vehicles.

**§27.953 Fuel system independence -- Excluded**

Summary: This paragraph establishes requirements for single and multiple fuel tanks in multiengine rotorcraft.

Rationale: This requirement is not directly relevant to a primary hazard identified in the hazard analysis for this operational context. Reliable fuel flow to multiple engines not required since hull loss is acceptable.

**§27.954 Fuel system lightning protection -- Excluded**

Summary: This paragraph establishes requirements for fuel system protection from lightning strikes.

Rationale: Out of scope of the operational context in Table B1. The operational context assumes no operations in thunderstorms/lightning conditions. Risk associated with the possibility of a lightning strike on the ground and potential harm to the crew should be considered in operational procedures.

**§27.955 Fuel flow -- Excluded**

Summary: This paragraph establishes requirements to ensure stable fuel flow to the engine.

Rationale: Continued operation of the engine is not a safety issue in this operational context provided that the device required by 27.917(a) is installed. Hull loss is not a safety hazard, but loss of rotor system integrity is.

**§27.959 Unusable fuel supply -- Excluded**

Summary: This paragraph establishes requirements to determine minimum usable fuel.

Rationale: Continued operation of the engine is not a safety issue in this operational context provided that the device required by 27.917(a) is installed. Hull loss is not a safety hazard, but loss of rotor system integrity is.

**§27.961 Fuel system hot weather operation -- Excluded**

Summary: This paragraph establishes requirements for fuel system operations at fuel temperature up to 110 deg. F.

Rationale: Continued operation of the engine is not a safety issue in this operational context provided that the device required by 27.917(a) is installed. Hull loss is not a safety hazard, but loss of rotor system integrity is.

**§27.963 Fuel tanks: general -- Rolled up to the suggested PPS requirement**

Summary: This paragraph establishes general requirements for fuel tank design, construction and installation, including such features as baffling, vibration resistance, inertia and fuel loading structural requirements, and ventilation requirements.

Rationale: These requirements are necessary in some form to mitigate a possible explosion hazard should fuel escape from the fuel tank during operations. The requirements were rolled up in the suggested PPS requirement into a general statement that the applicant determines safety critical conditions including consideration of fuel tank design, construction, and installation.

**§27.965 Fuel tank tests -- Rolled up to the suggested PPS requirement**

Summary: This paragraph specifies conditions under which fuel tanks must be tested to show structural integrity, including pressures, times, vibrations, etc.

Rationale: As in §27.963, this paragraph relates to ensuring explosion resistance of the fuel tank installation and was rolled up into the generalized requirement suggested for PPS.

**§27.967 Fuel tank installation -- Rolled up to the suggested PPS requirement**

Summary: This paragraph requires that fuel tanks be installed in such a way that they are properly supported and provided adequate protection against expected loads.

Rationale: This paragraph was rolled up in the suggested PPS requirement for the same reasons as §27.963 and §27.965.

**§27.969 Fuel tank expansion space -- As is**

Each fuel tank or each group of fuel tanks with interconnected vent systems must have an expansion space of not less than 2 percent of the tank capacity. It must be impossible to fill the fuel tank expansion space inadvertently with the rotorcraft in the normal ground attitude.

Rationale: Fuel tanks require expansion space to preclude fuel being forced out of the tank vent, which could present an explosion and subsequent release of high-energy parts.

**§27.971 Fuel tank sump -- Excluded**

Summary: This paragraph establishes requirements for a drainable fuel sump and sets minimum size to minimize possibility of water or sediment in the fuel, which could lead to engine malfunction.

Rationale: Continued operation of the engine is not a safety issue in this operational context provided that the device required by §27.917(a) is installed. Hull loss is not a safety hazard, but loss of rotor system integrity is.

**§27.973 Fuel tank filler connection -- Modified**

(a) Each fuel tank filler connection must prevent the entrance of fuel into any part of the rotorcraft other than the tank itself during normal operations ~~and must be crash resistant during a survivable impact in accordance with §27.952(c).~~  
In addition—

(1) Each filler must be marked as prescribed in §27.1557(c)(1);

(2) Each recessed filler connection that can retain any appreciable quantity of fuel must have a drain that discharges clear of the entire rotorcraft; and

(3) Each filler cap must provide a fuel-tight seal under the fluid pressure expected in normal operation ~~and in a survivable impact.~~

(b) Each filler cap or filler cap cover must warn when the cap is not fully locked or seated on the filler connection.

Rationale: Fuel must stay in the fuel tank to avoid possible inadvertent ignition. This protects the ground crew (e.g., when the rotorcraft is landing or taking off). Fuel tank filler connections need not preserve hull integrity during a crash because the fuel system itself is not required to be crash resistant.

Subparagraph (3) was kept because fuel vapors leaking from a loose or faulty fuel cap could be an inflight or ground fire or explosion hazard. Thus the filler cap should be required to provide a fuel-tight seal.

Subparagraph (b) was kept because ground crew must be warned if the filler cap is not properly locked or seated on the filler connection, in order to preserve ground crew safety.

**§27.975 Fuel tank vents -- Modified**

(a) Each fuel tank must be vented from the top part of the expansion space so that venting is effective under all normal flight conditions. Each vent must minimize the probability of stoppage by dirt or ice.

(b) The venting system must be designed to minimize spillage of fuel through the vents to an ignition source in the event of a rollover during landing *or* ground operation; ~~or a survivable impact.~~

Rationale: Venting is required to mitigate the possibility of over pressurization of the fuel tank resulting in rupture which would present an explosion hazard with subsequent release of high-energy parts. Design for survivable impact is not necessary because there are no humans on board.

**§27.977 Fuel tank outlet -- Excluded**

Summary: This paragraph establishes requirements for fuel outlets and strainers that relate to maintaining fuel flow to the engine.

Rationale: The hazard that underlies this requirement is relevant to a UAS with characteristics as in Table B1, but not to the same degree as for a Part 27 rotorcraft. Continued operation of the engine is not a safety issue in this operational context provided that the device required by §27.917(a) is installed. Hull loss is not a safety hazard, but loss of rotor system integrity is.

### **Fuel System Components**

#### **§27.991 Fuel pumps -- Excluded**

Summary: This paragraph establishes failure conditions that must not jeopardize compliance with §27.955.

Rationale: Continued operation of the engine is not a safety issue in this operational context provided that the device required by §27.917(a) is installed. Hull loss is not a safety hazard, but loss of rotor system integrity is. The requirements of §27.955 were also excluded.

#### **§27.993 Fuel system lines and fittings -- Rolled up to the suggested PPS requirement**

Summary: This paragraph sets requirements for fuel lines and fittings that safely accommodate high temperatures, vibration, and relative motion of components.

Rationale: Failure to comply with the spirit of these requirements in some form could result in a fuel system explosion hazard, but the requirement as written might be too restrictive for an unmanned system design that could tolerate hull losses under some conditions. Thus, the requirement was rolled up in the more general requirements suggested for PPS.

#### **§27.995 Fuel valves -- Rolled up the suggested PPS requirement**

Summary: This paragraph establishes requirements for the locations, responsiveness, and controls for fuel valves.

Rationale: As in §27.993, failure to comply with the spirit of these requirements in some form could result in a fuel system explosion hazard, but the requirement as written might be too restrictive for an unmanned system design that could tolerate hull losses under some conditions. The requirement was rolled up under the more general requirement suggested for PPS.

#### **§27.997 Fuel strainer or filter -- Excluded except for (c), which is rolled up to the suggested PPS requirement**

Summary: This paragraph establishes requirements for fuel strainers and filters. Subparagraph (c) establishes requirements for structural mounting of any fuel strainer or filter installed.

Rationale: Failure of the fuel filter/strainer mounting (if installed) could lead to a failure to contain fuel within the fuel system and an explosion hazard. Subparagraph (c) was rolled up into the suggested PPS requirement.

#### **§27.999 Fuel system drains -- Excluded except for (b)(2), which is rolled up to the suggested PPS requirement**

Summary: This paragraph establishes requirements on fuel system drains. Subparagraph (b)(2) establishes requirements for positive closure of fuel system drains.

Rationale: Since leaking fuel from a fuel system drain could represent an explosion hazard, this subparagraph was rolled up to the suggested PPS requirement for consideration during powerplant and supporting systems design.

### **Oil System**

#### **§27.1011 Engines: General -- Excluded**

Summary: This paragraph establishes design requirements for engine oil system(s) that ensure adequate oil supply to the engine under continuous operations.

Rationale: Continued operation of the engine is not a safety issue in this operational context provided that the device required by §27.917(a) is installed. Hull loss is not a safety hazard, but loss of rotor system integrity is.

#### **§27.1013 Oil tanks -- Rolled up to the suggested PPS requirement**

Summary: This paragraph establishes general requirements for oil tank design, construction and installation.

Rationale: These requirements may be necessary in some form to mitigate a possible explosion hazard should oil escape from the oil tank during operations. The requirements were rolled up into the general requirement suggested for PPS.

#### **§27.1015 Oil tank tests -- Rolled up to the suggested PPS requirement**

Summary: This paragraph specifies conditions under which oil tanks must be tested to show structural integrity.  
Rationale: As in §27.965 for fuel tank testing, this paragraph was considered to relate to ensuring explosion resistance of the oil tank installation and was rolled up into the generalized requirement suggested for PPS.

**§27.1017 Oil lines and fittings -- Rolled up to the suggested PPS requirement**

Summary: This paragraph sets requirements for oil lines and fittings that safely accommodate high temperatures, vibration and relative motion of components.

Rationale: Similar to the reasoning for §27.997 for fuel system lines and fittings, failure to comply with the spirit of these requirements in some form could result in an oil system explosion hazard. Thus, this requirement was rolled up as part of the more general requirement suggested for PPS.

**§27.1019 Oil strainer or filter -- Excluded**

Summary: This paragraph establishes requirements for oil strainers, filters, and bypasses that ensure uninterrupted flow of oil to the engine.

Rationale: Continued operation of the engine is not a safety issue in this operational context provided that the device required by §27.917(a) is installed. Hull loss is not a safety hazard, but loss of rotor system integrity is.

**§27.1021 Oil system drains -- Rolled up to the suggested PPS requirement**

Summary: Similar to the requirements of §27.999 for fuel system drains, this requirement establishes requirements for positive closure of oil system drains.

Rationale: Since leaking oil from an oil system drain could represent an explosion hazard, this subparagraph was rolled up to the suggested PPS requirement for consideration during powerplant and supporting systems design.

**§27.1027 Transmission and gearboxes -- Modified**

(a) The lubrication system for components of the rotor drive system that require continuous lubrication must be sufficiently independent of the lubrication systems of the engine(s) to ensure lubrication during autorotation.

(b) ~~Pressure lubrication systems for transmissions and gearboxes must comply with the engine oil system requirements of §§27.1013 (except paragraph (e)), 27.1015, 27.1017, 27.1021, and 27.1337(d).~~

(c) ~~Each pressure lubrication system must have an oil strainer or filter through which all of the lubricant flows and must—~~

~~(1) Be designed to remove from the lubricant any contaminant which may damage transmission and drive system components or impede the flow of lubricant to a hazardous degree;~~

~~(2) Be equipped with a means to indicate collection of contaminants on the filter or strainer at or before opening of the bypass required by paragraph (c)(3) of this section; and~~

~~(3) Be equipped with a bypass constructed and installed so that—~~

~~(i) The lubricant will flow at the normal rate through the rest of the system with the strainer or filter completely blocked; and~~

~~(ii) The release of collected contaminants is minimized by appropriate location of the bypass to ensure that collected contaminants are not in the bypass flowpath.~~

~~(d) For each lubricant tank or sump outlet supplying lubrication to rotor drive systems and rotor drive system components, a screen must be provided to prevent entrance into the lubrication system of any object that might obstruct the flow of lubricant from the outlet to the filter required by paragraph (c) of this section. The requirements of paragraph (c) do not apply to screens installed at lubricant tank or sump outlets.~~

~~(e) Splash-type lubrication systems for rotor drive system gearboxes must comply with §§27.1021 and 27.1337(d).~~

Rationale: Subparagraph (a) was kept because lubrication of the rotor drive system must continue independently of engine lubrication system in order to maintain rotor drive system integrity and prevent high energy parts from exiting the containment area during autorotation. Other than this, lubrication of the transmission and gearboxes need not be required to maintain hull integrity.

**Cooling**

**§27.1041 General -- Rolled up to the suggested PPS requirement**

Summary: This paragraph establishes requirements that the cooling system be capable of maintaining the temperatures of powerplant components, including rotor system components, within established temperature limits under critical surface and flight operating conditions.

Rationale: Since compliance with the general requirements of this paragraph could affect rotor system integrity, the requirement was rolled up for consideration in the generalized requirement suggested for PPS.

**§27.1043 Cooling tests -- Excluded**

Summary: Along with §27.1045, this paragraph establishes conditions and requirements for conducting cooling tests on engines.

Rationale: Specific tests for cooling are excluded in deference to the general proof of compliance requirements in §27.21.

**§27.1045 Cooling test procedures -- Excluded**

Summary: Along with §27.1043, this paragraph establishes conditions and requirements for conducting cooling tests on engines.

Rationale: Specific test procedures for cooling are excluded in deference to the general proof of compliance requirements in §27.21.

**Induction System**

**§27.1091 Air induction -- Rolled up to the suggested PPS requirement**

Summary: This paragraph establishes requirements for air induction systems. In particular, if fuel can accumulate in the system, the system must have drains that discharge fuel clear of the rotorcraft and out of the path of exhaust flames. Additionally, for turbine powered rotorcraft, the paragraph requires that there must be means to prevent hazardous quantities of fuel leakage or overflow from drains.

Rationale: Since compliance with some of the provisions of this paragraph could relate to the mitigation of an explosion hazard, the requirement was rolled up into the generalized requirement suggested for PPS.

**§27.1093 Induction system icing protection -- Excluded**

Summary: This paragraph establishes induction icing requirements for reciprocating and turbine engines and test conditions for demonstrating compliance. Preventing induction icing helps prevent damage to the engine and loss of performance.

Rationale: The hazard that underlies this requirement is relevant to a UAS with characteristics as in Table B1, but not to the same degree as for a Part 27 rotorcraft. For this operational context, damage to engine and loss of performance may be acceptable under some conditions, including ice ingestion. Engine failure is not a safety hazard as long as the rotor system is protected by a clutch-like device (as required by §27.917).

**Exhaust System**

**§27.1121 General -- Rolled up to the suggested PPS requirement**

Summary: This paragraph establishes requirements for the design and installation of the rotorcraft exhaust system to prevent ignition of flammable fluids or vapors and accommodate vibration, expansion, and other physical characteristics of the rotorcraft environment.

Rationale: The requirements are applicable, but only to mitigate the possibility of an inflight or ground explosion, which could result in the release of high-energy parts which could be a hazard to bystanders or crewmembers during servicing and loading operations. The requirement was rolled up into the general requirement suggested for PPS.

**§27.1123 Exhaust piping -- Rolled up to the suggested PPS requirement**

Summary: This paragraph establishes requirements for exhaust system design, including requirements that the exhaust system must prevent local hot spots and exhaust gases must discharge clear of fuel system components and drains. The paragraph also requires that exhaust system parts with a surface hot enough to ignite flammable fluids or vapors must be located or shielded so that leakage from any system carrying flammable fluids or vapors will not result in a fire.

Rationale: Since this paragraph relates to design features that could prevent explosions, it was rolled up under the generalized requirement suggested for PPS.

**Powerplant Controls and Accessories**

**§27.1141 Powerplant controls: general -- Excluded except for (d) and (e), which are rolled up to the suggested PPS requirement**

Summary: This paragraph establishes requirements for design and operation of powerplant controls to ensure continued safe operations.

Rationale: Subparagraph (d) is rolled up because verification of fuel valve position can be relevant to the pilot's safety role. Subparagraph (e) is rolled up to the suggested PPS requirement to ensure that loss of governor control for a turbine engine cannot jeopardize transmission or rotor system integrity due to over-torque.

<p><b>§27.1143 Engine controls -- Excluded</b>  Summary: This paragraph establishes design requirements for fuel shutoffs and controls for multiple engines.  Rationale: There is no safety requirement because engine failure resulting in hull loss is not a hazard in this operational context.</p>
<p><b>§27.1145 Ignition switches -- Excluded</b>  Summary: This paragraph establishes design requirements to prevent inadvertent activation of ignition switches and gang operation of multiple ignition switches.  Rationale: Engine failure due to inappropriate use of ignition switches resulting in hull loss is not a hazard in this operational context.</p>
<p><b>§27.1147 Mixture controls -- Excluded</b>  Summary: This paragraph establishes requirements to be able to control mixtures for multiple engines both separately and together.  Rationale: Engine failure due to inappropriate use of mixture controls resulting in hull loss is not a hazard in this operational context.</p>
<p><b>§27.1151 Rotor brake controls -- Rolled (a) up to the CMS(a) and SI requirements</b>  Summary: Subparagraph (a) requires that it must be impossible to apply the rotor brake inadvertently in flight and that crew notification occur if a rotor brake is not released before takeoff  Rationale: Inadvertent application of the rotor brake in flight while torque is being applied to the rotor would be a significant hazard to rotor system integrity. Thus, subparagraph (a) is a requirement on the design of the control system and is rolled up to the suggested CMS(a) and SI requirements. Subparagraph (b) is excluded because a warning system is not required in the ground control station.</p>
<p><b>§27.1163 Powerplant accessories -- Rolled up to the suggested PPS requirement</b>  Summary: This paragraph establishes requirements for mounting accessories to prevent damage to the engine or dragging on rotor system.  Rationale: Requirements related to engine protection are not applicable. Subparagraph (b) establishes accessory drive requirements that relate to protecting the transmission and rotor system from excessive accessory drive loads. This requirement is rolled up to the suggested PPS requirement.</p>
<p><b>Powerplant Fire Protection</b></p>
<p><b>§27.1183 Lines, fittings, and components -- Rolled up to the suggested PPS requirement</b>  Summary: This paragraph establishes requirements for fire resistance and fire proofing for fuel lines, fittings, and components. These requirements relate directly to preventing onboard fires and/or explosions.  Rationale: The requirements as written may be too specific for an unmanned vehicle where hull losses can be tolerated under some conditions, so the requirements were rolled up into the more general language of the suggested PPS requirement.</p>
<p><b>§27.1185 Flammable fluids -- Rolled up to the suggested PPS requirement</b>  Summary: This paragraph establishes design and installation requirements for firewalls, fuel tanks, and fuel system components in areas where flammable fluids are present.  Rationale: The requirements as written may be too specific for an unmanned vehicle where hull losses can be tolerated under some conditions, so the requirements were rolled up into the more general language of the suggested PPS requirement.</p>
<p><b>§27.1187 Ventilation and drainage -- Rolled up to the suggested PPS requirement</b>  Summary: This paragraph establishes requirements for ventilation and drainage for any compartment that contains part of the powerplant installation so as not to create a fire hazard.  Rationale: The details of the paragraph were considered to be too specific for an unmanned aircraft, but there still exists a requirement to protect crew when servicing the rotorcraft. Lack of compliance with the spirit of the paragraph could create an explosion hazard that would put both ground crew and bystanders at risk from flying debris, so the specific requirements of this paragraph were rolled up into the more general language of the suggested PPS requirement.</p>
<p><b>§27.1189 Shutoff means -- Rolled up to the suggested PPS requirement</b>  Summary: This paragraph establishes requirements for a means to shut off each line carrying flammable fluids into</p>



the engine compartment, with a number of exceptions listed.

Rationale: The details of the paragraph were considered too specific for an unmanned aircraft, but a lack of compliance with the spirit of this paragraph could present a hazard to crew when servicing the helicopter. The specific requirements of this paragraph were rolled up into the more general language of the suggested PPS requirement.

**§27.1191 Firewalls -- Rolled up to the suggested PPS requirement**

Summary: This paragraph establishes requirements for firewalls, or equivalents, to protect personnel compartments, structures, controls, rotor mechanisms, etc.

Rationale: While there are no personnel compartments in the UAS to protect, the destruction of systems that could lead to loss of rotor system integrity were considered relevant. The details of the paragraph were considered too specific for an unmanned aircraft, so the specific requirements of this paragraph were rolled up into the more general language of the suggested PPS requirement.

**§27.1193 Cowling and engine compartment covering -- Rolled up to the suggested PPS and SI requirements**

Summary: This paragraph establishes requirements for engine compartment covers that minimize fire hazards and protect rotor system components in the event of structural or mechanical failure of the normal retention means.

Rationale: The requirements of the paragraph were considered relevant to protecting the integrity of the rotor system and supporting structure and relevant to protecting UAS crew during servicing. The paragraph was rolled up into the suggested requirements for PPS and SI.

**§27.1194 Other surfaces -- Excluded**

Summary: This paragraph requires fire resistance on surfaces aft of the engine compartment.

Rationale: This requirement is not directly relevant to a primary hazard identified in the hazard analysis for this operational context.

**§27.1195 Fire detector systems -- Excluded**

Summary: This paragraph requires fire detectors in engine compartments that cannot be readily seen by the pilot.

Rationale: This requirement is not directly relevant to a primary hazard identified in the hazard analysis for this operational context. Fire detection and warning systems for onboard fires are not required because engine fire is not a primary hazard. Requirements for fire detection in a control station would likely be covered under OSHA requirements.

**14 CFR Part 27, Subpart F—Equipment**

**General**

**§27.1301 Function and Installation -- Modified**

Each item of installed equipment, *whose failure could adversely affect safety*, must—

- (a) Be of a kind and design appropriate to its intended function;
- (b) Be labeled as to its identification, function, or operating limitations, or any applicable combination of these factors;
- (c) Be installed according to limitations specified for that equipment; and
- (d) Function properly when installed

Rationale: Since loss of vehicle may not have safety implications, this requirement is limited to only those pieces of equipment whose failure would affect safety.

**§27.1303 Flight and navigation instruments -- Modified**

*The applicant must demonstrate that sufficient information is provided to the pilot to monitor and control the flight path of the rotorcraft within the approved operational envelope and operational (containment) volume. Considerations should include, but are not limited to* the following ~~are the required~~ flight and navigation instruments:

instruments:

- (a) An airspeed indicator.
- (b) An altimeter.
- (c) A magnetic direction indicator.
- (d) A vehicle position indicator.*
- (e) A vehicle health status indicator.*

Rationale: The original text presupposes that a pilot will have the ability to “hand-fly” the rotorcraft and needs

information from the specified instruments to do that. Inner loop control is not consistent with UAS characteristics given in Table B1. So, the requirement is rewritten to ensure that sufficient information is provided to the pilot to monitor and control the flight path without prescribing specific instruments or marking for those instruments. The dominant role of the pilot is expected to be to monitor instead of control the flight path. Instruments providing information about the vehicle position and health status might be useful for pilot and crew situational awareness.

**§27.1305 Powerplant limitations -- Modified**

*The applicant must demonstrate that sufficient information is provided to the pilot to monitor the powerplant to avoid failures that adversely affect safety. Considerations should include, but are not limited to the following for all engines, tanks, and pumps are the required powerplant instruments:*

*(e) Oil temperature, pressure, and quantity.*

*(f) Rotor and engine r.p.m.*

*(g) Gas temperature.*

*(h) Ferromagnetic particle detection.*

~~(a) A carburetor air temperature indicator, for each engine having a preheater that can provide a heat rise in excess of 60 °F.~~

~~(b) A cylinder head temperature indicator, for each —~~

~~(1) Air cooled engine;~~

~~(2) Rotorcraft with cooling shutters; and~~

~~(3) Rotorcraft for which compliance with §27.1043 is shown in any condition other than the most critical flight condition with respect to cooling.~~

~~(c) A fuel pressure indicator, for each pump fed engine.~~

~~(d) A fuel quantity indicator, for each fuel tank.~~

~~(e) A manifold pressure indicator, for each altitude engine.~~

~~(f) An oil temperature warning device to indicate when the temperature exceeds a safe value in each main rotor drive gearbox (including any gearboxes essential to rotor phasing) having an oil system independent of the engine oil system.~~

~~(g) An oil pressure warning device to indicate when the pressure falls below a safe value in each pressure lubricated main rotor drive gearbox (including any gearboxes essential to rotor phasing) having an oil system independent of the engine oil system.~~

~~(h) An oil pressure indicator for each engine.~~

~~(i) An oil quantity indicator for each oil tank.~~

~~(j) An oil temperature indicator for each engine.~~

~~(k) At least one tachometer to indicate the r.p.m. of each engine and, as applicable —~~

~~(1) The r.p.m. of the single main rotor;~~

~~(2) The common r.p.m. of any main rotors whose speeds cannot vary appreciably with respect to each other; or~~

~~(3) The r.p.m. of each main rotor whose speed can vary appreciably with respect to that of another main rotor.~~

~~(4) A low fuel warning device for each fuel tank which feeds an engine. This device must —~~

~~(1) Provide a warning to the flightcrew when approximately 10 minutes of usable fuel remains in the tank; and~~

~~(2) Be independent of the normal fuel quantity indicating system.~~

~~(m) Means to indicate to the flightcrew the failure of any fuel pump installed to show compliance with §27.955.~~

~~(n) A gas temperature indicator for each turbine engine.~~

~~(o) Means to enable the pilot to determine the torque of each turboshaft engine, if a torque limitation is established for that engine under §27.1521(e).~~

~~(p) For each turbine engine, an indicator to indicate the functioning of the powerplant ice protection system.~~

~~(q) An indicator for the fuel filter required by §27.997 to indicate the occurrence of contamination of the filter at the degree established by the applicant in compliance with §27.955.~~

~~(r) For each turbine engine, a warning means for the oil strainer or filter required by §27.1019, if it has no bypass, to warn the pilot of the occurrence of contamination of the strainer or filter before it reaches the capacity established in accordance with §27.1019(a)(2).~~

~~(s) An indicator to indicate the functioning of any selectable or controllable heater used to prevent ice clogging of fuel system components.~~

~~(t) For rotorcraft for which a 30 second/2 minute OEI power rating is requested, a means must be provided to alert~~

the pilot when the engine is at the 30-second and the 2-minute OEI power levels, when the event begins, and when the time interval expires.

(u) For each turbine engine utilizing 30-second/2-minute OEI power, a device or system must be provided for use by ground personnel which—

- (1) Automatically records each usage and duration of power at the 30-second and 2-minute OEI levels;
- (2) Permits retrieval of the recorded data;
- (3) Can be reset only by ground maintenance personnel; and
- (4) Has a means to verify proper operation of the system or device.

(v) Warning or caution devices to signal to the flight crew when ferromagnetic particles are detected by the chip detector required by §27.1337(e).

Rationale: The original text specifies a number of instruments required for the powerplant and limitations on those instruments. The requirements were considered too prescriptive, but the general intent that there are a number of instruments and attributes important to the pilot regarding the powerplant system is relevant, and was abstracted as proposed.

#### **§27.1307 Miscellaneous equipment -- Modified**

The following is the required miscellaneous equipment *if its whose failure could adversely affect safety*:

- (a) ~~An approved seat for each occupant.~~
- (b) ~~An approved safety belt for each occupant.~~
- (ae) A master switch arrangement.
- (bd) An adequate source of electrical energy, where electrical energy is necessary for operation of the rotorcraft.
- (ce) Electrical protective devices *for those items with safety effects*.

Rationale: This miscellaneous equipment is only required if its failure would affect safety. Since there are no vehicle occupants, there is no need for seats or seat belts. A master switch is required to protect the crew from unintended startup. Ground control station operators are not expected to be located in moving vehicles. Electrical protective devices (e.g., fuses) are required to protect safety-critical systems. Electrical protection devices might benefit other electrical devices (e.g., cargo or spray equipment) but are not required for the rotorcraft to be airworthy.

#### **§27.1309 Equipment, systems, and installations -- Modified**

(a) The equipment, systems, and installations whose functioning is required *by this set of requirements* ~~by this subchapter~~ must be designed and installed to ensure that they perform their intended functions under any foreseeable operating condition.

(b) The equipment, systems, and installations of a multiengine rotorcraft must be designed to prevent hazards to the rotorcraft in the event of a probable malfunction or failure.

(c) The equipment, systems, and installations of single-engine rotorcraft must be designed to minimize hazards ~~to the rotorcraft~~ in the event of a probable malfunction or failure.

Rationale: Subparagraphs (a), (b), and (c) apply.

#### **§27.1316 Electrical and electronic system lightning protection -- Excluded**

Summary: This paragraph requires electronic components to continue to function correctly in the presence of lightning.

Rationale: Out of scope of the operational context in Table B1 (i.e., no operations in thunderstorms/lightning conditions).

#### **§27.1317 High-intensity Radiated Fields Protection -- Modified**

(a) ~~Except as provided in paragraph (d) of this section,~~ Each electrical and electronic system that performs a function whose failure *could adversely affect safety* ~~would prevent the continued safe flight and landing of the rotorcraft~~ must be designed and installed so that *they comply with HIRF considerations (TBD) determined to affect UAS*.

(1) ~~The function is not adversely affected during and after the time the rotorcraft is exposed to HIRF environment I, as described in appendix D to this part;~~

(2) ~~The system automatically recovers normal operation of that function, in a timely manner, after the rotorcraft is exposed to HIRF environment I, as described in appendix D to this part, unless this conflicts with other operational or functional requirements of that system;~~

(3) ~~The system is not adversely affected during and after the time the rotorcraft is exposed to HIRF environment II, as described in appendix D to this part; and~~

(4) Each function required during operation under visual flight rules is not adversely affected during and after the time the rotorcraft is exposed to HIRF environment III, as described in appendix D to this part.

(b) Each electrical and electronic system that performs a function whose failure would significantly reduce the capability of the rotorcraft or the ability of the flightcrew to respond to an adverse operating condition must be designed and installed so the system is not adversely affected when the equipment providing these functions is exposed to equipment HIRF test level 1 or 2, as described in appendix D to this part.

(c) Each electrical and electronic system that performs a function whose failure would reduce the capability of the rotorcraft or the ability of the flightcrew to respond to an adverse operating condition, must be designed and installed so the system is not adversely affected when the equipment providing these functions is exposed to equipment HIRF test level 3, as described in appendix D to this part.

(d) Before December 1, 2012, an electrical or electronic system that performs a function whose failure would prevent the continued safe flight and landing of a rotorcraft may be designed and installed without meeting the provisions of paragraph (a) provided—

(1) The system has previously been shown to comply with special conditions for HIRF, prescribed under §21.16, issued before December 1, 2007;

(2) The HIRF immunity characteristics of the system have not changed since compliance with the special conditions was demonstrated; and

(3) The data used to demonstrate compliance with the special conditions is provided.

Rationale: The text in subparagraph (a) was generalized to make clear that any HIRF-induced effects that could cause safety issues must be mitigated; however, the expected level of HIRF environmental conditions is not known at this time. Subparagraphs (a)(1-4), (b), (c), and (d) were excluded for this reason.

#### Instruments: Installation

##### §27.1321 Arrangement and visibility -- Modified

(a) Each flight, navigation, and powerplant instrument ~~for use by any pilot~~ **required for the pilot in command** must be easily visible to him.

(b) For each multiengine rotorcraft, identical powerplant instruments must be located so as to prevent confusion as to which engine each instrument relates.

(c) ~~Instrument panel vibration may not damage, or impair the readability or accuracy of, any instrument.~~

(d) If a visual indicator is provided to indicate malfunction of an instrument **or system**, ~~that indicator~~ must be effective under all probable ~~cockpit lighting~~ **operating** conditions.

Rationale: Subparagraphs (a) and (b) were kept because instruments required by the UAS pilot should be easily visible and not confusing. Subparagraph (c) was deleted because the instrument panel is not located inside the vehicle; any vibration of the instrument panel is incidental. Thus, no specific requirement is provided. Subparagraph (d) was kept. The pilot displays are located in a ground control station. The design and operation at this station must accommodate different lighting and operating conditions.

##### §27.1322 Warning, caution, and advisory lights -- Modified

If warning, caution or advisory lights ~~are installed in the cockpit~~, **required by the type design are installed in the ground control station**, they must, unless otherwise approved by the Administrator, be—

- (a) Red, for warning lights (lights indicating a hazard which may require immediate corrective action);
- (b) Amber, for caution lights (lights indicating the possible need for future corrective action);
- (c) Green, for safe operation lights; and
- (d) Any other color, including white, for lights not described in paragraphs (a) through (c) of this section, provided the color differs sufficiently from the colors prescribed in paragraphs (a) through (c) of this section to avoid possible confusion.

Rationale: Text was modified because the warning, caution, and advisory lights, if any, will be located in the ground control station instead of a cockpit. If these lights are virtually implemented, they should comply with §27.1321.

##### §27.1323 Airspeed indicating system – Rolled up to the suggested CMS(a) and SI requirements

Summary: This paragraph provides various requirements for calibration of airspeed instruments.

Rationale: Given the operational context in Table B1, there is a requirement to establish a never-exceed speed,  $V_{NE}$ . Consequently, there is a need for some degree of airspeed indication (per requirement §27.1545), and some degree of ensuring the accuracy of that indication. So, this requirement was rolled up along with §27.1545 to the suggested requirements for CMS(a) and SI so that the applicant and regulator could determine the appropriate airspeed

measuring system requirements and calibration of any required airspeed indicating system.

**§27.1325 Static pressure systems -- Modified**

***If a static system is used in a safety-critical function,***

(a) each instrument with a static air ~~sensor case connections~~ must be vented so that the influence of rotorcraft speed, the opening and closing of windows, airflow variation, and moisture or other foreign matter does not seriously affect its accuracy.

(b) Each static pressure port must be designed and located in such manner that the correlation between air pressure in the static pressure system and true ambient atmospheric static pressure is not altered when the rotorcraft encounters icing conditions. An anti-icing means or an alternate source of static pressure may be used in showing compliance with this requirement. ~~If the reading of the altimeter, when on the alternate static pressure system, differs from the reading of the altimeter when on the primary static system by more than 50 feet, a correction card must be provided for the alternate static system.~~

~~(c) Except as provided in paragraph (d) of this section, if the static pressure system incorporates both a primary and an alternate static pressure source, the means for selecting one or the other source must be designed so that—~~

~~(1) When either source is selected, the other is blocked off; and~~

~~(2) Both sources cannot be blocked off simultaneously.~~

~~(d) For unpressurized rotorcraft, paragraph (c)(1) of this section does not apply if it can be demonstrated that the static pressure system calibration, when either static pressure source is selected is not changed by the other static pressure source being open or blocked.~~

Rationale: Some UAS may be designed without the need for a system to determine static pressure. Protection of static air sensors could be related to maintaining controllability and stability, which is related to maintaining rotor system integrity (see the suggested CMS requirements), as well as other safety critical functions (e.g., containment). Subparagraph (b) was included because maintaining stability and controllability in icing conditions relates to primary hazards if operations in icing conditions are specified in the operational context for the type design. Subparagraphs (c) and (d) were removed because the vehicle under consideration does not have multiple static pressure sources.

**§27.1327 Magnetic direction indicator -- Modified**

***If a magnetic direction indicator is included in the type design, then***

(a) Except as provided in paragraph (b) of this section—

(1) Each magnetic direction indicator must be installed so that its accuracy is not excessively affected by the rotorcraft's vibration or magnetic fields; and

(2) The compensated installation may not have a deviation, in level flight, greater than 10 degrees on any heading.

(b) A magnetic nonstabilized direction indicator may deviate more than 10 degrees due to the operation of electrically powered systems such as electrically heated windshields if either a magnetic stabilized direction indicator, which does not have a deviation in level flight greater than 10 degrees on any heading, or a gyroscopic direction indicator, is installed. Deviations of a magnetic nonstabilized direction indicator of more than 10 degrees must be placarded in accordance with §27.1547(e).

Rationale: The UAS pilot does not have inner loop control of vehicle in the operational context in Table B1, so a magnetic direction indicator is not required. A vendor could provide a magnetic direction indicator, but it is not required for continued safe flight and landing. If one is included, the requirement seems reasonable.

**§27.1329 Automatic pilot system-- Modified**

~~(a) Each automatic pilot system must be designed so that the automatic pilot can—~~

~~(1) Be sufficiently overpowered by one pilot to allow control of the rotorcraft; and~~

~~(2) Be readily and positively disengaged by each pilot to prevent it from interfering with control of the rotorcraft.~~

~~(b) Unless there is automatic synchronization, each system must have a means to readily indicate to the pilot the alignment of the actuating device in relation to the control system it operates.~~

~~(c) Each manually operated control for the system's operation must be readily accessible to the pilots.~~

~~(d) The system must be designed and adjusted so that, within the range of adjustment available to the pilot, it cannot produce hazardous loads on the rotorcraft or create hazardous deviations in the flight path under any flight condition appropriate to its use, either during normal operation or in the event of a malfunction, assuming that corrective action begins within a reasonable period of time.~~

~~(e) If the automatic pilot integrates signals from auxiliary controls or furnishes signals for operation of other equipment, there must be positive interlocks and sequencing of engagement to prevent improper operation.~~

~~(f) If the automatic pilot system can be coupled to airborne navigation equipment, means must be provided to indicate to the pilots the current mode of operation. Selector switch position is not acceptable as a means of indication.~~

Rationale: The requirements in §27.1329 presuppose a pilot is interacting with the autopilot to control the rotorcraft. The designated operation does not allow direct pilot control of rotorcraft servomechanisms; therefore, there is no need for requirements related to manual control of rotorcraft. The phrase “hazardous deviations of flight path” is interpreted to mean hazards to the vehicle itself (e.g., hazard of the vehicle ejecting high-energy parts) and it does not include hazards of the flight path itself (e.g., a vehicle exiting the containment region). Thus, the inclusion of this requirement does not mandate any particular architecture of the containment system or other parts of the UAS.

#### **§27.1335 Flight director systems -- Excluded**

Summary: This paragraph provides a requirement to indicate the mode of the flight director to the crew.

Rationale: Out of scope of the operational context in Table B1. The UAS pilot does not have inner loop control of vehicle, so a flight director is not needed. A vendor could provide a flight director, but it is not required for continued safe flight and landing.

#### **§27.1337 Powerplant instruments -- Rolled up to the suggested PPS requirement**

Summary: This paragraph provides requirements for powerplant instruments, especially fuel flow and oil-related instruments.

Rationale: Monitoring of some powerplant systems may be necessary to avoid explosion hazards, so this paragraph was rolled up to the suggested PPS requirement. Subparagraphs (a2), (d), and (e) are especially relevant.

### **Electrical Systems and Equipment**

#### **§27.1351 General -- Modified**

(a) Electrical system capacity. Electrical equipment *whose failure could adversely affect safety* must be adequate for its intended use. In addition—

(1) Electric power sources, their transmission cables, and their associated control and protective devices must be able to furnish the required power at the proper voltage to each load circuit essential for safe operation; and

(2) Compliance with paragraph (a)(1) of this section must be shown by an electrical load analysis, or by electrical measurements that take into account the electrical loads applied to the electrical system, in probable combinations and for probable durations.

(b) Function. For each *safety-critical* electrical system, the following apply:

(1) Each system, when installed, must be—

(i) Free from hazards in itself, in its method of operation, and in its effects on other parts of the rotorcraft; and

(ii) Protected from fuel, oil, water, other detrimental substances, and mechanical damage.

(2) Electric power sources must function properly when connected in combination or independently.

(3) No failure or malfunction of any source may impair the ability of any remaining source to supply load circuits essential for safe operation.

(4) Each electric power source control must allow the independent operation of each source.

(c) *Generating system*. There must be at least one generator if the system supplies power to load circuits essential for safe operation. In addition—

(1) Each generator must be able to deliver its continuous rated power;

(2) Generator voltage control equipment must be able to dependably regulate each generator output within rated limits;

(3) Each generator must have a reverse current cutout designed to disconnect the generator from the battery and from the other generators when enough reverse current exists to damage that generator; and

(4) Each generator must have an overvoltage control designed and installed to prevent damage to the electrical system, or to equipment supplied by the electrical system, that could result if that generator were to develop an overvoltage condition.

(d) Instruments. There must be means to monitor ~~indicate to appropriate crewmembers~~ the electric power system quantities essential for safe operation of the system. ~~In addition—~~

(1) For direct current systems, an ammeter that can be switched into each generator feeder may be used; and

(2) If there is only one generator, the ammeter may be in the battery feeder.

(e) External power. If provisions are made for connecting external power to the rotorcraft, and that external power

can be electrically connected to equipment other than that used for engine starting, means must be provided to ensure that no external power supply having a reverse polarity, or a reverse phase sequence, can supply power to the rotorcraft's electrical system.

Rationale: Loss of electrical power does not necessarily lead to a hazardous event. Proper functioning of the electrical system is only required on the parts of the system needed to maintain safety (e.g., the independent power source for the containment system needs to meet this requirement). Subparagraph (d) was modified to require monitoring of safety-critical electrical systems without specifying how the system would be monitored and what action will be taken in response to an unsafe condition to leave open options of onboard monitoring and closed-loop onboard action if desired by the applicant.

**§27.1353 Storage battery design and installation -- Modified**

***For equipment whose failure could adversely affect safety:***

- (a) Each storage battery must be designed and installed as prescribed in this section.
- (b) Safe cell temperatures and pressures must be maintained during any probable charging and discharging condition. No uncontrolled increase in cell temperature may result when the battery is recharged (after previous complete discharge)—
  - (1) At maximum regulated voltage or power;
  - (2) During a flight of maximum duration; and
  - (3) Under the most adverse cooling condition likely to occur in service.
- (c) Compliance with paragraph (b) of this section must be shown by test unless experience with similar batteries and installations has shown that maintaining safe cell temperatures and pressures presents no problem.
- (d) No explosive or toxic gases emitted by any battery in normal operation, or as the result of any probable malfunction in the charging system or battery installation, may accumulate in hazardous quantities within the rotorcraft.
- (e) No corrosive fluids or gases that may escape from the battery may damage surrounding structures or adjacent essential equipment.
- (f) Each nickel cadmium battery installation capable of being used to start an engine or auxiliary power unit must have provisions to prevent any hazardous effect on structure or essential systems that may be caused by the maximum amount of heat the battery can generate during a short circuit of the battery or of its individual cells.
- (g) Nickel cadmium battery installations capable of being used to start an engine or auxiliary power unit must have—
  - (1) A system to control the charging rate of the battery automatically so as to prevent battery overheating;
  - (2) A battery temperature sensing and over-temperature warning system with a means for disconnecting the battery from its charging source in the event of an over-temperature condition; or
  - (3) A battery failure sensing and warning system with a means for disconnecting the battery from its charging source in the event of battery failure.

Rationale: Loss of battery power does not necessarily lead to any identified hazard. Therefore proper functioning of the batteries is only required where the battery supplies the parts of the system needed to maintain safety (e.g., the containment system).

**§27.1357 Circuit protective devices -- Modified**

***For equipment whose failure could adversely affect safety:***

- (a) Protective devices, such as fuses or circuit breakers, must be installed in each electrical circuit other than—
  - (1) The main circuits of starter motors; and
  - (2) Circuits in which no hazard is presented by ~~their~~ *the* omission *of protective devices*.
- (b) A protective device for a circuit essential to flight safety may not be used to protect any other circuit.
- (c) Each resettable circuit protective device (“trip free” device in which the tripping mechanism cannot be overridden by the operating control) must be designed so that—
  - (1) A manual operation is required to restore service after tripping *[sic]*; and
  - (2) If an overload or circuit fault exists, the device will open the circuit regardless of the position of the operating control.
- (d) If the ability to reset a circuit breaker or replace a fuse is essential to safety in flight, that circuit breaker or fuse must be located and identified so that it can be readily reset or replaced in flight.
- (e) If fuses are used, there must be one spare of each rating, or 50 percent spare fuses of each rating, whichever is greater.

Rationale: This change is strictly unnecessary given the caveat in subparagraph (a)(2). However, this change emphasizes the point that only systems that can create hazards must include such protective devices.

**§27.1361 Master switch -- Modified**

***For equipment whose failure could adversely affect safety:***

- (a) There must be a master switch arrangement to allow ready disconnection of each electric power source from the main bus. The point of disconnection must be adjacent to the sources controlled by the switch.
- (b) Load circuits may be connected so that they remain energized after the switch is opened, if they are protected by circuit protective devices, rated at five amperes or less, adjacent to the electric power source.
- (c) The master switch or its controls must be installed so that the switch is easily discernible and accessible to a crewmember ~~in flight~~.

Rationale: A master switch is necessary to ensure the safety of crewmembers before takeoff and after landing.

**§27.1365 Electric cables -- Modified**

***For equipment whose failure could adversely affect safety:***

- (a) Each electric connecting cable must be of adequate capacity.
- (b) Each cable that would overheat in the event of circuit overload or fault must be at least flame resistant and may not emit dangerous quantities of toxic fumes.
- (c) Insulation on electrical wire and cable installed in the rotorcraft must be self-extinguishing when tested ~~in accordance with appendix F, part I(a)(3), of part 25 of this chapter~~.

Rationale: Electrical cable failure (e.g., short circuit, open circuit) does not necessarily lead to any identified hazard. Therefore proper functioning of the electrical cables is only required on the parts of the system needed to maintain safety.

**§27.1367 Switches -- Modified**

***For equipment whose failure could adversely affect safety:***

Each switch must be—

- (a) Able to carry its rated current;
- (b) Accessible to the crew; and
- (c) Labeled as to operation and the circuit controlled.

Rationale: Proper functioning of safety-relevant switches is necessary to ensure the safety of crewmembers before takeoff and after landing.

**Lights**

**§27.1381 Instrument lights -- Modified**

~~The instrument lights~~ ***For each display or other presentation of data required for systems whose failure adversely affects safety, that display or presentation must—***

- (a) Make each ~~instrument, switch, and other devices for which they are provided~~ ***relevant device, display, or presentation*** easily readable; and
- (b) Be installed so that—
  - (1) ~~Their direct rays are shielded from the pilot's eyes; and~~
  - (2) ~~No objectionable reflections~~ ***or illumination levels render required data unintelligible to the pilot in normal operations*** are visible to the pilot

Rationale: In general, the instruments (displays) in the ground control station will provide their own lighting. Instrument lights in a cockpit are required for the pilot to perform safety-related tasks.

**§27.1383 Landing lights *and supplemental lighting for night operations* -- Modified**

- (a) Each ~~required landing or hovering light~~ ***landing or hovering light or supplemental ground or airborne light required for approved night rotorcraft operations*** must be approved.
- (b) Each landing light must be installed so that—
  - (1) ~~No objectionable glare is visible to the pilot;~~
  - (2) ~~The pilot is not adversely affected by halation; and~~
  - (3) ~~It provides enough light for night operation, including hovering and landing.~~
- (c) At least one separate switch must be provided, as applicable—
  - (1) ~~For each separately installed landing light; and~~



~~(2) For each group of landing lights installed at a common location.~~

Rationale: This requirement was reworded since landing lights may not be located only on the rotorcraft, but may be provided by ground support equipment.

**§27.1385 Position light system installation -- Excluded**

Summary: This paragraph provides position light requirements.

Rationale: The unmanned rotorcraft is expected to yield right-of-way to any manned aircraft. Due to the reduced size of the vehicle (compared with Part 27 rotorcraft), use of position lights may not enhance situational awareness for pilots of other aircraft.

**§27.1387 Position light system dihedral angles -- Excluded**

Summary: This paragraph provides requirements specific to the dihedral angle of the position lights.

Rationale: The unmanned rotorcraft is expected to yield right-of-way to any manned aircraft. Due to the reduced size of the vehicle (compared with Part 27 rotorcraft), use of position lights may not enhance situational awareness for pilots of other aircraft.

**§27.1389 Position light distribution and intensities -- Excluded**

Summary: This paragraph provides requirements specific to the intensities of position lights.

Rationale: The unmanned rotorcraft is expected to yield right-of-way to any manned aircraft. Due to the reduced size of the vehicle (compared with Part 27 rotorcraft), use of position lights may not enhance situational awareness for pilots of other aircraft.

**§27.1391 Minimum intensities in the horizontal plane of forward and rear position lights -- Excluded**

Summary: This paragraph sets minimum requirements for position light intensities in the horizontal plane.

Rationale: The unmanned rotorcraft is expected to yield right-of-way to any manned aircraft. Due to the reduced size of the vehicle (compared with Part 27 rotorcraft), use of position lights may not enhance situational awareness for pilots of other aircraft.

**§27.1393 Minimum intensities in any vertical plane of forward and rear position lights -- Excluded**

Summary: This paragraph sets minimum requirements for position light intensities in the vertical plane.

Rationale: The unmanned rotorcraft is expected to yield right-of-way to any manned aircraft. Due to the reduced size of the vehicle (compared with Part 27 rotorcraft), use of position lights may not enhance situational awareness for pilots of other aircraft.

**§27.1395 Maximum intensities in overlapping beams of forward and rear position lights -- Excluded**

Summary: This paragraph sets maximum intensities for position lights.

Rationale: The unmanned rotorcraft is expected to yield right-of-way to any manned aircraft. Due to the reduced size of the vehicle (compared with Part 27 rotorcraft), use of position lights may not enhance situational awareness for pilots of other aircraft.

**§27.1397 Color specifications -- As is**

Each position light color must have the applicable International Commission on Illumination chromaticity coordinates as follows:

(a) Aviation red—

$y$  is not greater than 0.335; and

$z$  is not greater than 0.002.

(b) Aviation green—

$x$  is not greater than  $0.440 - 0.320y$ ;

$x$  is not greater than  $y - 0.170$ ; and

$y$  is not less than  $0.390 - 0.170x$ .

(c) Aviation white—

$x$  is not less than 0.300 and not greater than 0.540;

$y$  is not less than  $x - 0.040$  or  $y_c - 0.010$ , whichever is the smaller; and

$y$  is not greater than  $x + 0.020$  nor  $0.636 - 0.400x$ ;

Where  $y_c$  is the  $y$  coordinate of the Planckian radiator for the value of  $x$  considered.

Rationale: These requirements are maintained to ensure compatibility with the expected colors by other airspace users.

**§27.1399 Riding light -- Modified**

- (a) Each riding light required for water operation must be installed so that it can—
  - (1) Show a white light, appropriate for safe operations, for at least two nautical miles at night under clear atmospheric conditions; and
  - (2) Show a maximum practicable unbroken light with the rotorcraft on the water.
- (b) Externally hung lights may be used.

Rationale: Water operations will require some consideration for lighting, especially at night.

**§27.1401 Anticollision light system -- Modified**

- (a) General. If certification for night operation is requested, the rotorcraft must have an anticollision light system that—
  - (1) Consists of one or more approved anticollision lights located so that their emitted light will not impair the crew's vision or detract from the conspicuity of the position lights; and
  - (2) Meets the requirements of paragraphs (b) through (f) of this section.
- (b) Field of coverage. The system must consist of enough lights to illuminate the vital areas around the rotorcraft, considering the physical configuration and flight characteristics of the rotorcraft. The field of coverage must extend in each direction within at least 30 degrees below the horizontal plane of the rotorcraft, except that there may be solid angles of obstructed visibility totaling not more than 0.5 steradians.
- (c) Flashing characteristics. The arrangement of the system, that is, the number of light sources, beam width, speed of rotation, and other characteristics, must give an effective flash frequency of not less than 40, nor more than 100, cycles per minute. The effective flash frequency is the frequency at which the rotorcraft's complete anticollision light system is observed from a distance, and applies to each sector of light including any overlaps that exist when the system consists of more than one light source. In overlaps, flash frequencies may exceed 100, but not 180, cycles per minute.
- (d) Color. Each anticollision light must be aviation red and must meet the applicable requirements of §27.1397.
- (e) Light intensity. The minimum light intensities in any vertical plane, measured with the red filter (if used) and expressed in terms of “effective” intensities, must meet the requirements of paragraph (f) of this section. The following relation must be assumed:

$$I_e = \frac{\int_{t_1}^{t_2} I(t) dt}{0.2 + (t_2 - t_1)}$$

View or download PDF

where:

I<sub>e</sub>=effective intensity (candles).

I(t)=instantaneous intensity as a function of time.

t<sub>2</sub>-t<sub>1</sub>=flash time interval (seconds).

Normally, the maximum value of effective intensity is obtained when t<sub>2</sub> and t<sub>1</sub> are chosen so that the effective intensity is equal to the instantaneous intensity at t<sub>2</sub> and t<sub>1</sub>.

- (f) Minimum effective intensities for anticollision light. Each anticollision light effective intensity must equal or exceed the applicable values in the following table:

Angle above or below the horizontal plane	Effective intensity (candles)
0° to 5°	150
5° to 10°	90
10° to 20°	30
20° to 30°	15

- (g) A means must be provided for the pilot to activate or deactivate the anticollision lights in any flight phase.

Rationale: A small addition was made to this requirement in subparagraph (g) to allow for pilot-controlled or

automatic control of the anticollision lights. This was added to ensure that the anticollision lights do not blind or otherwise interfere with ground-based crewmembers so that they can perform their safety role during takeoffs and landings.

### **Safety Equipment**

#### **§27.1411 General -- Modified**

(a) Required safety equipment to be used by the crew in an emergency; ~~such as flares and automatic liferaft releases,~~ must be readily accessible.

~~(b) Stowage provisions for required safety equipment must be furnished and must—~~

~~(1) Be arranged so that the equipment is directly accessible and its location is obvious; and~~

~~(2) Protect the safety equipment from damage caused by being subjected to the inertia loads specified in §27.561.~~

Rationale: The particular examples of safety equipment may not be relevant for unmanned rotorcraft operations; however, the pilot and other crewmembers may need some safety equipment (e.g., fire extinguishers) that must be readily available.

#### **§27.1413 Safety belts -- Excluded**

Summary: This paragraph requires seat belts to have a metal latching device.

Rationale: This requirement is not directly relevant to a primary hazard identified in the hazard analysis for this operational context.

#### **§27.1415 Ditching equipment -- Excluded**

Summary: This paragraph provides requirements for ditching equipment (e.g., life rafts).

Rationale: This requirement is not directly relevant to a primary hazard identified in the hazard analysis for this operational context.

#### **§27.1419 Ice protection -- Rolled up to the suggested CMS(a) and SI requirements**

Summary: This paragraph provides airframe-related requirements for operation in icing conditions.

Rationale: The requirements of this paragraph relate directly to maintaining control of the rotorcraft in icing conditions, which relates to the primary hazard of flying debris. However, the analysis and testing requirements may be too prescriptive for a vehicle with no occupants flying within a containment volume.

#### **§27.1435 Hydraulic systems -- Excluded**

Summary: This paragraph provides requirements for design, test, and installation of hydraulic equipment.

Rationale: This requirement is not directly relevant to a primary hazard identified in the hazard analysis for this operational context. Ejection of high energy parts from a rupture of the hydraulic system was considered sufficiently inconsequential.

#### **§27.1457 Cockpit voice recorders -- Excluded**

Summary: This paragraph provides requirements for cockpit voice recorders.

Rationale: It is not clear what cockpit (or ground control station) voice recording would serve. The expectation is that accident investigation (if necessary) will not need voice recordings. Flight data (as per §27.1459) is assumed to be more relevant for determining accident cause.

#### **§27.1459 Flight data recorders -- Modified**

~~(a) Each flight recorder required by the operating *approval associated with the vehicle specified in this type design must meet the data recording requirements specified by the Administrator.*~~

~~rules of Subchapter G of this chapter must be installed so that:~~

~~(1) It is supplied with airspeed, altitude, and directional data obtained from sources that meet the accuracy requirements of §27.1323, §27.1325, and §27.1327 of this part, as applicable;~~

~~(2) The vertical acceleration sensor is rigidly attached, and located longitudinally within the approved center of gravity limits of the rotorcraft;~~

~~(3)(i) It receives its electrical power from the bus that provides the maximum reliability for operation of the flight data recorder without jeopardizing service to essential or emergency loads.~~

~~(ii) It remains powered for as long as possible without jeopardizing emergency operation of the rotorcraft.~~

~~(4) There is an aural or visual means for preflight checking of the recorder for proper recording of data in the storage medium;~~

~~(5) Except for recorders powered solely by the engine-driven electrical generator system, there is an automatic means~~

to simultaneously stop a recorder that has a data erasure feature and prevent each erasure feature from functioning, within 10 minutes after any crash impact; and

(6) Whether the cockpit voice recorder and digital flight data recorder are installed in separate boxes or in a combination unit, no single electrical failure external to the recorder may disable both the cockpit voice recorder and the digital flight data recorder.

(b) Each nonejectable recorder container must be located and mounted so as to minimize the probability of container rupture resulting from crash impact and subsequent damage to the record from fire.

(c) A correlation must be established between the flight recorder readings of airspeed, altitude, and heading and the corresponding readings (taking into account correction factors) of the first pilot's instruments. This correlation must cover the airspeed range over which the aircraft is to be operated, the range of altitude to which the aircraft is limited, and 360 degrees of heading. Correlation may be established on the ground as appropriate.

(d) Each recorder container must:

(1) Be either bright orange or bright yellow;

(2) Have a reflective tape affixed to its external surface to facilitate its location under water; and

(3) Have an underwater locating device, when required by the operating rules of this chapter, on or adjacent to the container which is secured in such a manner that they are not likely to be separated during crash impact.

(e) When both a cockpit voice recorder and a flight data recorder are required by the operating rules, one combination unit may be installed, provided that all other requirements of this section and the requirements for cockpit voice recorders under this part are met.

Rationale: It is not clear exactly what purpose a flight data recorder would serve for an unmanned rotorcraft, nor is it clear that an unmanned aircraft needs the detailed survivability requirements as described in this paragraph. The ground control station may provide all necessary data recording. The language was changed to allow more generic requirements for data recording.

#### **§27.1461 Equipment containing high energy rotors -- Modified**

(a) Equipment *whose failure adversely affects safety and* contains high energy rotors must meet paragraph (b), (c), or (d) of this section.

(b) High energy rotors contained in equipment must be able to withstand damage caused by malfunctions, vibration, abnormal speeds, and abnormal temperatures. In addition—

(1) Auxiliary rotor cases must be able to contain damage *relevant to Paragraph (a) of this section and* caused by the failure of high energy rotor blades; and

(2) Equipment control devices, systems, and instrumentation must reasonably ensure that no operating limitations affecting the integrity of high energy rotors will be exceeded in service.

(c) It must be shown by test that equipment containing high energy rotors can, *without directly causing one or more of the failure conditions addressed in Paragraph (a) of this section*, contain any failure of a high energy rotor that occurs at the highest speed obtainable with the normal speed control devices inoperative.

(d) Equipment containing high energy rotors must be located where rotor failure will ~~neither endanger the occupants nor~~ *not* adversely affect continued safe flight.

Rationale: The requirement was rewritten to emphasize that not all equipment with high-energy rotors that fails is capable of causing harm. Furthermore, this requirement recognizes that non-engine related components might contain high-energy rotors.

### **14 CFR Part 27, Subpart G—Operating Limitations and Information**

#### **§27.1501 General -- Modified**

(a) Each operating limitation *required by the Administrator* specified in §27.1503 through §27.1525 and other limitations and information necessary for safe operation must be established *and*

(b) ~~The operating limitations and other information necessary for safe operation must be made available to the crewmembers as prescribed in §27.1541 through §27.1589.~~

Rationale: References to specific subparagraphs that specify operating limitations for Part 27 rotorcraft were deleted because operating limitations relevant to an unmanned rotorcraft operating in a confined area have not yet been established. The reference was changed to a more general reference to operating limitations established by the FAA Administrator. Those operating limitations should still be made available to crewmembers.

### **Operating Limitations**

**§27.1503 Airspeed limitations: general – As Is**

(a) An operating speed range must be established.

(b) When airspeed limitations are a function of weight, weight distribution, altitude, rotor speed, power, or other factors, airspeed limitations corresponding with the critical combinations of these factors must be established.

Rationale: Exceeding a speed limit could result in a structural failure if the limit was set to preclude overloading some piece of the structure. Structural failure could affect rotor system integrity either directly (e.g. blade or hub failure) or indirectly (a piece of secondary structure coming off and hitting the blades).

**§27.1505 Never-exceed speed – Modified**

(a) The never-exceed speed,  $V_{NE}$ , must be established so that it is—

(1) Not less than 40 knots (CAS); and

(2) Not more than the lesser of—

(i) 0.9 times the maximum forward speeds established under §27.309;

(ii) 0.9 times the maximum speed shown under §§27.251 and 27.629; or

(iii) 0.9 times the maximum speed substantiated for advancing blade tip mach number effects.

(b)  $V_{NE}$  may vary with altitude, r.p.m., temperature, and weight, if—

(1) No more than two of these variables (or no more than two instruments integrating more than one of these variables) are used at one time; and

(2) The ranges of these variables (or of the indications on instruments integrating more than one of these variables) are large enough to allow an operationally practical and safe variation of  $V_{NE}$ .

(c) For helicopters, a stabilized power-off  $V_{NE}$  denoted as  $V_{NE}$  (power-off) may be established at a speed less than  $V_{NE}$  established pursuant to paragraph (a) of this section, if the following conditions are met:

(1)  $V_{NE}$  (power-off) is not less than a speed midway between the power-on  $V_{NE}$  and the speed used in meeting the requirements of—

(i) §27.65(b) for single engine helicopters; and

(ii) §27.67 for multiengine helicopters.

(2)  $V_{NE}$  (power-off) is—

(i) A constant airspeed;

(ii) A constant amount less than power on  $V_{NE}$ ; or

(iii) A constant airspeed for a portion of the altitude range for which certification is requested, and a constant amount less than power on  $V_{NE}$  for the remainder of the altitude range.

Rationale: Exceeding  $V_{NE}$  can result in a structural issue (e.g., flutter) or a loss of control issue (roll off).

**§27.1509 Rotor speed-- Rolled up to the suggested SI requirement**

Summary: This paragraph establishes ranges of values for maximum and minimum rotor speeds under power-off and power-on conditions.

Rationale: While maximum and minimum rotor speeds are clearly related to maintaining rotor system integrity, it is not known whether the specific ranges required for manned rotorcraft are directly applicable to an unmanned rotorcraft with different risk profiles. The paragraph was rolled up to the suggested requirement for SI where the applicant and the regulator could determine the appropriate ranges of values.

**§27.1519 Weight and center of gravity -- Rolled up to the suggested CMS(a) requirement**

Summary: This paragraph requires that weight and center of gravity limitations be established.

Rationale: Since these are critical parameters affecting controllability and maneuverability, this requirement was added to the suggested requirement in CMS(a).

**§27.1521 Powerplant limitations -- Rolled up to the suggested PPS requirement**

Summary: This paragraph specifies a requirement to establish relevant powerplant limitations, such as torque, temperature, speed, and other parameters, under a variety of conditions and for various time limits.

Rationale: The requirement to establish powerplant limitations was considered relevant to protecting rotor system integrity and preventing explosion which could cause release of high energy parts, but the specific conditions and times were considered too detailed. So, the general requirement for powerplant limitations was retained but rolled up into the more general language of the suggested PPS requirement.

**§27.1523 Minimum flight crew -- Modified**

The minimum flight crew must be established so that it is sufficient for safe operation, considering—

- (a) The workload on *and safety roles of* individual crewmembers; *and*
- (b) ~~The accessibility and ease of operation of necessary controls by the appropriate crewmember; and~~
- (c) The kinds of operation authorized under §27.1525.

Rationale: The word “flight” was deleted as a modifier to crew, since it is not appropriate for UAS (given the definition of crew). Wording was added in subparagraph (a) to include consideration of the crew’s safety role in determining the minimum size of the UAS crew. Words related to accessibility and ease of operation of controls were deleted in subparagraph (b), assuming that the original text referred to the accessibility of onboard controls to onboard crew, and that more general language about workload is desired because accessibility and ease of operation are only 2 of a larger set of attributes that affect the crew’s ability to perform their safety role.

**§27.1525 Kinds of operations -- Modified**

The kinds of operations (such as VLOS, BVLOS, VFR, IFR, day, night, or icing) for which the ~~rotorcraft~~ **UAS** is approved are established by demonstrated compliance with the applicable certification requirements and by the installed equipment.

Rationale: The approved operation includes capabilities of the whole UA system, including the vehicle, the ground control station, datalinks, etc.

**§27.1527 Maximum operating altitude -- Modified**

The maximum altitude up to which operation is allowed, as limited by flight, structural, powerplant, functional, *safety*, or equipment characteristics, must be established.

Rationale: The word “safety” was added to the list of considerations for establishing maximum altitude because operating limitations on altitude are an explicit limitation on the operation to help mitigate safety concerns when operating at altitudes where air traffic is expected (e.g., above 500 ft).

**§27.1529 Instructions for Continued Airworthiness -- As Is**

The applicant must prepare Instructions for Continued Airworthiness in accordance with appendix A to this part that are acceptable to the Administrator. The instructions may be incomplete at type certification if a program exists to ensure their completion prior to delivery of the first rotorcraft or issuance of a standard certificate of airworthiness, whichever occurs later.

Rationale: Instructions for continued airworthiness are applicable. Appendix A has been modified for the UAS as described in Table B1.

**Markings and Placards**

**§27.1541 General -- Modified**

(a) The ~~rotorcraft~~ **UAS** must contain—

- (1) The markings and placards specified *in this set of requirements* §27.1545 through §27.1565, and
- (2) Any additional information, instrument markings, and placards required for the safe operation of ~~rotorcraft~~ **UAS** with unusual design, operating or handling characteristics.

(b) Each marking and placard prescribed in paragraph (a) of this section—

- (1) Must be displayed in a conspicuous place; and
- (2) May not be easily erased, disfigured, or obscured.

Rationale: In (a), “rotorcraft” was changed to “UAS” (in 2 places) because markings and placards may be located in the ground control station or on other equipment in addition to the rotorcraft. A UAS may need markings and placards for safe operation that are not usually needed for manned rotorcraft (e.g., markings for landing zone of vehicle).

References to specific paragraphs that specify markings and placards in (1) were deleted in favor of a more general reference to the requirements for markings and placards identified in this set of requirements (e.g., §27.1557.).

**§27.1543 Instrument markings: general -- Excluded**

Summary: This paragraph addresses alignment of markings on cockpit instruments that have glass covers.

Rationale: This requirement is not directly relevant to a primary hazard identified in the hazard analysis for this operational context. This requirement is also irrelevant to a UAS by the design or operational characteristics in Table B1. Instruments with glass covers (like those found in a cockpit) are not expected in a UAS ground control station.

**§27.1545 Airspeed indicator -- Rolled up to the suggested CMS(a) and SI requirements**

Summary: This paragraph describes the markings necessary on an airspeed indicator.  
Rationale: Given the operational context in Table B1, there is a need for some degree of airspeed indication so as not to exceed a never-exceed speed,  $V_{NE}$  (as required by §27.1505). Presentation of airspeed information could use the markings as indicated, however, alternate ways of displaying information necessary for the pilot's safety role in complying with the never-exceed speed should be allowed. So, this requirement was rolled up to the suggested requirements for CMS(a) and SI so that the applicant and regulator could determine the appropriate markings for any airspeed measuring system.

**§27.1547 Magnetic direction indicator -- Excluded**

Summary: This paragraph describes placards necessary for magnetic direction indicators.  
Rationale: The stated requirements are too prescriptive for the operational context. Presentation of information could use the markings as indicated, however, alternate ways of displaying information necessary for the pilot's safety role should be allowed.

**§27.1549 Powerplant instruments -- Excluded**

Summary: This paragraph specifies required markings on powerplant instruments.  
Rationale: The stated requirements are too prescriptive for the operational context. Presentation of information could use the markings as indicated, however, alternate ways of displaying information necessary for the pilot's safety role should be allowed.

**§27.1551 Oil quantity indicator -- Excluded**

Summary: This paragraph requires markings on oil quantity indicators.  
Rationale: The stated requirements are too prescriptive for the operational context. Presentation of information could use the markings as indicated, however, alternate ways of displaying information necessary for the pilot's safety role should be allowed.

**§27.1553 Fuel quantity indicator -- Excluded**

Summary: This paragraph specifies requirements for markings relative to unusable fuel level.  
Rationale: The stated requirements are too prescriptive for the operational context. Presentation of information could use the markings as indicated, however, alternate ways of displaying information necessary for the pilot's safety role should be allowed.

**§27.1555 Control markings -- Modified**

- ~~(a) Each cockpit control, other than primary flight controls or control whose function is obvious, must be plainly marked as to its function and method of operation.~~
- ~~(b) For powerplant fuel controls—~~
  - ~~(1) Each fuel tank selector control must be marked to indicate the position corresponding to each tank and to each existing cross feed position;~~
  - ~~(2) If safe operation requires the use of any tanks in a specific sequence, that sequence must be marked on, or adjacent to, the selector for those tanks; and~~
  - ~~(3) Each valve control for any engine of a multiengine rotorcraft must be marked to indicate the position corresponding to each engine controlled.~~
- ~~(c) Usable fuel capacity must be marked as follows:~~
  - ~~(1) For fuel systems having no selector controls, the usable fuel capacity of the system must be indicated at the fuel quantity indicator.~~
  - ~~(2) For fuel systems having selector controls, the usable fuel capacity available at each selector control position must be indicated near the selector control.~~
- ~~(d) For accessory, auxiliary, and emergency controls—~~
  - ~~(1) Each essential visual position indicator, such as those showing rotor pitch or landing gear position, must be marked so that each crewmember can determine at any time the position of the unit to which it relates; and~~
  - ~~(2) Each emergency control must be red and must be marked as to method of operation.~~
- ~~(e) For rotorcraft incorporating retractable landing gear, the maximum landing gear operating speed must be displayed in clear view of the pilot.~~

Rationale: Requirements for controls, as described in this paragraph, have been excluded because the pilot does not have inner-loop control. However, subparagraph (d)(2) for marking emergency controls in red applies to emergency controls that the pilot would use to cause the rotorcraft to hover or land in emergency situations.

**§27.1557 Miscellaneous markings and placards -- Modified**

(a) ~~Baggage~~**Payload**, and cargo compartments, and ballast location. Each ~~baggage and cargo~~ **payload** compartment, and each ballast location must have a placard stating any limitations on contents, including weight, that are necessary under the loading requirements.

~~(b) Seats. If the maximum allowable weight to be carried in a seat is less than 170 pounds, a placard stating the lesser weight must be permanently attached to the seat structure.~~

(c) Fuel and oil filler openings. The following apply:

(1) Fuel filler openings must be marked at or near the filler cover with—

(i) The word “fuel”;

(ii) For reciprocating engine powered rotorcraft, the minimum fuel grade;

(iii) For turbine engine powered rotorcraft, the permissible fuel designations; and

(iv) For pressure fueling systems, the maximum permissible fueling supply pressure and the maximum permissible defueling pressure.

(2) Oil filler openings must be marked at or near the filler cover with the word “oil”.

~~(d) Emergency exit placards. Each placard and operating control for each emergency exit must be red. A placard must be near each emergency exit control and must clearly indicate the location of that exit and its method of operation.~~

Rationale: “Baggage” and “cargo” were replaced in subparagraph (a) with “payload” to be more consistent with UAS usage. Subparagraph (b) was deleted because seats are not needed aboard the UAS. Any seats in the ground control station are not considered critical to safety of flight. Subparagraph (d) was deleted because there are no people on board the UAS, hence there is no need for emergency exit placards on the rotorcraft. We are assuming that OSHA requirements would necessitate exit placards for any indoor areas of a ground control station.

**§27.1559 Limitations placard -- Modified**

There must be a placard in clear view of the pilot that specifies the kinds of operations (such as **visual line-of-sight, beyond visual line-of-sight**, VFR, IFR, day, night, or icing) for which the ~~UAS rotorcraft~~ is approved.

Rationale: Visual line-of-sight and beyond line-of-sight operations are different from typical operations for Part 27 rotorcraft. They were added to the list of example operations because it is important for a UAS pilot to be aware of the sight-line limitations for approved UAS operations.

**§27.1561 Safety equipment -- Modified**

(a) Each **required** safety equipment control to be operated by the crew in emergency, ~~such as controls for automatic liferaft releases,~~ must be plainly marked as to its method of operation.

(b) Each location, such as a locker or compartment, that carries any fire extinguishing, signaling, or other life saving equipment, must be so marked.

Rationale: The example of life rafts as safety equipment was deleted since there is no need for life rafts on UAS. The word “required” was added to safety equipment to indicate that not all safety equipment for a UAS may necessarily be considered required (e.g., a fire extinguisher in the ground control station should not need a placard). If it is required, it should be marked appropriately.

**§27.1565 Tail Rotor -- As is**

Each tail rotor must be marked so that its disc is conspicuous under normal daylight ground conditions.

Rationale: If the unmanned rotorcraft has a tail rotor, then it should be marked as described.

**Rotorcraft Flight Manual and Approved Manual Material**

**§27.1581 General -- Modified**

(a) Furnishing information. A Rotorcraft Flight Manual must be furnished with each rotorcraft, and it must contain the following:

(1) Information required **for UAS functions whose failure could adversely affect safety, and** by §27.1583 through §27.1589.

(2) Other information that is necessary for safe operation because of design, operating, or handling characteristics.

(b) Approved information. Each part of the manual listed in §27.1583 through §27.1589, that is **appropriate to the rotorcraft, must be** furnished, verified, and approved **under its associated type certificate, and** must be segregated, identified, and clearly distinguished from each unapproved part of that manual.

(c) [Reserved]



(d) Table of contents. Each Rotorcraft Flight Manual must include a table of contents if the complexity of the manual indicates a need for it.

Rationale: A flight manual is important. References to Part 27 paragraphs specifying content of the flight manual were replaced with a more general requirement that the flight manual should provide information on safety-critical functions. Not all of the original paragraphs referenced were considered applicable in this operational context.

#### **§27.1583 Operating Limitations -- Modified**

*A Rotorcraft Flight Manual must contain operating limitations for each of the following, as relevant to safety-critical functions, including, but not limited to:*

(a) Airspeed and rotor limitations. ~~Information necessary for the marking of airspeed and rotor limitations on, or near, their respective indicators, must be furnished. The significance of each limitation and of the color coding must be explained.~~

(b) Powerplant limitations. The following information must be furnished:

(1) Limitations *necessary to maintain powerplant and rotor system integrity* required by §27.1524.

(2) Explanation of the limitations, when appropriate.

~~(3) Information necessary for marking the instruments, required by §§27.1549 through 27.1553.~~

(c) Weight and loading distribution. The weight and center of gravity limits required by §§27.25 and 27.27, respectively, must be furnished. If the variety of possible loading conditions warrants, instructions must be included to allow ready observance of the limitations *specifically for takeoffs*.

(d) Flight UAS crew. When a flight crew of more than one is required, the number and functions of the minimum flight crew determined under §27.1523 must be furnished.

(e) Kinds of operation. Each kind of operation for which the rotorcraft and its equipment installations are approved must be listed.

(f) [Reserved]

(g) Altitude. The altitude established under §27.1527 and an explanation of the limiting factors must be furnished.

Rationale: Operating limitations should be documented in the flight manual. Modifications were made to generalize some of the requirements and delete references to Part 27 requirements that were not relevant in this operational context. Powerplant limitations are included to the extent they are necessary to protect rotor system integrity (such as torque limitations and r.p.m. limitations).

#### **§27.1585 Operating procedures -- Modified**

(a) Parts of the manual containing operating procedures must have information concerning any normal and emergency procedures and other information necessary for safe operation, including takeoff and landing procedures ~~and associated airspeeds~~. The manual must contain any pertinent information including—

(1) The kind of takeoff surface used in the tests and each appropriate climbout speed; and

(2) The kind of landing surface used in the tests and appropriate approach and glide airspeeds.

~~(b) For multiengine rotorcraft, information identifying each operating condition in which the fuel system independence prescribed in §27.953 is necessary for safety must be furnished, together with instructions for placing the fuel system in a configuration used to show compliance with that section.~~

~~(c) For helicopters for which a  $V_{NE}$  (power off) is established under §27.1505(e), information must be furnished to explain the  $V_{NE}$  (power off) and the procedures for reducing airspeed to not more than the  $V_{NE}$  (power off) following failure of all engines.~~

~~(d) For each rotorcraft showing compliance with §27.1353 (g)(2) or (g)(3), the operating procedures for disconnecting the battery from its charging source must be furnished.~~

~~(e) If the unusable fuel supply in any tank exceeds five percent of the tank capacity, or one gallon, whichever is greater, information must be furnished which indicates that when the fuel quantity indicator reads “zero” in level flight, any fuel remaining in the fuel tank cannot be used safely in flight.~~

~~(c) Information on the total quantity of usable fuel for each fuel tank must be furnished.~~

~~(g) The airspeeds and rotor speeds for minimum rate of descent and best glide angle as prescribed in §27.71 must be provided.~~

Rationale: Subparagraph (a) was kept because the kind of information specified is relevant except for airspeeds. Subparagraph (b) is deleted because independence of the fuel systems is not required for multiengine rotorcraft in this operational context. Subparagraph (c) was deleted because a UAS pilot will not have control of airspeed. Subparagraph (e) was deleted because the requirement for a fuel indicator was deleted. Subparagraph (f) was retained because knowledge of the total usable fuel quantity would be necessary to accurately calculate weight and

balance and may be helpful in assessing whether there are fuel leaks. Subparagraph (g) was deleted because the UAS pilot will have no way of knowing airspeed or rotor speed (these are controlled automatically by the autopilot).

**§27.1587 Performance information -- Rolled up to the suggested CMS(a) requirement**

Summary: This paragraph specifies that the flight manual must include enough information to determine the height-speed envelope relative to a number of different parameters. Other information required by the paragraph (e.g., the requirement to establish altitudes, temperatures, and winds at which the vehicle can be safely hovered) also relates to controllability and maneuverability.

Rationale: Since the requirement to establish the height-speed envelope (§27.87) was rolled up to the suggested CMS(a) requirement, this paragraph was also rolled up to that same requirement.

**§27.1589 Loading information -- Rolled up to the suggested CMS(a) requirement**

Summary: This paragraph requires instructions to be included in the Flight Manual for all possible loading conditions that can cause the center of gravity to be exceeded.

Rationale: Loading information is important to maintaining control margins that allow the vehicle to be safely controllable and maneuverable. This requirement is rolled up to the suggested CMS(a) requirement because only those loading conditions that affect controllability, maneuverability and stability to ensure rotor system integrity are needed.

**14 CFR Part 27, Appendix A—Instructions for Continued Airworthiness**

**A§27.1 General -- Modified**

(a) This appendix specifies requirements for the preparation of Instructions for Continued Airworthiness as required by §27.1529.

(b) The Instructions for Continued Airworthiness for each ~~UAS rotorcraft~~ must include the Instructions for Continued Airworthiness for each engine and rotor (hereinafter designated ‘products’), for each appliance required by this chapter, and any required information relating to the interface of those appliances and products with the ~~UAS rotorcraft~~. If Instructions for Continued Airworthiness are not supplied by the manufacturer of an appliance or product installed in the ~~UAS rotorcraft~~, the Instructions for Continued Airworthiness for the ~~UAS rotorcraft~~ must include the information essential to the continued airworthiness of the ~~UAS rotorcraft~~.

(c) The applicant must submit to the FAA a program to show how changes to the Instructions for Continued Airworthiness made by the applicant or by the manufacturers of products and appliances installed in the ~~UAS rotorcraft~~ will be distributed

Rationale: Continued airworthiness considerations should apply to an unmanned rotorcraft that requires airworthiness certification just as they apply to a manned aircraft. The only change was to make it clear that the requirements apply to the UAS as a whole. So, “rotorcraft” was replaced with “UAS.”

**A§27.2 Format -- As is**

(a) The Instructions for Continued Airworthiness must be in the form of a manual or manuals as appropriate for the quantity of data to be provided.

(b) The format of the manual or manuals must provide for a practical arrangement.

Rationale: Instructions for continued airworthiness should be in a usable form.

**A§27.3 Content -- Modified**

The contents of the manual or manuals must be prepared in the English language. The Instructions for Continued Airworthiness must contain the following manuals or sections, as appropriate, and information:

(a) ~~UAS rotorcraft~~ maintenance manual or section.

(1) Introduction information that includes an explanation of the ~~UAS’s rotorcraft~~ features and data to the extent necessary for maintenance or preventive maintenance.

(2) A description of the ~~UAS rotorcraft~~ and its systems and installations including its engines, rotors, and appliances.

(3) Basic control and operation information describing how the ~~UAS rotorcraft~~ components and systems are controlled and how they operate, including any special procedures and limitations that apply.

(4) Servicing information that covers details regarding servicing points, capacities of tanks, reservoirs, types of fluids to be used, pressures applicable to the various systems, location of access panels for inspection and servicing, locations of lubrication points, the lubricants to be used, equipment required for servicing, tow instructions and limitations, mooring, jacking, and leveling information.

(b) Maintenance instructions.

(1) Scheduling information for each part of the *UAS rotorcraft* and its engines, auxiliary power units, rotors, accessories, instruments and equipment that provides the recommended periods at which they should be cleaned, inspected, adjusted, tested, and lubricated, and the degree of inspection, the applicable wear tolerances, and work recommended at these periods. However, the applicant may refer to an accessory, instrument, or equipment manufacturer as the source of this information if the applicant shows the item has an exceptionally high degree of complexity requiring specialized maintenance techniques, test equipment, or expertise. The recommended overhaul periods and necessary cross references to the Airworthiness Limitations section of the manual must also be included. In addition, the applicant must include an inspection program that includes the frequency and extent of the inspections necessary to provide for the continued airworthiness of the *UAS rotorcraft*.

(2) Troubleshooting information describing problem malfunctions, how to recognize those malfunctions, and the remedial action for those malfunctions.

(3) Information describing the order and method of removing and replacing products and parts with any necessary precautions to be taken.

(4) Other general procedural instructions including procedures for system testing during ground running, symmetry checks, weighing and determining the center of gravity, lifting and shoring, and storage limitations.

(c) Diagrams of structural access plates and information needed to gain access for inspections when access plates are not provided.

(d) Details for the application of special inspection techniques including radiographic and ultrasonic testing where such processes are specified.

(e) Information needed to apply protective treatments to the structure after inspection.

(f) All data relative to structural fasteners such as identification, discarded recommendations, and torque values.

(g) A list of special tools needed.

Rationale: The same basic information for continued airworthiness applies to an unmanned rotorcraft. The only change was to make it clear that the requirements apply to the UAS as a whole. So, “rotorcraft” was replaced with “UAS.”

**A§27.4 Airworthiness Limitations section -- As is**

The Instructions for Continued Airworthiness must contain a section, titled Airworthiness Limitations that is segregated and clearly distinguishable from the rest of the document. This section must set forth each mandatory replacement time, structural inspection interval, and related structural inspection procedure required for type certification. If the Instructions for Continued Airworthiness consist of multiple documents, the section required by this paragraph must be included in the principal manual. This section must contain a legible statement in a prominent location that reads: “The Airworthiness Limitations section is FAA approved and specifies inspections and other maintenance required under §43.16 and 91.403 of the Federal Aviation Regulations unless an alternative program has been FAA approved.”

Rationale: The same basic requirement to specify information on airworthiness limitations applies to an unmanned rotorcraft.

**14 CFR Part 27, Appendix B—Airworthiness Criteria for Helicopter Instrument Flight**

**Appendix B Airworthiness Criteria for Helicopter Instrument Flight -- Excluded**

Summary: This appendix specifies the design and installation requirements for operation under instrument flight rules.

Rationale: Requirements specific to instrument flight were not addressed.

**14 CFR Part 27, Appendix B—Criteria for Category A**

**Appendix C – Criteria for Category A -- Excluded**

Summary: This Appendix specifies paragraphs under Part 29 that must be met in addition to Part 27 for Category A operation (for multi-engine rotorcraft)

Rationale: While this set of requirements intends to cover both single and multiengine rotorcraft, it is not intended to cover multiengine vehicles with Category A capabilities. Such operations primarily are intended to protect onboard passengers in the event of an engine failure and are thus considered out of scope for small and midsize UAS. In the event that an applicant should want credit for Category A capabilities in a UAS, the 44 extra requirements from Part 29 would have to be reviewed for applicability.

**14 CFR Part 27, Appendix D—HIRF Environments and Equipment HIRF Test Levels**

**Appendix D HIRF Environments and Equipment HIRF Test Levels -- Modified**

This appendix specifies the HIRF environments and equipment HIRF test levels for electrical and electronic systems under §27.1317. The field strength values for the HIRF environments and laboratory equipment HIRF test levels *must be established*. are expressed in root mean square units measured during the peak of the modulation cycle.

(a) HIRF environment I is specified in the following table:

Table I. HIRF Environment I

Frequency	Field strength (volts/meter)	
	Peak	Average
10 kHz-2 MHz	50	50
2 MHz-30 MHz	100	100
30 MHz-100 MHz	50	50
100 MHz-400 MHz	100	100
400 MHz-700 MHz	700	50
700 MHz-1 GHz	700	100
1 GHz-2 GHz	2,000	200
2 GHz-6 GHz	3,000	200
6 GHz-8 GHz	1,000	200
8 GHz-12 GHz	3,000	300
12 GHz-18 GHz	2,000	200
18 GHz-40 GHz	600	200

In this table, the higher field strength applies at the frequency band edges.

(b) HIRF environment II is specified in the following table:

Table II. HIRF Environment II

Frequency	Field strength (volts/meter)	
	Peak	Average
10 kHz-500 kHz	20	20
500 kHz-2 MHz	30	30
2 MHz-30 MHz	100	100
30 MHz-100 MHz	10	10
100 MHz-200 MHz	30	10
200 MHz-400 MHz	10	10
400 MHz-1 GHz	700	40
1 GHz-2 GHz	1,300	160
2 GHz-4 GHz	3,000	120
4 GHz-6 GHz	3,000	160

6 GHz-8 GHz	400	170
8 GHz-12 GHz	1,230	230
12 GHz-18 GHz	730	190
18 GHz-40 GHz	600	150

In this table, the higher field strength applies at the frequency band edges.

(c) HIRF environment III is specified in the following table:

Table III.— HIRF Environment III

Frequency	Field strength (volts/meter)	
	Peak	Average
10 kHz-100 kHz	150	150
100 kHz-400 MHz	200	200
400 MHz-700 MHz	730	200
700 MHz-1 GHz	1,400	240
1 GHz-2 GHz	5,000	250
2 GHz-4 GHz	6,000	490
4 GHz-6 GHz	7,200	400
6 GHz-8 GHz	1,100	170
8 GHz-12 GHz	5,000	330
12 GHz-18 GHz	2,000	330
18 GHz-40 GHz	1,000	420

In this table, the higher field strength applies at the frequency band edges.

(d) Equipment HIRF Test Level 1.

(1) From 10 kilohertz (kHz) to 400 megahertz (MHz), use conducted susceptibility tests with continuous wave (CW) and 1 kHz square wave modulation with 90 percent depth or greater. The conducted susceptibility current must start at a minimum of 0.6 milliamperes (mA) at 10 kHz, increasing 20 decibels (dB) per frequency decade to a minimum of 30 mA at 500 kHz.

(2) From 500 kHz to 40 MHz, the conducted susceptibility current must be at least 30 mA.

(3) From 40 MHz to 400 MHz, use conducted susceptibility tests, starting at a minimum of 30 mA at 40 MHz, decreasing 20 dB per frequency decade to a minimum of 3 mA at 400 MHz.

(4) From 100 MHz to 400 MHz, use radiated susceptibility tests at a minimum of 20 volts per meter (V/m) peak with CW and 1 kHz square wave modulation with 90 percent depth or greater.

(5) From 400 MHz to 8 gigahertz (GHz), use radiated susceptibility tests at a minimum of 150 V/m peak with pulse modulation of 4 percent duty cycle with a 1 kHz pulse repetition frequency. This signal must be switched on and off at a rate of 1 Hz with a duty cycle of 50 percent.

(e) *Equipment HIRF Test Level 2.* Equipment HIRF test level 2 is HIRF environment II in table II of this appendix reduced by acceptable aircraft transfer function and attenuation curves. Testing must cover the frequency band of 10 kHz to 8 GHz.

(f) *Equipment HIRF Test Level 3.* (1) From 10 kHz to 400 MHz, use conducted susceptibility tests, starting at a minimum of 0.15 mA at 10 kHz, increasing 20 dB per frequency decade to a minimum of 7.5 mA at 500 kHz.

(2) From 500 kHz to 40 MHz, use conducted susceptibility tests at a minimum of 7.5 mA.

(3) From 40 MHz to 400 MHz, use conducted susceptibility tests, starting at a minimum of 7.5 mA at 40 MHz, decreasing 20 dB per frequency decade to a minimum of 0.75 mA at 400 MHz.

(4) From 100 MHz to 8 GHz, use radiated susceptibility tests at a minimum of 5 V/m.

Rationale: Specific requirements for HIRF environments and equipment HIRF test levels were deleted and a placeholder inserted indicating that HIRF environments and equipment HIRF test levels need to be established for UAS. There is insufficient evidence, to date, to establish whether HIRF requirements specified in Part 27, Appendix D are applicable *as is* to UAS and to their intended operational environments. It is possible, given that some UAS operations may require flights that are slow and close to the surface, that HIRF environments that UAS encounter might differ from those that Part 27 rotorcraft typically encounter.

#### Suggested Requirements Abstracted from FAR Part 27

##### ***CMS(a) Design characteristics for autopilot control – New Suggested Requirement***

***The applicant must establish stability, controllability, and maneuverability design margins that prevent***

***(a) contact of the vehicle rotors with the ground, other parts of the vehicle structure, or obstacles in normal and non-normal operations and***

***(b) any other condition that could compromise rotor system integrity, resulting in the ejection of high energy parts in flight.***

***(c) The applicant must demonstrate that the proposed control system design and installation meets or exceeds these requirements. Considerations include but are not limited to the following:***

- (4) critical values of design parameters including weight, center of gravity, rotor speed, speed, density altitude, and height-speed envelope,***
- (5) normal operations such as takeoff, landing, and cargo attachment and removal (possibly in flight), as well as critical values of operational parameters such as winds (both steady and gusts), temperatures, terrain slopes, etc. for which operational approval is sought, and***
- (6) non-normal operations such as autorotation, unintended cargo shift or release, and contingency maneuvers.***

Rationale: The possibility of injury to or death of bystanders proximate to the operational area from high-energy debris is a key concern for unmanned rotorcraft operations. This requirement addresses issues related to inadequate stability, controllability and maneuverability of the UA in circumstances that can lead to rotor, hub, or drive system damage and subsequent release of high-energy debris (e.g., rotor blades) in flight that may pose harm to humans nearby (beyond the operational volume). This includes mitigating the risks associated with issues such as: (a) loss of control during takeoff, leading to vehicle rollover and destruction of the main rotors near ground personnel, or (b) loss of control during flight or hover near the containment boundary, leading to uncontrolled descent into terrain in proximity to persons near the border outside the containment zone. The following requirements from Part 27 may be relevant: §27.25, §27.27, §27.33, §27.51, §27.71, §27.75, §27.87, §27.141, §27.143, §27.151, §27.173, §27.175, §27.177, §27.231, §27.321, §27.337, §27.671, §27.672, §27.735, §27.1151(a) only, §27.1323, §27.1419, §27.1519, §27.1545, §27.1587, and §27.1589.

##### ***CMS(b) Ancillary support systems for controllability, maneuverability and stability -- New Suggested Requirement***

***The applicant must ensure that flight control commands from all sources (stability augmentation system, autopilot, control station, etc.) are passed to the appropriate flight control surfaces without hazardous flexure, slop, friction, jamming, interference or other hazards that would lead to loss of rotor system integrity.***

***Considerations include but are not limited to the following:***

***(a) electrical and mechanical aspects of the control system, and includes control of engines, rotor brakes, and other elements of the design that involve automated or remote operation of the vehicle controls,***

***(b) normal operational conditions, such as those encountered during takeoff, landing, and cargo attachment and removal (possibly in flight), and***

***(c) non-normal operational conditions that may reasonably be expected in service.***

Rationale: The design of vehicle stability, maneuverability and control systems must address issues related to their proper manufacture, installation, and maintenance. This requirement captures those issues related to the design, manufacture, assembly, and installation of the physical systems that directly impact the relevant hazards relating to loss of control of the UA, leading to the ejection of high energy parts outside the containment zone (e.g., rotor, hub or drive systems). The following requirements from Part 27 may be relevant: §27.307, §27.309, §27.391, §27.395, §27.605, §27.607, §27.621, §27.623, §27.625, §27.671, §27.675, §27.679, §27.681, §27.683, §27.685, §27.687, and §27.695.

***SI Design characteristics for structural integrity -- New Suggested Requirement***

***(a) The applicant must establish design, inspection, fabrication, and materials requirements, safety margins, and limitations of the structure of the rotor, hub, and drive systems to prevent in-flight loss of rotor system integrity.***

***Considerations should include***

***(1) any secondary structure whose failure could adversely affect the rotor system,, and***

***(2) primary load paths and supporting structure affecting the rotor system.***

***(b) The design, safety margins, and limitations should cover all conditions likely to be encountered in normal and non-normal operations.***

***(c) Design considerations include but are not limited to static analysis, dynamic analysis, and fatigue analysis and testing at critical conditions of weight, center of gravity, engine/rotor speed, engine/rotor torque, ground resonance, and any other safety-critical conditions.***

Rationale: Release of high energy parts at altitude that could exit the operational volume and pose harm to crew or bystanders must be mitigated. Any structure or components of the vehicle related to the rotor system must be designed to prevent in-flight loss of rotor system structural integrity that could lead to the release of high energy parts at altitude. This includes any part necessary to transmit power from the engine to the rotor hubs including gear boxes, shafting, universal joints, couplings, rotor brake assemblies, clutches, supporting bearings for shafting, attendant accessory pads or drives, and any cooling fans that are part of, or attached to, or mounted on the rotor drive system. The following requirements from Part 27 may be relevant: §27.25, §27.27, §27.33, §27.51, §27.75, §27.87, §27.141, §27.251, §27.307, §27.309, §27.321, §27.337, §27.361, §27.391, §27.547, §27.549, §27.571, §27.573, §27.605, §27.613, §27.621, §27.623, §27.625, §27.653, §27.659, §27.661, §27.663, §27.681, §27.927, §27.1151 (a only), §27.1193, §27.1323, §27.1419, §27.1509, and §27.1545.

***PPS Powerplant explosion prevention -- New Suggested Requirement***

***The rotorcraft powerplant, powerplant installation, and associated systems (e.g., fuel, oil, ventilation, exhaust, and air induction systems), including relevant elements of the ground support equipment, must be designed to prevent in-flight explosion or release of high energy parts that could cause serious injury. Considerations include, but are not limited to:***

***(a) showing by analysis or test that the probability of releasing high energy parts that could cause injury is minimized, and***

***(b) providing supplemental protection to the ground crew during servicing and inspection of the rotorcraft for preflight, post-flight, and thru-flight servicing (e.g., loading and unloading cargo).***

Rationale: The use of a Part 33 certified powerplant or installation is not assumed. Therefore, this requirement is intended to address powerplant-related requirements that protect the vehicle from exploding in flight and releasing high energy parts. This requirement includes engine design and/or containment provisions to prevent and/or contain high-energy engine and other rotating machinery parts, as well as design and testing requirements for any engine supporting systems that may have explosion potential due to flammable fluids, pressurized systems, ignition sources, or the potential for hazardous interactions with each other or other vehicle systems. The intent of this requirement is to prevent high-energy parts from being released outside of the containment area during flight. This requirement also provides for equipment-related supplemental protection for the ground crew, especially in instances when the ground crew is in close proximity to the rotorcraft. The following requirements from Part 27 may be relevant: §27.963, §27.965, §27.967, §27.993, §27.995, §27.997(c) only, §27.999(b)(2) only, §27.1013, §27.1015, §27.1017, §27.1021, §27.1041, §27.1091, §27.1121, §27.1123, §27.1141(d) and (e) only, §27.1163, §27.1183, §27.1185, §27.1187, §27.1189, §27.1191, §27.1193, §27.1337, and §27.1521.

**Suggested Requirements For Novel UAS Technologies**

***Containment in a designated operational volume -- New Suggested Requirement***

***A means to detect and avoid transgression of any containment boundaries (or boundaries of a designated operational volume) must be designed and installed on the vehicle. This includes the following considerations:***

***(i) The accuracy of the estimation of the unmanned aircraft's position relative to the containment boundaries must be sufficient to ensure that the aircraft will not exit a containment boundary.***

***(j) Situational awareness of the unmanned aircraft's location relative to the containment boundaries should be maintained at all times during all flight operations.***

***(k) Failure of infrastructure not part of the UAS (e.g., GPS, cellular telephone) must not significantly interfere with the determination of the location of the unmanned aircraft for purposes of containment.***

***(l) Means of detection should:***

- (3) *have complete and unobstructed surveillance of any established containment boundaries, at all times during all flight operations in all weather conditions (e.g., lighting and visibility conditions) for which operations are approved; and*
- (4) *be able to determine impending violations of any established boundary, in sufficient time for action to avoid crossing the boundary.*
- (m) *If action by the pilot in command is required to ensure the unmanned aircraft does not cross any established containment boundary, quick acting means must be provided to alert the pilot in command.*
  - (2) *Timing thresholds for alerts should consider the time needed (i) to transmit data via radios or other means of communication, (ii) for ground control station processing and annunciation, and (iii) for human response, as relevant.*
- (n) *Means of avoidance must be sufficient to ensure the aircraft remains within the established containment boundaries at all times.*
  - (4) *Latency and availability of any command and control datalink or other communication links required for avoidance should be considered in establishing timing thresholds for avoidance maneuvers and shown to be acceptable for ensuring an avoidance maneuver can be executed to maintain containment.*
  - (5) *Activation of an avoidance maneuver from on board the aircraft must be communicated to the pilot in command in a timely manner.*
  - (6) *Confirmation of the completion of any avoidance maneuver must be communicated to the pilot in command in a timely manner.*
- (o) *The containment system design must consider events wherein release of high energy parts may constitute a hazard to bystanders outside the containment area.*
- (p) *The performance of the containment system must not be degraded by any form of interference under any foreseeable operating condition. Considerations should include, but are not limited to:*
  - (4) *electromagnetic interference caused by any other unmanned aircraft systems,*
  - (5) *electromagnetic interference external to the aircraft, and*
  - (6) *interference via acoustic, thermal, vibrational, chemical, or metallurgical means.*

Rationale: The operational context requires that the UA stay within a designated authorized operational volume throughout all phases of flight to avoid operating beyond its authorization and to avoid a fly away event. Consequently, the UA must be equipped with a system with the ability to detect impending violations of any boundary of the containment or operational volume and take timely action to ensure the boundary is not crossed.

#### ***Detect and avoid intruder aircraft -- New Suggested Requirement***

*A means to detect and avoid other aircraft that may intrude on the containment or designated operational volume or otherwise pose a threat to loss of separation with the unmanned aircraft shall be provided.*

- (e) *Means of detecting other aircraft will:*
  - (4) *be able to detect other airborne vehicles*
    - (iii) *at a sufficient range beyond the operational volume to allow time for an avoidance maneuver. Range considerations may include, but are not limited to, environment and topology, characteristics of the aircraft fleets at surrounding airports, and radar characteristics*
    - (iv) *with sufficient accuracy to ensure safe separation is maintained;*
  - (5) *have complete and unobstructed coverage of the containment volume, and*
  - (6) *be active at all times during all flight operations in all weather, lighting, and visibility conditions for which operations are approved.*
- (f) *If action by the pilot in command is required to avoid loss of separation with an airborne vehicle, quick acting means must be provided to alert the pilot in command.*
  - (2) *Timing thresholds for alerts should consider the time needed*
    - (iv) *to transmit data via radios or other means of communication,*
    - (v) *for ground control station processing and annunciation, and*
    - (vi) *for human response, as relevant.*
- (g) *Means of avoidance must be sufficient to ensure the UA maintains sufficient separation from other aircraft at all times.*
  - (6) *Latency and availability of any command and control datalink or other communication links required for avoidance should be considered in establishing timing thresholds for avoidance maneuvers and shown to be acceptable for ensuring an avoidance maneuver can be executed to maintain separation.*
  - (7) *The avoidance maneuver must maintain separation from all other aircraft throughout its execution duration.*



- (8) Confirmation of any avoidance maneuver must be communicated to the pilot in command.
- (9) Clearance distances from containment boundaries should be established and maintained for avoidance maneuvers to avoid harm to persons on the ground.
- (10) Normal operations may only resume when the UA is well clear of all other aircraft.
- (h) The performance of the aircraft detection and avoidance system must not be degraded by any form of interference under any foreseeable operating conditions. Considerations include, but are not limited to:
  - (4) electromagnetic interference caused by any other UA systems,
  - (5) electromagnetic interference external to the UA, and
  - (6) interference via acoustic, thermal, vibrational, chemical or metallurgical means.

Rationale: The unmanned aircraft is responsible for remaining well clear of all other aircraft, including both manned and unmanned aircraft. All other airborne vehicles, including other UA, should be given priority.

**Detect and avoid ground-based obstacles -- New Suggested Requirement**

*The applicant must provide a means to detect and avoid persons and objects within the containment or designated operational volume during flight operations.*

- (e) Means of detection will:
  - (3) have sufficient range in the direction of UA travel to permit a simple avoidance maneuver (e.g., hovering or landing), and
  - (4) provide detection during all flight operations in all weather, lighting, and visibility conditions for which operations are approved.
- (f) If action by the pilot in command is required to avoid collision or remain a safe distance from persons or objects to prevent harm, quick acting means will be provided to alert the pilot in command.
  - (2) Timing thresholds for alerts should consider the time needed (i) to transmit data via radios or other means of communication, (ii) for ground control station processing and annunciation, and (iii) for human response, as relevant.
- (g) Means to suspend operation or provide an otherwise safe state shall be provided.
  - (5) Latency and availability of any command and control datalink or other communication links required for avoidance should be considered in establishing timing thresholds for avoidance maneuvers and shown to be acceptable.
  - (6) Minimum clearances should be established.
  - (7) Confirmation of any avoidance maneuver should be communicated to the pilot in command in a timely manner.
  - (8) Normal operations may only resume when the situation has been judged to be sufficiently safe to continue the flight path.
- (h) The performance of the detection and avoidance system must not be degraded by any form of interference under any foreseeable operating conditions. Considerations include, but are not limited to:
  - (5) electromagnetic interference caused by any other UA systems,
  - (6) electromagnetic interference external to the UA, and
  - (7) interference via acoustic, thermal, vibrational, chemical or metallurgical means, and
  - (8) environmental conditions (e.g., atmospheric reflection or refraction, light scattering due to water or ice features, etc.).

Rationale: The UA must have a system that addresses hazards that could result in directly colliding with people (third parties) or colliding with other objects within the containment or designated operational volume. Any such system must have the ability to detect persons or objects within the operational volume and take timely action to ensure the UA does not collide with them or come within sufficient proximity to cause harm.

**Safety-critical command and control (C2) links -- New Suggested Requirement**

*The applicant must include at least one safety-critical C2 link for use by the pilot to command the UA to a safe state and for providing safety-critical data from the UA to the pilot. Any datalink referred to below is assumed to be safety-critical.*

- (f) The C2 link shall:
  - (3) be available in all vehicle attitudes under all foreseeable operating conditions throughout the containment volume, and
  - (4) enable communication for safety-critical data at all points throughout the entire containment volume.
- (g) Uplink and downlink status shall
  - (6) be indicated to the pilot during all flight operations, and

- (7) *include the status of any intervening communication equipment (e.g., relays, etc.).*
- (h) *The uplink(s) used to communicate the pilot commands to the UA shall:*
  - (8) *adhere to appropriate standards of integrity, availability, continuity, reliability, and security (see assumption 3);*
  - (9) *cause operations to cease if thresholds for latency or for error rates are not met; and*
  - (10) *be active at all times during all flight operations, including during all weather, lighting, and visibility conditions for which operations are approved.*
- (i) *The downlink(s) used to communicate safety-critical vehicle information to the pilot in command shall:*
  - (4) *adhere to standards of integrity, availability, continuity, reliability, and security;*
  - (5) *meet established standards for error rates; and*
  - (6) *be capable of communicating data from the UA at all times during all flight operations in all weather, lighting, and visibility conditions for which operations are approved.*
- (j) *The performance of the C2 link (e.g., availability and quality of service) must not be degraded by any form of interference under any foreseeable operating conditions. Considerations include, but are not limited to:*
  - (10) *electromagnetic interference caused by any other UA system,*
  - (11) *electromagnetic interference external to the UA,*
  - (12) *ionospheric, atmospheric, or rain attenuation,*
  - (13) *quality of any relay mechanisms, including the guaranteed quality ratio of the signal received to that of the signal propagated, as well as any voting mechanisms used to distinguish between multiple signals (e.g., at the signal distance),*
  - (14) *passive (random) reflection, groundwave propagation, temperature inversion, refraction through the earth's atmosphere, anomalous and/or multipath propagation, Rayleigh fading and finite absorption,*
  - (15) *malicious interference/spoofing or link takeover,*
  - (16) *frequency access scheme, link budget, bandwidth characteristics and frequency assignment planning criteria of the C2 link,*
  - (17) *adjacent or shared frequencies, and*
  - (18) *interference related to shared resources (e.g., power).*

Rationale: A UAS might include any number of datalinks, but not all datalinks have safety significance. These requirements address only those datalinks that have a safety-critical role. There must be at least one safety critical C2 link in the design of the UA for use by the pilot in command to command the UA to a safe state and for providing safety-critical data from the UA to the pilot. These requirements are based on two assumptions: (1) there is a unique pairing between the ground control station and the UA (that is, no handoffs between ground control stations and no simultaneous control of more than one UA; and, (2) the FAA or a standards organization such as the RTCA will, at some point, specify qualitative standards for datalink integrity, availability, continuity, reliability, and security.

***Systems and equipment to support pilot and crew safety roles -- New Suggested Requirement***

***Equipment intended for crewmembers' use in the operation of the UA must be shown, individually and in combination with other equipment, to be designed so that qualified crewmembers can safely perform their tasks associated with its intended function.***

- (g) ***Equipment to support both the presentation of information and the controls necessary to act on that information in the accomplishment of safety tasks must be provided.***
  - (4) ***Sufficient information and control authority must be provided to monitor and control the flight path of the rotorcraft within the approved operational envelope and operational volume. Considerations should be given to, but are not limited to: an airspeed indicator, an altimeter, a magnetic direction indicator, a vehicle position indicator, and a vehicle health status indicator.***
  - (5) ***Sufficient information and control authority must be provided to monitor and control the powerplant to avoid failures that adversely affect safety. Considerations should be given to, but not limited to, the following for all engines, tanks, and pumps: temperature, pressure, and quantity, rotor and engine r.p.m., and ferromagnetic particle detector.***
  - (6) ***Each means to control the rotorcraft's flight path or associated systems (e.g., waypoint control, return-to-base, etc.) must be accessible and usable by the crew for the intended function with the required urgency.***
- (h) ***Flight controls and information intended for crew use must:***
  - (4) ***Be presented in a clear and unambiguous form, at resolution and precision appropriate to the task.***
  - (5) ***Be accessible and usable by the crew in a manner consistent with the urgency, frequency, and duration of their tasks, and***

**(6) Enable crew awareness, if awareness is required for safe operation, of the effects on the rotorcraft resulting from crew actions.**

**(i) Operationally-relevant behavior of the equipment must be:**

**(3) Predictable and unambiguous, and**

**(4) Designed to enable the crew to intervene in a manner appropriate to the task.**

**(j) To the extent practicable, equipment must enable the crew to manage errors resulting from the kinds of crew interactions with the equipment that can be reasonably expected in service, assuming the crew is acting in good faith. This subparagraph (d) does not apply to skill-related errors associated with control of the UA.**

**(k) Equipment, markings, and lighting to support crewmembers' general situational awareness, such as ground-based area lighting, aural warnings for start-up and landing, etc. must be provided.**

**(l) Equipment to effectively support safety-critical communication between crewmembers, if such communication is needed for safe operation, must be provided.**

Rationale: Different operations may require different safety roles for the pilot, crew, and automated systems. As such, there is not a clear, universal safety role for the pilot and crew for all unmanned operations. To enable different vehicle capabilities and different operations, a specific safety role for the pilot and crew must be defined. The required instrumentation, indicators, and control effectors, and their quality attributes vary based on the designated safety role. This requirement is based on the FAA and EASA Certification Standard for large airplanes (§25.1302 and CS §25.1302). The following requirements from Part 27 may be relevant: §27.1303, §27.1305, §27.1321, §27.1322, §27.1327, §27.1335, §27.1337, §27.1381, §27.1383, and §27.1399.

