



**Uniden®**

## **UBCT9 Scanner**

250 Channels  
12 Bands  
Programmable  
Trunk Tracker III  
with Close Call RF Capture

# **OWNER'S MANUAL**



---

## Precautions

---

---

Before you use this scanner, please observe the following:

### **WARNING!**

Uniden does not represent this unit to be waterproof. To reduce the risk of fire, electrical shock, or damage to the unit, do not expose this unit to rain or moisture.

### **IMPORTANT!**

- Changes or modifications to this product not expressly approved by Uniden, or operation of this product in any way other than as detailed by this Operating Guide, could void your authority to operate this product.
- The screen displays used in this manual are representations of what might appear when you use your scanner.





# Contents

Introduction.....	1
Front and Rear Views.....	2
Icon Display.....	3
Terminology.....	4
What is Scanning?.....	4
What is Searching?.....	4
What is Trunk Tracking?.....	4
Feature Highlights.....	6
Included with Your Scanner Package.....	7
Optional Accessories.....	7
Installing the UBCT9.....	8
For Home Use (Desktop Installation).....	8
For Mobile Use (In-Car Installation).....	8
Typical Mounting Methods.....	10
Mounting the Scanner in Your Vehicle.....	10
Applying Power for Vehicle Installation.....	11
Applying Power Using Standard AC Power.....	12
Connecting an External Speaker.....	12
Listening Safely.....	12
Connecting the Clone Cable.....	12
Scanning Overview.....	13
Turn the Scanner On.....	13
How Squelch Works.....	14
Setting the Squelch.....	14
State Scanning.....	15
Selecting the State.....	15
State Scan Hold.....	16
Storing State Scan Frequency.....	16
Skip a Frequency.....	16
Close Call RF Capture.....	17
Set Close Call Mode.....	17
Close Call Operation.....	18
Set Close Call Option.....	19
Select Close Call Bands.....	19
Set Close Call Alert.....	20
Setting of Pager screen.....	20
Alert Tone Volume.....	20
Alert Light Adjustment.....	20
Private Bank Scanning.....	21
Programming Frequencies into Channels.....	21
Deleting a Stored Frequency.....	21
Duplicate Frequency Alert.....	22
Memory Lock.....	22
Scanning Private Bank.....	22
Hold/Resume.....	23
Channel Lockout.....	23
Restoring a Locked-out Channel in Hold Mode.....	23
Restoring All Locked-out Channels.....	24
Priority Scan.....	24
Changing the Priority Channel.....	24
Service Scanning.....	25
Band Search.....	26
Setting a Search Band.....	26





Search Hold Feature .....	27
Data Skip.....	27
Frequency Skip .....	27
Storing Search Frequencies.....	28
Delay .....	28
Trunk Tracking.....	29
Setting the Squelch.....	29
Programming Trunking Frequencies .....	30
STEP 1: Selecting Trunking System Type .....	30
STEP 2: Programming Trunking Frequencies .....	31
Programming Talk Group ID/Scan Lists .....	31
Scan Lists .....	31
Receiving Trunked Systems .....	33
ID Scan Mode .....	33
ID Scan Hold Feature .....	34
ID Search Mode .....	34
ID Monitor Mode .....	35
ID Search Hold and Direct Entry ID in Hold Mode .....	35
Programming Scan Lists During Search .....	35
Deleting a Stored ID .....	35
ID Lockout .....	36
Review ID Lockout .....	36
Restoring Locked-out ID's .....	36
Setting the Delay Mode for Trunking Mode .....	37
Trunking Frequency Confirmation .....	37
Setting Priority in Trunking Mode .....	37
Moving between Scan List Memories .....	37
Multi-Track .....	38
EDACS <sup>®</sup> Reception .....	39
EDACS <sup>®</sup> Tracking.....	39
Programming EDACS <sup>®</sup> System Frequencies.....	39
An EDACS <sup>®</sup> Trunked system .....	40
Special EDACS <sup>®</sup> Features .....	41
EDACS <sup>®</sup> ID Range Search.....	41
EDACS <sup>®</sup> SCAT.....	41
LTR <sup>®</sup> Reception .....	42
LTR <sup>®</sup> Tracking .....	42
Motorola Reception .....	43
Motorola Tracking .....	43
Fleet Map Programming .....	44
Selecting Preset Fleet Map .....	44
Programming a User Fleet Map .....	44
Programming a Hybrid System .....	45
Setting the Base, Spacing Frequencies and Offset Channel for Motorola VHF/UHF Trunked Systems.....	45
Toggling the Status Bit .....	46
Control Channel Only Mode .....	46
Disconnect Tone Detect Option (End Code) .....	47
Remote Interface .....	48
PC Control Mode .....	48
Clone Mode .....	49
Care and Maintenance .....	52
Troubleshooting .....	53
Specifications .....	55
Appendix .....	56
One Year Limited Warranty .....	63





---



---

## Introduction

---



---

The UBCT9 is a state-of-the-art Trunk Tracking Scanner with Bear Tracker technology. It can store 250 frequencies such as police, fire/emergency, marine, railroad, air, amateur, and other communications into 5 banks of 50 channels for a total of 250 channels.

Use your new scanner to monitor:

- Close Call <sup>™</sup> RF Capture
- Police
- Trunking for:
  - Motorola
    - Type I
    - Type II
    - Type II: (Hybrid)
  - EDACS
    - Wide band
    - Scat
  - LTR
- Business/Industrial Radio
- Utilities
- Marine Band
- Aircraft Band
- And much more...

The chart below identifies the scanner band numbers, the frequency range, the modulation mode and the default step size settings.

No	Range (Mhz)	Mode	Step
1	0025.0000 - 0027.9950	AM	5kHz
2	0028.0000 - 0069.9900	FM	10kHz
3	0070.0000 - 0087.9875	FM	12.5kHz
4	0088.0000 - 0107.9000	WFM	100kHz
5	0108.0000 - 0136.9875	AM	12.5kHz
6	0137.0000 - 0147.9950	FM	5kHz
7	0148.0000 - 0173.9875	FM	12.5kHz
8	0174.0000 - 0224.9500	WFM	50kHz
9	0225.0000 - 0399.9500	AM	50kHz
10	0400.0000 - 0512.0000	FM	6.25kHz
11	0806.0000 - 0956.0000	FM	12.5kHz
12	1240.0000 - 1300.0000	FM	12.5kHz





## Front and Rear Views

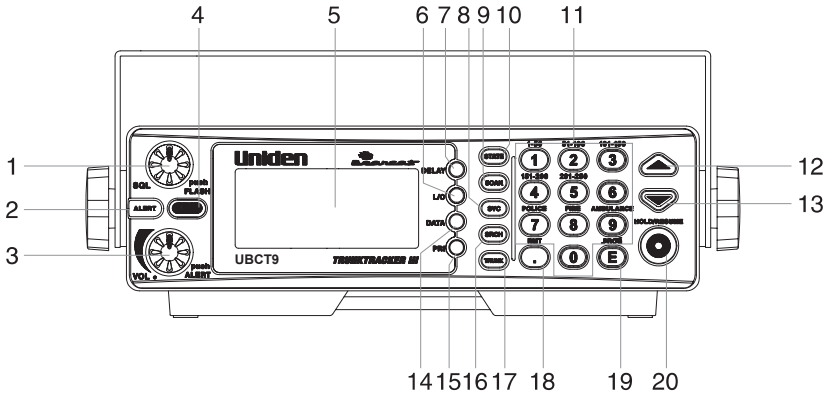

- |                                                                                                                                                                                                                                                                                                                                                                                                                                                                                                                                                     |                                                                                                                                                                                                                                                                                                                                                                                                                                                    |
|-----------------------------------------------------------------------------------------------------------------------------------------------------------------------------------------------------------------------------------------------------------------------------------------------------------------------------------------------------------------------------------------------------------------------------------------------------------------------------------------------------------------------------------------------------|----------------------------------------------------------------------------------------------------------------------------------------------------------------------------------------------------------------------------------------------------------------------------------------------------------------------------------------------------------------------------------------------------------------------------------------------------|
| <ol style="list-style-type: none"> <li>1. Squelch Control / Flash Brightness Selector (<b>SQL, FLASH</b>)</li> <li>2. Alerting Light (<b>ALERT</b>)</li> <li>3. Volume Control / Alert Tone Selector (<b>VOL</b>)</li> <li>4. Close Call RF Capture (<b>C.C.</b>)</li> <li>5. Display (window)</li> <li>6. Lockout Key (<b>L/O</b>)</li> <li>7. Delay Key (<b>DELAY</b>)</li> <li>8. Service Key (<b>SVC</b>)</li> <li>9. State Scan or Private Scan Key (<b>SCAN</b>)</li> <li>10. State Key (<b>STATE</b>)</li> <li>11. Numeric Keypad</li> </ol> | <ol style="list-style-type: none"> <li>12. Up Key (<b>▲</b>)</li> <li>13. Down Key (<b>▼</b>)</li> <li>14. Data Key (<b>DATA</b>)</li> <li>15. Priority Key (<b>PRI</b>)</li> <li>16. Search Key (<b>SRCH</b>)</li> <li>17. Trunk Key (<b>TRUNK</b>)</li> <li>18. Decimal/Remote Key (<b>●</b>, <b>RMT</b>)</li> <li>19. Enter / Program Enable - Disable Key (<b>E</b>, <b>PROG</b>)</li> <li>20. Hold/Resume Key (<b>HOLD/RESUME</b>)</li> </ol> |
|-----------------------------------------------------------------------------------------------------------------------------------------------------------------------------------------------------------------------------------------------------------------------------------------------------------------------------------------------------------------------------------------------------------------------------------------------------------------------------------------------------------------------------------------------------|----------------------------------------------------------------------------------------------------------------------------------------------------------------------------------------------------------------------------------------------------------------------------------------------------------------------------------------------------------------------------------------------------------------------------------------------------|

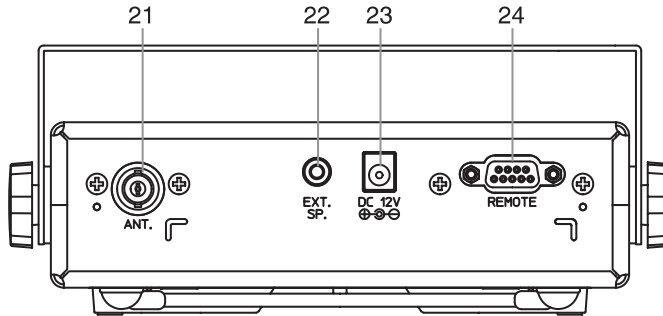

- |                                                                                                                                            |                                                                                                                                          |
|--------------------------------------------------------------------------------------------------------------------------------------------|------------------------------------------------------------------------------------------------------------------------------------------|
| <ol style="list-style-type: none"> <li>21. Antenna Connector (<b>ANT.</b>)</li> <li>22. External Speaker Jack (<b>EXT. SP.</b>)</li> </ol> | <ol style="list-style-type: none"> <li>23. DC Power Jack (<b>DC 12V</b>)</li> <li>24. Remote Control Terminal (<b>REMOTE</b>)</li> </ol> |
|--------------------------------------------------------------------------------------------------------------------------------------------|------------------------------------------------------------------------------------------------------------------------------------------|





## Icon Display

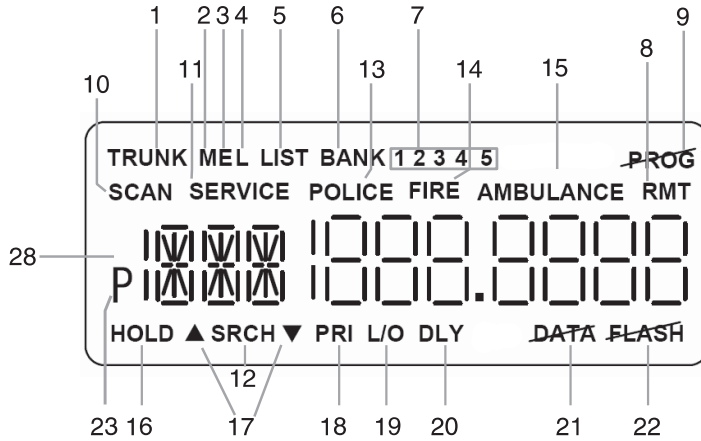

1. Trunk Tracking Mode (**TRUNK**)
2. Motorola trunking channel (**M**)
3. EDACS trunking channel (**E**)
4. LTR trunking channel (**L**)
5. Scan list (**LIST**)
6. Scan bank (**BANK**)
7. Bank's number and ID's list number (**1 2 3 4 5**)
8. Remote control mode (**RMT**)
9. Programming is locked (**PROG**)
10. State scanning and Private scanning mode (**SCAN**)
11. Service scanning mode (**SERVICE**)
12. Band searching mode (**SRCH**)
13. POLICE Bank included with State scanning (**POLICE**)
14. FIRE Bank included with State scanning (**FIRE**)
15. AMBULANCE Bank included with State scanning (**AMBULANCE**)
16. Scanning or the searching is on hold (**HOLD**)
17. Search direction (**▲, ▼**)
18. Priority function option (**PRI**)
19. Lockout channel and talk group (**L/O**)
20. Delay option (**DLY**)
21. DATA Skip option (**DATA**)
22. Warning Light disabled (**FLASH**)
23. Priority channel and talk group (**P**)



---

---

## Terminology

---

---

### What is Scanning?

Unlike standard AM or FM radio stations, most two-way communications do not transmit continuously. The UBCT9 scans the Frequencies you have programmed into the Scanner's channels until it finds an active frequency. Scanning stops on an active frequency and remains on that channel as long as the transmission continues. When the transmission ends, the scanning cycle resumes until another transmission is received.

### What is Searching?

The UBCT9 can search each of its 12 bands to find active frequencies. This is different from scanning because you are searching for frequencies that have not been programmed into your Scanner's channels. The scanner automatically chooses between two speeds while searching. During search mode the scanner will search 100 frequencies per second for bands with 12.5 kHz steps and during Turbo SEARCH mode the scanner can achieve up to 300 frequencies per second for bands with 5 kHz steps.

### What is Trunk Tracking?

Conventional scanning is a simple concept. You enter a radio frequency in your scanner's memory which is used by someone you want to monitor. For example, the police in your area may broadcast on 467.850 MHz, the fire department on 161.250 MHz, etc.

So when your scanner stops on a frequency, you usually know who it is, and more importantly, you can stop on a channel and listen to an entire conversation.

As the demand for public communications has increased, many public radio users don't have enough frequencies to meet their needs, and this has created a serious problem. Trunking radio systems have been implemented to solve this problem.

In a trunked radio system the frequencies are shared among the police and fire departments and a computer systematically assigns available frequencies when they are needed for communications.





Sharing of the available public service frequencies, or trunking, allows cities, counties, or other agencies to accommodate hundreds of users with relatively few frequencies. Following a conversation on a trunked system using a scanner is difficult, if not impossible. Because when there's a short break during the conversation you're monitoring, it's possible that the talk group will be assigned to a completely different frequency in the trunked system. This type of scanning is difficult and frustrating.

*TrunkTracker Technology* changes this! Not only does your new UBCT9 scan channels like a conventional scanner, it actually follows the users of a trunked radio system. Once you know a talk groups ID, you won't miss any of the action.

If you're a new scanner enthusiast, you may want to read the first part of this manual and use your scanner in conventional mode before you begin trunk tracking. Understanding scanning fundamentals and its terminology will make trunk tracking much easier.





---

## Feature Highlights

---

---

- Pre-programmed frequencies specific to each
- Pre-programmed Trunked frequencies
- Close Cal™ RF Capture Technology  
You can set the scanner so it detects and provides information about nearby radio transmissions.
- Pre-programmed Service Scanning by the following service banks;
  - Police
  - Rail Roads
  - Aircraft (except Aeronautic radio Navigation (108-117.9875MHz))
  - Marine Band
  - UHF CB Radio
  - AM CB Radio
- **Trunk Tracking** – Follow VHF High Band UHF 800MHz trunked public safety and public service systems just as if conventional two-way communications were used.
- **Multi-Track** – Track more than one trunking system at a time.  
Scan conventional and trunked systems at the same time.
- **250 Channels** – Program one frequency into each channel. You must have at least one channel programmed to use the Scan mode.
- **12 Bands** – Includes 12 bands, with aircraft and 800 MHz.
- **5 Banks**– 5 banks with 50 channels each are useful for storing similar frequencies to maintain faster scanning cycles or for storing all the frequencies of a trunked system.
- **25 MHz-1300 MHz**– Indicates the range of frequencies that can be searched within the bands of your scanner.  
Note: The frequency coverage is not continuous.
- **5 Priority Channels**– You can assign one priority channel in each bank. Assigning a priority channel allows you to track activity on your most important channel(s) while monitoring other channels for transmissions.  
You can also assign trunking priority talkgroups.
- **Data Skip** – Allows your scanner to skip unwanted data transmissions and reduces birdies.
- **Direct Channel Access** – Go directly to any channel without entering programming mode.
- **Turbo Search**– Increases the search speed to 300 steps per second. This applies only to transmission bands with 5 kHz steps.
- **PC Programmable** – Allows you to easily program all frequencies and Trunking Talk Groups into your UBCT9 through the Uniden UBCT9-SS programming software running on your PC.



---

## Included with Your Scanner Package

---

---

- UBCT9 Scanner
- AC Adapter
- DC Power Cord
- Cigarette Lighter Adapter Plug
- Telescopic Antenna
- Window Mount Antenna
- Operating Guide
- UBCT9 SS Programming Software CD
- Australian Scanner Frequencies CD
- Other Printed Materials
- Mobile Mounting Bracket

If any of these items are missing or damaged, immediately contact your place of purchase.

### Optional Accessories

The following optional accessories for your UBCT9 are available from your local Uniden Retailer.

**Motorola Antenna Adapter** - Use only if your antenna has a Motorola-type plug.



---

## Installing the UBCT9

---

---

### For Home Use (Desktop Installation)

1. Insert the DC plug end of the AC Adapter into the DC 12V jack on the rear panel.
2. Plug the AC Adapter into a standard 240V AC wall outlet.
3. Plug the Telescoping Antenna into the ANT connector.  
Extend the antenna to its full height. For frequencies higher than 406 MHz, shortening the antenna may improve the reception.
4. Use the desktop stand for a better viewing and operating angle.

### Helpful Hints

- If strong interference or electrical noise is received, relocate the scanner or its antenna away from the source.
- If you are operating the scanner in a fringe area or need to improve reception, use an optional antenna designed for multi-band coverage. (You can purchase this type of antenna at a local electronics store.)
- If the optional antenna has no cable, use 50-70 ohm coaxial cable for lead-in. A mating plug may be necessary for the optional antennas.

### For Mobile Use (In-Car Installation)

#### Installation for Temporary Use:

A Cigarette Lighter Power Cord is provided for easy, temporary installation.

**Warning: Do not use the cigarette lighter power cord in a positive ground vehicle.**

Plug one end of the Cigarette Lighter Power Cord into the cigarette lighter jack and the other end into the DC 12V jack on the back of the scanner.

#### Connecting the Antenna Plug

Connect the mobile antenna plug into the ANT connector on the rear panel. (For more information on antenna installation, please refer to the instruction guide that came with your antenna.)

The UBCT9 can be mounted using the supplied mounting bracket.

1. Select an ideal location in your vehicle to mount the UBCT9. Avoid a location that could interfere with your driving. In a passenger car, the ideal location is underneath the dashboard on the passenger side.
2. Use the supplied mounting bracket as a template for marking the location of the mounting screws. Note: If there are screws already holding the dashboard, you can use the same screw holes to mount the bracket.



3. Drill the necessary holes and secure the mounting bracket in place using the screws provided.
4. Mount the radio to the bracket only after the wiring has been connected to the rear panel.

### Connecting the Power Cord

**Note:** If you are not experienced in connecting accessories to the vehicle fuse box, please see your automotive dealer for advice on proper installation.

### Installation for everyday use:

1. Check the vehicle battery connections to determine which battery terminal (positive or negative) is grounded to the engine block or chassis. Most of today's vehicles use a negative ground. If your vehicle has a negative ground, follow Steps 2 and 3. Otherwise, skip to the note following Step 3.
2. Connect the RED wire of the DC power cord to the accessory contact in your vehicle's +12V DC fuse box.
3. Connect the BLACK wire of the DC power cord to the negative side of the vehicle (usually the chassis).

**Note:** In vehicles with a positive ground, the RED wire connects to the chassis and the BLACK wire connects to the accessory contact in the fuse box.

4. Insert the DC plug into the DC 12V jack on the back of the scanner.



## Typical Mounting Methods

The UBCT9 can be conveniently mounted on a table, bulkhead, overhead, or any other desired location with the supplied mounting bracket (refer to figure below for typical mounting methods).

**Caution:** Make sure there are no hidden electrical wires or other items behind the desired location before proceeding. Check that free access for mounting and cabling is available.

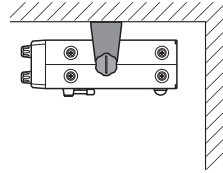
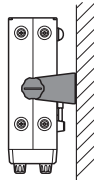
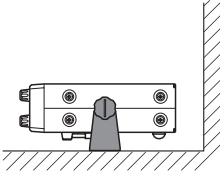

• Table top mount

• Bulkhead mount

• Overhead mount

## Mounting the Scanner in Your Vehicle

Before you mount the scanner, make sure you have all the necessary materials. Then confirm that the scanner fits your vehicle's mounting area. This unit requires a mounting area of 50.8mm high by 176.5mm wide by 153.6mm deep.

**Caution:** Be sure to avoid obstructions behind the mounting surface.

Follow these steps to mount the scanner in your vehicle.

1. Choose a mounting location, then use the supplied mounting bracket as a template to mark the positions for the mounting screw holes.
2. In the marked positions, drill holes slightly smaller than the supplied screws.
3. Attach the mounting bracket to the mounting location using the supplied screws and lock washers.
4. Attach the scanner to the mounting bracket using the supplied mounting knobs.
5. Connect the antenna's cable to the **ANT.** connector on the rear of the scanner.

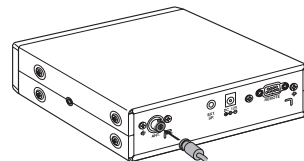
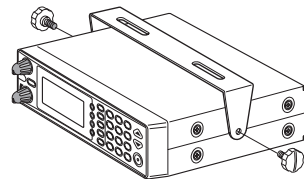
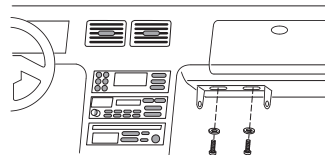

**Note:** If the antenna cable's connector does not fit in the **ANT** connector, you might also need a Motorola-to BNC antenna plug adapter (available at a local electronics store).





## Applying Power for Vehicle Installation

You can power your scanner using the supplied DC cigarette lighter power cord or an DC power cord.

### DC power Installation

To power the scanner from a vehicle's 12V power source (such as a cigarette-lighter socket), you need a cigarette-lighter adapter.

To connect an DC cigarette-lighter power cable, insert its barrel plug into the **DC 12V** jack on the rear of the scanner, then plug the power cable into your vehicle's cigarette lighter socket.

**Note :** If you use a cigarette-lighter power cable and your vehicle's engine is running, you might hear electrical noise from the engine while scanning. This is normal.

**Caution:** DC 12 V Jack can use a power source that supplies 12V DC at least 500 mA. You must use a power source that supplies 12V DC and delivers at least 500 mA. Your standard 12V car battery should be sufficient. The cord connector's center tip must be set to positive and its plug must fit the scanner's **DC 12V** jack. The supplied DC power cord meets these specifications. Using a power cord that does not meet these specifications could damage the scanner or the adapter.

- Always connect the adapter or DC power cord to the scanner before you connect it to the power source. When you finish, disconnect the adapter or DC power cord from the power source before you disconnect it from the scanner.
- For added safety and to protect your scanner, disconnect the cable from your vehicle battery's negative (-) terminal before you begin.

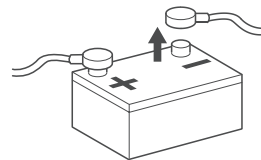

Follow these steps to connect the DC power cord.

1. Connect the power cord's black wire to a chassis ground, such as a metal screw attached to a metal part of the vehicle's frame. Be sure that the screw is not insulated from the frame by a plastic part.
2. Connect the power cord's red wire (with in-line fuse) to a source of voltage that turns on and off with the ignition switch, such as a spare accessory terminal in your vehicle's fuse box.
3. Insert the power cord's barrel plug into the **DC 12V** jack on the rear of the scanner.
4. Reconnect the cable to the vehicle battery's negative (-) terminal.

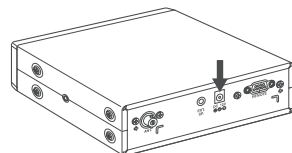
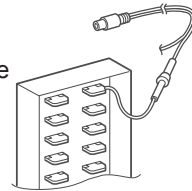



## Applying Power Using Standard AC Power

To power the scanner from an AC outlet, use the provided AC adapter with a 5.5 mm outer diameter/2.1mm inner diameter tip.

**Caution:** You must use a Class 2 power source that supplies 12V DC and delivers at least 500 mA. The cord connector's center tip must be set to positive and its plug must fit the scanner's **DC 12V** jack. Using an adapter that does not meet these specifications could damage the scanner or the adapter.

- Always connect the AC adapter to the scanner before you connect it to AC power. When you finish, disconnect the adapter from the AC power before you disconnect it from the scanner.

1. Insert the adapter's barrel plug into the **DC 12V** jack on the rear of the scanner.
2. Plug the adapter into a standard AC outlet. Use only the AC adapter supplied with your scanner.

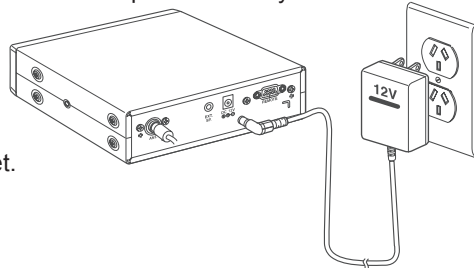

## Connecting an External Speaker

In a noisy area, an external speaker (available at a local electronics store) positioned in the right place might provide more comfortable listening.

Plug the speaker cable's 1/8 inch (3.5 mm) plug into your scanner's **EXT. SP** jack.

**Note:** Connecting an external speaker disconnects the scanner's internal speaker.

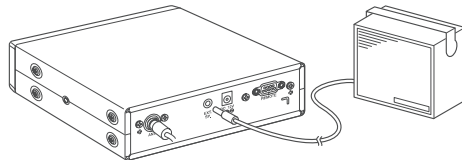

## Listening Safely

- Do not use the earphone. The volume is not adjustable for the Warning Alert and damage to your hearing could occur.

## Connecting the Clone Cable

You can transfer the programmed data to and from another UBCT9 scanner using a RS232C Straight Cable (9 pin to 9 pin) (not supplied). Connect the cable between each scanner's **REMOTE** jacks. See "Clone Mode" on page 49. You can also upload or download the programmed data to or from a PC using the UBCT9-SS programming software included with the UBCT9.







## Scanning Overview

You can scan in one of five ways:

- 1. Close Call RF Capture** When you activate Close Call your scanner will detect nearby strong radio frequencies. You may run Close Call in the background of any of the four options below or on its own.
- 2. Service Scanning** Press **SVC** to select one of the six services to find an active frequency. Police, Railroad and AM CB service frequencies are valid for Australia only. Aircraft, Marine and UHF CB service frequencies are valid for both Australia and New Zealand.
- 3. Band Search** Band Search Select a frequency band to search. The Search function is different from scanning. It searches for any active frequency step by step within the lower and upper limits of the band. When an active frequency is found, the scanner will stop and stay on that frequency as long as that transmission lasts. If that frequency is interesting to you, press **HOLD/RESUME** to hold the frequency on the display. Then program it into the private bank you want to store. If you do not want to program that frequency, press **HOLD/RESUME** or just wait until the transmission ends. The search resumes automatically 2 seconds after the last transmission and looks for more active frequencies.
- 4. Private Scanning** If you have programmed frequencies into this bank, press **SCAN**, then **1, 2, 3, 4, 5** or to scan only those that you have programmed in this bank.
- 5. State Scanning** You can select Police, Fire and Ambulance frequencies which are pre-programmed on a Australian state by state (including New Zealand) basis.

**Note:** Before you can scan the Private Bank, you must program frequencies into the channels. To program frequencies, see "Programming Frequencies into Channels" on page 21.

When scanning stops on an active frequency, it remains on that channel as long as the transmission continues. When the transmission ends, the scanner will remain on the same channel for 2 more seconds, waiting for a responding transmission. If there is no responding transmission within 2 seconds, the scanning cycle resumes.

### Turn the Scanner On

1. Turn the **VOL** knob clockwise.  
The scanner is turned on: the Alert Light flashes and the Alert Tone beeps loudly.

**Note:** The Alert Tone depends on the currently setting selected (see page 20).

2. While the alert tone sounds the display shows 'UBCT9'.  
When this stops the last setting mode selected before starts.

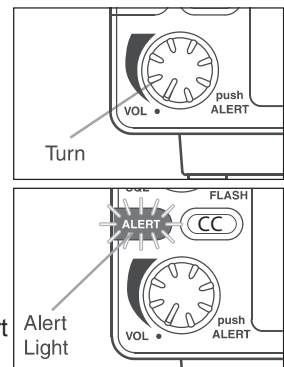



## How Squelch Works

Think of “SQUELCH” as a gate. If the gate is too low (squelch too low), everything (all noise as well as signals) gets through.

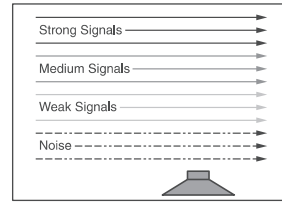

If the gate is set too high (squelch too high), nothing gets through.

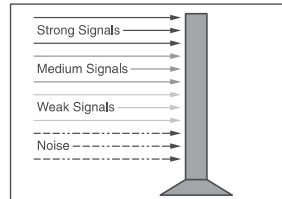

If the gate is set just right (squelch set properly), just the desired signals get through.

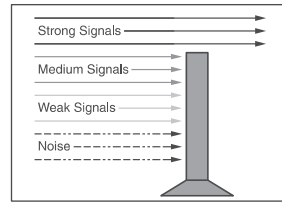

## Setting the Squelch

1. To set the squelch, press **HOLD/RESUME** to stop scanning.
2. Turn **SQL** fully counterclockwise until hiss heard. This lowers the “squelch gate,” allowing all signals and noise to get through.
3. Turn **SQL** fully clockwise just until hiss stops. This raises the “squelch gate,” allowing only strong signals to get through.

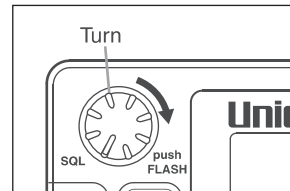
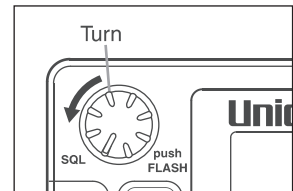



## State Scanning

Press **POLICE**, **FIRE** or **AMBULANCE** and the scanner scans through police, fire or Ambulance Frequencies and “SCAN” scrolls from right to left in the display.  
When in the State Scan mode, press **STATE** and the menu of states will appear.

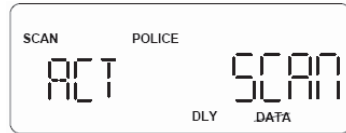

Press **POLICE**.  
The scanner will scan through Factory Programmed Police Frequencies and “**POLICE**” appears in the display.

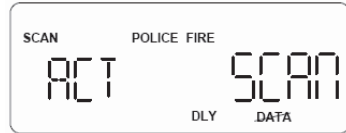

Press **FIRE**.  
The scanner will scan through Factory Programmed Fire Frequencies and “**FIRE**” appears in the display.



Press **AMBULANCE**. The scanner will scan through Factory Programmed Ambulance Frequencies, “**AMBULANCE**” appears in the display.

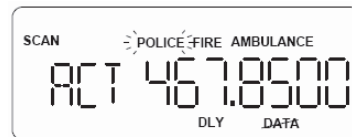

When the scanner finds a signal, scanning stops, the state code and the frequency displays.

When the transmission ends, the two seconds delay feature (if you set on) holds the scanner in that frequency for a response. If there is no response, scanning resumes. (See Delay page 28).

### Selecting the State

1. While State scanning, press **STATE**. The menu of states will appear (See State Code Order Appendix: page 56).
2. Press **STATE** and hold to scroll.
3. To step forward through the states (A-W), press **STATE** and, within 3 seconds, press repeatedly.
4. To step backward through the states (W-A), press **STATE** and, within 3 seconds, press repeatedly.





- To scroll repeatedly, press and hold ▲ or ▼ and **STATE**.

After 3 seconds, the scanner will begin to scan through the Police frequencies (Police only).

- If you want to start scanning immediately, press **HOLD/RESUME**.



### State Scan Hold

- When scanning stops on a desired frequency, press **HOLD/RESUME** to hold at that frequency as long as you like.



While "HOLD" appears in this mode, you can use ▲ or ▼ to move up or down the frequency steps. During Hold mode, you can see all frequencies sequentially. It does not depend on your selected bank.

Pressing and holding the keys for 1 sec, speeds up frequency change.

If present frequency is locked out, then "L/O" appears on LCD.



- To resume scanning, press **HOLD/RESUME**.

### Storing State Scan Frequencies

You can quickly store any frequency you find during scan.

- During scan, press **HOLD/RESUME** to store. You can press ▲ or ▼ to move up or down 1 frequency step.
- If you have found the frequency you want to store, press **E**.

- Or-

When the scanner stops on the frequency you want to store, press **E**.

- Select the private bank where you want to store the frequency, the smallest empty channel number and "000.0000" flashes on and off over the frequency you want to store. Press **E** (if the frequency you want to store exists already in a bank, you will hear an error tone and the other channel displays. Press **E** again to store the frequency in both channels).

### Skip a frequency

To skip a frequency, press **L/O**. You can program up to 100 skip frequencies.

You can skip the frequencies in the scanning sequence.

If you change the state code, skipped frequencies are cancelled as soon as scanning starts. If you change the State, skip frequencies are all clear.





## Close Call RF Capture™

Your scanner's Close Call feature lets you set the scanner so it detects then displays the frequency of a nearby strong radio transmission. Close Call RF capture works great for finding frequencies at venues such as malls and sporting events. You can set the scanner so Close Call detection works "in the background" while you are scanning other frequencies, turn off normal scanning while Close Call is working, or turn off the Close Call feature and use the scanner normally. You can set the scanner so it alerts you when the Close Call feature detects a frequency. You can also set the frequency band where you want the scanner to look for transmissions.

Unlike searching, which requires the scanner to tune to a frequency to check for a transmission, Close Call RF capture directly detects the presence of a strong, nearby signal and instantly tunes to the source's frequency.

### Notes:

Close Call RF capture works well for locating the source of strong local transmissions such as mobile and handheld two-way radios in areas with no other strong transmission sources. However, if you are in an area with many transmission sources (such as pager radio transmitters, multi-use radio towers, traffic control devices, etc.), Close Call RF capture might not find the transmission you are searching for, or it might find a transmission other than the one you are searching for.

Close Call RF capture cannot detect satellite dishes or any transmitter with a frequency above or below the frequency ranges listed in Select Close Call Bands on Page 19.

Close Call works better with some types of transmissions than others. It might not correctly display frequency information for transmitters using a highly directive antenna (such as an amateur radio beam antenna), if there are many transmitters operating at the same time in the same area, or if the transmitter is a broadcast television station.

Every 2 seconds, the scanner checks for frequencies in the range you specified in "Set Close Call Option" on page 19 and interrupts the audio when it checks for a Close call Transmission in that range.

### Set Close Call Mode

These settings affect when Close Call actually operates.

When Close Call is on with another mode, every 2 seconds the scanner will switch the filter settings to the ones set by the Close Call Bands option.

- Close Call: On Close Call is on at all times, for all modes.
- Close Call: Off Close Call is turned off for all modes.
- Close Call: Only Close Call is only available.

These modes can also be toggled by pressing **C.C.**  
When Close Call is set to On, Close Call LED is On.  
When Close Call is set to only mode, Close Call LED will flash.

When Close Call is set to off, Close Call LED is Off.  
When Close Call is on, "C-C" will be displayed every a few seconds.

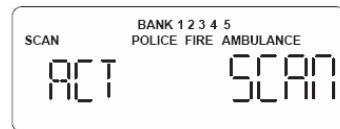



When the scanner is staying on a frequency, “- - - - -” will be displayed during “C-C” term instead of the frequency.

### Close Call Operation

1. When a signal is detected, the scanner alerts (depending on the Set Close Call Alert setting, page 20) and immediately jumps to the Close Call frequency. But, the frequency is not displayed.

**NOTE:** Close Call does not work during selecting the band search, selecting the State code and programming mode.  
If you want to confirm the frequency, press any key.

Even if a signal is lost, the scanner stops at this frequency for 10 seconds (if delay is on). After 10 seconds, the scanner resumes previous scanning.

2. If you press **HOLD** during the transmission or the delay time, the Scanner enters Close Call Hold mode and stays on the frequency. During the hold mode, the scanner does not check any other signal.
3. Press **HOLD** to resume the signal searching.
4.
  - a. If you press **HOLD** while the scanner is searching the signal, the scanner stops the and displays the current search Band.
  - b. Press **▲** or **▼** to select the searching band.
  - c. If you press **L/O**, you can set search skip frequency.
  - d. To clear all the skip frequencies, hold **L/O** for over 2 seconds.



↑ ↓

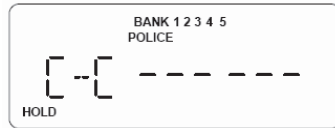



5. If you press **DELAY**, you can set DELAY function. 'DLY' appears on the screen.



6. If you press **DATA**, you can set DATA Skip function. '**DATA**' appears on the screen.



### Set Close Call Option

1. Press and hold **C.C** for 2 seconds to display the Close Call option menu.  
 "C-C.bnd" : Selecting Close Call Bands.  
 "C-C.ALT" : Close Call alert option.  
 "C-C.PS" : Setting of pager screen
2. Press **▲** or **▼** , to select the menu, and then press **E**.

### Select Close Call Bands

This setting controls the band filtering used during Close Call operation. Each of the following bands can be selected for Close Call operation:

25 - 88 MHz Band    88 - 108 MHzBand    108 - 137 MHz Band  
 137 - 174 MHz Band    174 - 311 MHz Band    311 - 512 MHz Band  
 806 - 956 MHz Band

1. Press **▲** or **▼** to select the band, and then press **E**.

The scanner flashes the "On or OFF "options.

2. Press **▲** or **▼** to select the option, and then press **E**.





## Set Close Call Alert

This option controls whether the scanner sounds an additional alert tone when a Close Call signal is detected.

Press ▲ or ▼ to select the option, and then press **E**.



## Setting of pager screen

This option sets whether the scanner screens common pager frequencies from hits during Close Call searching.

1. Press ▲ or ▼ to select the option, and then press **E**.



Pager Screen On : The scanner ignores hits on common pager frequencies.

Pager Screen OFF : The scanner does not screen for common pager frequencies.

**Note:** Pager screen affects the following frequency range.  
148.0000 - 149.2500 MHz

2. To return to previous mode, press  (decimal key).

## Alert Tone Volume

Push **VOL** to select Loud, Medium, or Soft.  
The Alert Tone beeps and the alert light flashes to confirm your choice.

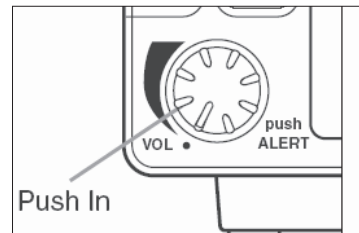

## Alert Light Adjustment

The Alert Light has three settings (Bright, Dimmer, Off).

- Push **SQL** to select Bright, Dimmer or Off.

The Alert Light flashes and the alert tone beeps.  
If you select Off, "**FLASH**" will be displayed to remind you the Alert Light is Off.

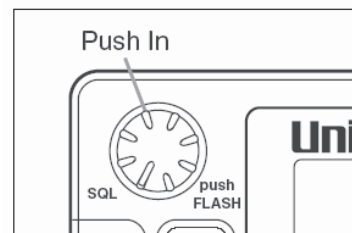





## Private Bank Scanning

### Programming Frequencies into Channels

Before the scanner begins Private Bank scanning, you must program a frequency into at least one channel. **Visit our website ([www.uniden.com.au](http://www.uniden.com.au), [www.uniden.co.nz](http://www.uniden.co.nz)) for information on known frequencies. Frequencies for Australia can be found on the **Australia Scanner Frequencies CD** included with the **UBCT9**.**

You will need to program each frequency into the scanner's channels in order to hear these frequencies.

1. Press **HOLD/RESUME** and enter the channel number where you want to store a frequency by using the keypad, then press **HOLD/RESUME**.



or Change the channel by using the ▲ or ▼ key.



2. Enter the frequency you want to store by using the keypad and  (decimal key).



3. Press **E** to store the frequency into the channel.

4. If you want to program another frequencies into the channel, select another channel by using the or key.



- Note:**
- To clear a mistake while entering the frequency, press  (decimal key) repeatedly until the display is cleared.
  - If you enter a invalid frequency, an error tone will sound and “**Error**” appears on the display. To clear the Error message immediately, press  (decimal key).
  - Even if you don't enter full numbers as a frequency number, the scanner will automatically select the nearest valid frequency.

### Deleting a Stored Frequency

To delete a stored frequency:

- a. Select a channel.
- b. Press **0**.
- c. Then press **E**.

**Note:** Channels with no frequencies are automatically locked out.





## Duplicate Frequency Alert

If you enter a frequency which has been stored in another channel, you will hear an error tone and the other channel displays.

Press  (decimal key) to clear and start again.

— OR —

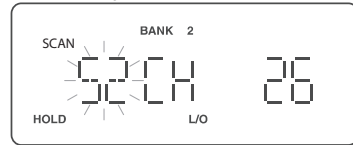

**Note:** Press **E** again to store the frequency in both channels. The smallest channel appears on the display when you store same frequency in two or more channels.

## Memory Lock

To avoid the accidental programming frequencies and talk group IDs, you can lock the memory with Memory Lock.

Press and hold **PROG** for 2 seconds to activate this feature, and “**PROG**” appears on the display. If you press **E** to program memory, you will hear two beeps. To deactivate Memory Lock, press and hold **PROG** for 2 seconds again.

## Scanning Private Bank

1. After programming frequencies, simply press **HOLD/RESUME** to begin scanning. Or pressing **SCAN** repeatedly until “**SCAN**” appears on the display, you can start Private Bank Scanning. The scanner scans only upward all the channels.

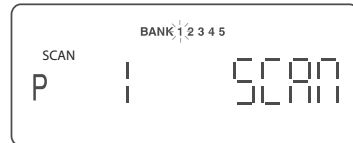

2. The bank indicators selected for scanning appear on the display, and the bank being currently monitored flashes. You can deselect banks from active scanning by entering their numbers on your keypad. The indicator for each deselected bank disappears, and the bank's channels are not scanned.

**Note:** One bank must always be active. You cannot deactivate all five banks at the same time. If you try to deselect all the banks, the first bank is automatically selected. To restore a bank to active scanning, enter the bank's number on your keypad. The bank's indicator will display again.

3. During normal scanning the scanner skips unprogrammed or locked out channels.
4. When a transmission is received, the scanner stops on that channel. When the transmission ends, scanning resumes automatically.

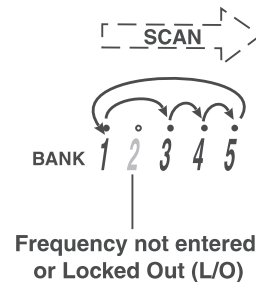

**Note:** You can set the scanner to hold for two seconds on the frequency for a response. For more information on Delay feature, please see page 28.





## Hold/Resume

If you want to stop on a channel during scanning, press **HOLD/RESUME**.

If you want to resume scanning, press **HOLD/RESUME**.

### Direct channel access:

There are several ways to access a specific channel quickly.

1. Press **HOLD/RESUME**.
2. Using the keypad, enter the channel number.
3. Press **HOLD/RESUME** again.

**Note:** You can also use the **SCAN**, **▲** or **▼** key instead of pressing **HOLD/RESUME**.



## Channel Lockout

You can lockout any channel so it is not checked during normal scanning. You can also restore the channel to scanning when you wish.

### Lockout in Hold Mode

1. Press **HOLD/RESUME** and enter the channel number by using the keypad, then press **HOLD/RESUME**.  
— OR —
1. Press **HOLD/RESUME** and select the channel by using the **▲** or **▼** key.
2. Press **L/O** to lockout the channel.  
“**L/O**” appears on the display.



### Lockout in Scanning Mode

If the scanner keeps stopping on a particular channel due to noise or frequent transmissions, you may want to keep that channel from scanning.

1. Wait until the scanner stops on the channel.
2. Then press **L/O**.
3. The scanner immediately resumes scanning because the locked out channel is no longer in the scanning sequence.

**Lockout Tips** Write down your locked-out channels and put in a convenient place in case you need to restore them.

### Restoring a Locked-out Channel in Hold Mode

1. Press **HOLD/RESUME** and select the channel number you want to restore by using the keypad, the **▲** or **▼** key, then press **HOLD/RESUME**.
2. Press **L/O** to unlock the channel. The “**L/O**” disappears.





## Restoring All Locked-out Channels

You can restore all locked-out channels in a bank only when a bank is selected for scan. If you have deselected a bank and you want to restore all of its locked-out channels using the steps below, you must press **SCAN** until “**SCAN**” appears and then enter the number of the bank on your keypad.

1. Press **HOLD/RESUME**.

**Note:** You must be in Hold mode before restoring all locked-out channels.

2. Press and hold **L/O** for about 2 seconds. You will hear two beeps when all the channels have been restored.

## Priority Scan

When Priority Scan is turned ON, your scanner checks the priority channel in the banks you selected every two seconds for activity. If a signal is present on the priority channel, your scanner monitors the channel until the transmission ends, then resumes normal scanning.

You can designate one channel in each bank as a Priority Channel. By default, the first channel in each bank is the Priority Channel, but you can change this.

To activate Priority Scan (in either the Hold or Scan mode):

1. Press **PRI**. “**PRI**” appears.

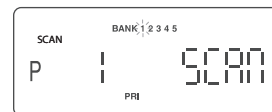

**Note:** If you have locked out the priority channel, error message appears when you select Priority mode.

2. Press **PRI** again to deactivate Priority Scan. “**PRI**” disappears.



## Changing the Priority Channel

You cannot eliminate the Priority Channel, but you can change it to any one of the 50 available channels in each bank.

1. Press **HOLD/RESUME**.
2. Select a new Priority Channel:
  - a. Enter the channel number using the keypad.
  - b. Then press **HOLD/RESUME**.
3. Press and hold **PRI** for 2 seconds to designate this channel as your new Priority Channel. When you hear two beeps, the Priority Channel has been changed. “**P**” appears on the display.



**Note:** Priority in Trunking mode works just the same, except you set them for talkgroup IDs instead of setting priorities for channels. The scanner only checks priority talkgroups between transmission.





## Service Scanning

The service scan feature allows you to rotate through the following six service banks.

- (1) Police\*
- (2) Rail Roads\*
- (3) Aircraft\*\*
- (4) Marine Band
- (5) UHF CB Band
- (6) AM CB BAND\*

\* Preset frequencies valid for Australia Only (not valid for NZ)

\*\* Except Aeronautical Radio Navigation (108-117.9875 MHz)

1. Press **SVC** to select a Service. '**SERVICE**' appears on the display with the current service bank below.



2. Continue pressing **SVC** until your desired Service is displayed. eg: Police (POL), RailRoad (RLR), Aircraft (AIR), Marine (MRN), UHF CB (UCB), AM CB (ACB).



3. After a three second delay scanning begins. If you want to start scanning immediately, press **HOLD/RESUME**.

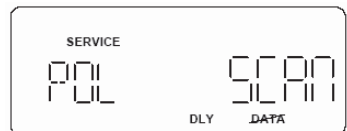

**Notes:**

- Press **HOLD/RESUME** at any time to hold the frequency. Press the **▲** or **▼** key to move up or down the frequency. If you find the frequency you want to store, while in Hold mode you can store the frequency (see page 21).

- If you want to remain on a frequency until a responding transmission is received, press **DELAY** to activate the delay feature (See page 28).
- To skip a frequency, press **L/O**. You can program up to 100 skip frequencies from the service frequencies.





## Band Search

### Setting a Search Band

The UBCT9 can search up to 12 separate frequency ranges to help you discover new stations in your area.

To set a Search Bands, enter into the Band Search mode.

Band No	Range (Mhz)	Mode	Step	Display
1	0025.0000 - 0027.9950	AM	5kHz	25 - 28
2	0028.0000 - 0069.9900	FM	10kHz	28 - 70
3	0070.0000 - 0087.9875	FM	12.5kHz	70 - 88
4	0088.0000 - 0107.9000	WFM	100kHz	88 - 108
5	0108.0000 - 0136.9875	AM	12.5kHz	108 - 137
6	0137.0000 - 0147.9950	FM	5kHz	137 - 148
7	0148.0000 - 0173.9875	FM	12.5kHz	148 - 174
8	0174.0000 - 0224.9500	WFM	50kHz	174 - 225
9	0225.0000 - 0399.9500	AM	50kHz	225 - 400
10	0400.0000 - 0512.0000	FM	6.25kHz	400 - 512
11	0806.0000 - 0956.0000	FM	12.5kHz	806 - 956
12	1240.0000 - 1300.0000	FM	12.5kHz	1240 - 1300

1. Press **SRCH**. The upper and lower limits of the Bands currently selected are on the display.
2. Use the **▲** or **▼** key to select the band you want to search. Wait for about two seconds and the scanner will begin searching that band. Or press **HOLD/RESUME** to begin immediately.



**Notes:** • You must set the Search Bands prior to any searching.

- The scanner automatically increases its search speed up to 300 steps per second for bands having 5 kHz steps. (Turbo Search)
- While searching, you can change the search direction by using the **▲** or **▼** key. Make sure which of icon, “ **▲ SRCH**” or “**SRCH ▼**” appears on the display.





- While Trunking is operating in scan mode, press **SRCH** and it will move to ID Search mode and ID Scan mode.

## Search Hold Feature

1. Press **HOLD/RESUME** at anytime to stop the search. To move up or down 1 frequency step, use the **▲** or **▼** key.
2. Press **HOLD/RESUME** to resume searching.

## Data Skip

A scanner will normally stop on any transmission it receives. This means the UBCT9 will occasionally stop on data signals and unmodulated transmissions. You can automatically skip many of these types of transmissions during search.

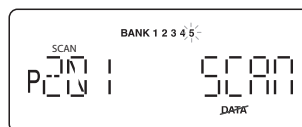

1. To activate the Data Skip feature, press **DATA** in Scan or Search mode. "**DATA**" appears on the display.
2. To deactivate the Data Skip feature, press **DATA** again. "**DATA**" disappears. When Data Skip is active, your scanner may pause momentarily on an unwanted signal but will resume searching in two or three seconds. The Data Skip feature is active as well as Scan mode and Service Search mode. Data Skip does not function during Service Scanning band (for **AM** or **Wide FM Transmission**), Priority Scan, and Trunking mode.

## Frequency Skip

If a particular frequency continues to interrupt search scanning, it is possible to set the scanner to skip the frequency.

To skip over a frequency, press **L/O** when stopping on the frequency you want to skip or when in Search Hold mode.

**Note:** You can program up to 100 skip frequencies.

The 101st skip frequency entered causes the first skipped frequency to unlock.

To restore a Locked out/Skipped frequency.

1. Select the desired frequency by using the **▲** or **▼** key in Search Hold mode.
2. Press **L/O**, and then press **HOLD/RESUME**.

To restore all skipped frequencies, press and hold **L/O** for 2 seconds in Search Hold mode.





## Storing Search Frequencies

You can quickly store any frequency you find during Search.

1. During Search, press **HOLD/RESUME**. If you want to change the frequency, use the **▲** or **▼** key to move up or down 1 frequency step. Then press **E**. Or when the scanner stops on the frequency you want to store, press **E**.
2. Select a bank you want to store by using the keypad. The smallest empty channel number and the frequency alternately appear on the display. If necessary, you can also change the channel by using the keypad, the **▲** or **▼** key.
3. Press **E**.

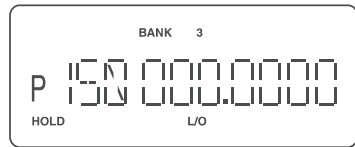

- Note:**
- If the frequency you want to store exists already in a bank, you will hear an error tone and other channel appears on the display. (See “Duplicate Frequency Alert” on page 22.)
  - After storing the frequency, it moves to the Search Hold mode.
  - If there is no free channel, the frequency you want to store will automatically be stored in the first channel in the selected bank.

4. Press to resume searching.

## Delay

To help prevent missing a reply on a specific channel or frequency, you can program a two second delay into any channel, frequency, service band or band search. When scan or search stops on a channel or frequency, there is a two-second pause before the scanning cycle resumes.

To activate the Delay feature (in either Scan mode or Search mode):

1. For State Scan mode or Private Scan mode, when in Hold mode, select the desired frequency or channel and then press **DELAY**. Or when the scanner stops on an active frequency or channel, quickly press **DELAY** before it continues scanning again.

— OR —

1. For Search mode, while searching press **DELAY**.
2. “**DLY**” will appear on the display.







---

## Trunk Tracking

---

---

Your UBCT9 tracks three major types of trunked radio systems. These systems are described here.

- **MOTOROLA** - Including Type I, Type II, Hybrid, SMARTNET, and Privacy Plus. Motorola systems are widely used by public safety and business users. Most are on the 800 MHz band, and recent systems are appearing on other bands. (see page 43).
- **EDACS** - Including "Wideband" 9600 baud and SCAT. "Wideband" systems are mostly on the 800 MHz band, and are used by public safety, utilities, and business users. Some systems are used on the VHF and UHF bands. (see page 39). SCAT systems are single-channel EDACS systems.
- **LTR** - These systems are mostly for business users, and found on the UHF, 800 and 900 MHz bands. (See page 42).

For details on the operation and programming for all of these systems, see pages 29-47.

When tracking these types of systems, remember these important points:

- Your scanner defaults to monitor Motorola Type II 800; however, you can change this if the system in your area is different. (The types of systems are discussed below.)
- Motorola, SMARTNET, and PRIVACY PLUS are trademarks of Motorola Inc. EDACS is a registered trademark of the M/A - COM Inc. LTR is a registered trademark of E.F. Johnson Company.

### Setting the Squelch

For trunked reception, a good setting for the **SQL** control is in the center of the range with the colour marker pointing up. See the illustration.

If it is set too high, it could prevent your scanner from locking to the Control Channel reliably. If it is set too low, it will slightly delay finding the Control Channel. The best setting is the same as for conventional reception, and is critical for monitoring trunked systems.

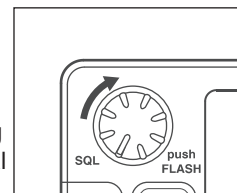



## Programming Trunking Frequencies

There are three steps for programming a trunked system:

1. Program the Trunk Type – What type of system will the scanner be tracking, Motorola Type II, Type I, EDACS, LTR, etc.
2. Program the Trunked Frequencies – Within a trunked system, the frequencies are shared among all the users, called “Talk Groups”.
3. Program the Talk Groups – Within the trunked system, each agency or department is assigned a Talk Group ID. This ID must be programmed into the scanner in order for it to monitor that specific agency or department.

Before you start programming your scanner to track a trunked system, consider the following:

- You can only program one trunking system in each bank of your scanner.
- Trunked frequencies must be entered while in the Trunk Programming mode.
- If you’re in the Trunk Programming mode, you cannot select channels in other banks. For example, if you are programming Bank 4, you can only select channels 151-200 with the ▲ or ▼ key.
- **IMPORTANT:** If you are programming an EDACS® or LTR trunked system, you must enter the frequencies in a specific order. Check the frequency guide included with the radio and the listed web sites for details.

### STEP 1: Selecting Trunking System Type

The first step in a Trunk Tracking system is storing the frequencies in one of the five available banks in your scanner.

1. Press and hold **TRUNK** for 1.5 seconds.  
You will hear two beeps, and “**BANK**” and “**TRUNK**” will begin to flash on the display.
2. Select the bank you want to store the frequency by using the keypad.
3. Select the system you want to track by using the ▲ or ▼ key, then press **E**.



List of trunking systems as follows:

- E2-800 (Motorola Type II 800 MHz)
- E2-Hi (Motorola Type II VHF 137-173.9875 MHz) \*
- E2-UHF (Motorola Type II UHF 406-512 MHz) \*
- E1 (Motorola Type I and Hybrid) \*\*
- Ed (EDACS® Wide Band: 9600 baud)\*\*\*
- Ed Sct (EDACS Scat)
- Lt (LTR)\*\*

\* Requires programming of a Base and Spacing frequency Offset channel (See page 45).



\*\* Requires programming of a Fleet map (See page 44).





\*\*\* Requires programming of frequencies in exact order and location.

## STEP 2: Programming Trunking Frequencies

1. Select **Prgr F** and press **E**. Use the numeric keypad and  (decimal key) to enter a frequency for the trunked system.  
For example, enter 85  125.



**Note:** To clear a mistake while entering a frequency, press  (decimal key) twice, and start over.



2. Then press **E**.

The “**E**” (EDACS), “**M**” (Motorola) or “**L**” (LTR) appears depending on the trunked system selected.

If the frequency is out of the range of the system chosen in this step, you will hear an error tone, the channel number flashes and an error message appears on the display.

3. Use the  or  key to select the next channel in the bank and press **E**.
4. Repeat steps 2 and 3 until all frequencies have been entered.

5. Press **SRCH** to begin searching the bank you've programmed.  
Then select the programmed bank by using the keypad.

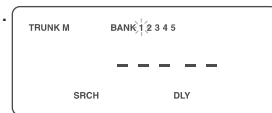

 **Remember!** To lockout the keypad to prevent re-programming of talkgroups, you can use Memory Lock (Refer to “Memory Lock” on page 22).

**Hint:** If you want to return to the previous menu screen, press **HOLD/RESUME** in the Trunk Programming mode.

## Programming Talk Group ID/Scan Lists

Each bank of your UBCT9 can be a trunk tracking bank and it can be a conventional scanning bank. When you designate a bank as a trunking bank, your scanner sets up 5 Scan Lists, which are simply lists used to store your favourite Talk Group IDs. Each list can contain up to 10 IDs, so you can store a total of 50 IDs for each trunk tracking bank. (250 IDs if you use all the banks as trunking banks!)

Scan Lists help you organize the trunking system users into categories. For example, you might use List#1 for police IDs, List#2 for fire department IDs, List#3 for emergency medical service IDs, etc. Once IDs are stored in lists, you can scan them as you scan conventional frequencies and you can lockout any one (up to 4) of the 5 Scan Lists by pressing the corresponding numeric key. When an ID is active, the Scan List number will appear on the display. You can program your Scan Lists either manually or during Trunking Search mode.





In order to program Talk Group ID's, you must first complete Step1—"Selecting Trunking System Type", page 30 and Step 2 – "Programming Trunking Frequencies", page 31.

1. After programming a frequency, press **HOLD/RESUME** to return to the main screen of system type selected and select **PrOg Id**. Then press **E**.
2. Select the Scan List location by using the **▲** or **▼** key.
3. Enter the Talk Group IDs for each trunk system as follows.

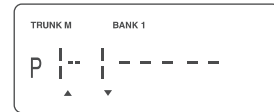

**To enter a Type 2 Talk Group ID:**

1. Enter the ID you want to store by using the keypad.
2. Press **E**.

**To enter a Type 1 ID:**

For a Type I ID, the Block number, Fleet number and Subfleet number make up the Talk Group ID number. For detail please see page 59.

1. Enter the ID you want to store by using the keypad (ID = Block number + Fleet number + **⊙** (decimal key) + Subfleet number).
2. Press **E**.

**To enter a Full EDACS ID ®:**

1. Enter the Agency number.
2. Press **⊙** (decimal key) for the "dash".
3. Enter the Fleet number and Subfleet number.
4. Press **E**.

**To enter a Partial EDACS® ID:**

1. Enter the Agency number you want to store.  
Use the **⊙** (decimal key) for the "dash".
2. Press **E**.

Or you can program all the Talk Group numbers within one fleet of an Agency.

1. Enter the Agency number.
2. Press **⊙** (decimal key) for the "dash".
3. Enter the Fleet number.
4. Press **E**.

**Hint:** Remember that Uniden's AFS format allows you to enter full or partial EDACS IDs for powerful flexibility in all modes. Be sure to read the section "EDACS Reception" on page 39 to learn how this works.

**Note:** The UBCT9 default to "AFS" talkgroup displays for EDACS ® only.

**To enter a LTR ID:**

For a LTR ID, the Area Code, Home Repeater number and ID make up the Talk Group ID.





Please see page 42 for more information.

1. Enter the Area Code.
2. Enter the Home Repeater number.
3. Enter the ID you want to store.
4. Press **E**.

**Note:** To clear a stored ID while entering an ID, press 0 and E successively, and start over.

## Receiving Trunked Systems

When you have properly programmed all the frequencies for a trunked system, you can monitor the system in several different ways. You will find that Search, Hold, Lockout, Scan and Delay are all similar to conventional scanning.

- **ID SCAN** lets you receive those talkgroups that you store in Scan Lists.
- **ID SCAN HOLD** lets you selectively listen to a talkgroup in your Scan Lists.
- **ID SEARCH** lets you hear all system talkgroup activity. This is the best way to get started.
- **ID SEARCH HOLD** works with Search mode to let you quickly freeze reception on an interesting transmission. Or you can manually specify a talkgroup with **DIRECT ENTRY** in **ID HOLD**.
- **ID LOCKOUT** works with Search and Scan to exclude talkgroups that you don't want to hear.
- **ID DELAY** works with each talkgroup to be delayed when the communication ends. When receiving EDACS systems, remember that Uniden's AFS talkgroups give you powerful flexibility. In a few key presses, you can specify a single talkgroup, a fleet, or an entire agency in all the above modes. Read the section "EDACS Reception" to understand how this works.

**Hint:** If the scanner is not in the Trunking mode, you can enter the Trunk mode by pressing **TRUNK**. Pressing **TRUNK** in the Trunking mode will move to the Private Scan Hold mode.

## ID Scan Mode

1. When in the Trunking mode, press **SCAN** to begin scanning the lists you have programmed.

If you haven't programmed any IDs, the scanner cannot stop on an active conversation.

2. To remove a Scan List from active scanning, press the number of the Scan List on your keypad.

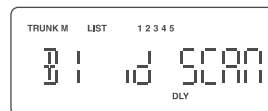

The Scan List indicator turns Off, and the IDs in that list are not scanned.





**Note:** One Scan List must always be active. If you try and deactivate all the Scan Lists, Scan List 1 will automatically be active.

3. To restore a Scan List to active scanning, press its number again.

☞ Remember! When you press TRUNK in the Trunking mode, you can be out of the Trunking mode and enter into Private Scan Hold mode.

**Note:**  SCRN appears on the display during Trunk Scan instead of simply SCRN.

## ID Scan Hold Feature

If you want to stop on a ID during ID scanning, press **HOLD/RESUME**.

**To directly access a specific ID location:**

There are several ways to access a specific ID quickly.

1. Press **HOLD/RESUME** to enter into Hold mode.
2. Using the keypad, ▲ or ▼ key, enter the ID location number (See page 31).
3. Press **HOLD/RESUME**.

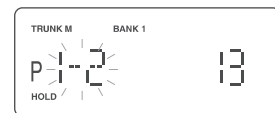

If you want to resume scanning, press **HOLD/RESUME**.

## ID Search Mode

Once you have programmed all the frequencies for a trunked system, Search will let you immediately start hearing transmissions.

When in the Trunking mode, press **SRCH** and the scanner begins to find any active IDs. When the scanner finds any ID, you will hear it.

Talkgroups display differently in Motorola, EDACS and LTR systems. You should read the appropriate parts of this guide to understand the formats.

The display indicates the bank and the type of trunked system you are monitoring. While monitoring on ID, press the ▲ key, and the scanner will check if any other IDs are active.

Regardless of the system, you won't know exactly who you are receiving until you listen for a while. Of course, figuring out who each ID represents is half the fun of Trunk Tracking.

Later, when you learn more about a system, you will want to store lists of talkgroups. Then you can scan specific agencies and users, and use the many other features your radio provides.





## ID Monitor Mode

By using ID Monitor mode, you can determine which talk groups are the most active without hearing conversations.

1. Press and hold **SRCH** for 2 seconds until you hear two beeps. Then **SRCH** begins flashing and all active talk group IDs appear on the display every 0.5 seconds.
2. To activate ID search mode, press **SRCH**.

**Note:** Lockout ID also appears on the display.

## ID Search Hold and Direct Entry ID in Hold Mode

Just like in Conventional Search, Hold lets you pause ID Search on an interesting transmission without storing the talkgroup into memory.

If you hear an interesting ID during Search mode, and want to continue listening to it --

- Press **HOLD/RESUME** to stop the search.



If you want to listen to a specific ID while in Hold mode --

- Use the keypad to enter the ID you want and press the **▼** key.

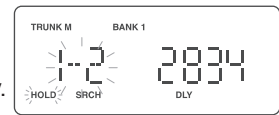

If you want to resume searching --

- Press **HOLD/RESUME** to return to Search mode.

**Note:** ID Hold feature is also applied to ID Scan mode.

## Programming Scan Lists During Search

To select a Scan List location and store an ID during Search mode, follow these steps:

1. When your scanner stops on an ID you want to store, press **E**.
2. You can change the Scan List memory location by using the **▲** or **▼** key. And then press **E**.
3. Press **SRCH** to return to Trunk Tracking Search mode.

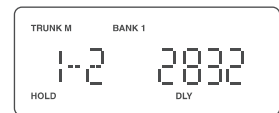
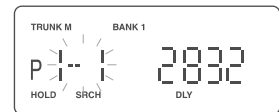

## Deleting a Stored ID

To delete a stored ID:

1. Press **HOLD/RESUME** in the ID Scan mode.
2. Select the Scan List location you want to delete by using the **▲** or **▼** key.
3. Press **0**.
4. Then press **E**.





## ID Lockout

Like conventional scanning, it's possible to lockout unwanted traffic. This is particularly important in trunked systems because in many areas, water meters, door alarms, traffic signals, and other mechanical devices are assigned IDs just like other users. Also some departments scramble or encrust their communications, and you may want to lock out these unintelligible broadcasts.

To Lockout an ID, press **L/O** on the ID you want to lockout.

The ID is locked out. You can Lockout up to 100 IDs. An Error message ("Full") is displayed when you try to register the 101st lockout. If you Lockout an ID in Search mode, it is also locked out in Scan List mode.

**Note:** Conversely, if you Lockout an ID while in Scan List mode, it is locked out in Search mode. For information about Scan Lists see page 31.

**EDACS BLOCKOUT** is a powerful form of ID Lockout that can be used only with AFS and EDACS systems. This feature lets you lockout entire Agencies or Fleets, not just individual talkgroups. Using EDACS Blockout you can, for example, prevent Search from stopping on any of hundreds of talkgroups in the Utilities agency. You can do this with just a few key presses. To use this mode just enter the Agency-part, or the Agency-Fleet part of the talkgroup code and press **L/O**. For example, to Blockout Agency 4 in Trunk Search, press **HOLD/RESUME, 0, 4, .** (decimal key), and then **L/O**. For other ways to use partial AFS entry, be sure to read the section "EDACS Reception".

## Review ID Lockout

You can check all IDs already locked out.

1. Press and hold **TRUNK** for 1.5 seconds in the Trunking mode.
2. Select the bank you want to review by using the keypad, and then the trunked system selected appears on the display. Then press **E**.
3. Select **Lockout** by using the **▲** or **▼** key, and then press **E**.
4. You can see the locked out IDs by using the **▲** or **▼** key.

**Hint:** Press and hold **L/O** for 2 seconds to check all locked out IDs when in the Trunking mode.

## Restoring Locked-out IDs

**To restore a single ID, follow these steps:**

- While in locked out review mode, select the locked out ID you want to restore and press **L/O**. The ID is restored and "L/O" disappears.

**To restore all locked out IDs in a bank once:**

- While in locked out review mode, press and hold **L/O** for 3 seconds. All locked out IDs in a bank are restored.







## Setting the Delay Mode for Trunking Mode

A default delay of 2 seconds is automatically set for each talkgroup for ID Scan mode and ID Search mode. To set the delay feature on or off, press **DELAY** while trunking, “**DLY**” will appear or disappear depending on your setting.

## Trunking Frequency Confirmation

You can check the frequency while a talkgroup ID is active. Press **▼** the key, and the active frequency on which the talk group is transmitting will flash on the display. Or press and hold the **▼** key for 2 seconds, the ID and the frequency alternately appears on the display. To cancel this mode, press the **▼** key again.

**Hint:** This feature is applied to ID Scan mode and ID Search mode.

## Setting Priority in Trunking Mode

You can set priority in your Scan lists, just as you do in your conventional ones. Default setting for the Priority ID is the first location in each Scan List. You can set the priority by pressing and holding **PRI** for 2 seconds in ID Scan Hold mode. After you've set up your Scan List, press **PRI** to activate it.

It's very similar to conventional priority although there is no “interrupt” during the transmissions. Priorities are checked in between transmissions.

With Priority ON, you can hold on an ID in your Scan List, such as Scan List 3, memory location 7, and the scanner will check all the priorities in all the active Scan Lists between any transmissions on the ID on which you're holding. The lowest numbered priority will be checked first. For example, the Priority ID in List 1 will be checked before the Priority in List 2, etc.

**Note:**

- This function does not work in LTR tracking.
- Priority Scan does not operate when Priority IDs are locked out.

## Moving between Scan List Memories

There are a number of ways to step and move through your Scan List memories:

1. Press **HOLD/RESUME** in the ID Scan mode and use the **▲** or **▼** key to move to up or down.
2. Or, press **HOLD/RESUME** in the ID Scan mode, next press **0-9** (scan list number), then press **0-9** (memory position). For example to move to Scan List 4, memory position 10, press: **HOLD/RESUME, 4, 0, HOLD/RESUME.**





## Multi-Track

The UBCT9 allows you to track more than one system at a time. Here are some highlights of this feature:

- You can actually track up to 5 trunking systems at one time.
- You can trunk scan, or search and scan conventional frequencies at the same time.
- You can program conventional frequencies in the same bank as trunking systems. After the scanner finishes checking a trunked system for activity, it will conventionally scan the other frequencies in the bank (remember, only trunking frequencies are programmed in Trunk mode).

To scan a mix of trunking and conventional banks, select the banks you wish to be active, and then press **TRUNK**. The scanner will instantly begin scanning. You can switch to Search mode and the scanner will search for any active ID's on the system.

**Note:** To switch ID Scan or ID Search, press **SCAN** or **SRCH** in the trunked system.

### *Multi-Track Operational Details*

When more than one trunk system is active (for example two or more trunked systems or a trunked system and one or more conventional frequencies), the radio jumps between systems/frequencies as follows:

**TRUNK SCAN:** The scanner moves to a trunked system and looks for IDs in your Scan List(s) for up to 1 second. If it finds no activity on your programmed talkgroups, it moves on to conventional channels in the same bank or to the next active bank.

If the scanner finds a talkgroup in one of your active Scan Lists, you will begin to hear that communication and the scanner will of course display the proper talkgroup number. When the communication ends, the scanner will wait for 2 seconds for any further replies and, if none, the scanner will move to the conventional channels in the same bank or to the next bank.

The scanner will not look for any other IDs within the same trunked system (as this would slow the scan process). If you press the ▲ key while you are listening to one ID, the scanner will check to see if another ID in your Scan List is active. It will disregard the ID to which you were just monitoring.

**TRUNK SEARCH:** This mode works similarly to Trunk Scan. If the scanner finds any (nonlocked- out) ID when it checks the control channel, you will hear it. You will then hear any replies that follow within 2 seconds. After that the scanner will move on and not continuously search the system for additional IDs (on busy systems you would never leave the system if this were the case). If you press the ▲ key while monitoring one ID, the radio will check if any other IDs are active (it will disregard the ID you just left), and if none are active, it will move on.



# EDACS® Reception

## EDACS Tracking ®

TrunkTracker III now allows tracking of EDACS® trunked systems. Until now these widely used systems have been almost impossible to monitor with a conventional scanner. With your TrunkTracker III listening to EDACS(s) is remarkably easy, and perhaps even easier than conventional scanning.

EDACS systems use 'Transmission Trunking', which means that each transmission is assigned a new frequency. As the conversation moves through the system's frequencies, your TrunkTracker III automatically follows it.

This chart shows a 30 second sample of EDACS transmissions. Eight different talkgroups are using the system as their transmissions switch between the thirteen system frequencies. Notice how the dotted line shows talkgroup 02-023 moving from channel to channel. Your UBCT9 can clearly and automatically follow this talkgroup, or any other, as you select.

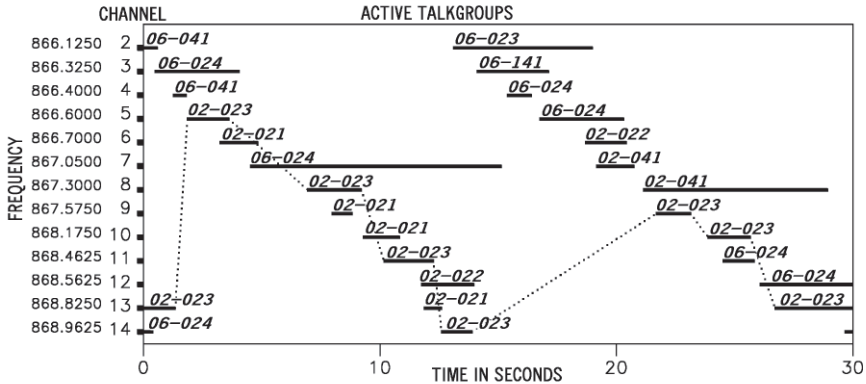

EDACS systems are organized in a logical way that keeps related talkgroups together. Your scanner is designed to take maximum advantage of this organization to make your scanning easy. It lets you zero in on just the part of the system you want to hear, whether it is an individual channel, an entire department or city.

## Programming EDACS System Frequencies

When you program EDACS frequencies, it is critical that you store each one in the CORRECT LOCATION. By the nature of EDACS systems this is necessary for tracking. This often is not the frequency order, so you must be sure you have the right sequence.





## An EDACS® Trunked system



This chart shows how talkgroups are organized within an EDACS system at the Agency level. The individual talkgroups cannot be shown at this scale because there are over 2000. However the chart can show the 16 Agencies in this example. The system is logical and easy to understand. EDACS systems are typically arranged in an outline structure.

The system users are given blocks of talkgroups. Sizes vary but most large cities and other agencies have blocks of 128 channels. Smaller cities have only 64 or 32 channels. In this example, the County Sheriff is agency 01. The city of Sullivan is Agency 03. Adams Hill and Matthew Junction share Agency 08.

Your scanner shows EDACS talkgroups in AFS (Agency-Fleet-Subfleet) format. This helps you see, at a glance, who you are monitoring. And with the partial-entry feature you can easily include nearby, related channels in the same Fleet or Agency. You can just as easily exclude entire unwanted Fleets and Agencies.

When in Search mode, with the system frequencies programmed, and your scanner locked to the control channel, you can select a desired city by keying in the Agency part of the AFS talkgroup. For example, in Hold mode you can select the entire city of Sullivan with 4 key presses (**0, 3**, ) (decimal key) and the **SRCH** key).

When you hear an interesting talkgroup in Hold mode capture it to your Scan List by pressing **E** during the transmission. Or hold on it by pressing **HOLD/RESUME**.

If you want to monitor the Sullivan Police Dispatch channel (which is talk group 03-062), press **0, 3**, ) (decimal key), **0, 6, 2** and the  key. Your scanner can also work in decimal format.

Talkgroup 03-62 in decimal format is 402. But decimal format does not give you any information about the system hierarchy.

For example Sullivan, in decimal, uses channels from 384 to 511. This is not as easy to remember as Agency 03. But decimal is useful if you need to work from decimal talkgroup lists.

AFS	AGENCY	DECIMAL
		000
00		100
01	COUNTY SHERIFF	200
	HOSPITALS	
02	COUNTY FIRE	300
	AMBULANCE	
03	SULLIVAN	400
		500
04	SWANSON	600
	BIRMINGHAM	
05	MILLIKEN	700
	RANDORA POND	
	TROUBLE CREEK	
06		800
	COLUMBIA	900
07		1000
	ADAMS HILL	
08	MATTHEW JCT	1100
09	CLIFFORD	1200
10	COUNTY GOVT	1300
		1400
11	BEACONSFIELD	1500
	NEW ELFERS	
12	BRENNAN	1600
	EXMORE	
	OAK VALLEY	
13	MIRANDA CANYON	1700
		1800
14		1900
15		2000





## Special EDACS ® Features

### AFS Partial Entry Feature

AFS is Uniden's method of encoding EDACS talkgroups.

AFS stands for 'Agency-Fleet-Subfleet'.

AFS talkgroups are used in all EDACS reception -- in ID Search, ID Lockout and ID Scan.

The powerful AFS Partial Entry feature designed into the UBCT9 lets you use either a complete talkgroup code, or just the most significant part.

This feature lets you expand or narrow searching and scanning to one of 4 levels. By entering only the desired part of an AFS talkgroup, you can select 128 talkgroups, 8 talkgroups, or a single talkgroup. For example, you could program every talkgroup in a police department with just 4 key presses. You can use the AFS Partial Entry feature anywhere you need to specify EDACS talkgroup.

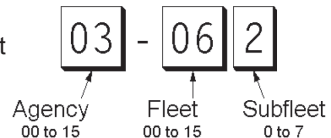

Your UBCT9 can also enter or display EDACS talkgroups in decimal format (0-2047).

1. Press and hold TRUNK for 1.5 seconds and select the bank you want to change.
2. Use the ▲ or ▼ key to select , then press **E**.
3. Use the ▲ or ▼ key to select , then press **E**.
4. Use the ▲ or ▼ key to select or , then press **E**.

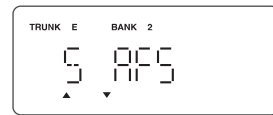

You can use this feature to translate decimal talkgroups lists to the much more powerful AFS format.

Examples of how you might use AFS are shown above in the description of an EDACS trunked system, and elsewhere in this manual. It is very easy to use. Be sure to become familiar with AFS Partial Entry, and your scanning will become far more flexible and efficient.

### EDACS ID Range Search

When the scanner searches EDACS talk group IDs, the scanner can search within a range you set for Agency or Fleet listings. For example if you want to search within the 01 agency, while in Hold mode press **0, 1, (decimal key)** then **SRCH**. Or if you want to search within the 01 agency and 01 fleet, while trunking press **0, 1, (decimal key), 0, 1,** then **SRCH**. To stop the ID range search, press **SRCH**.

### EDACS SCAT

With the EDACS SCAT feature, the data stream transmissions will be eliminated allowing you to clearly monitor the voice communications on EDACS SCAT systems.

To monitor EDACS SCAT systems you only need to program the frequency in the Trunk Tracking Programming mode. You do not need to enter group ID's.

**Note:** As EDACS SCAT is different from the other tracking feature, and it is not a feature which the scanner tracks any ID, you do not need to program Talk Group ID's.





---

## LTR ® Reception

---

---

### LTR ® Tracking

LTR ® (Logic Trunked Radio) systems are trunking systems used primarily by business or private communications service providers, such as taxicabs, delivery trucks, and repair services. These systems encode all trunking information as digital subaudible data that accompanies each transmission. Users on an LTR system are assigned to specific talkgroups, which are identified by the radio as six digit numbers.

These numbers are in the form AHUUUU, where:

A= Area code (0 or 1)

H= Home repeater (01 through 20)

U= User ID (000 through 254)

When the scanner receives a transmission on a channel set to the LTR mode, it first decodes the LTR data included with the transmission. In the ID Search mode, the scanner stops on the transmission and displays the talkgroup ID on the display. In the ID Scan mode, the scanner only stops on the transmission if the LTR data matches a talkgroup ID that you have stored in the bank's talkgroup ID list and have not locked out.

LTR systems are frequently programmed so that each radio has a unique ID code.



---

## Motorola Reception

---

### Motorola Tracking

There are really two types of Motorola trunking systems. These are usually referred to as Type I and Type II systems. Type I only occurs on some 800 MHz systems. All VHF and UHF trunking systems use Type II.

One important distinction between these two systems is the amount of data transmitted by each radio when its push-to-talk button (**PTT**) is pressed. Every radio in a trunked system is assigned a unique ID so the central site computer can identify it when it's used. Both Type I and Type II systems place radios (or radio users) into groups, called talkgroups, and these talkgroups are also assigned unique IDs. Some radios have access to only one talkgroup, while others have access to many talkgroups. The talkgroup(s) each radio can access is called the radio's affiliation(s).

In a Type II system, when someone uses their radio, only the radio ID is transmitted when **PTT** is pressed, whereas in a Type I system the radio ID and its current affiliation are both transmitted when **PTT** is pressed.

Why the difference? Type II systems are slightly more advanced because the central computer maintains a database which is used to determine each radio's affiliation(s). Changes to a Type II system are easier than Type I because the system manager only needs to update the database instead of reprogramming individual radios.

Another difference between the systems is that Type I systems are arranged in a Fleet-Subfleet hierarchy. For example, its possible for a city using a Type I system to designate 4 Fleets, each with 8 Subfleets. Their fleets might be the Police Department, the Fire Department, Utilities, and Administration. The Police may decide to further divide their fleet into subfleets such as Dispatch, Tactical Operations, Detectives, North, South, East and West Side Patrols, and Supervisors. All the available police radios would then be assigned to one of the police subfleets. Determining the exact Fleet-Subfleet hierarchy for a particular area is referred to as Fleet Map Programming, which is discussed further in this manual.

The disadvantage of a Type I system is that when **PTT** is pressed, the brief burst of data must contain the radio's ID and its Fleet and Subfleet. This is three times the amount of data a Type II system radio sends, and as a result Type I systems usually accommodate fewer users than Type II systems.

Even though there are many Type II systems, Type I systems are still in use. There are also Hybrid systems which are a combination of both Type I and Type II. Your scanner defaults to monitor Type II systems, but it's possible to select a Preprogrammed Fleet Map or create a Custom Fleet Map for your area.

For VHF and UHF Type II trunking systems, you will need to know the base, spacing frequencies and offset channels. See page 45 for details.





## Fleet Map Programming

If you have programmed a trunk tracking bank for Motorola, press **TRUNK** to start Multi-Track, and you will see user IDs on the display. Since the UBCT9 defaults to Type II systems, all the IDs will appear as numbers. However, if you notice a mix of odd and even user IDs, for example 6477, 2560, 6481, 6144, 1167, etc., then you are probably monitoring either a Type I or Hybrid systems.

You may also notice that you are missing responses when you hold on an active ID. Unlike Type II, Type I/Hybrid systems require a Fleet Map that sets specific Fleet-Subfleet parameters. It is easy to select a Fleet Map for your scanner; what is not always easy is selecting or programming a map that matches your particular area.

There are 16 preset Fleet Maps listed in the Appendix that you can choose, and these are usually a good place to start when setting up a Type I/Hybrid trunk tracking bank. If you choose a preset map and still have difficulty following complete conversations, then you'll have to program your own Fleet Map.

### Selecting Preset Fleet Map

1. Press and hold **TRUNK** for 1.5 seconds and select the bank you want to change.
2. Use the **▲** or **▼** key to select **E 1** (Type 1 system), then press **E**.
3. Use the **▲** or **▼** key to select **FLEET**, then press **E**.
4. Use the **▲** or **▼** key to select the map you want, then press **E**.

The scanner returns to FLEET Map list item.

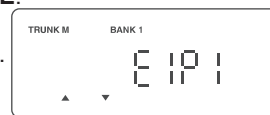

**Note:** You will now begin to see Type I Fleet-Subfleet IDs. For example, 100-12, 100-9, 000-12, 400-8, etc. See "User Defined Fleet Maps in the Appendix" for more information about Type I IDs.

How do you know if the preset map is correct? You will have to listen to see if you're following complete conversations. If not, you should try another preset map.

### Programming a User Fleet Map

You may want to read "User Defined Fleet Maps" in the Appendix before programming a Fleet Map. It contains a detailed explanation of Scanner Fleet Map Programming, as well as a table listing the Fleet Map Size Codes.

1. Press and hold **TRUNK** for 1.5 seconds and select the bank you want to change.
2. Use the **▲** or **▼** key to select **E 1** (Type 1 system), then press **E**.
3. Use the **▲** or **▼** key to select **FLEET**, then press **E**.
4. Use the **▲** or **▼** key to select **usr**, then press **E**.
5. Use the **▲** or **▼** key to select the size code for the first block, then press **E**.







The next available block appears on the display.

- Repeat step 5 until you have selected a size code for each block.

For details about each size code, see “Fleet Map Size Codes” in the Appendix.



## Programming a Hybrid System

A Hybrid system is simply a Type I system with some blocks designated as Type II blocks. To program a Hybrid system, follow the steps listed in “Programming a User Fleet Map” in the previous section. However, if you want a block to be Type II, select Size Code 5-0. When you begin searching a trunking bank with a Hybrid Fleet Map, you will see both types of system IDs. That is, Type II IDs usually appear as an even number without a dash; Type I IDs appear as a three or four digit number, followed by a hyphen and a one or two digit number.

## Setting the Base, Spacing Frequencies and Offset Channel for Motorola VHF/UHF Trunked Systems

To properly track Motorola VHF and UHF trunked systems, you must enter what is known as the Base, Spacing Frequencies and Offset Channels for each system.

To find these out, check [www.trunktracker.com](http://www.trunktracker.com) and other web sites and frequency resources.

To enter the Base, Spacing Frequencies and Offset Channel: (You can set up to three sets of these, but almost all systems only use one set).

- Press and hold **TRUNK** for 1.5 seconds and select the bank you want to change.
- Use the **▲** or **▼** key to select **E2-H** (Motorola Type2 VHF) or **E2-UHF** (Motorola Type2 UHF), then press **E**.
- Use the **▲** or **▼** key to select **BASE** then press **E**.
- Use the keypad to enter Configuration Block Number(1-3).
- Use the keypad to enter a new Base Frequency, then press **E**.
- Press **▲** the key and select **SPC** for entering the Spacing Frequency.
- Use the keypad to enter a new Spacing Frequency, then press **E**.

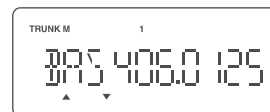

**Note:** You can only enter within a range of 5-100 kHz, and 5 or 12.5 kHz multiples.

- Press **▲** the key and select **OFFS** for entering the Offset Channel.

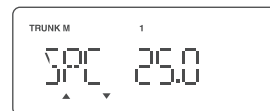



9. Use the keypad to enter a new Offset Channel, then press E.

- Note:**
- You can only input within a range of 380-759.
  - If the system is not tracking properly, you may need to try a new Base Frequency or Offset Channel, or you may be missing frequencies from the system.
  - You can set up to three Base, Spacing and Offsets for Motorola VHF/UHF trunked systems.



## Toggling the Status Bit

On Type II trunking systems there is a method by which specialized types of communications utilize unique talkgroup numbers. An emergency call will occur on a unique talkgroup from its primary assignment, for example. Because the UBCT9 defaults to Status-Bit ON mode, you never need to worry about missing these transmissions. If you have programmed talkgroup 33264 into Scan List memory, for example, and there is an emergency call within the group, you will hear it on 33264.

The only time you may wish to turn Status Bits OFF is if you're trying to figure out the proper Fleet Map of a Type I trunking system.

1. Press and hold **TRUNK** for 1.5 seconds and select the bank you want to change.
2. Use the ▲ or ▼ key to select **E2-800** (Motorola TYPE2 800MHz) , **E2-H** (Motorola Type2 VHF) or **E2-UHF** (Motorola Type2 UHF), then press **E**.
3. Use the ▲ or ▼ key to select **S-b t**, then press **E**.
4. Use the ▲ or ▼ key to select **Sbt ON** or **Sbt OFF**, then press **E**. The scanner returns to Status Bit list item.

## Control Channel Only Mode

When this function is activated, trunking is performed using Control Channel data only. Voice channel (also known as "DATA channel") frequencies do not have to be programmed into memory. This feature only applies to Motorola 800 MHz systems.

1. Press and hold **TRUNK** for 1.5 seconds and select the bank you want to change.
2. Use the ▲ or ▼ key to select **E2-800** (Motorola Type2 800MHz) or **E1** (Motorola Type1 800 MHz), then press **E**.
3. Use the ▲ or ▼ key to select **CC ONLY**, then press **E**.
4. Use the ▲ or ▼ key to select a plan from 2 frequency plans, then press **E**. The scanner returns to Control Channel Only list item.



- Note:** You must choose a plan before you begin to Control Channel Trunk (Only when 800 MHz system is selected).  
When you deselect Control Channel only mode, **CC OFF** appears on the display.





Read the descriptions of the Plan 1~2 for details on which may apply for you.

**PL1(plan1):** If the last three digits of ALL the frequencies in use end in one of the following three digits (125, 375, 625, or 875), use PL1(plan1).

**PL2 (plan 2):** If the last three digits of ALL the frequencies in use end in one of the following three digits (000, 250, 500, or 750) use Plan 2.

Of course, you will know the Control Channel frequency itself so that will help you determine the proper plan. If you try one plan and you receive errors (such as the scanner jumping to channels that are obviously not part of the system), you should try an alternate Plan.

- Note:**
- You can assign a Fleet Map to TYPE 1 or Hybrid systems scanned in Control Channel Only mode by going into the Trunk Programming mode. You can also program IDs, set a delay, and all the other parameters for systems scanned in this mode. You can then either search the system to find new IDs or you can program IDs into memory and then scan them.
  - The Control Channel Only feature is an extremely powerful tool. You can use it to determine if systems you are familiar with may have added new frequencies or you can use it to discover new systems by simply finding active control channels (using Search) and then programming them for Control Channel operation only. Remember that this feature only applies to Motorola 800 systems, that you do have to set the proper system type (800 MHz of Type 1 or Type 2) and you do have to program the Control Channel frequency into memory and identify the frequency as trunked in the Trunk Programming mode.

### Disconnect Tone Detect Option (End Code)

When this function is disabled, the radio looks for squelch before returning to the Control Channel instead of waiting for the Disconnect Tone. Only in rare instances will you need to adjust the default settings. The condition to return to Control Channels depends on whether the signal is present or not.

1. Press and hold **TRUNK** for 1.5 seconds and select the bank you want to change.
2. Use the **▲** or **▼** key to select **E2-800** (Motorola TYPE2 800MHz), **E2-V** (Motorola Type2 VHF) or **E2-UHF** (Motorola Type2 UHF), then press **E**.
3. Use the **▲** or **▼** key to select **Eot**, then press **E**.
4. Use the **▲** or **▼** key to select **Eot ON** or **Eot OFF**, then press **E**.

**Note:** Set the SQL control so that you hear a hissing, and the scanner will remain on the voice channel (even when a disconnect tone is transmitted or there is no signal at all).





---

## Remote Interface

---

You can communicate and program your UBCT9 in numerous ways with peripheral devices using a Remote Interface Cable port. This radio offers the following modes:

- **PC Control mode**  
Program and control your scanner from a PC using Uniden's UBCT9 Scanner Software.
- **Clone mode**  
Clone all the frequencies, trunking talkgroups, and fleet maps programmed into your scanner to another UBCT9 scanner.

### PC Control Mode

**To connect Scanner to PC:**

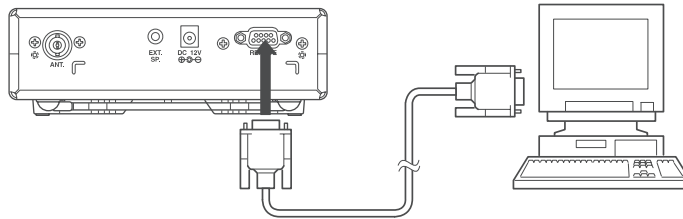

Plug the scanner end of the RS232C straight cable into the remote port which is on the rear of the scanner. Plug the other end of the cable (DB-9 serial connector) into a personal computer's serial port. A few PC's may require an adapter, most will not. Of course, make sure your PC is turned ON.

### To program your scanner:

You can program and control your scanner remotely from a PC using Uniden's UBCT9 Scanner software.

After connecting the scanner to a PC, turn the scanner ON.

To use the Remote (PC Control) mode, you must install Uniden's UBCT9 Scanner software and use as directed. Make sure that your scanner is connected to the serial port of the PC using the RS232C straight cable.





### Start Remote Mode and Change Transfer Speed:

1. Press and hold **RMT** for 2 seconds to activate the Remote mode.
2. Select the transfer speed except for **OFF**, then press **E** and the scanner will start Remote mode.



A unique feature of the UBCT9 is that all the front panel keys on the radio remain operational in Remote mode.

### PC Control Parameter

#### For your information:

- Transfer speed : 9600/19200/38400/57600 bps (adjustable)
- Start/Stop bit : 1 bit, 1 bit
- Data Length : 8 bit
- Parity Check : None
- Code : ASCII code
- Flow Control : None
- Return Code : Carriage Return only

### Clone Mode

You will need to purchase a RS232C straight cable and a null modem adapter. RS232C straight cables are available as male to male or male to female. Even if the RS232C straight cable you buy already has the male to male connectors, you will still have to have the null modem adapter. On the next page you will see the pin connections that are internal to a standard device. (These items are available at your local electronics stores.)



**To connect the Scanner to Scanner:**

Plug the male end of the RS232C straight interface cable into the remote port on the rear of one of the two scanners. Then connect the DB-9 to DB-9 null modem adapter to the cable. Plug the other end of the null modem adapter into the other scanner (DB9 Gender Changers are also available at your local electronics store.).

Null Modem Adapter  
Pin connections

Female DB9	Male DB9
1	4
2	3
3	2
4	6 & 1
5	5
6	4
7	8
8	7
9	Not used

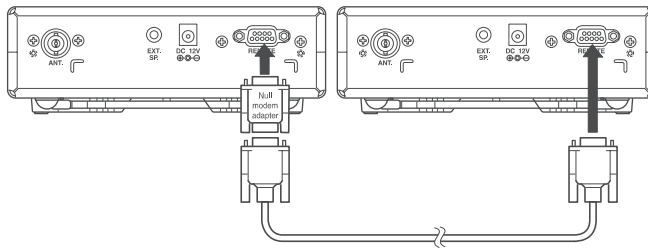

You can clone all of the programming of one UBCT9 into another, including frequencies, talkgroup IDs, delay settings, etc. After connecting the two scanners, turn the radios ON. Prepare each scanner for clone mode as follows.

*After connecting the two scanners, make sure the scanners are turned off.*

1. While you press and hold **E**, turn the radio on for each scanner.
2. Determine the scanner which has the frequency data that you want to transfer. This one must be set up as the “First Unit”, and the other must be set as the “Clone Unit”.
3. On the scanner that is the “Clone Unit”, use the ▲ or ▼ key to select **CLONE**, then press **HOLD/RESUME**.
4. On the scanner that is the “First Unit”, use the ▲ or ▼ key to select **FIRST**, then press **HOLD/RESUME**.





- The data transfer begins from the First Unit to the Clone Unit. During the data transfer, both scanners show the following displays.



send data



receive data

When the data transfer is complete, done displays.



If the data transfer is not successful, the following error message will appear.



**Note:** • To clear Error, press  (decimal key).

- Once you have completed the cloning of the scanners, reset the scanners by turning the scanners OFF and then ON again. This is particularly important to know if you wish to clone another scanner right away.



---

---

## Care and Maintenance

---

---

### **General Use**

- Turn the scanner **OFF** before disconnecting the power.
- Always write down the programmed frequencies in the event of memory loss.
- If memory is lost, simply reprogram each channel.  
The display shows 000.0000 in all channels when there has been a memory loss.

### **Location**

- Do not use the scanner in high-moisture environments such as the kitchen or bathroom.
- Avoid placing the unit in direct sunlight or near heating elements or vents.
- If the scanner receives strong interference or electrical noise, move it or its antenna away from the source of the noise. If possible, a higher elevation may provide better reception.

### **Cleaning**

- Disconnect the power to the unit before cleaning.
- Clean the outside of the scanner with a mild detergent.  
To prevent scratches, do not use abrasive cleaners or solvents. Be careful not to rub the LCD window.
- Do not use excessive amounts of water.

### **Repairs**

- Do not attempt any repair. The scanner contains no user serviceable parts contact your retailer or see warranty page for service information.

### **Birdies**

- All radios can receive birdies (undesired signals). If your scanner stops during Scan mode and no sound is heard, it may be receiving a birdie. Birdies are internally generated signals inherent in the electronics of the receiver.

Press **L/O** to lockout the channel, and then press **HOLD/RESUME** to resume scanning.







## Troubleshooting

If your UBCT9 is not performing properly, try the following steps.

Problem	Suggestion
Scanner won't work.	<ol style="list-style-type: none"> <li>1. Check the connections at both ends of the AC Adapter.</li> <li>2. Turn ON the wall switch of your room. You could be using an outlet controlled by the wall switch.</li> <li>3. Move the AC Adapter to another wall outlet.</li> </ol>
Improper reception.	<ol style="list-style-type: none"> <li>1. Check the antenna connection.</li> <li>2. Move the scanner.</li> <li>3. You may be in a remote area which could require an optional multi-band antenna. Check with your dealer or local electronics store.</li> </ol>
Scan won't stop.	<ol style="list-style-type: none"> <li>1. Adjust squelch threshold - refer to page 14, "Setting the Squelch".</li> <li>2. Check the antenna connection.</li> <li>3. Check to see if many of the channels are Locked Out. If so, the scanner has less chance of finding an active channel.</li> <li>4. Review each channel's frequency to see if it is still stored in Memory and is correct.</li> <li>5. It's possible that none of the programmed frequencies are currently active.</li> </ol>
Scan won't start.	<ol style="list-style-type: none"> <li>1. Press <b>SCAN</b> key again.</li> <li>2. Adjust the <b>SQL</b> control.</li> <li>3. Check to see if all channels are Locked Out</li> </ol>



If you experience difficulty while in TrunkTracker mode, try the following steps.

<b>Problem</b>	<b>Suggestion</b>
Scanner won't track.	<ol style="list-style-type: none"> <li>1. Missing the Data Frequency.</li> <li>2. Change to a Type 1 Scanner setup. Review Fleet Map Programming on page 44.</li> </ol>
Scanner won't stop during Scan List mode.	<ol style="list-style-type: none"> <li>1. No IDs have been programmed.</li> <li>2. The IDs you have stored are not active.</li> </ol>
Scanner will not acquire data channel.	<ol style="list-style-type: none"> <li>1. Adjust the squelch for Trunking mode - refer to page 29.</li> <li>2. Missing the frequency used for the data channel. Check your frequency list.</li> </ol>
Missing replies to conversations.	<ol style="list-style-type: none"> <li>1. Change a Type 1 scanner setup. Review Fleet Map Programming on page 44.</li> <li>2. Try another Preset Fleet Map or Program your own Fleet Map.</li> <li>3. Check to see that all of the system's frequencies have been entered.</li> </ol>
Channel Activity Indicators are flashing but no sound is heard.	<ol style="list-style-type: none"> <li>1. May be a telephone interconnect call, which are intentionally blocked by your scanner.</li> <li>2. The ID on your display is not active.</li> </ol>
Scanner not tracking an EDACS system properly.	<ol style="list-style-type: none"> <li>1. Logical channel numbers (frequencies) for the system are not programmed in the correct order. Check frequency resources and reprogram.</li> <li>2. Not all frequencies for the system are programmed. Check frequency resources.</li> </ol>

If you still cannot get satisfactory results while using your scanner or if you want additional information, please see the Uniden contact details in the warranty page at the back of this manual.

If you have internet access, you can visit [www.uniden.com.au](http://www.uniden.com.au), [www.uniden.co.nz](http://www.uniden.co.nz) for additional information.





---



---

## Specifications

---



---

Certified in accordance with FCC Rules and Regulations Part 15, Subpart C, as of date of manufacture.

Channel:	250
Banks:	5 (50 channels each)
Service Bands:	6 preprogrammed search bands
Frequency Range:	25.0-28.0 MHz 28.0-70.0 MHz 70.0-88.0 MHz 88.0-108.0 MHz 108.0-137.0 MHz 137.0-148.0 MHz 148.0-174.0 MHz 174.0-225.0 MHz 225.0-400.0 MHz 400.0-512.0 MHz 806.0-956.0 MHz 1240.0-1300.0 MHz
Operating Temperature:	-20 °C to +60 °C (-4 °F to +140 °F)
Scan Rate:	100 channels per second (conventional mode)
Search Rate:	100 steps per second (Normal Search) 300 steps per second (Turbo Search: when searching 5KHz step bands)
Audio Output:	Maximum 2.0W (1.6W normal @ 10% THD)
Internal Speaker:	8 ohms (57 mm outer diameter)
Power Requirements:	AAD-008S AC Adapter (12V DC, 500mA)
Antenna:	Telescopic Antenna (included) Window Mount Antenna (included) Antenna Jack: BNC type
External Jacks:	External Speaker (EXT.SP.) (3.5 mm) DC 12 V Power Jack, (center is positive) Remote Control (REMOTE) Jack (DB-9)
Size:	7.06 in. (W) x 6.10 in. (D) x 2.44 in. (H) 176.5mm (W) x 153.6 (D) x 50.8mm (H)
Weight:	1.1 kg (2 lbs 7 oz.)

Features and specifications are all subject to change without notice.





---

---

## Appendix

---

---

### State Code Order

No.	Code	State Name
1.	ACT	Australian Central Territories
2.	NSW	New South Wales
3.	NT	Northern Territory
4.	NZ	New Zealand
5.	QLD	Queensland
6.	SA	South Australia
7.	TAS	Tasmania
8.	VIC	Victoria
9.	WA	Western Australia



## Preset Fleet Maps

### E1P1

Block	Size Code
0	SIZE CODE 11
1	SIZE CODE 11
2	SIZE CODE 11
3	SIZE CODE 11
4	SIZE CODE 11
5	SIZE CODE 11
6	SIZE CODE 11
7	SIZE CODE 11

### E1P2

Block	Size Code
0	SIZE CODE 4
1	SIZE CODE 4
2	SIZE CODE 4
3	SIZE CODE 4
4	SIZE CODE 4
5	SIZE CODE 4
6	SIZE CODE 4
7	SIZE CODE 4

### E1P3

Block	Size Code
0	SIZE CODE 4
1	SIZE CODE 4
2	SIZE CODE 4
3	SIZE CODE 4
4	SIZE CODE 4
5	SIZE CODE 4
6	SIZE CODE 12
7	(SIZE CODE 12)

### E1P4

Block	Size Code
0	SIZE CODE 12
1	(SIZE CODE 12)
2	SIZE CODE 4
3	SIZE CODE 4
4	SIZE CODE 4
5	SIZE CODE 4
6	SIZE CODE 4
7	SIZE CODE 4

### E1P5

Block	Size Code
0	SIZE CODE 4
1	SIZE CODE 4
2	SIZE CODE 12
3	(SIZE CODE 12)
4	SIZE CODE 4
5	SIZE CODE 4
6	SIZE CODE 4
7	SIZE CODE 4

### E1P6

Block	Size Code
0	SIZE CODE 3
1	SIZE CODE 10
2	SIZE CODE 4
3	SIZE CODE 4
4	SIZE CODE 12
5	(SIZE CODE 12)
6	SIZE CODE 12
7	(SIZE CODE 12)

### E1P7

Block	Size Code
0	SIZE CODE 10
1	SIZE CODE 10
2	SIZE CODE 11
3	SIZE CODE 4
4	SIZE CODE 4
5	SIZE CODE 4
6	SIZE CODE 4
7	SIZE CODE 4

### E1P8

Block	Size Code
0	SIZE CODE 1
1	SIZE CODE 1
2	SIZE CODE 2
3	SIZE CODE 2
4	SIZE CODE 3
5	SIZE CODE 3
6	SIZE CODE 4
7	SIZE CODE 4



**E1P9**

Block	Size Code
0	SIZE CODE 4
1	SIZE CODE 4
2	SIZE CODE 0
3	SIZE CODE 0
4	SIZE CODE 0
5	SIZE CODE 0
6	SIZE CODE 0
7	SIZE CODE 0

**E1P10**

Block	Size Code
0	SIZE CODE 0
1	SIZE CODE 0
2	SIZE CODE 0
3	SIZE CODE 0
4	SIZE CODE 0
5	SIZE CODE 0
6	SIZE CODE 4
7	SIZE CODE 4

**E1P11**

Block	Size Code
0	SIZE CODE 4
1	SIZE CODE 0
2	SIZE CODE 0
3	SIZE CODE 0
4	SIZE CODE 0
5	SIZE CODE 0
6	SIZE CODE 0
7	SIZE CODE 0

**E1P12**

Block	Size Code
0	SIZE CODE 0
1	SIZE CODE 0
2	SIZE CODE 0
3	SIZE CODE 0
4	SIZE CODE 0
5	SIZE CODE 0
6	SIZE CODE 0
7	SIZE CODE 4

**E1P13**

Block	Size Code
0	SIZE CODE 3
1	SIZE CODE 3
2	SIZE CODE 11
3	SIZE CODE 4
4	SIZE CODE 4
5	SIZE CODE 0
6	SIZE CODE 0
7	SIZE CODE 0

**E1P14**

Block	Size Code
0	SIZE CODE 4
1	SIZE CODE 3
2	SIZE CODE 10
3	SIZE CODE 4
4	SIZE CODE 4
5	SIZE CODE 4
6	SIZE CODE 12
7	(SIZE CODE 12)

**E1P15**

Block	Size Code
0	SIZE CODE 4
1	SIZE CODE 4
2	SIZE CODE 4
3	SIZE CODE 11
4	SIZE CODE 11
5	SIZE CODE 0
6	SIZE CODE 12
7	(SIZE CODE 12)

**E1P16**

Block	Size Code
0	SIZE CODE 3
1	SIZE CODE 10
2	SIZE CODE 10
3	SIZE CODE 11
4	SIZE CODE 0
5	SIZE CODE 0
6	SIZE CODE 12
7	(SIZE CODE 12)



## User Defined Fleet Maps

### Type I Programming Information

When a Type I system is designed, the address information for all the IDs are divided into 8 equal sized blocks. When you program your scanner to track a Type I system, you must select a size code for each of these blocks. When you have assigned a size code to all 8 blocks, you have defined the Fleet Map for the system you're tracking. Each size code determines the number of Fleets, Subfleets, and IDs each block will have. For example, a size code of "4" has one Fleet, which is divided into 16 separate Subfleets, and it has a total of 512 individual IDs.

When a block is assigned a size code, the Fleet or Fleets created within the block are assigned a Type I ID. The way these IDs display on your scanner depends on the block number and the blocks size code. When a Type I ID displays, the left most digit represents the block which contains the ID. The next two or three digits identify which Fleet is active, and the last digit(s) identifies the Subfleet.

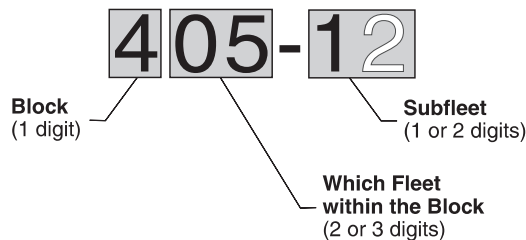

Your task is to program your fleet map with the same size code assignments as the trunked system. If you do this accurately, you'll track all the Fleet-Subfleet combinations used by the system. In other words, you'll hear complete communications while monitoring a trunked system.

If you don't already know the size codes used, you'll have to guess at them. But since you don't have to figure out all the blocks at once, this isn't as hard as it seems. Select a size code for a block, and then press **SRCH**. Now listen to the communications. If you decide you are receiving most of the replies to the conversations with IDs assigned to the block you just programmed, then you've probably selected the right size code and can work on the next block of the map.

Finally, for most public safety systems there are some size codes which are more common. SIZE CODE 3 and SIZE CODE 4 are probably the most common, followed by SIZE CODE 10, SIZE CODE 11, and SIZE CODE 12.





## Fleet Map Size Codes

Size	Fleets	Subfleets	IDs	Blocks Used
0	Reserves block for Type II IDs			
1	128	4	16	1
2	16	8	64	1
3	8	8	128	1
4	1	16	512	1
5	64	4	32	1
6	32	8	32	1
7	32	4	64	1
8	16	4	128	1
9	8	4	256	1
10	4	8	256	1
11	2	16	256	1
12	1	16	1024	2
13	1	16	2048	4
14	1	16	4096	8

### Size Code Restrictions

If you select SIZE CODE 12, 13, or 14, there are some restrictions as to which blocks can be used for these codes.

- SIZE CODE 12 can only be assigned to Blocks 0, 2, 4, or 6.
- SIZE CODE 13 can only be assigned to Blocks 0 and 4.
- SIZE CODE 14 can only be assigned to Block 0.

Since these SIZE CODES require multiple blocks, you will be prompted for the next available block when programming a Fleet Map. For example, if you assign Block 0 as an SIZE CODE 12, you will be prompted for Block 2, the next block available, instead of Block 1. And if you assign Block 0 as SIZE CODE 14, you would not see another prompt because all available blocks have been used.







**MEMO**





**MEMO**





---

---

## One Year Limited Warranty

---

---

### UNIDEN UBCT9 Scanning Receiver

**IMPORTANT:** Evidence of the original purchase is required for warranty service.

**WARRANTOR:** Uniden New Zealand Limited. Uniden Australia Pty Ltd. ABN 58 001 865 498  
**Warranty only available in original country of purchase.**

**ELEMENT OF WARRANTY:**

Uniden warrants to the original retail owner for the duration of this warranty, its UBCT9 (herein after referred to as the Product), to be free from defects in materials and craftsmanship with only the limitations or exclusions set out below.

**WARRANTY DURATION:**

This warranty to the original retail owner only, shall terminate and be of no further effect 1 year (12 months) after the date of original retail sale. This warranty will be deemed invalid if the Product is;

- (A) Damaged or not maintained as reasonable and necessary,
  - (B) Modified, altered or used as part of any conversion kits, subassemblies, or any configurations not sold by Uniden,
  - (C) Improperly installed,
  - (D) Repaired by someone other than an authorized Uniden Repair Agent for a defect or malfunction covered by this warranty,
  - (E) Used in conjunction with any equipment or parts or as part of a system not manufactured by Uniden, or
  - (F) Where the Serial Number label of the product has been removed or damaged beyond recognition.
- Warranty only valid in the country of original retail/sale.

**PARTS COVERED:**

This warranty covers for one (1) year, the Product and included accessories.

**STATEMENT OF REMEDY:**

In the event that the Product does not conform to this warranty at any time while this warranty is in effect, the warrantor at its discretion, will repair the defect or replace the Product and return it to you without charge for parts or service. This warranty does not provide for reimbursement or payment of incidental or consequential damages. This EXPRESS WARRANTY is in addition to and does not in any way affect your rights under the TRADE PRACTICES ACT 1974 (Cth) (Australia) or the CONSUMER GUARANTEES ACT (New Zealand).

**PROCEDURE FOR OBTAINING PERFORMANCE OR WARRANTY:**

In the event that the Product does not conform to this warranty, the Product should be shipped or delivered, freight pre-paid, with evidence of original purchase (e.g. a copy of the sales docket), to the warrantor at:

**UNIDEN AUSTRALIA PTY LIMITED**  
**SERVICE DIVISION**  
345 Princes Highway,  
Rockdale,  
NSW 2216,  
AUSTRALIA  
Fax: (02) 9599 3278  
[www.uniden.com.au](http://www.uniden.com.au)

**UNIDEN NEW ZEALAND LIMITED**  
**SERVICE DIVISION**  
150 Harris Road,  
East Tamaki,  
Auckland,  
NEW ZEALAND  
Fax: (09) 274 4253  
[www.uniden.co.nz](http://www.uniden.co.nz)





THANK YOU FOR BUYING A UNIDEN PRODUCT

**Uniden<sup>®</sup>**

©2007. Uniden Australia Pty Limited/Uniden New Zealand Limited  
Printed in China.  
UBZZ01332AZ(0)