

**UDC2500**  
**Universal Digital Controller**  
**Product Manual**

**51-52-25-127**

**Revision 8**

**April 2017**

# Notices and Trademarks

**Copyright 2017 by Honeywell  
Revision 8 April 2017**

While this information is presented in good faith and believed to be accurate, Honeywell disclaims the implied warranties of merchantability and fitness for a particular purpose and makes no express warranties except as may be stated in its written agreement with and for its customers.

In no event is Honeywell liable to anyone for any indirect, special or consequential damages. The information and specifications in this document are subject to change without notice.

Honeywell, PlantScape, Experion PKS, and **TotalPlant** are registered trademarks of Honeywell International Inc.

Other brand or product names are trademarks of their respective owners.

**Honeywell Process Solutions  
1250 W Sam Houston Pkwy S  
Houston, TX 77042**

---

# About This Document

## Abstract

This document provides descriptions and procedures for the Installation, Configuration, Operation, and Troubleshooting of your UDC2500 Controller.

## Revision Information

Document Name	Document ID	Revision Number	Publication Date
<b>UDC2500 Universal Digital Controller Product Manual</b>			
Rating Operating Altitude added	51-52-25-127	6	March 2012
Figure 2.15 added (Current OP with Relay)	51-52-25-127	7	April 2014
Switching between setpoints, <b>button corrected</b>	51-52-25-127	8	April 2017

## References

The following list identifies all documents that may be sources of reference for material discussed in this publication.

Document Title	
Process Instrument Explorer manual	51-52-25-131
How to Apply Digital Instrumentation in Severe Electrical Noise Environments.	51-52-05-01
Modbus RTU Serial Communications User Manual	51-52-25-66
MODBUS Messaging on TCP/IP Implementation Guide.	51-52-25-121

## Support and Contact Information

For Europe, Asia Pacific, North and South America contact details, refer to the back page of this manual or the appropriate Honeywell Solution Support web site:

Honeywell Corporate [www.honeywellprocess.com](http://www.honeywellprocess.com)

Honeywell Process Solutions [www.honeywellprocess.com/pressure-transmitters/](http://www.honeywellprocess.com/pressure-transmitters/)

Training Classes <http://www.automationcollege.com>











---

## Telephone and Email Contacts



Area	Organization	Phone Number
United States and Canada	Honeywell Inc.	1-800-343-0228 Customer Service
		1-800-423-9883 Global Technical Support
Global Email Support	Honeywell Process Solutions	<a href="mailto:ask-ssc@honeywell.com">ask-ssc@honeywell.com</a>

## Symbol Definitions

The following table lists those symbols used in this document to denote certain conditions.

Symbol	Definition
	<b>ATTENTION:</b> Identifies information that requires special consideration.
	<b>TIP:</b> Identifies advice or hints for the user, often in terms of performing a task.
<b>CAUTION</b>	Indicates a situation which, if not avoided, may result in equipment or work (data) on the system being damaged or lost, or may result in the inability to properly operate the process.
	<b>CAUTION:</b> Indicates a potentially hazardous situation which, if not avoided, may result in minor or moderate injury. It may also be used to alert against unsafe practices. <b>CAUTION</b> symbol on the equipment refers the user to the product manual for additional information. The symbol appears next to required information in the manual.
	<b>WARNING:</b> Indicates a potentially hazardous situation, which, if not avoided, could result in serious injury or death. <b>WARNING</b> symbol on the equipment refers the user to the product manual for additional information. The symbol appears next to required information in the manual.
	<b>WARNING, Risk of electrical shock:</b> Potential shock hazard where HAZARDOUS LIVE voltages greater than 30 Vrms, 42.4 Vpeak, or 60 VDC may be accessible.
	<b>ESD HAZARD:</b> Danger of an electro-static discharge to which equipment may be sensitive. Observe precautions for handling electrostatic sensitive devices.
	<b>Protective Earth (PE) terminal:</b> Provided for connection of the protective earth (green or green/yellow) supply system conductor.
	<b>Functional earth terminal:</b> Used for non-safety purposes such as noise immunity improvement. NOTE: This connection shall be bonded to Protective Earth at the source of supply in accordance with national local electrical code requirements.
	<b>Earth Ground: Functional earth connection.</b> NOTE: This connection shall be bonded to Protective Earth at the source of supply in accordance with national and local electrical code requirements.
	<b>Chassis Ground:</b> Identifies a connection to the chassis or frame of the equipment shall be bonded to Protective Earth at the source of supply in accordance with national and local electrical code requirements.

continued

Symbol	Description
	The Canadian Standards mark means the equipment has been tested and meets applicable standards for safety and/or performance.
	For radio equipment used in the European Union in accordance with the R&TTE Directive the CE Mark and the notified body (NB) identification number is used when the NB is involved in the conformity assessment procedure. The alert sign must be used when a restriction on use (output power limit by a country at certain frequencies) applies to the equipment and must follow the CE marking.

# Contents

Support and Contact Information .....	iv
<b>1 INTRODUCTION .....</b>	<b>1</b>
1.1 Overview .....	1
1.2 Function of Displays and Keys .....	3
1.3 Process Instrument Explorer Software .....	4
1.4 CE Conformity (Europe).....	5
<b>2 INSTALLATION.....</b>	<b>7</b>
2.1 Overview.....	7
2.2 Condensed Specifications .....	8
2.3 Model Number Interpretation .....	12
2.4 Control and Alarm Relay Contact Information .....	15
2.5 Mounting.....	16
2.6 Wiring .....	18
2.6.1 Electrical Considerations .....	18
2.7 Wiring Diagrams.....	20
<b>3 CONFIGURATION.....</b>	<b>33</b>
3.1 Overview .....	33
3.2 Configuration Prompt Hierarchy .....	34
3.3 Configuration Procedure.....	35
3.4 Tuning Set Up Group.....	36
3.5 SP Ramp Set Up Group .....	40
3.6 Accutune Set Up Group.....	44
3.7 Algorithm Set Up Group.....	47
3.8 Output Set Up Group .....	52
3.9 Input 1 Set Up Group.....	56
3.10 Input 2 Set Up Group .....	60
3.11 Control Set Up Group .....	62
3.12 Options Group.....	68
3.13 Communications Group .....	74
3.14 Alarms Set Up Group.....	77

3.15	Display Set Up Group .....	83
3.16	P.I.E. Tool Ethernet and Email Configuration Screens .....	85
3.17	Configuration Record Sheet.....	88
<b>4</b>	<b>MONITORING AND OPERATING THE CONTROLLER.....</b>	<b>90</b>
4.1	Overview.....	90
4.2	Operator Interface .....	91
4.3	Entering a Security Code .....	91
4.4	Lockout Feature .....	92
4.5	Monitoring Your Controller .....	94
4.5.1	Annunciators .....	94
4.5.2	Viewing the operating parameters .....	95
4.5.3	Diagnostic Messages.....	96
4.6	Single Display Functionality .....	98
4.7	Start Up Procedure for Operation .....	100
4.8	Control Modes .....	101
4.8.1	Mode Definitions .....	101
4.8.2	What happens when you change modes .....	102
4.9	Setpoints.....	102
4.10	Timer .....	103
4.11	Accutune III.....	105
4.11.1	Tune for Simplex Outputs .....	106
4.11.2	Tune for Duplex (Heat/Cool) .....	106
4.11.3	Using AUTOMATIC TUNE at start-up for Duplex (Heat/Cool) .....	107
4.11.4	Using BLENDED TUNE at start-up for Duplex (Heat/Cool) .....	107
4.11.5	Using MANUAL TUNE at start-up for Duplex (Heat/Cool).....	108
4.11.6	Error Codes .....	110
4.12	Fuzzy Overshoot Suppression .....	111
4.13	Using Two Sets of Tuning Constants.....	111
4.14	Alarm Setpoints.....	113
4.15	Three Position Step Control Algorithm .....	114
4.16	Setting a Failsafe Output Value for Restart After a Power Loss .....	115
4.17	Setting Failsafe Mode .....	116
4.18	Setpoint Rate/Ramp/Program Overview .....	116
4.19	Setpoint Ramp .....	117
4.20	Setpoint Rate .....	118
4.21	Setpoint Ramp/Soak Programming .....	119
4.22	P.I.E. Tool Maintenance Screens .....	126
4.23	Configuring your Ethernet Connection.....	132



---

<b>5</b>	<b>INPUT CALIBRATION</b> .....	<b>137</b>
5.1	Overview.....	137
5.2	Minimum and Maximum Range Values.....	138
5.3	Preliminary Information.....	140
5.4	Input 1 Set Up Wiring.....	141
5.5	Input 1 Calibration Procedure.....	145
5.6	Input 2 Set Up Wiring.....	147
5.7	Input 2 Calibration Procedure.....	148
5.8	Restore Input Factory Calibration.....	150
<b>6</b>	<b>OUTPUT CALIBRATION</b> .....	<b>153</b>
6.1	Overview.....	153
6.2	Current Output Calibration.....	154
6.3	Auxiliary Output Calibration.....	156
6.4	Restore Output Factory Calibration Procedure.....	158
<b>7</b>	<b>TROUBLESHOOTING/SERVICE</b> .....	<b>160</b>
7.1	Overview.....	160
7.2	Troubleshooting Aids.....	161
7.3	Power-up Tests.....	163
7.4	Status Tests.....	163
7.5	Background Tests.....	164
7.6	Controller Failure Symptoms.....	166
7.7	Troubleshooting Procedures.....	167
7.8	Restoring Factory Configuration.....	176
7.9	Software Upgrades.....	177
<b>8</b>	<b>PARTS LIST</b> .....	<b>179</b>
8.1	Exploded View.....	179
8.2	Removing the chassis.....	181
<b>9</b>	<b>MODBUS RTU FUNCTION CODES</b> .....	<b>182</b>
9.1	Overview.....	182
9.2	General Information.....	182
9.3	Function Code 20 (14h) - Read Configuration Reference Data.....	184
9.3.1	Read Configuration Examples.....	186
9.4	Function Code 21 (15h) - Write Configuration Reference Data.....	188
9.4.1	Write Configuration Examples.....	190

---

<b>10</b>	<b>MODBUS READ, WRITE AND OVERRIDE PARAMETERS PLUS EXCEPTION CODES</b>	<b>191</b>
10.1	Overview	191
10.2	Reading Control Data	192
10.3	Read Software Options Status	193
10.4	Miscellaneous Read Onlys	194
10.4.1	Register Addresses for Read Onlys	194
10.4.2	SetPoint Program Read Only Information	194
10.5	Setpoints	195
10.6	Using a Computer Setpoint (Overriding Controller Setpoint)	196
10.7	Configuration Parameters	198
10.7.1	Tuning	198
10.7.2	SP Ramp/Rate/Program	200
10.7.3	Accutune	203
10.7.4	Algorithm	204
10.7.5	Output Algorithms	205
10.7.6	Input 1	206
10.7.7	Input 2	209
10.7.8	Control	211
10.7.9	Options	213
10.7.10	Communications	215
10.7.11	Alarms	216
10.7.12	Display	219
10.8	Modbus RTU Exception Codes	220
<b>11</b>	<b>ETHERNET TCP/IP</b>	<b>222</b>
11.1	Overview	222
<b>12</b>	<b>FURTHER INFORMATION</b>	<b>223</b>
12.1	Modbus RTU Serial Communications	223
12.2	Modbus Messaging on TCP/IP	223
12.3	How to Apply Digital Instrumentation in Severe Electrical Noise Environments	223

## Tables

Table 2-1	Condensed Specifications	8
Table 2-2	Control Relay Contact Information	15
Table 2-3	Alarm Relay Contact Information	15
Table 2-4	Mounting Procedure	17
Table 2-5	Permissible Wiring Bundling	19
Table 2-6	Universal Output Functionality and Restrictions	21
Table 2-7	Terminals for connecting a UDC to a MDI Compliant Hub or Switch	30
Table 2-8	Terminals for connecting a UDC directly to a PC utilizing a straight-through cable	31
Table 3-1	Configuration Topics	33
Table 3-2	Configuration Prompt Hierarchy	34
Table 3-3	Configuration Procedure	35
Table 3-4	TUNING Group (Numeric Code 100) Function Prompts	36
Table 3-5	SPRAMP Group (Numeric Code 200) Function Prompts	40
Table 3-6	ATUNE Group (Numeric Code 300) Function Prompts	45
Table 3-7	ALGOR Group (Numeric Code 400) Function Prompts	47
Table 3-8	OUTPUT Group (Numeric Code 500) Function Prompts	52
Table 3-9	INPUT 1 Group (Numeric Code 600) Function Prompts	56
Table 3-10	INPUT2 Group (Numeric Code 700) Function Prompts	60
Table 3-11	CONTRL Group (Numeric Code 800) Function Prompts	62
Table 3-12	OPTION Group (Numeric Code 900) Function Prompts	68
Table 3-13	Communications Group (Numeric Code 1000) Function Prompts	74
Table 3-14	ALARMS Group (Numeric Code 1100) Function Prompts	77
Table 3-15	DISPLY Group (Numeric Code 1200) Function Prompts	83
Table 4-1	Procedure to Enter a Security Code	92
Table 4-2	Annunciators	94
Table 4-3	Lower Display Key Parameter Prompts	95
Table 4-4	Diagnostic Messages	96
Table 4-5	Single Display Parameters	99
Table 4-6	Procedure for Starting Up the Controller	100
Table 4-7	Control Mode Definitions	101
Table 4-8	Changing Control Modes (Dual Display Only)	102
Table 4-9	Procedure for Changing the Local Setpoints	102
Table 4-10	Procedure for Switching Between Setpoints	103
Table 4-11	Procedure for Starting “TUNE”	106
Table 4-12	Procedure for Using AUTOMATIC TUNE at Start-up for Duplex Control	107
Table 4-13	Procedure for Using BLENDED TUNE at Start-up for Duplex Control	108
Table 4-14	Procedure for Using MANUAL TUNE for Heat side of Duplex Control	108
Table 4-15	Procedure for Using MANUAL TUNE for Cool side of Duplex Control	109
Table 4-16	Procedure for Accessing Accutune Error Codes	110
Table 4-17	Accutune Error Codes	110
Table 4-18	Set Up Procedure	112
Table 4-19	Procedure for Switching PID SETS from the Keyboard	113
Table 4-20	Procedure for Displaying Alarm Setpoints	113
Table 4-21	Procedure for Displaying 3Pstep Motor Position	114
Table 4-22	Procedure for Setting a Failsafe Value	115
Table 4-23	Procedure for Setting a Failsafe Mode	116
Table 4-24	Running A Setpoint Ramp	117

Table 4-25 Program Contents	119
Table 4-26 Run/Monitor Functions	124
Table 5-1 Voltage, Milliamp and Resistance Equivalents for Input 1 Range Values	138
Table 5-2 Voltage and Milliamp Equivalents for Input 2 Range Values	140
Table 5-3 Equipment Needed	140
Table 5-4 Set Up Wiring Procedure for Thermocouple Inputs Using an Ice Bath	141
Table 5-5 Set Up Wiring Procedure for Thermocouple Inputs using Thermocouple Source	142
Table 5-6 Set Up Wiring Procedure for RTD Inputs	142
Table 5-7 Set Up Wiring Procedure for Radiamatic, Millivolts, Volts or T/C Differential Inputs	143
Table 5-8 Set Up Wiring Procedure for 0 to 10 Volts	144
Table 5-9 Set Up Wiring Procedure for Milliampere Inputs	144
Table 5-10 Input 1 Calibration Procedure (Numeric Code 10000)	145
Table 5-11 Set Up Wiring Procedure for 0 to 20 mA or 4 to 20 mA Inputs – Input 2	147
Table 5-12 Set Up Wiring Procedure for 0 to 2 Volts, 0 to 5 Volts, or 1 to 5 Volts – Input 2	148
Table 5-13 Input 2 Calibration Procedure (Numeric Code 20000)	149
Table 5-14 Restore Factory Calibration	150
Table 6-1 Set Up Wiring Procedure for Current Output	154
Table 6-2 Current Output Calibration Procedure (Numeric Code 30000)	155
Table 6-3 Set Up Wiring Procedure for Auxiliary Output	156
Table 6-4 Auxiliary Output Calibration Procedure (Numeric Code 50000)	157
Table 6-5 Restore Factory Calibration Procedure	158
Table 7-1 Procedure for Identifying the Software Version	162
Table 7-2 Procedure for Displaying the Status Test (Numeric Code 1200) Results	163
Table 7-3 Background Tests	164
Table 7-4 Controller Failure Symptoms	166
Table 7-5 Troubleshooting Power Failure Symptoms	168
Table 7-6 Troubleshooting Current Output Failure	168
Table 7-7 Troubleshooting Three Position Step Control Output Failure	169
Table 7-8 Troubleshooting Time Proportional Output Failure	170
Table 7-9 Troubleshooting Current/Time or Time/Current Proportional Output Failure	170
Table 7-10 Troubleshooting Alarm Relay Output Failure	172
Table 7-11 Troubleshooting a Keyboard Failure	173
Table 7-12 Troubleshooting a RS-485 Communications Failure	173
Table 7-13 Troubleshooting an Ethernet Communications Failure	175
Table 7-14 Troubleshooting Auxiliary Output Failure	175
Table 7-15 Restoring Factory Configuration	176
Table 7-16 Software Upgrades	177
Table 8-1 Parts Identification	180
Table 8-2 Parts Not Shown	180
Table 8-3 Software Upgrades (see Section 7.9)	180
Table 9-1 Integer Parameter Type	183
Table 9-2 Floating Point Parameter Type	183
Table 9-3 Register Address Format for Function Code 20	185
Table 9-4 Register Address Format for Function Code 21	189
Table 10-1 Control Data Parameters	193
Table 10-2 Option Status	193
Table 10-3 Miscellaneous Read Onlys	194
Table 10-4 SetPoint Program Read Only Information	194
Table 10-5 Setpoint Code Selections	195
Table 10-6 Setpoint Associated Parameters	195

Table 10-7 Computer Setpoint Selection	196
Table 10-8 Computer Setpoint Associated Parameters	197
Table 10-9 Set-up Group – Tuning	198
Table 10-10 Set-up Group – Setpoint Ramp/Rate	200
Table 10-11 Set-up Group – Accutune	203
Table 10-12 Set-up Group – Algorithm	204
Table 10-13 Set-up Group – Output	205
Table 10-14 Set-up Group – Input 1	206
Table 10-15 Set-up Group – Input 2	209
Table 10-16 Set-up Group – Control	211
Table 10-17 Set-up Group – Options	213
Table 10-18 Set-up Group – Communications	215
Table 10-19 Set-up Group – Alarms	216
Table 10-20 Set-up Group – Display	219
Table 10-21 Modbus RTU Data Layer Status Exception Codes	221

## Figures

Figure 1-1 UDC2500 Operator Interface (all display items shown)	2
Figure 1-2 Screen capture of Process Instrument Explorer running on a Pocket PC	4
Figure 1-3 Depiction of infrared communications	5
Figure 2-1 Model Number Interpretation	12
Figure 2-2 Mounting Dimensions (not to scale)	16
Figure 2-3 Mounting Methods	17
Figure 2-4 Composite Wiring Diagram	22
Figure 2-5 Mains Power Supply	23
Figure 2-6 Input 1 Connections	24
Figure 2-7 Input 2 Connections	25
Figure 2-8 Electromechanical Relay Output	25
Figure 2-9 Solid State Relay Output	26
Figure 2-10 Open Collector Output	27
Figure 2-11 Dual Electromechanical Relay Option Output	28
Figure 2-12 Current Output	28
Figure 2-13 Three Position Step Control Connections for DC250-EE, Double Relays	29
Figure 2-14 Three Position Step Control for DC2500-RX, Dual Relay Option	29
Figure 2-15 Three Position Step Control for DC2500-CE, Current Output with Relay	29
Figure 2-16 RS-422/485 Communications Option Connections	30
Figure 2-17 Ethernet Communications Option Connections	30
Figure 2-18 Auxiliary Output and Digital Inputs Option Connections	31
Figure 2-19 Transmitter Power for 4-20 mA — 2 wire Transmitter Using Open Collector	32
Figure 2-20 Transmitter Power for 4-20 mA — 2 Wire Transmitter Using Auxiliary Output	32
Figure 3-1 Ethernet Configuration Screen	85
Figure 3-2 Email Configuration Screen	86
Figure 4-1 Operator Interface	91

Figure 4-2 Functional Overview Block Diagram of the UDC2500 Controller _____	97
Figure 4-3 Ramp/Soak Profile Example _____	122
Figure 4-4 Program Record Sheet _____	123
Figure 4-5 Maintenance Data Menu _____	126
Figure 4-6 Loop Data Maintenance Screen _____	127
Figure 4-7 Alarm Details Maintenance Screen _____	128
Figure 4-8 Digital Input Details Screen _____	129
Figure 4-9 Status Data Maintenance Screen _____	130
Figure 4-10 Ethernet Status Maintenance Screen _____	131
Figure 4-11 IR Communications Address _____	132
Figure 4-12 Online Configuration _____	133
Figure 4-13 Configuration Upload in Progress _____	133
Figure 4-14 Ethernet Communications Type Selection _____	134
Figure 4-15 Ethernet Communications Address _____	135
Figure 4-16 Configuration Upload in Progress _____	136
Figure 5-1 Input 1 and Input 2 Wiring Terminals _____	140
Figure 5-2 Wiring Connections for Thermocouple Inputs Using an Ice Bath _____	141
Figure 5-3 Wiring Connections for Thermocouple Inputs Using Thermocouple Source _____	142
Figure 5-4 Wiring Connections for RTD (Resistance Thermometer Device) _____	142
Figure 5-5 Wiring Connections for Radiamatic, T/C Differential, Millivolts or Volts _____	143
Figure 5-6 Wiring Connections for 0 to 10 Volts _____	144
Figure 5-7 Wiring Connections for 0 to 20 mA or 4 to 20 mA Inputs _____	144
Figure 5-8 Wiring Connections for 0 to 20 mA or 4 to 20 mA Input – Input 2 _____	147
Figure 5-9 Wiring Connections for 0 to 2 Volts, 0 to 5 Volts or 1 to 5 Volts Input – Input 2 _____	148
Figure 6-1 Wiring Connections for Calibrating Current Output _____	154
Figure 6-2 Wiring Connections for Calibrating Auxiliary Output _____	156
Figure 8-1 UDC2500 Exploded View _____	179
Figure 10-1 Software Option Status Information _____	193

# 1 Introduction

## 1.1 Overview

### Function

The UDC2500 is a microprocessor-based stand-alone controller. It combines a high degree of functionality and operating simplicity in a 1/4 DIN size controller. This instrument is an ideal controller for regulating temperature and other process variables in numerous heating and cooling applications, as well as in metal working, food, pharmaceuticals, semiconductor, testing and environmental work.

The UDC2500 monitors and controls temperatures and other variables in applications such as environmental chambers, plastic processing machines, furnaces and ovens, and packaging machinery.

### Features

- 90 – 250 Vac or 24 Vac/dc Power Supply
- Input/Output Isolation
- Isolated Auxiliary Current Output / Digital Inputs
- Modbus® RS-485, Infrared, or Ethernet TCP/IP Communications
- Infrared interface
- Timer
- Accutune III Tuning with Fuzzy Logic Overshoot Suppression.
- 2nd Input (Remote Setpoint)
- Setpoint Ramp/Rate/Program
- Three Position Step Control
- Duplex (Heat/Cool)

### Easy to Read Displays

The dedicated vacuum fluorescent displays with multi-language prompts make the operator interface easy to read, understand and operate. Programmed sequences of displays assure quick and accurate entry of all configurable parameters.

### Easy to Operate

Simple keystrokes let you select input and range configuration, set the operating parameters that meet your process control needs now, and change them later to meet new ones.

## Mount Anywhere

This instrument is intended for industrial control applications. It must be panel mounted with the wiring terminals enclosed within the panel. The instrument is environmentally hardened and, when suitably enclosed, can be mounted anywhere in plant or factory, on the wall, or even on the process machine itself. The front face is NEMA3 and IP55 rated and can be easily changed to NEMA4X and IP66 for the most severe hose-down applications. It withstands ambient temperatures up to 55°C (133°F) and resists the effects of vibration and shock.







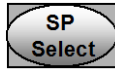



Figure 1-1 UDC2500 Operator Interface (all display items shown)



## 1.2 Function of Displays and Keys

Table 1-1 shows each key on the operator interface and defines its function.

**Table 1-1 Function of Displays and Keys**

Key	Function
	<ul style="list-style-type: none"> <li>Places the controller in the Configuration Set Up group select mode. Sequentially displays Set Up groups and allows the FUNCTION key to display individual functions in each Set Up group.</li> </ul>
	<ul style="list-style-type: none"> <li>Used in conjunction with the SET UP key to select the individual functions of a selected Configuration Set Up group.</li> <li>Used during field calibration procedure.</li> </ul>
	<ul style="list-style-type: none"> <li>Selects an operating parameter to be shown in the lower display. See Section 4.5.2 for a list of the operating parameters and Section 4.5.3 for a list of the diagnostic messages.</li> </ul>
	<ul style="list-style-type: none"> <li>Alternately selects:           <ul style="list-style-type: none"> <li><b>AUTO</b> Lower display automatically displays setpoint value in engineering units.</li> <li><b>MAN</b> Lower display automatically indicates output in %.</li> <li><b>RESET</b> Only used on Limit Controllers to reset the Limit Relay.</li> </ul> </li> </ul>
	<ul style="list-style-type: none"> <li><b>Setpoint Select</b> Hold key down to cycle through configured setpoints.</li> </ul>
	<ul style="list-style-type: none"> <li>Alternate action switch initiates or holds the Setpoint Ramp or Setpoint Program.</li> <li>Acknowledges a latched alarm 1.</li> <li>Acknowledges Diagnostic Messages.</li> </ul>
	<ul style="list-style-type: none"> <li>Increases the selected parameter value.</li> </ul>
	<ul style="list-style-type: none"> <li>Decreases the selected parameter value.</li> </ul>

Note 1: Value can be changed if in manual mode. For Three Position Step Control when a slidewire is not used, the output value is the estimated motor position.

Note 2: Value can be changed via increment/decrement keys.

Note 3: The selected set can be changed via increment/decrement keys.

## 1.3 Process Instrument Explorer Software

### Overview

Process Instrument Explorer lets you configure your instrument on a desktop/laptop or Pocket PC. For details see Process Instrument Explorer manual #51-52-25-131.

### Features

- Create configurations with intuitive software program running on either a Pocket PC, a Desktop or a laptop computer. ·
- Create/edit configurations live, just connect software to controller via comm port.·
- Create/edit configurations offline and download to controller later via comm. port.·
- Port types available on every UDC2500:·
  - Infrared
  - RS 485
  - Ethernet
- Same port types on UDC3200 and UDC3500 allow interconnectivity.
- This software is available in English, Spanish, Italian, German and French.

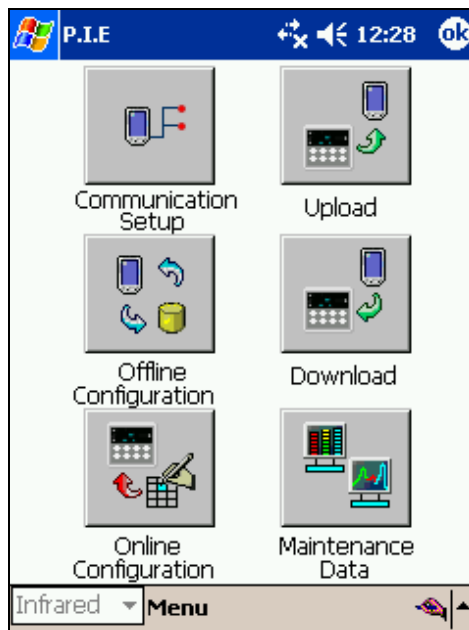


Figure 1-2 Screen capture of Process Instrument Explorer running on a Pocket PC

### Infrared communications

The infrared connection provides a non-intrusive wireless connection with the instrument and maintains NEMA4X AND IP66 integrity.

No need to get access to the back of the controller to communicate with the instrument, no need to take your screw driver to wire the communication cable, no wiring mistake possible. You can now duplicate an instrument's configuration, upload or download a new configuration in a matter of seconds, just by pointing your Pocket PC in the direction of the instrument.

It takes just a few seconds to upload a configuration from an instrument. You can then save the configuration file onto your PC or pocket PC for review, modification or archiving. Furthermore, this software also gives you important maintenance information on the controller: instantly, get information on the current operating parameters, digital inputs and alarm status, identify internal or analog input problems.

**Question:** What if I have several controllers on the same panel? How can I be sure I am communicating with the correct one?

**Answer:** The infrared port of the controller is normally "off". You activate the infrared port by pressing any controller's key. You can now communicate. After 4 minutes, the port will be shut down again. Also, in the Communications Group "IR ENABLE" may be disabled to prohibit IR communications.



Figure 1-3 Depiction of infrared communications

## 1.4 CE Conformity (Europe)

This product is in conformity with the protection requirements of the following European Council Directives: **73/23/EEC**, the Low Voltage Directive, and **89/336/EEC**, the EMC Directive. Conformity of this product with any other "CE Mark" Directive(s) shall not be assumed.

*Product Classification:* Class I: Permanently connected, panel-mounted Industrial Control Equipment with protective earthing (grounding) (EN61010-1).

*Enclosure Rating:* This controller must be panel-mounted with the rear terminals enclosed within the panel. The front panel of the controller is rated at NEMA4X and IP66 when properly installed.

*Installation Category (Overvoltage Category):* Category II (EN61010-1)

*Rating operating Altitude:* up to 2000m (Reference IEC and ANSI/ISA 61010)

*Pollution Degree:* Pollution Degree 2: Normally non-conductive pollution with occasional conductivity caused by condensation. (Ref. IEC 664-1)

*EMC Classification:* Group 1, Class A, ISM Equipment (EN61326, emissions), Industrial Equipment (EN61326, immunity)

*Method of EMC Assessment:* Technical File (TF)

*Declaration of Conformity:* 51453655

Deviation from the installation conditions specified in this manual, and the special conditions for CE conformity in Subsection 2.1, may invalidate this product's conformity with the Low Voltage and **EMC** Directives.

---

## ATTENTION

The emission limits of EN61326 are designed to provide reasonable protection against harmful interference when this equipment is operated in an industrial environment. Operation of this equipment in a residential area may cause harmful interference. This equipment generates, uses, and can radiate radio frequency energy and may cause interference to radio and television reception when the equipment is used closer than 30 meters (98 feet) to the antenna(e). In special cases, when highly susceptible apparatus is used in close proximity, the user may have to employ additional mitigating measures to further reduce the electromagnetic emissions of this equipment.

---

---

## WARNING

If this equipment is used in a manner not specified by the manufacturer, the protection provided by the equipment may be impaired.

---

## 2 Installation

### 2.1 Overview

#### Introduction

Installation of the UDC2500 consists of mounting and wiring the controller according to the instructions given in this section. Read the pre-installation information, check the model number interpretation (Subsection 2.3), and become familiar with your model selections, then proceed with installation.

#### What's in this section?

The following topics are covered in this section.

TOPIC	See Page
2.1 Overview	7
2.2 Condensed Specifications	8
2.3 Model Number Interpretation	12
2.4 Control and Alarm Relay Contact Information	15
2.5 Mounting	16
2.6 Wiring	18
2.7 Wiring Diagrams	20
Composite Wiring Diagram	22
AC Line Voltage	23
Input 1 Connections	24
Input 2 Connections	25
Relay Output	
Electromechanical	25
Solid State	26
Open Collector	27
Dual Electromechanical Relay	28
Current Output Connections	28
Three Position Step Control Connections w/o Dual Relay	29
Three Position Step Control Connections with Dual Relay	29
RS-422/485 Communications Option	30
Ethernet Communications Option	30
Auxiliary Output and Digital Inputs Option	31
Transmitter Power using Open Collector Output	32
Transmitter Power using Auxiliary Output	32

## Pre-installation Information

If the controller has not been removed from its shipping carton, inspect the carton for damage then remove the controller.

- Inspect the unit for any obvious shipping damage and report any damage due to transit to the carrier.
- Make sure a bag containing mounting hardware is included in the carton with the controller.
- Check that the model number shown on the inside of the case agrees with what you have ordered.

## 2.2 Condensed Specifications

Honeywell recommends that you review and adhere to the operating limits listed in Table 2-1 when you install your controller.

**Table 2-1 Condensed Specifications**

<b>Specifications</b>	
<b>Analog Inputs</b>	<p><i>Accuracy:</i>  <math>\pm 0.25\%</math> of full scale typical (<math>\pm 1</math> digit for display)                      Can be field calibrated to <math>\pm 0.05\%</math> of full scale typical                      16-bit resolution typical</p> <p><i>Sampling Rate:</i> Both inputs are sampled six times per second</p> <p><i>Temperature Stability:</i> <math>\pm 0.01\%</math> of Full Scale span / °C change—typical</p> <p><i>Input Impedance:</i>                      4-20 Milliampere Input: 250 ohms                      0-10 Volt Input: 200K ohms                      All Others: 10 megohms</p> <p><i>Maximum Lead Wire Resistance:</i>                      Thermocouples: 50 ohms/leg                      100 ohm, 200 ohm and 500 ohm RTD: 100 ohms/leg                      100 ohm Low RTD: 10 ohms/leg</p>
<b>Analog Input Signal Failure Operation</b>	<p><i>Burnout Selections:</i> Upscale, Downscale, Failsafe or None  <i>Thermocouple Health:</i> Good, Failing, Failure Imminent or Failed  <i>Failsafe Output Level:</i> Configurable 0-100% of Output range</p>
<b>Stray Rejection</b>	<p><b>Common Mode</b>  <i>AC (50 or 60 Hz):</i> 120 dB (with maximum source impedance of 100 ohms) or <math>\pm 1</math> LSB (least significant bit) whichever is greater with line voltage applied.  <i>DC:</i> 120 dB (with maximum source impedance of 100 ohms) or a <math>\pm 1</math> LSB whichever is greater with 120 Vdc applied.  <i>DC (to 1 KHz):</i> 80 dB (with maximum source of impedance of 100 ohms) or <math>\pm 1</math> LSB whichever is greater with 50 Vac applied.</p> <p><b>Normal Mode</b>  <i>AC (50 or 60 Hz):</i> 60 dB (with 100 % span peak-to-peak maximum)</p>
<b>Digital Inputs (Two) (Optional)</b>	<p>+30 Vdc source for external dry contacts or isolated solid state contacts. Digital Inputs are isolated from line power, earth ground, analog inputs and all outputs except for the Second Current Output.</p> <p>The second Digital Input is mutually exclusive with the Second Current Output.</p>

<b>Specifications</b>	
<b>Controller Output Types</b>	<p><b>Electromechanical Relays (One or Two)</b> SPDT contacts. Both Normally Open and Normally Closed contacts are brought out to the rear terminals. Internally socketed. <i>Resistive Load:</i> 5 amps @ 120 Vac or 240 Vac or 30 Vdc <i>Inductive Load (cos<math>\phi</math> = 0.4):</i> 3 amps @ 130 Vac or 250 Vac <i>Inductive Load (L/R = 7 msec):</i> 3.5 amps @ 30 Vdc <i>Motor:</i> 1/6 H.P.</p> <p><b>Dual Electromechanical Relays</b> Two SPST contacts. One Normally Closed contact for each relay is brought out to the rear terminals. Useful for Time Duplex or Three Position Step control applications, this option takes the place of one of the above electromechanical relays, thus saving it for use as an alarm. Units with this output option may have two additional relays (total of four relays) plus the Second Current Output. Relays are internally socketed. <i>Resistive Load:</i> 2 amps @ 120 Vac, 240 Vac or 30 Vdc <i>Inductive Load (cos<math>\phi</math> = 0.4):</i> 1 amp @ 130 Vac or 250 Vac <i>Inductive Load (L/R = 7 msec):</i> 1 amp @ 30 Vdc</p> <p><b>Solid State Relays (One or Two)</b> Zero-crossing type SPST solid state contacts consisting of a triac N.O. output. Internally socketed. <i>Resistive Load:</i> 1.0 amp @ 25°C and 120 or 240 Vac, 0.5 amp @ 55°C and 120 or 240 Vac <i>Inductive Load:</i> 50 VA @ 120 Vac or 240 Vac <i>Minimum Load:</i> 20 milliamps</p> <p><b>Open Collector Outputs (One or Two)</b> Socketed assembly replacing a relay. Opto-isolated from all other circuits except current output and not from each other. Internally powered @ 30 Vdc. Note: Applying an external power supply to this output will damage the instrument. <i>Maximum Sink Current:</i> 20 mA <i>Short-circuit current limit:</i> 100 mA</p> <p><b>Current Outputs (One or Two)</b> These outputs provide a 21 mA dc maximum into a negative or positive grounded load or into a non-grounded load. Current outputs are isolated from each other, line power, earth ground and all inputs. Outputs can be easily configured via the keyboard for either direct or reverse action and for either 0 to 20 mA or 4 to 20 mA without field calibration. The second current output can be used in an Auxiliary Output mode. This Auxiliary Output can be configured to represent either Input, PV, Setpoint, Deviation, or Control output. The range of an Auxiliary Output can be scaled per the range of the selected variable and can be set anywhere between 0 to 21 mA. The Second Current Output is mutually exclusive with the second Digital Input. <i>Resolution:</i> 12 bits over 0 to 21 mA <i>Accuracy:</i> 0.05% of full scale <i>Temperature Stability:</i> 0.01% F.S./°C <i>Load Resistance:</i> 0 to 1000 ohms</p>
<b>Alarm Outputs (Optional)</b>	<p>One SPDT Electromechanical relay. A second alarm is available if the second control relay is not used for control purposes or when the Dual Relay Option is used. Up to four setpoints are independently set as high or low alarm, two for each relay. Setpoint can be on any Input, Process Variable, Deviation, Manual Mode, Failsafe, PV Rate, RSP Mode, Communication Shed, or Output. A single adjustable hysteresis of 0.0 to 100.0% is provided. The alarm can also be set as an ON or OFF event at the beginning of a Setpoint ramp/soak segment. <i>Alarm Relay Contacts Rating:</i> Resistive Load: 5 amps at 120 Vac or 240 Vac or 30 Vdc</p>
<b>Isolation (Functional)</b>	<p><i>Analog Inputs:</i> are isolated from all other circuits at 850Vdc for 2 seconds, but not from each other. <i>Analog Outputs:</i> are isolated from all other circuits at 850Vdc for 2 seconds. <i>AC Power:</i> is electrically isolated from all other inputs and outputs to withstand a HIPOT potential of 1900Vdc for 2 seconds per Annex K of EN61010-1. <i>Relay Contacts:</i> with a working voltage of 115/230 Vac, are isolated from each other and all other circuits at 345Vdc for 2 seconds.</p>

<b>Specifications</b>	
<b>RS422/485 Modbus RTU Communications Interface (Optional)</b>	<p><i>Baud Rate:</i> 4800, 9600, 19,200 or 38,400 baud selectable  <i>Data Format:</i> Floating point or integer  <i>Length of Link:</i>            2000 ft (600 m) max. with Belden 9271 Twinax Cable and 120 ohm termination resistors            4000 ft. (1200 m) max. with Belden 8227 Twinax Cable and 100 ohm termination resistors  <i>Link Characteristics:</i> Two-wire, multi-drop Modbus RTU protocol, 15 drops maximum or up to 31 drops for shorter link length.</p>
<b>Ethernet TCP/IP Communications Interface (Optional)</b>	<p><i>Type:</i> 10Base-T  <i>Length of Link:</i> 330 ft. (100 m) maximum. Use Shielded twisted-pair, Category 5 (STP CAT5) Ethernet cable.  <i>Link Characteristics:</i> Four-wire plus shield, single drop, five hops maximum  <i>IP Address:</i> IP Address is 10.0.0.2 as shipped from the Factory  <i>Recommended network configuration:</i> Use Switch rather than Hub in order to maximize UDC Ethernet performance.  <i>Configuration:</i> Ethernet parameters are configured via the Process Instrument Explorer.  <i>Email:</i> The capability to send an Email is provided. This must be configured via the Process Instrument Explorer.</p>
<b>Infrared Communications (Optional)</b>	<p><i>Type:</i> Serial Infrared (SIR)  <i>Length of Link:</i> 3 ft. (1 m) maximum for IrDA 1.0 compliant devices  <i>Baud Rate:</i> 19,200 or 38,400 baud selectable</p>
<b>Power Consumption</b>	<p>18 VA maximum (90 to 250 Vac)            12 VA maximum (24 Vac/dc)</p>
<b>Power Inrush Current</b>	<p>10A maximum for 4 ms (under operating conditions), reducing to a maximum of 225 mA (90 to 250 Vac operation) or 750 mA (24 Vac/dc operation) after one second.</p> <p><b>CAUTION:</b> When applying power to more than one instrument, make sure that sufficient power is supplied. Otherwise, the instruments may not start up normally due to voltage drop from the inrush current.</p>
<b>Weight</b>	<p>3 lbs. (1.3 kg)</p>



Environmental and Operating Conditions				
Parameter	Reference	Rated	Operative Limits	Transportation and Storage
<b>Ambient Temperature</b>	25 ± 3 °C 77 ± 5 °F	15 to 55 °C 58 to 131 °F	0 to 55 °C 32 to 131 °F	-40 to 66 °C -40 to 151 °F
<b>Relative Humidity</b>	10 to 55*	10 to 90*	5 to 90*	5 to 95*
<b>Vibration</b> Frequency (Hz) Acceleration (g)	0 0	0 to 70 0.4	0 to 200 0.6	0 to 200 0.5
<b>Mechanical Shock</b> Acceleration (g) Duration (ms)	0 0	1 30	5 30	20 30
<b>Line Voltage (Vdc)</b>	+24 ± 1	22 to 27	20 to 27	--
<b>Line Voltage (Vac)</b> <b>90 to 240 Vac</b>  <b>24 Vac</b>	120 ± 1 240 ± 2  24 ± 1	90 to 240  20 to 27	90 to 250  20 to 27	-- -- --
<b>Frequency (Hz)</b> (For Vac)	50 ± 0.2 60 ± 0.2	49 to 51 59 to 61	48 to 52 58 to 62	-- --


\* The maximum moisture rating only applies up to 40 °C (104 °F). For higher temperatures, the RH specification is derated to maintain constant moisture content.

## 2.3 Model Number Interpretation

### Introduction

Write your controller's model number in the spaces provided below and circle the corresponding items in each table. This information will also be useful when you wire your controller.

Figure 2-1 Model Number Interpretation



51-51-16U-79  
Issue 17  
Page 1 of 3

### UDC2500 Universal Digital Controller

#### Model Selection Guide

**New! Easy To Use UDC2500 1/4 DIN Single Loop Controller**

The UDC2500 Controller packs new powerful features while retaining all the simplicity, flexibility and the industry standard HMI of the UDC2300 Controller that it replaces. Many new optional features include:

- NEMA 4X, IP66 Front Face
- Built-in infrared communications port for configuring with a Pocket PC or Laptop
- PC Based Configuration Tools
- Ethernet Communications
- Limit Model Available
- Thermocouple Health Monitoring
- Accutune III (Fast/Slow, Heat/Cool)

**Instructions**

- Select the desired key number. The arrow to the right marks the selection available.
- Make the desired selections from Tables I through VI using the column below the proper arrow. A dot (•) denotes availability.

Key Number    I    II    III    IV    V    VI

-  -  -  -  -  -

**KEY NUMBER - UDC2500 Single Loop Controller**

Description	Selection	Availability
Digital Controller for use with 90 to 250Vac Power	DC2500	↓
Digital Controller for use with 24Vac/dc Power	DC2501	↓

**TABLE I - Specify Control Output and/or Alarms**

Output #1	Description	0 _	C _	E _	A _	T _	R _
	None (Can be used as an indicator only)	•	•	•	•	•	•
	Current Output (4 to 20ma, 0 to 20 ma)	•	•	•	•	•	•
	Electro Mechanical Relay (5 Amp Form C)	•	•	•	•	•	•
	Solid State Relay (1 Amp)	•	•	•	•	•	•
	Open Collector transistor output	•	•	•	•	•	•
	Dual 2 Amp Relays (Both are Form A) (Heat/Cool Applications)	•	•	•	•	•	•
Output #2 and Alarm #1 or Alarms 1 and 2	No Additional Outputs or Alarms	_ 0	•	•	•	•	•
	One Alarm Relay Only	_ B	•	•	•	•	•
	E-M Relay (5 Amp Form C) Plus Alarm 1 (5 Amp Form C Relay)	_ E	•	•	•	•	•
	Solid State Relay (1 Amp) Plus Alarm 1 (5 Amp Form C Relay)	_ A	•	•	•	•	•
	Open Collector Plus Alarm 1 (5 Amp Form C Relay)	_ T	•	•	•	•	•

**TABLE II - Communications and Software Selections**

Communications	Description	0 _ _ _	1 _ _ _	2 _ _ _	3 _ _ _
	None	•	•	•	•
	Auxiliary Output/Digital Inputs (1 Aux and 1 DI or 2 DI)	•	•	•	•
	RS-485 Modbus Plus Auxiliary Output/Digital Inputs	•	•	•	•
	10 Base-T Ethernet (Modbus RTU) Plus Auxiliary Output/Digital Inputs	•	•	•	•
Software Selections	Standard Functions, Single Display	_ 0 _ _	•	•	•
	Dual Display with Auto/Manual	_ A _ _	•	•	•
	Set Point Programming (12 Segments) Dual Display, Auto/Manual	_ B _ _	•	•	•
	Limit Controller (Includes Dual Display Option)	_ L _ _	a	a	a
Reserved	No Selection	_ _ 0 _	•	•	•
Infrared interface	None	_ _ _ 0	•	•	•
	Infrared Interface Included (Can be used with a Pocket PC)	_ _ _ R	•	•	•

51-51-16U-79  
 Issue 17  
 Page 2 of 3

**TABLE III - Input 1 can be changed in the field using external resistors**

Input	Options	Availability	
		DC 2500	2501
Input 1	TC, RTD, mV, 0-5V, 1-5V	1 _ _	• •
	TC, RTD, mV, 0-5V, 1-5V, 0-20mA, 4-20mA	2 _ _	• •
	TC, RTD, mV, 0-5V, 1-5V, 0-20mA, 4-20mA, 0-10V	3 _ _	• •
Input 2	None	_ 00	• •
	0-5V, 1-5V, 0-20mA, 4-20mA	_ 10	b b

**TABLE IV - Options**

Option	Description	Availability	
		DC 2500	2501
Approvals	CE, UL and CSA (Standard)	0 _ _ _	• •
	CE, UL, CSA and FM	1 _ _ _	c c
	CE Only	2 _ _ _	• •
Tags	None	_ 0 _ _	• •
	Stainless Steel Customer ID Tag - 3 lines w/22 characters/line	_ T _ _	• •
Future Options	None	_ _ 0 _	• •
	None	_ _ _ 0	• •
	None	_ _ _ _ 0	• •

**TABLE V - Product Manuals**

Manual	Description	Availability	
		DC 2500	2501
Manuals	Product Information on CD - English	0 _	• •
	English (Hard Copy) Manual (51-52-25-127)	E _	• •
	French (Hard Copy) Manual (51-52-25-127-FR)	F _	b b
	German (Hard Copy) Manual (51-52-25-127-DE)	G _	b b
	Italian (Hard Copy) Manual (51-52-25-127-IT)	I _	• •
	Spanish (Hard Copy) Manual (51-52-25-127-SP)	S _	b b
Certificate	None	_ 0	• •
	Certificate of Conformance (F3391)	_ C	• •

**TABLE VI**

Selection	Description	Availability
No Selection	None	0 • •

**RESTRICTIONS**

Restriction Letters	Available Only With		Not Available With	
	Table	Selection	Table	Selection
a	I	E _		
	I	A _		
	I	T _		
Limit Controller Restrictions/Comments:				
1. FM approved units with communications are limited to read only.				
2. UL listed for regulatory use only.				
b			II	_ L _ _
c	II	_ L _ _	I	C _ , R _

**ORDERING INSTRUCTIONS: These are provide as guidance for ordering such as those listed**

1. Part numbers are provided to facilitate Distributor Stock.
2. Orders may be placed either by model selection or by part number.
3. Part numbers are shown within the model selection tables to assist with compatibility information.
4. Orders placed by model selection are systematically protected against incompatibility.
5. Compatibility assessment is the responsibility of the purchaser for orders placed by part number.
6. Items labeled as N/A are not available via the stocking program and must be ordered by model selection.



# UDC2500

## Universal Digital Controller

## Supplemental Accessories & Kits

Description		Part Number
Bezel Assembly and Bezel Gasket		51453143-501
Display/Keyboard (with IR)		51452758-502
Dual Display with Auto/Manual		50004634-501
SPP (includes Dual Display, Auto/Manual)		50004634-502
Power/Output PWA with 2 E-M Relays (90-264 Vac Operation)		51452822-502
Power/Output PWA with 2 E-M Relays (24 Vac/dc Operation)		51452822-503
Auxiliary Output/Digital Input/RS-422/485 Communications PWA		51452810-501
Auxiliary Output/Digital Input/Ethernet Communications PWA		51452816-501
MCU/Inputs PWA (with 2nd Input and IR) for Controllers		51452801-503
MCU/Inputs PWA (with IR) for Limit Controllers		51452801-504
Electro-Mechanical Relay		30755306-501
Open Collector Output PWA		30756679-501
Solid State Relay		30756725-501
Current Output PWA		51452804-501
Dual Electromechanical Relay PWA		51452807-501
Ethernet Adaptor Board Kit		50009071-501
Case Assembly (including Mounting Kit with four brackets)		51452759-501
Varistor (MOV) 120 Vac		30732481-501
Varistor (MOV) 240 Vac		30732481-502
4-20 mA Input Resistor Assembly (250 ohm)		30731996-506
0-10 Volt Input Resistor Assembly (100K pair)		30754465-501
Mounting Kits (12 Brackets)		51452763-501
DIN Adaptor Kit		30755223-003
Process Instrument Explorer Software for UDC2500		50001619-001
Panel Bracket Kit		50004821-501
Configuration Cable Kit (used when IR is not specified)		46188694-501
Product Information on CD	All Languages	51453375-501
Quick Start Manual (2 page) Standard & Limit Controller	English	51-52-25-124
Product Manual	English	51-52-25-127
Limit Controller Manual	English	51-52-25-118

## 2.4 Control and Alarm Relay Contact Information

### Control Relays

**ATTENTION**  
 Control relays operate in the standard control mode (that is, energized when output state is on).

**Table 2-2 Control Relay Contact Information**

Unit Power	Control Relay Wiring	Control Relay Contact	Output #1 or #2 Indicator Status
<b>Off</b>	N.O.	Open	<b>Off</b>
	N.C.	Closed	
<b>On</b>	N.O.	Open	<b>Off</b>
		Closed	<b>On</b>
	N.C.	Closed	<b>Off</b>
		Open	<b>On</b>

### Alarm Relays

**ATTENTION**  
 Alarm relays are designed to operate in a failsafe mode (that is, de-energized during alarm state). This results in alarm actuation when power is OFF or when initially applied, until the unit completes self diagnostics. If power is lost to the unit, the alarms will de-energize and thus the alarm contacts will close.

**Table 2-3 Alarm Relay Contact Information**

Unit Power	Alarm Relay Wiring	Variable NOT in Alarm State		Variable in Alarm State	
		Relay Contact	Indicators	Relay Contact	Indicators
<b>Off</b>	N.O.	Open	<b>Off</b>	Open	<b>Off</b>
	N.C.	Closed		Closed	
<b>On</b>	N.O.	Closed	<b>Off</b>	Open	<b>On</b>
	N.C.	Open		Closed	

## 2.5 Mounting

### Physical Considerations

The controller can be mounted on either a vertical or tilted panel using the mounting kit supplied. Adequate access space must be available at the back of the panel for installation and servicing activities.

- Overall dimensions and panel cutout requirements for mounting the controller are shown in Figure 2-2.
- The controller's mounting enclosure must be grounded according to CSA standard C22.2 No. 0.4 or Factory Mutual Class No. 3820 paragraph 6.1.5.
- The front panel is moisture rated NEMA3 and IP55 rated and can be easily upgraded to NEMA4X and IP66.

### Overall Dimensions

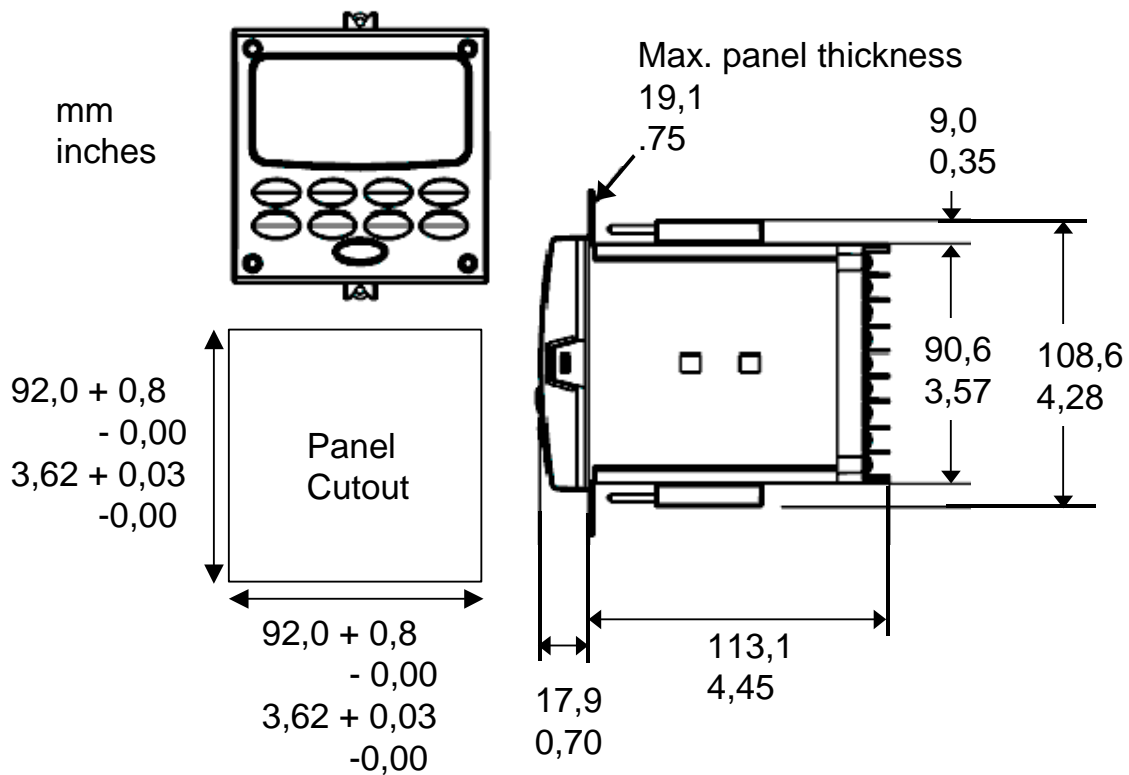


Figure 2-2 Mounting Dimensions (not to scale)

## Mounting Method

Before mounting the controller, refer to the nameplate on the outside of the case and make a note of the model number. It will help later when selecting the proper wiring configuration.

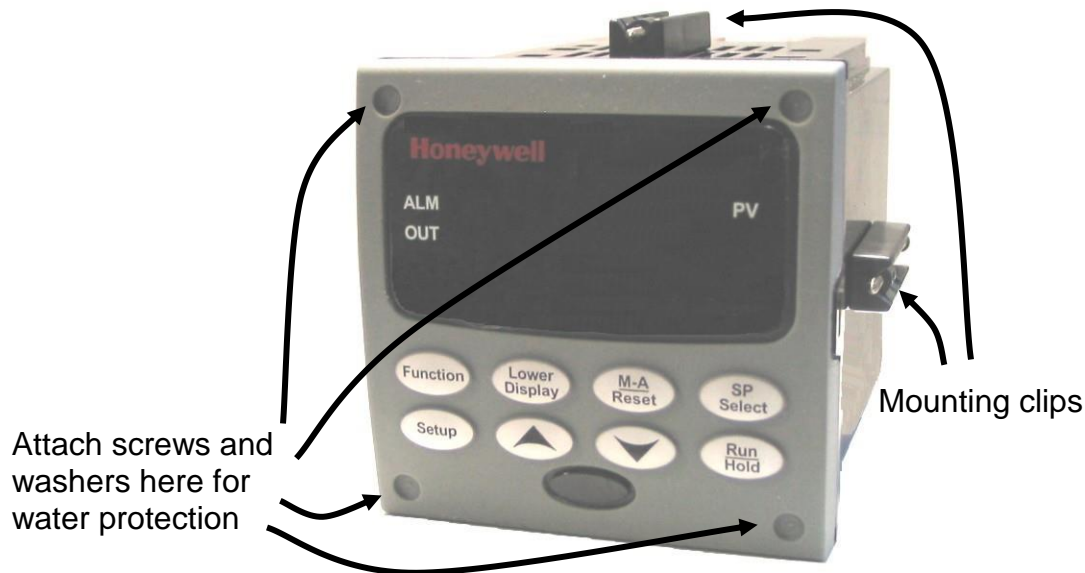


Figure 2-3 Mounting Methods

## Mounting Procedure

Table 2-4 Mounting Procedure

Step	Action
1	Mark and cut out the controller hole in the panel according to the dimension information in Figure 2-2.
2	Orient the case properly and slide it through the panel hole from the front.
3	Remove the mounting kit from the shipping container and install the kit as follows: <ul style="list-style-type: none"> <li>For normal installation two mounting clips are required. Insert the prongs of the clips into the two holes in the top and bottom center of the case (Figure 2-3).</li> <li>For water-protected installation four mounting clips are required. There are two options of where to install the mounting clips: 1) Insert the prongs of the clips into the two holes on the left and right side of the top and bottom of the case or 2) on the center on each of the four sides (Figure 2-3).</li> <li>Tighten screws to 2 lb-inch (22 N•cm) to secure the case against the panel. CAUTION: Over tightening will cause distortion and the unit may not seal properly.</li> </ul>
4	For water-protected installation, install four screws with washers into the four recessed areas in the corners of the front bezel (Figure 2-3). Push the point of the screw through the center piercing the elastomeric material and then tighten screws to 5 lb-in (56 N•cm).

## 2.6 Wiring

### 2.6.1 Electrical Considerations

#### Line voltage wiring

This controller is considered “rack and panel mounted equipment” per EN61010-1, Safety Requirements for Electrical Equipment for Measurement, Control, and Laboratory Use, Part 1: General Requirements. Conformity with 72/23/EEC, the Low Voltage Directive requires the user to provide adequate protection against a shock hazard. The user shall install this controller in an enclosure that limits OPERATOR access to the rear terminals.

#### Mains Power Supply

This equipment is suitable for connection to 90 to 250 Vac or to 24 Vac/dc 50/60 Hz, power supply mains. It is the user’s responsibility to provide a switch and non-time delay (North America), quick-acting, high breaking capacity, Type F (Europe), 1/2A, 250V fuse(s), or circuit-breaker for 90-250 Vac applications; or 1 A, 125 V fuse or circuit breaker for 24 Vac/dc applications, as part of the installation. The switch or circuit-breaker shall be located in close proximity to the controller, *within easy reach of the OPERATOR*. The switch or circuit-breaker shall be marked as the disconnecting device for the controller.



**Applying 90-250 Vac to an instrument rated for 24 Vac/dc will severely damage the instrument and is a fire and smoke hazard.**

When applying power to multiple instruments, make certain that sufficient current is supplied. Otherwise, the instruments may not start up normally due to the voltage drop caused by the in-rush current.

#### Controller Grounding

PROTECTIVE BONDING (grounding) of this controller and the enclosure in which it is installed shall be in accordance with National and Local electrical codes. To minimize electrical noise and transients that may adversely affect the system, supplementary bonding of the controller enclosure to a local ground, using a No. 12 (4 mm<sup>2</sup>) copper conductor, is recommended.

#### Control/Alarm Circuit Wiring

The insulation of wires connected to the Control/Alarm terminals shall be rated for the highest voltage involved. Extra Low Voltage (ELV) wiring (input, current output, and low voltage Control/Alarm circuits) shall be separated from HAZARDOUS LIVE (>30 Vac, 42.4 V<sub>peak</sub>, or 60 V<sub>dc</sub>) wiring per Permissible Wiring Bundling, Table 2-5.

#### Electrical Noise Precautions

Electrical noise is composed of unabated electrical signals which produce undesirable effects in measurements and control circuits.



Digital equipment is especially sensitive to the effects of electrical noise. Your controller has built-in circuits to reduce the effect of electrical noise from various sources. If there is a need to further reduce these effects:

- *Separate External Wiring*—Separate connecting wires into bundles (See Permissible Wiring Bundling - Table 2-5) and route the individual bundles through separate conduit metal trays.  
*Use Suppression Devices*—For additional noise protection, you may want to add suppression devices at the external source. Appropriate suppression devices are commercially available.

#### ATTENTION

For additional noise information, refer to document number 51-52-05-01, *How to Apply Digital Instrumentation in Severe Electrical Noise Environments*.

### Permissible Wiring Bundling

**Table 2-5 Permissible Wiring Bundling**

Bundle No.	Wire Functions
1	<ul style="list-style-type: none"> <li>• Line power wiring</li> <li>• Earth ground wiring</li> <li>• Line voltage control relay output wiring</li> <li>• Line voltage alarm wiring</li> </ul>
2	<p><b>Analog</b> signal wire, such as:</p> <ul style="list-style-type: none"> <li>• Input signal wire (thermocouple, 4 to 20 mA, etc.)</li> <li>• 4-20 mA output signal wiring</li> </ul> <p><b>Digital</b> input signals</p>
3	<ul style="list-style-type: none"> <li>• Low voltage alarm relay output wiring</li> <li>• Low voltage wiring to solid state type control circuits</li> <li>• Low voltage wiring to open collector type control circuits</li> </ul>

## 2.7 Wiring Diagrams

### Identify Your Wiring Requirements

To determine the appropriate diagrams for wiring your controller, refer to the model number interpretation in this section. The model number of the controller is on the outside of the case.

### Universal Output Functionality and Restrictions

Instruments with multiple outputs can be configured to perform a variety of output types and alarms. For example, an instrument with one current output and two relays can be configured to provide any one of the following:

- 1) Current Simplex with two alarm relays
- 2) Current Duplex 100% with two alarm relays
- 3) Time Simplex with one alarm relay
- 4) Time Duplex with no alarm relays
- 5) Three Position Step Control with no alarm relays

These selections may all be made via the keyboard and by wiring to the appropriate output terminals; there are no internal jumpers or switches to change. This flexibility allows a customer to stock a single instrument which is able to handle a variety of applications.

Table 2-6 shows what control types and alarms are available based upon the installed outputs. In this table, when Duplex Control and Reverse Action are configured:

**Output 1 is HEAT and Output 2 is COOL.**

In Table 2-6 when Three Position Step Control is configured:

**Output 1 is OPEN and Output 2 is CLOSE.**

In Table 2-6 the **Output 1/2** option **Single Relay** can be any of the following selections: Electro-Mechanical Relay, Solid-State Relay or Open Collector Output.

Table 2-6 Universal Output Functionality and Restrictions

Output Algorithm Type	Output 1/2 Option	Function of Output 1/2	Function of Other Outputs		
			Output #3	Output #4	Auxiliary Output
Time Simplex	Single Relay	Output 1	Alarm 2	Alarm 1	Not Needed
	Current Output	INU	Output 1	Alarm 1	Not Needed
	Dual Relay	Output 1	Alarm 2	Alarm 1	Not Needed
Time Duplex or TPSC	Single Relay	Output 1	Output 2	Alarm 1	Not Needed
	Current Output	INU	Output 2	Output 1	Not Needed
	Dual Relay	Outputs 1 and 2	Alarm 2	Alarm 1	Not Needed
Current Simplex	Single Relay	INU	Alarm 2	Alarm 1	Output 1
	Current Output	Output 1	Alarm 2	Alarm 1	Not Needed
	Dual Relay	INU	Alarm 2	Alarm 1	Output 1
Current Dup. 100% Current = COOL and HEAT	Single Relay	INU	Alarm 2	Alarm 1	Outputs 1 and 2
	Current Output	Outputs 1 and 2	Alarm 2	Alarm 1	Not Needed
	Dual Relay	INU	Alarm 2	Alarm 1	Outputs 1 and 2
Current Duplex 50% Current = HEAT Aux Out = COOL	Single Relay	N/A	N/A	N/A	N/A
	Current Output	Output 1	Alarm 2	Alarm 1	Output 2
	Dual Relay	N/A	N/A	N/A	N/A
Current/Time Current = COOL Time = HEAT	Single Relay *	Output 1	Output 2	Alarm 1	Output 2
	Current Output	Output 2	Output 2	Alarm 1	Not Needed
	Dual Relay *	Outputs 1 & 2	Alarm 2	Alarm 1	Output 2
Time/Current Time = COOL Current = HEAT	Single Relay *	Output 1	Output 2	Alarm 1	Output 1
	Current Output	Output 1	Output 2	Alarm 1	Not Needed
	Dual Relay *	Outputs 1 & 2	Alarm 2	Alarm 1	Output 1

TPSC = Three Position Step Control

N/A = Not Available – This output algorithm type cannot be performed with this Output 1/2 option.

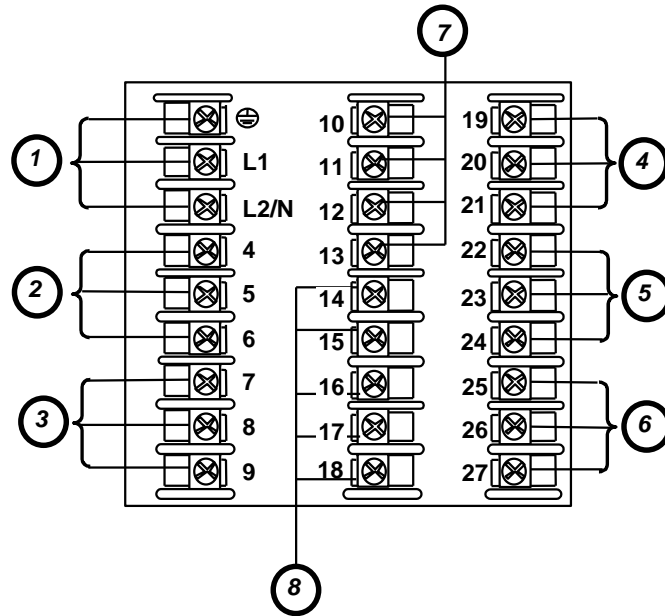
INU = Installed, Not Used – The installed Output 1/2 option is not used for the configured output algorithm type.

Not Needed = Auxiliary Output is Not Needed to provide the desired output algorithm and can be used for another purpose. With the proper configuration, Auxiliary Output could also be used as a substitute for the Current Output

\* To obtain this output algorithm type with these Output 1/2 Options: 1) Configure the OUTALG selection as “TIME D”; 2) Configure Auxiliary Output for “OUTPUT” and; 3) Scale the Auxiliary Output as necessary for the desired output algorithm type. For these selections, the Output 1 (HEAT) and Output 2 (COOL) signals will be present both on the Auxiliary Output and on the two relays normally used for Time Duplex.

## Wiring the Controller

Using the information contained in the model number, select the appropriate wiring diagrams from the composite wiring diagram below. Refer to the individual diagrams listed to wire the controller according to your requirements.



See table for callout details

**Figure 2-4 Composite Wiring Diagram**

Callout	Details
1	AC/DC Line Voltage Terminals. See Figure 2-5.
2	Output 3 Terminals. See Figure 2-8 through Figure 2-14.
3	Output 4 Terminals. See Figure 2-8 through Figure 2-14.
4	Outputs 1 and 2 Terminals. See Figure 2-8 through Figure 2-14.
5	Input #2 Terminals. See Figure 2-7.
6	Input #1 Terminals. See Figure 2-6.
7	Aux. Output and Digital Inputs Terminals. See Figure 2-18.
8	Communications Terminals. See Figure 2-16 and Figure 2-17.

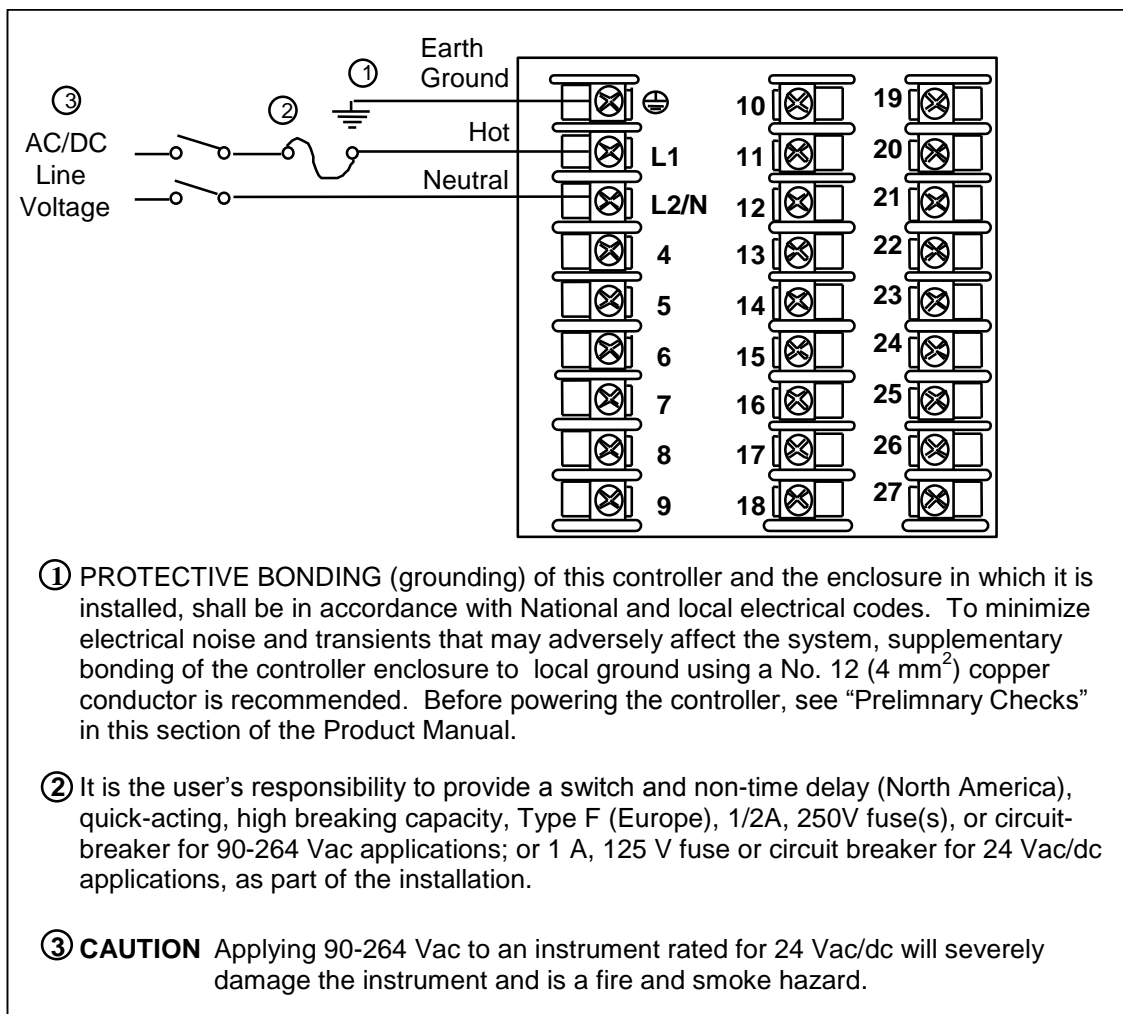


Figure 2-5 Mains Power Supply

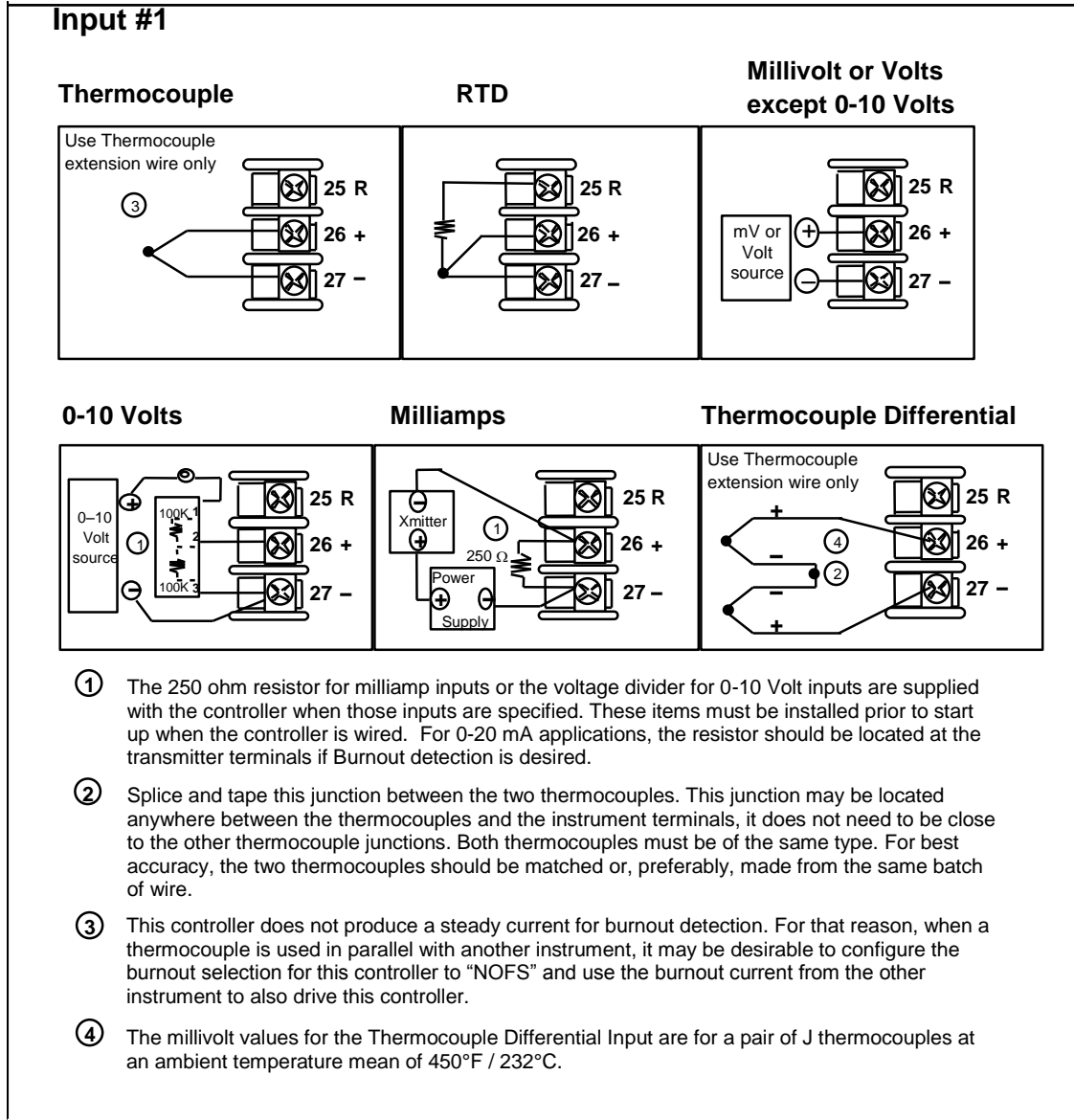


Figure 2-6 Input 1 Connections

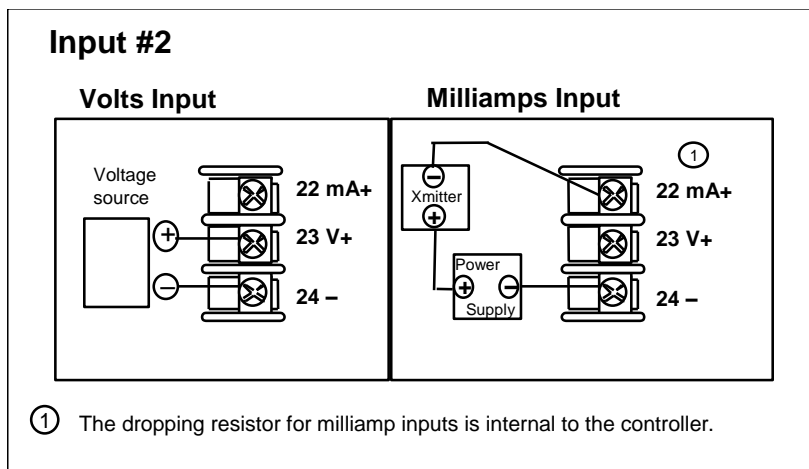


Figure 2-7 Input 2 Connections

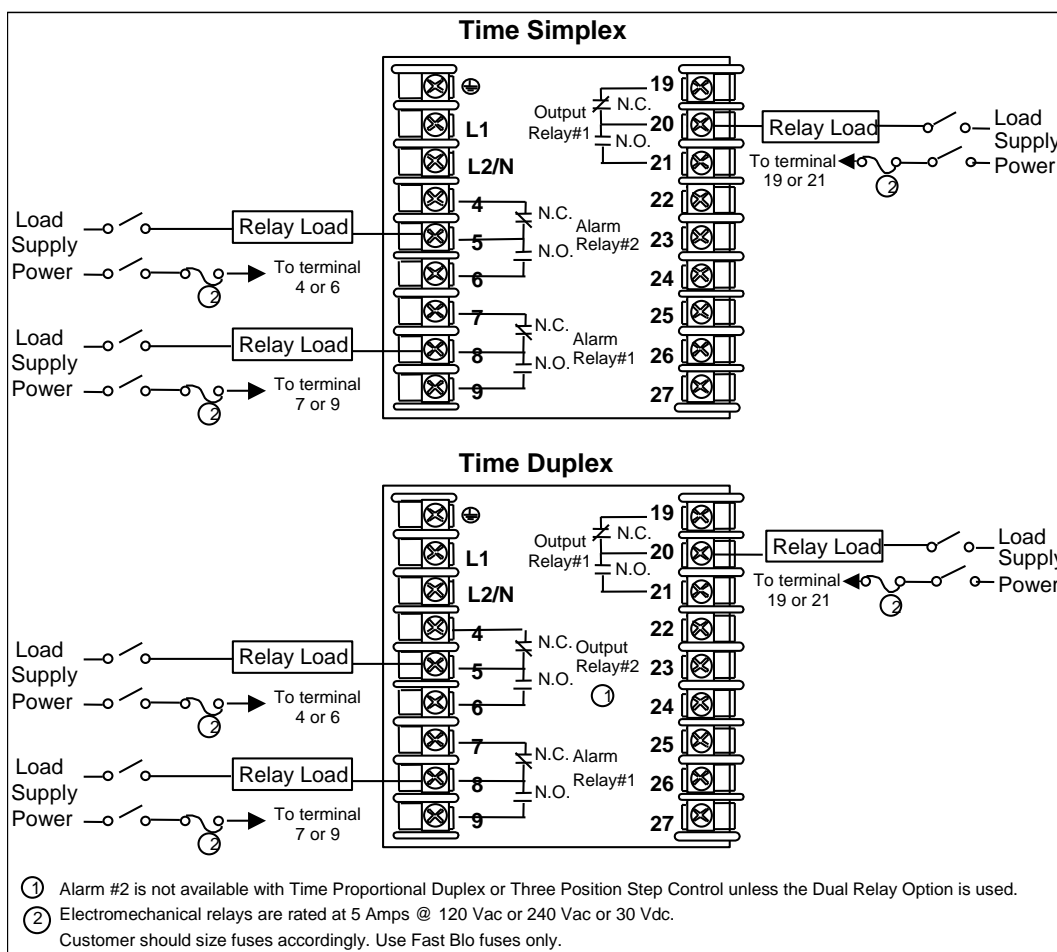
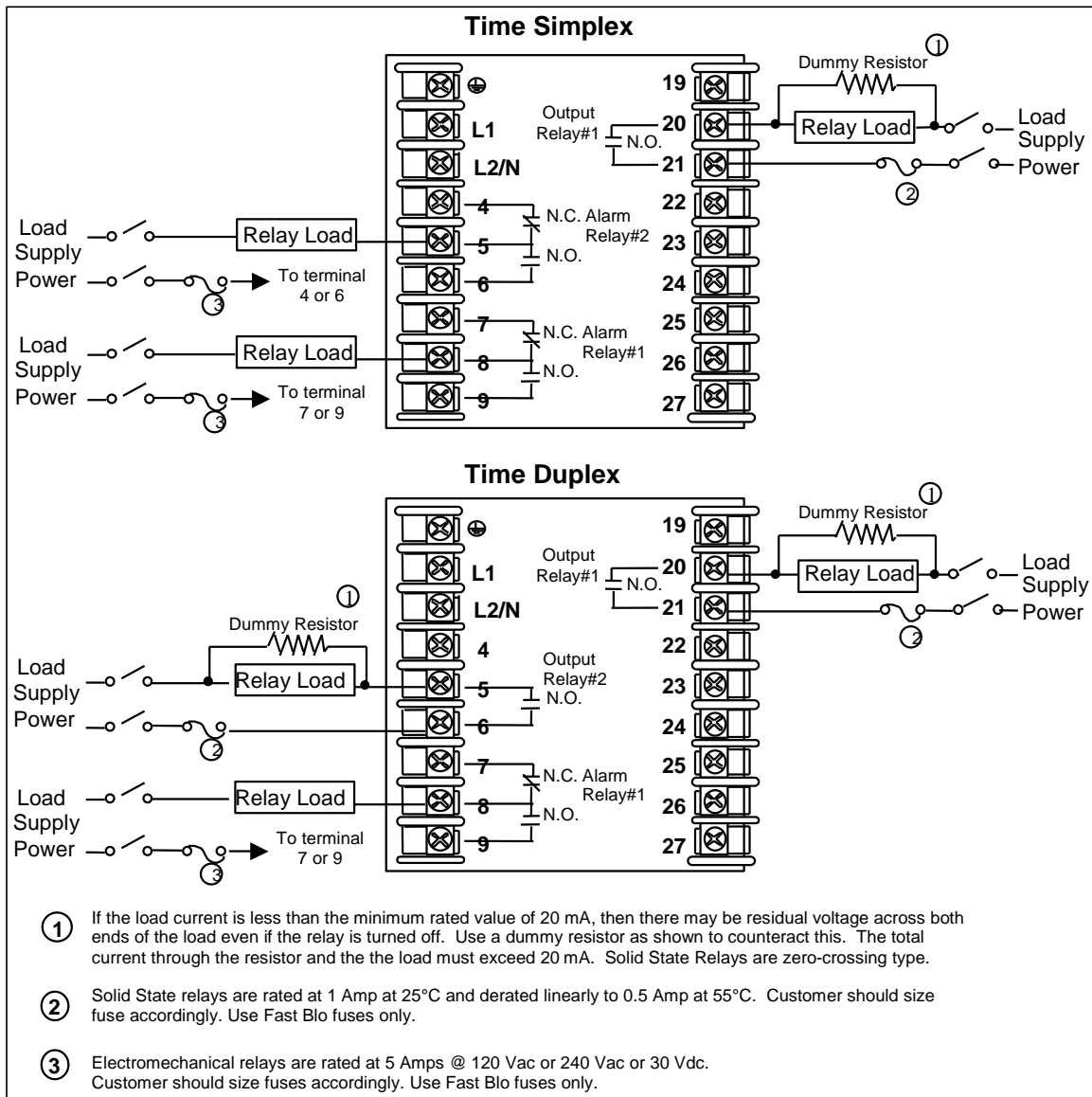


Figure 2-8 Electromechanical Relay Output

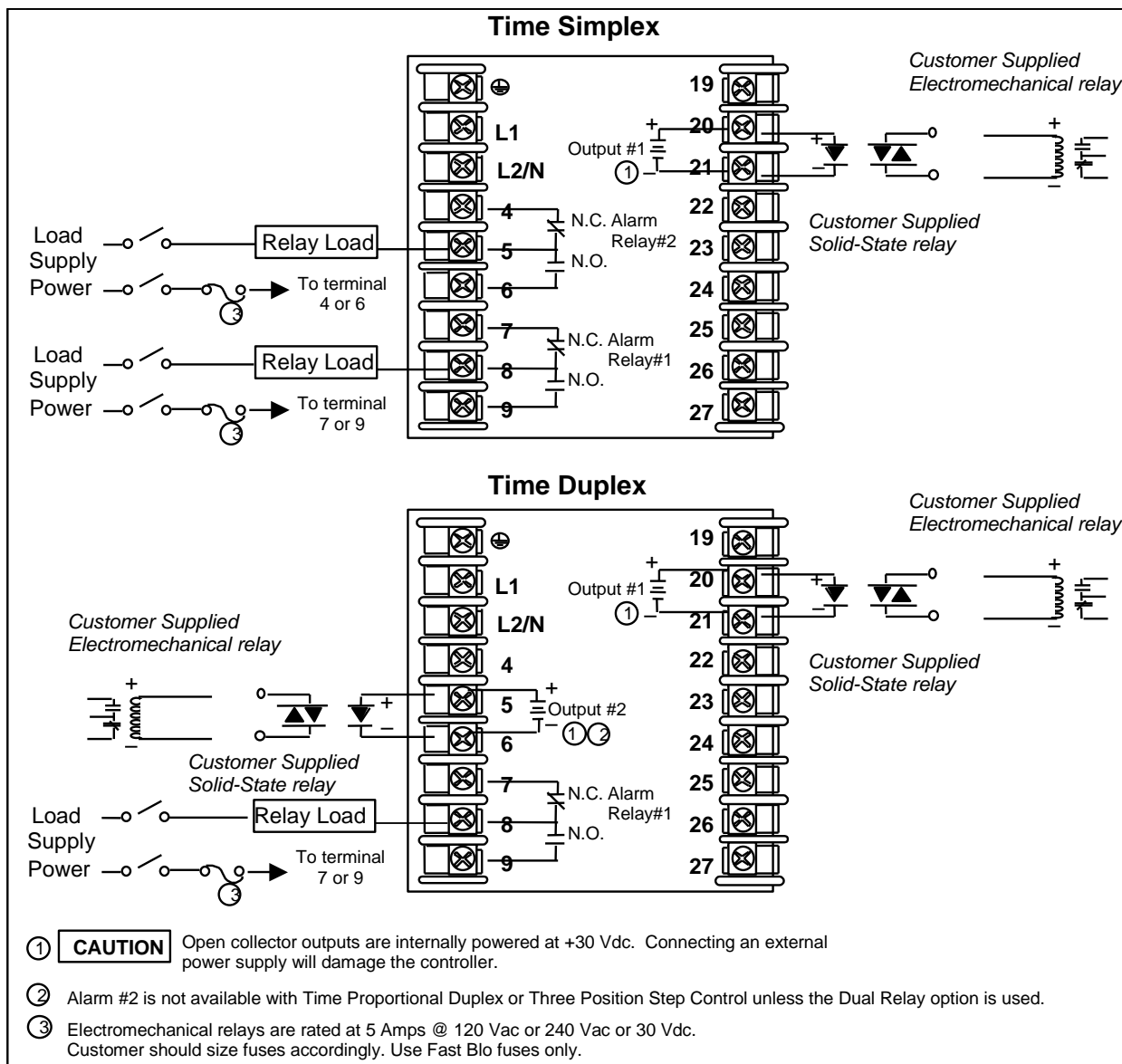
See Table 2-6 for relay terminal connections for other Output Algorithm Types.



**Figure 2-9 Solid State Relay Output**

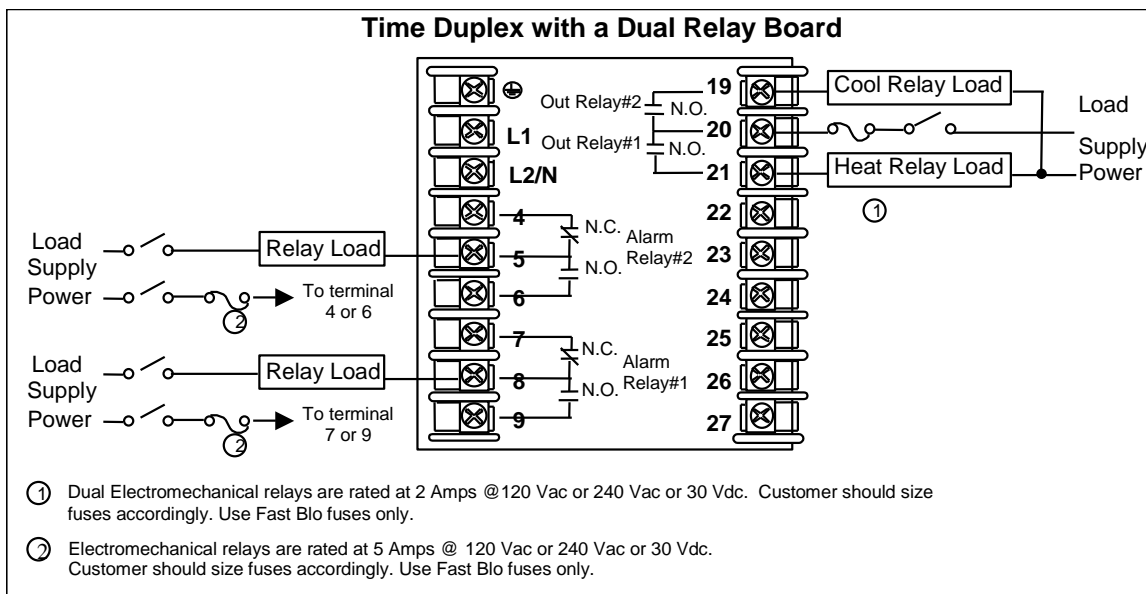
See Table 2-6 for relay terminal connections for other Output Algorithm Types.





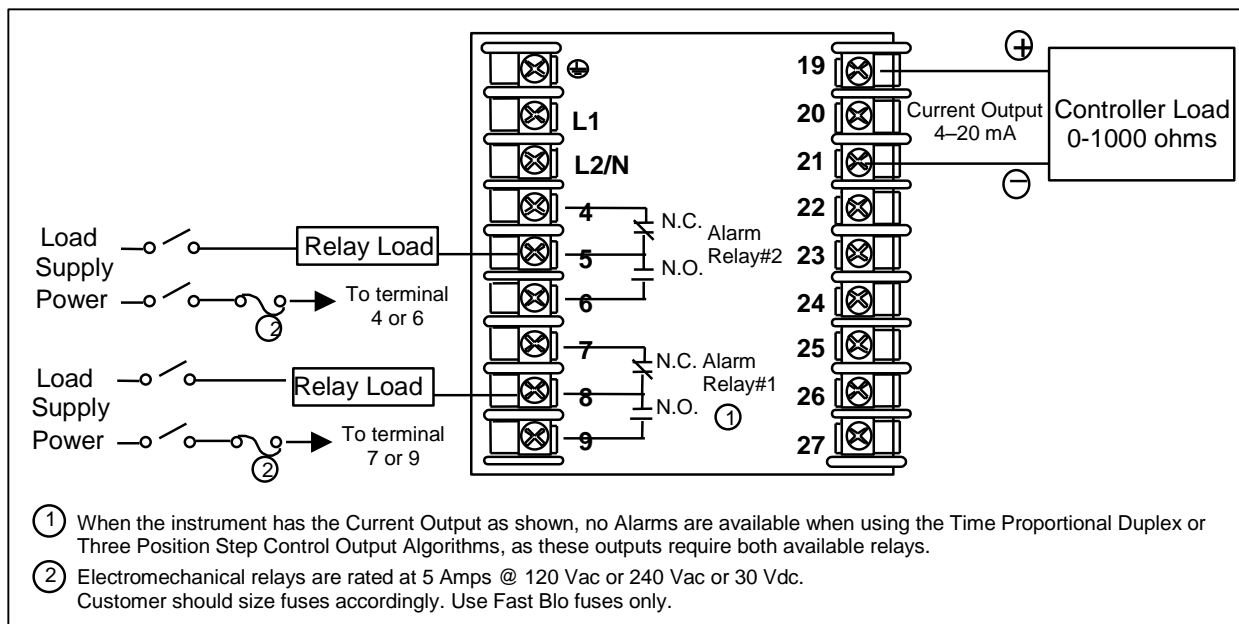
**Figure 2-10 Open Collector Output**

See Table 2-6 for relay terminal connections for other Output Algorithm Types.



**Figure 2-11 Dual Electromechanical Relay Option Output**

See Table 2-6 for relay terminal connections for other Output Algorithm Types.



**Figure 2-12 Current Output**

See Table 2-6 for relay terminal connections for other Output Algorithm Types.

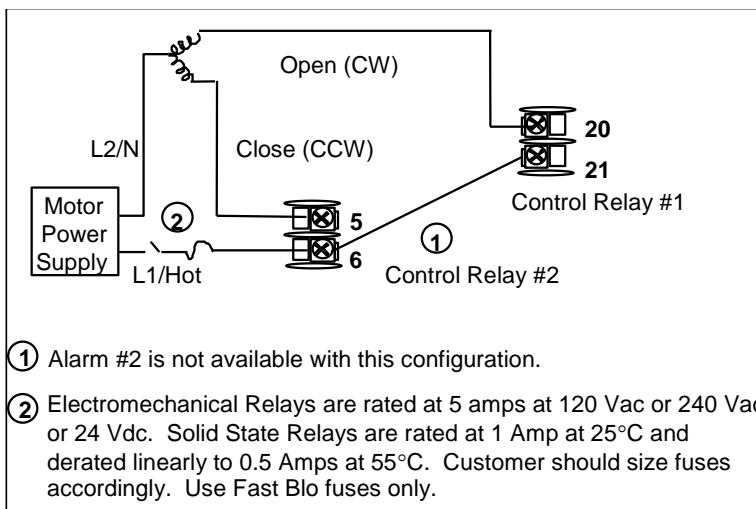


Figure 2-13 Three Position Step Control Connections for DC250-EE, Double Relays

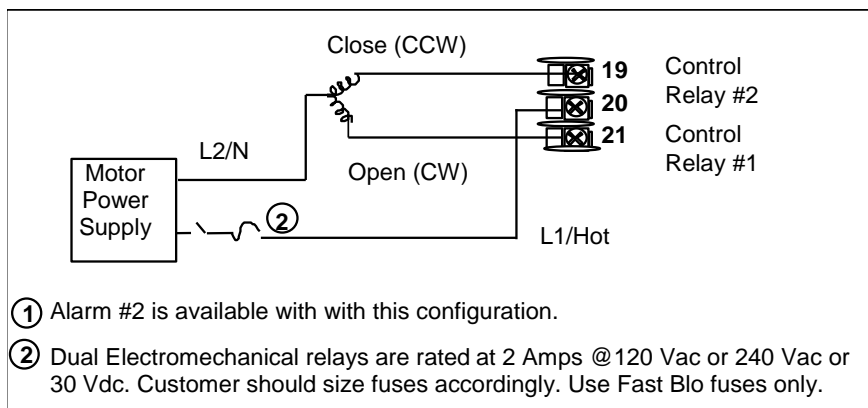


Figure 2-14 Three Position Step Control for DC250-RX, Dual Relay Option

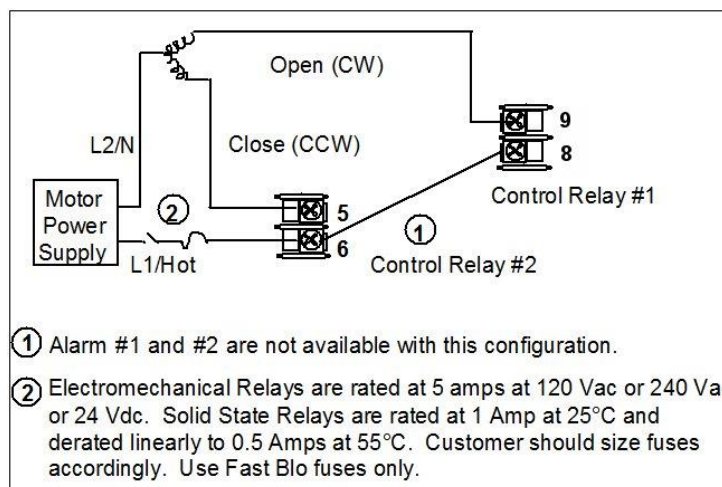


Figure 2-15 Three Position Step Control for DC2500-CE, Current Output with Relay

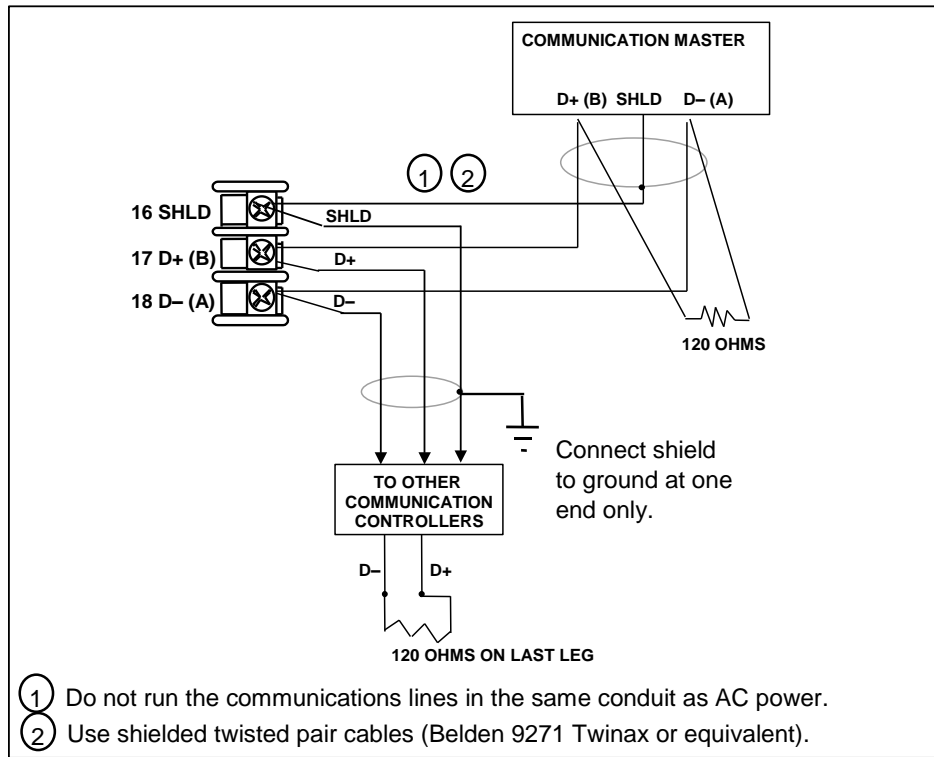


Figure 2-16 RS-422/485 Communications Option Connections

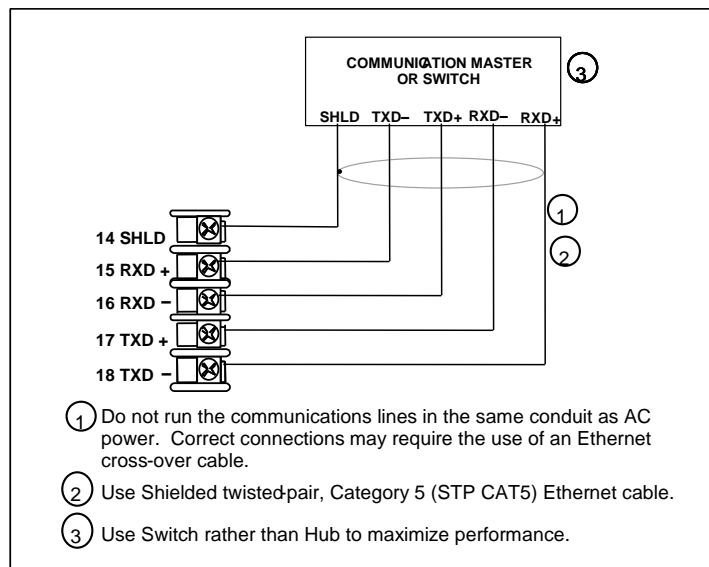


Figure 2-17 Ethernet Communications Option Connections

Figure Figure 2-17 and Table 2-7 shows how to connect a UDC to a MDI Compliant Hub or Switch utilizing a **straight-through cable** or for connecting a UDC to a PC utilizing a **crossover cable**.

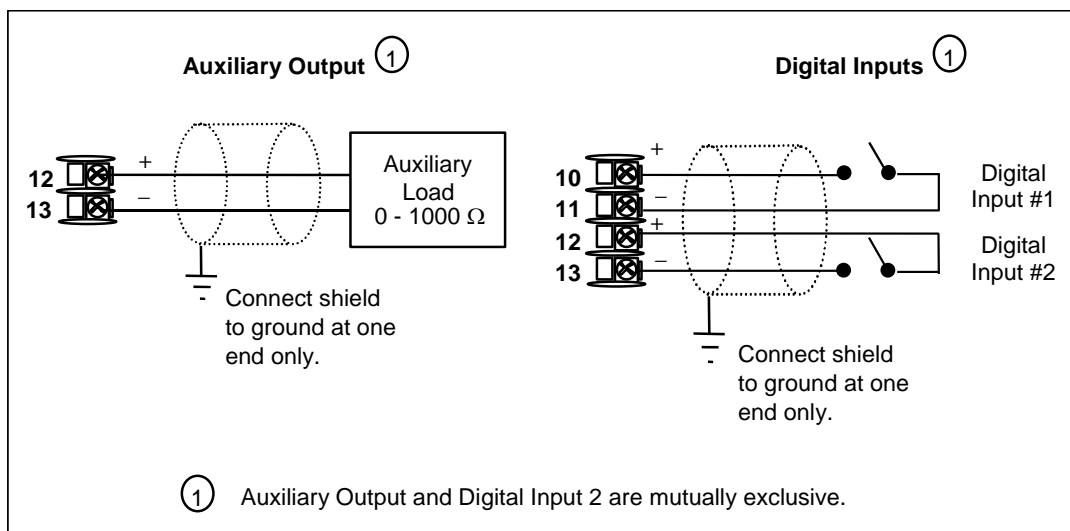
Table 2-7 Terminals for connecting a UDC to a MDI Compliant Hub or Switch

UDC Terminal	UDC Signal Name	RJ45 Socket Pin #	Switch Signal Name
Position 14	Shield	Shield	Shield
Position 15	RXD-	6	TXD-
Position 16	RXD+	3	TXD+
Position 17	TXD-	2	RXD-
Position 18	TXD+	1	RXD+

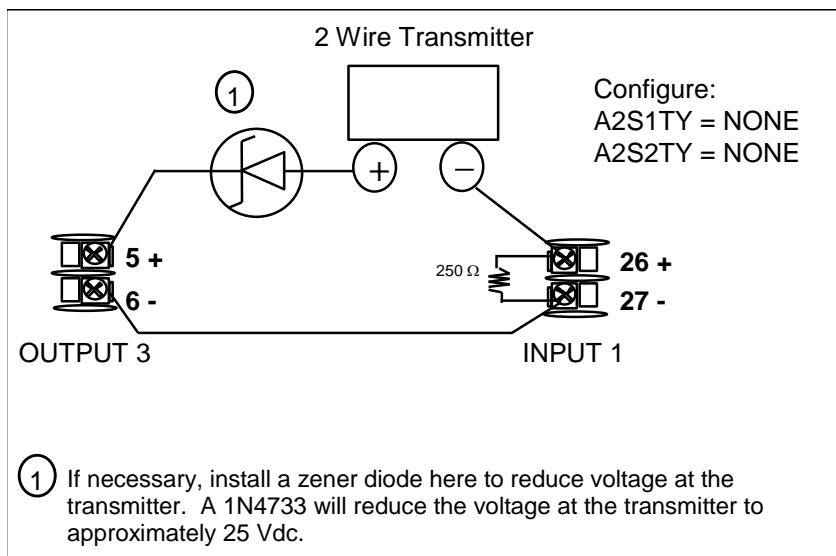
Table 2-8 shows how to connect a UDC directly to a PC utilizing a straight-through cable (wiring the UDC cable this way makes the necessary cross-over connections)

**Table 2-8 Terminals for connecting a UDC directly to a PC utilizing a straight-through cable**

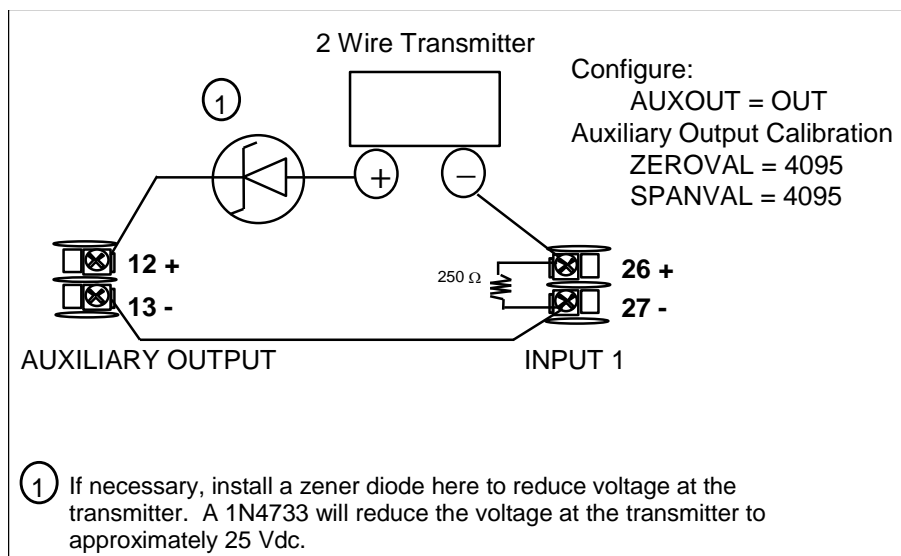
UDC Terminal	UDC Signal Name	RJ45 Socket Pin #	PC Signal Name
Position 14	Shield	Shield	Shield
Position 15	RXD-	2	TXD-
Position 16	RXD+	1	TXD+
Position 17	TXD-	6	RXD-
Position 18	TXD+	3	RXD+



**Figure 2-18 Auxiliary Output and Digital Inputs Option Connections**



**Figure 2-19 Transmitter Power for 4-20 mA — 2 wire Transmitter Using Open Collector Alarm 2 Output**



**Figure 2-20 Transmitter Power for 4-20 mA — 2 Wire Transmitter Using Auxiliary Output**

## 3 Configuration

### 3.1 Overview

#### Introduction

Configuration is a dedicated operation where you use straightforward keystroke sequences to select and establish (configure) pertinent control data best suited for your application.

To assist you in the configuration process, there are prompts that appear in the upper and lower displays. These prompts let you know what group of configuration data (Set Up prompts) you are working with and also, the specific parameters (Function prompts) associated with each group.

Table 3-1 shows an overview of the prompt hierarchy as it appears in the controller.

#### What's in this section?

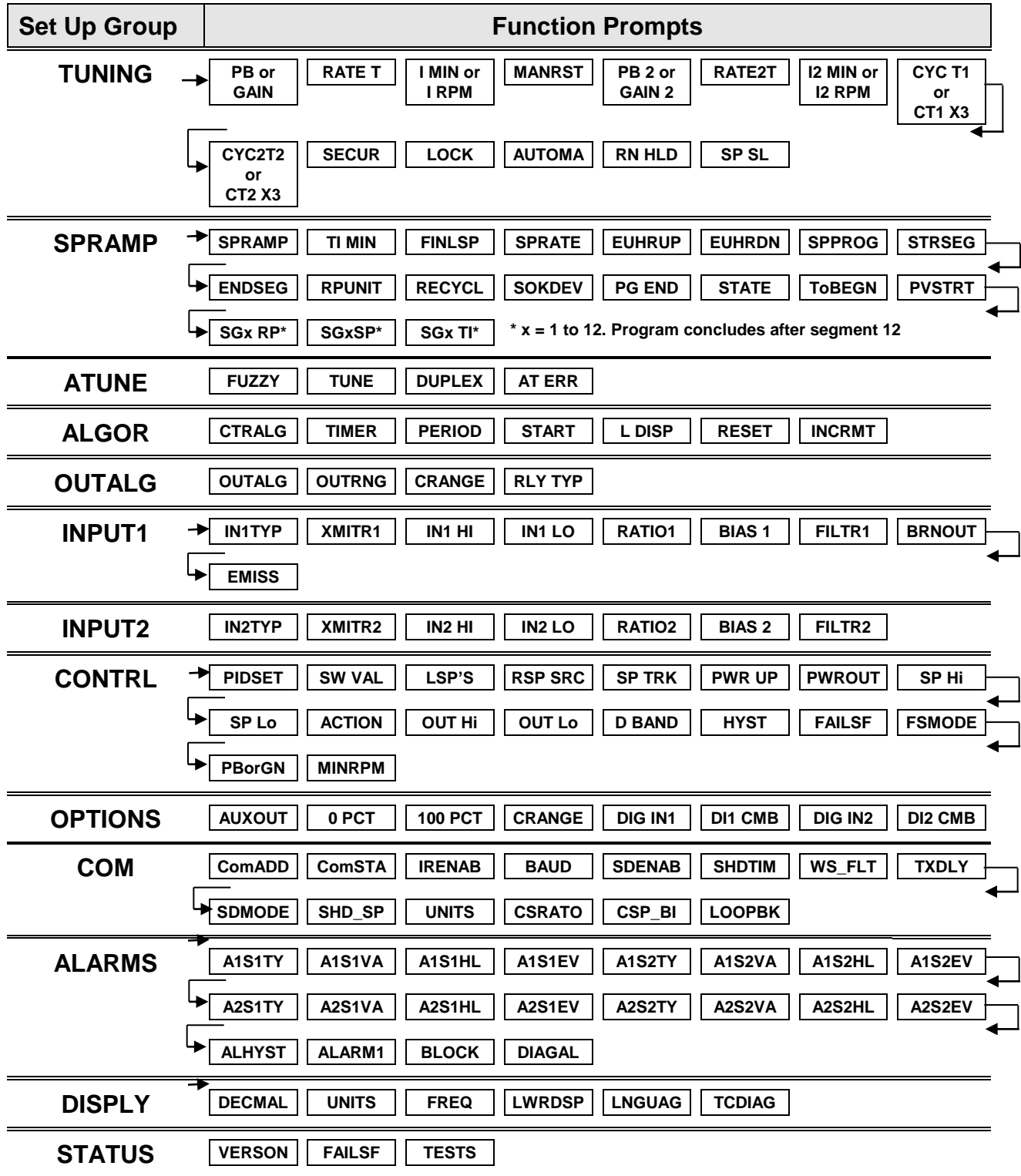
The following topics are covered in this section.

**Table 3-1 Configuration Topics**

TOPIC	See Page
3.1 Overview	33
3.2 Configuration Prompt Hierarchy	34
3.3 Configuration Procedure	35
3.4 Tuning Set Up Group	36
3.5 SP Ramp Set Up Group	39
3.6 Accutune Set Up Group	44
3.7 Algorithm Set Up Group	47
3.8 Output Set Up Group	52
3.9 Input 1 Set Up Group	56
3.10 Input 2 Set Up Group	60
3.11 Control Set Up Group	62
3.12 Options Set Up Group	68
3.13 Communications Set Up Group	74
3.14 Alarms Set Up Group	77
3.15 Display Set Up Group	83
3.16 P.I.E. Tool Ethernet and Email Configuration Screens	85
3.17 Configuration Record Sheet	88

### 3.2 Configuration Prompt Hierarchy

Table 3-2 Configuration Prompt Hierarchy





### 3.3 Configuration Procedure

#### Introduction

Each of the Set Up groups and their functions are pre-configured at the factory. The factory settings are shown in Table 3-4 through Table 3-14 that follow this procedure.








If you want to change any of these selections or values, follow the procedure in Table 3-3. This procedure tells you the keys to press to get to any Set Up group and any associated Function parameter prompt.

#### Procedure

**ATTENTION**

The prompting scrolls at a rate of 2/3 seconds when the **SET UP** or **FUNCTION** key is held in. Also, ▲ or ▼ keys will move group prompts forward or backward at a rate twice as fast.

**Table 3-3 Configuration Procedure**

Step	Operation	Press	Result
1	Enter Set Up Mode		<i>Upper Display</i> = <b>SET</b> <i>Lower Display</i> = <b>TUNING</b> (This is the first Set Up Group title)
2	Select any Set Up Group		Sequentially displays the other Set Up group titles shown in the prompt hierarchy in Table 3-2 Configuration Prompt Hierarchy. You can also use the ▲ or ▼ keys to scan the Set Up groups in both directions. Stop at the Set Up group title that describes the group of parameters you want to configure. Then proceed to the next step.
3	Select a Function Parameter		<i>Upper Display</i> = the current value or selection for the first function prompt of the selected Set Up group. <i>Lower Display</i> = the first Function prompt within that Set Up group. Sequentially displays the other function prompts of the Set Up group you have selected. Stop at the function prompt that you want to change, then proceed to the next step.
4	Change the Value or Selection	 or 	Increments or decrements the value or selection that appears for the selected function prompt. If you change the value or selection of a parameter while in Set Up mode then decide not to enter it, press <b>M-A RESET</b> once—the original value or selection is recalled.
5	Enter the Value or Selection		Enters value or selection made into memory after another key is pressed.
6	Exit Configuration		Exits configuration mode and returns controller to the same state it was in immediately preceding entry into the Set Up mode. It stores any changes you have made. If you do not press any keys for 30 seconds, the controller times out and reverts to the mode and display used prior to entry into Set Up mode.

### 3.4 Tuning Set Up Group

#### Introduction

Tuning consists of establishing the appropriate values for the tuning constants you are using so that your controller responds correctly to changes in process variable and setpoint. You can start with predetermined values but you will have to watch the system to see how to modify them. The Accutune feature automatically selects Gain, Rate, and Reset on demand.

#### ATTENTION

Because this group contains functions that have to do with security and lockout, we recommend that you configure this group last, after all other configuration data has been loaded.

#### Function Prompts

Table 3-4 TUNING Group (Numeric Code 100) Function Prompts

Function Prompt Lower Display		Selection or Range of Setting Upper Display		Parameter Definition
English	Numeric Code	English	Numeric Code	
<b>PB or GAIN</b>	<b>101</b>	PB = 0.1 to 1000 % Gain = 0.01 to 1000		<p><b>PROPORTIONAL BAND</b> (simplex) is the percent of the range of the measured variable for which a proportional controller will produce a 100 % change in its output.</p> <p><b>GAIN</b> is the ratio of output change (%) over the measured variable change (%) that caused it.</p> $G = \frac{100\%}{PB\%}$ <p>where PB is the proportional band (in %)</p> <p>If the PB is 20 %, then the Gain is 5. And, at those settings, a 3 % change in the error signal (SP-PV) will result in a 15 % change in the controller's output due to proportional action. If the Gain is 2, then the PB is 50 %.</p> <p>Also defined as "HEAT" Gain on Duplex models for variations of Heat/Cool applications.</p> <p><i>The selection of Proportional Band or Gain is made in the CONTROL parameter group under prompt PBoRGAIn.</i></p>
<b>RATE T</b>	<b>102</b>	0.00 to 10.00 minutes 0.08 or less = OFF		<p><b>RATE</b> action, in minutes, affects the controller's output whenever the deviation is changing; and affects it more when the deviation is changing faster.</p>

Function Prompt Lower Display		Selection or Range of Setting Upper Display		Parameter Definition
English	Numeric Code	English	Numeric Code	
				Also defined as "HEAT" Rate on Duplex models for variations of Heat/Cool applications.
<b>I MIN</b> or <b>I RPM</b>	<b>103</b>	0.02 to 50.00  0.02 to 50.00		<p><b>I MIN</b> = Reset in Minutes per Repeat</p> <p><b>I RPM</b> = Reset in Repeats per Minute</p> <p><b>Integral Time</b> (or <b>Reset</b>) adjusts the controller's output in accordance with both the size of the deviation (SP–PV) and the time that it lasts. The amount of the corrective action depends on the value of Gain. The Reset adjustment is measured as how many times proportional action is repeated per minute or how many minutes before one repeat of the proportional action occurs.</p> <p>Used with control algorithm PID-A or PID-B. Also defined as "HEAT" Reset on Duplex models for variations of Heat/Cool applications.</p> <p><b>ATTENTION</b> The selection of whether Minutes per Repeat or Repeats per Minute is used is made in the CONTRL parameters group under the prompt <b>MINorRPM</b>.</p>
<b>MANRST</b>	<b>104</b>	-100 to 100 % Output		<p><b>MANUAL RESET</b> is only applicable if you use control algorithm PD WITH MANUAL RESET in the Algorithm Set Up group. Because a proportional controller will not necessarily line out at setpoint, there will be a deviation (offset) from setpoint. This eliminates the offset and lets the PV line out at setpoint.</p> <p><b>ATTENTION</b> Bias is shown on the lower display.</p>
<b>PB 2 or GAIN 2</b>	<b>105</b>	PB = 0.1 to 1000 % Gain = 0.01 to 1000		<p><b>PROPORTIONAL BAND 2</b> or <b>GAIN 2</b>, <b>RATE 2</b>, and <b>RESET 2</b> parameters are the same as previously described for "Heat" except that they refer to the <b>cool</b> zone tuning constants on duplex models or the second set of PID constants, whichever is pertinent.</p>
<b>RATE2T</b>	<b>106</b>	0.00 to 10.00 minutes 0.08 or less = OFF		<p>This is the same as above except that it applies to Duplex models for the "COOL" zone of Heat/Cool applications or for the second set of PID constants.</p>

Function Prompt Lower Display		Selection or Range of Setting Upper Display		Parameter Definition
English	Numeric Code	English	Numeric Code	
<b>I2 MIN or I2 RPM</b>	<b>107</b>	0.02 to 50.00  0.02 to 50.00		These are the same as above except that they apply to Duplex models for the "COOL" zone of Heat/Cool applications or for the second set of PID constants.
<b>CYC T1 or CT1 X3</b>	<b>108</b>	1 to 120		<p><b>CYCLE TIME (HEAT)</b> determines the length of one time proportional output relay cycle. Defined as "HEAT" cycle time for Heat/Cool applications.</p> <p><b>CYC T1</b>—Electromechanical relays <b>CT1 X3</b>—Solid state relays</p> <p><b>ATTENTION</b> <i>Cycle times are in either second or 1/3-second increments depending upon the configuration of RLYTYP in the Output Algorithm Set Up group.</i></p>
<b>CYC2T2 or CT2 X3</b>	<b>109</b>	1 to 120		<p><b>CYCLE TIME 2 (COOL)</b> is the same as above except it applies to Duplex models as the cycle time in the "COOL" zone of Heat/Cool applications or for the second set of PID constants.</p> <p><b>CYC2T2</b>—Electromechanical relays <b>CT2 X3</b>—Solid state relays</p> <p><b>ATTENTION</b> <i>Cycle times are in either second or 1/3-second increments depending upon the configuration of RLYTYP in the Output Algorithm Set Up group.</i></p>
<b>SECUR</b>	<b>110</b>	0 to 9999		<p><b>SECURITY CODE</b>—The level of keyboard lockout may be changed in the Set Up mode. Knowledge of a security code may be required to change from one level to another. This configuration should be copied and kept in a secure location.</p> <p>NOTE: The Security Code is for keyboard entry only and is not available via communications.</p> <p><b>ATTENTION</b> <i>Can only be changed if LOCK selection is NONE.</i></p>
<b>LOCK</b>	<b>111</b>	NONE	0	<p><b>LOCKOUT</b> applies to one of the functional groups: Configuration, Calibration, Tuning, Accutune. <b>DO NOT CONFIGURE UNTIL ALL CONFIGURATION IS COMPLETE.</b></p> <p><b>NONE</b>—No lockout; all groups are read/write.</p>

Function Prompt Lower Display		Selection or Range of Setting Upper Display		Parameter Definition
English	Numeric Code	English	Numeric Code	
		CAL	1	<p><b>CALIBRATION</b>—All groups are available for read/write except for the Calibration and Keyboard Lockout groups.</p> <p><b>+ CONFIGURATION</b>—Tuning, SP Ramp, and Accutune groups are read/write. All other groups are read only. Calibration and Keyboard Lockout groups are not available.</p> <p><b>+ VIEW</b>—Tuning and Setpoint Ramp parameters are read/write. No other parameters are viewable.</p> <p><b>ALL</b>—Tuning and Setpoint Ramp parameters are available for read only. No other parameters are viewable.</p>
		CONF	2	
		VIEW	3	
		ALL	4	
<b>AUTOMA</b>	<b>112</b>	DIS ENAB	0 1	<p><b>MANUAL/AUTO KEY LOCKOUT</b>—Allows you to disable the Manual/Auto key.</p> <p><b>DISABLE</b> <b>ENABLE</b></p> <p><b>ATTENTION</b> <i>Can only be viewed if LOCKOUT is configured for NONE.</i></p>
<b>RN HLD</b>	<b>114</b>	DIS ENAB	0 1	<p><b>RUN/HOLD KEY LOCKOUT</b>—Allows you to disable the Run/Hold key, for either SP Ramp or SP Program. <i>The Run/Hold key is never disabled when used to acknowledge a latched alarm 1 or a Diagnostic Message.</i></p> <p><b>DISABLE</b> <b>ENABLE</b></p> <p><b>ATTENTION</b> <i>Can only be viewed if LOCKOUT is configured for NONE.</i></p>
<b>SP SEL</b>	<b>115</b>	DIS ENAB	0 1	<p><b>SETPOINT SELECT KEY LOCKOUT</b>—Allows you to disable the Setpoint Select key.</p> <p><b>DISABLE</b> <b>ENABLE</b></p> <p><b>ATTENTION</b> <i>Can only be viewed if LOCKOUT is configured for NONE.</i></p>

### 3.5 SP Ramp Set Up Group

#### Introduction

Set Point Ramp, Set Point Programs and Set Point Rates can be configured in this group.

A single *Setpoint Ramp* [SP RAMP] can be configured to occur between the current local setpoint and a final local setpoint over a time interval of from 1 to 255 minutes.

A *Set Point Rate* [SPRATE] lets you configure a *specific rate of change* for any local setpoint change.

A single *Set Point Program* [SP PROG] with up to 12 segments can be configured.

For more information on Set Point Rate, Ramp and Programming, see Sections 4.18 through 4.21.

You can start and stop the ramp/program using the **RUN/HOLD** key.

*PV Hot Start* is a configurable feature and means that, at initialization, the setpoint is set to the current PV value and the Ramp or Rate or Program then starts from this value.

#### Function Prompts

**Table 3-5 SPRAMP Group (Numeric Code 200) Function Prompts**

Function Prompt Lower Display		Selection or Range of Setting Upper Display		Parameter Definition
English	Numeri c Code	English	Numeric Code	
<b>SP RAMP</b> <i>SP Program must be disabled for SP Ramp prompts to appear</i>	<b>201</b>	DIS ENAB	0 1	<p><b>SINGLE SETPOINT RAMP</b>—Make a selection to enable or disable the setpoint ramp function. Make sure you configure a ramp time and a final setpoint value.</p> <p><i>SP Programming must be disabled.</i></p> <p><b>DISABLE SETPOINT RAMP</b>—Disables the setpoint ramp option.</p> <p><b>ENABLE SETPOINT RAMP</b>—Allows the single setpoint ramp prompts to be shown.</p>
<b>TI MIN</b>	<b>202</b>	0 to 255 minutes		<p><b>SETPOINT RAMP TIME</b>—Enter the number of minutes desired to reach the final setpoint. A ramp time of “0” implies an immediate change of setpoint.</p>

Function Prompt Lower Display		Selection or Range of Setting Upper Display		Parameter Definition
English	Numeri c Code	English	Numeric Code	
<b>FINLSP</b>	<b>203</b>	Enter a value within the setpoint limits		<p><b>SETPOINT RAMP FINAL SETPOINT</b>—Enter the value desired for the final setpoint. The controller will operate at the setpoint set here when ramp is ended.</p> <p><b>ATTENTION</b> If the ramp is on HOLD, the held setpoint can be changed by the ▲ and ▼ keys. However, the ramp time remaining and original ramp rate is not changed. Therefore, when returning to RUN mode, the setpoint will ramp at the same rate as previous to the local setpoint change and will stop if the final setpoint is reached before the time expires. If the time expires before the final setpoint is reached, it will jump to the final setpoint.</p> <p><b>ATTENTION</b> SP RAMP and SP RATE will cause the SP portion of Accutune to abort. PV Tune will continue to function normally. Ramp is placed into HOLD while tuning (TUNE configuration).</p>
<p><b>SPRATE</b></p> <p><i>SP Rate operates only when neither SP Ramp or SP Programming is running or when SP Ramp and SP Programming are disabled</i></p>	<b>204</b>	<p>DIS</p> <p>ENAB</p>	<p>0</p> <p>1</p>	<p><b>SETPOINT RATE</b>—Lets you configure a specific rate of change for any local setpoint change.</p> <p><b>DISABLE SETPOINT RATE</b>—Disables the setpoint rate option.</p> <p><b>ENABLE SETPOINT RATE</b>—Allows the SP rate feature.</p>
<b>EUHRUP</b>	<b>205</b>	0 to 9999 in Engineering units per hour		<p><b>RATE UP</b>—Rate up value. When making a setpoint change, this is the rate at which the controller will change from the original setpoint up to the new one. The ramping (current) setpoint can be viewed as SPn in the lower display.</p> <p>Entering a 0 will imply an immediate change in Setpoint (i.e., no rate applies).</p>

Function Prompt Lower Display		Selection or Range of Setting Upper Display		Parameter Definition
English	Numeric Code	English	Numeric Code	
<b>EUHRDN</b>	<b>206</b>	0 to 9999 in Engineering units per hour		<b>RATE DOWN</b> —Rate down value. When making a setpoint change, this is the rate at which the controller will change from the original setpoint down to the new one. The ramping (current) setpoint can be viewed as SPn in the lower display.  Entering a 0 will imply an immediate change in Setpoint (i.e., no rate applies).
<b>SPPROG</b> (optional feature)  <i>SP Ramp must be disabled for SP Program prompts to appear. If SP Rate is enabled, it does not operate while an SP Program is running.</i>	<b>207</b>	DIS ENAB	0 1	<b>SETPOINT RAMP/SOAK PROGRAM</b> —Available only with controllers that contain this option.  <i>SP RAMP must be disabled.</i>  <b>DISABLE</b> —Disables setpoint programming. <b>ENABLE</b> —Enables setpoint programming.  <b>ATTENTION</b> Detailed information for the prompts for SP Programming may be found in <i>Section 4.21 – Setpoint Programming</i> . The listing below is only for reference purposes.
<b>STRSEG</b>	<b>208</b>	1 to 11		Start Segment Number
<b>ENDSEG</b>	<b>209</b>	2 to 12 (always end in a soak segment) SOK 2 SOK 4 SOK 6 SOK 8 SOK 10 SOK 12	2 4 6 8 10 12	End Segment Number
<b>RPUNIT</b>	<b>210</b>	TIME EU-M EU-H	0 1 2	Engineering Units for Ramp Segments  <b>TIME</b> in hours:minutes <b>RATE</b> in Engineering units per minute <b>RATE</b> in Engineering units per hour
<b>RECYCL</b>	<b>211</b>	0 to 100 recycles		Number of Program Recycles
<b>SOKDEV</b>	<b>212</b>	0 to 100		Guaranteed Soak Deviation Value
<b>PG END</b>	<b>213</b>	<b>LAST</b> (Hold at last SP) <b>FSAF</b> (Manual mode/failsafe)	0 1	Program Termination State



Function Prompt Lower Display		Selection or Range of Setting Upper Display		Parameter Definition
English	Numeri c Code	English	Numeric Code	
<b>STATE</b>	<b>214</b>	DIS HOLD	0 1	Program State at Program End
<b>ToBEGN</b>	<b>215</b>	DIS KEY (Keyboard)	0 1	Reset/Rerun SP Program
<b>PVSTRT</b>	<b>216</b>	DIS ENAB	0 1	<b>DISABLE</b> —LSP1 is used as the initial ramp setpoint. <b>ENABLE</b> —Current PV value is used as the initial ramp setpoint.
<b>SG1 RP</b> <b>SG3 RP</b> <b>SG5 RP</b> <b>SG7 RP</b> <b>SG9 RP</b> <b>SG11 RP</b>	<b>217</b> <b>220</b> <b>223</b> <b>226</b> <b>229</b> <b>232</b>	0-99hours:0- 59minutes Engineering Units/minute or Engineering Units /hour		Segment #1 Ramp Time or Segment #1 Ramp Rate  <b>Select TIME, EU-M, or EU-H at prompt RPUNIT. All ramps will use the same selection.</b>
<b>SG2 SP</b> <b>SG4 SP</b> <b>SG6 SP</b> <b>SG8 SP</b> <b>SG10SP</b> <b>SG12SP</b>	<b>218</b> <b>221</b> <b>224</b> <b>227</b> <b>230</b> <b>233</b>	Enter a Value within the Setpoint Limits		Soak Segments Setpoint Value
<b>SG2 TI</b> <b>SG4 TI</b> <b>SG6 TI</b> <b>SG8 TI</b> <b>SG10TI</b> <b>SG12TI</b>	<b>219</b> <b>222</b> <b>225</b> <b>228</b> <b>231</b> <b>234</b>	0-99 Hours:0-59 Minutes		Soak Segments Duration

## 3.6 Accutune Set Up Group

### Introduction

*Accutune III* automatically calculates GAIN, RATE, and RESET TIME (PID) tuning constants for your control loop. When initiated on demand, the Accutune algorithm measures a process step response and automatically generates the PID tuning constants needed for no overshoot on your process.

*Fuzzy*, Fuzzy Overshoot Suppression: When enabled, this configuration will suppress or eliminate any overshoot that may occur as a result of the existing tuning parameters, as the PV approaches the setpoint.

*Tune*, Demand Tuning: The tuning process is initiated through the operator interface keys or via a digital input (if configured). The algorithm then calculates new tuning parameters and enters them in the tuning group. *Tune* will operate with PIDA, PIDB, PD+MR and Three Position Step Control algorithms.

*SP*, SP Tuning: SP tuning continuously adjusts the PID parameters in response to setpoint changes. You can select tuning on minimum setpoint changes of 5 % up to 15 % span. Perform SP tuning after you have configured the controller. SP Tuning does not operate with the Three Position Step Control algorithm.

*Simplex* Tuning is used when a Simplex Control Algorithm is configured and uses the current SP value and alters the output over the Output Limit Range.

*Duplex* Tuning is used when a Duplex Control Algorithm is configured. To perform a Duplex Tune, Two Local Setpoints must be configured per the Control Group in Section 3.11.

## Function Prompts

Table 3-6 ATUNE Group (Numeric Code 300) Function Prompts

Function Prompt Lower Display		Selection or Range of Setting Upper Display		Parameter Definition
English	Numeric Code	English	Numeric Code	
<b>FUZZY</b>	<b>301</b>	DIS	0	<p><b>FUZZY OVERSHOOT SUPPRESSION</b>—Can be enabled or disabled independently of whether Demand Tuning or SP Tuning is enabled or disabled.</p> <p><b>DISABLE</b>—Disables Fuzzy Overshoot Suppression.</p> <p><b>ENABLE</b>—The UDC uses Fuzzy Logic to suppress or minimize any overshoot that may occur when PV approaches SP. It will not recalculate any new tuning parameters.</p>
		ENAB	1	
<b>TUNE</b>	<b>302</b>	DIS TUNE	0 1	<p><b>ACCUTUNE III</b></p> <p><b>DISABLE</b> —Disables the Accutune function.</p> <p><b>DEMAND TUNING</b>—If TUNE is selected, and tuning is initiated through the operator interface or digital input (if configured), the algorithm calculates new tuning parameters and enters them into the tuning group. This tuning requires no process knowledge and does not require line out for initialization.</p>
<b>DUPLEX</b>	<b>303</b>	MANU		<p><b>DUPLEX ACCUTUNING III</b> – These prompts only appear when a duplex output type has been configured.</p> <p><b>MANUAL</b> – Tune manually using LSP 1 and LSP 2 values. LSP 1 is used to derive tuning parameters associated with HEAT (output &gt; 50 %). LSP 2 is used to derive tuning parameters associated with COOL (output &lt; 50 %).</p> <p><b>AUTOMATIC</b> – Tuning is performed automatically on both HEAT and COOL sequentially. LSP 1 is used for HEAT tuning and LSP 2 is used for COOL tuning. To initiate tuning, either LSP 1 or LSP 2 must be in use.</p>
		AUTO		

Function Prompt Lower Display		Selection or Range of Setting Upper Display		Parameter Definition
English	Numeric Code	English	Numeric Code	
		DIS		<b>DISABLE</b> – The current SetPoint is used to derive a single set of blended tuning parameters. This tuning is performed over the range of the output limits similar to Simplex Tuning. The Tuning Parameters derived are placed into both the HEAT and COOL tune sets (PID 1 and PID 2).
<b>AT ERR</b> (Read Only)	<b>304</b>	NONE	0	<b>ACCUTUNE ERROR STATUS</b> —When an error is detected in the Accutune process, an error prompt will appear  <b>NONE</b> —No errors occurred during last Accutune procedure.
		RUN	5	<b>RUNNING</b> —An Accutune process is still active checking process gain, even though “TUNE” is not lit. It does not affect keyboard operation.
		ABRT	4	<b>CURRENT ACCUTUNE PROCESS ABORTED</b> —Caused by one of the following conditions: <ul style="list-style-type: none"> <li>• changing to manual mode</li> <li>• digital input detected</li> <li>• in heat region of output but a cool output was calculated, or vice versa.</li> </ul>
		SP2	6	<b>SP2</b> —LSP2 not configured or a Setpoint other than LSP1 or LSP2 is in use.

### 3.7 Algorithm Set Up Group

#### Introduction

This data deals with various algorithms in the controller and Timer functions.

The Timer section allows you to configure a time-out period and to select the timer start by either the keyboard (**RUN/HOLD** key) or Alarm 2. An optional digital input can also be configured to the start the timer. The timer display is selectable as either “time remaining” (*see TREM*) or “elapsed time” (*see ET*).

Alarm 1 is activated at the end of the time-out period. When the timer is enabled, it has exclusive control of the alarm 1 relay—any previous alarm 1 configuration is ignored. At time-out, the timer is ready to be activated again by whatever action has been configured.

#### Function Prompts

Table 3-7 ALGOR Group (Numeric Code 400) Function Prompts

Function Prompt Lower Display		Selection or Range of Setting Upper Display		Parameter Definition
English	Numeric Code	English	Numeric Code	
<b>CTRALG</b>	<b>401</b>	ONOF	0	<p>The <b>CONTROL ALGORITHM</b> lets you select the type of control that is best for your process.</p> <p><b>ON/OFF</b> is the simplest control type. The output can be either ON (100 %) or OFF (0 %). The Process Variable (PV) is compared with the setpoint (SP) to determine the sign of the error (ERROR = PV–SP). The ON/OFF algorithm operates on the sign of the error signal.</p> <p>In Direct Acting Control, when the error signal is positive, the output is 100 %; and when the error signal is negative, the output is 0 %. If the control action is reverse, the opposite is true. An adjustable overlap (Hysteresis Band) is provided between the on and off states.</p> <p><b>ATTENTION</b> Other prompts affected: <i>OUTHYS</i></p>

Function Prompt Lower Display		Selection or Range of Setting Upper Display		Parameter Definition
English	Numeric Code	English	Numeric Code	
		PIDA	1	<p><b>DUPLEX ON/OFF</b> is an extension of this algorithm when the output is configured for Duplex. It allows the operation of a second ON/OFF output. There is a deadband between the operating ranges of the two inputs and an adjustable overlap (hysteresis) of the on and off states of each output. Both Deadband and Hysteresis are separately adjustable. With no relay action the controller will read 50 %.</p> <p><b>ATTENTION</b> <i>Other prompts affected: OUTHYS and DEADBD</i></p> <p><b>PID A</b> is normally used for three-mode control. This means that the output can be adjusted somewhere between 100 % and 0 %. It applies all three control actions—Proportional (P), Integral (I), and Derivative (D)—to the error signal.</p> <p><b>Proportional (Gain)</b>—Regulates the controller’s output in proportion to the error signal (the difference between Process Variable and Setpoint).</p> <p><b>Integral (Reset)</b>—Regulates the controller’s output to the size of the error and the time the error has existed. (The amount of corrective action depends on the value of proportional Gain.)</p> <p><b>Derivative (Rate)</b>—Regulates the controller’s output in proportion to the rate of change of the error. (The amount of corrective action depends on the value of proportional Gain.)</p>
		PIDB	2	<p><b>PID B</b>—Unlike the PID A equation, the controller gives only an integral response to a setpoint change, with no effect on the output due to the gain or rate action, and it gives full response to PV changes. Otherwise controller action is as described for the PID A equation. See note on PID A.</p>

Function Prompt Lower Display		Selection or Range of Setting Upper Display		Parameter Definition
English	Numeric Code	English	Numeric Code	
		PDMR	3	<p><b>PD WITH MANUAL RESET</b> is used whenever integral action is not wanted for automatic control. The equation is computed with no integral contribution. The MANUAL RESET, which is operator adjustable, is then added to the present output to form the controller output.</p> <p>Switching between manual and automatic mode will be bumpless.</p> <p>If you select PD with Manual Reset you can also configure the following variations:</p> <ul style="list-style-type: none"> <li>• PD (Two Mode) control,</li> <li>• P (Single Mode) control.</li> <li>• Set Rate (D) to 0.</li> </ul> <p><b>ATTENTION</b> <i>Other prompts affected: MANRST in the Tuning Set Up group</i></p>
		TPSC	4	<p><b>THREE POSITION STEP CONTROL (TPSC)</b>—The Three Position Step Control algorithm allows the control of a valve (or other actuator) with an electric motor driven by two controller relay outputs; one to move the motor upscale, the other downscale without a feedback slidewire linked to the motor shaft. The deadband is adjustable in the same manner as the duplex output algorithm.</p> <p>The Three Position Step Control algorithm provides an output display (OUT) which is an estimated motor position, since the motor is not using any slidewire feedback. Although this output indication is only an approximation, it is “corrected” each time the controller drives the motor to one of its stops (0 % or 100 %). It avoids all the control problems associated with the feedback slidewire (wear, dirt, noise). When operating in this algorithm, the estimated OUT display is shown to the nearest percent (i.e., no decimal).</p> <p>Refer to the <i>Operation</i> section for motor position displays.</p> <p>As a customer configurable option, when a second input board is installed, the motor slidewire can be connected to the controller.</p>

Function Prompt Lower Display		Selection or Range of Setting Upper Display		Parameter Definition
English	Numeric Code	English	Numeric Code	
		NONE	5	<p>The actual slidewire position is then shown on the lower display as POS. <b>This value is used for display only. It is NOT used in the Three Position Step algorithm.</b> To configure this option, set Input 2 actuation to SLIDEW. Calibrate the slidewire.</p> <p><b>ATTENTION</b> Other prompts affected: DEADB</p> <p>This configuration is usually used for Indicator applications. For this configuration, the PV value is percent of range becomes the control output value which is used by any configured control output type. When configured, the upper display shows the PV while the lower display is blank unless more than one analog input is configured, in which case the lower display shows the other analog inputs.</p>
<b>TIMER</b>	<b>402</b>	DIS ENAB	0 1	<p><b>TIMER</b> allows you to enable or disable the timer option.</p> <p>The timer option allows you to configure a timeout period and to select timer start by either the keyboard (RUN/HOLD key) or Alarm 2. A digital input can also be configured to start the timer.</p> <p>When the timer is enabled, it has exclusive control of the alarm 1 relay; any previous alarm configuration is ignored. At timeout, the timer is ready to be re-activated by whatever action has been configured. Alarm 1 is activated at the end of the timeout period.</p>
<b>PERIOD</b>	<b>403</b>	0:00 to 99:59 Select length of time in Hours and Minutes, or minutes and seconds.		<p><b>PERIOD</b> allows you to configure the length of timeout period (from 0 to 99 hours:59 minutes).</p>
<b>START</b>	<b>404</b>	KEY AL2	0 1	<p><b>START</b> allows you to select whether the timer starts with the keyboard (Run/Hold key) or Alarm 2.</p>



Function Prompt Lower Display		Selection or Range of Setting Upper Display		Parameter Definition
English	Numeric Code	English	Numeric Code	
<b>L DISP</b>	<b>405</b>	TREM ET	0 1	<p><b>L DISP</b> allows you to select whether time remaining (TI REM) or elapsed time (E TIME) is displayed for the timer option.</p> <p>The time is shown on the lower display in HH:MM format along with a rotating “clock” character.</p> <ul style="list-style-type: none"> <li>• If the “clock” rotation is <i>clockwise</i>, elapsed time is indicated.</li> <li>• If the “clock” rotation is <i>counterclockwise</i>, time remaining is indicated.</li> </ul>
<b>RESET</b>	<b>406</b>	Key AL1	0 1	<p><b>RESET TIMER</b> determines how the Timer will be set back to zero.</p> <p><b>KEY</b> – Reset Timer via Run/Hold Key  <b>ALARM 1</b> – Reset the Timer via either Alarm 1 or Run/Hold Key</p>
<b>INCRMT</b>	<b>407</b>	MIN SEC	0 1	<p><b>INCREMENT</b> This selection determines how the timer’s count will increment.</p> <p><b>MINUTES</b> Counts are in Hours/Minutes  <b>SEC</b> Counts are in Minutes/Seconds</p>

### 3.8 Output Set Up Group

#### Introduction

This group deals with various output types in the controller, the Digital Output Status and the Current Output operation.

**ATTENTION** The Tuning Group is automatically configured to have two PID sets when a Duplex Control Algorithm is selected.

#### Function Prompts

Table 3-8 OUTPUT Group (Numeric Code 500) Function Prompts

Function Prompt Lower Display		Selection or Range of Setting Upper Display		Parameter Definition
English	Numeric Code	English	Numeric Code	
OUTALG	501			<p>The <b>OUTPUT ALGORITHM</b> lets you select the type of output you want. <b>Not applicable with Control algorithm prompt TPSC (Three Position Step Control).</b></p> <p>Selections are hardware dependent. For example, if the controller does not have a current output, then none of the prompts for Output Algorithms that need a current output will appear. Likewise, if the controller does not have a relay output, then none of the prompts that need a relay output will appear.</p> <p><b>ATTENTION</b> For all Duplex Output forms, PID heat parameters apply for controller output greater than 50 %; PID cool parameters apply for controller output less than 50 %.</p> <p><b>TIME SIMPLEX</b>—This output algorithm uses Digital Output 1 for Time Proportional Control. The output is updated per the Loop sampling rate selection. Time Proportional Output has a resolution of 4.44 msec. Cycle Time is adjustable from 1 to 120 seconds.</p> <p><b>TIME SIMPLEX</b>—This output algorithm uses Digital Output 2 for Time Proportional Control. The output is updated per the Loop sampling rate selection. Time Proportional Output has a resolution of 4.44 msec. Cycle Time is adjustable from 1 to 120 seconds.</p>
		RLY	0	
		RLY2	1	

Function Prompt Lower Display		Selection or Range of Setting Upper Display		Parameter Definition
English	Numeric Code	English	Numeric Code	
		CUR	2	<p><b>CURRENT SIMPLEX</b>—Type of output using one 4 mA to 20 mA signal that can be fed into a positive or negative grounded load of 0 to 1000 ohms. This signal can easily be configured for 4-20 mA or 0-20 mA operation via the CRANGE configuration, below.</p> <p><b>TIME DUPLEX</b>—This output algorithm uses Digital Outputs 1 and 2 for Duplex Time Proportional Control. The outputs are updated per the Loop sampling rate selection. Time Proportional Output has a resolution of 4.44 msec. Cycle Time is adjustable from 1 second to 120 seconds.</p> <p><b>CURRENT DUPLEX</b> is similar to current simplex but uses a second current output. The second output is usually scaled so that zero and span correspond with 0 % and 50 % output (cool zone). When the output is 0 % to 50 %, the controller uses tuning parameter set #2, when the output is 50 % to 100 % it uses set #1.</p> <p><b>ATTENTION</b> Other prompts affected: 4-20 RNG</p> <p><b>CURRENT/TIME DUPLEX</b> is a variation of duplex with current active for 0 % to 50 % output (tuning set 2) and time is active 50 % to 100 % output (tuning set 1). Relay controls heat, current controls cool.</p> <p><b>ATTENTION</b> Other prompts affected: 4-20 RNG</p> <p><b>TIME CURRENT DUPLEX</b> is similar to CUR TI except that current is active for 50 % to 100 % and time is active for 0 % to 50 %. Relay controls cool, current controls heat.</p> <p><b>ATTENTION</b> Other prompts affected: 4-20 RNG</p>
		RLYD	3	
		CURD	4	
		CURT	5	
		TCUR	6	
<b>CRANGE</b>	<b>502</b>	4-20 0-20	0 1	<p><b>CURRENT OUTPUT RANGE</b> allows the user to easily select 4-20 mA output or 0-20 mA output operation without the need for recalibration of the instrument.</p>
<b>OUTRNG</b>	<b>504</b>			<p><b>CURRENT DUPLEX RANGE ALGORITHM</b> — Used with Output Algorithm selections CURD, CURT, or TCUR.</p>

Function Prompt Lower Display		Selection or Range of Setting Upper Display		Parameter Definition
English	Numeric Code	English	Numeric Code	
		50		<p><b>CURRENT DUPLEX RANGE (SPLIT)</b>—This setting should be used for Relay/Current and Current/Relay Duplex Outputs. It can also be used for Current Duplex when an Auxiliary Output board is present. This enables the normal control current output to provide heat control and the auxiliary current output to provide cool control. To enable this:</p> <ul style="list-style-type: none"> <li>• AUX OUT in the Options Set Up group must be selected for Output.</li> <li>• The Auxiliary Current Output is scaled as desired for 0-50 % controller output.</li> <li>• Deadband for this configuration only applies to the Current Output. The Auxiliary Output must have the Deadband scaled in.</li> </ul> <p>FOR EXAMPLE:</p> <p>If a 2 % Deadband is desired, then enter <b>2.0</b> for the Deadband selection in the Control Algorithm group. This will apply Deadband to the Current Output. In the Options group, set the Auxiliary Output LOW VAL selection to <b>49.0</b> and the HIGH VAL selection to <b>0.0</b>.</p> <p><b>CURRENT DUPLEX RANGE (FULL)</b> enables the Current Output to provide both heat and cool functions for control over 0-100 % of the controller output. The PID heat parameters apply when the output is greater than 50 % and the PID cool parameters apply when the output is less than 50 %. The second current output is not required for this type of duplex operation.</p>
		100		

Function Prompt Lower Display		Selection or Range of Setting Upper Display		Parameter Definition
English	Numeric Code	English	Numeric Code	
<b>RLY TYP</b>		MECH  S S	0  1	<p><b>RELAY CYCLE TIME INCREMENT</b> selection is used only for Time Simplex and Duplex output configurations. This configuration sets the increment size of the relay cycle times in the Tuning and Tuning 2 Set Up groups.</p> <p><b>ELECTROMECHANICAL RELAY</b>—Cycle time in one-second increments.</p> <p><b>SOLID STATE RELAY</b>—Cycle time in 1/3 second increments. This is useful for solid state relay applications that require shorter cycle times. DO NOT use this setting unless cycle times of less than 1 second are required.</p> <p><b>ATTENTION</b> The Lockout selection must be set to NONE in order to view this selection.</p>
<b>MTR TI</b>	<b>505</b>	5 to 1800 seconds		<p><b>MOTOR TIME</b> – Appears only when “TPSC” (Three Position Step Control) is selected as the Control Algorithm. This is the time it takes the motor to travel from 0 to 100 % (fully closed to fully open). This time can usually be found on the nameplate of the motor.</p>

### 3.9 Input 1 Set Up Group

#### Introduction

This data deals with various parameters required to configure Input 1.

#### Function Prompts

Table 3-9 INPUT 1 Group (Numeric Code 600) Function Prompts

Function Prompt Lower Display		Selection or Range of Setting Upper Display		Parameter Definition
English	Numeric Code	English	Numeric Code	
<b>IN1TYP</b>	<b>601</b>			<b>INPUT 1 ACTUATION TYPE</b> – This selection determines what actuation you are going to use for Input 1.
		B	1	<b>B</b> —B Thermocouple
		E H	2	<b>E H</b> —E Thermocouple High
		E L	3	<b>E L</b> —E Thermocouple Low
		J H	4	<b>J H</b> —J Thermocouple High
		J M	5	<b>J M</b> —J Thermocouple Med
		J L	6	<b>J L</b> —J Thermocouple Low
		K H	7	<b>K H</b> —K Thermocouple High
		K M	8	<b>K M</b> —K Thermocouple Med
		K L	9	<b>K L</b> —K Thermocouple Low
		NNMH	10	<b>NNMH</b> —Ni-Ni-Moly Thermocouple High
		NNML	11	<b>NNML</b> —Ni-Ni-Moly Thermocouple Low
		NICH	12	<b>NICH</b> —Nicrosil-Nisil Thermocouple High
		NICL	13	<b>NICL</b> —Nicrosil-Nisil Thermocouple Low
		R	14	<b>R</b> —R Thermocouple
		S	15	<b>S</b> —S Thermocouple
		T H	16	<b>T H</b> —T Thermocouple High
		T L	17	<b>T L</b> —T Thermocouple Low
		W H	18	<b>W H</b> —W5W26 Thermocouple High
		W L	19	<b>W L</b> —W5W26 Thermocouple Low
		100H	20	<b>100H</b> —100 Ohm RTD High
		100L	21	<b>100L</b> —100 Ohm RTD Low
		200	22	<b>200</b> —200 Ohm RTD
		500	23	<b>500</b> —500 Ohm RTD
		RADH	24	<b>RADH</b> —Radimatic RH
		RADI	25	<b>RADI</b> —Radimatic RI
		0-20	26	<b>0-20</b> —0 to 20 Milliamperes
		4-20	27	<b>4-20</b> —4 to 20 Milliamperes
		10m	28	<b>10m</b> —0 to 10 Millivolts
		50m	29	<b>50m</b> —0 to 50 Millivolts
		100m	30	<b>100m</b> —0 to 100 Millivolts
		0-5	31	<b>0-5</b> —0 to 5 Volts
		1-5	32	<b>1-5</b> —1 to 5 Volts
		0-10	33	<b>0-10</b> —0 to 10 Volts
		TDIF	34	<b>TDIF</b> —Thermocouple Differential
		PR	35	<b>PR</b> —PR40-PR20 Thermocouple

Function Prompt Lower Display		Selection or Range of Setting Upper Display		Parameter Definition
English	Numeric Code	English	Numeric Code	
<b>XMITR1</b>	<b>602</b>	B	0	<p><b>TRANSMITTER CHARACTERIZATION—</b> This selection lets you instruct the controller to characterize a linear input to represent a non-linear one. If characterization is performed by the transmitter itself, then select LIN (Linear).</p> <p><b>ATTENTION</b> Prompt only appears when a linear actuation is selected at prompt IN1 TYPE.</p> <p><b>FOR EXAMPLE:</b> If input 1 is a 4 to 20 mA signal, but the signal represents a type K H thermocouple, then configure <b>K H</b> and the controller will characterize the 4 to 20 mA signal so that it is treated as a type K thermocouple input (high range).</p> <p>Parameter definitions are the same as in IN1 TYPE.</p>
		E H	1	
		E L	2	
		J H	3	
		J M	4	
		J L	5	
		K H	6	
		K M	7	
		K L	8	
		NNMH	9	
		NNML	10	
		NICH	11	
		NICL	12	
		R	13	
		S	14	
		T H	15	
		T L	16	
		W H	17	
		W L	18	
		100H	19	
		100L	20	
		200	21	
		500	22	
		RADH	23	
		RADI	24	
		LIN	25	
SrT	26			
<b>IN1 HI</b>	<b>603</b>	-999 to 9999 floating in engineering units		<p><b>INPUT 1 HIGH RANGE VALUE</b> in engineering units is displayed for all inputs but can only be configured for linear or square root transmitter characterization.</p> <p>Scale the #1 input signal to the display value you want for 100 %.</p> <p><b>EXAMPLE:</b> Process Variable = Flow Range of Flow = 0 to 250 Liters/Minute Actuation (Input 1) = 4 to 20 mA Characterization (XMITTER) = LINEAR Set IN1 HI display value to 250 Set IN1 LO display value to 0 Then 20 mA = 250 Liters/Minute and 4 mA = 0 Liters/Minute</p> <p><b>ATTENTION</b> The control setpoint will be limited by the range of units selected here.</p>

Function Prompt Lower Display		Selection or Range of Setting Upper Display		Parameter Definition
English	Numeric Code	English	Numeric Code	
<b>IN1 LO</b>	<b>604</b>	-999 to 9999 floating in engineering units		<p><b>INPUT 1 LOW RANGE VALUE</b> in engineering units is displayed for all inputs but can only be configured for linear or square root transmitter characterization. Scale the #1 input signal to the display value you want for 0 %. See example above.</p> <p><b>ATTENTION</b> The control setpoint will be limited by the range of units selected here.</p>
<b>RATIO1</b>	<b>605</b>	-20.0 to 20.0		<p><b>RATIO ON INPUT 1</b>—Select the Ratio value you want on Input 1.</p>
<b>BIAS 1</b>	<b>606</b>	-999 to 9999		<p><b>BIAS ON INPUT 1</b> — Bias is used to compensate the input for drift of an input value due to deterioration of a sensor, or some other cause. Select the bias value you want on Input 1.</p>
<b>FILTR1</b>	<b>607</b>	0 to 120 seconds 0 = No Filter		<p><b>FILTER FOR INPUT 1</b>—A software digital filter is provided for Input 1 to smooth the input signal. You can configure the first order lag time constant from 1 to 120 seconds. If you do not want filtering, enter 0.</p>
<b>BRNOUT</b>	<b>608</b>	NONE  UP	0  1	<p><b>BURNOUT PROTECTION (SENSOR BREAK)</b> provides most input types with upscale or downscale protection if the input fails.</p> <p><b>NO BURNOUT</b>—Pre-configured Failsafe output (selected in the CONTROL Set up Group) applied if failed input is detected (does not apply for an input out of range). Diagnostic message IN1 FAIL is intermittently flashed on the lower display.</p> <p><b>UPSCALE BURNOUT</b> will force the Input 1 signal to the full scale value when the sensor fails. Diagnostic message IN1 FAIL intermittently flashed on the lower display.</p> <p>The controller remains in Automatic control mode and adjusts the controller output signal in response to the full scale Input 1 signal developed by the Burnout circuitry.</p>



Function Prompt Lower Display		Selection or Range of Setting Upper Display		Parameter Definition
English	Numeric Code	English	Numeric Code	
		DOWN	2	<p><b>DOWNSCALE BURNOUT</b> will force the Input 1 signal to the lower range value when the sensor fails. Diagnostic message IN1 FAIL intermittently flashed on the lower display.</p> <p>The controller remains in Automatic control mode and adjusts the controller output signal in response to the lower range Input 1 signal developed by the Burnout circuitry.</p> <p>This selection does not provide input failure detection and should only be used when a thermocouple input is connected to another instrument which supplies the Burnout current. (For this selection, no burnout signal is sent to the sensor.) when a thermocouple input is connected to another instrument which supplies the Burnout current. (For this selection, no burnout signal is sent to the sensor.)</p> <p><b>ATTENTION</b> For Burnout to function properly on a 0-20 mA input type (or a 0-5V type that uses a dropping resistor), the dropping resistor must be remotely located (across the transmitter terminals). Otherwise, the input at the UDC terminals will always be 0 mA (i.e., within the normal operating range) when the 0-20 mA line is opened.</p>
		NOFS	3	
<b>EMISS</b>	<b>609</b>	0.01 to 1.00		<p><b>EMISSIVITY</b> is a correction factor applied to the Radiamatic input signal that is the ratio of the actual energy emitted from the target to the energy which would be emitted if the target were a perfect radiator.</p> <p>Available only for Radiamatic inputs.</p>

### 3.10 Input 2 Set Up Group

#### Introduction

This data deals with various parameters required to configure Input 2.

#### Function Prompts

Table 3-10 INPUT2 Group (Numeric Code 700) Function Prompts

Function Prompt Lower Display		Selection or Range of Setting Upper Display		Parameter Definition
English	Numeric Code	English	Numeric Code	
IN2TYP	701			<b>INPUT 2 ACTUATION TYPE</b> – This selection determines what actuation you are going to use for Input 2.  <b>DIS</b> —Disable <b>0-20</b> —0 to 20 mA (internal dropping resistor) <b>4-20</b> —4 to 20 mA (internal dropping resistor) <b>0-5</b> —0 to 5 Volts <b>1-5</b> —1 to 5 Volts <b>0-2</b> —0 to 2 Volts
		DIS 0-20 4-20 0-5 1-5 0-2	0 26 27 31 32 35	
XMITR2	702			<b>TRANSMITTER CHARACTERIZATION</b> — Same as Input 1 Transmitter
		B E H E L J H J M J L K H K M K L NNMH NNML NIC H NIC L R S T H T L W H W L 100H 100L 200 500 RADH RADI LIN SrT	0 1 2 3 4 5 6 7 8 9 10 11 12 13 14 15 16 17 18 19 20 21 22 23 24 25 26	

Function Prompt Lower Display		Selection or Range of Setting Upper Display		Parameter Definition
English	Numeric Code	English	Numeric Code	
<b>IN2 HI</b>	<b>703</b>	–999 to 9999 floating in engineering units		<p><b>INPUT 2 HIGH RANGE VALUE</b> in engineering units is displayed for all inputs but can only be configured for linear or square root transmitter characterization.</p> <p>Scale the #2 input signal to the display value you want for 100 %.</p> <p>EXAMPLE:            Process Variable = Flow            Range of Flow = 0 to 250 Liters/Minute            Actuation (Input 2) = 4 to 20 mA            Characterization (XMITTER) = LINEAR            Set IN1 HI display value to 250            Set IN1 LO display value to 0            Then 20 mA = 250 Liters/Minute            and 4 mA = 0 Liters/Minute</p> <p><b>ATTENTION</b> The control setpoint will be limited by the range of units selected here.</p>
<b>IN2 LO</b>	<b>704</b>	–999 to 9999 floating in engineering units		<p><b>INPUT 2 LOW RANGE VALUE</b> in engineering units is displayed for all inputs but can only be configured for linear or square root transmitter characterization. Scale the #2 input signal to the display value you want for 0 %. See example above.</p> <p><b>ATTENTION</b> The control setpoint for Input 2 will be limited by the range of units selected here.</p>
<b>RATIO2</b>	<b>705</b>	-20.0 to 20.0		<p><b>RATIO ON INPUT 2</b>—Select the Ratio value you want on Input 2.</p>
<b>BIAS 2</b>	<b>706</b>	-999 to 9999		<p><b>BIAS ON INPUT 2</b> — Bias is used to compensate the input for drift of an input value due to deterioration of a sensor, or some other cause. Select the bias value you want on Input 2.</p>
<b>FILTR2</b>	<b>707</b>	0 to 120 seconds 0 = No Filter		<p><b>FILTER FOR INPUT 2</b>—A software digital filter is provided for Input 1 to smooth the input signal. You can configure the first order lag time constant from 1 to 120 seconds. If you do not want filtering, enter 0.</p>



### 3.11 Control Set Up Group

#### Introduction

The functions listed in this group deal with how the controller will control the process including: Number of Tuning Parameter Sets, Setpoint Source, Tracking, Power-up Recall, Setpoint Limits, Output Direction and Limits, Deadband, and Hysteresis.

#### Function Prompts

Table 3-11 CONTRL Group (Numeric Code 800) Function Prompts

Function Prompt Lower Display		Selection or Range of Setting Upper Display		Parameter Definition
English	Numeric Code	English	Numeric Code	
PIDSET	801	ONE	0	<p><b>NUMBER OF TUNING PARAMETER SETS</b>—This selection lets you choose one or two sets of tuning constants (gain, rate, and reset). NOTE: The Tuning Group is automatically configured to have two PID sets when a Duplex Control Algorithm is configured.</p> <p><b>ONE SET ONLY</b>—Only one set of tuning parameters is available. Configure the values for: Gain (proportional band), Rate, Reset Time, and Cycle Time (if time proportional is used).</p> <p><b>TWO SETS KEYBOARD SELECTABLE</b>—Two sets of tuning parameters can be configured and can be selected at the operator interface or by using the Digital Inputs.</p> <p>Press <b>LOWER DISPLAY</b> key until you see PID SET1 or PID SET2 then press  or  to switch between sets. Configure the values for: Gain, Rate, Reset, Cycle Time Gain #2, Rate #2, Reset #2, Cycle #2 Time</p>
		2KBD	1	

Function Prompt Lower Display		Selection or Range of Setting Upper Display		Parameter Definition
English	Numeric Code	English	Numeric Code	
		2 PR	2	<p><b>TWO SETS PV AUTOMATIC SWITCHOVER</b>—When the process variable is <i>GREATER</i> than the value set at prompt SW VALUE (Switchover Value), the controller will use Gain, Rate, Reset, and Cycle Time. The active PID SET can be read in the lower display.</p> <p>When the process variable is <i>LESS</i> than the value set at prompt SW VALUE, the controller will use Gain #2, Rate #2, Reset #2, and Cycle #2 Time. The active PID SET can be read in the lower display.</p> <p><b>ATTENTION</b> <i>Other prompts affected: SW VALUE</i></p>
		2 SP	3	<p><b>TWO SETS SP AUTOMATIC SWITCHOVER</b>—When the setpoint is <i>GREATER</i> than the value set at prompt SW VALUE (Switchover Value), the controller will use Gain, Rate, Reset, and Cycle.</p> <p>When the setpoint is <i>LESS</i> than the value set at prompt SW VALUE, the controller will use Gain #2, Rate #2, Reset #2, and Cycle #2.</p> <p><b>ATTENTION</b> <i>Other prompts affected: SW VALUE</i></p>
<b>SW VAL</b>	<b>802</b>	Value in engineering units within PV or SP range limits		<p><b>AUTOMATIC SWITCHOVER VALUE</b>—This is the value of Process Variable or Setpoint at which the controller will switch from Tuning Constant Set #2 to Set #1.</p> <p><b>ATTENTION</b> <i>Only appears when PID SETS selection is configured for either 2 PVS or 2 SPS.</i></p>
<b>LSP'S</b>	<b>803</b>	ONE	0	<p><b>LOCAL SETPOINT SOURCE</b>—This selection determines what your local setpoint source will be.</p> <p><b>LOCAL SETPOINT</b>—The setpoint entered from the keyboard.</p>

Function Prompt Lower Display		Selection or Range of Setting Upper Display		Parameter Definition
English	Numeric Code	English	Numeric Code	
		TWO	1	<b>TWO LOCAL SETPOINTS</b> —This selection lets you switch between two local setpoints using the <b>SETPOINT SELECT</b> key.
<b>RSPSRC</b>	<b>804</b>	NONE INP2	0 1	<b>REMOTE SETPOINT SOURCE</b> — This selection lets you switch between the local and remote setpoints using the <b>SETPOINT SELECT</b> key.  <b>NONE</b> —No remote setpoint. <b>INPUT 2</b> —Remote Setpoint is Input 2.
<b>SP TRK</b>	<b>805</b>	NONE  PROC  RSP	0  1  2	<b>SETPOINT TRACKING</b> —The local setpoint can be configured to track either PV or RSP as listed below. Not configurable when Auto Bias is set.  <b>ATTENTION</b> For selections other than NONE, LSP is stored in nonvolatile memory only when there is a mode change; i.e., when switching from RSP to LSP or from Manual to Automatic. If power is lost, then the current LSP value is also lost.  <b>NO TRACKING</b> —If local setpoint tracking is not configured, the LSP will not be altered when transfer from RSP to LSP is made.  <b>PROCESS VARIABLE (PV)</b> —Local setpoint tracks the PV when in manual.  <b>RSP</b> —Local setpoint tracks remote setpoint when in automatic. When the controller transfers out of remote setpoint, the last value of the remote setpoint (RSP) is inserted into the local setpoint.
<b>PWR UP</b>	<b>806</b>	MAN  ALSP	0  1	<b>POWER UP CONTROLLER MODE RECALL</b> —This selection determines which mode and setpoint the controller will use when the controller restarts after a power loss.  <b>MANUAL, LSP</b> —At power-up, the controller will use manual mode with the local setpoint displayed.  <b>AUTOMATIC MODE, LAST LSP</b> —At power-up, the controller will use automatic mode with the last local setpoint used before power down displayed.

Function Prompt Lower Display		Selection or Range of Setting Upper Display		Parameter Definition
English	Numeric Code	English	Numeric Code	
		ARSP	2	<b>AUTOMATIC MODE, LAST RSP</b> —At power-up, the controller will use automatic mode with the last remote setpoint used before power down displayed.
		AMSP	3	<b>LAST MODE/LAST SETPOINT</b> used before power down.
		AMLS	4	<b>LAST MODE/LAST LOCAL SETPOINT</b> on power down.
<b>PWROUT</b>	<b>807</b>			<b>THREE POSITION CONTROL STEP OUTPUT START-UP MODE</b> —This selection determines what position the motor will be in when powered up or in the failsafe position.
		LAST	0	<b>LAST OUTPUT</b> —At power-up in automatic mode, the motor position will be the last one prior to power down. When the unit goes into FAILSAFE, it will stay in automatic mode; motor will <b>not</b> be driven to the configured failsafe position.
		FSAF	1	<b>FAILSAFE OUTPUT</b> —At power-up in manual mode, the motor will be driven to either the 0 % or 100 % output position, whichever is selected at prompt FAILSAFE. For Burnout/None, when the unit goes into FAILSAFE, it will go to manual mode; motor will be driven to the configured failsafe position.
<b>SP Hi</b>	<b>808</b>	0 to 100 % of the PV range		<b>SETPOINT HIGH LIMIT</b> —This selection prevents the local and remote setpoints from going above the value selected here. The setting must be equal or less than the upper range of the PV.
<b>SP Lo</b>	<b>809</b>	0 to 100 % of the PV range		<b>SET POINT LOW LIMIT</b> —This selection prevents the local and remote setpoints from going below the value selected here. The setting must be equal or greater than the lower range of the PV.
<b>ACTION</b>	<b>810</b>	DIR	0	<b>CONTROL OUTPUT DIRECTION</b> —Select direct or reverse output action. <b>DIRECT ACTING CONTROL</b> —The controller's output <i>increases</i> as the process variable increases.
		REV	1	<b>REVERSE ACTING CONTROL</b> —The controller's output <i>decreases</i> as the process variable increases.

Function Prompt Lower Display		Selection or Range of Setting Upper Display		Parameter Definition
English	Numeric Code	English	Numeric Code	
<b>OUT Hi</b>	<b>811</b>	0 % to 100 % -5 % to 105 %		<b>HIGH OUTPUT LIMIT</b> —This is the highest value of output beyond which you do not want the controller automatic output to exceed.  For relay output types. For current output types.
<b>OUT Lo</b>	<b>812</b>	0 % to 100 % -5 % to 105 %		<b>LOW OUTPUT LIMIT</b> —This is the lowest value of output below which you do not want the controller automatic output to exceed.  For relay output types. For current output types.
<b>D BAND</b>	<b>813</b>	-5.0 to 25.0 % 0.0 to 25.0 % 0.5 to 5.0 %		<b>DEADBAND</b> is an adjustable gap between the operating ranges of output 1 and output 2 in which neither output operates (positive value) or both outputs operate (negative value).  Time Duplex On-Off Duplex Three Position Step
<b>HYST</b>	<b>814</b>	0.0 to 100.0 % of PV		<b>HYSTERESIS (OUTPUT RELAY)</b> is an adjustable overlap of the ON/OFF states of each control output. This is the difference between the value of the process variable at which the control outputs energize and the value at which they de-energize.  <b>ATTENTION</b> Only applicable for ON/OFF control.
<b>FAILSF</b>	<b>815</b>	0 to 100 %		<b>FAILSAFE OUTPUT VALUE</b> —The value used here will also be the output level when you have Communications SHED set to failsafe or when NO BURNOUT is configured and Input 1 fails.  <b>ATTENTION</b> Applies for all output types <i>except</i> Three Position Step Control.
<b>FAILSF</b>	<b>816</b>	0 100		<b>THREE POSITION STEP FAILSAFE OUTPUT</b>  <b>0 PCT</b> —Motor goes to closed position. <b>100 PCT</b> —Motor goes to open position.



Function Prompt Lower Display		Selection or Range of Setting Upper Display		Parameter Definition
English	Numeric Code	English	Numeric Code	
<b>FSMODE</b>	<b>817</b>	No L	0	<b>FAILSAFE MODE</b>  <b>NON LATCHING</b> —Controller stays in last mode that was being used (automatic or manual); output goes to failsafe value. (NOTE 1, NOTE 2)  <b>LATCHING</b> —Controller goes to manual mode; output goes to failsafe value. (NOTE 2)
		LACH	1	
<b>PBorGN</b>	<b>818</b>	GAIN	0	<b>PROPORTIONAL BAND UNITS</b> —Select one of the following for the Proportional (P) term of the PID algorithm:  <b>GAIN</b> selects the unitless term of gain for the P term of the PID algorithm. Where: $GAIN = \frac{100 \% FS}{PB\%}$  <b>PROPORTIONAL BAND</b> selects units of percent proportional band for the P term of the PID algorithm. Where: $PB \% = \frac{100 \% FS}{GAIN}$
		PB	1	
<b>MINRPM</b>	<b>819</b>	MIN	0	<b>RESET UNITS</b> —Selects units of minutes per repeat or repeats per minute for the I term of the PID algorithm.  20 Repeats per Minute = 0.05 Minutes per Repeat.  <b>MINUTES PER REPEAT</b> —The time between each repeat of the proportional action by reset.  <b>REPEATS PER MINUTE</b> —The number of times per minute that the proportional action is repeated by reset.
		RPM	1	

NOTE 1: Does not apply to Three Position Step Control.

NOTE 2: If controller is in Manual upon failure, output will maintain its value at time of failure.

NOTE 3: These selections appear when the Control Algorithm is selected for 3PSTEP.

NOTE 4: The local setpoint will automatically adjust itself to be within the setpoint limit range. For example, if SP = 1500 and the SP HiLIM is changed to 1200, the new local setpoint will be 1200.

NOTE 5: Reset limits and Dropoff are not displayed when Three Position Step Control is configured.

### 3.12 Options Group

#### Introduction

The Options group lets you configure the remote mode switch (Digital Inputs) to a specific contact closure response, or configure the Auxiliary Output to be a specific selection with desired scaling.

#### Function Prompts

Table 3-12 OPTION Group (Numeric Code 900) Function Prompts

Function Prompt Lower Display		Selection or Range of Setting Upper Display		Parameter Definition
English	Numeric Code	English	Numeric Code	
AUXOUT	901			<p><b>AUXILIARY OUTPUT SELECTION</b></p> <p>This selection provides an mA output representing one of several control parameters. The display for auxiliary output viewing will be in engineering units for all but output. Output will be displayed in percent.</p> <p><b>ATTENTION</b> Other prompts affected by these selections: 4mA VAL and 20mA VAL.</p> <p><b>ATTENTION</b> Output cannot be configured when Three Position Step Control is used.</p>
		DIS	0	<b>NO AUXILIARY OUTPUT</b>
		IN1	1	<p><b>INPUT 1</b>—This represents the configured range of input 1.</p> <p>FOR EXAMPLE:                      Type J Thermocouple (0 °F to 1600 °F)                      0 °F display = 0 % output                      1600 °F display = 100 % output</p>
		IN2	2	<b>INPUT 2</b> represents the value of the configured range of input 2.
		PROC	3	<b>PROCESS VARIABLE</b> —Represents the value of the Process Variable. PV = Input XxRatioX + BiasX

Function Prompt Lower Display		Selection or Range of Setting Upper Display		Parameter Definition
English	Numeric Code	English	Numeric Code	
		DEV	4	<p><b>DEVIATION (PROCESS VARIABLE MINUS SETPOINT)</b>—Represents –100 % to +100 % of the selected PV span in engineering units.</p> <p>Zero deviation will produce a center scale (12 mA or 50 %) output. A negative deviation equal in magnitude to the Auxiliary Output High Scaling Factor will produce a low end output (4 mA or 0 %) output. A positive deviation equal in magnitude to the Auxiliary Output Low Scaling Factor will produce a high end output (20 mA or 100 %).</p> <p>FOR EXAMPLE:            Input 1 = Type T High Thermocouple            PV range = –300 °F to +700 °F            PV span = 1000 °F            Deviation Range = –1000 °F to +1000 °F            Auxiliary Output Low Scale Value = 0.0            Auxiliary Output High Scale Value = 1000</p> <p>If PV = 500 °F and SP = 650 °F            then Deviation Display = –150 °F, which is –7.5% of the Deviation Range, so            Auxiliary Output = 50% – 7.5% = 42.5%</p>
		OUT	5	<p><b>OUTPUT</b>—Represents the displayed controller output in percent (%). Cannot be used with            Three Position Step Control.</p>
		SP	6	<p><b>SETPOINT</b>—Represents the value of the setpoint currently in use and is shown in the same units as those used by the PV.</p>
		LSP 1	7	<p><b>LOCAL SETPOINT ONE</b>—Auxiliary output represents Local Setpoint 1 regardless of active setpoint.</p>
		LSP 2	8	<p><b>LOCAL SETPOINT TWO</b>—Auxiliary output represents Local Setpoint 2 regardless of active setpoint.</p>
<b>OPCT</b>	<b>902</b>	Value in Engineering Units		<p><b>AUXILIARY OUTPUT LOW SCALING FACTOR</b>— This is a value in engineering units used to represent all AUX OUT parameters except Output.</p> <p>For Output, this is a value in percent and can be any value between –5 % and +105 %. However, keep in mind that relay output types can only be scaled 0 % to 100 %.</p>

Function Prompt Lower Display		Selection or Range of Setting Upper Display		Parameter Definition
English	Numeric Code	English	Numeric Code	
100 PCT	903	Value in Engineering Units		<p><b>AUXILIARY OUTPUT HIGH SCALING FACTOR</b>— This is a value in engineering units used to represent all AUX OUT parameters except Output.</p> <p>For Output, this is a value in percent and can be any value between –5 % and +105 %. However, keep in mind that relay output types can only be scaled 0 % to 100 %.</p>
CRANGE	904	4-20 0-20	0 1	<p><b>AUXILIARY OUTPUT RANGE</b> allows the user to easily select 4-20mA output or 0-20mA output operation without the need for recalibration of the instrument.</p> <p><b>ATTENTION</b> Changing the Auxiliary Output Range will result in the loss of Field Calibration values and will restore Factory Calibration values.</p>
DIGIN1	905	NONE MAN LSP SP2 DIR	0 1 2 3 4	<p><b>DIGITAL INPUT 1 SELECTIONS</b>—All selections are available for Input 1. The controller returns to its original state when contact opens, except when overruled by the keyboard.</p> <p><b>NO DIGITAL INPUT SELECTIONS</b></p> <p><b>TO MANUAL</b>—Contact closure puts the affected loop into manual mode. Contact open returns controller to former mode.</p> <p><b>TO LOCAL SETPOINT</b>—When a remote setpoint is configured, contact closure puts the controller into local setpoint 1. When contact opens, the controller returns to former operation—local or remote setpoint—unless <b>SETPOINT SELECT</b> key is pressed while digital input is active. If this happens, the controller will stay in the local setpoint mode when contact opens.</p> <p><b>TO LOCAL SETPOINT TWO</b>—Contact closure puts the controller into local setpoint 2.</p> <p><b>TO DIRECT ACTION</b>—Contact closure selects direct controller action.</p>

Function Prompt Lower Display		Selection or Range of Setting Upper Display		Parameter Definition
English	Numeric Code	English	Numeric Code	
		HOLD	5	<p><b>TO HOLD</b>—Contact closure suspends Setpoint Program or Setpoint Ramp. When contact reopens, the controller starts from the Hold point of the Ramp/Program unless the Ramp/Program was not previously started via the <b>RUN/HOLD</b> key.</p> <p>This selection applies to either loop.</p>
		PID2	6	<p><b>TO PID2</b>—Contact closure selects PID Set 2.</p>
		RUN	7	<p><b>RUN</b>—Contact closure starts a stopped SP Ramp or Program. Upper left character blinks “R”. Reopening the contact puts controller in HOLD mode.</p> <p>This selection applies to either loop.</p>
		Begn	8	<p><b>EXTERNAL SP PROGRAM RESET</b>—Contact closure resets SP Program back to the beginning of the first segment in the program and places the program in the HOLD mode. Program cycle number is not affected. Reopening switch has no effect.</p> <p>This selection applies to either loop.</p> <p><b>ATTENTION</b> Once the last segment of the setpoint program has timed out, the controller enters the mode of action specified in the configuration data and the program cannot be reset to the beginning of the first segment by digital input closure.</p>
		NO I	9	<p><b>INHIBIT INTEGRAL (RESET)</b>—Contact closure disables PID Integral (Reset) action.</p>
		MNFS	10	<p><b>MANUAL FAILSAFE OUTPUT</b>—Controller goes to Manual mode, output goes to the Failsafe value.</p> <p><b>ATTENTION</b> This will cause a bump in the output when switching from Automatic to Manual. The switch back from Manual to Automatic is bumpless. When the switch is closed, the output can be adjusted from the keyboard.</p>
		LOCK	11	<p><b>KEYBOARD LOCKOUT</b>—Contact closure disables all keys. Lower display shows LOCKED if a key is pressed.</p>

Function Prompt Lower Display		Selection or Range of Setting Upper Display		Parameter Definition
English	Numeric Code	English	Numeric Code	
		TIMR	12	<b>TIMER</b> —Contact closure starts timer, if enabled. Reopening the switch has no effect.
		TUNE	13	<b>INITIATE LIMIT CYCLE TUNING</b> —Contact closure starts the slow tuning process. The lower display shows DoSLOW. Opening the contact has no effect.
		INIT	14	<b>SETPOINT INITIALIZATION</b> —Contact closure forces the setpoint to the current PV value. Opening the contact has no effect.
		RSP	15	<b>TO REMOTE SETPOINT</b> —Contact closure selects the Remote setpoint.
		MNLT	16	<b>MANUAL LATCHING</b> —Contact closure transition forces the loop to Manual mode. Opening the switch has no effect. If the <b>M-A RESET</b> key is pressed while the switch is closed, the loop will return to Automatic mode.
		TRAK	17	<b>OUTPUT TRACKS INPUT 2</b> —Contact closure allows Output to track Input 2. While the switch is open, the output is in accordance with its pre-defined functionality. When the switch is closed, the output value (in percent) will track the Input 2 percent of range value. When the switch is reopened, the output will start at this last output value and normal PID action will then take over control. The transfer is bumpless.
		STRT	18	<b>PV HOTSTART</b> —Contact closure starts the SP Ramp or SP Program at the original selected starting Setpoint Value that existed at the time that the SP Ramp or Program was first started. Opening contact has no effect. This configuration must be selected prior to the first time the SP Ramp or Program is placed in the RUN mode, as otherwise the unit will not be able to capture the initial Setpoint value. This selection allows the unit to retain the initial Setpoint value even if power to the unit is lost.  When the STATE selection in the SP Ramp or Program Set Up group is set to HOLD and the digital input contact is left closed, then when the end of the program or ramp is reached, the program or ramp will automatically restart at the initial Setpoint

Function Prompt Lower Display		Selection or Range of Setting Upper Display		Parameter Definition
English	Numeric Code	English	Numeric Code	
				value.  If power to the unit is lost while while a SP Ramp or Program was running, then if the contact is closed at power up, the unit will automatically restart the SP Ramp or Program at the captured Setpoint value.
<b>DI1COM</b>	<b>906</b>	DIS  +PD2  +DIR  +SP2  +SP1  +RUN	0  1  2  3  4  5	<b>DIGITAL INPUT 1 COMBINATION SELECTIONS</b> —This selection allows the specified function to occur in addition to the one chosen for DIG IN 1.  <b>DISABLE</b> —Disables combination function.  <b>PLUS PID2</b> —Contact closure selects PID Set 2.  <b>PLUS DIRECT ACTION</b> —Contact closure selects direct controller action.  <b>PLUS SETPOINT 2</b> —Contact closure puts the controller into setpoint 2.  <b>PLUS SETPOINT 1</b> —Contact closure puts the controller into setpoint 1.  <b>PLUS RUN SETPOINT PROGRAM/RAMP</b> —Contact closure starts SP Program/Ramp if enabled.
<b>DIGIN2</b>	<b>907</b>	Same selections as for Digital Input 1		<b>DIGITAL INPUT 2 SELECTIONS</b>
<b>DI2COM</b>	<b>908</b>	Same selections as Digital Input 1 Combinations		<b>DIGITAL INPUT 2 COMBINATIONS</b>

### 3.13 Communications Group

#### Introduction

The Communications group lets you configure the controller to be connected to a host computer via Modbus® or Ethernet TCP/IP protocol. Two parameters in this Group, Communications Station Address and TX Delay, are also used for IR communications. No other parameters affect IR communications.

#### Introduction

A controller with a communications option looks for messages from the host computer. If these messages are not received within the configured shed time, the controller will SHED from the communications link and return to stand-alone operation. You can also set the SHED output mode and setpoint recall, and communication units.

Up to 99 addresses can be configured over this link. The number of units that can be configured depends on the link length, with 31 being the maximum for short link lengths and 15 drops being the maximum at the maximum link length.

#### Function Prompts

Table 3-13 Communications Group (Numeric Code 1000) Function Prompts

Function Prompt Lower Display		Selection or Range of Setting Upper Display		Parameter Definition
English	Numeric Code	English	Numeric Code	
ComADR	1001	1 to 99		<b>COMMUNICATIONS STATION ADDRESS</b> —This is a number that is assigned to a controller that is to be used with the communications option. This number will be its address. This parameter is also used for the IR communications link.
COMSTA	1002	DIS MODB ETHR	0 1 2	<b>COMMUNICATIONS SELECTION</b> <b>DISABLE</b> —Disables the communications option <b>MODBUS</b> —Enable Modbus RTU communications <b>ETHERNET</b> —Enable Ethernet Communications
IRENAB	1003	DIS ENAB	0 1	<b>INFRARED COMMUNICATIONS</b> – Enables/ Disables the IR Port.
BAUD	1004	4800 9600 19200 38400	0 1 2 3	<b>BAUD RATE</b> is the transmission speed in bits per second. This value is used for both RS-485 and IR Communications, but for IR Communications, values below 19200 baud are interpreted as being 19200 baud. <b>4800 BAUD</b> <b>9600 BAUD</b> <b>19200 BAUD</b> <b>38400 BAUD</b>



Function Prompt Lower Display		Selection or Range of Setting Upper Display		Parameter Definition																														
English	Numeric Code	English	Numeric Code																															
<b>TX_DLY</b>	<b>1005</b>	1 to 500 milliseconds		<b>TX DELAY</b> —Configurable response-delay timer allows you to force the UDC to delay its response for a time period of from 1 to 500 milliseconds compatible with the host system hardware/software. This parameter is also used for the IR communications link.																														
<b>WS_FLT</b>	<b>1006</b>			<p>Defines word/byte order of floating point data for communications. Byte values:</p> <p style="text-align: center;"> <span style="margin-right: 40px;">0</span> <span style="margin-right: 40px;">1</span> <span style="margin-right: 40px;">2</span> <span>3</span> </p> <p style="text-align: center;"> <span style="margin-right: 40px;">s e e e e e e e</span> <span style="margin-right: 40px;">e m m m m m m m</span> <span style="margin-right: 40px;">m m m m m m m m</span> <span>m m m m m m m m</span> </p> <p>Where: s = sign, e = exponent, m = mantissa bit</p> <table style="width: 100%; border-collapse: collapse;"> <tr> <td style="width: 25%;"></td> <td style="width: 25%; text-align: center;">0</td> <td style="width: 25%; text-align: center;">1</td> <td style="width: 25%; text-align: center;">2</td> <td style="width: 25%; text-align: center;">3</td> </tr> <tr> <td>FP B</td> <td style="text-align: center;">0</td> <td style="text-align: center;">1</td> <td style="text-align: center;">2</td> <td style="text-align: center;">3</td> </tr> <tr> <td>FPBB</td> <td style="text-align: center;">1</td> <td style="text-align: center;">0</td> <td style="text-align: center;">3</td> <td style="text-align: center;">2</td> </tr> <tr> <td>FP L</td> <td style="text-align: center;">2</td> <td style="text-align: center;">3</td> <td style="text-align: center;">2</td> <td style="text-align: center;">1</td> </tr> <tr> <td>FPLB</td> <td style="text-align: center;">3</td> <td style="text-align: center;">2</td> <td style="text-align: center;">3</td> <td style="text-align: center;">0</td> </tr> <tr> <td></td> <td></td> <td></td> <td style="text-align: center;">0</td> <td style="text-align: center;">1</td> </tr> </table>		0	1	2	3	FP B	0	1	2	3	FPBB	1	0	3	2	FP L	2	3	2	1	FPLB	3	2	3	0				0	1
	0	1	2	3																														
FP B	0	1	2	3																														
FPBB	1	0	3	2																														
FP L	2	3	2	1																														
FPLB	3	2	3	0																														
			0	1																														
<b>SDENAB</b>	<b>1007</b>	DIS ENAB	0 1	<b>SHED ENABLE</b> —Disables/enables shed functionality.																														
<b>SHDTIM</b>	<b>1008</b>	0 to 255 Sample Periods		<p><b>SHED TIME</b>—The number that represents how many sample periods there will be before the controller sheds from communications. Each period equals 1/3 seconds; 0 equals No shed.</p> <p>Note: If ComSTA is set to MODBUS and if SHEDENAB is set to DISABL, Shed Time will not be configurable.</p>																														
<b>SDMODE</b>	<b>1009</b>			<p><b>SHED CONTROLLER MODE AND OUTPUT LEVEL</b>—Determines the mode of local control you want when the controller is shed from the communications link.</p> <p><b>LAST</b>—SAME MODE AND OUTPUT—The controller will return to the same mode (manual or automatic) at the same output level that it had before shed.</p> <p><b>TO MAN</b>—MANUAL MODE, SAME OUTPUT—The controller will return to manual mode at the same output level that it had before shed.</p> <p><b>FSAFE</b>—MANUAL MODE, FAILSAFE OUTPUT—The controller will return to manual mode at the output value selected at Control prompt FAILSAFE.</p> <p><b>TO AUTO</b>—AUTOMATIC MODE, LAST SP—The</p>																														
		LAST	0																															
		MAN	1																															
		FSAFE	2																															
		AUTO	3																															

Function Prompt Lower Display		Selection or Range of Setting Upper Display		Parameter Definition
English	Numeric Code	English	Numeric Code	
				controller will return to the automatic mode and the last setpoint used before shed.
<b>SHD_SP</b>	<b>1010</b>	LSP	0	<p><b>SHED SETPOINT RECALL</b></p> <p>Note: If SHEDENAB=DISABLE, this prompt will not be configurable.</p> <p><b>TO LSP</b>—Controller will use last local or remote setpoint used.</p> <p><b>TO CSP</b>—When in “slave” mode, the controller will store the last host computer setpoint and use it at the Local setpoint. When in “monitor” mode, the controller will shed to the last UDC Local or Remote setpoint used, and the LSP is unchanged.</p>
		CSP	1	
<b>UNITS</b>	<b>1011</b>	PCT EGR	0 1	<b>PERCENT ENGINEERING UNITS</b>
<b>CSRATIO</b>	<b>1012</b>	-20.0 to 20.0		<b>COMPUTER SETPOINT RATIO</b> —Computer setpoint ratio.
<b>CSP_BI</b>	<b>1013</b>	-999 to 9999		<b>COMPUTER SETPOINT RATIO</b> —Computer setpoint ratio in Engineering Units.
<b>LOOPBK</b>	<b>1014</b>	DIS	0	<p><b>LOCAL LOOPBACK</b> tests the communications hardware.</p> <p><b>DISABLE</b>—Disables the Loopback test.</p> <p><b>ENABLE</b>—Allows loopback test. The UDC goes into Loopback mode in which it sends and receives its own message. The UDC displays PASS or FAIL status in the upper display and LOOPBACK in the lower display while the test is running. The UDC will go into manual mode when LOOPBACK is enabled with the output at the Failsafe value. The test will run until the operator disables it here, or until power is turned off and on.</p> <p><b>ATTENTION</b> The instrument does not have to be connected to the external communications link in order to perform this test. If it is connected, only one instrument should run the loopback test at a time. The host computer should not be transmitting on the link while the loopback test is active.</p>
		ENAB	1	

### 3.14 Alarms Set Up Group

#### Introduction

An alarm is an indication that an event that you have configured (for example—Process Variable) has exceeded one or more alarm limits. There are two alarms available. Each alarm has two setpoints. You can configure each of these two setpoints to alarm on various controller parameters.

There are two alarm output selections, High and Low. You can configure each setpoint to alarm either High or Low. These are called single alarms.

You can also configure the two setpoints to alarm on the same event and to alarm both high and low. A single adjustable Hysteresis of 0 % to 100 % is configurable for the alarm setpoint.

See *Table 2-3 in the Installation section* for Alarm relay contact information.

The prompts for the Alarm Outputs appear whether or not the alarm relays are physically present. This allows the Alarm status to be shown on the display and/or sent via communications to a host computer.

#### Function Prompts

**Table 3-14 ALARMS Group (Numeric Code 1100) Function Prompts**

Function Prompt Lower Display		Selection or Range of Setting Upper Display		Parameter Definition
English	Numeric Code	English	Numeric Code	
A1S1TY	1101			<b>ALARM 1 SETPOINT 1 TYPE</b> —Select what you want Setpoint 1 of Alarm 1 to represent. It can represent the Process Variable, Deviation, Input 1, Input 2, Output, and if you have a model with communications, you can configure the controller to alarm on SHED. If you have setpoint programming, you can alarm when a segment goes ON or OFF.
		NONE	0	<b>NO ALARM</b>
		IN 1	1	<b>INPUT 1</b>
		IN 2	2	<b>INPUT 2</b>
		PROC	3	<b>PROCESS VARIABLE</b>
		DE	4	<b>DEVIATION</b>
		OUT	5	<b>OUTPUT (NOTE 1)</b>
		SHED	6	<b>SHED FROM COMMUNICATIONS</b>
		E-ON	7	<b>EVENT ON (SP PROGRAMMING)</b>
		E-OFF	8	<b>EVENT OFF (SP PROGRAMMING)</b>
		MAN	9	<b>ALARM ON MANUAL MODE (NOTE 2)</b>
		RSP	10	<b>REMOTE SETPOINT</b>
		FSAF	11	<b>FAILSAFE</b>
		PrRT	12	<b>PV RATE OF CHANGE</b>
		DI 1	13	<b>DIGITAL INPUT 1 ACTUATED (NOTE 7)</b>
DI 2	14	<b>DIGITAL INPUT 2 ACTUATED (NOTE 7)</b>		
BRAK	15	<b>LOOP BREAK (NOTE 4)</b>		

Function Prompt Lower Display		Selection or Range of Setting Upper Display		Parameter Definition
English	Numeric Code	English	Numeric Code	
		DE 2 TC W TC F	16 17 18	<p><b>DEVIATION FROM LSP 2</b> (NOTE 3)  <b>THERMOCOUPLE WARNING</b> (NOTE 5)  <b>THERMOCOUPLE FAILING</b> (NOTE 6)</p> <p><b>ATTENTION</b></p> <p><b>NOTE 1.</b> When the controller is configured for Three Position Step Control, alarms set for Output will not function.</p> <p><b>NOTE 2.</b> Alarm 1 is not available if the Timer is enabled because Alarm 1 is dedicated to Timer output.</p> <p><b>NOTE 3.</b> This Deviation Alarm is based upon deviation from the 2nd Local Setpoint or Remote SP regardless of whichever SP is active.</p> <p><b>NOTE 4.</b> Loop Break monitors the control loop to determine if it is working. When enabled, the control output is checked against the minimum and maximum output limit settings. When the output reaches one of these limits, a timer begins. If the timer expires and the output has not caused the PV to move by a pre-determined amount, then the alarm activates, thus signalling that the loop is broken. The loop break timer value must be configured by the operator as the AxSx VAL entry. This value is in seconds with a range of 0 to 3600 seconds. A setting of 0 is equivalent to an instantaneous loop break when the output reaches one of its limit values.</p> <p>The amount of PV Movement required is determined by the "UNITS" setting in the Display Setup Group. For the Degrees F configuration, the PV must move by 3° in the desired direction in the time allowed. For the Degrees C configuration, the PV must move by 2° in the desired direction in the time allowed. For the "NONE" selection, the PV must move 1% of the PV range in the time allowed.</p> <p>Loop Break alarms do not have a HIGH/LOW State configuration, they are always assumed to be a HIGH state alarm.</p>

Function Prompt Lower Display		Selection or Range of Setting Upper Display		Parameter Definition
English	Numeric Code	English	Numeric Code	
				<p><b>NOTE 5.</b> Thermocouple Warning means that the instrument has detected that the Thermocouple Input is starting to fail. Not valid for other input types.</p> <p><b>NOTE 6.</b> Thermocouple Failing means that the instrument has detected that the Thermocouple Input is in imminent danger of failing. Not valid for other input types.</p> <p><b>NOTE 7.</b> For the Digital Input selections, DI 1 can be either enabled or disabled in the Options Group (See Section 3.12), but DI 2 must be enabled in the Options Group for the alarm to function properly.</p>
A1S1VA	1102	Value in engineering units		<p><b>ALARM 1 SETPOINT 1 VALUE</b>—This is the value at which you want the alarm type chosen in prompt A1S1TYPE to actuate. The value depends on what the setpoint has been configured to represent. No setpoint is required for alarms configured for Communications SHED. For SP Programming the value is the segment number for which the event applies.</p> <p>This prompt does not appear for “Alarm on Manual” type alarm. For example: A1S1TYPE = MANUAL.</p>
A1S1HL	1103	HIGH LOW	0 1	<p><b>If Setpoint Programming is disabled or if the Alarm Type is not configured for Event On/Off:</b></p> <p><b>ALARM 1 SETPOINT 1 STATE</b>—Select whether you want the alarm type chosen in prompt A1S1TYPE to alarm High or Low.</p> <p><b>HIGH ALARM</b> <b>LOW ALARM</b></p>

Function Prompt Lower Display		Selection or Range of Setting Upper Display		Parameter Definition
English	Numeric Code	English	Numeric Code	
A1S1EV	1103	BEGIN END	0 1	<p><i>If Setpoint Programming is enabled and if the Alarm Type is configured for Event On/Off:</i></p> <p><b>ALARM 1 SEGMENT EVENT 1</b>—Select whether you want the alarm type chosen in prompt A1S1TYPE to alarm the beginning or end of a segment in setpoint Ramp/Soak programming.</p> <p><b>BEGINNING OF SEGMENT</b> <b>END OF SEGMENT</b></p> <p><b>ATTENTION</b> Alarms configured for events will not operate on Setpoint Program segments of zero length.</p>
A1S2TY	1104			<p><b>ALARM 1 SETPOINT 2 TYPE</b>—Select what you want Setpoint 2 of Alarm 1 to represent. The selections are the same as A1S1TYPE.</p>
A1S2VA	1105	Value in engineering units		<p><b>ALARM 1 SETPOINT 2 VALUE</b>—This is the value at which you want the alarm type chosen in prompt A1S2TYPE to actuate. The details are the same as A1S1 VAL.</p>
A1S2HL	1106	HIGH LOW	0 1	<p><b>ALARM 1 SETPOINT 2 STATE</b>—Same as A1S1HL.</p>
A1S2EV	1106	BEGIN END	0 1	<p><b>ALARM 1 SEGMENT EVENT 2</b>—Same as A1S1EV.</p>
A2S1TY	1107			<p><b>ALARM 2 SETPOINT 1 TYPE</b>—Select what you want Setpoint 1 of Alarm 2 to represent. The selections are the same as A1S1TYPE.</p> <p><b>ATTENTION</b> Not applicable with Relay Duplex unless using Dual Relay PWA.</p>
A2S1VA	1108	Value in engineering units		<p><b>ALARM 2 SETPOINT 1 VALUE</b>—This is the value at which you want the alarm type chosen in prompt A2S1TYPE to actuate. The details are the same as A1S1 VAL.</p>

Function Prompt Lower Display		Selection or Range of Setting Upper Display		Parameter Definition
English	Numeric Code	English	Numeric Code	
A2S1HL	1109	HIGH LOW	0 1	<b>ALARM 2 SETPOINT 1 STATE</b> —Same as A1S1HL.
A2S1EV	1109	BEGIN END	0 1	<b>ALARM 2 SEGMENT EVENT 1</b> —Same as A1S1EV.
A2S2TY	1110			<p><b>ALARM 2 SETPOINT 2 TYPE</b>—Select what you want Setpoint 2 of Alarm 2 to represent.</p> <p>The selections are the same as A1S1TYPE.</p> <p><b>ATTENTION</b> Not applicable with Relay Duplex unless using Dual Relay PWA.</p>
A2S2VA	1111	Value in engineering units		<p><b>ALARM 2 SETPOINT 2 VALUE</b>—This is the value at which you want the alarm type chosen in prompt A2S2TYPE to actuate.</p> <p>The details are the same as A1S1 VAL.</p>
A2S1HL	1112	HIGH LOW	0 1	<b>ALARM 2 SETPOINT 1 STATE</b> —Same as A1S1HL.
A2S1EV	1112	BEGIN END	0 1	<b>ALARM 2 SEGMENT EVENT 2</b> —Same as A1S1EV.
ALHYST	1113	0.0 to 100.0 % of span or full output as appropriate		<p><b>ALARM HYSTERESIS</b>—A single adjustable hysteresis is provided on alarms such that when the alarm is OFF it activates at exactly the alarm setpoint; when the alarm is ON, it will not deactivate until the variable is 0.0 % to 100 % away from the alarm setpoint.</p> <p>Configure the hysteresis of the alarms based on INPUT signals as a % of input range span.</p> <p>Configure the hysteresis of the alarm based on OUTPUT signals as a % of the full scale output range.</p>

Function Prompt Lower Display		Selection or Range of Setting Upper Display		Parameter Definition
English	Numeric Code	English	Numeric Code	
<b>ALARM1</b>	<b>1114</b>	NO LAT LATCH	0 1	<p><b>LATCHING ALARM OUTPUT 1</b>—Alarm output 1 can be configured to be Latching or Non-latching.</p> <p><b>NO LAT</b>—Non-latching <b>LATCH</b>—Latching</p> <p><b>ATTENTION</b> When configured for latching, the alarm will stay active after the alarm condition ends until the RUN/HOLD key is pressed.</p>
<b>BLOCK</b>	<b>1115</b>	DIS AL1 AL 2 AL12	0 1 2 3	<p><b>ALARM BLOCKING</b>—Prevents nuisance alarms when the controller is first powered up. The alarm is suppressed until the parameter gets to the non-alarm limit or band. Alarm blocking affects both alarm setpoints.</p> <p><b>DISABLE</b>—Disables blocking <b>AL1</b>—Blocks alarm 1 only <b>AL2</b>—Blocks alarm 2 only <b>AL12</b>—Blocks both alarms</p> <p><b>ATTENTION</b> When enabled on power up or initial enabling via configuration, the alarm will not activate unless the parameter being monitored has not been in an alarm condition for a minimum of one control cycle (167 ms).</p>
<b>DIAGAL</b>	<b>1116</b>	DIS AL1 AL 2 DISWRN	0 1 2 3	<p><b>DIAGNOSTIC</b>—Monitors the Current Output and/or Auxiliary Output for an open circuit condition. If either of these two outputs falls below about 3.5 mA, then an Alarm is activated. This configuration is in addition to whatever was selected for AxSxTYPE.</p> <p><b>DISABLE</b>—Disables Diagnostic Alarm <b>ALARM 1</b>—Alarm 1 is diagnostic alarm <b>ALARM 2</b>—Alarm 2 is diagnostic alarm <b>DISABLE WARNING</b>—Disables Output Fail message on lower display</p>



### 3.15 Display Set Up Group

#### Introduction

This group includes selections for Decimal place, Units of temperature, Language and Power frequency.

#### Function Prompts

Table 3-15 DISPLY Group (Numeric Code 1200) Function Prompts

Function Prompt Lower Display		Selection or Range of Setting Upper Display		Parameter Definition
English	Numeric Code	English	Numeric Code	
<b>DECMAL</b>	<b>1201</b>	NONE ONE TWO		<p><b>DECIMAL POINT LOCATION</b>—This selection determines where the decimal point appears in the display.</p> <p><b>NONE</b>—No Decimal Place—fixed, no auto-ranging <b>8888</b></p> <p><b>ONE</b>—1 decimal place <b>888.8</b></p> <p><b>TWO</b>—2 decimal places <b>88.88</b></p> <p><b>ATTENTION</b> Auto-ranging will occur for selections of one or two decimal places. For example, should the instrument be configured for two decimal places and the PV exceeds 99.99, then the display will change to a single decimal place so that values of 100.0 and above can be shown.</p>
<b>UNITS</b>	<b>1202</b>	F  C  NONE	0  1  2	<p><b>TEMPERATURE UNITS</b>—This selection will affect the indication and operation.</p> <p><b>DEG F</b>—Degrees Fahrenheit – Degrees F Annunciator lighted</p> <p><b>DEG C</b>—Degrees Centigrade – Degrees C Annunciator lighted</p> <p><b>NONE</b>—No temperature annunciators lighted. Upper and Lower Displays will show temperature in Degrees Fahrenheit when inputs are configured for Thermocouple or RTD types.</p>

Function Prompt Lower Display		Selection or Range of Setting Upper Display		Parameter Definition
English	Numeric Code	English	Numeric Code	
<b>FREQ</b>	<b>1203</b>	60 50	0 1	<p><b>POWER LINE FREQUENCY</b>—Select whether your controller is operating at 50 or 60 Hertz.</p> <p><b>ATTENTION</b> For controllers powered by +24 Vdc, this configuration should be set to the AC line frequency used to produce the +24 Vdc supply.</p> <p>Incorrect setting of this parameter may cause normal mode noise problems in the input readings.</p>
<b>DISPLY</b>	<b>1205</b>	SP PRY  PRN	0 1  2	<p><b>DEFAULT DISPLAY</b>—For single display units, only. This setting selects the default parameter shown on the upper display. Pressing the <b>LOWER DISPLAY</b> key will cycle through all applicable values. One minute after the last press of the display key, the display will revert to the display configured here.</p> <p><b>SETPOINT</b>—Active Setpoint</p> <p><b>PV-YES</b>—Process Variable with lower display prompt.</p> <p><b>PV-NO</b>—Process Variable with no lower display prompt.</p>
<b>LWRDSP</b>	<b>1204</b>	ENAB DIS	0 1	<p><b>LOWER DISPLY</b>—For dual display units, only. Select whether the unit uses single or dual display.</p> <p><b>ENAB</b>—Enable Dual Display</p> <p><b>DIS</b>—Disable Dual Display (Single Display Only)</p>
<b>LNGUAG</b>	<b>1206</b>	ENGL FREN GERM SPAN ITAL NUMB	0 1 2 3 4 5	<p><b>LANGUAGE</b>—This selection designates the prompt language.</p> <p><b>ENGLISH</b></p> <p><b>FRENCH</b></p> <p><b>GERMAN</b></p> <p><b>SPANISH</b></p> <p><b>ITALIAN</b></p> <p><b>NUMERIC</b></p>
<b>TCDIAG</b>	<b>1207</b>	ENAB DIS	0 1	<p><b>THERMOCOUPLE DIAGNOSTICS</b>—Enable or disable Thermocouple diagnostic messages.</p> <p><b>ENAB</b>—Enable Diagnostic Messages</p> <p><b>DIS</b>—Disable Diagnostic Messages</p>

## 3.16 P.I.E. Tool Ethernet and Email Configuration Screens

### Introduction

These screens only appear in instruments that have Ethernet Communications. Ethernet and Email parameters can only be configured via the Process Instrument Explorer (P.I.E. Tool®). The figures in this section show screen-shots of the Configuration Screens from the PC version of the P.I.E. Tool®. Pocket PC Configuration Screens are generally similar in format but smaller.

### Ethernet Configuration Screen

This controller is shipped from the factory with the IP Address set to 10.0.0.2, the Subnet Mask set to 255.255.255.0 and the Default Gateway set to 0.0.0.0. Consult your Information Technologies (IT) representative as to how these should be configured for your installation. The MAC address is printed on the product label located on the instrument's case.

These settings can be changed via the Ethernet Configuration Screen as shown in Figure 3-1.

See [Section 4.23 – Configuring your Ethernet Connection](#) for more information.

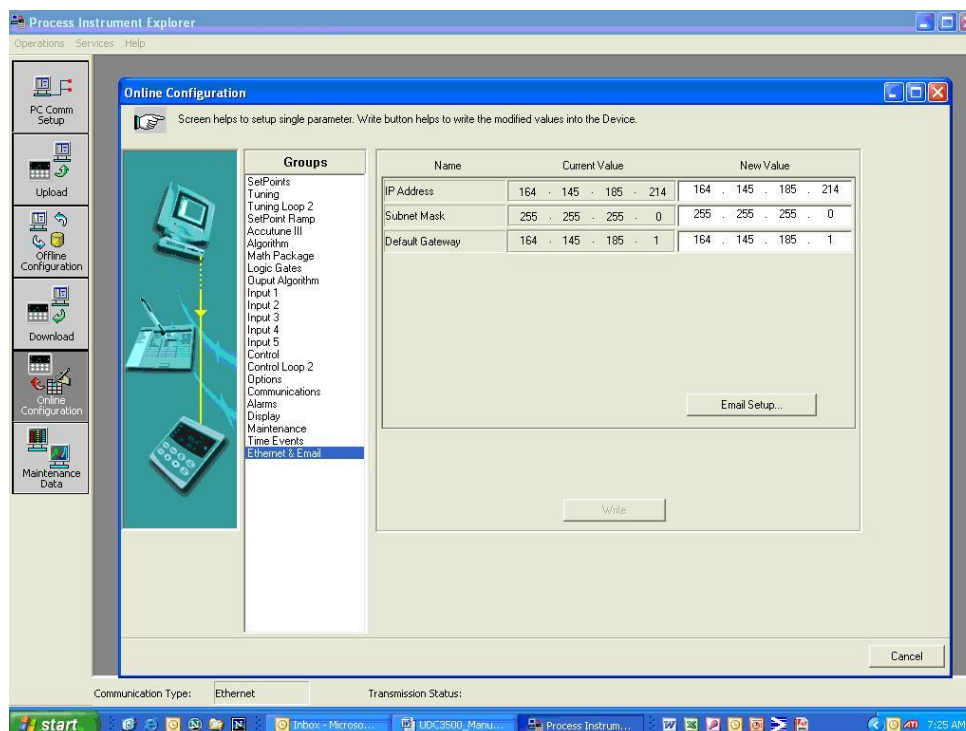


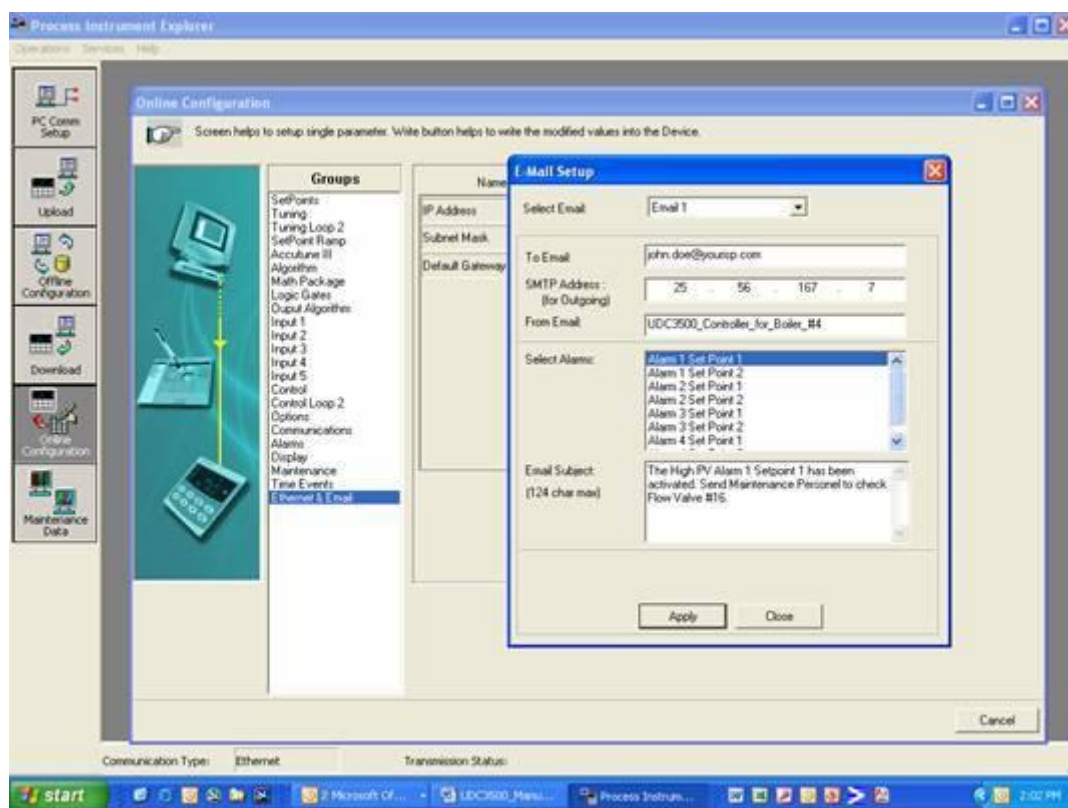
Figure 3-1 Ethernet Configuration Screen

**WARNING**

After you change the IP Address, you will no longer be able to communicate with the instrument via Ethernet until you change the P.I.E. Tool's IP Address setting in the **PC COMM SETUP** section to match the setting that is now in your controller. See **Section 4.23 – Configuring your Ethernet Connection** for more information.

**Email Configuration Screen**

This controller may be configured to support sending an Email when an alarm occurs. Emails are sent only when the selected alarm transitions from the OFF to the ON state.



**Figure 3-2 Email Configuration Screen**

This controller cannot receive Emails, so it is suggested that you configure the **From Email:** window with a non-Email style address that will make it easy for you to determine which controller sent the Email. For Email technical reasons, the entry in the **From Email:** window cannot have spaces. See Figure 3-2.

If you do not know your SMTP IP Address for outgoing Email, then contact your Information Technologies (IT) representative. If your PC is on the same LAN that will be used by the controller and which also connects to the Email server, then the SMTP IP Address may generally be found by opening a DOS shell and typing:

ping smtp.[your domain name and extension], i.e., **ping smtp.your\_isp.com**

The content of the Emails sent by this controller contains the Alarm that triggered the Email, its settings and the current value (if applicable) of the monitored variable. For example, the content of an Email triggered by Alarm 1 Setpoint 1 that is configured to monitor Input 1 would look something like this:

**Name: Alarm 1 SP1, Type: INPUT1, Event: HIGH/END, Value = 500.00,  
Actual = 712.69**

The content of an Email triggered by Alarm 2 Setpoint 1 that is configured to monitor Digital Input 1 would look something like this:

**Name: Alarm 2 SP1, Type: DIG IN1, Event: HIGH/END, Value = 0.00,  
Actual = 0.00**

---

### ATTENTION

Email will always be time-stamped with the date that the Ethernet Software in the instrument was last modified.

If the SMTP address on your network is changed, such as can happen when a server is replaced, then you must reconfigure the Email SMTP IP address in this instrument to match the new IP address.

---

### 3.17 Configuration Record Sheet

Enter the value or selection for each prompt on this sheet so you will have a record of how your controller was configured.

Group Prompt	Function Prompt	Value or Selection	Factory Setting	Group Prompt	Function Prompt	Value or Selection	Factory Setting
<b>TUNING</b>	PB or GAIN	_____	1.0	<b>ALGOR</b>	CTRALG	_____	PIDA
	RATE T	_____	0.00		TIMER	_____	DIS
	I MIN or I RPM	_____	1.0		PERIOD	_____	0:01
	MANRST	_____	1.0		START	_____	KEY
	PB2 or GAIN 2	_____	0.0		L DISP	_____	TREM
	RATE2T	_____	0.00		RESET	_____	KEY
	I2 MIN or I2 RPM	_____	1.0	INCRMT	_____	MIN	
	CYCT1 or CT1	_____	20	<b>OUTALG</b>	OUTALG	_____	NOTE 1
	X3	_____	20		CRANGE	_____	4-20
	CYC2T2 or CT2	_____	20		RLY TY	_____	MECH
	X3	_____	20		MTR TI	_____	5
	SECUR	_____	0				
	LOCK	_____	NONE				
	AUTOMA	_____	ENAB				
A TUNE	_____	ENAB					
RN HLD	_____	ENAB					
SP SEL	_____	ENAB					
<b>SPRAMP</b>	SPRAMP	_____	DIS	<b>INPUT1</b>	IN1TYP	_____	K H
	TI MIN	_____	3		XMITR1	_____	LIN
	FINLSP	_____	1000		IN1 HI	_____	2400
	SPRATE	_____	DIS		IN1 LO	_____	0
	EUHRUP	_____	0		RATIO1	_____	1.00
	EUHRDN	_____	0		BIAS 1	_____	0.0
	SPPROG	_____	DIS		FILTR1	_____	1
			BRNOUT	_____	UP		
			EMIS	_____	1.0		
<b>ATUNE</b>	FUZZY	_____	DIS	<b>INPUT2</b>	IN2TYP	_____	1-5V
	TUNE	_____	TUNE		LIN	_____	LIN
	DUPLEX	_____	MAN		IN2 HI	_____	2400
	AT ERR	Read Only	NONE		IN2 LO	_____	0
				RATIO2	_____	1.00	
				BIAS 2	_____	0.0	
				FILTR2	_____	1	

NOTE 1: Model Number Dependent.

Group Prompt	Function Prompt	Value or Selection	Factory Setting	Group Prompt	Function Prompt	Value or Selection	Factory Setting
<b>CONTRL</b>	PIDSET	_____	ONE	<b>ALARMS</b>	A1S1TY	_____	NONE
	SW VAL	_____	0.00		A1S1VA	_____	90
	LSP'S	_____	ONE		A1S1HL	_____	HIGH
	RSPSRC	_____	NONE		A1S1EV	_____	BEGN
	SP TRK	_____	NONE		A1S2TY	_____	NONE
	PWR UP	_____	AUTO		A1S2VA	_____	90
	PWROUT	_____	FSAF		A1S2HL	_____	HIGH
	SP Hi	_____	2400		A1S2EV	_____	BEGN
	SP Lo	_____	0		A2S1TY	_____	NONE
	ACTION	_____	REV		A2S1VA	_____	90
	OUT Hi	_____	100		A2S1HL	_____	HIGH
	OUT Lo	_____	0		A2S1EV	_____	BEGN
	D BAND	_____	2.0		A2S2TY	_____	NONE
	HYST	_____	0.5		A2S2VA	_____	90
	FAILSF	_____	0.0		A2S2HL	_____	HIGH
	FSMODE	_____	NOL		A2S2EV	_____	BEGN
	PBoGN	_____	GAIN		ALHYST	_____	0.0
	MINRPM	_____	MIN		ALARM1	_____	NOL
				BLOCK	_____	DIS	
				DIAGAL	_____	DIS	
<b>OPTION</b>	AUXOUT	_____	DIS	<b>DISPLY</b>	DECMAL	_____	NONE
	ARANGE	_____	4-20		UNITS	_____	F
	0 PCT	_____	0		FREQ	_____	60
	100 PCT	_____	100		LWRDSP	_____	DIS
	DIG IN 1	_____	NONE		DISPLY	_____	SP
	DIG1 CMB	_____	DIS		LNGUAG	_____	ENGL
	DIG IN 2	_____	NONE		TCDIAG	_____	DIS
	DIG2 CMB	_____	DIS				
<b>COM</b>	COMADR	_____	Disable	<b>Ethernet</b> (Accessible via PIE Tool)	MAC Add.	_____	--
	COMSTA	_____	0		IP Address	_____	10.0.0.2
	IRENAB	_____	Enable		Subnet Mask	_____	225.225 .225.0
	BAUD	_____	9600				
	TX_DLY	_____	30		Default Gate	_____	0.0.0.0
	WS_FLT	_____	FP_B		To Email	_____	--
	SDENAB	_____	Enable		SMTP Add.	_____	0.0.0.0
	SHDTIM	_____	0		Alarm	_____	NONE
	SDMODE	_____	Last		Email Subj	_____	--
	SHD_SP	_____	LSP				
	UNITS	_____	PCT				
	CSRATIO	_____	1.0				
	CSP_BI	_____	0				
	LOOPBK	_____	Disable				

## 4 Monitoring and Operating the Controller

### 4.1 Overview

#### Introduction

This section gives you all the information necessary to help you monitor and operate your controller including an Operator Interface overview, how to lockout changes to the controller, entering a security code, and monitoring the displays.

#### What's in this section?

The following topics are covered in this section.

TOPIC	See Page
4.1 Overview	90
4.2 Operator Interface	91
4.3 Entering A Security Code	91
4.4 Lockout Feature	92
4.5 Monitoring The Controller	94
4.6 Single Display Functionality	98
4.7 Start Up Procedure for Operation	97
4.8 Control Modes	101
4.9 Setpoints	102
4.10 Timer	103
4.11 Accutune	105
4.12 Fuzzy Overshoot Suppression	111
4.13 Using Two Sets Of Tuning Constants	111
4.14 Alarm Setpoints	113
4.15 Three Position Step Control Algorithm	114
4.16 Setting A Failsafe Output Value For Restart After A Power Loss	115
4.17 Setting Failsafe Mode	116
4.18 Setpoint Rate/Ramp/Program Overview	116
4.20 Setpoint Rate	118
4.19 Setpoint Ramp	117
4.21 Setpoint Ramp/Soak Programming	119
4.22 P.I.E. Tool Maintenance Screens	126
4.23 Configuring your Ethernet Connection	132



## 4.2 Operator Interface

### Introduction

Figure 4-1 is a view of the Operator Interface.

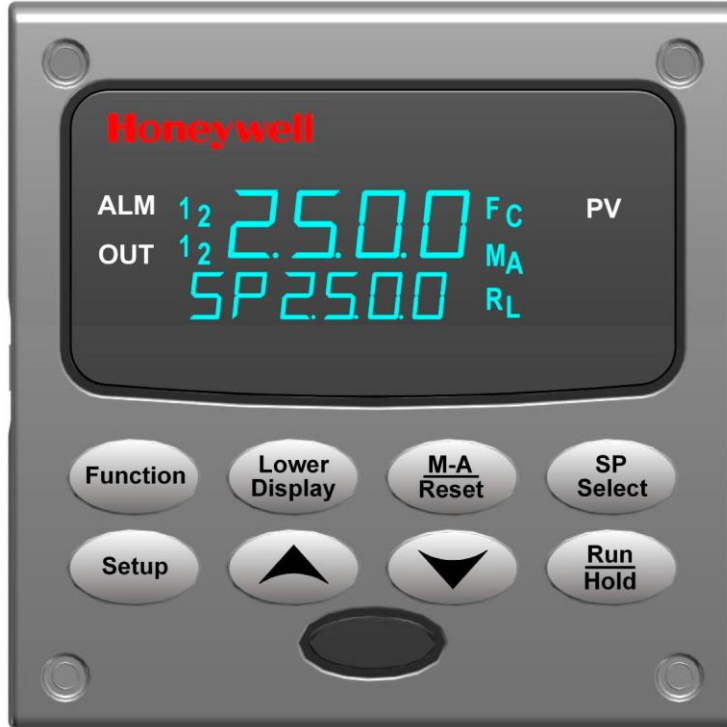


Figure 4-1 Operator Interface

## 4.3 Entering a Security Code

### Introduction





The level of keyboard lockout may be changed in the Set Up mode. However, knowledge of a security code number (0 to 9999) may be required to change from one level of lockout to another. When a controller leaves the factory, it has a security code of 0 which permits changing from one lockout level to another without entering any other code number.

### Procedure

If you require the use of a security code, select a number from 0001 to 9999 and enter it when the lockout level is configured as NONE. Thereafter, that selected number must be used to change the lockout level from something other than NONE.

**ATTENTION** Write the number on the Configuration Record Sheet in the configuration section so you will have a permanent record.

**Table 4-1 Procedure to Enter a Security Code**

Step	Operation	Press	Result
1	Enter Set Up Mode		Upper Display = <b>SET UP</b> Lower Display = <b>TUNING</b>
2	Select any Set Up Group		Upper Display = <b>0</b> Lower Display = <b>SECUR</b>
3	Security Code Entry	 or 	To enter a four digit number in the upper display (0001 to 9999) This will be your security code.

## 4.4 Lockout Feature

### Introduction

The lockout feature in the UDC2500 is used to inhibit changes (via keyboard) of certain functions or parameters by unauthorized personnel.

### Lockout levels

There are different levels of Lockout depending on the level of security required. These levels are:

- **NONE** No Lockout. All groups Read/Write.
- **CAL** Calibration prompts are deleted from the Setup List.
- **CONF** Timer, Tuning, SP Ramp, and Accutune are Read/Write. All other Setup groups are Read only. Calibration Group is not available.
- **VIEW** Timer, Tuning, and SP Ramp are Read/Write. No other parameters are available.
- **ALL** Timer, Tuning, and SP Ramp are Read only. No other parameters are viewable.

See *Subsection 3.4 - Tuning Parameters Set Up Group* prompts to select one of the above.

Security Code (*see Subsection 4.3*)

## Individual key lockout

There are three keys that can be disabled to prevent unauthorized changes to the parameters associated with these keys. *First set the “Lock” prompt to NONE.*

These keys are:



Key

- you can disable the Run/Hold key for Set Point Programming at configuration Set Up group prompt “Tuning,” function prompt “RN HLD.”



Key

- you can disable the Auto/Manual key at configuration Set Up, group prompt “Tuning”, function prompt “AUTOMA”



Key

- you can disable the Set Point Select function key at configuration Set Up group prompt “Tuning,” function prompt “SP SEL.”

See *Subsection 3.4 - Tuning Parameters Set Up Group* prompts to enable or disable these keys.

## Key error

When a key is pressed and the prompt “Key Error” appears in the lower display, it will be for one of the following reasons:

- Parameter not available or locked out
- Not in setup mode, press **SET UP** key first
- Individual key locked out.

## 4.5 Monitoring Your Controller

### 4.5.1 Annunciators

The following annunciator functions have been provided to help monitor the controller:

**Table 4-2 Annunciators**

Annunciator	Indication
<b>ALM 1 2</b>	<p><i>A visual indication of each alarm</i></p> <p>Blinking 1 indicates alarm latched and needs to be acknowledged (by pressing the <b>RUN/HOLD</b> key before extinguishing when the alarm condition ends</p>
<b>OUT 1 2</b>	<p><i>A visual indication of the control relays</i></p>
<b>A or M</b>	<p><i>A visual indication of the mode of the controller (Dual display model only)</i></p> <p><b>A</b>—Automatic Mode</p> <p><b>M</b>—Manual Mode</p>
<b>[None], F or C</b>	<p><i>A visual indication of the temperature units</i></p> <p><b>[None]</b>—No temperature unit annunciator</p> <p><b>F</b>—Degrees Fahrenheit</p> <p><b>C</b>—Degrees Celsius</p>
<b>L or R</b>	<p><i>A visual indication of setpoint being used</i></p> <p><b>L</b>— Local Setpoint is active</p> <p><b>R</b>— RSP or LSP 2 is active</p> <p><i>The upper display is used to show other annunciator functions</i></p> <p><b>TUNE</b>—Accutuning in progress</p> <p><b>RUN</b>—SP Program in progress</p> <p><b>HOLD</b>—SP Program on hold</p> <p><b>CSP</b>—Controlling to the Computer Setpoint</p> <p><b>LOOPBK</b>—Loopback Test running</p>

---

## 4.5.2 Viewing the operating parameters

Press the **LOWER DISPLAY** key to scroll through the operating parameters listed in Table 4-3. The lower display will show only those parameters and their values that apply to your specific model.

**Table 4-3 Lower Display Key Parameter Prompts**

Lower Display	Description
<b>OT XX.X</b>	OUTPUT—Output value is percent; for Three Position Step control, this is an estimated motor position and shown with no decimal place.
<b>SP XXXX</b>	LOCAL SETPOINT #1—Also current setpoint when using SP Ramp.
<b>2LXXXX</b>	LOCAL SETPOINT #2
<b>RSXXXX</b>	REMOTE SETPOINT
<b>2NXXXX</b>	INPUT 2
<b>DEXXXX</b>	DEVIATION—Maximum negative display is –999.9.
<b>PIDS X</b>	TUNING PARAMETER SELECTED SET—where X is either 1 or 2.
<b>HH.MM</b>	TIME REMAINING—Time that remains on timer in Hours.Minutes
<b>HH.MM</b>	ELAPSED TIME—Time that has elapsed on timer in Hours.Minutes.
<b>RPXXXM</b>	SETPOINT RAMP TIME—Time remaining in the setpoint ramp in minutes.
<b>AX XXX</b>	AUXILIARY OUTPUT
<b>SnXXXX</b>	SP RATE SETPOINT—Current setpoint for setpoint rate applications
<b>BIXXXX</b>	BIAS—Displays the manual reset value for algorithm PD+MR.
<b>To BGn</b>	TO BEGIN—Resets Setpoint Program back to beginning of the program.
<b>NoTUNE</b>	Unit is currently not in Accutune process.
<b>DoSLOW</b>	Accutune Slow tuning process is operating.
<b>DoFAST</b>	Accutune Fast tuning process is operating.
<b>POSXX.XX</b>	Three position

### 4.5.3 Diagnostic Messages

The UDC2500 performs background tests to verify data and memory integrity. If there is a malfunction, a diagnostic message will be shown on the lower display. In the case of more than one simultaneous malfunction, only the highest priority diagnostic message will be displayed. Table 4-4 shows the error messages in order by priority. If any of these diagnostic messages appear on the lower display, refer to *Section 7 - Troubleshooting* for information on how to correct the problem.

**Table 4-4 Diagnostic Messages**

Prompt	Description
<b>EE FAIL</b>	Unable to write to non-volatile memory.
<b>IN1FL</b>	Two consecutive failures of input 1 integration.
<b>IN2FL</b>	Two consecutive failures of input 2 integration.
<b>CFGERR</b>	Configuration Errors—Low limit greater than high limit for PV, SP, Reset, or Output.
<b>IN1RNG</b>	Input 1 Out-of-Range Out-of-range criteria: Linear range: $\pm 10\%$ out-of-range Characterized range: $\pm 1\%$ out-of-range
<b>IN2RNG</b>	Input 2 Out-of-Range—Same as Input 1.
<b>PV LIM</b>	PV Out-of-Range $PV = (PV \text{ source} \times PV \text{ source ratio}) + PV \text{ source bias}$
<b>FAILSF</b>	Failsafe — conditions for failsafe are: ... EEROM Test Failed ... Scratch Pad RAM Test Failed ... Configuration Test Failed ... Field or Factory Cal Test Failed  Check the “Status” group.
<b>RV LIM</b>	Remote Variable Out-of-Range $RV = (RV \text{ source} \times RV \text{ source ratio}) + RV \text{ source bias}$
<b>SEG ERR</b>	Segment Error—SP Program starting segment number is less than ending segment number.
<b>LOCK</b>	The lockout feature has been enabled to prevent unauthorized changes of certain functions or parameters.
<b>TCWARN</b>	Thermocouple sensor is starting to burnout.*
<b>TCFAIL</b>	Thermocouple sensor is in imminent danger of burning out.*
<b>OUT1 FL</b>	Current Output 1 is less than 3.5 mA.**
<b>OUT2 FL</b>	Current Output 2 is less than 3.5 mA.**

\* The Thermocouple Error messages can be disabled via the TCDIAG configuration in the DISPLAY setup group.

\*\* The Current Output Error messages can be disabled via the DIAGAL configuration in the ALARM setup group.

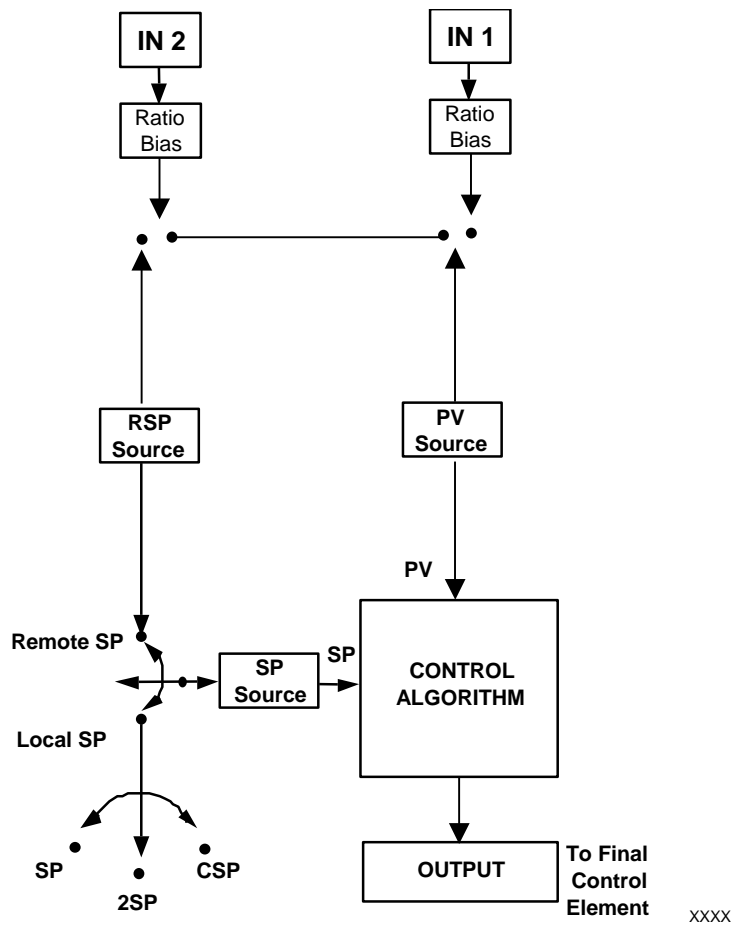


Figure 4-2 Functional Overview Block Diagram of the UDC2500 Controller

## 4.6 Single Display Functionality

### Introduction

This means that the displayed value of PV, Setpoint, Setpoint2, Remote Setpoint, Input 2, Output, Bias, Aux Out, and Deviation will appear on the top display and a prompt identifying the value will appear on the bottom display.

### Access the Values

Pressing the **LOWER DISPLAY** key will cycle through all applicable values (configuration dependent). One minute after the last press of the display key, the display will revert back to a configured default display. The default display is configured in the Input 1 Setup Group, and has three selections:

- Active Setpoint (**SP**)
- Process Variable (**PR Y**)
- Process Variable with no bottom display prompt (**PR n**).

### Exceptions

*There are three exceptions to the above rules.* The displays for PID SET, Timer and Setpoint Ramp will appear the same as on a dual display model and, when displaying Timer or Ramp values, the default display switchover feature is disabled.

### Auto-only Mode

The single display model is *Auto only* mode. The Auto/Manual key has no effect on controller mode. As a result of this, the failsafe mode is always non-latching.

While a failsafe condition exists, the controller output will assume the failsafe value. When the failsafe condition goes away, normal automatic operation continues.












## Single Display Parameters

**Table 4-5 Single Display Parameters**

Lower Display Prompt	Upper Display Value	Comments
(blank)	Process Variable	Default selection
PV	Process Variable	Default selection
SP	Local Setpoint #1	Default selection
2SP	Local Setpoint #2	Default selection
RSP	Remote Setpoint	Default selection
OUT	Output	
DEV	Deviation	
2IN	Input #2	
AUX	Aux Output value	
BIA	PD+MR bias value	
PIDS x	Process Variable	Active PID set
RP xxxM	Process Variable	SP Ramp time left
HH.MM or MM.SS	Process Variable	Timer display

## 4.7 Start Up Procedure for Operation

Table 4-6 Procedure for Starting Up the Controller

Single Display Step	Dual Display Step	Operation	Press	Result
1	1	Configure controller		Make sure the controller has been configured properly and that all the values and selections have been recorded on the Configuration Record Sheet. See steps 4 & 5.
	2	Select Manual Mode		N/A for Single Display Model Until "M" indicator is ON. The controller is in manual mode.
	3	Adjust the Output	 or 	N/A for Single Display Model To adjust the output value and ensure that the final control element is functioning correctly. <i>Upper Display</i> = PV Value <i>Lower Display</i> = OT and the output value in %
	4	Select Automatic Mode		N/A for Single Display Model Until "A" indicator is ON. The controller is in Automatic mode. The controller will automatically adjust the output to maintain the process variable at setpoint.
2	5	Enter the Local Setpoint	  or 	<i>Upper Display</i> = Pv Value <i>Lower Display</i> = SP and the Local Setpoint Value To adjust the local setpoint to the value at which you want the process variable maintained. The local setpoint cannot be changed if the Setpoint Ramp function is running.
3	6	Tune the Controller		Use Accutune to tune the controller; see product manual for detailed procedure or refer to Tuning Set Up group to set that the selections for PB or GAIN, RATE T, and I MIN or I RPM.

## 4.8 Control Modes

### ATTENTION

After changing a Local Setpoint value, if no other key is pressed, it then takes a minimum of thirty (30) seconds elapsed time before the new value is stored in non-volatile memory. If controller power is removed before this time, the new setpoint value is lost and the previous setpoint value is used at power-up. If, after changing the LSP value, another key is pressed, then the value is stored immediately.

### 4.8.1 Mode Definitions

Table 4-7 Control Mode Definitions

Control Mode	Definition
<b>AUTOMATIC with LOCAL SETPOINT</b>	In automatic local mode, the controller operates from the local setpoints and automatically adjusts the output to maintain the PV at the desired value. In this mode you can adjust the setpoint. See <i>Subsection 4.9 - Setpoints</i> .
<b>AUTOMATIC with REMOTE SETPOINT (optional)</b>	In automatic remote mode, the controller operates from the setpoint measured at the remote setpoint input. Adjustments are available to ratio this input and add a constant bias before it is applied to the control equation. See <i>Subsection 3.9 or 3.10, Input 1 or Input 2</i> .
<b>MANUAL (optional)</b>	In the manual mode, the operator directly controls the controller output level. The process variable and the percent output are displayed. The configured High and Low Output Limits are disregarded and the operator can change the output value, using the increment and decrement keys, to the limits allowed by the output type (0 % to 100 % for a time proportioning output or -5 % to 105 % for a current output).

**Manual Mode not available with Single Display model.**

## 4.8.2 What happens when you change modes

Table 4-8 Changing Control Modes (Dual Display Only)

Control Mode	Definition
<b>Manual to Automatic Local Setpoint</b>	The Local Setpoint is usually the value previously stored as the Local Setpoint. PV tracking is a configurable feature which modifies this. For this configuration, when the controller is in manual mode, the local setpoint value tracks the process variable value continuously.
<b>Manual or Auto Local to Automatic Remote SP</b>	The Remote Setpoint uses the stored ratio and bias to calculate the control setpoint.
<b>Automatic Remote Setpoint to Manual or Auto Local Setpoint</b>	If configured for local setpoint tracking, RSP, when the controller transfers out of remote setpoint the last value of the remote setpoint is inserted into the local setpoint. If LSP tracking is not configured, the local setpoint will not be altered when the transfer is made.

## 4.9 Setpoints

### Introduction





You can configure the following setpoints for the UDC2500 controller.

- A Single Local Setpoint
- 2 Local Setpoints
- a Local Setpoint and a Remote Setpoint

Refer to *Subsection 3.11 – Control Set Up Group* for configuration details.

### Changing the Setpoints

Table 4-9 Procedure for Changing the Local Setpoints


Step	Operation	Press	Result
1	Select the Setpoint		Until you see: <i>Upper Display = PV</i> <i>Lower Display = SP or 2L (Value)</i>
2	Change the Value	 or 	To change the Local Setpoint to the value at which you want the process maintained. The display “blinks” if you attempt to enter setpoint values beyond the high and low limits..
3	Return to PV Display		To store immediately or will store after 30 seconds.

## Switching between setpoints

You can switch Local and Remote setpoints or between two Local setpoints when configured.

**ATTENTION** The REMOTE SETPOINT value cannot be changed at the keyboard.

**Table 4-10 Procedure for Switching Between Setpoints**

Step	Operation	Press	Result
1	Select the Setpoint		<p>To alternately select Local Setpoint 1 (LSP) and the Remote Setpoint (RSP) or switch between the 2 Local Setpoints (LSP and 2L)</p> <p><b>ATTENTION</b> “KEY ERROR” will appear in the lower display, if:</p> <ul style="list-style-type: none"> <li>the remote setpoint or 2<sup>nd</sup> local setpoint is not configured as a setpoint source</li> <li>you attempt to change the setpoint while a setpoint ramp is enabled, or</li> <li>if you attempt to change the setpoint with the setpoint select function key disabled.</li> </ul>

## 4.10 Timer

### Introduction

The Timer provides a configurable Time-out period of from 0 to 99 hours:59 minutes or 0 to 99 minutes:99 seconds.

Timer “Start” is selectable as either the **RUN/HOLD** key or Alarm 2.

The Timer display can be either “Time Remaining” or “Elapsed Time”.

### Configuration check

Make sure:

- TIMER is enabled
- A TIMEOUT period has been selected (in hours and minutes or minutes and seconds)
- A TIMER FUNCTION START has been selected (KEY or AL2)
- A TIMER display has been selected (Time remaining or Elapsed time)
- A timer increment selected
- Timer reset selected

Refer to *Subsection 3.7 Algorithm Set Up Group* for details.

## Viewing Times

The times are viewed on the lower display as follows:

TIME REMAINING will show as a *decreasing* Hrs:Min value (HH:MM) or Min:Sec value (MM:SS) plus a *counterclockwise* rotating clock face.

ELAPSED TIME will show as an *increasing* Hrs:Min value(HH:MM) or Min:Sec value (MM:SS) plus a *clockwise* rotating clock face.



## Operation

When the Timer is enabled (RUN/HOLD key or ALARM 2), it has exclusive control of Alarm 1 relay.

At “TIME-OUT”:

- Alarm 1 is active
- The clock character has stopped moving
- The Time display shows either 00:00 or the time-out period depending on the configuration selection
- The Timer is ready to be reset

At “RESET”:

- Alarm 1 relay is inactive
- The time display shows the time-out period
- The time-out period can be changed at this time using the  or  keys.
- The Timer is ready to be activated

## 4.11 Accutune III

### Introduction

Accutune III (TUNE) may be used for self-regulating and single integrating processes. This autotuning method is initiated on-demand, typically at initial start-up.

There are no other requirements necessary, such as prior knowledge to the process dynamics or initial or post tune process line-out to setpoint or manual output.

Also, the setpoint value is not required to change in order to initiate the tuning process, but the controller must be in the Automatic mode to start tuning. The process need not be in a static (lined out) state and may be dynamic (changing with a steady output).

### Configuration check

Make sure:

- TUNE has been enabled see to *Subsection 3.6 - Accutune Set Up Group* for details.

### Tuning indicators

“TUNE” will flash in the upper display until tuning is completed.

### Operation

The “TUNE” (Accutune II) algorithm provides user-friendly, on-demand tuning in this controller. No knowledge of the process is required at start-up. The operator simply initiates the tuning while in the automatic mode.

Once Accutune III has been enabled in the TUNE setup group, either “SLOW” or “FAST” tuning may be used. Which one is used is selected via the lower display during normal operation.

For the SLOW selection, the controller calculates conservative tuning constants with the objective of minimizing overshoot. If the controller determines that the process has appreciable dead time, it will automatically default to use Dahlin Tuning, which produces very conservative tuning constants. The SLOW selection may be useful for TPSC applications, as it reduces any “hunt” problems for the motor.

For the FAST selection, the controller calculates aggressive tuning constants with the objective of producing quarter damped response. Depending upon the process, this selection will usually result in some overshoot. For this reason, it may be desirable to enable the FUZZY tune selection. See Section 4.12. When Fuzzy tune is enabled, it will work to suppress or eliminate any overshoot that may occur as a result of the calculated tuning parameters as the PV approaches the setpoint.








The TUNE process will cycle the controller’s output two full cycles between the low and high output limits while allowing only a very small Process Variable change above and below the SP during each cycle. “TUNE” flashes in the upper display until tuning is completed.

At the end of the tuning process, the controller immediately calculates the tuning constants and enters them into the Tuning group, and begins PID control with the correct tuning parameters. This works with any process, including integrating type processes, and allows retuning at a fixed setpoint.

### 4.11.1 Tune for Simplex Outputs

After “TUNE” has been enabled, you can start Accutune as shown in Table 4-11.

**Table 4-11 Procedure for Starting “TUNE”**

Step	Operation	Press	Result
1	Configure LSP1		Until <b>SP</b> (Local Setpoint 1) shows in the lower display.
2		 or 	Until LSP1 is to the desired value.
3	Switch to “Automatic” Mode		Until the “A” indicator is lighted (on controllers with Manual option).
4	Show Tuning Prompt		Until “NoTUNE” is shown on lower display.
5	Initiate Tuning		Select “DoSLOW” or “DoFAST” in lower display.
6	Tuning in operation		Upper display will flash “TUNE” as long as ACCUTUNE process is operating. When process completes, tuning parameters are calculated and lower display will show “NoTune” prompt.

#### ATTENTION

The Accutune process may be aborted at any time by changing the lower display back to “NoTUNE” or by switching the controller into Manual Mode.

### 4.11.2 Tune for Duplex (Heat/Cool)

Accutune for applications using Duplex (Heat/Cool) control.

The controller must be configured to have two local setpoints unless Blended Tuning is desired (see below). See *Subsection 3.11- Control Set Up Group* for details on configuring two local setpoints. During tuning, the Accutune III process assumes that Local Setpoint 1 will cause a Heating demand (output above 50%), and the tuning parameters calculated for that setpoint are automatically entered as PID SET 1. Likewise, Accutune III assumes that Local Setpoint 2 will cause a Cooling demand (output less than 50%), and the tuning parameters calculated for that setpoint are automatically entered as PID SET 2.



## Configuration Check for Duplex

See *Subsection 3.6 - Accutune Set Up Group* for details.






Make sure:

- TUNE has been enabled
- DUPLEX has been configured to Manual, Automatic or Disabled

### 4.11.3 Using AUTOMATIC TUNE at start-up for Duplex (Heat/Cool)

Used when DUPLEX has been configured for AUTOMATIC. This is the preferred selection for most Heat/Cool applications when tuning a new chamber. This selection will sequentially perform both Heat and Cool tuning without further operator intervention.

**Table 4-12 Procedure for Using AUTOMATIC TUNE at Start-up for Duplex Control**





Step	Operation	Press	Result
1	Configure LSP1		Until <b>SP</b> (Local Setpoint 1) shows in the lower display.
2		▲ or ▼	Until LSP1 is a value within the <b>Heat Zone</b> (output above 50%).
3	Configure LSP2		Until <b>2SP</b> (Local Setpoint 2) shows in the lower display.
4		▲ or ▼	Until LSP2 is a value within the <b>Cool Zone</b> (output below 50%).
5	Switch to "Automatic" Mode		Until the "A" indicator is lighted (on controllers with Manual option).
6	Show Tuning Prompt		Until "NoTUNE" is shown on lower display.
7	Initiate Tuning	▲	Select "DoSLOW" or "DoFAST" in lower display.
	Tuning in operation		Upper display will flash "TUNE" as long as ACCUTUNE process is operating. When process completes, tuning parameters are calculated and lower display will show "NoTune" prompt.

### 4.11.4 Using BLENDED TUNE at start-up for Duplex (Heat/Cool)

When DUPLEX has been configured for DISABLE. This is the preferred selection for Heat/Cool applications which use a highly insulated chamber (a chamber which will lose heat very slowly unless a cooling device is applied). Only one local setpoint (LSP 1) is needed for this selection.

This selection results in performance tuning over the full range utilizing both Heat and Cool outputs to acquire blended tune values that are then applied to both Heat and Cool tuning parameters. Both PID sets are set to the same values.




**Table 4-13 Procedure for Using BLENDED TUNE at Start-up for Duplex Control**


Step	Operation	Press	Result
1	Configure LSP1		Until <b>SP</b> (Local Setpoint 1) shows in the lower display.
2		▲ or ▼	Until the Setpoint is to the desired value.
3	Switch to "Automatic" Mode		Until the "A" indicator is lighted (on controllers with Manual option).
4	Show Tuning Prompt		Until "NoTUNE" is shown on lower display.
5	Initiate Tuning	▲	Select "DoSLOW" or "DoFAST" in lower display.
6	Tuning in operation		Upper display will flash "TUNE" as long as ACCUTUNE process is operating. When process completes, tuning parameters are calculated and lower display will show "NoTune" prompt.

#### 4.11.5 Using MANUAL TUNE at start-up for Duplex (Heat/Cool)





When DUPLEX has been configured for MANUAL. This selection should be used when tuning is needed only for the HEAT zone or only for the COOL zone but not both. If Local Setpoint 1 is used, then the controller will perform a HEAT zone tune. If Local Setpoint 2 is used, then the controller will perform a COOL zone tune.

**Table 4-14 Procedure for Using MANUAL TUNE for Heat side of Duplex Control**

Step	Operation	Press	Result
1	Configure LSP1		Until <b>SP</b> (Local Setpoint 1) shows in the lower display.
2		▲ or ▼	Until LSP1 is a value within the <b>Heat Zone</b> (output above 50%).
3	Switch to "Automatic" Mode		Until the "A" indicator is lighted (on controllers with Manual option).
4	Show Tuning Prompt		Until "NoTUNE" is shown on lower display.
5	Initiate Tuning	▲	Select "DoSLOW" or "DoFAST" in lower display.

Step	Operation	Press	Result
6	Tuning in operation		Upper display will flash "TUNE" as long as ACCUTUNE process is operating. When process completes, tuning parameters are calculated and lower display will show "NoTune" prompt.

**Table 4-15 Procedure for Using MANUAL TUNE for Cool side of Duplex Control**

Step	Operation	Press	Result
1	Configure LSP2		Until <b>2SP</b> (Local Setpoint 2) shows in the lower display.
2		▲ or ▼	Until LSP2 is a value within the <b>Cool Zone</b> (output below 50%).
3	Switch to "Automatic" Mode		Until the "A" indicator is lighted (on controllers with Manual option).
4	Show Tuning Prompt		Until "NoTUNE" is shown on lower display.
5	Initiate Tuning	▲	Select "DoSLOW" or "DoFAST" in lower display.
6	Tuning in operation		Upper display will flash "TUNE" as long as ACCUTUNE process is operating. When process completes, tuning parameters are calculated and lower display will show "NoTune" prompt.

## 4.11.6 Error Codes

Table 4-16 Procedure for Accessing Accutune Error Codes



Step	Operation	Press	Result
1	Select Accutune Set-up Group		Upper Display = <b>SET</b> Lower Display = <b>ATUNE</b>
2	Go to Error Code Prompt		Upper Display = <b>(an error code)</b> Lower Display = <b>ATERR</b> <b>Table 4-17 lists all the error codes, definitions, and fixes.</b>

Table 4-17 Accutune Error Codes

Error Code (Upper Display)	Definition	Fix
<b>RUN</b>	ACCUTUNE RUNNING	The Accutune process is still active (Read Only)
<b>NONE</b>	NO ERRORS OCCURRED DURING LAST ACCUTUNE PROCEDURE	None
<b>IDFL</b>	PROCESS IDENTIFICATION FAILURE Autotune has aborted because an illegal value of GAIN, RATE, or reset was calculated.	<ul style="list-style-type: none"> <li>Illegal Values – try Accutune again.</li> <li>untunable process -- contact local application engineer.</li> </ul>
<b>ABRT</b>	CURRENT ACCUTUNE PROCESS ABORTED caused by the following conditions: <i>a. Operator changed to Manual mode</i> <i>b. Digital Input detected</i> <i>c. In Heat region of output and a Cool output calculated or vice versa.</i>	Try Accutune again
<b>SP2</b>	LSP2 not enabled or LSP1 or LSP2 not in use (only applies to Duplex Tuning)	Enable LSP2 and configure the desired LSP1 and LSP2 setpoints.

### Aborting Accutune

To abort Accutune and return to the last previous operation (SP or output level), press **M-A/RESET** key to abort the Accutune process.

## Completing Accutune

When Accutune is complete, the calculated tuning parameters are stored in their proper memory location and can be viewed in the TUNING Set up Group, and the controller will control at the local setpoint using these newly calculated tuning constants.

## 4.12 Fuzzy Overshoot Suppression

### Introduction

Fuzzy Overshoot Suppression minimizes Process Variable overshoot following a setpoint change or a process disturbance. This is especially useful in processes which experience load changes or where even a small overshoot beyond the setpoint may result in damage or lost product.

### How it works

The fuzzy logic observes the speed and direction of the PV signal as it approaches the setpoint and temporarily modifies the internal controller response action as necessary to avoid an overshoot. There is no change to the PID algorithm, and the fuzzy logic does not alter the PID tuning parameters. This feature can be independently Enabled or Disabled as required by the application to work with “TUNE” (On-Demand) Accutune III tuning algorithm.

### Configuration

To configure this item, refer to Section 3 - Configuration:

Set Up Group “**ATUNE**”

Function Prompt “**FUZZY**”

Select “**ENAB**”(enable) or “**DIS**” (disable) - Use ▲ or ▼.

## 4.13 Using Two Sets of Tuning Constants

### Introduction

You can use two sets of tuning constants for single output types and choose the way they are to be switched. (Does not apply for Duplex control.)

The sets can be:









- keyboard selected,
- automatically switched when a predetermined process variable value is reached,
- automatically switched when a predetermined setpoint value is reached.

## Set up Procedure

Use the following procedure (Table 4-18) to:





- select two sets,
- set the switch-over value,
- set tuning constant value for each set.

**Table 4-18 Set Up Procedure**

Step	Operation	Press	Result
1	Select Control Set-up Group		Until you see: <i>Upper Display</i> = <b>SET</b> <i>Lower Display</i> = <b>CONTRL</b>
2	Select PID SETS		Until you see: <i>Upper Display</i> = <b>(available selections)</b> <i>Lower Display</i> = <b>PID SETS</b>
3	Select PID SETS Function	 or 	To select the type of function. Available selections are: <b>ONE</b> —1 set of constants <b>2 KBD</b> —2 sets, keyboard selectable <b>2 PR</b> —2 sets, auto switch at PV value <b>2 SP</b> —2 sets, auto switch at SP value
4	Set Tuning Values for Each Set		Refer to “TUNING” Set up group, subsection 3.4 and set the following tuning parameters: PB or GAIN* RATE T* I MIN or I RPM* CYCT1 or CTIX3* PB2 or GAIN2** RATE 2T** I2MIN or I2RPM** CYC2T2 or CT2X3**  *PIDSET1 will be used when PV or SP, whichever is selected, is <b>greater</b> than the switchover value.  **PIDSET2 will be used when PV or SP, whichever is selected, is <b>less</b> than the switchover value.
5	Set Switchover Value for 2PR or 2SP Selection	   or 	Until you see: <i>Upper Display</i> = <b>(the switchover value)</b> <i>Lower Display</i> = <b>SW VAL</b>  To select the switchover value in the upper display.

Switch between two sets via keyboard (without automatic switch-over)

**Table 4-19 Procedure for Switching PID SETS from the Keyboard**

Step	Operation	Press	Result
1	Select Control Set-up Group		Until you see: <i>Upper Display = (the PV value)</i> <i>Lower Display = PIDS X (X= 1 or 2)</i>
2		 or 	To change PID SET 1 to PID SET2 or Vice Versa. You can use Accutune on each set.
3			To accept changes.

## 4.14 Alarm Setpoints

### Introduction

An alarm consists of a relay contact and an operator interface indication. The alarm relay is de-energized if setpoint 1 or setpoint 2 is exceeded.



The alarm relay is energized when the monitored value goes into the allowed region by more than the hysteresis.




The relay contacts can be wired for normally open (NO) energized or normally closed (NC) de-energized using internal jumper placement. See Table 2-3 in the *Section 2 – Installation* for alarm relay contact information.

There are four alarm setpoints, two for each alarm. The type and state (High or Low) is selected during configuration. See *Subsection 3.13 – Configuration* for details.

### Alarm Setpoints Display

**Table 4-20 Procedure for Displaying Alarm Setpoints**

Step	Operation	Press	Result
1	Select Alarm Set-up Group		Until you see: <i>Upper Display = SET</i> <i>Lower Display = ALARMS</i>
2	Access the Alarm Setpoint Values		To successively display the alarm setpoints and their values. Their order of appearance is shown below. <i>Upper Display = (the alarm setpoint value)</i> <i>Range values are within the range of the selected parameters except:</i> <b>DEVIATION (DE)</b> value = PV Span <b>EVENTS (E-ON/E-OFF)</b> value = Event Segment Number <b>PV RATE OF CHANGE (PVRT)</b> = The amount of PV change in one minute in engineering units. <b>LOOP BREAK ALARMS (BRAK)</b> = The timer value may be changed only for controllers configured for ON/OFF.

Step	Operation	Press	Result
			<i>Lower Display = A1S1VA = Alarm 1, Setpoint 1</i> <i>A1S2VA = Alarm 1, Setpoint 2</i> <i>A2S1VA = Alarm 2, Setpoint 1</i> <i>A2S2VA = Alarm 2, Setpoint 2</i>
			NOTES: <i>With 3 position step control, alarms set for "output" will not function.</i> <i>MAN, RSP, AND FSAF selections do not have setpoint values.</i>
3	Change a value	 or 	To change any alarm setpoint value in the upper display.
4	Return to Normal Display		

## 4.15 Three Position Step Control Algorithm

### Introduction

The Three Position Step Control algorithm allows the control of a valve (or other actuator) with an electric motor driven by two controller output relays; one to move the motor upscale, the other to move it downscale, without a feedback slidewire linked to the motor shaft.

### Estimated Motor Position

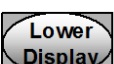
The Three Position Step control algorithm provides an output display ("OT") which is an estimated motor position since the motor is not using any feedback.

- Although this output indication is only accurate to a few percent, it is corrected each time the controller drives the motor to one of its stops (0 % or 100 %).
- It avoids all the control problems associated with the feedback slidewire (wear, dirt, and noise).
- When operating in this algorithm, the estimated "OT" display is shown to the nearest percent (that is, no decimal).

See Motor Travel Time (the time it takes the motor to travel from 0 % to 100 %) in section 3.8.

### Motor Position Display

Table 4-21 Procedure for Displaying 3Pstep Motor Position

Step	Operation	Press	Result
1	Access the Displays		Until you see: <i>Upper Display = PV</i> <i>Lower Display = OT (The estimated motor position in %)</i>








## 4.16 Setting a Failsafe Output Value for Restart After a Power Loss

### Introduction

If the power to the controller fails and power is reapplied, the controller goes through the power up tests, then goes to a user configured FAILSAFE OUTPUT VALUE.

### Set a Failsafe Value

Table 4-22 Procedure for Setting a Failsafe Value

Step	Operation	Press	Result
1	Select Control Set-up Group		Until you see: <i>Upper Display = SET</i> <i>Lower Display = CONTRL</i>
2	Select Failsafe Function Prompt		You will see: <i>Upper Display = (range)</i> <i>within the range of the Output 0 to 100 for all output types except 3 Position Step</i> <b>3 Position Step</b> <i>0 = motor goes to closed position</i> <i>100 = motor goes to open position</i> <i>Lower Display = FAILSF</i>
3	Select a value	 or 	To select a failsafe output value in the upper display
4	Return to Normal Display		At power up, the output will go to the value set.



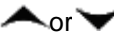

## 4.17 Setting Failsafe Mode

### Introduction

You can set the Failsafe Mode to be Latching or Non-Latching.

### Set Failsafe Mode

**Table 4-23 Procedure for Setting a Failsafe Mode**

Step	Operation	Press	Result
1	Select Control Set-up Group		Until you see: <i>Upper Display</i> = <b>SET</b> <i>Lower Display</i> = <b>CONTRL</b>
2	Select Failsafe Function Prompt		You will see: <i>Upper Display</i> = <b>LACH</b> (Controller goes to manual and output goes to failsafe value) <b>NO L</b> (Controller mode does not change and output goes to failsafe value) <i>Lower Display</i> = <b>FSMODE</b>
3	Select a value		To select a failsafe mode in the upper display.
4	Return to Normal Display		At power up, the output will go to the value set.

## 4.18 Setpoint Rate/Ramp/Program Overview

### Introduction

The Setpoint Ramp configuration group lets you enable and configure any of the following:

- **SPRATE** – a specific rate of change for any local setpoint change. (Subsection 4.20)
- **SPRAMP** – a single setpoint ramp that occurs between the current local setpoint and a final local setpoint over a time interval of 1 to 255 minutes. (Subsection 4.19)
- **SPPROG** – a ramp/soak profile in a 12-segment program. (Subsection 4.21)

This section explains the operation of each selection and configuration reference where necessary.

### PV Hot Start

This is a standard feature. At power-up, the setpoint is set to the current PV value and the Rate or Ramp or Program then starts from this value.

## RUN/HOLD key

You can start or stop the Ramp or Program using the **RUN/HOLD** key.

## 4.19 Setpoint Ramp

### Introduction

When you have configured a SETPOINT RAMP, the ramp will occur between the current local setpoint and a final local setpoint over a time interval of from 1 to 255 minutes. You can RUN or HOLD the ramp at any time.

### Configuration Check






Make sure

- SPRAMP is enabled
- A Ramp Time (TIMIN) in minutes has been configured
- A final setpoint value (FINLSP) has been configured. See Subsection 3.5 – Configuration group “SPRAMP” for details.

### Operation

Running a Setpoint Ramp includes starting, holding, viewing the ramp, ending the ramp and disabling it. See Table 4-24.

**Table 4-24 Running A Setpoint Ramp**

Step	Operation	Press	Result
1	Select Automatic Mode		“A” indicator is on. <i>Upper Display</i> = Hold and PV value <i>Lower Display</i> = SP and Present value
2	Set Start Setpoint		Until start SP value is in lower display <i>Upper Display</i> = Hold and PV value <i>Lower Display</i> = SP and start SP value
3	Start the Ramp		You will see <i>Upper Display</i> = Run and a changing PV value <i>Lower Display</i> = SP and a changing SP value increasing or decreasing toward a final SP value
4	Hold/Run the Ramp		This holds the ramp at the current setpoint value. Press again to continue.
5	View the remaining ramp time		Until you see <i>Upper Display</i> = RUN or HOLD and the PV value <i>Lower Display</i> = <b>RP xx HH.MM</b> (time remaining)

Step	Operation	Press	Result
6	End the Ramp		When the final setpoint is reached, "RUN" changes to "HOLD" in the upper display and the controller operates at the new final setpoint.
7	Disable SPRAMP		See Section 3 – Configuration group "SPRAMP" for details.

---

### Power Outage

If power is lost during a ramp, upon power-up the controller will be in HOLD and the setpoint value will be the setpoint value prior to the beginning of the setpoint ramp.

The ramp is placed in hold at the beginning.

Configure the mode at Set Up Group "CONTROL", function prompt "PWRUP". See Subsection 3.11 – CONTRL GROUP FUNCTION Prompts.

## 4.20 Setpoint Rate

### Introduction

When you have configured a SETPOINT RATE, it will apply immediately to local setpoint change.

### Configuration check

Make sure:

- SPRATE is enabled
- SP RATE and SPPROG are not running.
- A Rate Up (EUHRUP) or Rate Down (EUHRDN) value has been configured in Engineering units per hour.

#### ATTENTION

A value of 0 will imply an immediate change in setpoint, that is, NO RATE applies. See Subsection 3.5 – Configuration group "SPRAMP" for details.)

---

### Operation

When a change to local setpoint is made, this controller will ramp from the original setpoint to the "target" setpoint at the rate specified.

The current setpoint value can be viewed at Sn on the lower display.

### Power outages

If power is lost before the "target" setpoint is reached, upon power recovery, the controller powers up with Sn = Current PV value and it automatically "Restarts" from Sn = current PV value up to the original "target" setpoint.

## 4.21 Setpoint Ramp/Soak Programming

### Introduction

The term “programming” is used here to identify the process for selecting and entering the individual ramp and soak segment data needed to generate the required setpoint versus time profile (also called a program).

A segment is a ramp or soak function which together make up a setpoint program. Setpoint Ramp/Soak Programming lets you configure six ramp and six soak segments to be stored for use as one program or several small programs. You designate the beginning and end segments to determine where the program is to start and stop.

### Review program data and configuration

While the procedure for programming is straightforward, and aided by prompts, we suggest you read “Program Contents”. Table 4-25 lists the program contents and an explanation of each to aid you in configuration. Then refer to Subsection 3.5 – Configuration to do the setpoint program.

Make sure SPRATE and SPRAMP are disabled.

### Fill out the worksheet

Refer to the example in Figure 4-3 and draw a Ramp/Soak Profile on the worksheet provided (Figure 4-4) and fill in the information for each segment. This will give you a record of how the program was developed.

### Operation

Refer to Table 4-26 Run/Monitor the program.

### Program Contents

Table 4-25 lists all the program contents and a description of each.

**Table 4-25 Program Contents**

Contents	Definition
<b>Ramp time or rate segments</b>	<p>A ramp segment is the time or rate of change it takes to change the setpoint to the next setpoint value in the program.</p> <ul style="list-style-type: none"> <li>• Ramps are odd number segments. Segment #1 will be the initial ramp time.</li> <li>• Ramp time is determined in either:               <ul style="list-style-type: none"> <li>TIME* - Hours:Minutes      Range = 0-99 hr.:59 min.</li> <li>or</li> <li>EU-M* - Degrees/Minute Range = 0 to 999</li> <li>EU-H* - Degrees/Hour</li> </ul> </li> </ul> <p>*The selection of time or rate is made at prompt “RP UNIT” - Set this prompt before entering any Ramp information.</p>

Contents	Definition
	<p><b>ATTENTION</b> Entering “0” will imply an immediate step change in setpoint to the next soak.</p>
<b>Ramp unit</b>	<p>The ramp unit selection determines the engineering units for the ramp segments.</p> <p>The selections are:</p> <ul style="list-style-type: none"> <li>• TIME = Hours:Minutes (XX:XX) Range: 0-99 hr.:0-59 min</li> <li>• EU-H = Degrees/Hour OR EU-M = Degrees/Minute (Range – 0-999)</li> </ul>
<b>Soak segments</b>	<p>A soak segment is a combination of soak setpoint (value) and a soak duration (time).</p> <ul style="list-style-type: none"> <li>• Soaks are even number segments.</li> <li>• Segment 2 will be the initial soak value and soak time.</li> <li>• The soak setpoint range value must be within the setpoint high and low range limits in engineering units.</li> <li>• Soak time is the duration of the soak and is determined in: TIME - Hours:Minutes Range = 0-99 hr.:59 min.</li> </ul>
<b>Start segment number</b>	<p>The start segment number designates the number of the first segment. Range = 1 to 11</p>
<b>End segment number</b>	<p>The end segment number designates the number of the last segment, it must be a soak segment (even number). Range = 2 to 12</p>
<b>Recycle number</b>	<p>The recycle number allows the program to recycle a specified number of times from beginning to end. Range = 0 to 99</p>
<b>Guaranteed soak</b>	<p>All soak segments can have a deviation value of from 0 to <math>\pm 99</math> (specified by SOK DEV) which guarantees the value for that segment.</p> <p><b>Guaranteed</b> soak deviation values <math>&gt;0</math> guarantee that the soak segment’s process variable is within the <math>\pm</math> deviation for the configured soak time. Whenever the <math>\pm</math> deviation is exceeded, soak timing is frozen.</p> <p>There are no guaranteed soaks whenever the deviation value is configured to 0, (that is, soak segments start timing soak duration as soon as the soak setpoint is first reached, regardless of where the process variable remains relative to the soak segment).</p> <p>The soak deviation value is the number in engineering units, above or below the setpoint, outside of which the timer halts. The range is 0 to <math>\pm 99</math>.</p> <p>The decimal location corresponds to input 1 decimal selection.</p>
<b>PV Start</b>	<p>This function determines whether LSP1 or PV is used as the setpoint when the program is initially changed from HOLD to RUN.</p> <p>The selections are:</p> <p><b>DISABL</b> = When the program is initially changed from HOLD to RUN the present LSP1 value is captured as the default setpoint. If the program is terminated or the power cycled before the program has completed, the LSP1 is used as the control setpoint. The beginning segment uses this value as the initial ramp setpoint.</p>

Contents	Definition
	<p><b>ENABL</b> = When the program is initially changed from HOLD to RUN the present PV value is captured and used as the beginning setpoint value for the ramp segment. If the program is terminated before completion, the setpoint value will revert back to the PV value captured at the initial HOLD to RUN transition. If the power is cycled before program completion, upon power-up the setpoint is set to the PV value at power-up and when the program is restarted that setpoint value is used initially.</p>
<p><b>Program state</b></p>	<p>The program state selection determines the program state after completion.</p> <p>The selections are:</p> <ul style="list-style-type: none"> <li>• <b>DIS</b> = program is disabled (so program value changed to DIS)</li> <li>• <b>HOLD</b> = program on hold</li> </ul>
<p><b>Program termination state</b></p>	<p>The program termination state function determines the status of the controller upon completion of the program.</p> <p>The selections are:</p> <ul style="list-style-type: none"> <li>• <b>LAST</b> = controls to last setpoint</li> <li>• <b>FSAF</b> = manual mode and failsafe output.</li> </ul>
<p><b>Reset Program to Beginning</b></p>	<p>When enabled, this selection allows you to reset the program to the beginning from the keyboard.</p>

### Ramp/soak profile example

Before you perform the actual configuration, we recommend that you draw a Ramp/Soak profile in the space provided on the “*Program Record Sheet*” (Figure 4-4) and fill in the associated information. An example of a Ramp-Soak Profile is shown in Figure 4-3. Start setpoint is at 200 degrees F.

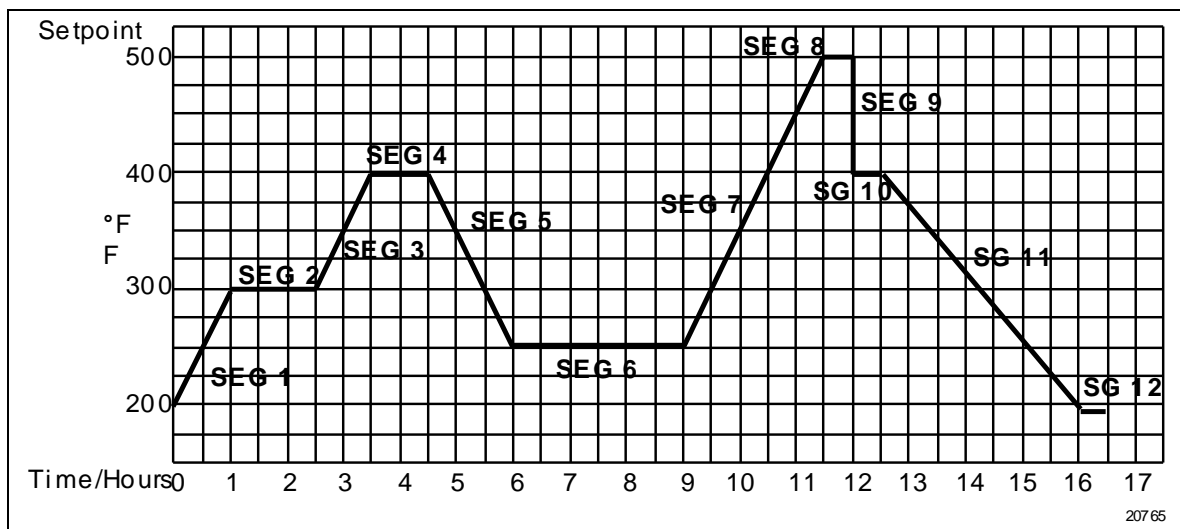


Figure 4-3 Ramp/Soak Profile Example

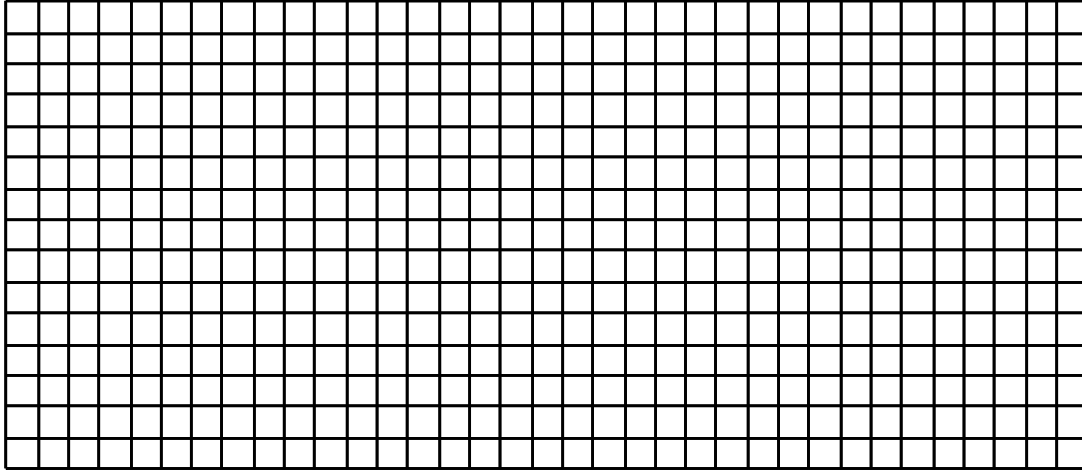
Ramp/Soak Profile Example

Prompt	Function	Segment	Value	Prompt	Function	Segment	Value
STRSEG	Start Seg.		1	SG4 TI	Soak Time	4	1 hr.
ENDSEG	End Seg.		12	SG5 RP	Ramp Time	5	1 hr.:30 min.
RP UNIT	Engr. Unit for Ramp		TIME	SG6 SP	Soak SP	6	250
PG END	Controller Status		LAST SP	SG6 TI	Soak Time	6	3 hr.:0 min.
STATE	Controller State at end		HOLD	SG7 RP	Ramp Time	7	2 hr.:30 min.
TO BEGIN	Reset SP Program		DIS	SG8 SP	Soak SP	8	500
PVSTRT	Program starts at PV value		DIS	SG8 TI	Soak Time	8	0 hr.:30 min.
RECYCL	Number of Recycles		2	SG9 RP	Ramp Time	9	0
SOKDEV	Deviation Value		0	SG10 SP	Soak SP	10	400
SG1 RP	Ramp Time	1	1 hr.	SG10 TI	Soak Time	10	0 hr.:30 min.
SG2 SP	Soak SP	2	300	SG11 RP	Ramp Time	11	3 hr.:30 min.
SG2 TI	Soak Time	2	1 hr.:30 min.	SG12 SP	Soak SP	12	200
SG3 RP	Ramp Time	3	1 hr.	SG12TI	Soak Time	12	0 hr.:30 min.
SG4 SP	Soak SP	4	400				



**Program record sheet**

Draw your ramp/soak profile on the record sheet shown in Figure 4-4 and fill in the associated information in the blocks provided. This will give you a permanent record of your program and will assist you when entering the Setpoint data.



**Figure 4-4 Program Record Sheet**

Prompt	Function	Segment	Value	Prompt	Function	Segment	Value
STRSEG	Start Seg.			SG4 TI	Soak Time	4	
ENDSEG	End Seg.			SG5 RP	Ramp Time	5	
RP UNIT	Engr. Unit for Ramp			SG6 SP	Soak SP	6	
RECYCL	Number of Recycles			SEG6 TI	Soak Time	6	
SOKDEV	Deviation Value			SG7 RP	Ramp Time	7	
PG END	Controller Status			SG8 SP	Soak SP	8	
STATE	Program Controller State			SG8 TI	Soak Time	8	
TO BEGIN	Reset SP Program			SG9 RP	Ramp Time	9	
PVSTRT	Program starts at PV value			SG10 SP	Soak SP	10	
SG1 RP	Ramp Time	1		SG10 TI	Soak Time	10	
SG2 SP	Soak SP	2		SG11RP	Ramp Time	11	
SG2 TI	Soak Time	2		SG12SP	Soak SP	12	
SG3 RP	Ramp Time	3		SG12TI	Soak Time	12	
SG4 SP	Soak SP	4					

## Run/Monitor the program

Prior to running the program, make sure all the “SP PROG” function prompts under the Set Up group “SP RAMP” have been configured with the required data.





“HOLD” appears periodically in the upper display indicating that the program is in the HOLD state.


**ATTENTION** SP Programmer parameter *cannot* be changed during RUN state (must be in HOLD state).

## Run/Monitor functions

Table 4-26 lists all the functions required to run and monitor the program.

**Table 4-26 Run/Monitor Functions**

Function	Press	Result
Set the Local Setpoint		<i>Upper Display = PV value</i> <i>Lower Display = SP</i>
	▲ or ▼	To set the Local Setpoint value to where you want the program to start out.
Run State		Initiates the setpoint program. “ <b>RUN</b> ” appears in the upper display indicating that the program is running.
Hold State		Holds the setpoint program. “ <b>HOLD</b> ” appears in the upper display indicating that the program is in the HOLD state. The setpoint holds at the current setpoint.
External Hold		If one of the Digital Inputs is programmed for the HOLD function, then contact closure places the controller in the HOLD state, if the setpoint program is running. The upper display will periodically show “ <b>HOLD</b> ” while the switch is closed. <b>ATTENTION</b> The keyboard takes priority over the external switch for the RUN/HOLD function. Reopening the HOLD switch runs the program.
To Begin	▲ or ▼	To go back to the beginning of the program.
Viewing the present ramp or soak segment number and time	 until you see	<i>Upper Display = PV value</i> <i>Lower Display = XXHH.MM</i> Time remaining in the SEGMENT in hours and minutes. XX = The current number, 1 to 12.

Function	Press	Result
Viewing the number of cycles left in the program	 until you see	<i>Upper Display</i> = PV value <i>Lower Display</i> = <b>REC_XX</b>  Number of cycles remaining in the setpoint program. X = 0 to 99
End Program		When the final segment is completed, the “ <b>RUN</b> ” in the upper display either changes to “ <b>HOLD</b> ” (if configured for HOLD state), or disappears (if configured for disable of setpoint programming). <ul style="list-style-type: none"> <li>• The controller either operates at the last setpoint in the program or goes into manual mode/failsafe output.</li> </ul>
Disable Program		See Section 3 – Configuration Group “SPPROG” for details.

## Power outage

**ATTENTION** If power is lost during a program, upon power-up the controller will be in hold and the setpoint value will be the setpoint value prior to the beginning of the setpoint program. The program is placed in hold at the beginning. The mode will be as configured under “PWR UP” in the “CONTROL” group.

## Digital input (remote switch) operation

Program can be placed in RUN or HOLD state through a remote dry contact connected to optional digital input terminals, as follows:

RUN—contact closure places Program in RUN state, OR

HOLD—contact closure places Program in HOLD state

Opening the contact will cause the Controller to revert to its original state.

## 4.22 P.I.E. Tool Maintenance Screens

### Introduction

This controller uses special P.I.E. Tool<sup>®</sup> Maintenance Screens which allow remote access and access to functions not accessible via the controller's display and keyboard. The figures in this section show screen-shots of the Maintenance Screens from the PC version of the P.I.E. Tool<sup>®</sup>. Pocket PC Maintenance Screens are generally similar in format but smaller.

---

### ATTENTION

Your instrument may not have all of the screens and parameters shown in this section.

---

### Loop Data

Select **Loop Data** from the **Maintenance Data** menu.

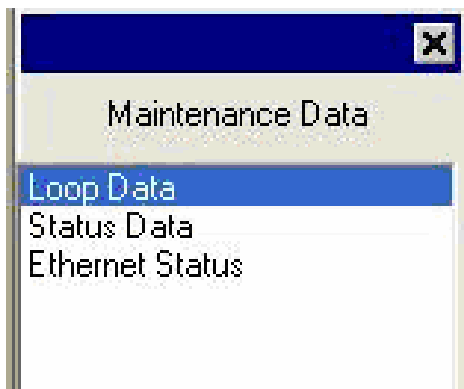
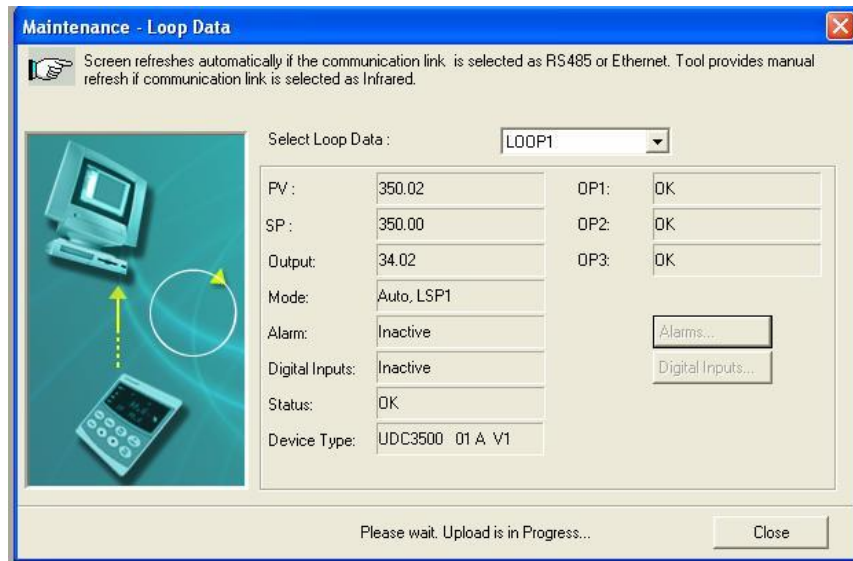


Figure 4-5 Maintenance Data Menu



**Figure 4-6 Loop Data Maintenance Screen**

The Loop Data screen allows you to see the current status of the process loop. The **OP1**, **OP2** and **OP3** windows indicate the status of the current outputs. If a current output is not installed, the OP status for that output is always **OK**.

The **Alarms** and **Digital Inputs** buttons allow you to see the current status of each alarm setpoint and digital input.

### Loop Data – Alarm Details

This screen appears when you click on the **Alarm** button on the Loop Data Maintenance Screen and shows the status of each alarm setpoint. **NONE** in the Type column indicates that the alarm is disabled. Highlighted alarms are currently active. An asterisk (\*) indicates that the alarm has changed state since the last communications transaction.

For this instrument, the **Alarm On** and **Alarm Off** columns will always be blank.

See Section 3.14 for other information about configuring Alarms.

Alarm	Type	Event	Value	Actual	Alarm On	Alarm Off
Alarm1-SP1	IN 1	HIGH/END	500.00	249.99		
Alarm1-SP2	NONE	LOW /BEGIN	0.00	0.00		
Alarm2-SP1	NONE	LOW /BEGIN	0.00	0.00		
Alarm2-SP2	NONE	LOW /BEGIN	0.00	0.00		

Figure 4-7 Alarm Details Maintenance Screen

## Loop Data – Digital Input Details

This screen appears when you click on the **Digital Inputs** button on the Loop Data Maintenance Screen and shows the status of each Digital Input. **NONE** in the Type column indicates that the Digital Input is disabled. Highlighted Digital Inputs are currently active. An asterisk (\*) indicates that the alarm has changed state since the last communications transaction.

This instrument has a maximum of two Digital Inputs. Digital Inputs 3 through 8 will always appear as **NONE**.

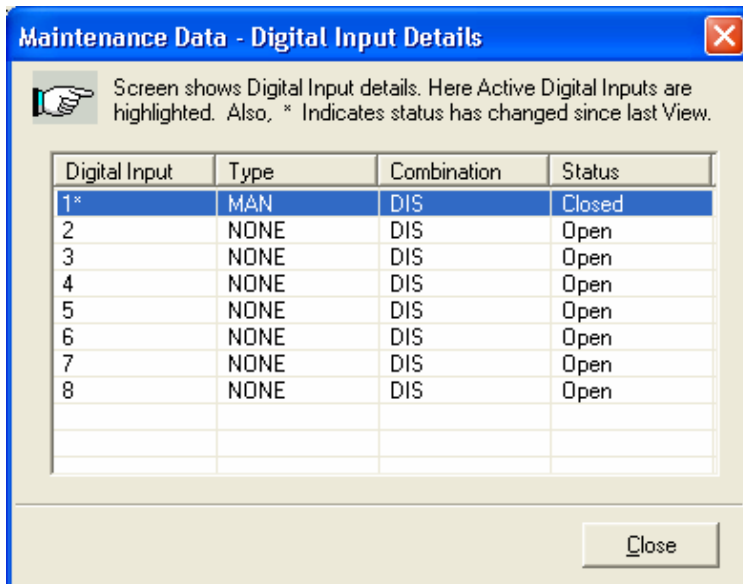
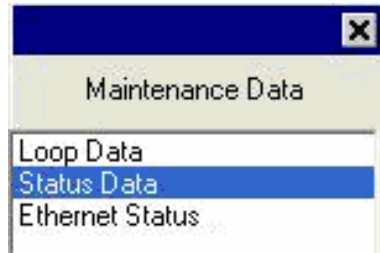


Figure 4-8 Digital Input Details Screen

## Status Data

Select **Status Data** from the **Maintenance Data** menu.



The Status Data screen lets you see the current status of the controller's diagnostics. If the controller has detected a problem, this screen will show the detected problem.

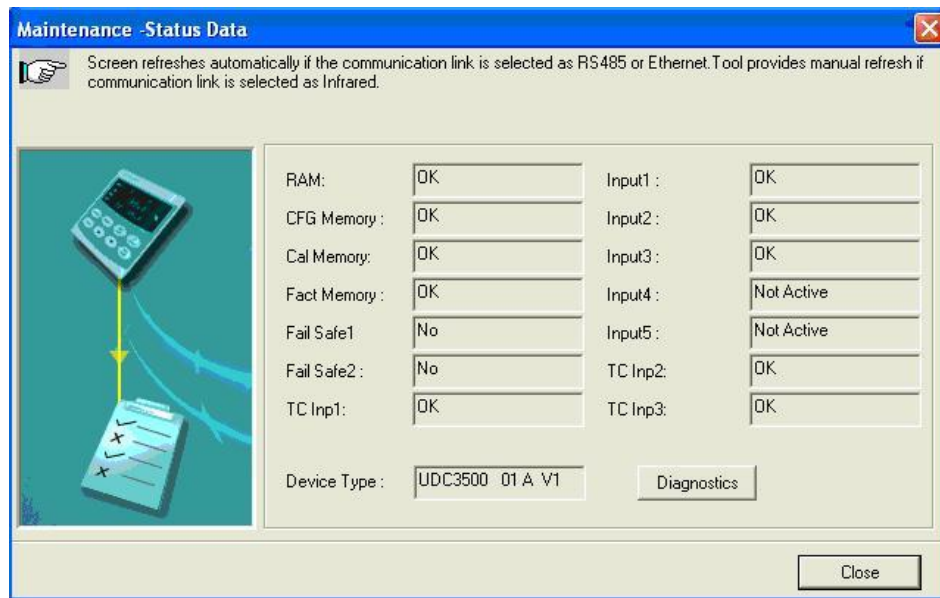
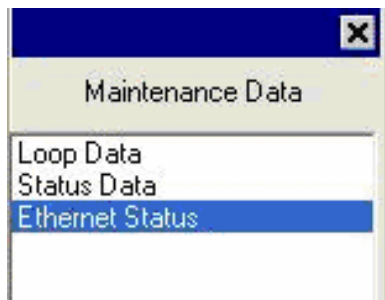


Figure 4-9 Status Data Maintenance Screen



## Ethernet Status

Select **Ethernet Status** from the **Maintenance Data** menu.



This screen only appears in instruments that have the Ethernet Communications option. Essentially, this screen shows the same Ethernet diagnostic messages as available on the controller via the lower display window. See Section 7.5 for details.

The Ethernet Status screen shows the network status of the Ethernet Link. This may be accessed either via Ethernet or via Infrared communications. Not all diagnostic messages are available via Ethernet Communications. For example, if the Ethernet cable is unplugged, then the instrument cannot send up the **EUNPLGED** diagnostic message via Ethernet.

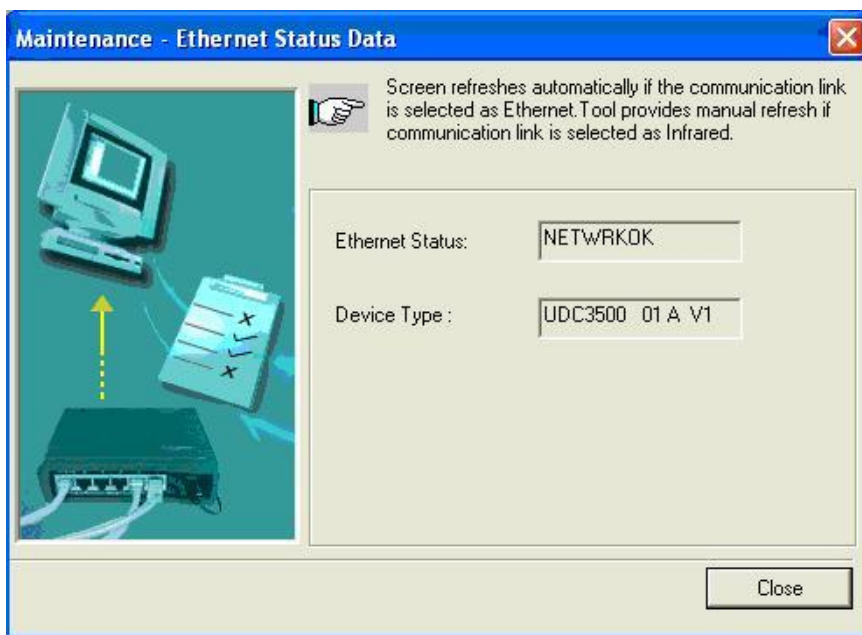


Figure 4-10 Ethernet Status Maintenance Screen

## 4.23 Configuring your Ethernet Connection

### Introduction

This controller is shipped from the factory with the address for Infrared (IR) communications set to 3, the Ethernet IP Address set to 10.0.0.2, the Ethernet Subnet Mask set to 255.255.255.0 and the Ethernet Default Gateway set to 0.0.0.0. Consult your Information Technologies (IT) representative as to how these should be configured for your installation. The MAC address is printed on the product label located on the instrument's case.

Only the P.I.E. Tool<sup>®</sup> can be used to configure Ethernet parameters. The figures in this section show screen-shots from the PC version of the P.I.E. Tool<sup>®</sup> Screens. Pocket PC Screens are generally similar in format but smaller. The P.I.E. Tool can connect to your controller via either Ethernet communications port or the Infrared (IR) communications port.

### Configuring the Controller via Infrared Communications

If connecting via IR and assuming that the instrument's IR address has not been changed from its factory setting of 3, then configure your Communications Type as **Infrared** and your IR address to **3** as shown below in Figure 4-11.

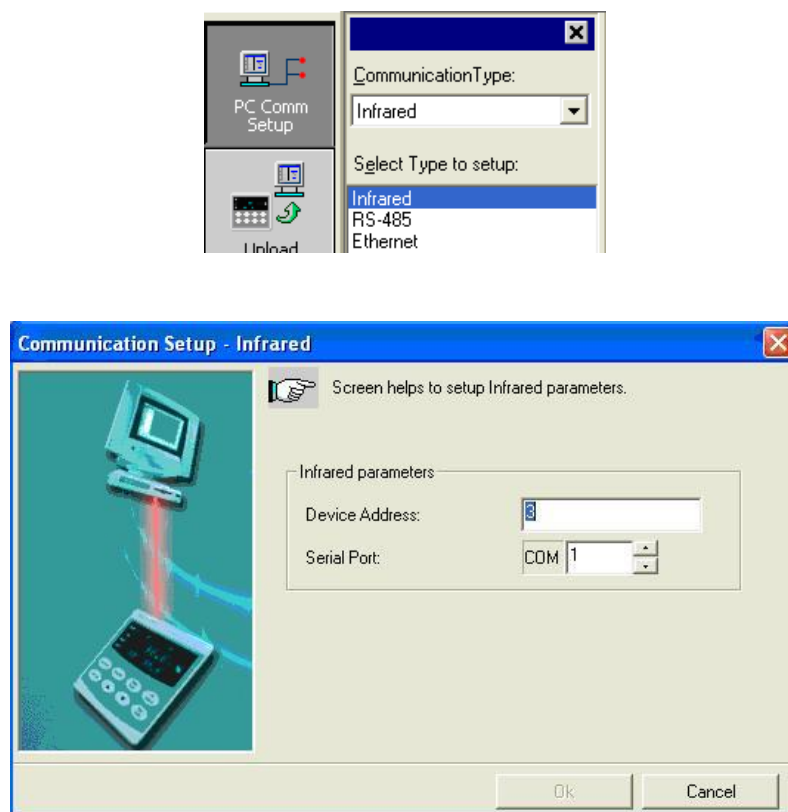


Figure 4-11 IR Communications Address

Close the IR configuration window and then single click on the **Online Configuration** button shown in Figure 4-12.

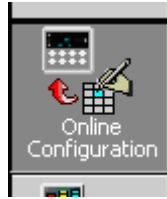


Figure 4-12 Online Configuration

Press any button on the controller's keyboard to activate the controller's IR port. Point your IR dongle (if using PC) or your Pocket PC's IR port (if using Pocket PC) at the IR window on the front of the controller and then click on the **Start** button. The P.I.E. Tool<sup>®</sup> should start uploading the configuration information from the controller as shown below:

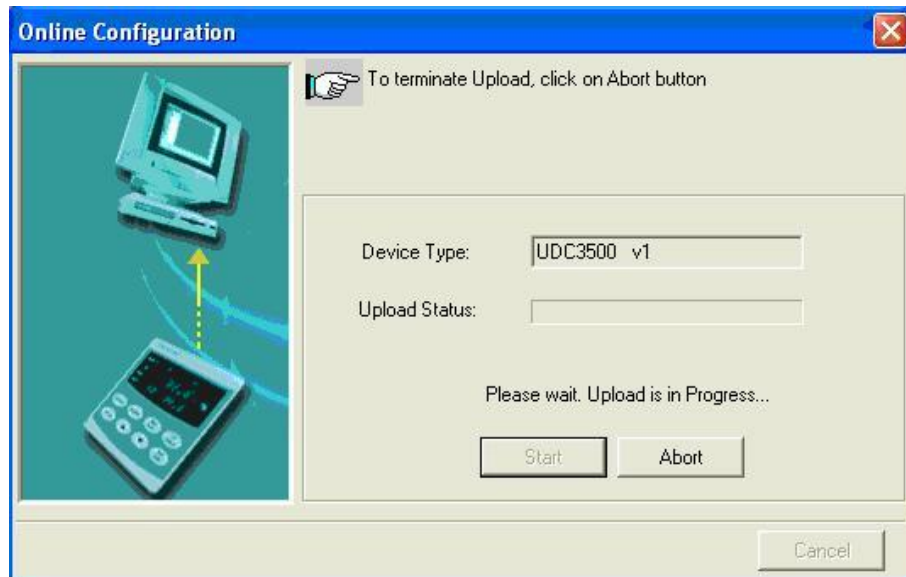


Figure 4-13 Configuration Upload in Progress

Once the upload is complete, click on the **Ethernet & Email Group**. Configure your Ethernet and Email parameters per Section 3.16.

Once you have changed the Ethernet settings and downloaded them to your controller, you will now be able to communicate with it via Ethernet.

## Configuring the Controller via Ethernet Communications

### WARNING

Configuring the Controller via Ethernet Communications requires that you change your PC's IP settings. If you have never done this before, then it is **strongly** recommended that you consult with your Information Technologies (IT) representative before proceeding.

First, write down the current Local Area Network (LAN) configuration values for your PC for its IP Address, Subnet Mask and Default Gateway settings. Put these someplace that you can find them later.

Connecting to the Ethernet Port in the Controller requires that you have either an Ethernet crossover cable or a MDI-compliant Switch or Hub available with a straight-through cable. The crossover cable can be used to directly connect your PC to the Controller while the Switch or Hub can be used to connect your PC and Controller to the Hub or Switch via straight-through cables.

Once you have made an Ethernet connection between your PC and the controller, then change the Local Area Network (LAN) settings on your PC to be as follows:

IP Address: 10.0.0.3  
Subnet Mask: 255.255.255.0  
Default Gateway: 10.0.0.1

Now open your P.I.E. Tool<sup>®</sup> program and select **PC Comm Setup** and select **Ethernet** as your **Communication Type** as shown in Figure 4-14.

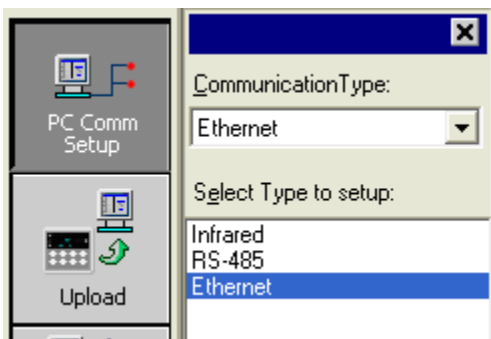
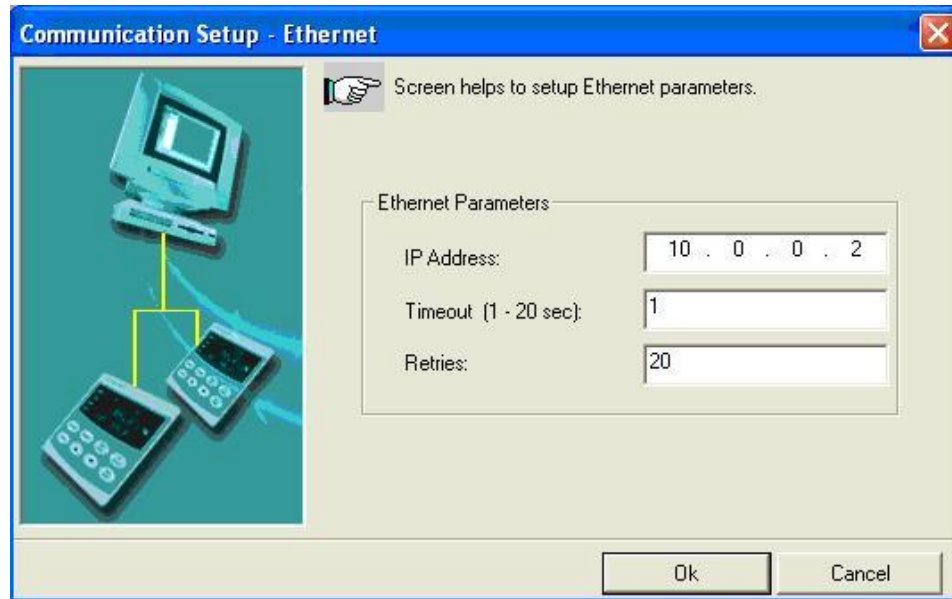


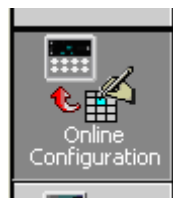
Figure 4-14 Ethernet Communications Type Selection

Now set your Ethernet address to **10.0.0.2** as shown in Figure 4-15.

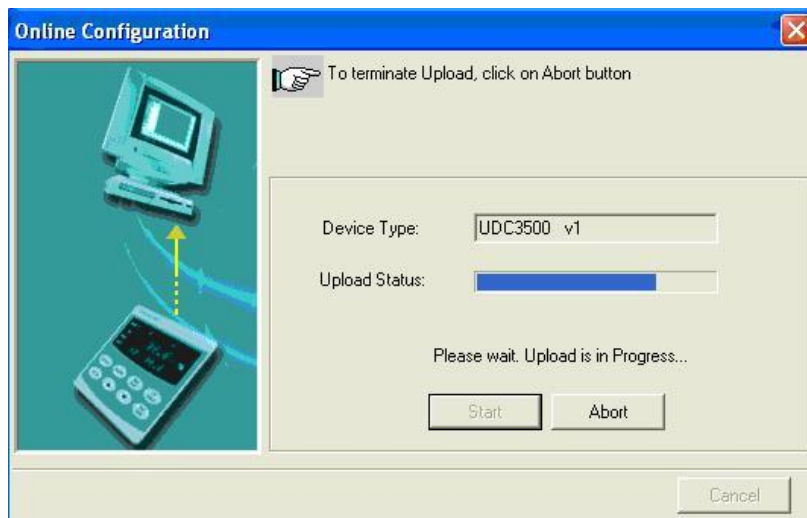


**Figure 4-15 Ethernet Communications Address**

Close the Ethernet configuration window and then single click on the **Online Configuration** button.



Then, click on the **Start** button. The P.I.E. Tool® should start uploading the configuration information from the controller as shown in Figure 4-16.



**Figure 4-16 Configuration Upload in Progress**

Once the upload is complete, click on the **Ethernet & Email** Group. Configure your Ethernet and Email parameters per Section 3.16.

Once you have changed the Ethernet settings and downloaded them to your controller, you will no longer be able to communicate with it until you change the IP address in the P.I.E. Tool® to be per the controller's new IP Address.

You will also need to re-configure the Local Area Network (LAN) settings on your PC back to their original settings. On some PCs and LANs, it is possible to simply allow the PC to get these settings automatically via the DHCP server. Contact your Information Technologies (IT) representative to see if this is available on your PC.

## 5 Input Calibration



### WARNING—SHOCK HAZARD

INPUT CALIBRATION MAY REQUIRE ACCESS TO HAZARDOUS LIVE CIRCUITS, AND SHOULD ONLY BE PERFORMED BY QUALIFIED SERVICE PERSONNEL. MORE THAN ONE SWITCH MAY BE REQUIRED TO DE-ENERGIZE UNIT BEFORE CALIBRATION.

### 5.1 Overview

#### Introduction

This section describes the field calibration procedures for Input 1 and Input 2.

- All input actuations in every UDC2500 controller are fully factory-calibrated and are ready for configuration by the user.
- Field Calibration can improve the accuracy of the Controller if necessary for a particular application.

#### CAUTION

The field calibration will be lost if a change in input type configuration is implemented at a later time. The original factory calibration data remains available for later use after a field calibration is done. See subsection 0 if you want to restore factory calibration values.

#### What's in this section?

The following topics are covered in this section.

TOPIC	See Page
5.1 Overview	137
5.2 Minimum and Maximum Range Values	138
5.3 Preliminary Information	140
5.4 Input #1 Set Up Wiring	141
5.5 Input #1 Calibration Procedure	145
5.6 Input #2 Set Up Wiring	147
5.7 Input #2 Calibration Procedure	148
5.8 Restore Factory Calibration	150

## Calibration Steps

Use the following steps when calibrating an input.

Step	Action
1	Find the minimum and maximum range values for your PV input range from Table 5-1.
2	Disconnect the field wiring and find out what equipment you will need to calibrate.
3	Wire the calibrating device to your controller according to the set up wiring instructions for your particular input (Subsection 5.4 or 5.6).
4	Follow the calibration procedure given for Input #1 or Input #2 (Subsection 5.5 or 5.7).

## 5.2 Minimum and Maximum Range Values

### Select the Range Values

Calibrate the controller for the minimum (0 %) and maximum (100 %) range values of your particular input type. Two input controllers will need to have each input calibrated separately.

Select the Voltage, Current or Resistance equivalents for 0 % and 100 % range values from Table 5-1 and Table 5-2. Use these values when calibrating your controller.

**Table 5-1 Voltage, Milliamp and Resistance Equivalents for Input 1 Range Values**

Sensor Type	PV Input Range		Range Values	
	°F	°C	0 %	100 %
<b>Thermocouples (per ITS-90)</b>				
<b>B</b>	0 to 3300	-18 to 1816	-0.100 mV	13.769 mV
<b>E</b>	-454 to 1832	-270 to 1000	-9.835 mV	76.373 mV
<b>E (low)</b>	-200 to 1100	-129 to 593	-6.472 mV	44.455 mV
<b>J</b>	0 to 1600	-18 to 871	-0.886 mV	50.060 mV
<b>J (med)</b>	20 to 900	-7 to 482	-0.334 mV	26.400 mV
<b>J (low)</b>	20 to 550	-7 to 288	-0.334 mV	15.650 mV
<b>K</b>	0 to 2400	-18 to 1816	-0.692 mV	52.952 mV
<b>K (med)</b>	-20 to 1200	-29 to 649	-1.114 mV	26.978 mV
<b>K (low)</b>	-20 to 750	-29 to 399	-1.114 mV	16.350 mV
<b>NiMo-NiCo (NM90)</b>	32 to 2500	0 to 1371	0.000 mV	71.773 mV
<b>NM90 (low)</b>	32 to 1260	0 to 682	0.000 mV	31.825 mV
<b>Nicrosil-Nisil (Nic)</b>	0 to 2372	-18 to 1300	-0.461 mV	47.513 mV
<b>Nic (low)</b>	0 to 1472	-18 to 800	-0.461 mV	28.455 mV
<b>R</b>	0 to 3100	-18 to 1704	-0.090 mV	20.281 mV



Sensor Type	PV Input Range		Range Values	
	°F	°C	0 %	100 %
<b>S</b>	0 to 3100	-18 to 1704	-0.092 mV	17.998 mV
<b>T</b>	-300 to 700	-184 to 371	-5.341 mV	19.097 mV
<b>T (low)</b>	-200 to 500	-129 to 260	-4.149 mV	12.574 mV
<b>W5W26</b>	0 to 4200	-18 to 2315	-0.234 mV	37.075 mV
<b>W5W26 (low)</b>	0 to 2240	-18 to 1227	-0.234 mV	22.283 mV
<b>RP20-RP40</b>	32 to 3216	0 to 1880	0.000 mV	4.933 mV
<b>Thermocouple Differential *</b>	-50 to 150	-46 to 66	-1.54 mV	4.62 mV
<b>Honeywell Radiamatic</b>				
<b>Type RH</b>	0 to 3400	-18 to 1871	0.00 mV	57.12 mV
<b>Type RI **</b>	0 to 3400	-18 to 1871	0.00 mV	60.08 mV
<b>RTD</b> <b>Alpha = 0.00385 per IEC-60751 (1995)</b>				
<b>100 ohms</b>	-300 to 1200	-184 to 649	25.202 ohms	329.289 ohms
<b>100 ohms (low)</b>	-300 to 300	-184 to 149	25.202 ohms	156.910 ohms
<b>200 ohms</b>	-300 to 1200	-184 to 649	50.404 ohms	658.578 ohms
<b>500 ohms</b>	-300 to 1200	-184 to 649	126.012 ohms	1646.445 ohms
<b>Linear</b>				
<b>Milliamps</b>	4 to 20 mA 0 to 20 mA		4.00 mA 0.00 mA	20.00 mA 20.00 mA
<b>Millivolts</b>	0 to 10 mV 0 to 50 mV 0 to 100 mV		0.00 mV 0.00 mV 0.00 mV	10.00 mV 50.00 mV 100.00 mV
<b>Volts</b>	1 to 5 Volts 0 to 5 Volts 0 to 10 Volts		1.00 Volts 0.00 Volts 0.00 Volts	5.00 Volts 5.00 Volts 10.00 Volts

\* The Factory Calibrated millivolt values for the Thermocouple Differential Input are for a pair of J thermocouples at an ambient temperature mean of 450°F / 232°C. Other thermocouple types and ambient temperature means may be accomplished via Field Calibration of the input, with the range value limits being -4 mV to +16 mV for the zero and span values.

\*\* The range values for Radiamatic Type RI are customer configurable within the limits shown.

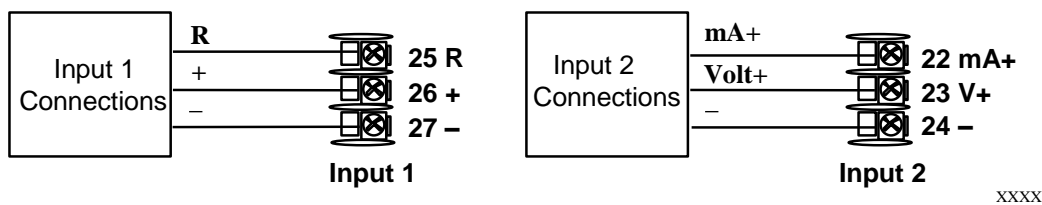
**Table 5-2 Voltage and Milliamp Equivalent for Input 2 Range Values**

Sensor Type	PV Input Range	Range Values	
		0 %	100 %
Linear  Milliamps	4 to 20 mA	4.00 mA	20.00 mA
	0 to 20 mA	0.00 mA	20.00 mA
Volts	1 to 5 Volts	1.00 Volts	5.00 Volts
	0 to 5 Volts	0.00 Volts	5.00 Volts
	0 to 2 Volts	0.00 Volts	2.00 Volts

### 5.3 Preliminary Information

#### Disconnect the Field Wiring

Tag and disconnect any field wiring connected to the input (#1 or #2) terminals on the rear of the controller.



**Figure 5-1 Input 1 and Input 2 Wiring Terminals**

#### Equipment Needed

Table 5-3 lists the equipment you will need to calibrate the specific types of inputs that are listed in the table. You will need a screwdriver to connect these devices to your controller.

**Table 5-3 Equipment Needed**

Type of Input	Equipment Needed
Thermocouple Inputs (Ice Bath)	<ul style="list-style-type: none"> <li>• A calibrating device with at least <math>\pm 0.02</math> % accuracy for use as a signal source such as a millivolt source.</li> <li>• Thermocouple extension wire that corresponds with the type of thermocouple that will be used with the controller input.</li> <li>• Two insulated copper leads for connecting the thermocouple extension wire from the ice baths to the mV source.</li> <li>• Two containers of crushed ice.</li> </ul>
Thermocouple Inputs (T/C Source)	<ul style="list-style-type: none"> <li>• A calibrating device with at least <math>\pm 0.02</math> % accuracy for use as a signal source such as a millivolt source.</li> <li>• Thermocouple extension wire that corresponds with the type of thermocouple that will be used with controller input.</li> </ul>

Type of Input	Equipment Needed
RTD (Resistance Thermometer Device)	<ul style="list-style-type: none"> <li>A decade box, with at least <math>\pm 0.02\%</math> accuracy, capable of providing stepped resistance values over a minimum range of 0 to 1650 ohms with a resolution of 0.001 ohm.</li> <li>Three insulated copper leads of equal length for connecting the decade box to the controller.</li> </ul>
Milliamper, Millivolt, Volts, and Radiamatic	<ul style="list-style-type: none"> <li>A calibrating device with at least <math>\pm 0.02\%</math> accuracy for use as a signal source.</li> <li>Two insulated copper leads for connecting the calibrator to the controller.</li> <li>Place current source at zero before switching ON.</li> <li>Do not switch current sources OFF/ON while connected to the UDC2500 input.</li> </ul>

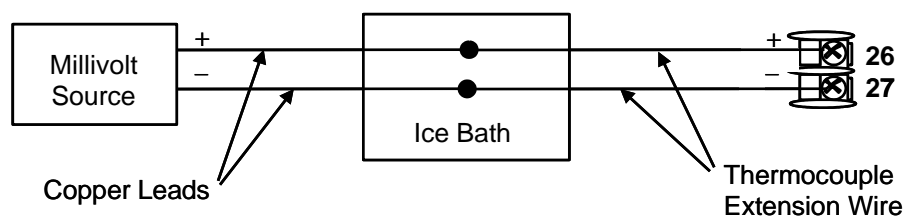
## 5.4 Input 1 Set Up Wiring

### Thermocouple Inputs Using an Ice Bath

Refer to Figure 5-2 and wire the controller according to the procedure given in Table 5-4..

**Table 5-4 Set Up Wiring Procedure for Thermocouple Inputs Using an Ice Bath**

Step	Action
1	Connect the copper leads to the calibrator.
2	Connect a length of thermocouple extension wire to the end of each copper lead and insert the junction points into the ice bath.
3	Connect the thermocouple extension wires to the terminals for Input #1. See Figure 5-2.



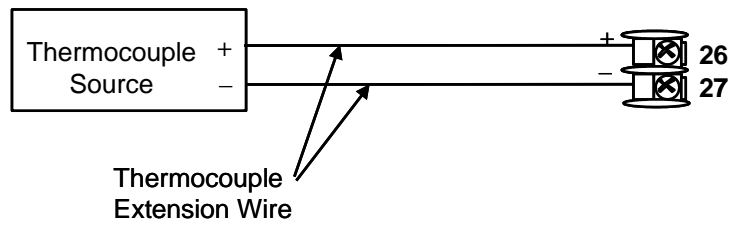
**Figure 5-2 Wiring Connections for Thermocouple Inputs Using an Ice Bath**

### Thermocouple Inputs Using a Thermocouple Source

Refer to Figure 5-3 and wire the controller according to the procedure given in Table 5-5..

**Table 5-5 Set Up Wiring Procedure for Thermocouple Inputs using Thermocouple Source**

Step	Action
1	Connect the thermocouple extension wires to the terminals for Input #1 as shown in Figure 5-3.



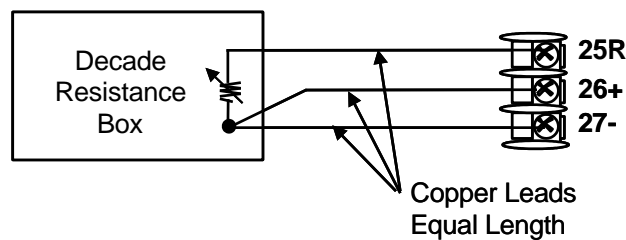
**Figure 5-3 Wiring Connections for Thermocouple Inputs Using Thermocouple Source**

### RTD Inputs

Refer to Figure 5-4 and wire the controller according to the procedure given in Table 5-6.

**Table 5-6 Set Up Wiring Procedure for RTD Inputs**

Step	Action
1	Connect the copper leads from the calibrator to the Input #1 terminals as shown in Figure 5-4.



**Figure 5-4 Wiring Connections for RTD (Resistance Thermometer Device)**

## Radiamatic, Millivolts, Volts or Thermocouple Differential Inputs

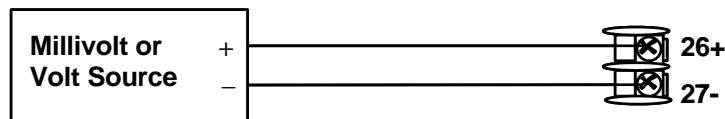
Refer to Figure 5-5 and wire the controller according to the procedure given in Table 5-7.

**Table 5-7 Set Up Wiring Procedure for Radiamatic, Millivolts, Volts or T/C Differential Inputs  
(Except 0-10 Volts)**

Step	Action
1	Connect the copper leads from the calibrator to the Input #1 terminals as shown in Figure 5-5.
2	Place current/voltage source at zero before switching on.
3	Do not switch current/voltage source ON/OFF while connected to the instrument.

### ATTENTION

For Radiamatic inputs only, set Emissivity value to 1.0. See *Subsection 3.9 – Configuration Set Up* prompt INPUT1, function prompt EMISS.



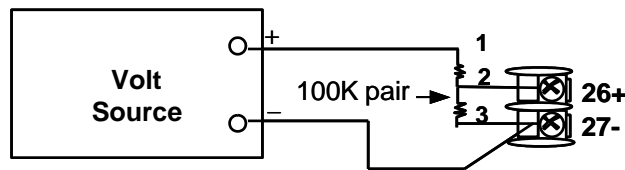
**Figure 5-5 Wiring Connections for Radiamatic, T/C Differential, Millivolts or Volts  
(Except 0 to 10 Volts)**

## 0 to 10 Volts

Refer to Figure 5-6 and wire the controller according to the procedure given in Table 5-8.

**Table 5-8 Set Up Wiring Procedure for 0 to 10 Volts**

Step	Action
1	Connect the copper leads from the calibrator to the Input #1 terminals as shown in Figure 5-6.
2	Place voltage source at zero before switching on.
3	Do not switch voltage source ON/OFF while connected to the instrument.



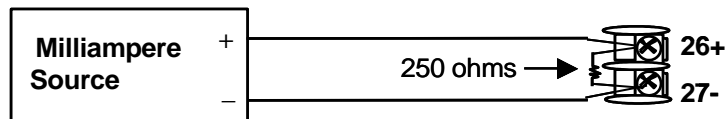
**Figure 5-6 Wiring Connections for 0 to 10 Volts**

## Milliamperes

Refer to Figure 5-5 and wire the controller according to the procedure given in Table 5-7.

**Table 5-9 Set Up Wiring Procedure for Milliampere Inputs**

Step	Action
1	Connect the copper leads from the calibrator to the Input #1 terminals as shown in Figure 5-7.
2	Place current source at zero before switching on.
3	Do not switch current source ON/OFF while connected to the instrument.



**Figure 5-7 Wiring Connections for 0 to 20 mA or 4 to 20 mA Inputs**

## 5.5 Input 1 Calibration Procedure

### Preliminary Steps

- Apply power and allow the controller to warm up for 30 minutes before you calibrate.
- Please read *Subsection 5.4 – Input 1 Set Up Wiring* before beginning the procedure.
- **Make sure you have LOCK set to NONE.** See *Subsection 3.4 - Tuning Set Up Group*.
- See Table 5-1 for Voltage vs. Resistance equivalents or 0 % and 100 % range values.





### CAUTION





For linear inputs, avoid step changes in inputs. Vary smoothly from initial value to final 100 % value.

### Procedure

The calibration procedure for Input #1 is listed in Table 5-10. The numeric codes are also listed.

**Table 5-10 Input 1 Calibration Procedure (Numeric Code 10000)**

Step	Operation	Press	Result
1	Enter Calibration Mode		<i>Upper Display = CAL ( - - - - )</i> <i>Lower Display = INPUT1 (10000)</i>
		until you see	
			You will see: <i>Upper Display = DIS ( 0 )</i> <i>Lower Display = CALIN1 (10001)</i>
2	Calibrate 0 %		The calibration sequence is enabled and you will see: <i>Upper Display = BEGN ( 1 )</i> <i>Lower Display = CALIN1 (10001)</i>
			At the completion of the sequence, the selection automatically reverts to disable.
			You will see: <i>Upper Display = APLY ( 2 )</i> <i>Lower Display = IN1ZRO (10002)</i>
		<ul style="list-style-type: none"> <li>• Adjust your calibration device to an output signal equal to the 0 % range value for your particular input sensor. See Table 5-1 for Voltage, Degrees, or Resistance equivalents for 0 % range values.</li> <li>• Wait 15 seconds, then go to the next step.</li> </ul>	

Step	Operation	Press	Result						
3	Calibrate 100 %		<p>You will see:</p> <p><i>Upper Display = APLY ( 2 )</i>  <i>Lower Display = IN1SPN (10003)</i></p> <ul style="list-style-type: none"> <li>Adjust your calibration device to an output signal equal to the 100 % range value for your particular input sensor. See Table 5-1 for Voltage, Degrees, or Resistance equivalents for 100 % range values.</li> <li>Wait 15 seconds, and</li> </ul> <table border="1"> <thead> <tr> <th>If ...</th> <th>Then ...</th> </tr> </thead> <tbody> <tr> <td>you are calibrating a Thermocouple input</td> <td>go to step 4</td> </tr> <tr> <td>you are calibrating other than a Thermocouple input</td> <td>go to step 5</td> </tr> </tbody> </table>	If ...	Then ...	you are calibrating a Thermocouple input	go to step 4	you are calibrating other than a Thermocouple input	go to step 5
If ...	Then ...								
you are calibrating a Thermocouple input	go to step 4								
you are calibrating other than a Thermocouple input	go to step 5								
4	Check the Cold Junction Temperature		<p>The calculations for zero and span are now stored and you will see:</p> <p><i>Upper Display = The cold junction temperature at the rear terminals</i>  <i>Lower Display = CJTEMP (10004)</i></p> <p>The value in the upper display is in tenths of a degree. It is the current reading of the temperature as measured at the thermocouple terminals and recognized by the controller. You can change this value, if it is in error, using the ▲ or ▼ keys.</p> <p><b>WARNING:</b> The accuracy of the controller is directly affected by the accuracy of this value. It is recommended that this value not be changed under normal circumstances.</p>						
5	Exit the Calibration Mode	 then 	<p>The controller stores the calibration constants and exits the calibration mode.</p>						



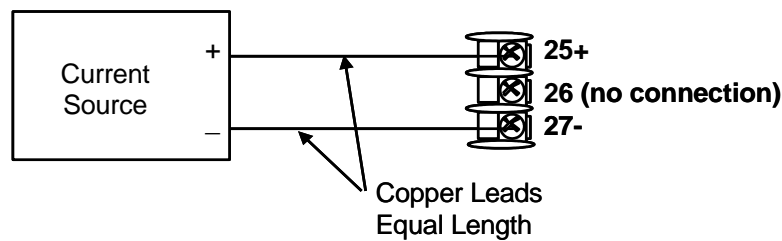
## 5.6 Input 2 Set Up Wiring

### 0 to 20 mA or 4 to 20 mA Inputs – Input 2

Refer to Figure 5-8 and wire the controller according to the procedure given in Table 5-13.

**Table 5-11 Set Up Wiring Procedure for 0 to 20 mA or 4 to 20 mA Inputs – Input 2**

Step	Action
1	Connect the copper leads from the calibrator to the Input #2 terminals as shown in Figure 5-8.
2	Place current source at zero before switching on.
3	Do not switch current source ON/OFF while connected to the instrument.



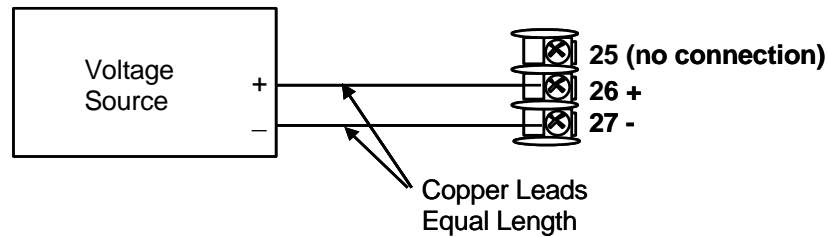
**Figure 5-8 Wiring Connections for 0 to 20 mA or 4 to 20 mA Input – Input 2**

## 0 to 2 Volts, 0 to 5 Volts, or 1 to 5 Volt Inputs – Input 2

Refer to Figure 5-9 and wire the controller according to the procedure given in Table 5-12.

**Table 5-12 Set Up Wiring Procedure for 0 to 2 Volts, 0 to 5 Volts, or 1 to 5 Volts – Input 2**

Step	Action
1	Connect the copper leads from the calibrator to the Input #2 terminals as shown in Figure 5-8.
2	Place voltage source at zero before switching on.
3	Do not switch voltage source ON/OFF while connected to the instrument.



**Figure 5-9 Wiring Connections for 0 to 2 Volts, 0 to 5 Volts or 1 to 5 Volts Input – Input 2**

## 5.7 Input 2 Calibration Procedure

### Preliminary Steps



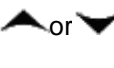




- Apply power and allow the controller to warm up for 30 minutes before you calibrate.
- Please read *Subsection 5.6* – before beginning the procedure.
- **Make sure you have LOCK set to NONE.** See *Subsection 3.4 - Tuning Set Up Group*.

*Continued next page*

## Procedure

The calibration procedure for Input #2 is listed in Table 5-13. The numeric codes are also listed.

**Table 5-13 Input 2 Calibration Procedure (Numeric Code 20000)**

Step	Operation	Press	Result
1	Enter Calibration Mode		<i>Upper Display = CAL ( - - - - )</i> <i>Lower Display = INPUT2 (20000)</i>
			until you see
			You will see: <i>Upper Display = DIS ( 0 )</i> <i>Lower Display = CALIN2 (20001)</i>
			You will see: <i>Upper Display = BEGN ( 1 )</i> <i>Lower Display = CALIN2 (20001)</i>
2	Calibrate 0 %		You will see: <i>Upper Display = APLY ( 2 )</i> <i>Lower Display = INZZRO (20002)</i>
			<ul style="list-style-type: none"> <li>Adjust your calibration device to an output signal equal to the 0 % range value for your particular input sensor.</li> <li>Wait 15 seconds, then go to the next step.</li> </ul>
3	Calibrate 100 %		You will see: <i>Upper Display = APLY ( 2 )</i> <i>Lower Display = IN2SPN (20003)</i>
			<ul style="list-style-type: none"> <li>Adjust your calibration device to an output signal equal to the 100 % range value for your particular input sensor.</li> <li>Wait 15 seconds, then go to the next step.</li> </ul>
4	Exit the Calibration Mode		The controller stores the calibration constants.
			To store the calibration constants and exit the calibration mode.

## 5.8 Restore Input Factory Calibration

### Introduction

The factory calibration constants for all the input actuation types that can be used with the controller are stored in its non-volatile memory. Thus, you can quickly restore the “Factory Calibration” for a given input actuation type by simply changing the actuation type to another type and then changing it back to the original type.

*Refer to Table 5-14 Restore Factory Calibration for procedure*



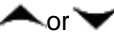
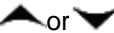


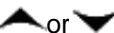
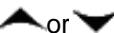



#### ATTENTION


A restored factory calibration overwrites any previous field calibration done for the input and may change the High and Low Range Limits.

Protect your field calibration from accidental overwrites by configuring the appropriate LOCKOUT selection after calibration.

See *Section 3 - Configuration* for specific instructions to set the lockout.

**Table 5-14 Restore Factory Calibration**

Step	Operation	Press	Result
1	Set LOCKOUT to NONE		until you see: <i>Upper Display = SET UP</i> <i>Lower Display = TUNING</i>
			Until you see: <i>Upper Display = one of the following:</i> <b>NONE</b> – all parameters are read/write <b>CAL</b> – all parameters are read/write except Calibration <b>CONF</b> – configuration parameters are Read Only; no writes permitted <b>VIEW</b> – Tuning and Setpoint Ramp parameters are read/write. No other parameters can be viewed. <b>ALL</b> – Tuning and Setpoint Ramp parameters are available for read only. No other parameters can be viewed. <i>Lower Display = LOCK</i>
2	Enter INPUT 1 Setup Group	 or 	Until <b>NONE</b> is in the upper display
			until you see: <i>Upper Display = SET UP</i> <i>Lower Display = INPUT 1 or 2</i>
3	Scroll through Functions		until you see: <i>Upper Display = the current selection</i> <i>Lower Display = INxTYP</i>
		 or 	to change the current selection to another selection
			until the lower display rolls through the rest of the functions and returns to: <i>Upper Display = the new selection</i> <i>Lower Display = INxTYP</i>
		 or 	until you change the input selection in the upper display back to

Step	Operation	Press	Result
			<p>the proper selection. You will see:</p> <p><i>Upper Display</i> = Original Input Selection that matches your type of sensor.</p> <p><i>Lower Display</i> = <b>INxTYP</b></p>
4	Return to Normal Operation		<p>to return to Normal operating mode.</p> <p>The factory calibration will be restored. If the problem is not corrected, contact the Honeywell Technical Assistance Center at 1-800-423-9883 USA and Canada</p>



## 6 Output Calibration

### 6.1 Overview

#### Introduction

This section describes the field calibration procedures for the following types of outputs:

- Current Output
- Auxiliary Output

#### What's in this section?

The following topics are covered in this section.

TOPIC	See Page
6.1 Overview	153
6.2 Current Output Calibration	154
6.3 Auxiliary Output Calibration	156
6.4 Restore Output Factory Calibration	158



#### **WARNING—SHOCK HAZARD**

**OUTPUT CALIBRATION MAY REQUIRE ACCESS TO HAZARDOUS LIVE CIRCUITS, AND SHOULD ONLY BE PERFORMED BY QUALIFIED SERVICE PERSONNEL. MORE THAN ONE SWITCH MAY BE REQUIRED TO DE-ENERGIZE UNIT BEFORE CALIBRATION.**

## 6.2 Current Output Calibration

### Introduction

Calibrate the controller so that the output provides the proper amount of current over the desired range. The controller can provide an output current range of from 0 to 21 milliamperes and is usually calibrated at 4 mA for 0 % of output and 20 mA for 100 % of output, or any other values between 0 mA and 21 mA. It is not necessary to re-calibrate the controller in order to change from 4 to 20 mA operation over to 0 to 20 mA operation, a simple configuration change is all that is required. See the CO RANGE configuration in *Sub-section 3.8* for details.

### Equipment Needed

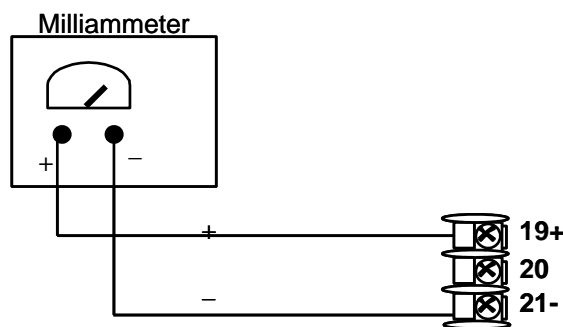
You will need a standard shop type milliammeter, with whatever accuracy is required, capable of measuring 0 to 20 milliamps.

### Calibrator Connections

Refer to Figure 6-1 and wire the controller according to the procedure given in Table 6-1.

**Table 6-1 Set Up Wiring Procedure for Current Output**

Step	Action
1	Apply power and allow the controller to warm up 30 minutes before you calibrate.
2	Set LOCK in the Tuning Set Up group to NONE.
3	Tag and disconnect the field wiring, at the rear of the controller, from terminals 21 (-) and 19 (+). See Figure 6-1.
4	Connect a milliammeter across these terminals.












**Figure 6-1 Wiring Connections for Calibrating Current Output**



**Procedure**

The procedure for calibrating the Current Output is listed in Table 6-2. The numeric codes are also listed. Make sure LOCK in the Tuning Set Up group is set to **NONE**. (See Subsection 3.4 – Tuning Set Up Group.)

**Table 6-2 Current Output Calibration Procedure  
(Numeric Code 30000)**

Step	Operation	Press	Result
1	Enter Calibration Mode		Upper Display = <b>CAL ( - - - - )</b> Lower Display = <b>CURRENT (30000)</b>
		until you see	
2	Calibrate 0 %		You will see: Upper Display = A Value Lower Display = <b>ZROVAL (30001)</b>
		 or 	Until the desired 0 % output is read on the milliammeter, use the values shown below depending on the action of your controller. Normally, this will be the setting that produces 4 mA.
3	Calibrate 100 %		This stores the 0 % value and you will see: Upper Display = A Value Lower Display = <b>SPNVAL (30002)</b>
		 or 	Until the desired 100 % output is read on the milliammeter, use the values shown below depending on the action of your controller. Normally, this will be the setting that produces 20 mA.
4	Exit the Calibration Mode		The controller stores the span value.
			To exit the calibration mode.

## 6.3 Auxiliary Output Calibration

### Introduction

Calibrate the controller so that the auxiliary output provides the proper amount of current over the desired range. The controller can provide an auxiliary current output range of from 0 mA to 21 mA and is usually calibrated at 4 mA for 0 % of output and 20 mA for 100 % of output or any other values between 0 mA and 21 mA. It is not necessary to re-calibrate the controller in order to change from 4 to 20 mA operation over to 0 to 20 mA operation, a simple configuration change is all that is required. See the AO RANGE configuration in *Sub-section 3.12* for details.

### Equipment Needed

You will need a calibrating device with whatever accuracy is required, capable of measuring 0 to 20 mA.

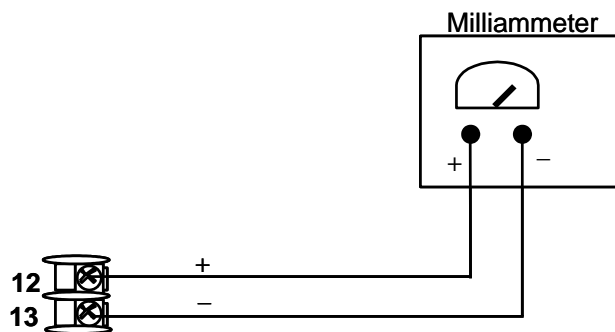
### Calibrator Connections

Refer to

Figure 6-2 and wire the controller according to the procedure given in Table 6-3.

**Table 6-3 Set Up Wiring Procedure for Auxiliary Output**

Step	Action
1	Apply power and allow the controller to warm up 30 minutes before you calibrate.
2	<b>Set LOCK in the Tuning Set Up group to NONE.</b>
3	Tag and disconnect the field wiring, at the rear of the controller, from terminals 12 (+) and 13 (-). See Figure 6-2.
4	Connect a milliammeter across these terminals.












**Figure 6-2 Wiring Connections for Calibrating Auxiliary Output**

**Procedure**

The procedure for calibrating the auxiliary output is listed in Table 6-4. The numeric codes are also listed.

Make sure “LOCK” in the Tuning Set Up group is set to “NONE” (see *Subsection 3.4*).

**Table 6-4 Auxiliary Output Calibration Procedure  
(Numeric Code 50000)**

Step	Operation	Press	Result
1	Enter Calibration Mode		<i>Upper Display = CAL ( - - - - )</i> <i>Lower Display = AUXOUT (50000)</i>
		until you see	
2	Calibrate 0 %		You will see: <i>Upper Display = A Value</i> <i>Lower Display = ZROVAL (50001)</i>
		 or 	until the desired 0 % output is read on the milliammeter, use the values shown below depending on the action of your controller. Normally, this will be the setting that produces 4 mA.
3	Calibrate 100 %		To store the 0 % value you will see: <i>Upper Display = A Value</i> <i>Lower Display = SPNVAL (50002)</i>
		 or 	until the desired 100 % output is read on the milliammeter. . Normally, this will be the setting that produces 20 mA.
4	Exit the Calibration Mode		The controller stores the span value.
			To exit the calibration mode.

## 6.4 Restore Output Factory Calibration Procedure

### Introduction

The factory calibration constants for the Current and Auxiliary Outputs are stored in its non-volatile memory. Thus, you can quickly restore the “Factory Calibration” for those outputs by simply changing the CO RANGE or AO RANGE to the other setting and then changing it back to the original type.



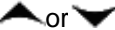
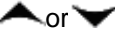


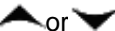

*Refer to Table 6-5 Restore Factory Calibration for procedure*




#### ATTENTION

A restored factory calibration overwrites any previous field calibration done for the output. Protect your field calibration from accidental overwrites by configuring the appropriate LOCKOUT selection after calibration.

See *Section 3 - Configuration* for specific instructions to set the lockout.

**Table 6-5 Restore Factory Calibration Procedure**

Step	Operation	Press	Result
1	Set LOCKOUT to NONE		until you see: <i>Upper Display = SET</i> <i>Lower Display = TUNING</i>
			Until you see: <i>Upper Display = one of the following:</i> <b>NONE</b> – all parameters are read/write <b>CAL</b> – all parameters are read/write except Calibration <b>CONF</b> – configuration parameters are Read Only; no writes permitted <b>VIEW</b> – Tuning and Setpoint Ramp parameters are read/write. No other parameters can be viewed. <b>ALL</b> – Tuning and Setpoint Ramp parameters are available for read only. No other parameters can be viewed. <i>Lower Display = LOCK</i>
2	Enter OUTPUT or OPTIONS Setup Group	 or 	Until <b>NONE</b> is in the upper display
			until you see: <i>Upper Display = SET</i> <i>Lower Display = OUTALG</i> (for the Current Output) - or - <i>Lower Display = OPTION</i> (for the Auxiliary Output)
3	Scroll through Functions		until you see: <i>Upper Display = the current selection</i> <i>Lower Display = CRANGE</i> (for the Current Output) - or - <i>Lower Display = ARANGE</i> (for the Auxiliary Output)
			to change the range configuration to the other selection
			until the lower display rolls through the rest of the functions and returns to: <i>Upper Display = the new selection</i>

Step	Operation	Press	Result
			<p><i>Lower Display = <b>CRANGE</b> (for the Current Output)</i>                      - or -  <i>Lower Display = <b>ARANGE</b> (for the Auxiliary Output)</i></p> <p> or  to change the range selection in the upper display back to the proper selection. You will see:</p> <p><i>Upper Display = Original range selection</i>  <i>Lower Display = <b>CRANGE</b> (for the Current Output)</i>                      - or -  <i>Lower Display = <b>ARANGE</b> (for the Auxiliary Output)</i></p>
4	Return to Normal Operation		<p>to return to Normal operating mode.</p> <p>The factory calibration will be restored. If the problem is not corrected, contact the Honeywell Technical Assistance Center at 1-800-423-9883 USA and Canada</p>

## 7 Troubleshooting/Service

### 7.1 Overview

#### Introduction

Instrument performance can be adversely affected by installation and application problems as well as by hardware problems. We recommend that you investigate the problems in the following order:

- installation related problems
- application related problems
- hardware and software related problems

and use the information presented in this section to solve them.

#### What's in this section?

The following topics are covered in this section.

TOPIC		See Page
7.1	Overview	160
7.2	Troubleshooting Aids <ul style="list-style-type: none"> <li>• Overall Error Messages</li> <li>• Controller Failure Symptoms</li> <li>• Customer Support</li> <li>• Determining the Software Version Number</li> </ul>	161
7.3	Power-up Tests	163
7.4	Status Tests	163
7.5	Background Tests	164
7.6	Controller Failure Symptoms	166
7.7	Troubleshooting Procedures <ul style="list-style-type: none"> <li>• Power Failure</li> <li>• Current Proportional Output Failure</li> <li>• Time Proportional Output Failure</li> <li>• Time/Current - Current/Time Proportional Output Failure</li> <li>• Alarm Relay Output Failure</li> <li>• Keyboard Failure</li> </ul>	167
7.8	Restore Factory Configuration	176
7.9	Software Upgrades	177

## Installation related problems

Read the Installation section in this manual to make sure the UDC2500 has been properly installed. The installation section provides information on protection against electrical noise, connecting external equipment to the controller, and shielding and routing external wiring.

**ATTENTION** System noise induced into the controller will result in diagnostic error messages recurring. If the diagnostic error messages can be cleared, it indicates a “soft” failure and is probably noise related.

If system noise is suspected, completely isolate the controller from all field wiring. Use calibration sources to simulate PV and check all controller functions; i.e. Gain, Rate, Reset, Output, Alarms, etc.

## Application related problems

Review the application of the controller; then, if necessary, direct your questions to the local sales office.

## Hardware and software related problems

Use the troubleshooting error message prompts and controller failure symptoms to identify typical failures which may occur in the controller. Follow the troubleshooting procedures to correct them.

## 7.2 Troubleshooting Aids

### Overall error messages

An error message can occur:

- At power-up. See Subsection 7.3.
- When the Status Tests are requested. See Subsection 7.4.
- During continuous background tests while in normal operation. See Subsection 7.5.

### Controller failure symptoms

Other failures may occur that deal with the Power, Output, or Alarms. Refer to the controller failure symptom in Table 7-4 to determine what is wrong and the troubleshooting procedures to use to correct the problem.

### Check installation

If a set of symptoms still persists, refer to *Section 2 - Installation* and ensure proper installation and proper use of the controller in the system.

## Customer support

If you cannot solve the problem using the troubleshooting procedures listed in this section, you can get **technical assistance** by dialing 1-800-423-9883 USA and Canada.

An engineer will discuss your problem with you. **Please have your complete model number, serial number, and Software version available.** The model and serial numbers can be found on the chassis nameplate. The software version can be viewed under Setup Group “Status.” See Table 7-1.

If it is determined that a hardware problem exists, a replacement controller or part will be shipped with instructions for returning the defective unit.



Do not return your controller without authorization from Honeywell’s Technical Assistance Center or until the replacement has been received.

Check out Honeywell’s **web site** at <http://www.honeywell.com/ps>.

## Determining the software version

Table 7-1 lists the procedure for identifying the software version number.

**Table 7-1 Procedure for Identifying the Software Version**

Step	Operation	Press	Result
1	Select STATUS Set Up Group		<i>Upper Display = READ</i> <i>Lower Display = STATUS</i>
2	Read the software version		You will see: <i>Upper Display = Software version number</i> <b>32xx</b>  <i>Lower Display = VERSION</i>  Please give this number to the Customer Support person. It will indicate which version of UDC2500 you have and help them determine a solution to your problem.



## 7.3 Power-up Tests

### What happens at power-up

When power is applied, the controller will run three diagnostic tests. After these tests are completed, "TEST DONE" is displayed.

### Test Failures

If one or more of these tests fail, the controller will go to the Failsafe Manual Mode, and FAILSF will flash in the lower display and a message indicating which test failed will appear in the lower display. Then, "DONE" will appear in the lower display.

### Three Position Step test failures

For controller configured for Three Position Step Control with motor position indication and Auto-cal has never been done, the prompt CAL MTR will appear to suggest that the controller be calibrated.

## 7.4 Status Tests




### Introduction

When required, the results of these tests can be checked to determine the reason the controller has gone to Failsafe.

### How to check the status tests

The procedure in Table 7-2 tells you how to display the results of the status tests.

**Table 7-2 Procedure for Displaying the Status Test (Numeric Code 1200) Results**

Step	Operation	Press	Result
1	Select STATUS Set Up Group		Upper Display = READ Lower Display = STATUS
2	Read the test results		You will see: Upper Display = NO or YES YES indicates a failure Lower Display = FAILSAFE
			Upper Display = PASS or FAIL Lower Display = TEST

## 7.5 Background Tests

### Introduction

The UDC2500 performs ongoing background tests to verify data and memory integrity. If there is a malfunction, a diagnostic message will be displayed (blinking) in the lower display.

In the case of simultaneous malfunctions, the messages will appear in sequence in the lower display. Table 7-3 lists these background tests, the reason for their failure, and how to correct the problem.

Diagnostic messages may be suppressed (stop the blinking) by pressing the **RUN/HOLD** key. The messages will still be available for viewing by pressing the **LOWER DISPLAY** key.

**Table 7-3 Background Tests**

Lower Display	Reason for Failure	How to Correct the Problem
<b>E FAIL</b>	Unable to write to non-volatile memory. Anytime you change a parameter and it is not accepted, you will see E FAIL.	<ol style="list-style-type: none"> <li>1. Check the accuracy of the parameter and re-enter.</li> <li>2. Try to change something in configuration.</li> <li>3. Run through Read STATUS tests to re-write to EEPROM.</li> </ol>
<b>FAILSF</b>	This error message shows whenever the controller goes into a failsafe mode of operation. This will happen if: <ul style="list-style-type: none"> <li>• RAM test failed</li> <li>• Configuration test failed</li> <li>• Calibration test failed</li> <li>• Burnout configured for none and the input failed.</li> </ul>	<ol style="list-style-type: none"> <li>1. Run through STATUS check to determine the reason for the failure.</li> <li>2. Press the <b>SET UP</b> key until STATUS appears in the lower display.</li> <li>3. Press the <b>FUNCTION</b> key to see whether the tests pass or fail, then run through the STATUS codes a second time to see if the error cleared.</li> </ol>
<b>IN1RNG</b>	Input 1 out of range. The process input is outside the range limits.	<ol style="list-style-type: none"> <li>1. Make sure the range and actuation are configured properly.</li> <li>2. Check the input source.</li> <li>3. Restore the factory calibration. (See <i>Subsection 0.</i>)</li> <li>4. Field calibrate. See <i>Section 5 - Input Calibration.</i></li> </ol>
<b>IN1_FL</b>	Two consecutive failures of input 1 integration; i.e., cannot make analog to digital conversion. This will happen if: <ul style="list-style-type: none"> <li>• Upscale or Downscale burnout is selected and the input is open</li> <li>• Input not configured correctly for the sensor being used</li> </ul>	<ol style="list-style-type: none"> <li>1. Make sure the actuation is configured correctly. See <i>Section 3 - Configuration.</i></li> <li>2. Make sure the input is correct and that it has not burned-out (opened).</li> <li>3. Check for gross over-ranging with a multimeter.</li> <li>4. Restore factory calibration. See <i>Subsection 5.8</i></li> </ol>

Lower Display	Reason for Failure	How to Correct the Problem
<b>IN2RNG</b>	Input 2 out of range. The remote input is outside the range limits.	Same as IN1RNG above.
<b>IN2_FL</b>	Two consecutive failures of input 2 integration. i.e., cannot make analog to digital conversion.	Same as IN1FL above.
<b>CNFERR</b>	<ul style="list-style-type: none"> <li>• PV low limit is &gt; PV high limit</li> <li>• SP low limit is &gt; SP high limit</li> <li>• Output low limit &gt; Output high limit</li> </ul>	1. Check the configuration for each item and reconfigure if necessary.
<b>PV LIM</b>	PV out of range. $PV = INP1 \times RATIO1 + INP1 \text{ BIAS}$	1. Make sure the input signal is correct. 2. Make sure the Ratio and Bias settings are correct. 3. Recheck the calibration. Use Bias of 0.0
<b>RV LIM</b>	The result of the formula shown below is beyond the range of the remote variable. $RV = INP2 \times RATIO + BIAS$	1. Make sure the input signal is correct. 2. Make sure the Ratio2 and Bias2 settings are correct. 3. Recheck the calibration. Use a Ratio2 of 1.0 and a Bias2 of 0.0.
<b>SEGERR</b>	Setpoint Program start segment number is less than ending segment number.	Check SP Program configuration, subsection 3.5 Set up Group SPPROG function prompts "STRSEG" and "ENDSEG".
<b>TCWARN</b>	The Thermocouple is starting to burnout.	This diagnostic message means that the controller has detected that the thermocouple is starting to burnout. This error message may also be created if the resistance of the wires used to connect the thermocouple to the instrument is above 100 ohms.
<b>TCFAIL</b>	The Thermocouple is in imminent danger of burning out.	This diagnostic message means that the controller has detected that the thermocouple will soon fail. User should consider replacing the thermocouple as soon as possible. This message will also be generated if the resistance of the wires used to connect the thermocouple to the instrument is above 180 ohms.
<b>OUT1FL</b>	Current Output is less than 3.5 mA.	The current output is open circuit. Check the field wiring. See Procedure #2.
<b>OUT2FL</b>	Auxiliary Output is less than 3.5 mA.	The auxiliary output is open circuit. Check the field wiring. See Procedure #10.

## 7.6 Controller Failure Symptoms

### Introduction

In addition to the error message prompts, there are failure symptoms that can be identified by noting how the controller displays and indicators are reacting.

### Symptoms

Compare your symptoms with those shown in Table 7-4.

**Table 7-4 Controller Failure Symptoms**

Upper Display	Lower Display	Indicators	Controller Output	Probable Cause	Trouble-shooting Procedure
Blank	Blank	Off	None	Power Failure	1
OK	Displayed Output disagrees with Controller Output	OK	Controller Output disagrees with Displayed Output	Current Proportional Output	2
OK		OK		Three Position Step Control Output	3
OK		OK		Time Proportional Output	4
OK		OK		Current/Time Proportional Output	5
OK	OK	OK	External Alarm function does not operate properly	Malfunction in alarm output	6
Display does not change when a key is pressed				Keyboard Malfunction	7
Controller fails to go into "Slave" operation during communications				Communications Failure	8
OK	Displayed Output disagrees with Auxiliary Output	OK	Controller Auxiliary Output disagrees with Displayed Auxiliary Output	Auxiliary Output	9

### Other symptoms

If a set of symptoms or prompts other than the one you started with appears while troubleshooting, re-evaluate the symptoms. This may lead to a different troubleshooting procedure.

If the symptom still persists, refer to the installation section in this manual to ensure proper installation and proper use of the controller in your system.

## 7.7 Troubleshooting Procedures

### Introduction

The troubleshooting procedures are listed in numerical order as they appear in Table 7-4. Each procedure lists what to do if you have that particular failure and how to do it or where to find the data needed to accomplish the task.



### **WARNING—SHOCK HAZARD**

**TROUBLESHOOTING MAY REQUIRE ACCESS TO HAZARDOUS LIVE CIRCUITS, AND SHOULD ONLY BE PERFORMED BY QUALIFIED SERVICE PERSONNEL. MORE THAN ONE SWITCH MAY BE REQUIRED TO DE-ENERGIZE UNIT BEFORE SERVICING.**

---

### Equipment needed

You will need the following equipment in order to troubleshoot the symptoms listed in the tables that follow:

- Multimeter – Capable of measuring millivolts, milliamps and resistance.
- Calibration sources – T/C, mV, Volt, etc.

## Procedure #1

Table 7-5 explains how to troubleshoot power failure symptoms.

**Table 7-5 Troubleshooting Power Failure Symptoms**

Step	What to do	How to do it
1	Check the AC line voltage.	Use a voltmeter to measure the AC voltage across terminals L1 and L2 on the rear terminal panel of the controller.  Check the earth ground connection.
2	Make sure the chassis plugs into the rear of the case properly.	Withdraw the chassis and visually inspect the controller board and the inside of the case.
3	Check the system for Brown-outs, heavy load switching, etc., and conformance to installation instructions.	Refer to <i>Section 2 - Installation</i> .
4	Change Power board.	Installation instructions supplied with new board.

---

## Procedure #2

Table 7-6 explains how to troubleshoot Current Output failure symptoms.

**Table 7-6 Troubleshooting Current Output Failure**

Step	What to do	How to do it
1	Make sure the controller is configured for Current output and the proper range (4 to 20 or 0 to 20) is configured.	Make Output Set Up group function prompt OUT ALG = CUR.  Make the Output Set UP group function prompt CRANGE = 4-20 or 0-20 per your application.  Refer to <i>Section 3 - Configuration</i> .
2	Check the field wiring.	Output impedance must be less than or equal to 1000 ohms.
3	Check the output.	Put the controller into Manual mode and change the output from 0 % to 100 % (4-20 mA). Use a DC milliammeter at the rear terminals to verify the output.
4	Recalibrate the Current Proportional output.	Refer to <i>Section 6 - Output Calibration</i> for details.
5	Change Current Output board.	Installation instructions provided with new board.
6	Change Controller	

---

**Procedure #3**

Table 7-7 explains how to troubleshoot Position Proportional Output failure symptoms.

**Table 7-7 Troubleshooting Three Position Step Control Output Failure**

Step	What to do	How to do it
1	Make certain that the controller is configured for Three Position Step control.	Make Output Algorithm Set Up group function prompt OUT ALG = TPSC.  Refer to <i>Section 3.8</i> .
2	Check the field wiring.	Refer to <i>Section 2 - Installation</i> for details.
3	Check the output.	Put the controller into Manual mode and change the output from 0 % to 100 %.
4	Check whether the motor drives in both directions.	Remove controller and short out Output 1 or Output 2. The motor should go to either open or closed. If it does controller is ok. If not, repeat Step 1.
5	Check whether the motor drives in either direction. If the motor does not drive in either direction, check the motor. If the motor drives in one direction but not the other, go to Step 6	Refer to the motor instructions.
6	Make sure the output relays are actuating properly.	Put the controller into Manual mode. Vary the output above and below the present value. Observe "OT" in the Lower Display and the Relay Annunciators on the operator interface.  If they are not working properly, check the field wiring, then go to Step 5.  If they are, go to Step 7.
7	Change the two Output Relays or the Dual Relay Board (depending upon unit)	Installation instructions supplied with the new relays or board.

**Procedure #4**

Table 7-8 explains how to troubleshoot Time Proportional Output failure.

**Table 7-8 Troubleshooting Time Proportional Output Failure**

Step	What to do	How to do it
1	Make sure the controller is configured for Time Proportional output.	Make Output Algorithm Set Up group function prompt OUTALG = RLY or RLYD.  Refer to <i>Section 3 - Configuration</i> .
2	Check the field wiring.	Make sure the NO or NC contact wiring is correct.  Refer to <i>Section 2 - Installation</i> for details.
3	Check the output.	Put the controller into Manual mode. Vary the output above and below the present value. Observe OUT1 indicator on the operator interface. Contact should change state. 0 % open, 100 % closed. Listen for a click from the relay when the OUT1 indicator changes state.
4	Check relay.	Change relay.
5	Change MCU board.	Installation instructions supplied with the new board.

---

**Procedure #5**

Table 7-9 explains how to troubleshoot Current/Time or Time/Current Proportional Output failure.

**Table 7-9 Troubleshooting Current/Time or Time/Current Proportional Output Failure**



Step	What to do	How to do it
1	Make sure the controller is configured for Time/Current or Current/Time Proportional output.	Make Output Algorithm Set Up group function prompt OUT ALG = TCUR or CURT. Refer to <i>Section 3 – Configuration</i> .
2	Check the field wiring.	Make sure the NO or NC contact wiring selection is correct. Refer to <i>Section 2 - Installation</i> for details.
3	Check the relay output.	Put the controller into Manual mode. Vary the output above and below the present value. Observe OUT1 indicator on the operator interface. Listen for a click from the relay when the OUT1 indicator changes state.
4	Check the Current Proportional Output.	Put the controller into Manual mode and change the output from 0 % to 100 % (4-20 mA). Use a DC milliammeter at the rear terminals to verify the output.
5	Recalibrate the controller.	Refer to <i>Section 6 - Output Calibration</i> for details.
6	Change relay and/or Current Output boards.	Installation instructions supplied with new board.

**Procedure #6**

Table 7-10 explains how to troubleshoot Alarm Relay Output failure.

**Table 7-10 Troubleshooting Alarm Relay Output Failure**

Step	What to do	How to do it
1	Check the alarm configuration data. If it is correct, check the field wiring.	Reconfigure if necessary. Refer to <i>Section 3 - Configuration</i> for details.
2	Check that the applicable alarm relay actuates properly depending on what you have set at prompt AxSxTYPE.  If it does, check the field wiring.	If the alarm type is set for PV, place the controller in manual mode. Vary the input to raise and lower the PV around the setpoint. Listen for a click from the relay as the PV moves in either direction and note that the proper ALM1 or ALM2 is lit.  EXAMPLE: If the alarm is set for MAN, put the controller into manual mode. The alarm light is ON. Put the controller into automatic mode and the alarm light is OFF.
3	Check the contacts.	Make sure the NO or NC contact wiring is correct.  Refer to <i>Section 2 - Installation</i> for relay contact information.
4	Change the relay and/or the current output board.	Installation instructions supplied with the new relay or board.
5	Change MCU board.	Installation instructions supplied with the new board.

**Procedure #7**

Table 7-11 explains how to troubleshoot a Keyboard failure.



**Table 7-11 Troubleshooting a Keyboard Failure**

Step	What to do	How to do it
1	Make sure the keyboard is connected properly to the MCU/output and power/input boards.	Withdraw the chassis from the case and visually inspect the connection.
2	Controller Keyboard or specific keys may be LOCKED OUT via the security code.	Use your four-digit security code number to change the lockout level. Refer to <i>Section 3 – Configuration</i> .
3	Run the keyboard test.	<p>Press the <b>[SET UP]</b> key and hold in, then press the <b>[FUNCTION]</b> key at the same time. The controller will run a display test. Then you will see:</p> <p style="text-align: center;">Upper Display  <div style="border: 1px solid black; padding: 2px; display: inline-block;">KEYS</div></p> <p style="text-align: center;">Lower Display  <div style="border: 1px solid black; padding: 2px; display: inline-block;">TRY ALL</div></p> <p>Press each key. If it works, the key name will appear in the lower display.</p>
4	Replace the display/keyboard if any keys do not function.	Refer to <i>“Parts Replacement Procedures”</i> in this section.

**Procedure #8**

Table 7-11 explains how to troubleshoot a Communications failure

**Table 7-12 Troubleshooting a RS-485 Communications Failure**

Step	What to do	How to do it
1	Check the Address Number, ComState and Baud Rate settings.	See Section 3.13.
2	Check the field wiring and termination resistor.	Using an ohm meter, check the resistance across the communications rear terminals. See Section 2.7 for wiring diagrams.
3	Make sure the Communications Printed Wiring Board is installed properly in the controller.	Withdraw the chassis from the case and inspect the board. See the exploded view (Figure 8-1) for location of the board. Return the chassis to the case.
4	<p>Determine if the Communications board is faulty by running a LOCAL LOOPBACK TEST.</p> <p>If the test fails, replace the board. If the test passes, the problem is most likely elsewhere in the communications network.</p>	<p>Disconnect the communications cable from the rear terminals. Run the Local Loopback Test.</p> <p>Press <b>[SET UP]</b> until you see:</p> <p>Upper Display  <div style="border: 1px solid black; padding: 2px; display: inline-block;">SET UP</div></p> <p>Lower Display  <div style="border: 1px solid black; padding: 2px; display: inline-block;">COM</div></p> <p>Press <b>[FUNCTION]</b> until you see:</p> <p>Upper Display  <div style="border: 1px solid black; padding: 2px; display: inline-block;">DISABLE</div></p> <p>Lower Display  <div style="border: 1px solid black; padding: 2px; display: inline-block;">LOOPBACK</div></p> <p>Press  or  you will see:</p> <p>Upper Display  <div style="border: 1px solid black; padding: 2px; display: inline-block;">ENABLE</div></p> <p>Lower Display  <div style="border: 1px solid black; padding: 2px; display: inline-block;">LOOPBACK</div></p> <p>The test will run until the operator disables it here.</p>

## Procedure #9

Table 7-13 explains how to troubleshoot a Communications failure

**Table 7-13 Troubleshooting an Ethernet Communications Failure**

Step	What to do	How to do it
1	Check the IP address, Subnet Mask address and Gateway address settings.	See the PIE Tool Manual.
2	Check if the Ethernet Connection is active.	Looking into the instrument, there should be steady green LED. If this is not present, then the instrument is not seeing a valid Ethernet connection. See Section 2.7 for wiring diagrams. A second green LED will blink during actual Ethernet transactions.
3	Change Ethernet Communications board.	Installation instructions provided with new board.
4	Change Controller	

## Procedure #10

Table 7-14 explains how to troubleshoot Auxiliary Proportional Output failure symptoms.

**Table 7-14 Troubleshooting Auxiliary Output Failure**

Step	What to do	How to do it
1	Make sure the controller is configured for Auxiliary Output and the proper range (4 to 20 or 0 to 20) is configured.	Make Options Set Up group function prompt AUX OUT any selection other than NONE. If this prompt does not show up, check if DIG IN 2 is enabled. If so, then as Auxiliary Output and Digital Input 2 are mutually exclusive, you must chose which one of these features you wish to use.  Make the Options Set UP group function prompt CRANGE = 4–20 or 0–20 per your application.  Refer to <i>Section 3 - Configuration</i> .
2	Check the field wiring.	Output impedance must be less than or equal to 1000 ohms.
3	Check the output.	Change the AUX OUT selection to OUTPUT. Put the controller into Manual mode and change the output from 0 % to 100 % (4-20 mA). Use a DC milliammeter at the rear terminals to verify the output.
4	Recalibrate the Auxiliary output.	Refer to <i>Section 6 - Output Calibration</i> for details.
5	Change Auxiliary Output board.	Installation instructions provided with new board.
6	Change Controller	

## 7.8 Restoring Factory Configuration

### Introduction

This procedure restores the configuration of the instrument back to the Factory Settings per Section 3.17.

**ATTENTION:** Restoring the factory configuration overwrites all user-entered configuration changes. This procedure cannot be undone, it is a one-way process.

Table 7-15 explains how to restore Factory Configuration.

**Table 7-15 Restoring Factory Configuration**

Step	What to do
1	Turn off the power to the instrument for at least five seconds.
2	Turn the power back on and simultaneously press the <b>FUNCTION</b> and ▲ keys. This must be done while “TEST DONE” is being displayed.
3	If step 2 was performed correctly, the instrument will now display “UDC” [Upper] “UPDATE” [Lower].
4	Press the <b>FUNCTION</b> Key. The instrument will now display “DIS” [Upper] “RESTORE” [Lower].
5	Press the ▲ key. The instrument will now display “CFG” [Upper] “RESTORE” [Lower].
6	Press the <b>FUNCTION</b> Key. The instrument will now display “DOIN” “RESTORE”
7	When the instrument finishes the restore operation, it automatically resets itself and restarts in the product mode. The instrument configuration will now be the same as it was when the instrument left the factory and all user-entered configurations since that time have been overwritten.

## 7.9 Software Upgrades

### Introduction

This procedure enables software features that were not ordered from the factory. See

**Table 8-3** for a list of the available Software Upgrades.

#### **ATTENTION:**

This procedure cannot be undone, it is a one-way process.

Each instrument has a unique code number sequence, so the following procedure must be performed on each instrument to be upgraded.

Table 7-16 explains how to enable new software features.

**Table 7-16 Software Upgrades**

Step	What to do
1	Turn off the power to the instrument for at least five seconds.
2	Turn the power back on and simultaneously press the <b>FUNCTION</b> and ▲ keys. This must be done while “TEST DONE” is being displayed.
3	If step 2 was performed correctly, the instrument will now display “UDC” [Upper] “UPDATE” [Lower].
4	Press the <b>FUNCTION</b> Key. The instrument will now display “DIS” [Upper] “RESTORE” [Lower].
5	Press the ▲ key. The instrument will now display “CFG” [Upper] “RESTORE” [Lower].
6	Press the ▲ key. The instrument will now display “OPTN” [Upper] “RESTORE” [Lower].
7	Press the <b>FUNCTION</b> Key. The instrument will now display “XXXX” [Upper] “ENTER1” [Lower], where XXXX is a unique code number for this particular instrument. Write this number down.
8	Press the <b>FUNCTION</b> Key. The instrument will now display “XXXX” “ENTER2”. Write this number down.
9	Press the <b>FUNCTION</b> Key. The instrument will now display “XXXX” “ENTER3”. Write this number down.
10	Write down the Model and Serial Numbers of your instrument.

- 11 Contact your Honeywell Representative to place an order. Please have a company purchase order number available before you call. The order entry person will ask for the following information:
1. Software Upgrade Part Number you require:  
Dual Display with Auto/Manual – 50004634-501, or  
Set Point Programming (includes Dual Display and Auto/Manual) – 50004634-502
  2. Model Number of your instrument(s)
  3. Serial Number of your instrument(s)
  4. Code Numbers 1, 2 and 3 from your instrument(s)
  5. Purchase order number.

With this information, a new code number set will be generated for your instrument.

- 12 When you have the new code number set, repeat steps 1 to 6.
- 13 Press the **FUNCTION** Key. The instrument will now display “XXXX” “ENTER1”, where XXXX is a unique code number for this particular instrument. Using the ▲ and ▼ keys, enter the new Code 1 number.
- 14 Press the **FUNCTION** Key. The instrument will now display “XXXX” “ENTER2”. Using the ▲ and ▼ keys, enter the new Code 2 number.
- 15 Press the **FUNCTION** Key. The instrument will now display “XXXX” “ENTER3”. Using the ▲ and ▼ keys, enter the new Code 3 number.
- 16 Press the **FUNCTION** Key. The instrument will process the new code numbers and add the new software feature. If the code numbers were entered incorrectly, the controller will go into Manual Mode and flash the message “FAILSAFE” on the lower display. Repeat steps 12 through 16.
- 17 When the instrument finishes the operation, it automatically resets itself and restarts in the product mode. The instrument configuration now includes the added software feature(s).
-



# 8 Parts List

## 8.1 Exploded View

### Introduction

Figure 8-1 is an exploded view of the UDC2500 Controller. Each part is labeled with a key number. The part numbers are listed by key number in Table 8-1. Parts not shown are listed in Table 8-2.

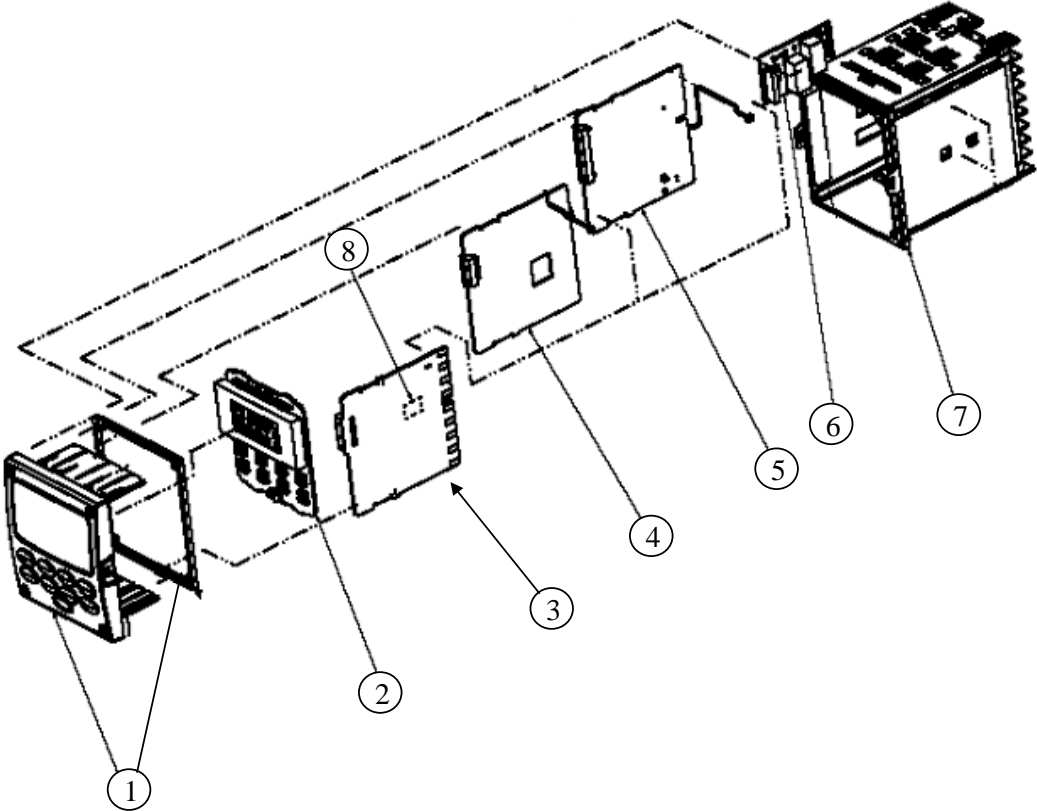


Figure 8-1 UDC2500 Exploded View

**Table 8-1 Parts Identification**

Key Number	Part Number	Description
1	51453143-501	Bezel Assembly and Bezel Gasket
2	51452758-502	Display/Keyboard (with IR)
3	51452822-502	Power/Output PWA (90-250 Vac Operation)
	51452822-503	Power/Output PWA (24 Vac/dc Operation)
4	51452810-501	Auxiliary Output/Digital Input/RS-422/485 Communications PWA
	51452816-501	Auxiliary Output/Digital Input/Ethernet Communications PWA
5	51452801-503	MCU/Inputs PWA (with 2nd Input and IR) for Controllers
	51452801-504	MCU/Inputs PWA (with IR) for Limit Controllers
6	30755306-501 30756679-501 30756725-501 51452804-501 51452807-501	Output 1/2 <ul style="list-style-type: none"> <li>• Electro-Mechanical Relay</li> <li>• Open Collector Output PWA</li> <li>• Solid State Relay</li> <li>• Current Output PWA</li> <li>• Dual Electromechanical Relay PWA</li> </ul>
7	51452759-501	Case Assembly (including Mounting Kit with 4 brackets & screws)
8	30755306-501 30756679-501 30756725-501	Output 3 <ul style="list-style-type: none"> <li>• Electro-Mechanical Relay</li> <li>• Open Collector Output PWA</li> <li>• Solid State Relay</li> </ul>

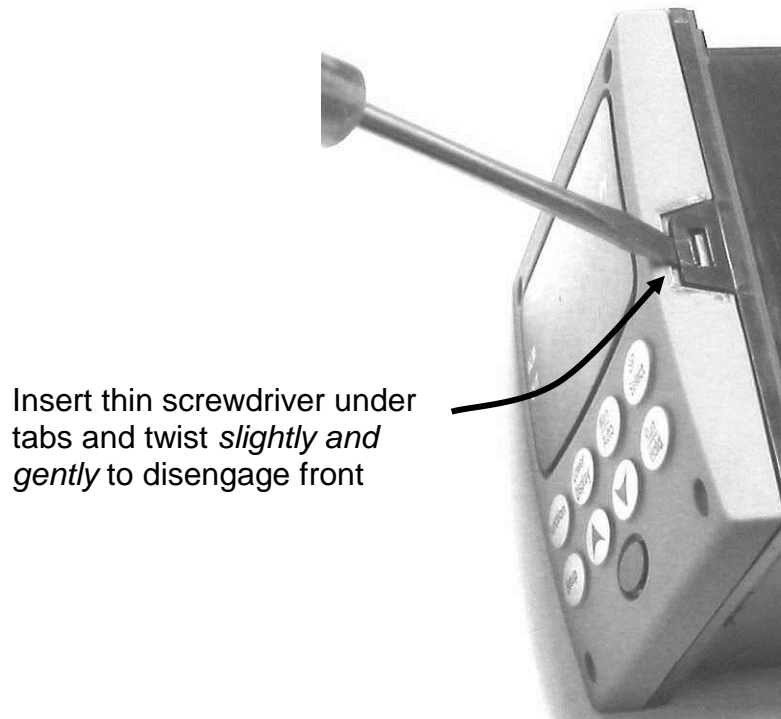
**Table 8-2 Parts Not Shown**

Part Number	Description
30731996-506	4-20 mA Input Resistor Assembly (250 ohm)
30754465-501	0-10 Volt Input Resistor Assembly (100K pair)
51452763-501	Mounting Kits (12 brackets & screws)

**Table 8-3 Software Upgrades (see Section 7.9)**

Part Number	Description
50004634-501	Dual Display and Manual/Auto
50004634-502	Dual Display, Manual/Auto and Set Point Programming (SPP)

## 8.2 Removing the chassis



Using a thin screwdriver, *gently* twist the screwdriver to pry the side tabs from the front face. Pry just enough to release it, *otherwise you'll bend or break the tab*. If you break or bend the tab and can't reattach the front snugly, you'll need to reattach the front using the 4 NEMA4 screws provided. See Table 2-4 page 17.

## 9 Modbus RTU Function Codes

### 9.1 Overview

This section describes the function codes needed to upload and download the configuration from a host computer into this instrument.

#### What's in this section?

The following topics are covered in this section.

TOPIC	See Page
9.1 Overview	182
9.2 General Information	182
9.3 Function Code 20	184
9.4 Function Code 21	188

### 9.2 General Information

This instrument uses a subset of the standard Modbus RTU function codes to provide access to process-related information. Several MODICON function codes are implemented. It is appropriate to define instrument-specific "user-defined" function codes. Where differences occur between the two protocols it will be noted. Several standard Modbus RTU function codes are supported.

#### Configuration ID Tags

Function codes **20** and **21** use the RS422/485 tag IDs for accessing configuration and process-related data. These tags are fully explained in *Section 10*.

The tag IDs represent the register addresses used in the Request Message.

#### Other Modbus Codes

For Modbus codes **other than** for accessing configuration and process-related data for this controller, refer to the Modbus RTU Serial Communications User Manual # 51-55-25-66.

## Register Address Structure

**Table 9-1 Integer Parameter Type**

Register Numbers (Dec)	Name	Access	Notes
1	Type = 1	NOT SUPPORTED	16-bit Unsigned Integer
2	Attribute	NOT SUPPORTED	1 = Read Only, 2 = Read/Write
3	Value (16 bit integer)	Read / Write	
4	Not Used	NOT SUPPORTED	
5	Low Range (16 bit integer)	NOT SUPPORTED	
6	Not Used	NOT SUPPORTED	
7	High Range (16 bit Integer)	NOT SUPPORTED	
8	Not Used	NOT SUPPORTED	
9 to 13	Description Text (ASCII string)	NOT SUPPORTED	

**Table 9-2 Floating Point Parameter Type**

Register Numbers (Dec)	Name	Access	Notes
1	Type = 2	NOT SUPPORTED	IEEE Floating Point
2	Attribute	NOT SUPPORTED	1 = Read Only, 2 = Read/Write
3	Value (float high word)	Read / Write	
4	Value (float low word)	NOT SUPPORTED	
5	Low Range (float high word)	NOT SUPPORTED	
6	Low Range (float low word)	NOT SUPPORTED	
7	High Range (float high word)	NOT SUPPORTED	
8	High Range (float low word)	NOT SUPPORTED	
9 to 13	Description Text (ASCII string)	NOT SUPPORTED	

## Register Count

The register count depends on the data format of the registers being read or written.

Integer data is represented in sixteen bits and is transferred high byte first.

Floating point data is transferred in IEEE 32-bit format.

The register count definitions are:

0001 = Integer Data

0002 = Floating Point Data

## 9.3 Function Code 20 (14h) - Read Configuration Reference Data

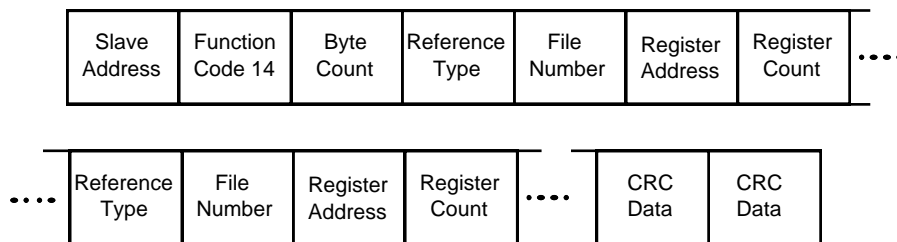
### Description

Function code 20 (14 Hex) is used in this instrument to read information stored in its configuration database. Each configuration item is explicitly addressed by a file number and register address. IEEE 32-bit floating point and 16-bit integer formats are supported.

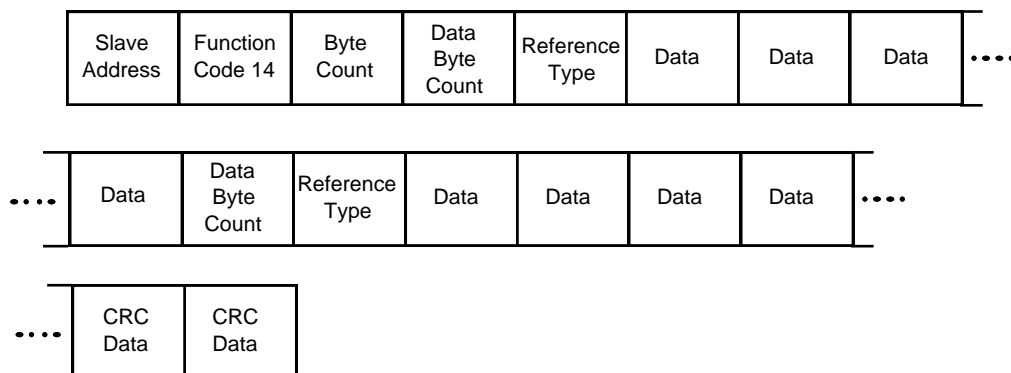
### Request and Response Formats

The Request and Response formats for Function code 20 (14 Hex) are shown below. Details for each block reference follow.

#### Request Message Format



#### Response Message Format



### Byte Count

The Byte Count equals the number of bytes transmitted in either the request or response message and will be the minimum number required to transmit all requested data.

### Data Byte Count

The Data Byte Count is the number of data bytes of the *sub response* including the Reference Type but not including itself. A floating point sub response has four bytes of data and one byte representing the reference type making the data byte count equal to five.

## Reference Type Definitions

The Reference Type definition is always 06.  
 See examples in Subsection 9.3.1

## File Number

The file number word contains the register number from the register address structure tables on page 3. Although the register address structure tables indicate up to 13 data registers are available for access, only register address 3 is currently supported.

## Register Address

The register address word represents the tag ID number for the parameter(s) being accessed. The register address word is made up of two bytes—the MSB = 00 always. The LSB contains the tag ID number. The tag ID numbers represent the parameter's register address(es). See Section 3 for the tag ID numbers.

**Table 9-3 Register Address Format for Function Code 20**

Register Address(es) (Decimal)	Register Address(es) (Hex)	Format
001 to 125	0001 to 007D	<b>analog</b> formatted data (2 registers – IEEE 32-bit floating point)
128 to 255	0080 to 00FF	<b>integer</b> formatted data (1 register – 16-bit integer)

### 9.3.1 Read Configuration Examples

#### Example #1

The following is an example of a request to read the Gain 1 value using Function code 20.

**Request Message** (Read (Gain 1) = ID Tag 001)

02 14 07 06 00 03 00 01 00 02 (CRC16)

*Where:*

02 = Address  
14 = Function Code 20 (14 hex)  
07 = Byte Count  
06 = Reference Type  
00,03 = File Number (Access Data Value)  
00,01 = Register Address (Standard Access Gain 1 - Tag ID #1)  
00 02 = Register Count (Floating Point Data)  
(CRC16)

This is the response to the above request.

**Response Message**

02 14 06 05 06 3F C0 00 00 (CRC16)

*Where:*

02 = Address  
14 = Function Code 20 (14 Hex)  
06 = Byte Count  
05 = Sub Message Length  
06 = Reference Type (IEEE Floating Point)  
3F C0 00 00 = 1.50 (Value of Proportional Band)  
(CRC16)



**Example #2**

The following is another example of a request and response message using Function code 20.

**Request Message** (Read LSP #1 = ID Tag 39 and LSP #2 = ID Tag 53)

```
02 14 0E 06 00 03 00 27 00 02 06 00 03 00 35 00 02 (CRC16)
```

Where:

```
02      = Address
14      = Function Code 20 (14 Hex)
0E      = Byte Count
06      = Reference Type (IEEE Floating Point)
00,03   = File Number (Access Data Value)
00,27   = Register Address (Standard Access LSP #1 - ID Tag 39)
00,02   = Register Count to read (Floating Point Data)
06      = Reference Type (IEEE Floating Point)
00,03   = File Number (Access Data Value)
00,35   = Register Address (Standard Access LSP #2 - ID Tag 53)
00,02   = Register Count to read (Floating Point Data)
(CRC16)
```

This is the response to the above request.

**Response Message**

```
02 14 0C 05 06 43 C8 00 00 05 06 44 60 00 00 (CRC16)
```

Where:

```
02      = Address
14      = Function Code 20 (14 Hex)
0C      = Byte Count
05      = Data Byte Count (Sub Message Length)
06      = Reference Type (IEEE Floating Point)
43 C8 00 00 = 400.0 (Value of Local Setpoint #1)
05      = Data Byte Count (Sub Message Length)
06      = Reference Type (IEEE Floating Point)
44 60 00 00 = 896.0 (Value of Local Setpoint #2)
(CRC16)
```

## 9.4 Function Code 21 (15h) - Write Configuration Reference Data

### Introduction

Function Code 21 (15 Hex) is used in this instrument to allow writes of integer and floating point values to the configuration database and override values.

The configuration database of this instrument is located in EEROM. The override values are stored in RAM.

Integer format is used to write to “Digital” configuration items. Floating Point format is used to write to “Analog” configuration items as defined by the configuration ID tags.

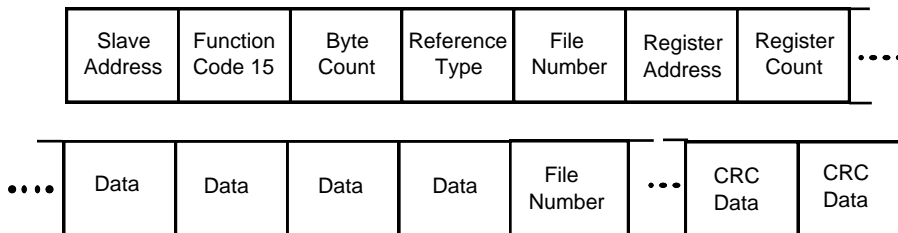
### Write Restrictions

Care should be taken not to exceed the 100,000 write limit of the EEROM.

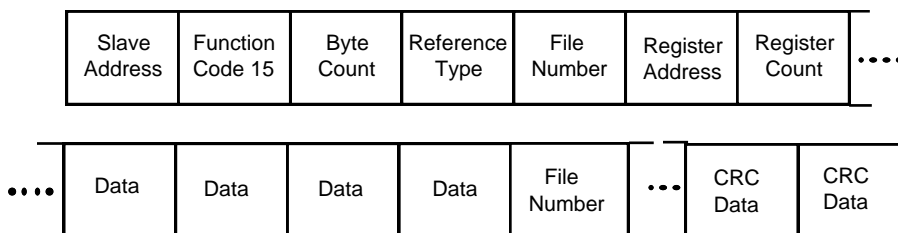
### Request and Response Formats

The Request and Response formats for Function code 21 (15 Hex) are shown below. Details for each block reference follow.

#### Request Message Format



#### Response Message Format (echo back of request)



The register address is interpreted as the tag ID configuration number.

For Infrared Transactions, add three BOFs (C0hex) at the beginning of each message and one EOF (FFhex) at the end of each message.

### Reference Type Definitions

The Reference Type definition is always 06.

*See examples in Subsection 9.4.1*

## File Number

The file number word contains the register number from the register address structure shown in Table 9-1 and Table 9-2. Although the register address structure tables indicate up to 13 data registers are available for access, only register address 3 is currently supported.

## Register Address

The register address is used to designate the tag ID number for the parameter being accessed. The register address is made up of two bytes—the MSB = 00 always. The LSB contains the RS422 tag ID number. The tag ID numbers represent the parameter's register address(es). See *Section 10* for the tag ID numbers.

**Table 9-4 Register Address Format for Function Code 21**

Register Address(es) (Dec)	Register Address(es) (Hex)	Format
001 to 125	0001 to 007D	<b>analog</b> formatted data (2 registers – IEEE 32-bit floating point)
128 to 215 & 255	0080 to 00D7 & 00FF	<b>integer</b> formatted data (2 registers – IEEE 32-bit floating point)

## Unrestricted Registers

As mentioned previously, all register data is stored in the EEROM of this instrument with some exceptions. These exceptions were made to allow write access to override information. The registers, which are designated as Override values, are listed below. These registers do not have restrictions on the number of writes.

<i>ID Tag</i>	<i>Register Number</i>	<i>UDC Usage</i>
125	(7Dh)	Computer Setpoint

## Restrictions on Parameter Numbers in One Message

The maximum number of writeable parameters per write request is 1.

## 9.4.1 Write Configuration Examples

### Example #1

The following is an example of a request to write the Gain 1 value using Function code 21 (15 Hex).

**Request Message** (Write Gain 1= 1.5 “ID Tag 1”)

02 15 0B 06 00 03 00 01 00 02 3F C0 00 00 (CRC16)

Where:

02           = Address  
15           = Function Code 21 (15 Hex)  
0B           = Byte Count  
06           = Reference Type (IEEE Floating Point)  
00 03       = File Number (Access Data Value)  
00 01       = Register Address (Standard Access - Gain 1 - ID Tag 1)  
00 02       = Register Count (Floating Point Data)  
3F C0 00 00 = 1.50  
(CRC16)

This is the response to the above request.

**Response Message** (The response is an echo of the request)

02 15 0B 06 00 01 00 02 00 02 3F C0 00 00 (CRC16)

## 10 Modbus Read, Write and Override Parameters plus Exception Codes

### 10.1 Overview

#### Introduction

This section contains information concerning Reading, Writing, and Overriding parameters in this instrument. There are two types of parameters:

- **Data Transfer**—These parameters include reading control data, option status, and reading or changing setpoints.
- **Configuration Data**—All the configuration data is listed in the order in which it appears in the controller.

Each type of parameter has the identifying codes listed with it.

#### What's in this section?

The following topics are covered in this section.

TOPIC	See Page
10.1 Overview	191
10.2 Reading Control Data	192
10.3 Read Options Status	193
10.4 Miscellaneous Read Onlys	194
10.5 Setpoints	195
10.6 Using a Computer Setpoint (Overriding Controller Setpoint)	196
10.7 Configuration Parameters	197
10.8 Modbus RTU Exception Codes	220

#### General Information

##### *Non-volatile Memory Retention*

- This controller uses non-volatile memory to store configuration data. These memories are guaranteed to retain data for a minimum of ten years as long as the data is not written and erased more than 10,000 times. In order not to exceed this number, it is strongly recommended that configurations which change rapidly such as Computer Setpoint use the Override feature which does not affect non-volatile memory.

### *Analog Parameters*

- Whenever analog register addresses 0001 through 0074 (those that can be changed via communications) are changed, a Write cycle occurs after receipt of the message and the response is returned.

### *Override Parameters*

- Override analog register address 007D (computer setpoint) is not stored in non-volatile memory. It can be changed as frequently as desired with no effect on non-volatile memory retentivity, but the controller must remain in the slave mode.

### *Digital Parameters*

- Whenever digital configuration register addresses 0080 through 00FA are updated via communications, the non-volatile memory is updated as soon as the message is received.

### *Communications Transfer Rates*

- Reads minimum 20mS and writes minimum 200mS

### *Supported Function Codes*

- IR port 20 and 21
- RS485 and Ethernet ports 1,2,3,4,6,16,17,20,21

### *Communications Modes of Operation*

- When the Shed Timer is enabled and a write or override occurs the controller will enter Slave Mode. The keypad is locked from the operator. The purpose of this mode is that if communications is lost and the shed timer times out then the controller will enter a known state of operation. The configuration of the “Shed Mode and Output” and Shed Setpoint Recall are used to configure the controller’s shed state. While in Slave Mode pushing the MAN/AUTO key enters Emergency Manual mode. The local operator then has control of the output. The controller is in Monitor Mode if the Shed timer is disabled.

## **10.2 Reading Control Data**

### **Overview**

The following control data can be read from this instrument:

- Input 1
- Input 2
- PV, SP, Output

### **Register Addresses**

Use the identifying codes listed in Table 10-1 to read the specific items.

A Write request for these codes will result in an Error message.



## 10.4 Miscellaneous Read Onlys

### 10.4.1 Register Addresses for Read Onlys

The identifying register addresses listed in Table 10-3 represent some information that is Read only. No Writes allowed.

**Table 10-3 Miscellaneous Read Onlys**

Parameter Description	Register Address		Data Type	Access	Data Range or Enumerated Selection
	Hex	Decimal			
Software Type	009D	157	INT	RD	READ only (UDC2500) 37 = UDC2500
Software Version	00A7	167	INT	RD	READ only Value less than 255

### 10.4.2 SetPoint Program Read Only Information

The identifying register addresses listed in Table 10-4 represent some information for SetPoint Programming that is Read only. No Writes allowed.

**Table 10-4 SetPoint Program Read Only Information**

Parameter Description	Register Address		Data Type	Access	Data Range or Enumerated Selection
	Hex	Decimal			
Present SPP Segment Number	00FB	251	INT	RD	1 – 12
Segment Time Remaining in Minutes	00FC	252	INT	RD	0 – 59 Minutes
Segment Time Remaining in Hours	00FD	253	INT	RD	0 – 99 Hours
Cycles Remaining	00FE	254	INT	RD	0 – 100
Current Cycle Number	00FF	255	INT	RD	0 – 100



## 10.5 Setpoints

### Overview

You can use two separate local setpoints in the controller. The identifying register addresses listed in Table 10-5 allow you to select which setpoint you want to use and to enter a value in Engineering Units (whichever is selected at register address 00A1) for that setpoint via communications.

### Register Addresses

Make your selection using register address 00AD and enter the value for the setpoint chosen using register address in Table 10-5.

**Table 10-5 Setpoint Code Selections**

Parameter Description	Register Address		Data Type	Access	Data Range or Enumerated Selection
	Hex	Decimal			
Local Setpoint #1	0027	039	FP	R/W	Value within the setpoint range limits
Local Setpoint #2	0035	053	FP	R/W	Value within the setpoint range limits
Number of Local Setpoints	00AD	173	INT	R/W	00 = Local Setpoint #1 only 01 = 2nd Local Setpoint via keyboard or communications

### Associated Parameters

Refer to Table 10-6 to display or change any of the parameters associated with the setpoint.

**Table 10-6 Setpoint Associated Parameters**

Parameter	Register Address	
	Hex	Decimal
Setpoint Limits	0007, 0008	007, 008
Computer Setpoint	007D	125

## 10.6 Using a Computer Setpoint (Overriding Controller Setpoint)

### Overview

You can use a setpoint generated from the computer to override the setpoint being used by the controller. The value generated by the computer will have ratio and bias applied by the controller.

### Register Addresses

Use the identifying code in Table 10-7 to enter the computer setpoint.

**Table 10-7 Computer Setpoint Selection**

Parameter Description	Register Address		Data Type	Access	Data Range or Enumerated Selection
	Hex	Decimal			
Computer Setpoint	007D	125	FP	R/W	Value from computer with Ratio and Bias applied by the controller. Within the Setpoint Range Limits in Engineering Units or Percent.

### Shed

The computer setpoint override will continue until SHED from communications occurs or the controller is placed into monitor mode through communications. Doing periodic SLAVE READS within the shed time will allow the override to continue until communication is stopped and shed time elapses. Does not apply to IR communications.

**ATTENTION**

0 Shed (code 79) allows the override to continue indefinitely or until the reset shed timer register address 1B90 is written using function code 6 or register address 7F using function code 21. Any data value can be written because it is ignored.

When SP is overridden, the upper display becomes “COM” momentarily, and the lower display shows the CSP value as CSXXXX.

**Table 10-7.1 Shed Timer Reset**

Parameter Description	Register Address		Data Type	Access	Data Range or Enumerated Selection
	Hex	Decimal			
Shed Timer Reset	7F	127	FP	W	Exit Slave Mode IR Only

### Associated Parameters

Refer to Table 10-8 for the codes to display or change any of the parameters associated with the computer setpoint.

**Table 10-8 Computer Setpoint Associated Parameters**

Parameter	Register Address	
	Hex	Decimal
Setpoint Limits	0007, 0008	007, 008
Local Setpoint #1	0027	039
Local Setpoint #2	0035	053
Local Setpoint Selection	00AD	173
Computer Setpoint Ratio	005A	90
Computer Setpoint Bias	005B	91
Shed Timer Reset	007F	127

## 10.7 Configuration Parameters

### Overview

Listed on the next pages are the identifying codes for the parameters in the various Set-up Groups in this instrument. Most of the parameters are configurable through the hosts. Some are Read Only and are indicated as such and cannot be changed.

### Reading or Writing

Do a Read or Write, depending on your requirements, using the identifying code and format code listed in the tables. The range or selection available for each range is listed in the tables.

### 10.7.1 Tuning

Table 10-9 lists all the register addresses and ranges or selections for the function parameters in the Set-up Group Tuning.

**Table 10-9 Set-up Group – Tuning**

Parameter Description	Register Address		Data Type	Access	Data Range or Enumerated Selection
	Hex	Decimal			
Gain #1 or PB Note 1	0001	001	FP	R/W	0.01 to 1000 Gain 0.1 to 1000 PB
Rate #1 Note 1	0002	002	FP	R/W	0.00 to 10.00
Reset #1 Note 1	0003	003	FP	R/W	0.02 to 50.00
Manual Reset	000D	013	FP	R/W	-100 to +100
Gain #2 or PB #2 Note 1	0004	004	FP	R/W	0.01 to 1000 Gain 0.1 to 1000 PB
Rate #2 Note 1	0005	005	FP	R/W	0.00 to 10.00
Reset #2 Note 1	0006	006	FP	R/W	0.02 to 50.00
Cycle Time #1	15	21	INT	R/W	1 to 120 seconds
Cycle Time #2	16	22	INT	R/W	1 to 120 seconds

Parameter Description	Register Address		Data Type	Access	Data Range or Enumerated Selection
	Hex	Decimal			
<b>Lockout (keyboard only)</b> Changes to data are always possible via communications regardless of this configuration.	0084	132	INT	R/W	0 = No Lockout 1 = Calibration Locked out 2 = +Configuration – Timer, Tuning, SP Ramp, Accutune are read/write 3 = +View – Tuning and SP Ramp are read/write, no other parameters are available 4 = Maximum Lockout
Security Code	0050	080	INT	R/W	0 to 9999
Man/Auto Key Lockout	00BF	191	INT	R/W	0 = Disable 1 =Enable
Run/Hold Key Lockout	00EE	238	INT	R/W	0 = Disable 1 =Enable
Setpoint Key Lockout	00ED	237	INT	R/W	0 = Disable 1 =Enable

NOTE 1: Writes to these locations are not available when Accutune is enabled.

## 10.7.2 SP Ramp/Rate/Program

Table 10-10 lists all the register addresses and ranges or selections for the function parameters in Set-up Group Setpoint Ramp/Rate.

**Table 10-10 Set-up Group – Setpoint Ramp/Rate**

Parameter Description	Register Address		Data Type	Access	Data Range or Enumerated Selection
	Hex	Decimal			
<b>SP Ramp</b>	0096	150	INT	R/W	0 = Disabled 1 = Enabled
Single SP Ramp Time	19	25	FP	R/W	0 to 255 (minutes)
Final Ramp SP Value	001A	026	FP	R/W	PV Range in Engineering Units
<b>SP Rate</b>	F0	240	INT	R/W	0 = Disabled 1 = Enabled
Rate Up (EU/HR)	006C	108	FP	R/W	0 to 9999
Rate Down (EU/HR)	006D	109	FP	R/W	0 to 9999
<b>Setpoint Program</b>	00B2	178	INT	R/W	0 = Disabled 1 = Enabled
Start Segment #	58	88	FP	R/W	1 to 12
End Segment #(Soak)	00B0	176	INT	R/W	0 = Soak 2 1 = Soak 4 2 = Soak 6 3 = Soak 8 4 = Soak 10 5 = Soak 12
Engineering Units or Ramp Segments	00B6	182	INT	R/W	0 = HRS:MIN 1 = Degrees/Minute 2 = EU/Hour
Program Recycles	59	89	FP	R/W	0 to 100
Guaranteed Soak Deviation	0057	087	FP	R/W	0 to 99.9 (0 = no soak)
Program End State	00B5	181	INT	R/W	0 = Disable SP Program 1 = Hold at Program End

Parameter Description	Register Address		Data Type	Access	Data Range or Enumerated Selection
	Hex	Decimal			
Controller Status at Program End	00B4	180	INT	R/W	0 = Last Setpoint and Mode 1 = Manual, Failsafe Output
Reset SP Program (ToBEGIN)	00B3	179	INT	R/W	0 = Disable 1 = Via Keypad
PV Hotstart	00E2	226	INT	R/W	0 = Disabled 1 = Enabled
Segment #1 Ramp Time	0039	057	FP	R/W	99.59 (0-99 Hrs:0-59 Min) or 0 to 999 (Degrees/Minute)
Segment #2 Soak Setpoint Value	003A	058	FP	R/W	Within Setpoint Limits
Segment #2 Soak Time	003B	059	FP	R/W	99.59 (0-99 Hrs:0-59 Min)
Segment #3 Ramp Time	003C	060	FP	R/W	99.59 (0-99 Hrs:0-59 Min) or 0 to 999 (Degrees/Minute)
Segment #4 Soak Setpoint Value	003D	061	FP	R/W	Within Setpoint Limits
Segment #4 Soak Time	003E	062	FP	R/W	99.59 (0-99 Hrs:0-59 Min)
Segment #5 Ramp Time	003F	063	FP	R/W	99.59 (0-99 Hrs:0-59 Min) or 0 to 999 (Degrees/Minute)
Segment #6 Soak Setpoint Value	0040	064	FP	R/W	Within Setpoint Limits
Segment #6 Soak Time	0041	065	FP	R/W	99.59 (0-99 Hrs:0-59 Min)
Segment #7 Ramp Time	0042	066	FP	R/W	99.59 (0-99 Hrs:0-59 Min) or 0 to 999 (Degrees/Minute)
Segment #8 Soak Setpoint Value	0043	067	FP	R/W	Within Setpoint Limits

Parameter Description	Register Address		Data Type	Access	Data Range or Enumerated Selection
	Hex	Decimal			
Segment #8 Soak Time	0044	068	FP	R/W	99.59 (0-99 Hrs:0-59 Min)
Segment #9 Ramp Time	0045	069	FP	R/W	99.59 (0-99 Hrs:0-59 Min) or 0 to 999 (Degrees/Minute)
Segment #10 Soak Setpoint Value	0046	070	FP	R/W	Within Setpoint Limits
Segment #10 Soak Time	0047	071	FP	R/W	99.59 (0-99 Hrs:0-59 Min)
Segment #11 Ramp Time	0048	072	FP	R/W	99.59 (0-99 Hrs:0-59 Min) or 0 to 999 (Degrees/Minute)
Segment #12 Soak Setpoint Value	0049	073	FP	R/W	Within Setpoint Limits
Segment #12 Soak Time	004A	074	FP	R/W	99.59 (0-99 Hrs:0-59 Min)



### 10.7.3 Accutune

Table 10-11 lists all the register addresses and ranges or selections for the function parameters in Set-up Group Accutune.

**Table 10-11 Set-up Group – Accutune**

Parameter Description	Register Address		Data Type	Access	Data Range or Enumerated Selection
	Hex	Decimal			
Fuzzy Overshoot Suppression	00C1	193	INT	R/W	0 = Disabled 1 = Enabled
Accutune Enable	0098	152	INT	R/W	0 = Accutune Disabled 1 = Tune
Accutune Duplex selection	E1	225	INT	R/W	0 = Manual 1 = Auto 2 = Disable (blend)
Accutune Error (Read only)	0097	151	INT	R/W	0 = None 3 = Process Identification failed 4 = Accutune aborted on command 5 = Running

## 10.7.4 Algorithm

Table 10-12 lists all the register addresses and ranges or selections for the function parameters in Set-up Group Algorithm.

**Table 10-12 Set-up Group – Algorithm**

Parameter Description	Register Address		Data Type	Access	Data Range or Enumerated Selection
	Hex	Decimal			
Control Algorithm Selection (Selection here will affect ID code 160 in Output Algorithms.)	0080	128	INT	R/W	0 = ON/OFF 1 = PID-A 2 = PID-B 3 = PD-A with Manual Reset 4 = Three Position Step 5 = Disable
Timer	00D8	216	INT	R/W	0 = Disable 1 = Enable
Period	0063	099	FP	R/W	00.00 TO 99.59
Start (Initiation)	00D9	217	INT	R/W	0 = Key (Run/Hold Key) 1 = Alarm 2
LDISP (Selection)	00DA	218	INT	R/W	0 = TI REM 1 = Elapsed Time
Timer Reset	00D6	214	INT	R/W	0 = Key (Run/Hold Key) 1 = AL1 (Alarm 1 or Key)
Timer Increment	00D7	215	INT	R/W	0 = Min (Counts hr/min) 1 = Sec (Counts min/sec)

## 10.7.5 Output Algorithms

Table 10-13 lists all the register addresses and ranges or selections for the function parameters in Set-up Group Output.

**Table 10-13 Set-up Group – Output**

Parameter Description	Register Address		Data Type	Access	Data Range or Enumerated Selection
	Hex	Decimal			
Output Algorithm	00A0	160	INT	R/W	0 = Time Simplex 1 = Not Used 2 = Current Simplex 3 = Three Position Step or Position Proportioning 4 = Time Duplex 5 = Current Duplex 6 = Current/Time Duplex 7 = Time/Current Duplex
Relay Cycle Time Increments	00BE	190	INT	R/W	0 = 1 second increments 1 = 1/3 second increments
Motor Time for Three Position Step	004B	075	INT	R/W	5 to 1800 seconds
Current Range for Current Duplex	0099	153	INT	R/W	0 = Full (100%) 1 = Split (50%)
Current Output Range	00EA	235	INT	R/W	0 = 4-20 mA 1 = 0-20 mA

### 10.7.6 Input 1

Table 10-14 lists all the register addresses and ranges or selections for the function parameters in Set-up Group Input 1.

**Table 10-14 Set-up Group – Input 1**

Parameter Description	Register Address		Data Type	Access	Data Range or Enumerated Selection
	Hex	Decimal			
Input 1 Type	00A8	168	INT	R/W	1 = B TC 2 = E TC H 3 = E TC L 4 = J TC H 5 = J TC M 6 = J TC L 7 = K TC H 8 = K TC M 9 = K TC L 10 = NNM H 11 = NNM L 12 = Nicosil H TC 13 = Nicosil L TC 14 = R TC 15 = S TC 16 = T TC H 17 = T TC L 18 = W TC H 19 = W TC L 20 = 100 PT RTD 21 = 100 PT LO RTD 22 = 200 PT RTD 23 = 500 PT RTD 24 = Radiamatic RH 25 = Radiamatic RI 26 = 0-20 mA 27 = 4-20 mA 28 = 0-10 mV 29 = 0-50 mV 30 = 100 mV 31 = 0-5 Vdc 32 = 1-5 Vdc 33 = 0-10 Vdc 34 = Unused 35 = Unused 36 = Thermocouple Differential 37 = PR40-PR20 Thermocouple
<b>ATTENTION</b>					
Changing the Input Type will result in the loss of Field Calibration values and will restore the Factory Calibration values.					

Parameter Description	Register Address		Data Type	Access	Data Range or Enumerated Selection
	Hex	Decimal			
Input 1 Transmitter Characterization	00A9	169	INT	R/W	0 = B TC 1 = E TC H 2 = E TC L 3 = J TC H 4 = J TC M 5 = J TC L 6 = K TC H 7 = K TC M 8 = K TC L 9 = NNM H 10 = NNM L 11 = Nicrosil H TC 12 = Nicrosil L TC 13 = R TC 14 = S TC 15 = T TC H 16 = T TC L 17 = W TC H 18 = W TC L 19 = 100 PT RTD 20 = 100 PT LO RTD 21 = 200 PT RTD 22 = 500 PT RTD 23 = Radiamatic RH 24 = Radiamatic RI 25 = Linear 26 = Square Root
Input 1 High Range Value	001D	029	FP	R/W	-999. to 9999. Engineering Units (Linear types only)
Input 1 Low Range Value	001E	030	FP	R/W	-999 to 9999. Engineering Units (Linear types only)
Input 1 Ratio	006A	106	FP	R/W	-20.00 to 20.00
Input 1 Bias	006B	107	FP	R/W	-999 to 9999. Engineering Units
Input 1 Filter	002A	042	FP	R/W	0 to 120 seconds

Parameter Description	Register Address		Data Type	Access	Data Range or Enumerated Selection
	Hex	Decimal			
Burnout (Open Circuit Detection)	00A4	164	INT	R/W	0 = None and Failsafe 1 = Upscale 2 = Downscale 3 = No Failsafe
Emissivity	0017	023	FP	R/W	0.01 to 1.00

### 10.7.7 Input 2

Table 10-15 lists all the register addresses and ranges or selections for the function parameters in Set-up Group Input 2.

**Table 10-15 Set-up Group – Input 2**

Parameter Description	Register Address		Data Type	Access	Data Range or Enumerated Selection
	Hex	Decimal			
Input 2 Type	00AA	170	INT	R/W	0 = Disable 1 to 25 Unused 26 = 0-20 mA 27 = 4-20 mA 28 to 30 = Unused 31 = 0-5 Vdc 32 = 1-5 Vdc 33 = Unused 34 = Unused 35 = 0 – 2 Vdc
	ATTENTION  Changing the Input Type will result in the loss of Field Calibration values and will restore the Factory Calibration values.				

Parameter Description	Register Address		Data Type	Access	Data Range or Enumerated Selection
	Hex	Decimal			
Input 2 Transmitter Characterization	00AB	171	INT	R/W	0 = B TC 1 = E TC H 2 = E TC L 3 = J TC H 4 = J TC M 5 = J TC L 6 = K TC H 7 = K TC M 8 = K TC L 9 = NNM H 10 = NNM L 11 = Nicrosil H TC 12 = Nicrosil L TC 13 = R TC 14 = S TC 15 = T TC H 16 = T TC L 17 = W TC H 18 = W TC L 19 = 100 PT RTD 20 = 100 PT LO RTD 21 = 200 PT RTD 22 = 500 PT RTD 23 = Radiamatic RH 24 = Radiamatic RI 25 = Linear 26 = Square Root
Input 2 High Range Value	0023	035	FP	R/W	-999. to 9999. Engineering Units
Input 2 Low Range Value	0024	036	FP	R/W	-999 to 9999. Engineering Units
Input 2 Ratio	0025	037	FP	R/W	-20.00 to 20.00
Input 2 Bias	0026	038	FP	R/W	-999 to 9999. Engineering Units
Input 2 Filter	002B	043	FP	R/W	0 to 120 seconds



## 10.7.8 Control

Table 10-16 lists all the register addresses and ranges or selections for the function prompts in Set-up Group Control.

**Table 10-16 Set-up Group – Control**

Parameter Description	Register Address		Data Type	Access	Data Range or Enumerated Selection												
	Hex	Decimal															
Tuning Parameter Selection	00AC	172	INT	R/W	0 = One set only 1 = 2 sets keyboard selected 2 = 2 sets with PV automatic switchover 3 = 2 sets with setpoint (SP) automatic switchover												
Automatic Switchover Value (used with 172 selection 2 or 3)	0038	056	FP	R/W	Within the PV Range in engineering units												
Local Setpoint Source (Number of LSPs)	00AD	173	INT	R/W	0 = One Local Setpoint 1 = Two Local Setpoints												
Power Up Mode Recall	0082	130	INT	R/W	<table border="0"> <tr> <td><b>Control Mode</b></td> <td><b>Setpoint Mode</b></td> </tr> <tr> <td>0 = MAN</td> <td>LSP</td> </tr> <tr> <td>1 = AUTO</td> <td>LSP</td> </tr> <tr> <td>2 = AUTO</td> <td>Last RSP</td> </tr> <tr> <td>3 = LAST</td> <td>Last SP</td> </tr> <tr> <td>4 = LAST</td> <td>Last Local SP</td> </tr> </table>	<b>Control Mode</b>	<b>Setpoint Mode</b>	0 = MAN	LSP	1 = AUTO	LSP	2 = AUTO	Last RSP	3 = LAST	Last SP	4 = LAST	Last Local SP
<b>Control Mode</b>	<b>Setpoint Mode</b>																
0 = MAN	LSP																
1 = AUTO	LSP																
2 = AUTO	Last RSP																
3 = LAST	Last SP																
4 = LAST	Last Local SP																
RSP Source	0083	131	INT	R/W	0 = None 1 = Input 2												
Setpoint Tracking	008A	138	INT	R/W	0 = None 1 = LSP = PV (when in Manual) 2 = LSP = RSP (when switched)												
Control Setpoint High Limit	0007	007	FP	R/W	0 to 100% of PV (engineering units)												
Control Setpoint Low Limit	0008	008	FP	R/W	0 to 100% of PV (engineering units)												

Parameter Description	Register Address		Data Type	Access	Data Range or Enumerated Selection
	Hex	Decimal			
Control Output Direction	0087	135	INT	R/W	0 = Direct 1 = Reverse
High Output Limit	000E	014	FP	R/W	-5 to 105% of output
Low Output Limit	000F	015	FP	R/W	-5 to 105% of output
Output Deadband for Time Duplex	0012	018	FP	R/W	-5 to +25.0%
Output Deadband for TPSC	0014	020	FP	R/W	0.5 to 5.0%
Output Hysteresis	0013	019	FP	R/W	0.0 to 100.0% of PV
Failsafe Mode	00D5	213	INT	R/W	0 = Latching 1 = Non latching
Failsafe Output Level	0028	040	FP	R/W	0 to 100%
TPSC Power-up Output	00B7	183	INT	R/W	0 = Last 1 = Failsafe
TPSC Failsafe Output	00B8	184	INT	R/W	0 = Motor goes to closed position (0%) 1 = Motor goes to open position (100%)
Proportional Band Units	0094	148	INT	R/W	0 = Gain 1 = Proportional band
Reset Units	0095	149	INT	R/W	0 = Minutes 1 = RPM
PV High Range	0036	054	FP	R	PV High Limit
PV Low Range	0037	055	FP	R	PV Low Limit

## 10.7.9 Options

Table 10-18 lists all the register addresses and ranges or selections for the function parameters in Set-up Group Options.

**Table 10-17 Set-up Group – Options**

Parameter Description	Register Address		Data Type	Access	Data Range or Enumerated Selection
	Hex	Decimal			
Auxiliary Output *	0086	134	INT	R/W	0 = None 1 = Input 1 2 = Input 2 3 = PV 4 = Deviation 5 = Output 6 = Setpoint 7 = LSP 1 8 = LSP 2
Low Scaling Factor	0031	049	FP	R/W	Within the range of the selected variable in ID 134
High Scaling Factor	0032	050	FP	R/W	Within the range of the selected variable in ID 134
Auxiliary Output Range	00EC	236	INT	R/W	0 = 4-20 mA 1 = 0-20 mA

Parameter Description	Register Address		Data Type	Access	Data Range or Enumerated Selection
	Hex	Decimal			
Digital Input #1	00BA	186	INT	R/W	0 = None 1 = To Manual 2 = To Local Setpoint #1 3 = To Local Setpoint #2 4 = To Direct Action 5 = To Hold Ramp 6 = To PID Set #2 7 = To Run Ramp 8 = To Begin 9 = No I (Reset) 10 = To Manual Failsafe Output 11 = Disable Keyboard 12 = To Timer 13 = Initiate Limit Cycle Tuning 14 = Setpoint Initialization (SP=PV) 15 = To RSP 16 = Manual Latching 17 = Output 1 tracks Input 2 18 = Start/Restart SP Ramp or SP Program
Digital Input #1 Combinations	00BC	188	INT	R/W	0 = Disable 1 = +PID2 2 = +Direct 3 = +LSP2 4 = +LSP1 5 = +Run
Digital Input #2 *	00BB	187	INT	R/W	Same as Digital Input #1
Digital Input #2 Combinations *	00BD	189	INT	R/W	Same as Digital Input #1 Combinations
* Auxiliary Output and Digital Input #2 are mutually exclusive.					

## 10.7.10 Communications

Table 10-18 lists all the register addresses and ranges or selections for the function parameters in Set-up Group Communications.

**Table 10-18 Set-up Group – Communications**

Parameter Description	Register Address		Data Type	Access	Data Range or Enumerated Selection
	Hex	Decimal			
Communication Address	004D	77	FP	R/W	1 - 99
Communications Type	00E7	231	INT	R/W	0 = None 1 = Disable 2 = RS-485 Modbus 3 = Ethernet
IR Port Enable	00F1	241	INT	R/W	0 = Disable 1 = Enable
Baud Rate	00E8	232	INT	R/W	0 = 4800 1 = 9600 2 = 19200 3 = 38400
Transmit Delay	004E	78	FP	R/W	Response Delay in ms (1 to 500) +6ms
Floating Point Byte Order	00E9	233	INT	R/W	0 = Big Endian 1 = Big Endian Byte Swap 2 = Little Endian 3 = Little Endian Byte Swap
Shed Enable	00EA	234	INT	R/W	0 = Enable 1 = Disable
Shed Time	004F	79	INT	R/W	0 = No Shed 1 = 255 sample periods
Shed Mode and Output	00A2	162	INT	R/W	0 = Last Mode and Last Output 1 = Manual Mode, Last Output 2 = Manual Mode, Failsafe Output 3 = Automatic Mode
Shed Setpoint Recall	00A3	163	INT	R/W	0 = To Last Local Setpoint used 1 = CSP
Computer Setpoint Ratio	005A	90	FP	R/W	-20.00 to 20.00
Computer Setpoint Bias	005B	91	FP	R/W	-999 to 9999.
Comm Data Units	00A1	161	INT	R/W	0 = Percent 1 = Engineering Units

### 10.7.11 Alarms

Table 10-19 lists all the register addresses and ranges or selections for the function parameters in Set-up Group Alarms.

**Table 10-19 Set-up Group – Alarms**

Parameter Description	Register Address		Data Type	Access	Data Range or Enumerated Selection
	Hex	Decimal			
Alarm 1 Setpoint 1 Value	0009	009	FP	R/W	Within the range of selected parameter or PV span for deviation alarm
Alarm 1 Setpoint 2 Value	000A	010	FP	R/W	Within the range of selected parameter or PV span for deviation alarm
Alarm 2 Setpoint 1 Value	000B	011	FP	R/W	Within the range of selected parameter or PV span for deviation alarm
Alarm 2 Setpoint 2 Value	000C	012	FP	R/W	Within the range of selected parameter or PV span for deviation alarm
Alarm 1 Setpoint 1 Type	008C	140	INT	R/W	0 = None 1 = Input 1 2 = Input 2 3 = PV 4 = Deviation 5 = Output 6 = Alarm on Shed 7 = SP Event On 8 = SP Event Off 9 = Manual 10 = Remote Setpoint 11 = Failsafe 12 = PV Rate of Change 13 = Alarm on Digital Input 1 14 = Alarm on Digital Input 2 15 = Loop Break 16 = Deviation based upon SP2 17 = T/C Warning 18 = T/C Fail

Parameter Description	Register Address		Data Type	Access	Data Range or Enumerated Selection
	Hex	Decimal			
Alarm 1 Setpoint 2 Type	008E	142	INT	R/W	Same as 140
Alarm 2 Setpoint 1 Type	0090	144	INT	R/W	Same as 140
Alarm 2 Setpoint 2 Type	0092	146	INT	R/W	Same as 140
Alarm 1 Setpoint 1 Event	008D	141	INT	R/W	0 = Low Alarm 1 = High Alarm
Alarm 1 Setpoint 2 Event	008F	143	INT	R/W	0 = Low Alarm 1 = High Alarm
Alarm 2 Setpoint 1 Event	0091	145	INT	R/W	0 = Low Alarm 1 = High Alarm
Alarm 2 Setpoint 2 Event	0093	147	INT	R/W	0 = Low Alarm 1 = High Alarm
Alarm Hysteresis	0029	041	FP	R/W	0.0 to 100% of output or span
Alarm Latching for Output 1	00C8	200	INT	R/W	0 = Non Latching 1 = Latching
Alarm States	00C9	201	INT	R/W	State = 0 = Not in Alarm State = 1 = In Alarm Bit 0 = Alarm 11 State Bit 1 = Alarm 12 State Bit 2 = Alarm 21 State Bit 3 = Alarm 22 State  Event = 0 = Low Event = 1 = High Bit 4 = Alarm 11 Event Bit 5 = Alarm 12 Event Bit 6 = Alarm 21 Event Bit 7 = Alarm 22 Event
Alarm 1 Blocking	00CA	202	INT	R/W	0 = Disable 1 = Block 1 2 = Block 2 3 = Block 1 2

Parameter Description	Register Address		Data Type	Access	Data Range or Enumerated Selection
	Hex	Decimal			
Diagnostic Alarm	009A	154	INT	R/W	0 = Disable 1 = Alarm 1 2 = Alarm 2



## 10.7.12 Display

Table 10-20 lists all the register addresses and ranges or selections for the function parameters in Set-up Group Display.

**Table 10-20 Set-up Group – Display**

Parameter Description	Register Address		Data Type	Access	Data Range or Enumerated Selection
	Hex	Decimal			
Decimal Point Location	009B	155	INT	R/W	0 = XXXX – Fixed 1 = XXX.X – Floating decimal point to one 2 = XX.XX – Floating decimal point to two
Temperature Units	0081	129	INT	R/W	0 = °F 1 = °C 2 = None
Power Frequency	00A6	166	INT	R/W	0 = 60 Hertz 1 = 50 Hertz
Language (Displays)	00C0	192	INT	R/W	0 = English 1 = French 2 = German 3 = Spanish 4 = Italian 5 = Numeric
Lower Display Enable	00AE	174	INT	R/W	0 = Enable 1 = Disable
Lower Display	00AF	175	INT	R/W	0 = Setpoint 1 = PRY – PV with Label 2 = PRN – PV without Label
TC Diagnostics	009f	159	INT	R/W	0 = Enable 1 = Disable

## 10.8 Modbus RTU Exception Codes

### Introduction

When a master device sends a query to a slave device it expects a normal response. One of four possible events can occur from the master's query:

- *Slave device receives the query without a communication error and can handle the query normally.*  
It returns a normal response.
- *Slave does not receive the query due to a communication error.*  
No response is returned. The master program will eventually process a time-out condition for the query.
- *Slave receives the query but detects a communication error (parity, LRC or CRC).*  
No response is returned. The master program will eventually process a time-out condition for the query.
- *Slave receives the query without a communication error but cannot handle it (i.e., request is to a non-existent coil or register).*  
The slave will return with an exception response informing the master of the nature of the error (Illegal Data Address.)

The exception response message has two fields that differentiate it from a normal response:

#### **Function Code Field:**

In a normal response, the slave echoes the function code of the original query in the function code field of the response. All function codes have a most-significant bit (MSB) of 0 (their values are below 80 hex). In an exception response, the slave sets the MSB of the function code to 1. This makes the function code value in an exception response exactly 80 hex higher than the value would be for a normal response.

With the function code's MSB set, the master's application program can recognize the exception response and can examine the data field for the exception code.

#### **Data Field:**

In a normal response, the slave may return data or statistics in the data field. In an exception response, the slave returns an exception code in the data field. This defines the slave condition that caused the exception.

### Query

Example: Internal slave error reading 2 registers starting at address 1820h from slave at slave address 02.

02 03 18 20 00 02 CRC CRC

### Response

Example: Return MSB in Function Code byte set with Slave Device Failure (04) in the data field.

02 83 04 CRC CRC

**Table 10-21 Modbus RTU Data Layer Status Exception Codes**

Exception Code	Definition	Description
<b>01</b>	Illegal Function	The message received is not an allowable action for the addressed device.
<b>02</b>	Illegal Data Address	The address referenced in the function-dependent data section of the message is not valid in the addressed device.
<b>03</b>	Illegal Data Value	The value referenced at the addressed device location is no within range.
<b>04</b>	Slave Device Failure	The addressed device has not been able to process a valid message due to a bad device state.
<b>05, 06</b>	Slave Device Busy	The addressed device has ejected a message due to a busy state. Retry later.
<b>07</b>	NAK, Negative Acknowledge	The addressed device cannot process the current message. Issue a PROGRAM POLL to obtain device-dependent error data.
<b>09</b>	Buffer Overflow	The data to be returned for the requested number of registers is greater than the available buffer space. <i>Function Code 20 only.</i>

## 11 Ethernet TCP/IP

### 11.1 Overview

Ethernet parameters can only be configured via the Process Instrument Explorer software.

Ethernet IP Address is 10.0.0.2 as shipped from the Factory.

The MAC address is printed on the case label of each instrument.

When constructing a network, it is recommended that a Switch be used to connect UDCs to a LAN rather than using a Hub. This is because a Switch passes only those messages for IP addresses that are connected to the Switch while a Hub passes all message traffic. Using a Switch thus improves the overall throughput of the traffic to and from the UDCs.

## **12 Further information**

### **12.1 Modbus RTU Serial Communications**

Refer to Honeywell document 51-52-25-66 Modbus RTU Serial Communications User Manual.

### **12.2 Modbus Messaging on TCP/IP**

Refer to Honeywell document 51-52-25-121 MODBUS Messaging on TCP/IP Implementation Guide.

### **12.3 How to Apply Digital Instrumentation in Severe Electrical Noise Environments**

Refer to Honeywell document 51-52-05-01 How to Apply Digital Instrumentation in Severe Electrical Noise Environments.

## Index

### A

Aborting Accutune, 114  
 Accutune Error Codes, 114  
**ACCUTUNE ERROR STATUS**, 46  
 Accutune III, 109  
 Accutune Set Up Group, 44, 87  
 Adaptive tune, 45  
 Alarm blocking, 86  
**ALARM HYSTERESIS**, 85  
**Alarm Outputs**, 9  
 Alarm Relay Output failure, 176  
 Alarm Relays, 15  
 Alarm Setpoints, 117  
 Alarm Setpoints Display, 117  
 Alarms Set Up Group, 81  
 Algorithm Set Up Group, 47  
**Analog Inputs**, 8  
 Annunciators, 98  
 Application related problems, 165  
 ATUNE Group, 45, 87  
 Auto/Manual key, 97  
**AUTOMATIC with LOCAL SETPOINT**, 105  
**AUTOMATIC with REMOTE SETPOINT**, 105  
 Auto-only Mode, 102  
 Autotune is complete, 115  
 Auxiliary Output Calibration, 160  
 Auxiliary Output Calibration Procedure, 161  
 Auxiliary Output Connections, 31  
 Auxiliary Output Failure, 179

### B

background tests, 168  
**BAUD RATE**, 77  
 Bias, 58, 62  
 blended tune, 112  
 Burnout protection, 58

### C

Calibration Mode, 154, 162  
 Calibration Steps, 142  
 CE Conformity (Europe), 5  
 Changing Control Modes, 106  
 Changing the Local Setpoints, 106  
 Communications failure, 177, 179  
**Communications Interface**, 10  
 Composite Wiring Diagram, 22  
 Computer Setpoint, 200  
 Computer setpoint ratio, 79  
 Configuration, 33  
 Configuration Parameters, 202

Configuration Procedure, 35  
 Configuration Prompt Hierarchy, 34  
 Control algorithm, 47  
 Control and Alarm Relay Contact Information, 15  
 Control Modes, 105  
 Control Relays, 15  
 Control Set Up Group, 63, 70, 77  
 Control/Alarm Circuit Wiring, 18  
 Controller Failure Symptoms, 170  
 Controller Grounding, 18  
**Controller Output Types**, 9  
 Current duplex, 53  
 Current Output, 28  
 Current Output Calibration, 158  
 Current Output Calibration Procedure, 159  
 Current Output Failure, 172  
 Current simplex, 53  
 Current/time duplex, 53  
 Current/Time or Time/Current Proportional Output failure, 174  
 Customer support, 166  
 Cycle time (cool), 38  
 Cycle time (heat), 38

### D

Deadband, 67  
 decimal places, 87  
 Demand Tuning, 44  
 Diagnostic Alarm, 86  
 diagnostic message, 100  
 Digital input (remote) operation, 129  
**Digital input selections**, 72  
**Digital Inputs**, 8  
 Digital Inputs Option Connections, 31  
 Dimensions, 16  
 Direct acting control, 66  
 Displays, 3  
 Dual Electromechanical Relay Option Output, 28  
 Duplex Control, 111, 113

### E

ELAPSED TIME, 108  
 Electrical Considerations, 18  
 Electrical Noise Precautions, 18  
 Electromechanical Relay Output, 25  
 Email Configuration Screen, 90  
 Emissivity, 59  
**End segment number**, 124  
**Environmental and Operating Conditions**, 11  
 Equipment you will need to calibrate, 144

Error Codes, 114  
 Error Messages, 100  
 Estimated Motor Position, 118  
 Ethernet Communications Address, 138, 139  
 Ethernet Configuration Screen, 89  
 Ethernet Connection, 136  
 Ethernet Status, 135  
 Ethernet TCP/IP, 226  
**Ethernet TCP/IP Communications Interface**, 10  
 External Interface Option Connections, 30, 31  
 External setpoint program reset, 73  
*External Wiring*, 19

## F

Factory calibration, 154, 162  
**Failsafe Function Prompt**, 119, 120  
 Failsafe Manual Mode, 167  
 Failsafe mode, 69  
 Failsafe Mode, 120  
 Failsafe output value, 67  
**FAILSAFE OUTPUT VALUE**, 119  
 Failsafe Output Value for Restart After a Power Loss, 119  
 Field Wiring, 144  
 Filter, 58, 62  
 Floating Point Parameter Type, 187  
 Function code 20, 188  
 Function Code 21, 192  
 function codes **20** and **21**, 186  
**Function Prompts**, 34  
 Fuzzy Overshoot Suppression, 44, 115  
**FUZZY OVERSHOOT SUPPRESSION**, 45

## G

Gain, 36  
 Gain 2, 37  
**Guaranteed soak**, 124

## H

**HOTSTART**, 75  
 Hysteresis (output relay), 67

## I

Infrared communications, 4  
**Infrared Communications**, 10  
**INFRARED COMMUNICATIONS**, 77  
 Input 1 actuation type, 56, 60  
 Input 1 and Input 2 Wiring Terminals, 144  
 Input 1 Calibration Procedure, 149  
 Input 1 Connections, 24  
 Input 1 high range value, 57, 61  
 Input 1 low range value, 58, 62  
 Input 1 Set Up Group, 56  
 Input 1 Set Up Wiring, 145  
 Input 2 Calibration Procedure, 152  
 Input 2 Connections, 25

Input 2 Set Up Group, 60  
 Input 2 Set Up Wiring, 151, 152  
 Input Calibration, 141  
 Installation, 7  
 Installation related problems, 165  
 Integer Parameter Type, 187  
**Isolation**, 9

## K

Key error, 97  
 key lockout, 97  
 Keyboard failure, 177  
 Keys, 3

## L

Latching, 120  
 Local Area Network (LAN) settings, 138  
 Local setpoint source, 64  
 Lockout, 38  
 lockout feature, 96  
 Lockout levels, 96  
 Loop Data – Alarm Details, 132  
 Loop Data – Digital Input Details, 133  
 Loop Data screen, 131  
 loopback test, 80  
 Lower Display Key Parameter Prompts, 99

## M

Mains Power Supply, 18, 23  
**MANUAL**, 105  
 Manual reset, 37  
**MANUAL TUNE**, 112  
 Manual/Auto key lockout, 39  
 Minimum and Maximum Range Values, 142  
 Modbus Read, Write and Override Parameters, 195  
 Modbus RTU Exception Codes, 224  
 Modbus RTU Function Codes, 186  
 Model Number Interpretation, 12  
 Monitoring t, 94  
 Motor Position Display, 118  
**MOTOR TIME**, 55  
 Mounting, 16  
 Mounting Method, 17  
 Mounting Procedure, 17

## N

Non-Latching, 120

## O

Open Collector Output, 27  
operating parameters, 99  
Operator Interface, 95  
Option Status, 197  
**OUTPUT ALGORITHM**, 52  
Output Calibration, 157  
**OUTPUT LIMIT**, 67  
Output Set Up Group, 52  
Overriding Controller Setpoint, 200

## P

P.I.E. Tool, 136  
P.I.E. Tool Ethernet and Email Configuration Screens, 89  
P.I.E. Tool Maintenance Screens, 130  
Parts Identification, 184  
Parts List, 183  
PD with manual reset, 49  
Permissible Wiring Bundling, 19  
Physical Considerations, 16  
**PID A**, 48  
**PID B**, 48  
Position proportional or 3 position step test failures, 167  
**Power Consumption**, 10  
power failure symptoms, 172  
**Power Inrush Current**, 10  
**POWER LINE FREQUENCY**, 88  
Power outage, 129  
Power Outage, 122  
Power-up Tests, 167  
Pre-installation Information, 8  
Process Instrument Explorer, 4  
Program Contents, 123  
Program record sheet, 127  
**Program state**, 125  
**Program termination state**, 125  
Proportional band, 36  
Proportional band 2, 37  
Proportional band units, 69  
PV Hot Start, 120

## R

**Ramp time or rate segments**, 123  
**Ramp unit**, 124  
Ramp/soak profile example, 125  
Rate, 36  
Rate 2, 37  
Ratio, 58, 62  
Read Onlys, 198  
Reading Control Data, 196  
**Recycle number**, 124  
Register Address Structure, 187  
register count, 187  
relay cycle times, 55  
Remote setpoint source, 65

Removing the chassis, 185  
Reset, 37  
Reset 2, 37  
**Reset Program to Beginning**, 125  
Reset units, 69  
Restore Factory Calibration, 154  
Restore Output Factory Calibration, 162  
Restoring Factory Configuration, 180  
Reverse acting control, 67  
RTD Inputs, 146  
Run/Hold key, 97  
RUN/HOLD key, 121  
Run/Hold key lockout, 39  
Run/Monitor the program, 128

## S

Security code, 38  
Security Code, 95  
Set Point Select function key, 97  
**Set Up Group**, 34  
Set Up Wiring Procedure for Auxiliary Output, 160  
Setpoint Code Selections, 199  
Setpoint high limit, 66  
Setpoint low limit, 66  
Setpoint ramp, 40  
Setpoint Ramp, 121  
Setpoint ramp final setpoint, 41  
Setpoint ramp time, 40  
Setpoint Ramp/Soak Programming, 123  
Setpoint rate, 41  
Setpoint Rate, 122  
Setpoint Select key lockout, 39  
Setpoint tracking, 65  
Setpoints, 106, 199  
Set-up Group Accutune, 207  
Set-up Group Alarms, 220  
Set-up Group Algorithm, 208  
Set-up Group Communications, 219  
Set-up Group Control, 215  
Set-up Group Display, 223  
Set-up Group Input 1, 210  
Set-up Group Input 2, 213  
Set-up Group Options, 217  
Set-up Group Output, 209  
Set-up Group Setpoint Ramp/Rate, 204  
Set-up Group Tuning, 202  
**SHED TIME**, 78  
Single Display Functionality, 102  
Single Display Parameters, 103  
**Soak segments**, 124  
Software Options Status, 197  
Software Type, 198  
Software Upgrade Part Number, 182  
Software Upgrades, 181  
Software Version, 198  
software version number, 166  
Solid State Relay Output, 26  
SP Ramp Set Up Group, 40  
SP Tuning, 44  
Specifications, 8



**SPPROG**, 42  
**SPRATE**, 41  
**Start segment number**, 124  
 Start Up Procedure for Operation, 104  
**STATION ADDRESS**, 77  
 Status Data, 134  
 Status Tests, 167  
**Stray Rejection**, 8  
 Support and Contact Information, iv  
*Suppression Devices*, 19  
 Switch between two sets via keyboard, 117  
 Switching between setpoints, 107

## T

Telephone and Email Contacts, iv  
**TEMPERATURE UNITS**, 87  
 Test Failures, 167  
 Thermocouple Inputs Using a Thermocouple Source,  
 146  
 Thermocouple Inputs Using an Ice Bath, 145  
 Three Position Step, 49  
 Three Position Step Control algorithm, 118  
 Three Position Step Control Connections, 29  
 Three Position Step Control Output Failure, 173  
**TIME CURRENT DUPLEX**, 53  
 Time duplex, 53  
 Time proportional output, 52  
 Time Proportional Output failure, 174  
 TIME REMAINING, 108  
 Time simplex, 52  
 TIME-OUT, 108  
 Timer, 107  
 Timer, 50  
 Transmitter characterization, 57  
 Transmitter Power for 4-20 mA, 32  
 Troubleshooting Aids, 165  
 troubleshooting procedures, 171  
 Troubleshooting/Service, 164  
**TUNE**, 45, 109

Tune for Duplex (Heat/Cool), 110  
 Tuning, 36  
 Tuning indicators, 109  
 Tuning parameter sets, 63  
 Tuning Set Up Group, 36  
 Two Sets of Tuning Constants, 115  
**TX DELAY**, 78

## U

Universal Output Functionality and Restrictions, 21

## V

Voltage and Resistance Equivalents for 0% and 100%  
 Range Values, 142, 144

## W

**Weigh**, 10  
 Wiring, 18  
 Wiring Bundling, 19  
 Wiring Connections for 1 to 5 Volt Input – Input 2,  
 152  
 Wiring Connections for 4 to 20 mA Input – Input 2,  
 151  
 Wiring Connections for Calibrating Auxiliary Output,  
 161  
 Wiring Connections for Calibrating Current Output,  
 158  
**Wiring Connections for Radiamatic,  
 Milliampere, Millivolts, or Volts (Except 0 to  
 10 Volts)**, 147, 148  
 Wiring Connections for RTD (Resistance  
 Thermometer Device), 146  
 Wiring Diagrams, 20  
 Wiring the Controller, 22  
 worksheet, 123

## Sales and Service

For application assistance, current specifications, pricing, or name of the nearest Authorized Distributor, contact one of the offices below.

### ASIA PACIFIC

Honeywell Process Solutions,  
(TAC) [hfs-tac-support@honeywell.com](mailto:hfs-tac-support@honeywell.com)

#### Australia

Honeywell Limited  
Phone: +(61) 7-3846 1255  
FAX: +(61) 7-3840 6481  
Toll Free 1300-36-39-36  
Toll Free Fax:  
1300-36-04-70

#### China – PRC - Shanghai

Honeywell China Inc.  
Phone: (86-21) 5257-4568  
Fax: (86-21) 6237-2826

#### Singapore

Honeywell Pte Ltd.  
Phone: +(65) 6580 3278  
Fax: +(65) 6445-3033

#### South Korea

Honeywell Korea Co Ltd  
Phone: +(822) 799 6114  
Fax: +(822) 792 9015

### EMEA

Honeywell Process Solutions,  
Phone: + 80012026455 or  
+44 (0)1344 656000

Email: (Sales)

[FP-Sales-Apps@Honeywell.com](mailto:FP-Sales-Apps@Honeywell.com)

or

(TAC)

[hfs-tac-support@honeywell.com](mailto:hfs-tac-support@honeywell.com)

### AMERICA'S

Honeywell Process Solutions,  
Phone: (TAC) 1-800-423-9883 or  
215/641-3610  
(Sales) 1-800-343-0228

Email: (Sales)

[FP-Sales-Apps@Honeywell.com](mailto:FP-Sales-Apps@Honeywell.com)

or

(TAC)

[hfs-tac-support@honeywell.com](mailto:hfs-tac-support@honeywell.com)

### For more information

To learn more about SmartLine Transmitters,  
visit [www.honeywellprocess.com](http://www.honeywellprocess.com)  
Or contact your Honeywell Account Manager

### Process Solutions

Honeywell  
1250 W Sam Houston Pkwy S  
Houston, TX 77042

Honeywell Control Systems Ltd  
Honeywell House, Skimped Hill Lane  
Bracknell, England, RG12 1EB

Shanghai City Centre, 100 Jungi Road  
Shanghai, China 20061

[www.honeywellprocess.com](http://www.honeywellprocess.com)



34-ST-25-127 Rev.8  
April 2017

©2017 Honeywell International Inc.