

UNIFIED FACILITIES CRITERIA (UFC)

SECURITY ENGINEERING: PHYSICAL SECURITY MEASURES FOR HIGH-RISK PERSONNEL



APPROVED FOR PUBLIC RELEASE; DISTRIBUTION UNLIMITED

UNIFIED FACILITIES CRITERIA (UFC)

**SECURITY ENGINEERING: PHYSICAL SECURITY MEASURES FOR HIGH-RISK
PERSONNEL (HRP)**

Any copyrighted material included in this UFC is identified at its point of use. Use of the copyrighted material apart from this UFC must have the permission of the copyright holder.

U.S. ARMY CORPS OF ENGINEERS

NAVAL FACILITIES ENGINEERING COMMAND (Preparing Activity)

AIR FORCE CIVIL ENGINEER SUPPORT AGENCY

Record of Changes (changes are indicated by \1\ .../1/)

Change No.	Date	Location

FOREWORD

The Unified Facilities Criteria (UFC) system is prescribed by MIL-STD 3007 and provides planning, design, construction, sustainment, restoration, and modernization criteria, and applies to the Military Departments, the Defense Agencies, and the DoD Field Activities in accordance with [USD\(AT&L\) Memorandum](#) dated 29 May 2002. UFC will be used for all DoD projects and work for other customers where appropriate. All construction outside of the United States is also governed by Status of Forces Agreements (SOFA), Host Nation Funded Construction Agreements (HNFA), and in some instances, Bilateral Infrastructure Agreements (BIA.) Therefore, the acquisition team must ensure compliance with the more stringent of the UFC, the SOFA, the HNFA, and the BIA, as applicable.

UFC are living documents and will be periodically reviewed, updated, and made available to users as part of the Services' responsibility for providing technical criteria for military construction. Headquarters, U.S. Army Corps of Engineers (HQUSACE), Naval Facilities Engineering Command (NAVFAC), and Air Force Center for Engineering and the Environment (AFCEE) are responsible for administration of the UFC system. Defense agencies should contact the preparing service for document interpretation and improvements. Technical content of UFC is the responsibility of the cognizant DoD working group. Recommended changes with supporting rationale should be sent to the respective service proponent office by the following electronic form: [Criteria Change Request](#). The form is also accessible from the Internet sites listed below.

UFC are effective upon issuance and are distributed only in electronic media from the following source:

- Whole Building Design Guide web site <http://dod.wbdg.org/>.

Hard copies of UFC printed from electronic media should be checked against the current electronic version prior to use to ensure that they are current.

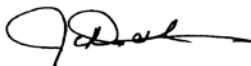

JAMES C. DALTON, P.E.
Chief, Engineering and Construction
U.S. Army Corps of Engineers



JOSEPH E. GOTT, P.E.
Chief Engineer
Naval Facilities Engineering Command



TERRY G. EDWARDS, P.E.
Director, Air Force Center for
Engineering and the Environment
Department of the Air Force

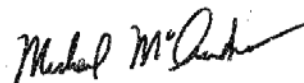

MICHAEL McANDREW
Director, Facility Investment and
Management
Office of the Deputy Under Secretary of
Defense (Installations and Environment)

UNIFIED FACILITIES CRITERIA (UFC) NEW DOCUMENT SUMMARY SHEET

Subject: UFC 4-010-03, Security Engineering: Physical Security Measures for High-risk Personnel (HRP).

Cancel: U. S. Navy Physical Security Measures for Executive Protection Manual (September 1990).

Description: This UFC document provides guidance on how to select or design office and residential facilities for High-risk Personnel. HRP are personnel who are likely to be terrorist or criminal targets based on their grade, assignment, symbolic value, criticality, or threat and vulnerability assessment. This document provides guidance to commanders, planners, project managers, architects and engineers, housing and real estate staff on how to select facilities for HRP or design and implement physical security measures for HRP on projects, including new construction, additions, and renovations. The document does not apply to HRP protection in combat zones nor in areas where contingency, temporary construction or expeditionary operations are underway. However, it does not limit HRP protection in these areas.

Reasons for Development: There was no existing UFC document that prescribed guidance on how to design or provide facility (office and residential) physical security measures for HRP.

- This document is one of a series of new security engineering UFC documents covering physical countermeasures for the current threat environment.
- The design of physical security measures is a specialized technical area that does not fall in the normal skill record and resume of commanders, architects, engineers, and project managers. This document provides guidance to those parties tasked with implementing existing and emerging physical protection system requirements.
- This document provides a unified approach for physical security measures for HRP.

Impact: The following direct benefits will result from the publication of UFC 4-010-03:

- Creation of a single-source reference for the design and construction of physical security measures for HRP.
- Promulgation of multi-service standard recommendations and considerations.
- Potential increase of productivity of HRP and reduced temporary housing costs through clarification of considerations, guidance on planning, and provision of design solutions.
- Reduction of facility project costs.
- Better performance of modernized facilities, in terms of force protection, than original facilities.

TABLE OF CONTENTS

CHAPTER 1 - INTRODUCTION	1
1-1 SCOPE	1
1-1.1 PURPOSE	1
1-1.2 HRP DEFINITION	1
1-1.3 GEOGRAPHIC COMBATANT COMMANDS	1
1-1.4 PLANNING AND INTEGRATION	1
1-2 INTENT	1
1-3 LEVELS OF PROTECTION	2
1-4 APPLICABILITY	2
1-5 PROGRAMMING	2
1-5.1 DOCUMENTATION	2
1-6 INFORMATION SENSITIVITY	2
1-7 ORGANIZATION OF THIS HRP UFC	2
1-7.1 CHAPTER 2, PHYSICAL SECURITY MEASURES	3
1-7.2 CHAPTERS 3 THROUGH 8	4
1-7.3 CHAPTER 9, ADMINISTRATION AND OPERATIONAL INTERFACES	5
1-7.4 APPENDIX A, REFERENCES	5
1-7.5 APPENDIX B, GLOSSARY	5
1-7.6 APPENDIX C, RESIDENTIAL SURVEY FORM	5
CHAPTER 2 - PHYSICAL SECURITY MEASURES	6
2-1 ORGANIZATION OF THE CHAPTER	6
2-1.1 BULLETED STATEMENT	6
2-1.2 TAG NUMBER	6
2-2 ALTERNATE AND EQUIVALENT MEANS OR METHODS	7
2-3 COMMON RECOMMENDATIONS	7
2-4 OFFICE RECOMMENDATIONS	9
2-5 RESIDENCE RECOMMENDATIONS	9
2-6 SUMMARY TABLE	12
CHAPTER 3 - EXTERNAL ZONE/SITE LOCATION	14
3-1 OVERVIEW	14
3-2 COMMON SITE LOCATION RECOMMENDATIONS	15
3-2.1 FINAL APPROACH ROUTES	15
3-2.2 HRP VEHICLE PARKING	16
3-2.3 RESPONSE FORCES	16
3-2.4 DOD COMPOUND	17
3-3 OFFICE SPECIFIC RECOMMENDATION	17
3-3.1 OFFICE SITE RECOMMENDATION	17
3-4 RESIDENCE SITE RECOMMENDATIONS	18

3-4.1	S-6R COMMENTARY.....	18
3-4.2	BUILDING APPEARANCE	18
3-4.3	COMMUTE ROUTE.....	19
3-4.4	EMERGENCY SERVICES.....	20
3-4.5	CRIME AREA	21
3-4.6	VEHICULAR APPROACHES.....	21
	CHAPTER 4 - PROPERTY PERIMETER	23
4-1	OVERVIEW	23
4-2	COMMON PROPERTY PERIMETER RECOMMENDATIONS	23
4-2.1	COMMON PROPERTY PERIMETER RECOMMENDATIONS	23
4-3	RESIDENCE PROPERTY PERIMETER RECOMMENDATIONS	24
4-3.1	RESIDENCE PROPERTY PERIMETER REQUIREMENTS.....	24
4-3.2	PERIMETER BOUNDARY	25
4-3.3	CLEAR ZONES	28
4-3.4	EGRESS ROUTE VIEWING	29
4-3.5	P-4R COMMENTARY.....	29
4-3.6	PERIMETER CCTV	29
4-3.7	PERIMETER IDS.....	30
	CHAPTER 5 - PROPERTY GROUNDS.....	31
5-1	OVERVIEW	31
5-2	RESIDENCE PROPERTY GROUNDS RECOMMENDATIONS.....	32
5-2.1	RESIDENCE PROPERTY GROUNDS RECOMMENDATIONS.....	32
	CHAPTER 6 - BUILDING EXTERIOR	37
6-1	OVERVIEW	37
6-2	COMMON BUILDING EXTERIOR RECOMMENDATIONS	37
6-2.1	NUMBER OF LEVELS	37
6-2.2	WINDOW LOCKS.....	39
6-2.3	NUMBER OF EXTERIOR DOORS.....	40
6-2.4	EXTERIOR DOOR MATERIAL	40
6-2.5	DOOR SWING.....	40
6-2.6	EXTERIOR DOOR HINGES	40
6-2.7	EXTERIOR DOOR JAMBS	41
6-3	RESIDENCE EXTERIOR RECOMMENDATIONS	42
6-3.1	EXTERIOR DOOR LOCKS	42
6-3.2	WINDOWS.....	42
6-3.3	UNDER-BUILDING ACCESS CONTROL	44
6-3.4	ROOF ACCESS.....	45
6-3.5	MAILBOX	46
6-3.6	TRASH RECEPTACLES.....	46
6-4	GOOD PRACTICES FOR HRP RESIDENCES.....	46

6-4.1	OVERHEAD DOORS	46
6-4.2	SLIDING GLASS DOORS.....	46
6-4.3	INTERIOR COURTYARDS	47
CHAPTER 7 - BUILDING INTERIOR		49
7-1	OVERVIEW	49
7-2	COMMON BUILDING-INTERIOR RECOMMENDATIONS	49
7-2.1	SKYLIGHTS	49
7-2.2	FURNITURE	49
7-3	OFFICE BUILDING-INTERIOR RECOMMENDATIONS.....	49
7-3.1	INTERNAL SECONDARY PERIMETER	49
7-3.2	PRIMARY ACCESS DOOR.....	50
7-3.3	OTHER ACCESS DOORS	51
7-3.4	HRP OFFICE DOOR FRAME CONSTRUCTION.....	51
7-3.5	OFFICE CONSTRUCTION MATERIALS	52
7-3.6	INTERIOR CCTV SYSTEM	52
7-4	RESIDENCE BUILDING-INTERIOR RECOMMENDATIONS	52
7-4.1	FIRE PROTECTION	53
7-4.2	IDS	53
7-5	RESIDENCE BUILDING-INTERIOR GOOD PRACTICES.....	55
7-5.1	HRP BEDROOMS	55
7-5.2	GUARD FORCE RESTROOM	55
CHAPTER 8 - SAFE ROOM/HAVEN.....		56
8-1	OVERVIEW	56
8-2	COMMON RECOMMENDATIONS.....	56
8-2.1	SAFE ROOM COMMENTARY	56
8-2.2	ADJACENT DOOR.....	60
8-2.3	SAFE HAVEN.....	61
8-3	ADDITIONAL SAFE ROOM/HAVEN CONSIDERATIONS	62
8-3.1	SECURE COMMUNICATIONS	62
8-3.2	NO EXTERIOR WALLS	62
CHAPTER 9 - ADMINISTRATIVE IMPACTS ON FACILITY REQUIREMENTS		63
9-1	OVERVIEW	63
9-2	LEASED SPACE CHALLENGES	63
9-3	CONGRESSIONAL LIMITS FOR RESIDENTIAL IMPROVEMENTS	63
9-4	HISTORIC PRESERVATION ISSUES	63
9-4.1	PROCESS IN THE UNITED STATES	64
9-4.2	ADVERSE EFFECTS	64
9-4.3	PROGRAMMATIC APPROACH	64
9-5	RESPONSE FORCE INTERFACE	65
APPENDIX A - REFERENCES.....		66

APPENDIX B - GLOSSARY 68
APPENDIX C - RESIDENCE SURVEY..... 71

TABLES

TABLE 2-1. RECOMMENDATIONS SUMMARY TABLE FOR HRP OFFICES AND RESIDENCES 13
TABLE 4-1. GATE STATION CONSIDERATIONS 28
TABLE 7-1. IDS FOR HRP RESIDENCES 54
TABLE 8-1. SAFE ROOM ENTRY DOOR ATTRIBUTES 58

FIGURES

FIGURE 1-1. LAYERED DEFENSE ZONES – SECTION VIEW 3
FIGURE 1-2. LAYERED DEFENSE ZONES – PLAN VIEW 4
FIGURE 1-3. SIX-SIDED PROBLEM 4
FIGURE 2-1. TAG NUMBER LEGEND 7
FIGURE 3-1. EXTERNAL ZONE ISSUES 14
FIGURE 3-2. FINAL APPROACH ROUTES 15
FIGURE 3-3. S-1 CASE STUDY 20
FIGURE 3-4. UNOBSTRUCTED APPROACHES 22
FIGURE 4-1. PROTECTION OF SUBTERRANEAN OPENINGS 24
FIGURE 4-2. GATE ACCESS CONTROL STATIONS 27
FIGURE 4-3. SAMPLE GATE OPERATOR PRODUCT 27
FIGURE 5-1. ELEMENTS OF PROPERTY GROUNDS 31
FIGURE 5-2. VANTAGE POINT COUNTERMEASURES 33
FIGURE 6-1. NUMBER OF LEVELS 38
FIGURE 6-2. WINDOW WITH MULTIPLE LOCKING POINTS 39
FIGURE 6-3. DOOR HARDWARE COUNTERMEASURES 41
FIGURE 6-4. WINDOW FILM ANCHORING SYSTEM 43
FIGURE 6-5. BLAST CURTAINS 44
FIGURE 6-6. COAL CHUTE ENTRY POINT 45
FIGURE 6-7. SAMPLE PATIO DOOR BAR 46
FIGURE 6-8. SECONDARY SLIDING DOOR LOCK 47
FIGURE 6-9. INTERIOR COURTYARD 48
FIGURE 7-1. INTERNAL CONTROLLED ACCESS AREA 50
FIGURE 7-2. TOP VIEW DOOR FRAME SYSTEM 52
FIGURE 8-1. H-1 CASE STUDY FIGURE 57
FIGURE 8-2. SIMPLE SLIDING LOCK 58
FIGURE 8-3. ROBUST INTERNAL LOCKING DOOR 59
FIGURE 8-4. SECURITY DOOR PINS 59

FIGURE 8-5. HARDENING AN ADDITIONAL DOOR 61
FIGURE 8-6. EXTERIOR WINDOWS/WALLS ON A SAFE ROOM 62

CHAPTER 1 - INTRODUCTION

1-1 SCOPE

1-1.1 PURPOSE

This UFC provides technical information and guidance on physical security measures for HRP. The document focuses on two building types: (a) the HRP office and (b) the HRP residence. Determining the level of protection and associated protection measures for a HRP is the responsibility of the Protection-Providing Organization (PPO). The PPO refers to the U.S. Army Criminal Investigative Command, the Naval Criminal Investigative Service, the U.S. Air Force Office of Special Investigations, the Defense Criminal Investigative Service, the Pentagon Force Protection Agency, and the National Security Agency. As required by Department of Defense Instructions 2000-16 *DoD Antiterrorism (AT) Standards* and O-2000.22 *Designation and Physical Protection of DoD High-risk Personnel (HRP)*, the PPO will conduct a Personal Security Vulnerability Assessment (PSVA) for each HRP. The resulting PSVA will provide recommendations for the protection of the HRP.

1-1.2 HRP DEFINITION

HRP are DoD personnel who are likely to be terrorist or criminal targets based on their grade, assignment, symbolic value, criticality, and threat and vulnerability assessment. DoD Instruction Number O-2000.22 defines High Risk Billets (HRB), HRP levels; assigns responsibilities and establishes policy, processes, and procedures for the designation and protection of DoD HRP.

1-1.3 GEOGRAPHIC COMBATANT COMMANDS

Geographic Combatant Commands (GCC) may establish additional guidance to ensure uniform and consistent application of these criteria within their areas of operations.

1-1.4 PLANNING AND INTEGRATION

Integration of protective measures must be done during the planning process. The planning team must consider all aspects of the project to ensure a balance between security and other requirements. To accomplish this, the planning team should consist of key personnel including PPO, antiterrorism, intelligence, security, and facility engineering personnel. This team is responsible for identifying requirements for the project, facilitating the development of supporting operational procedures, obtaining adequate resources, and properly supporting all other efforts needed to prudently enhance protection of the HRP. For further information on planning and integration, refer to UFC 4-020-01, *DoD Security Engineering Facilities Planning Manual*.

1-2 INTENT

This criteria is to be used in conjunction with a PSVA when available. When a PSVA is not available, this document may also be used as selection criteria for a HRP residence

or office. The recommendations contained in this criteria is intended to minimize the possibility of HRP casualties in buildings or portions buildings in which they work and live. These recommendations provide appropriate and implementable measures to establish a level of protection against terrorist attacks where no known threat of terrorist activity currently exists. While complete protection against all potential threats is cost prohibitive, the intent of these recommendations can be achieved through prudent master planning, real estate acquisition, and design and construction practices.

1-3 LEVELS OF PROTECTION

The level of protection for an HRP is established by the PPO. The recommendations provided by these criteria meet the intent described above and establish a foundation for the rapid application of additional protective measures in a higher threat environment. These criteria may be supplemented where specific terrorist threats are identified, where more stringent local criteria apply, where PSVA recommend, or where local commanders dictate additional measures.

1-4 APPLICABILITY

This document provides planning and design guidance for DoD components and participating organizations. This criteria applies to construction, renovation, and leases associated with the primary residence or office of an HRP. These criteria are not intended for HRP protection in combat zones and in areas where contingency or expeditionary operations are underway and does not limit HRP protection in those areas.

1-5 PROGRAMMING

1-5.1 DOCUMENTATION

Protective measures recommended by the PVSA into DoD construction or leases must be incorporated into the appropriate programming documents such as the DD Form 1391 or lease agreements. Refer to UFC 4-020-01 for guidance on the costs for implementing these criteria and for providing protective measures or levels of protection beyond these criteria.

1-6 INFORMATION SENSITIVITY

All aspects of HRP protection are guided by an analytical risk management process. The designation of an HRP and the associated PSVA may be classified as Confidential, For Official Use Only, or higher. Consult with the PPO on classification of designation of an HRP and the associated PSVA.

1-7 ORGANIZATION OF THIS HRP UFC

Following this introductory chapter, the remaining chapters present information as summarized below.

1-7.1 CHAPTER 2, PHYSICAL SECURITY MEASURES

This chapter succinctly summarizes the recommendations for HRP offices and residences. The chapter is principally laid out in bullet format, serving as a concise reference. Detailed backup and commentary on the basis of the requirement or mitigating options are covered in the subsequent chapters. Chapter 2 is organized by six different layers of physical security measures.

Figures 1-1 and 1-2 depict the layered defense zones and associated chapters of this HRP UFC. Starting from the zone farthest away from the location of the HRP, the six zones considered are: External Zone/Site Location, Property Perimeter, Property Grounds, Building Exterior, Building Interior, and Safe Room/Haven.

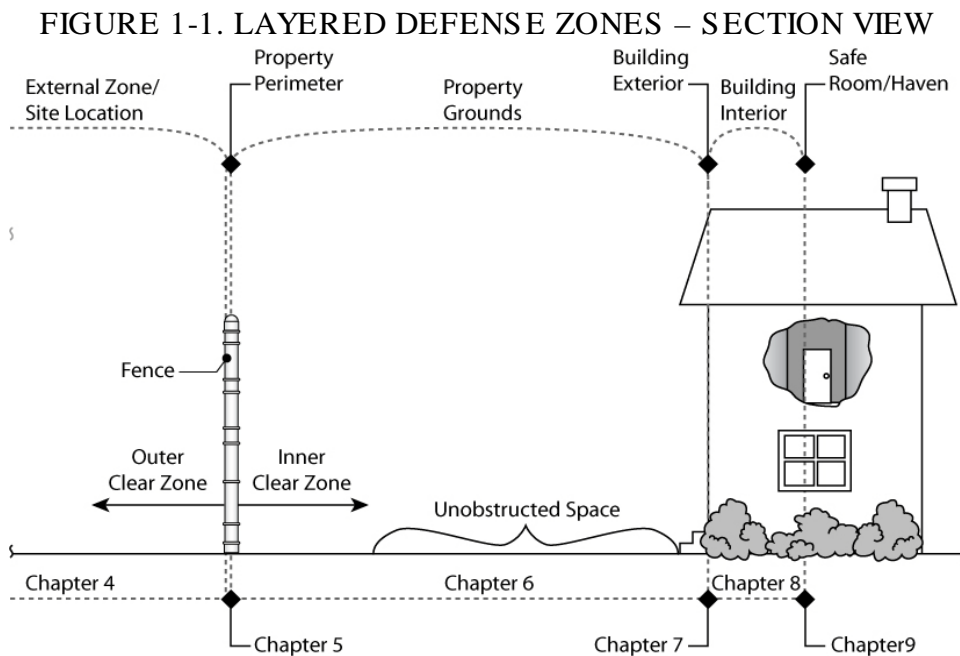
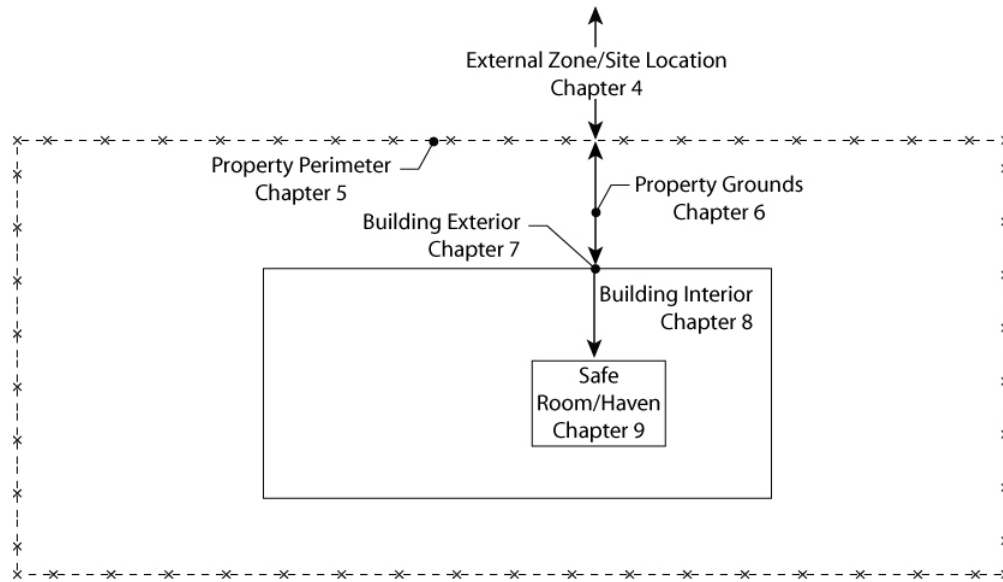

FIGURE 1-2. LAYERED DEFENSE ZONES – PLAN VIEW



1-7.2 CHAPTERS 3 THROUGH 8

Chapters 3 through 8 present specific information and criteria relative to each zone. Both office and residential space requirements are considered. Each chapter begins with general guidelines followed by specific information relative to the two different building types considered: offices and residences.

In general, each zone has to treat intruder penetration as a six-sided problem. While the exterior ground-level boundaries are more easily comprehended, consideration has to be given to penetration from below (culverts and basements) and above (rooftops and nearby trees) as well. Figure 1-3 illustrates the concepts of the six-sided problem.

FIGURE 1-3. SIX-SIDED PROBLEM

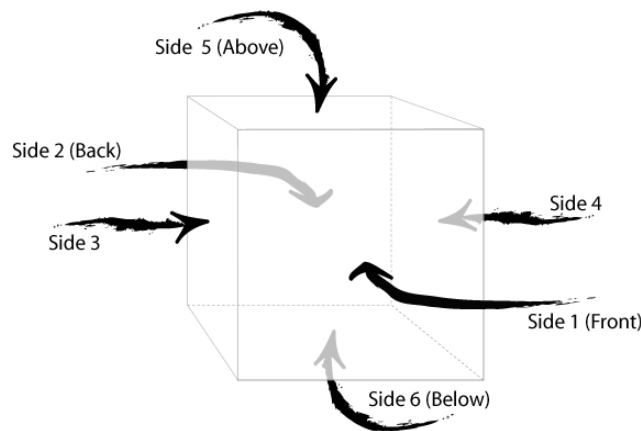

1-7.3 CHAPTER 9, ADMINISTRATION AND OPERATIONAL INTERFACES

While the focus and scope of this HRP UFC is on physical facility attributes of HRP administrative and residential space, any security solution includes administrative and operational aspects. Chapter 9 covers special consideration issues of interfacing with the GCC, leased space challenges, congressional limits for residential improvements, host nation agreements, historic preservation, and response force interface.

1-7.4 APPENDIX A, REFERENCES

Appendix A contains a list of references used in this UFC. In order to make this a “living document,” the date of the code or standard is not listed, with the understanding that the best practice is to use the most currently available edition.

1-7.5 APPENDIX B, GLOSSARY

Acronyms, abbreviations, and terms are defined in Appendix B.

1-7.6 APPENDIX C, RESIDENTIAL SURVEY FORM

Appendix C is a model residential survey form. The sample survey form is subdivided into the different protection zones and is intended to assist with the evaluation of houses for HRP residences.

CHAPTER 2 - PHYSICAL SECURITY MEASURES

2-1 ORGANIZATION OF THE CHAPTER

This chapter provides a summary of the protection measures and selection criteria for HRP primary residences and office spaces. Coordinate recommendations with the supported commander, responsible PPO, and applicable PSVA. The chapter was formatted as a “detachable” executive summary of the recommendations presented in the document. To understand the full intent of the recommendation(s), the reader should refer to the applicable technical content chapter(s).

2-1.1 BULLETED STATEMENT

For each recommendation, a brief statement of a particular physical security measure is stated in bullet format as shown below.

- H-1C: Safe Room/Haven. A Safe Room or Safe Haven should be provided for the HRP at both the office and the residence. (Safe Haven)

The bulleted item is a succinct statement of the recommendation. A short title of the referenced chapter follows the bullet statement. For example, to find out more information as to what constitutes a Safe Room or Safe Haven or how to achieve this, the reader should go to Chapter 8, Safe Room/Haven.

2-1.2 TAG NUMBER

The tag number at the beginning of each physical security measure (recommendation) is unique to this HRP UFC and is intended to be a communication aid when linking the requirement (recommendation) to the supporting text or commentary. The three-character tag number uses the following legend.

2-1.2.1 Tag Number First Character

The first character is an abbreviation for the defense zone layer that is most applicable for the countermeasure. “S” is used to represent site or external zone issues. “P” is used to represent the perimeter zone. “G” is used to represent issues relative to the property grounds. “E” is used to represent issues associated with the building exterior of the HRP office or residence. “I” is used to represent issues associated with the building interior. “H” is used to represent issues associated with the safe room or safe haven.

2-1.2.2 Tag Number Second Character

The second character is a sequential number for countermeasures in a given zone—be it a requirement or a recommendation. This number ensures a unique tag number.

2-1.2.3 Tag Number Third Character

The third character indicates whether the countermeasure is applicable to offices, residences, or both (common). "O" indicates a requirement or recommendation unique to offices. "R" represents a requirement or recommendation to residences. "C" represents a common requirement or recommendation applicable to offices and residences.

FIGURE 2-1. TAG NUMBER LEGEND

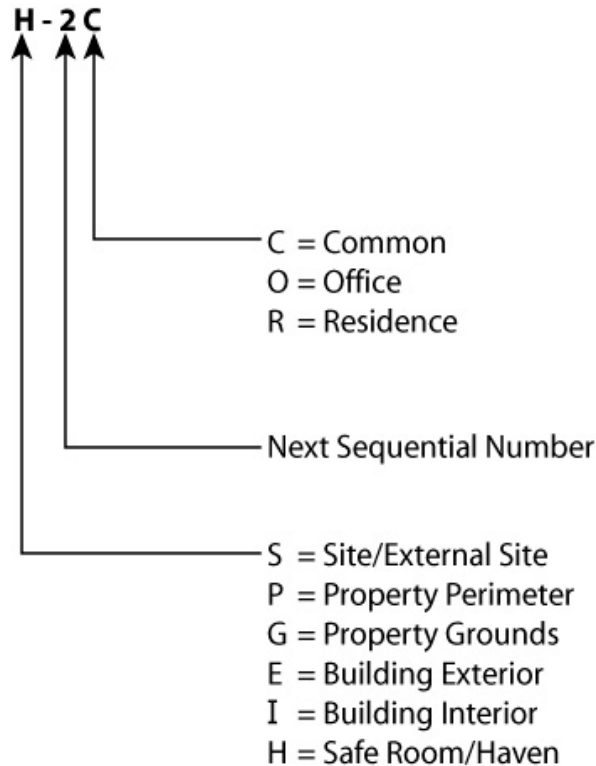

2-2 ALTERNATE AND EQUIVALENT MEANS OR METHODS

While a listed physical security measure may be very specific, the intent is to achieve a certain level of protection for the HRP. If a requirement can be met by alternate and equivalent means or methods, then that variance should be accepted when proven to provide the equivalent level of protection.

2-3 COMMON RECOMMENDATIONS

The recommendations in this section apply to both HRP offices and residences.

- S-1C: Final Approach Routes. The property location should have a minimum of two entrance and egress routes. (Site)
- S-2C: HRP Vehicle Parking. HRP vehicles (hard cars) should be located in a secure location when not in use by the HRP. (Site)

- S-3C: Response Forces. The HRP office and residence is recommended to be located within 15 minutes response time of dispatch response forces.
- S-4C: DoD Compound. The HRP primary office and residence should be located on a DoD, DoS, NATO compound, or host nation military installation.
- P-1C: Subterranean Openings. Man-passable subterranean openings, such as utility openings, should be hardened. (Perimeter)
- E-1C: Number of Levels. HRP offices and the residential master bedroom should be located in buildings which are three stories or less in height. The office or master bedroom should be located on a floor above ground level. When located in structures more than three floors, HRP offices and the residential master bedroom should not be above the third floor, and prevention of intrusion from upper floors must be addressed. (Building Exterior)
- E-2C: Window Locks. Windows should be lockable from the inside. (Building Exterior)
- E-3C: Minimize Number of Exterior Doors. To minimize possible intrusion points, select a building with a manageable number of exterior doors. (Building Exterior)
- E-4C: Exterior Door Material. To assist with forced entry protection, the unglazed portions of exterior doors to HRP offices and residences should be made of solid material such as metal or wood. (Building Exterior)
- E-5C: Door Swing. Exterior doors on HRP offices and residences should open outward. (Building Exterior)
- E-6C: Exterior Door Hinges. Exterior door hinges should be heavy-duty. Countermeasures should be implemented to minimize opportunities for the door to be breached by tampering with the door hinges. (Building Exterior)
- E-7C: Exterior Door Jambs. If the door jamb material into which the exterior door bolt fits is not of solid material (at least 1 inch {26 mm} thick and supported), the door jamb surface should be hardened to resist forced entry attack.
- I-1C: Skylights. Due to increased risks of building intrusion, select an office or residence without skylights. (Building Interior)
- I-2C: Furniture Layout. Locate furniture such that personnel are seated away from windows or likely path of glass fragments or other projectiles to the maximum extent possible. (Building Interior)
- H-1C: Safe Room/Haven. A Safe Room or Safe Haven should be provided for the HRP at both the office and the residence. (Safe Haven)

- H-2C: Layers of Protection. To provide defense in depth, it is recommended that an additional adjacent door be hardened. (Safe Haven)
- H-3C: Safe Haven. For a high level of protection, a Safe Haven with hardened boundaries is recommended. (Safe Haven)

2-4 OFFICE RECOMMENDATIONS

In addition to the common recommendations for HRP buildings, the following additional physical protection measures are recommended for HRP offices:

- S-5O: Minimum Standards. Regardless of the building's occupancy load (number of people), the building in which the HRP office is located should meet the minimum antiterrorism standard requirement of a primary gathering building (low level of protection) as prescribed by UFC 4-010-01. (Site)
- I-3O: Internal Controlled Access Area. Locate HRP Office in a command suite with controlled access. (Building Interior)
- I-4O: Primary Access Door. The HRP office and command suite door should be of solid construction and should swing outward for forced entry mitigation. (Building Interior)
- I-5O: Other Access Doors. HRP office doors other than the primary access door should be secured with deadlocking panic hardware on the inside and have no exterior hardware. (Building Interior)
- I-6O: HRP Office Door Frame Construction. The office and command suite door frame system (door frame, hardware, and locks) should be of sufficient strength to preclude distortion that could cause improper alignment of door alarm sensors, improper door closure or degradation of security. (Building Interior)
- I-7O: Office Construction. The walls, floor, and ceiling of the HRP office and command suite should be made of permanent construction materials. Walls should be extended from true floor to true ceiling. (Building Interior)
- I-8O: CCTV. Consider use of closed-circuit television (CCTV) to allow security personnel to assess the perimeter of the command suite. (Building Interior)

Coordinate implementation with the supported commander, responsible PPO, and applicable PSVA.

2-5 RESIDENCE RECOMMENDATIONS

In addition to the common recommendations for both HRP buildings, additional physical protection measures are recommended for HRP residences. Many of the

recommendations are based on the assumption that the HRP residence is not located on a military installation.

- S-6R: Neighborhood. The residence should not be located in neighborhoods nearby iconic structures or organizations that might attract violent political activity or demonstrations. (Site)
- S-7R: Building Appearance. The architecture and lighting levels of the building should blend into the surrounding area. Aggressors should not be able to pick out the residence just from its appearance. (Site)
- S-8R: Commute Route. To minimize additional travel vulnerabilities, locate the off-installation residence at a site that does not greatly increase the HRP's commute time or exposure to threats along routes to and from the office location. (Site)
- S-9R: Emergency Services. Residences should be located at a site that has enjoyed good emergency service protection (such as police department, fire department, and health services). The response time from emergency services should be less than 15 minutes. (Site)
- S-10R: Crime Area. Pick a residence in an area with a low crime history. (Site)
- S-11R: Vehicular Approaches. Pick a residence on a site that does not have unobstructed vehicle approaches perpendicular to the HRP residence. (Site)
- P-2R: Perimeter Boundary. To delineate property boundaries, the residential property perimeter should be encircled with a physical barrier, such as a wooden fence, curb or vegetation to mark the property boundary and establish criminal trespass conditions. The residential driveway access is assumed to be open. The PSVA may recommend higher levels of protection resulting in the property perimeter encircled with a fence or wall of 6 feet (ft) [2 meter (m)] minimum height and gated driveway. (Perimeter)
- P-3R: Egress Route Viewing. A capability to view the egress routes in advance of exiting the residential property should be established. (Perimeter)
- P-4R: Vehicle Access Points. The number of vehicle access points to the HRP residence should be kept to the minimum necessary. (Perimeter)
- P-5R: Perimeter CCTV. Consider CCTV to allow security personnel to assess threats around the residence and the perimeter. (Perimeter)
- P-6R: Perimeter IDS. Consider adding IDS for the perimeter to provide the earliest possible detection and notification of an intrusion. (Perimeter)

- G-1R: Standoff Distance. The standoff distance of the protected residence should meet UFC 4-010-01 standards for a Very Low Level of Protection. (Grounds)
- G-2R: Vantage Points. The HRP pickup/drop-off area and residential high-visibility windows should be concealed or screened from external vantage points. (Grounds)
- G-3R: HRP POV Parking. HRP privately owned vehicle (POV) parking should be in a controlled area. (Grounds)
- G-4R: Security Lighting: Provide security lighting around the residential exterior. At a minimum, luminaries should be provided at all entrance and exit points. (Grounds)
- G-5R: Unobstructed Space. Obstructions within 33 ft (10 m) of the HRP residence should not allow for concealment of objects 6 in (15 cm) or greater in height. (Grounds)
- G-6R: Access Control Point. Since threat levels or security needs can increase, a residence with space for a guard booth or guard house that can monitor and control access to the property is preferred. (Grounds)
- G-7R: Visitor Parking. When there is no external controlled perimeter, visitor parking should be no closer to the HRP residence than 33 ft (10 m). (Grounds)
- E-8R: Exterior Door Locks. Exterior doors should have a minimum of two locking devices per door, such as a keyed lock in a doorknob and a dead bolt lock [minimum 1 in (26 mm) throw]. (Building Exterior)
- E-9R: Windows. Windows should comply with Standard 10 of UFC 4-010-01 for inhabited buildings. (Building Exterior)
- E-10R: Under-building Access Control. Access to crawl spaces, utility tunnels, and other means of under-building access should be controlled or hardened. (Building Exterior)
- E-11R: Roof Access. Roof access should be controlled in accordance with Standard 14 of UFC 4-010-01. (Building Exterior)
- E-12R: Residential Mailbox Guidelines. (Building Exterior)
 - If a mail-slot is part of the residence building exterior, such as a slot in the front door, the mail-slot shall be blanked to prevent foreign object entry.

- The residential mailbox should be located at a minimum of 33 ft (10 m) from the residence.
- E-13R: Trash Receptacles. Trash receptacles should be positioned a reasonable distance away from the residence. (Building Exterior)
- I-9R: Fire Protection System. Provide a fire protection system for the HRP residence as follows: (Building Interior)
 - Sprinklers: Sprinklers are required for all new construction per NFPA 101 and the International Residential Code (IRC) and are recommended for renovations.
 - Smoke Alarms: Provide smoke alarms that comply with UL 217 or UL 268, as applicable, and are installed in accordance with NFPA 72. The smoke alarms should be capable of being connected to the security panel. Smoke alarms that are connected to the security panel must send a signal to a constantly attended location.
- I-10R: Intrusion Detection System (IDS). Provide an IDS inside the HRP residence as follows:
 - Low Level of Protection (LLOP): (a) Monitor all exterior doors with point sensors. (b) Provide a duress alarm in the HRP bedroom, the Safe Room/Haven, and the HRP's office in the residence. Consider the use of both fixed (wired) and wireless to provide flexible coverage and use by occupants. (c) Connect the IDS to a Dispatch Center.
 - Medium Level of Protection (MLOP): Provide LLOP criteria and provide volumetric IDS inside the residence.
 - High Level of Protection (HLOP): Provide MLOP criteria and provide two means of communication between the IDS and Dispatch Center.

Coordinate implementation with the supported commander, responsible PPO, and applicable PSVA.

2-6 SUMMARY TABLE

To summarize the information presented above, Table 2-1 presents a listing of all the recommendations.

Table 2-1. Recommendations Summary Table for HRP Offices and Residences

		Common Recommendations		Office Recommendations		Residence Recommendations
Site		S-1C S-2C S-3C S-4C		S-5O		S-6R S-11R S-7R S-8R S-9R S-10R
Perimeter		P-1C				P-2R P-6R P-3R P-4R P-5R
Grounds						G-1R G-5R G-2R G-6R G-3R G-7R G-4R
Exterior		E-1C E-5C E-2C E-6C E-3C E-7C E-4C				E-8R E-12R E-9R E-13R E-10R E-11R
Interior		I-1C I-2C		I-3O I-7O I-4O I-8O I-5O I-6O		I-9R I-10R
Haven		H-1C H-2C H-3C				

CHAPTER 3 - EXTERNAL ZONE/SITE LOCATION

3-1 OVERVIEW

This chapter provides an elaboration of the Site (S) recommendations summarized in Chapter 2. It describes attributes and issues associated with the external zone located around the protected property perimeter as illustrated in Figure 3-1 below.

FIGURE 3-1. EXTERNAL ZONE ISSUES

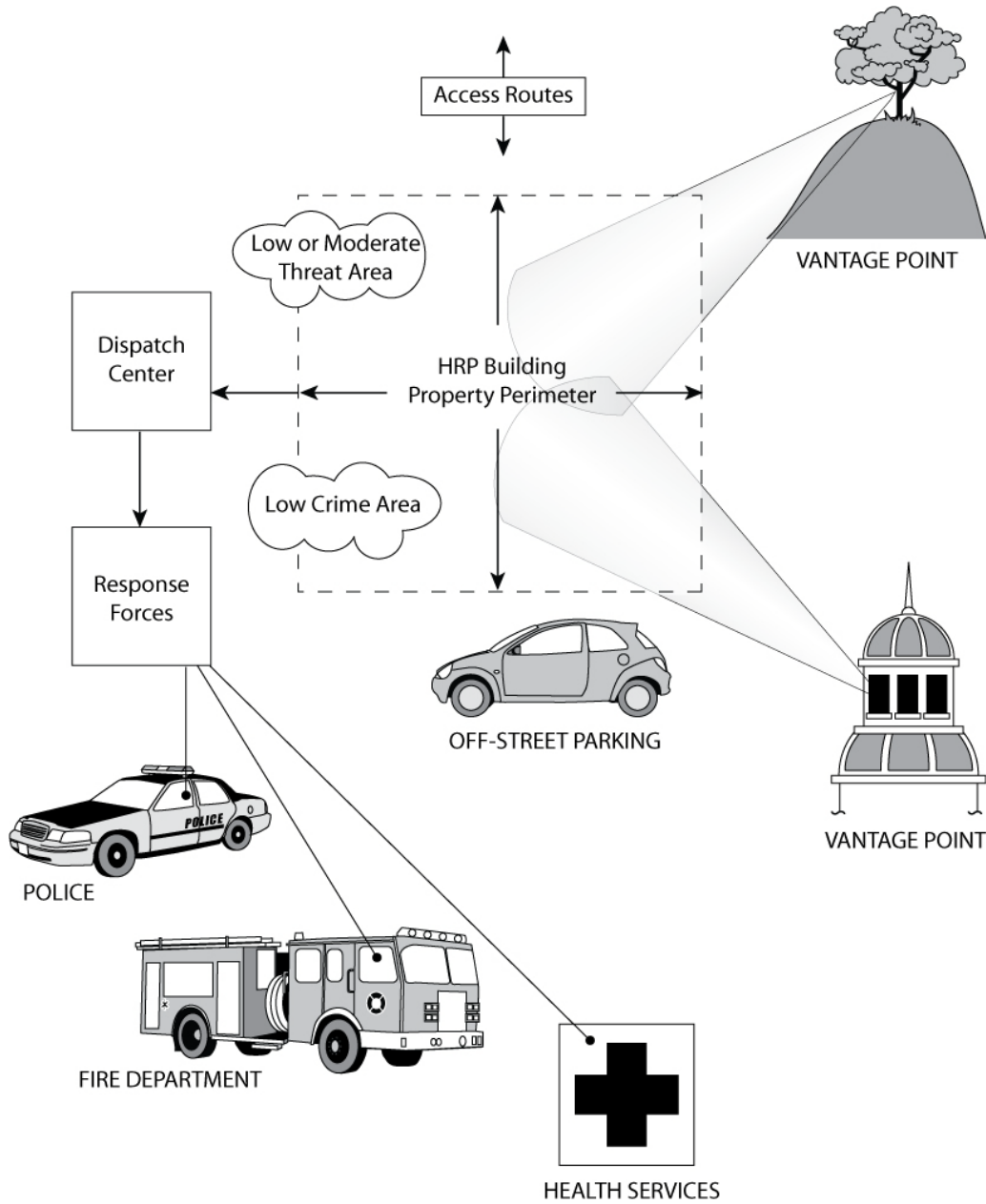

3-2 COMMON SITE LOCATION RECOMMENDATIONS

The following recommendations apply to both HRP offices and residences.

- S-1C: Final Approach Routes. The property location should have a minimum of two entrance and egress routes.

3-2.1 FINAL APPROACH ROUTES

“Statistics of kidnappings and assassinations have shown that the vast majority occur close to the residence when the victim is leaving or returning home” (DoS: *Security Guidelines for American Families Living Abroad*). This statement is directly applicable to DoD HRP as well. It is customary for the HRP to use a variety of commute routes. This section focuses on the final approach routes of the traveling HRP on public roadways just prior to getting to the office or residence. To avoid predictable travel paths, alternative approaches to the HRP office and residence should be provided.

3-2.1.1 S-1C Commentary

Narrow or one-way streets should be avoided. If the HRP office is located on a DoD installation, it is assumed that there are multiple entrance and egress routes, and there may even be multiple entry control points or gates to the installation. For the HRP residence, it is normal that there will be one driveway (one way in and out) on the property grounds. Up to the driveway entrance, there should be at least two routes (presumably right or left) as shown in Figure 3-2. A poor choice for an HRP residence site would be a hilltop location with a long, tortuous, single-lane entrance road past multiple residences leading up to the HRP residence.

FIGURE 3-2. FINAL APPROACH ROUTES
Approach/Egress Routes

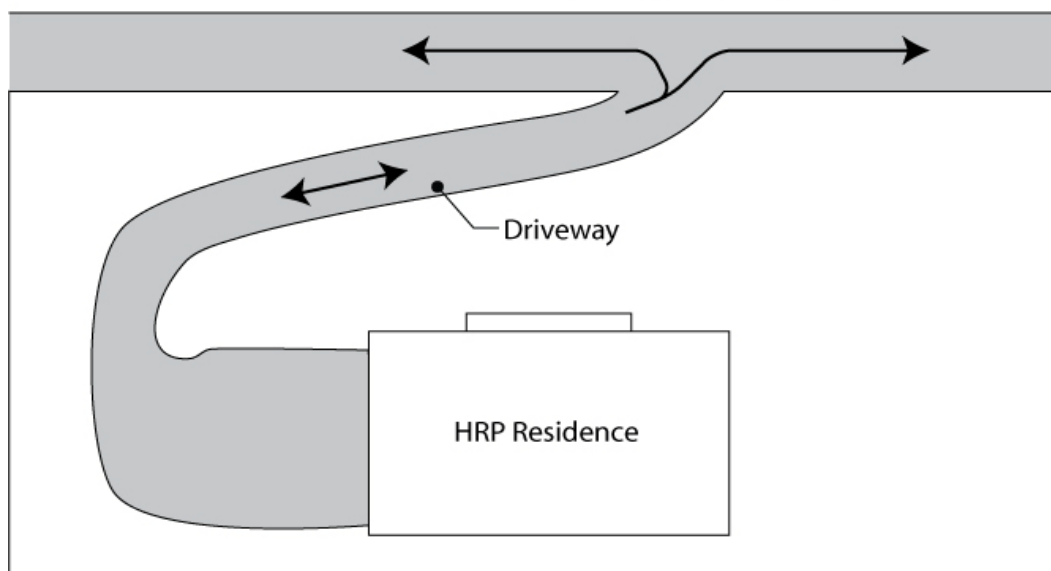

- S-2C: HRP Vehicle Parking. HRP vehicles (hard cars) should be located in a secure location when not in use by the HRP.

3-2.2 HRP VEHICLE PARKING

The HRP vehicle is the official use only vehicle used to transport the HRP. Access to the HRP vehicle should be controlled to limit potential threats.

3-2.2.1 S-2C Commentary

In considering HRP office and residence sites, facility space should be locating for parking the HRP vehicle in a secure location. Typically, there is more than one HRP car. The Protective Security Detail (PSD) may choose to use different cars for additional security, and there are normally needs for an advance car and/or trail car. As a result, the space planning and garage location must provide the adequate number of bays. Rarely is there space at either the HRP office or residence. In some cases, the HRP vehicles are parked offsite at a confidential, secure location. A good practice is to make use of a multi-bay garage building that is equipped with an IDS. An alternative is to guard the space (patrolled guard), but the labor expense is hard to justify. In a third scheme, the HRP vehicles can be parked in a location that is within the sight lines of an existing guard post. Regardless of the location, covered parking should be provided for vehicles with bullet resistant glazing to protect the car from potentially harmful effects of direct exposure to sunlight.

- S-3C: Response Forces. The HRP office or residence is recommended to be to be located within 15 minutes response time of dispatch response forces.

3-2.3 RESPONSE FORCES

Response forces are defined as those supplemental security human resources reacting to an incident or threat to the HRP. These resources are in addition to any assigned PSD. The response forces may be DoD, host nation armed services/governmental agency, or local law enforcement. The identification, makeup, and communication link to the response force as well as the protocol for response should be established and formalized. The Dispatch Center is the location that receives the emergency communication of an incident or threat. The reaction time of response forces to the HRP residence and office from the Dispatch Center for response forces is recommended to be less than 15 minutes.

3-2.3.1 S-3C Commentary

Sites closer to response forces are more desirable. The evaluation should include capabilities, location, responsiveness, and reputation of the local police authorities. Fifteen minutes is a long time for trained assailants to penetrate multiple layers of property barriers; the time to get through fences and doors can be on the order of seconds. It is important that backup security response forces are identified for a given HRP office or residence. It is assumed that 15 minutes is a reasonable recommendation

for on-installation response. If the HRP residence is outside of the United States, the legal implications of who has law enforcement jurisdiction also need to be understood. The number, skill, and armament of the response forces falls under the purview of the PSD. Once identified, the communication means to contact the response force and time to get to the site can be determined. In the event the 15-minute response recommendation cannot be met, additional security engineering and hardening of the HRP office or residence can be made to provide adequate protection, in event of an intrusion breach, until help can arrive.

- S-4C: DoD Compound. The HRP primary office and residence should be located on a DoD, DoS, NATO compound, or host nation military installation.

3-2.4 DOD COMPOUND

DoD installations, or their DoS, NATO, host-nation equivalents, have intrinsic security features of controlled access at the perimeter, nearby security forces, standards on building standoff distances, and perimeter maintenance programs. As a result, it is recommended that HRP offices and residences be located on a DoD, DoS, NATO compound, or host nation military installation. A review of several existing commands revealed that most HRP offices are located at on-base installations, but many HRP residences are not. Due to the enhanced security of on-base residences, base master planners ought to consider on-site location and space planning for HRP residences, as well as HRP offices.

3-3 OFFICE SPECIFIC RECOMMENDATION

3-3.1 OFFICE SITE RECOMMENDATION

The following site recommendation is made specifically for the HRP office, but not HRP residences.

- S-5O: Minimum Standards. Regardless of the building's occupancy load (number of people), the building in which the HRP office is located should meet the minimum antiterrorism standard requirement of a primary gathering building (low level of protection) as prescribed by UFC 4-010-01.

3-3.1.1 UFC 4-010-01 Minimum Standards

UFC 4-010-01 prescribes mandatory DoD minimum antiterrorism standards for new and existing inhabited buildings. To take advantage of the preexisting work defined in UFC 4-010-0, this HRP UFC recommendations that HRP offices comply with the minimum standards of UFC 4-010-01.

3-3.1.2 S-5O Commentary

UFC 4-010-01 provides detailed guidance on minimum antiterrorism standards for DoD buildings. Appendix B contains standards for new and existing buildings. Since HRP

office buildings are recommended to be on DoD or similar bases, invoking the existing minimum antiterrorism requirements streamlines this HRP UFC by allowing it to focus on only those special physical protection measures that are uniquely tailored to the HRP. Certain circumstances, such as a higher threat level or the increased visibility and role of an HRP Level I billet, may warrant additional physical protection greater than that required for a low level of protection. When those circumstances occur, the HRP office building should be hardened to a higher level of protection as defined in this HRP UFC and UFC 4-010-01.

3-4 RESIDENCE SITE RECOMMENDATIONS

The following site recommendations apply only to HRP residences.

- S-6R. Neighborhood. The residence should not be located in neighborhoods nearby iconic structures or organizations that have historically attracted violent political activity or demonstrations.

3-4.1 S-6R COMMENTARY

Historically, the majority of HRP residences have been located off-installation. As a result, site/external zone issues of the neighborhood should be considered. Acts of civil unrest can be preceded by advanced organization or they can occur as spontaneous reactions to unexpected political events that precipitate protest. In every culture, such political demonstrations often gravitate around familiar landmarks or structures that symbolize and catalyze discontent. Examples of iconic structures and buildings are national embassies, plazas, and monuments. S-6R addresses the proximity of iconic landmarks, structures, or organizations in the community surrounding a potential HRP residence that could serve as attractants of protest acts. Locating HRP residences away from such locations is an obvious preventive strategy to help reduce the likelihood of exposing these residences to the risks associated with involvement in civil unrest. The locations and topography of potential HRP residence sites should also be evaluated for their potential to accommodate large gatherings, such as large open spaces or spacious roadways on a site's perimeter, which could encourage large assemblies. HRP residential sites should optimally be physically discrete, unobtrusive, inhospitable to the assembly of groups, and located well away from locations known to attract groups. This issue is not restricted to locations outside of the United States. There are areas or neighborhoods in the United States, such as the National Mall area in Washington, DC, which would not be suitable for an HRP residence.

- S-7R: Building Appearance. The architecture and lighting levels of the building should blend into the surrounding area. Aggressors should not be able to pick out the residence just from its appearance.

3-4.2 BUILDING APPEARANCE

One tactic for HRP protection is to have the HRP "blend in" with the community. This makes it more difficult to target the HRP. With regard to the appearance of the building,

the residence should blend with the existing architectural environment in terms of the number of floors, color, and appearance of the building. The architecture of the building can remain unique if the residence is not visible from public roads or vantage points. Screening by hedges or perimeter fence can help make the HRP residence less conspicuous. Over-illuminated properties stand out at night, which challenges the HRP residence lighting consultant to provide appropriate illumination without calling attention to the property.

- S-8R: Commute Route. To minimize additional travel vulnerabilities, locate the off-installation residence at a site that does not greatly increase the HRP's commute time or exposure to threats along routes to and from the office location.

3-4.3 COMMUTE ROUTE

The HRP's risk exposure is continuous and is not limited to time spent in the HRP office or in the HRP residence. Although it has been previously recommended that the HRP residence be located on a DoD or similar installation, there will be cases where other factors will result in the residence being located off-installation. For off-installation HRP residences, issues of the commute route have to be considered. Time efficiency and productivity concerns will motivate the HRP to select residence locations with a short commute time. However, housing availability may be further away from the HRP office and thereby increase the HRP's vulnerability. If the commute is excessively long or passes through unsafe areas, the risk from the commute route may exceed the risk of a specific HRP residence. Examples of hazards that can be encountered along the commute route are single-lane choke points, such as bridges over a river or chasm area, or routes that pass through neighborhoods with a high crime history or propensity for violence. A good practice is to select a residence that offers a variety of low-risk commuting routes.

3-4.3.1 S-1 Commute-Route Case Study

The lease on the current HRP residence is expiring and will not be renewed. Therefore a new HRP residence has to be procured. The selection team has identified three residences that meet the HRP's housing requirements. Residence #1 is in a nearby upscale neighborhood, but is located adjacent to a foreign embassy, which may attract protestors. Residence #2 has a 40-minute commute route, but requires modifications to upgrade the home with a safe room. Residence #3 is located in a trendy rural area with panoramic scenic views. This residence has many security features and exceeds the minimum requirements for an HRP residence, but the commute route passes over a single choke-point bridge. Alternate commute paths for Residence #3 exceed two hours commute time one-way. In this case, there is no easy choice. Residence #1 has liability in that it is located near an iconic structure that might give rise to violent political demonstrations or opportunities for surveillance by a hostile foreign nation. Residence #2 requires capital investment to upgrade the residence to minimum standards recommended by this UFC. Residence #3 is preferred as a residence, but the excessive commute time and exposure over a choke point cannot be mitigated. Based on the

limited information given, Residence #2 should be upgraded to meet minimum standards, or an alternate site location for the HRP residence should be considered. This case study also reinforces recommendation S-8RR, that the HRP residence be located on a DoD or similar installation. On the next page, Figure 3-3 illustrates this case study.

FIGURE 3-3. S-1 CASE STUDY

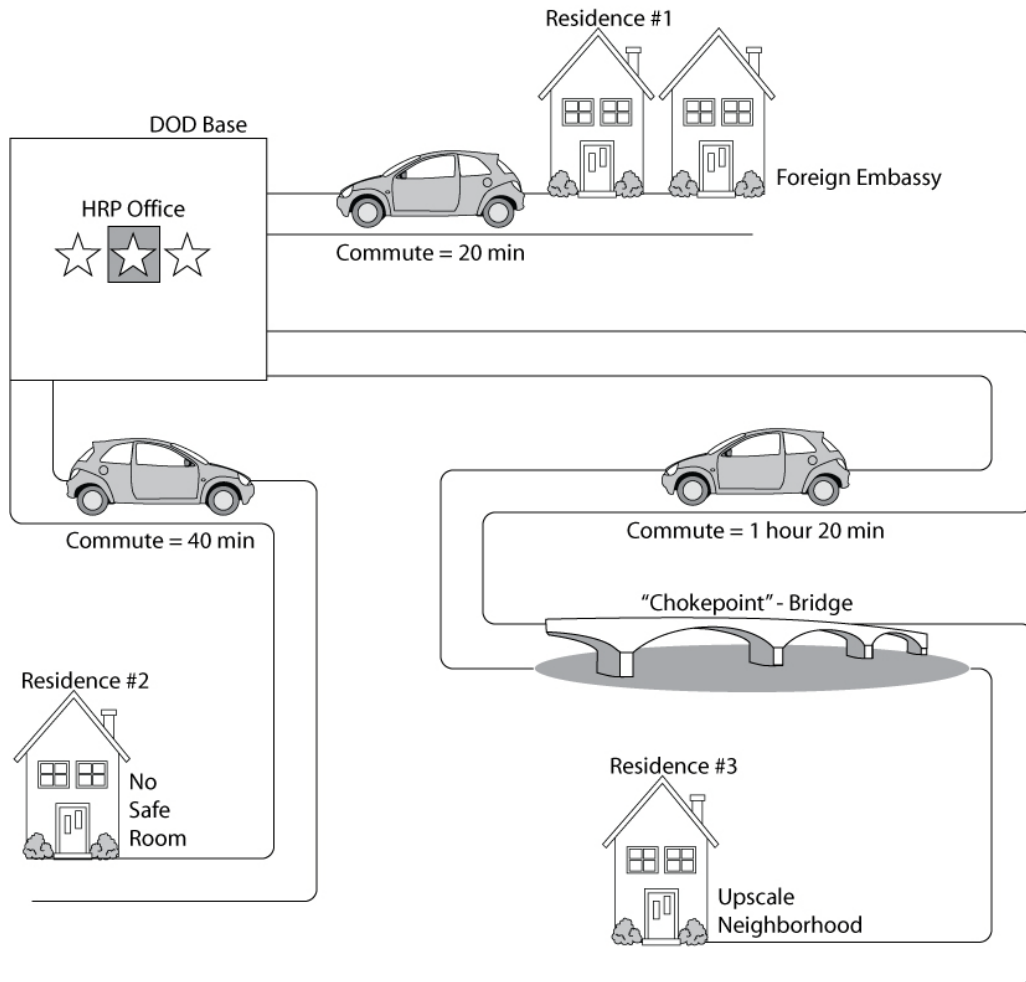

3-4.4 EMERGENCY SERVICES

In the United States, emergency services are considered police department, fire department, and health services.

- S-9R: Emergency Services. Residences should be located at a site that has enjoyed good emergency service protection (such as police department, fire department, and health services). The response time from emergency services should be less than 15 minutes.

3-4.4.1 S-9R Commentary

Consideration should be given to the closest responding police forces. The evaluation should include capabilities, location, responsiveness, and reputation of the local police authorities. A good reputation is encouraging, but a sufficiently strong capability is important. What is the connection method for communications with the local police department? Make sure it is reliable, secure, and has redundant features and backup. Identify and evaluate the closest fire department. In Chapter 7, I-9R recommends a fire alarm system for the HRP residence. The system may be a stand-alone system, interfaced with the local fire department, or monitored by an off-site central monitoring station. Regardless of the system architecture, the means for communicating with the local fire department needs to be determined. Most fire departments have equipment that enables them to reach the third floor above ground. This capability should be verified with the local fire department. Take into account the language capability of the HRP and the family in selecting a residential location. This is important for communication with emergency services (fire, health, and police).

- S-10R: Crime Area. Pick a residence in an area with a low-crime history.

3-4.5 CRIME AREA

While there may be no established link between a terrorist threat and a local crime area, it is recommended that the HRP residence be located in a low-crime area. High-crime area neighborhoods may have some attributes that make these neighborhoods good places for terrorist activities. Issues of high population density, a large transient population, and a lowered inclination to report a suspicious event can make a high-crime area a more favorable launching point for a terrorist attack.

- S-11R: Vehicular Approaches. Pick a residence on a site that does not have unobstructed vehicle approaches perpendicular to the HRP residence.

3-4.6 VEHICULAR APPROACHES

Unobstructed approaches allow assailant vehicles to gain velocity and momentum. To limit high-speed assailant vehicles, it is best if the path to the HRP residence has a few turns or obstacles in it. Figure 3-4 illustrates two conceptual residential neighborhoods. The residence on the left is a poor choice due to the one-way dead-end public access road and the straight-on approach to the HRP residence. The residence on the right has more choices for travel routes and a serpentine approach to the residence. The serpentine approach is only good if landscaping (grade or vegetation) prohibits unimpeded travel over the open ground. The approach to the facility should not interfere with emergency vehicle access (refer to UFC 3-600-01, *Fire Protection Engineering for Facilities*). For additional guidance, refer to UFC 4-022-02, *Selection and Application of Vehicle Barriers*.

FIGURE 3-4. UNOBSTRUCTED APPROACHES

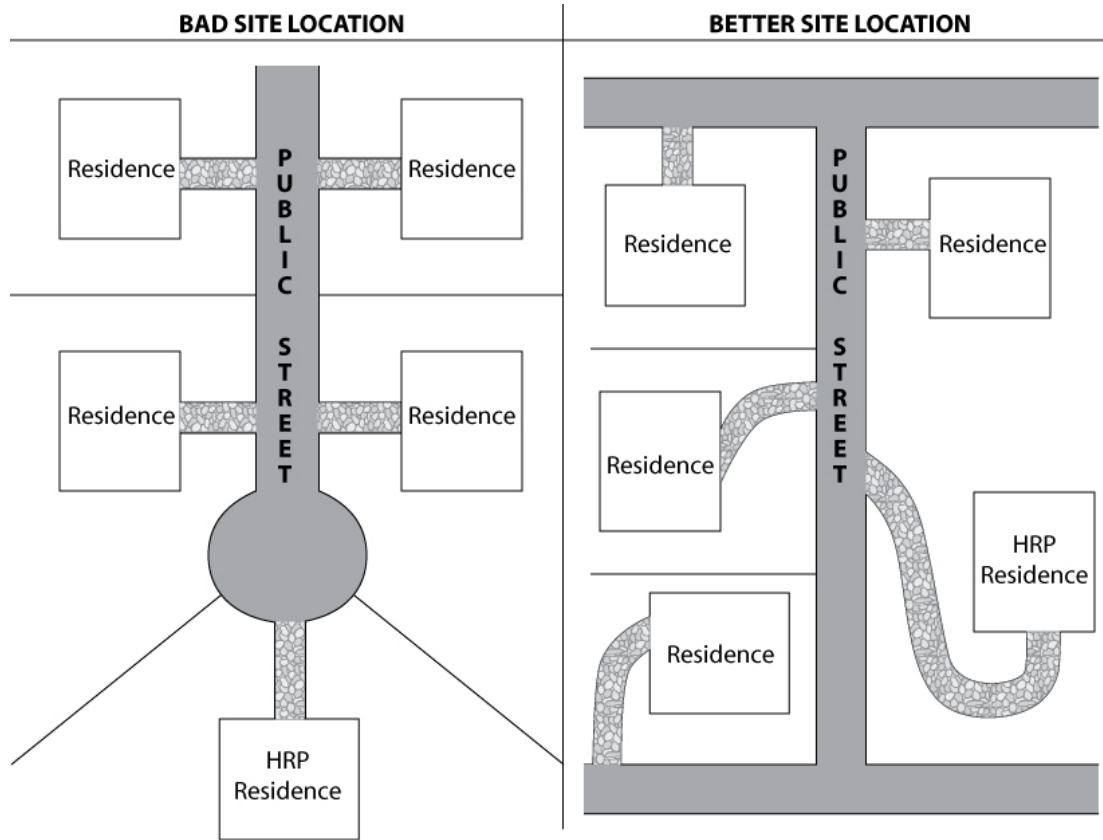

CHAPTER 4 - PROPERTY PERIMETER

4-1 OVERVIEW

This chapter provides an elaboration of the Perimeter (P) recommendations summarized in Chapter 2. The property-line or installation-perimeter is the first boundary over which DoD forces have substantial influence and control. This chapter covers perimeter issues such as general perimeter protection, protection from culvert and utility space intrusion, entry access, anti-vehicle barriers, security lighting, perimeter intrusion alarm systems, security gatehouses, and CCTV systems.

4-2 COMMON PROPERTY PERIMETER RECOMMENDATIONS

4-2.1 COMMON PROPERTY PERIMETER RECOMMENDATIONS

The following requirements apply to both HRP offices and residences.

- P-1C: Subterranean Openings. Man-passable subterranean openings, such as utility openings, should be hardened.

4-2.1.1 Subterranean Openings

Culverts and underground utilities such as sewer pipes provide a possible intrusion entry point. An opening is considered to be “impassable” if one dimension of a rectangular opening is less than 6 in. (15 cm) or if the total area is less than 96 sq in (in²) (619 sq cm (cm²)).

4-2.1.1.1 P-1CM Commentary

To harden “passable” openings, single or multiple gratings or grills can be used. The provided grills should be constructed with bars that are at least No. 5 rebar [5/8 in (16 mm)]. Additional constrictive barrier designs should be considered for higher threat scenarios. As an alternative, an IDS can be used. A better solution is a combination grate with an integrated alarm mechanism for which there are off-the-shelf security products. When grating/grilling or alarms are implemented, it is preferred that the countermeasures be placed at accessible locations on the protected side of the subterranean openings. Installation of countermeasures at hard-to-reach locations makes them susceptible to compromise or difficult to check and monitor for integrity. Refer to Figure 4-1 for an illustration of how subterranean openings may be protected.

FIGURE 4-1. PROTECTION OF SUBTERRANEAN OPENINGS

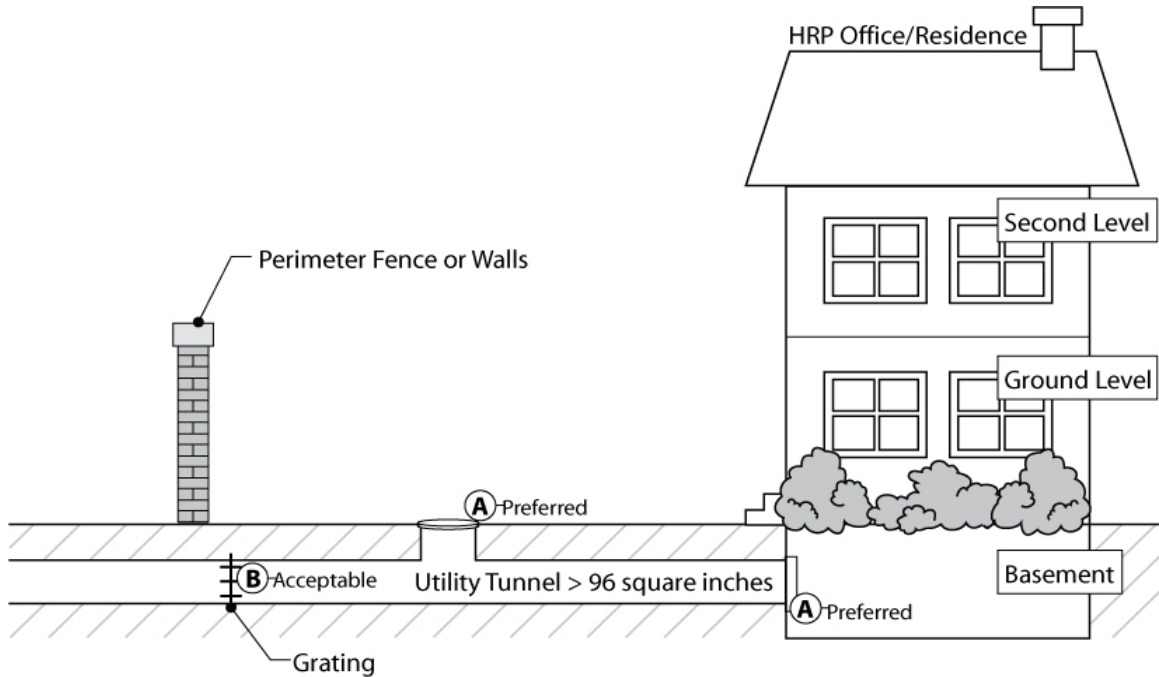

4-3 RESIDENCE PROPERTY PERIMETER RECOMMENDATIONS

4-3.1 RESIDENCE PROPERTY PERIMETER REQUIREMENTS

The following property perimeter requirements apply to HRP residences.

- P-2R: Perimeter Boundary. To delineate property boundaries, the residential property perimeter should be encircled with a physical barrier, such as a wooden fence, curb, or vegetation to mark the property boundary and establish criminal trespass conditions. The residential driveway access is assumed to be open. The PSVA may recommend higher levels of protection resulting in the property perimeter encircled with a fence or wall of 6 ft (2 m) minimum height and gated driveway.

4-3.1.1 P-3R Commentary

To the maximum extent possible, a physical perimeter barrier should be established on the property line of the protected domain. Fundamental to criminal prosecution of trespass or more significant crimes is proof of unlawful entry. Crossing a physical barrier is helpful in establishing intent by the intruder to be in an area without authorization. Additionally, perimeter barriers add delay factors to ingress and egress times. While it is rare that an HRP office is located outside a secured American compound, it is common that an HRP residence will be located off-installation. In any event, even for those cases located inside a secured compound or installation, it is a prudent practice to establish some HRP building boundary (hedge or picket fence) to establish the condition of

criminal trespass or alert notification because it is possible for aggressors to get onto an American installation or compound. Rarely is a perimeter barrier exactly on a property line. In most cases, the barrier (fence or vegetation) is some distance inside the property. The intent is to establish a barrier that allows establishing the trespass act. The following subparagraphs will review different means or vegetation for establishing a physical boundary.

4-3.1.2 Wood Picket Fences

While offering little physical resistance, a simple wood picket fence helps establish a trespass boundary.

4-3.1.3 Hedges

There are a variety of vegetation species that make good security hedges. A dense, thorny hedge makes a formidable physical barrier but can conceal intruders from the protected property grounds. Hedges planted in a raised curb or planter offer additional vehicular penetration protection.

4-3.1.4 Decorative Bollards with Chains

Anchored decorative bollards with interconnecting decorative heavy-gauge chains offer little pedestrian impediment, but can establish a trespass perimeter. If properly designed with sufficient strength and footings, the bollards can provide vehicle barrier protection.

4-3.2 PERIMETER BOUNDARY

If the PSVA recommends a higher level of protection, there are several options. Especially for off-installation residences, the property perimeter can be protected by a fence or wall, and the residential driveway should be gated. Fences vary in material and design, from chain-link fences to sturdy ornamental fences with impalers. A fence offers the advantage of being able to be seen through and thereby increases visual surveillance or awareness of the area immediately outside the fence. Walls block viewing of the external zone, but simultaneously shield the protected property from external lines of sight and inhibit or stop vehicular penetration. A very brief overview of different fence and wall types and materials follow.

4-3.2.1 Chain-Link Fences

Chain-link fences offer some increased trespass resistance over short wooden fences, but can be easily-cut, scaled, or hurdled. Chain-link fences can also be easily breached with bolt-cutters. Chain-link fences are not aesthetically pleasing, and may work for office perimeters, but are not desirable for residences.

4-3.2.2 Masonry Walls

Brick or masonry walls help shield the protected property grounds from external lines of sight and can inhibit or stop vehicular penetration. One guideline is a 9-ft (2.75-m) wall

measured on both sides without footholds or handholds. A lower standard would allow footholds and handholds on the protected side. A downside to masonry walls is the shrapnel effect associated with an off-site explosive charge.

4-3.2.3 Metal Ornamental Fences

Metal ornamental fences offer better aesthetics, and greater barrier penetration resistance than chain-link fences.

4-3.2.4 Anti-Climb Fences

New security fence material places the vertical and horizontal fence members in such close proximity that it is not possible to insert a hand or foothold between the fence segments. These fences can be obtained in a variety of colors and are made of materials with higher cut resistance.

4-3.2.5 Gating the Residential Driveway

Part of the P-4R recommendation is the stipulation that the residential driveway be gated. Typically this means a motor-operated gate. When a driveway gate is implemented, a scheme for opening the gate has to be prepared, which gets into issues of access control. While card readers or remote gate operators can be used for the HRP and the HRP's family, additional provision needs to be added for visitors. For visitor access, there are three main schemes for access control of the gate, as shown in Figure 4-2. The simplest scheme is Station 3, where a combination camera, intercom, gate operator station is used. A gated entrance with a camera and intercom system keeps unwanted visitors at a distance and initially avoids a face-to-face encounter. A sample product is shown in Figure 4-3. Station 2 would imply a staffed guard post for the PSD at a location within line of sight of the gate, but at standoff distance. Station 1 is right at the driveway entrance and would require a guard-post with restroom facilities as described in Chapter 5. Advantages and disadvantages of each access control station are summarized in Table 4-1. Since the actuation of the gate includes operational protocol of who opens the gate and under what circumstances, a decision on which solution to implement requires involvement of the PSD, host nation guards, and the HRP.

FIGURE 4-2. GATE ACCESS CONTROL STATIONS

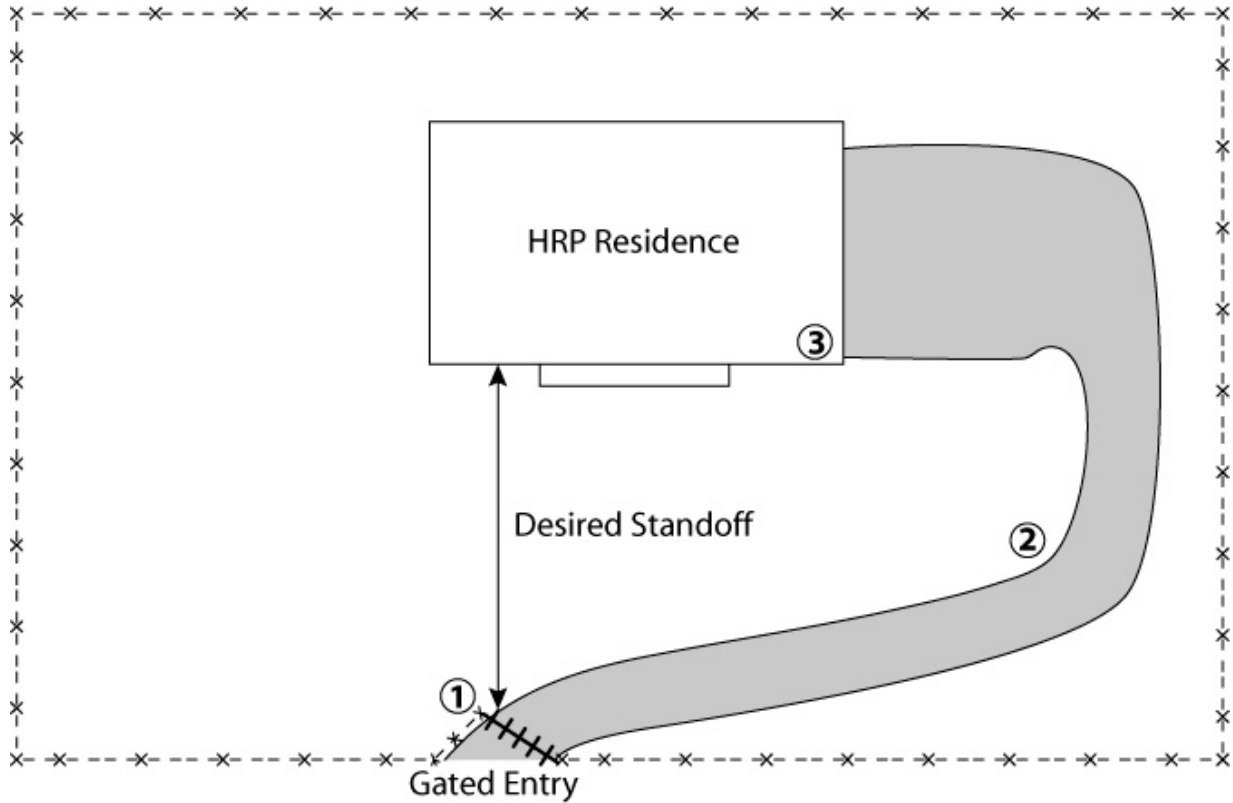

FIGURE 4-3. SAMPLE GATE OPERATOR PRODUCT

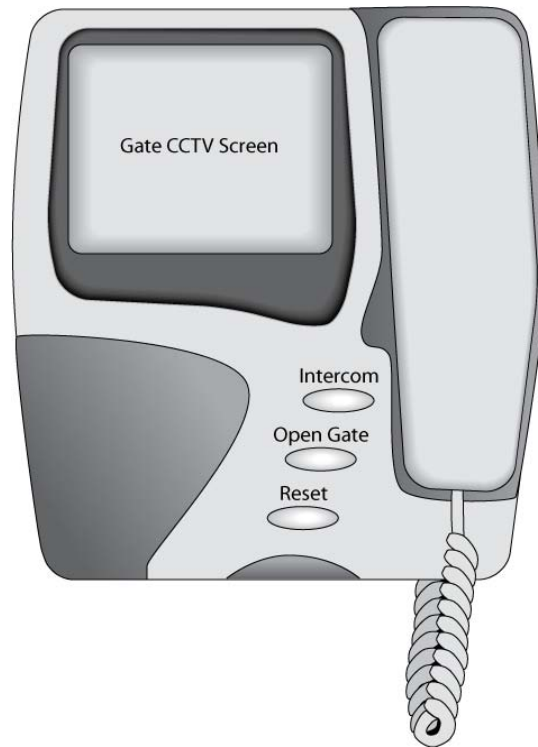

Table 4-1. Gate Station Considerations

	① Guard Post at Gate	② Remote Guard Post	③ Remote from Residence
PROS	<ul style="list-style-type: none"> • Close-up visual identification and assessment. • Allows increased surveillance of the adjoining street. • Least obtrusive to the HRP. 	<ul style="list-style-type: none"> • Standoff for the guard. • Possible increased surveillance of the HRP residence. • Not obtrusive to the HRP. 	<ul style="list-style-type: none"> • Can be done without a guard.
CONS	<ul style="list-style-type: none"> • Requires a guard booth or a guard post. • The guard is in close proximity to a potential threat. • Manpower intensive. 	<ul style="list-style-type: none"> • Requires an intermediate guard post. • Manpower intensive. 	<ul style="list-style-type: none"> • Requires line of sight or camera to the gate. • Requires coordination between HRP and PSD. • Requires underground electrical interfaces.

4-3.2.6 Vehicle Barriers

For the most critical situations, a vehicle barrier can be used to maintain stand-off to an HRP's office or residence to mitigate the effects of a VBEID and prevent unauthorized or controlled vehicle access. Vehicle barrier protection is important for two reasons. First, a vehicle can be used as a VBIED. By breaching the perimeter, the vehicle bomb can get inside an established standoff distance and do more damage. Second, in an intrusion attack, a vehicle can be a quick means to get inside the property perimeter, saving additional seconds for the assailants to get into the residence. Metrics (such as the gross vehicle weight) of the vehicle that might be used are beyond the classification level of this UFC. The security designer should assess the likely threat and associated vehicle mass in determining the design strength of the barrier. The resultant barrier does not necessarily need to be structural in nature. Natural environmental barriers such as vegetation, rock faces, or steep ditches (moat effect), that can be proven to offer protection from vehicle impact, are acceptable solutions. Refer to UFC 4-022-02 for additional guidance on vehicle barriers.

4-3.3 CLEAR ZONES

The PSVA may recommend improvements to the external and internal clear zones. The verbiage below outlines some good practices with respect to clear zones.

4-3.3.1 External Clear Zone

The external clear zone is the area immediately outside the perimeter barrier or boundary. It should be kept free of excessive vegetation. A good practice is not to allow the vegetation in the external clear zone to exceed 1.5 ft (0.5 m). The 1.5 ft (0.5 m)

height is based on limiting the ability of assailants to conceal themselves in a staging position immediately outside the perimeter boundary.

4-3.3.2 Internal Clear Zone

As a good practice, vegetation in the internal clear zone should not exceed 6 in (15 cm) for the zone extending 10 ft (3 m) inward from the perimeter fence or wall. The vegetation limitation on the inner clear zone is more restrictive than the outer clear zone. The 6 in (15 cm) height is based on limiting the ability to conceal a large explosive charge.

- P-3R: Egress Route Viewing. A capability to view the egress routes in advance of exiting the residential property should be established.

4-3.4 EGRESS ROUTE VIEWING

Egress route viewing is the ability to monitor activity on the external public roads before leaving the HRP residence. For official business travel, the capability to view the egress routes in advance of exiting the residence can easily be established by the PSD in an advance car; however, there will be occasions when the HRP may use a POV when the PSD is not assigned. If the residential garage opens immediately onto public streets, it would be a good practice to view the outside area before opening the garage door. A simple way to do this is to install a sight-glass in the garage door. A more robust method is to install a CCTV system that has a monitor inside the garage.

- P-4R: Vehicle Access Points. The number of vehicle access points to the HRP residence should be kept to the minimum necessary.

4-3.5 P-4R COMMENTARY

Having more than one vehicle access point increases the vulnerability. As a result, the number of access points should be minimized. Usually, there is just one vehicle access point to a residence, the driveway. For larger residences, additional vehicle access points may exist such as service roads for deliveries.

- P-5R: Perimeter CCTV. Consider closed-circuit television (CCTV) to allow security personnel to assess threats around the residence and the perimeter.

4-3.6 PERIMETER CCTV

The primary function of CCTV system is to assess threats from the IDS. A secondary benefit of the CCTV system is surveillance. There is a case history of an individual who was frequenting the sidewalk outside an HRP residence. Monitoring of CCTV footage picked up on the unusual behavior and enabled security personnel to intercede. Use of pan, tilt, zoom (PTZ) cameras for external zone monitoring must be judicious. Privacy laws in some countries or states preclude unlawful surveillance of other private property. One mitigating method is to blank out monitor screens of non public areas or

to mechanically limit the range of PTZ camera movement. When providing CCTV, issues of illumination should be considered. Options for CCTV illumination during times of darkness include activated illumination (alarm or motion), infrared illuminators, low-light camera, or thermal cameras.

- P-6R: Perimeter IDS. Consider adding an IDS for the perimeter to provide the earliest possible detection and notification of an intrusion.

4-3.7 PERIMETER IDS

For a higher level of protection, consider adding an IDS to the perimeter to provide the earliest possible detection and notification of an intrusion. The technology should be appropriate for the level of protection and threat. Technology options include fence-mounted systems, buried cable/fiber sensors, video content analysis systems, infrared, and microwave sensors. The use of dual technology sensors/systems is recommended for all IDS. The use of two detection sensors configured in an “AND” logic improves system performance (less nuisance alarms) since both sensors need to be activated to achieve an alarm condition. Refer to UFC 4-021-02NF, *Security Engineering: Electronic Security Systems*.

CHAPTER 5 - PROPERTY GROUNDS

5-1 OVERVIEW

This chapter provides an elaboration of the Grounds (G) recommendations summarized in Chapter 2. Property grounds constitute the area between the property perimeter and the exterior of the building where the HRP is located. For blast protection, the most cost-effective countermeasure is standoff—distance between the blast location and the HRP. The external clear zone is an area immediately outside the property fence or wall and may be on property not under the control of the DoD. The internal clear zone is the area immediately inside the property perimeter. The clear zone, when combined with the rest of the property grounds, constitutes the space an intruder must cross before entering the protected building (office or residence). Immediately around the HRP office or residence is an area known as unobstructed space. Obstructions that could hide a smaller explosive charge (briefcase size) should be eliminated in this zone as a blast hazard countermeasure. This chapter reviews issues of standoff distances, unobstructed space, vegetation, illumination, parking, and garages, as well as intrusion detection systems such as CCTV. This UFC assumes the HRP Office is located in an inhabited building or primary gathering building as defined by UFC 4-010-01. Therefore, the minimum standards of UFC 4-010-01 are not repeated. As a result, this chapter focuses on minimum standards for off-installation HRP residences.

FIGURE 5-1. ELEMENTS OF PROPERTY GROUNDS

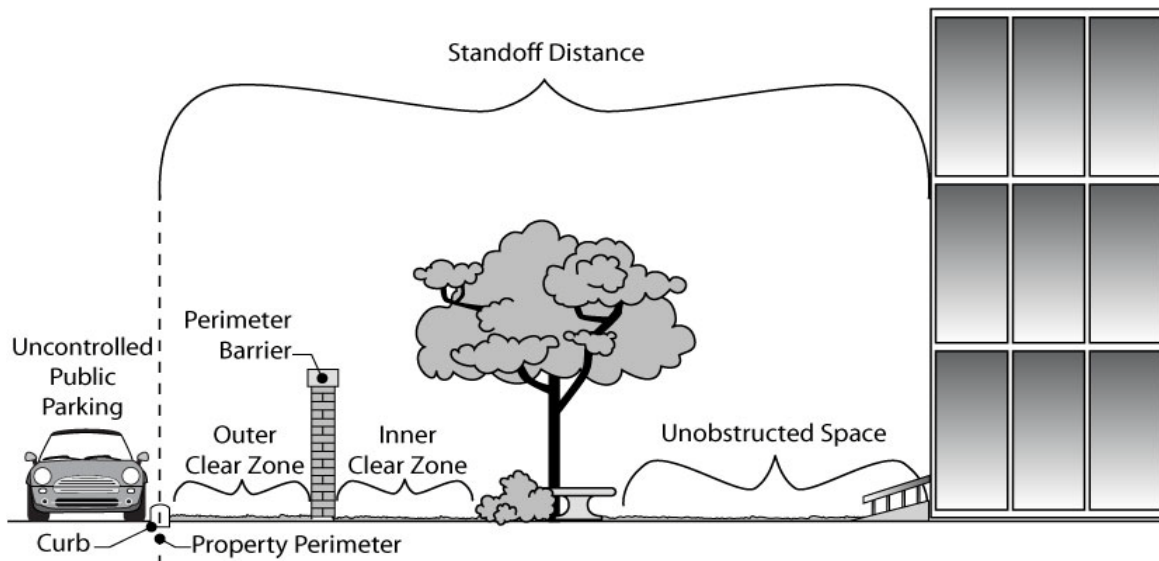

5-2 RESIDENCE PROPERTY GROUNDS RECOMMENDATIONS

5-2.1 RESIDENCE PROPERTY GROUNDS RECOMMENDATIONS

The following countermeasures are recommended for off-installation HRP residences:

- G-1R: Standoff Distance. The standoff distance of the protected residence should meet UFC 4-010-01 standards for a Very Low Level of Protection.

5-2.1.1 G-1R Commentary

Greater standoff distances offer blast mitigation and may be required for higher threats or higher levels of protection. Invariably, having sufficient standoff distance is the most economical countermeasure for mitigating blast hazards.

- G-2R: Vantage Points. The HRP pickup/drop-off area and residential high-visibility windows should be concealed or screened from external vantage points.

5-2.1.2 G-2R Commentary

Vantage points are geographic locations that offer a superior line of sight into the protected property. Consideration should be given to avoid or eliminate lines of sight from external zones that offer a direct-fire or indirect-fire ballistics path. Examples of external zone vantage points are a hilltop or a higher-elevation property, such as a neighboring apartment building. There are a variety of countermeasures that can be used to limit the line of sight, such as screening walls or landscaping. UFC 4-010-01 discusses building entrance layout under Standard 11 in Appendix B.

For the HRP residence, activity at the HRP pickup/drop-off point is more frequent than HRP appearance at the front entrance. While an attack may be planned for a location away from the HRP residence, it is possible for on-site or nearby observers to confirm which vehicle the HRP has entered. As a result, the HRP pickup/dropoff location should be screened to mitigate visual confirmation of the HRP location. This is sometimes referred to as “covered pickup and drop-off.” Figure 5-2 illustrates some of the vantage point countermeasures discussed above.

- G-3R: HRP POV Parking. HRP POV parking should be in a controlled area.

5-2.1.3 HRP POV Parking

The controlled area is intended to limit access to the HRP POV. At residences, a garage that can be securely locked and alarmed is one method of securing vehicles. An alternate method is to park the POV within a short line of sight of an existing guard post.

FIGURE 5-2. VANTAGE POINT COUNTERMEASURES

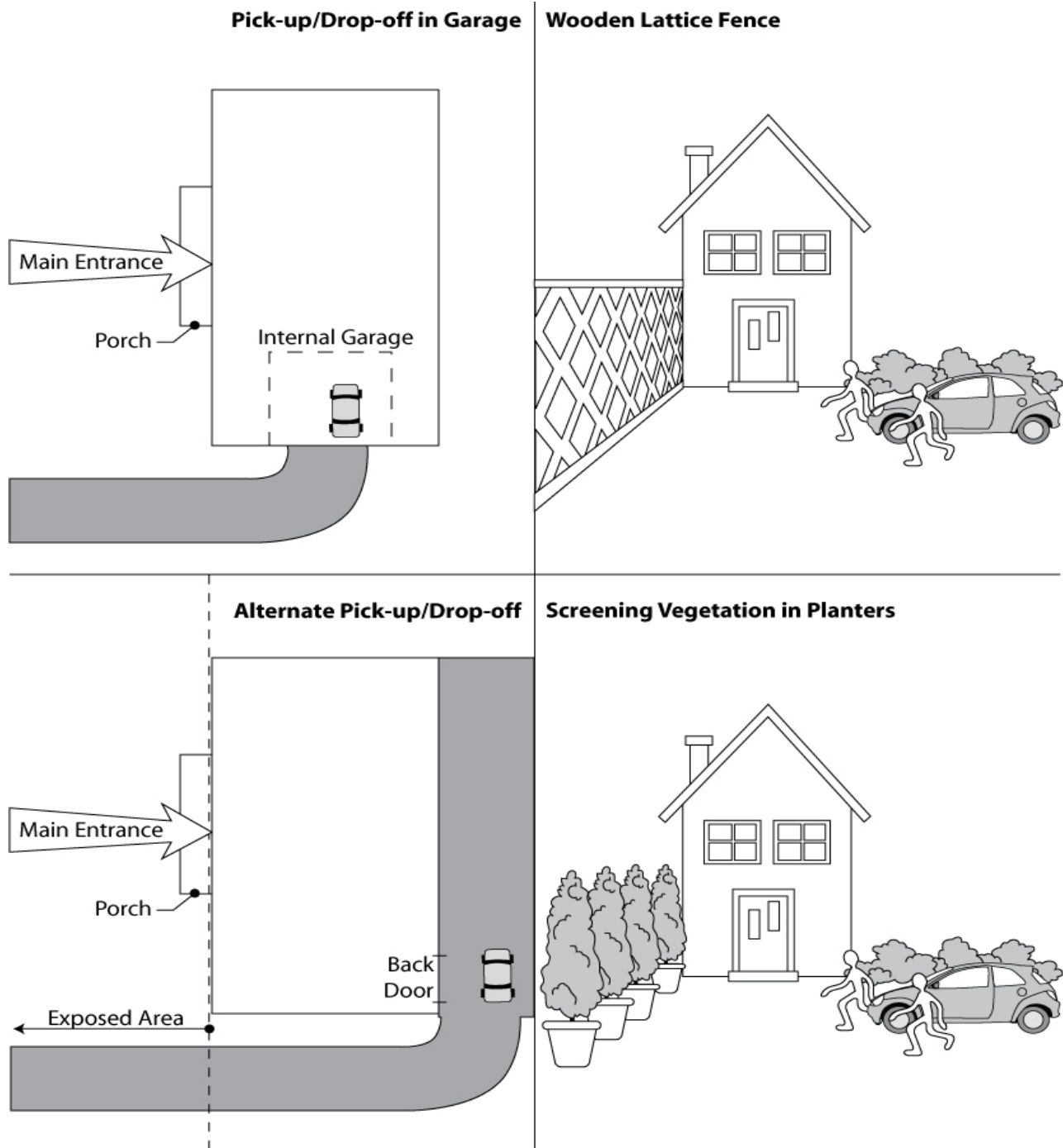

- G-4R: Security Lighting. Provide security lighting around the residential exterior. At a minimum, luminaries should be provided at all entrance and exit points.

5-2.1.4 Security Lighting

Lighting above exterior doors helps deter intruders and minimize the risk that an aggressor can conceal themselves near the door. The exterior door lighting should be left on during periods of darkness. Exterior lighting must consider concepts such as peripheral detection, glare control, illumination levels, uniformity, and color-rendering index. Full cutoff or fully shielded luminaries mounted on the residence wall can illuminate the exterior of the building without adding light to the surrounding area or cause light trespass to neighboring properties. Lighting the unobstructed space around the residence exterior helps deter concealment. Full cutoff fixtures should be used to limit the amount of light projected vertically. Enhanced lighting should be considered to illuminate the areas around the residence to include trash receptacles. For more detailed information on security applications of lighting, refer to the “Security Lighting” chapter of UFC 3-530-01, *Design: Interior and Exterior Lighting and Controls*.

- G-5R: Unobstructed Space. Obstructions within 33 ft (10 m) of the HRP residence should not allow for concealment of objects 6 in (150 mm) or greater in height.

5-2.1.5 Unobstructed Space

Referring to Figure 5-1, unobstructed space is the zone within 33 ft (10 m) of an inhabited building that does not allow for concealment of objects 6 in (150 mm) or greater in height. The unobstructed space limits the size of a potential explosive charge to something that could not be concealed. Unobstructed space can be confusing if one does not understand the intent of the definition of the word “conceal.” The best clarification is by example. Trees with trunks that grow straight up are not considered concealing, because an object could be observed at the base of the tree. On the other hand, a tree or bush with sweeping, bushy branches could conceal an object greater than 6 in (150 mm) in height and should be trimmed or removed. A park bench with support legs and open air between them would not be considered an obstruction. Conversely, a large storage bin that had a swinging lid on could be an obstruction if it were capable of concealing an object 6 in (150 mm) high or higher. A free-standing HVAC unit (or small pad-mounted transformer) is not considered an obstruction if one can see fully around the perimeter and the base of the unit.

- G-6R: Access Control Point. Since threat levels or security needs can increase, a residence with space for a guard booth or guard house that can monitor and control access to the property is preferred. (Grounds)

5-2.1.6 Guard Booth/House Space

The security environment can change. To sustain a long-term posture, a watch and duty station should be established. While this would only be required at the highest levels of protection, a property that has space for a guard booth or guard house would be better suited for a HRP residence. UFC 4-022-01, *Security Engineering: Entry Control Facilities / Access Control Points* provides *Guard Facility Design Criteria*. While full

incorporation of these design criteria may not be warranted for a HRP guard booth or guard house, they should be evaluated and included as appropriate. If required or provided, security guard booths/houses should meet the following criteria:

5-2.1.6.1 Location

Locate the guard booth or guard house at the entrance to the property to control vehicular and pedestrian access to the site. Consideration should be given to the location's ability to be used as a fighting position, to include adequate fields of fire and ballistic protection.

5-2.1.6.2 Space

Nominally 100 to 150 ft² (9 to 14 ft²).

5-2.1.6.3 Control

Contains gate-operator activating-controls, either electrical or mechanical.

5-2.1.6.4 Restroom

Includes a lavatory, water closet, and base cabinet.

5-2.1.6.5 HVAC

Is environmentally-treated air conditioning or heating as determined by the local environmental conditions.

5-2.1.6.6 Security

Is lockable.

5-2.1.6.7 View

Provides view of the area in the vicinity of the gate, in the immediate surroundings, and the front door of the residence.

5-2.1.6.8 Communications

Intercom communications established between the guard house (if one is provided) and the gate and between the guard house and the residence or office.

5-2.1.6.9 Bullet Resistant Construction

Guard booths/houses should have ballistic protection. Consider ballistic protection in the design and construction of the exterior envelope including windows, doors, walls, and other equipment.

- G-7R: Visitor Parking. When there is no external controlled perimeter, visitor parking should be no closer to the HRP residence than 33 ft (10 m).

5-2.1.7 Visitor Parking

Since a parked vehicle can be used to disguise and hide an explosive material, precautions should be taken to make sure that visitor vehicles do not get closer than the minimum 33 ft (10 m) standoff distance specified for HRP residences.

CHAPTER 6 - BUILDING EXTERIOR

6-1 OVERVIEW

This chapter provides an elaboration of the physical exterior Envelope (E) recommendations summarized in Chapter 2. Architectural and structural issues on forced entry, blast protection, number of floors, wall types, protection of openings such as doors, windows, and other entry points; and interior courtyards are reviewed.

6-2 COMMON BUILDING EXTERIOR RECOMMENDATIONS

The following recommendations apply to both HRP offices and residences.

- E-1C: Number of Levels. HRP offices and the residential master bedroom should be located in buildings which are three stories or less in height. The office and master bedroom should be located on a floor above ground level. When located in structures more than three floors, HRP offices and the residential master bedroom should not be above the third floor, and prevention of intrusion from upper floors must be addressed.

6-2.1 NUMBER OF LEVELS

To provide additional delay time against forced entry and to enhance fire safety, a recommendation is made on the number of floors (levels) present in HRP offices or residence buildings. For this recommendation, the number of levels refers to floor levels above ground exclusive of subterranean floors. Figure 6-1 illustrates the concepts pertinent to recommendation E-1C.

FIGURE 6-1. NUMBER OF LEVELS

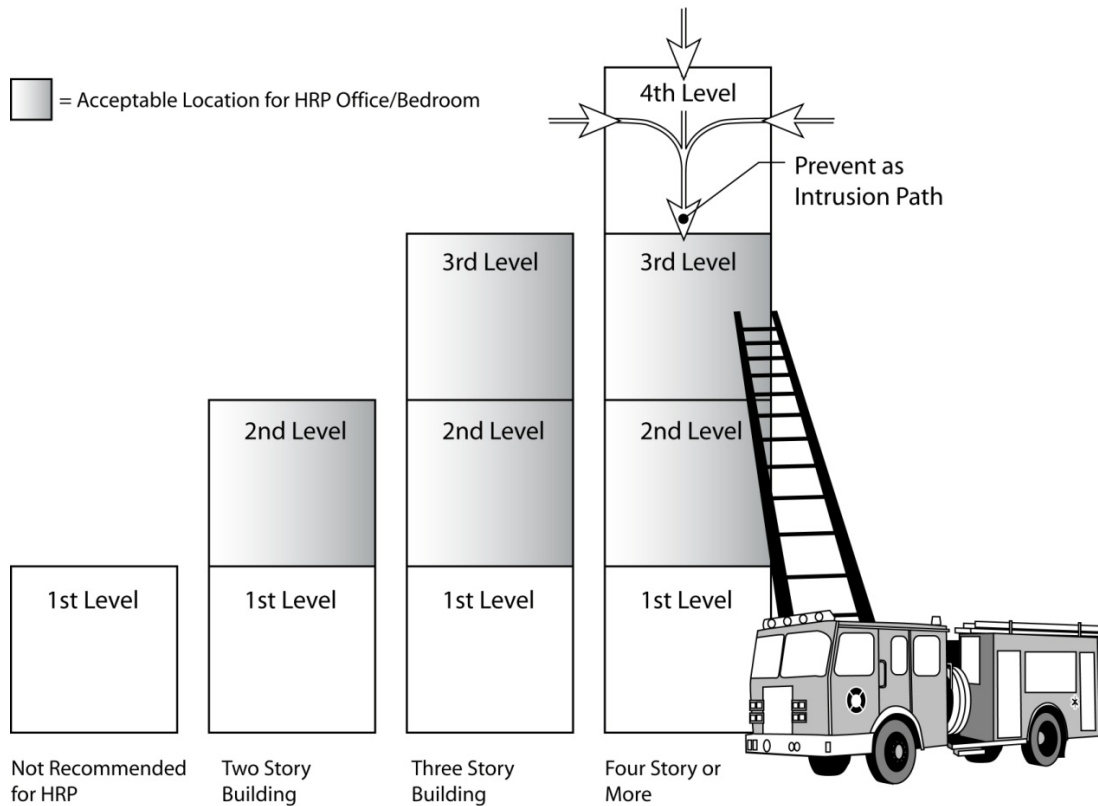

6-2.1.1 Fire Safety

The height at which fire department services can easily evacuate people with standard equipment is three floors or less.

6-2.1.2 Forced Entry Delay

During a forced entry, the HRP's reaction time to get into a Safe Room/Haven is on the order of seconds. To provide additional delay time, it is recommended that the HRP office or bedroom not be located on the ground level. Placement of offices/bedrooms on the ground floor is not a good practice because the ground floor location offers increased lines of sight and multiple entry points (any ground floor door or window) for intruders.

6-2.1.3 Intrusion Consideration

E-1CR does not prohibit locating an HRP office on the third floor of an eight-story building. However, having additional offices above the HRP office in an uncontrolled building is not recommended because assailants can stage or intrude from the higher level floors. Refer to Figure 6-1 on intrusion paths from above.

- E-2C: Window Locks. Windows should be lockable from the inside.

6-2.2 WINDOW LOCKS

Window frames should be locked or secured in a manner such that an intruder is forced to break the glass or cut through the polycarbonate coating in order to gain entry. For a high level of protection, a good window locking system is one with multiple locking and anchoring points, as illustrated in Figure 6-2.

FIGURE 6-2. WINDOW WITH MULTIPLE LOCKING POINTS

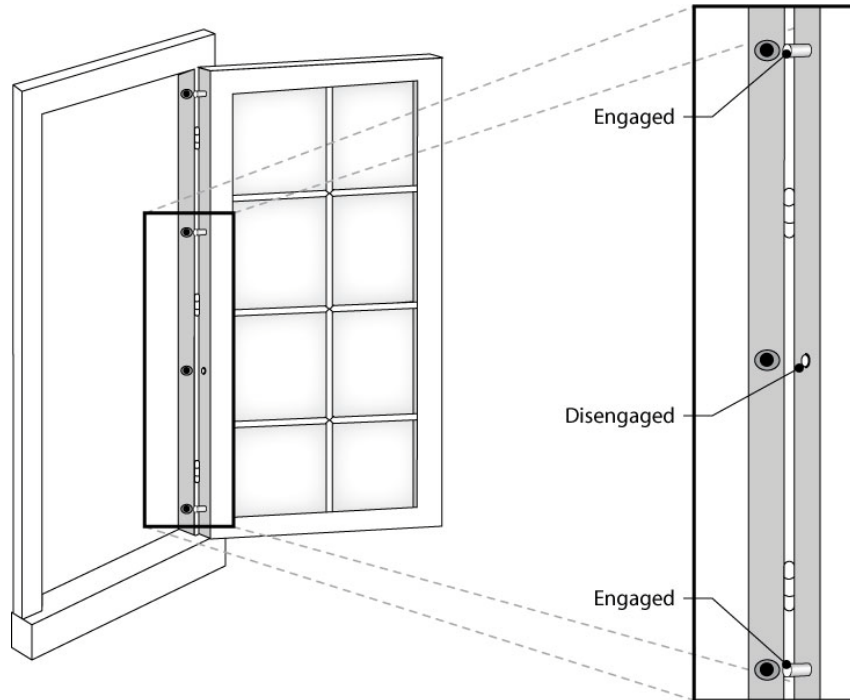

6-2.2.1 Windows and Life Safety Code

NFPA 101, *Life Safety Code*, requires that every sleeping room or living area shall have no less than one primary means of escape and one secondary means of escape. The bedroom windows may be the secondary means of escape. If windows are the secondary escape route, the windows must comply with certain requirements such as (a) being located within 20 ft (6 m) of grade and (b) have windows that are operable from the inside without tools or special effort. The requirements may be relaxed if the residence is protected by a sprinkler system or there is an alternate means of escape. Before modifying bedroom windows such that they may not be usable as a secondary means of escape, review the requirements of NFPA 101 to make sure emergency egress standards are met.

- E-3C: Minimize Number of Exterior Doors. To minimize possible intrusion points, select a building with a manageable number of exterior doors.

6-2.3 NUMBER OF EXTERIOR DOORS

Doors are a likely point for an entry portal because of the multiple components that have to be hardened, such as the door jamb, the locking mechanism, the door frame, and the door itself. While a number is not written into recommendation E-3C, providing forced entry detection and safeguards for more than four exterior doors on the ground floor is challenging.

- E-4C: Exterior Door Material. To assist with forced entry protection, the unglazed portions of exterior doors to HRP offices and residences should be made of solid material such as metal or wood.

6-2.4 EXTERIOR DOOR MATERIAL

For personal protection of HRPs, the primary consideration is the blast and forced entry threat. Doors represent a potential vulnerability for intruder entry. Historic reports indicate that the door is the primary break-in entry point. The minimum standard for door material is wood. Metal doors offer increased forced entry protection, with options of hollow core doors, metal clad doors, and solid metal doors (rare). Use of steel framing increases forced entry protection. Refer to Figure 7-2 in Chapter 7 for a cross-sectional view and supporting explanatory material on door frame systems. The exterior door should be sturdy enough to provide some blast protection. For the purpose of this standard, the interior door from a garage to the residential interior is considered an exterior door.

- E-5C: Door Swing. Exterior doors on HRP offices and residences should open outward.

6-2.5 DOOR SWING

To take advantage of the strength of the door framing system, it is best that exterior doors swing outward. For blast resistance, outward-swinging doors will seat into the door frames in response to an explosive blast, increasing the likelihood that the doors will not enter the buildings as hazardous debris. In addition, the doors resistance to forced entry is improved.

- E-6C: Exterior Door Hinges. Exterior door hinges should be heavy-duty. Countermeasures should be implemented to minimize opportunities for the door to be breached by tampering with the door hinges.

6-2.6 EXTERIOR DOOR HINGES

When door hinges are mounted on the exterior public side of the door, forced entry mitigation measures must be considered. Examples of exterior door hinge countermeasures include flanging/tack-welding the hinge pins, hinge covers, hinge dowels and lugs. Figure 6-3 provides illustrations of door hardware countermeasures.

FIGURE 6-3. DOOR HARDWARE COUNTERMEASURES

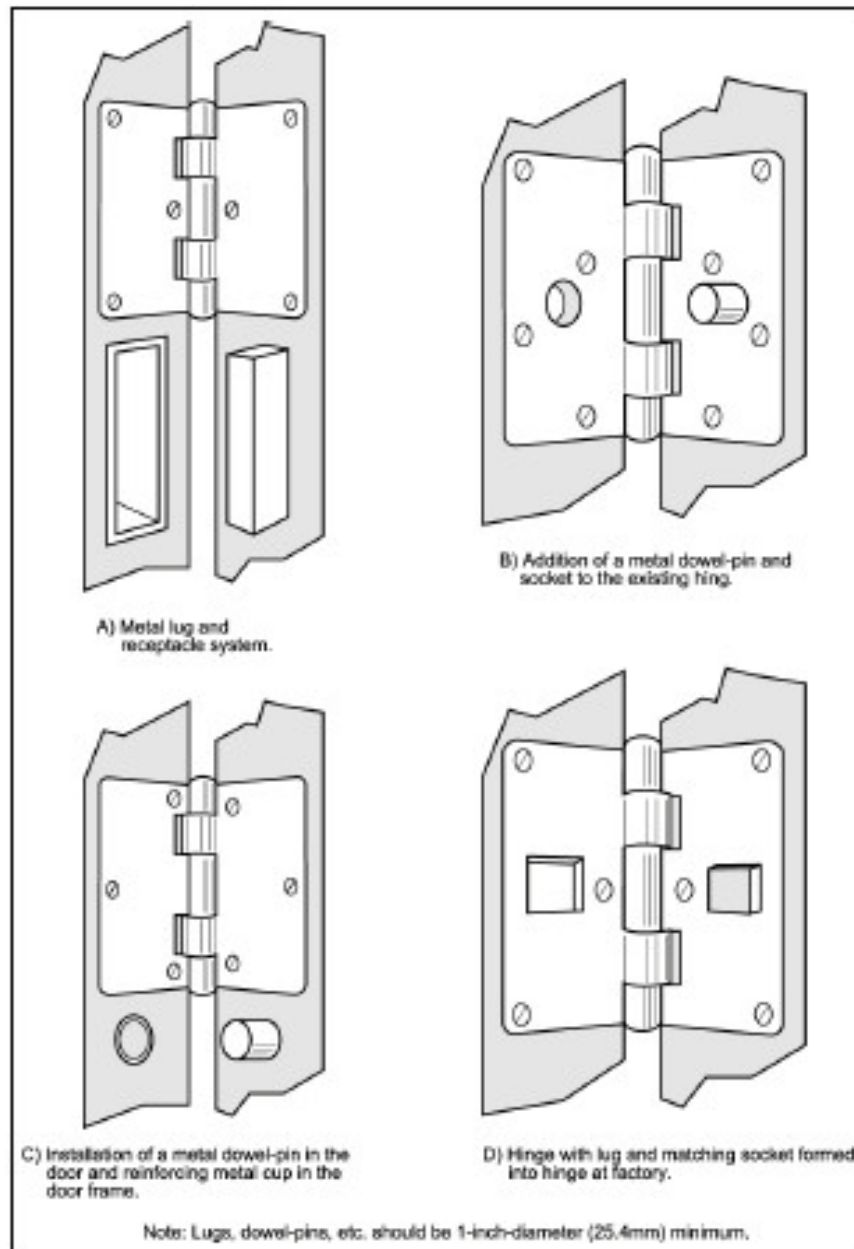

- E-7C: Exterior Door Jambs. If the door jamb material into which the exterior door bolt fits is not of solid material (at least 1 in [26 mm] thick and supported), the door jamb surface should be hardened to resist forced entry attack.

6-2.7 EXTERIOR DOOR JAMBS

The most frequently overlooked door component is the door jamb. The door jamb is the vertical side piece of the door frame. Door jambs are typically constructed of wood or metal. Refer to Figure 7-2 for a cross-sectional view of a door framing system. An

extremely secure door with a weak door jamb will not delay forced entry. If the door jamb can be easily destroyed, then the secure door measures are compromised. It may be more cost effective to replace deficient door jambs with new metal door jambs.

6-3 RESIDENCE EXTERIOR RECOMMENDATIONS

The following recommendations are made for HRP residences:

- E-8R: Exterior Door Locks. Exterior doors should have a minimum of two locking devices per door such as a keyed lock in a doorknob and a dead bolt lock [minimum 1 in (26 mm) throw].

6-3.1 EXTERIOR DOOR LOCKS

Traditional spring latch locks do not throw into the door frame and can be sprung open with a credit card or other flexible implement. Breaking a dead-bolt lock requires more effort and time. Deadbolts come in configurations that include use of interior key, thumb knob, and removable interior thumb knob. The use of key operated interior deadbolts need to be reviewed against life safety codes. When using thumb knob dead bolt, minimize or harden glazing adjacent to the door.

- E-9R: Windows. Windows should comply with Standard 10 of UFC 4-010-01 for inhabited buildings.

6-3.2 WINDOWS

Windows can be a source of flying glass fragment hazards. Traditional plate glass is approximately ¼ in (6 mm) thick and is subject to shattering or breakage. There is a natural conflict between the human desire for windows, especially in residences, and the associate security risks. Where windows are provided, they should meet criteria outlined in UFC 4-010-01 for an Inhabited Building. Windows may be provided with ballistic resistant glazing based on Underwriter's Laboratory, Inc. (UL) 752 Bullet-Resisting Equipment to mitigate the ballistic threat. It should be noted that in a blast event, the window frame, anchorage, and supporting structural elements are designed to the appropriate blast pressure. Therefore, if blast is included in the Design Basis Threat (DBT), serious consideration must be given to other mitigation methods for the ballistic threat such as screening and window films that obscure the protected asset from vantage points.

6-3.2.1 Fragment Retention Film

Fragment retention film is not recommended; laminated glazing is the preferred material. However, when laminated glazing is impractical consider the use of fragment retention film. Fragment retention films not only help retain glass fragments, but have the additional possibility of having a solar reflectance that can help mask interior view from would-be intruders or assailants. Application of fragment retention film is problematic. The window glazing needs to be very clean and care must be taken to

prevent the film from being scratched. It is best to extend the film into the frame and anchor it as shown in Figure 6-4. Fragment retention film requires special cleaning products and loses its effectiveness over time. One estimate of film life is seven years. As a result, laminated glass is the preferred material for window glazing.

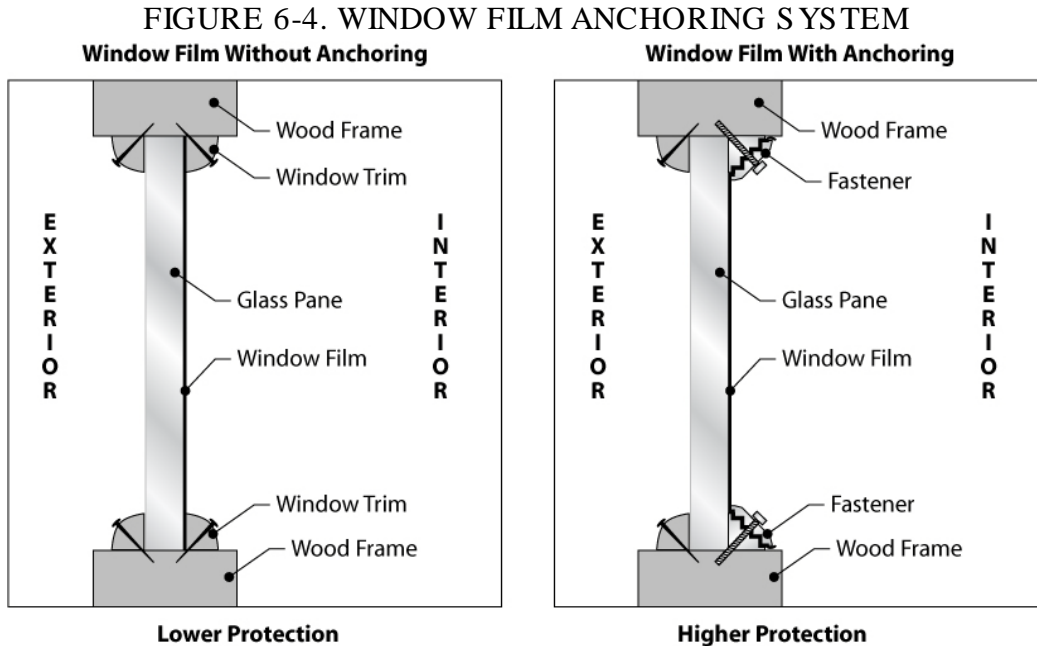

6-3.1.3 Blast Curtains

For retrofit projects where window replacement or application of fragment retention film is problematic, there is the option of using blast curtains. These window-drapery and curtain materials vent blast pressure while catching flying glass shards, as shown in Figure 6-5. If an alternate and equivalent level of protection can be established, blast curtains are an option. The fabric can be custom colored to match office and housing interiors. In order to work, the curtain must remain over the window opening. Additionally, the drapery material must be several times (such as three times) the size of the window.

FIGURE 6-5. BLAST CURTAINS

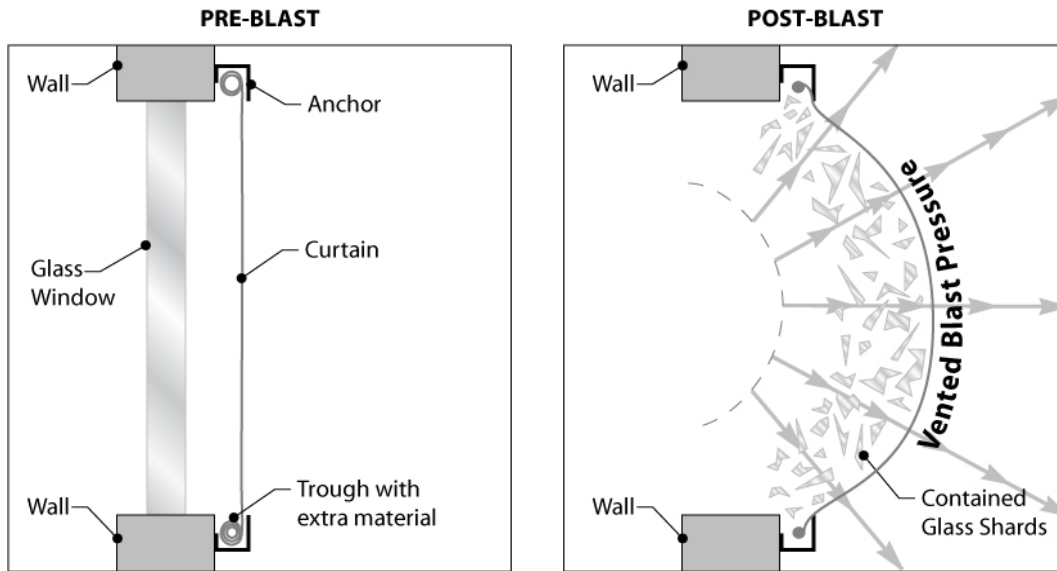

- E-10R: Under-building Access Control. Access to crawl spaces, utility tunnels, and other means of under-building access should be controlled or hardened.

6-3.3 UNDER-BUILDING ACCESS CONTROL

In addition to doors and windows, all other openings of the building exterior envelope should be protected in some manner to prevent the openings being used as an access point. Examples of these types of openings include: basement doors, coal chutes, large electrical tunnels, steam line tunnels, and other utility openings. Countermeasures for safeguarding under-building access are the grill or grate systems described under P-1C (protection of subterranean openings) or the use of supervised door contacts on an IDS system. Figure 6-6 displays a typical example of an under-building access.

FIGURE 6-6. COAL CHUTE ENTRY POINT

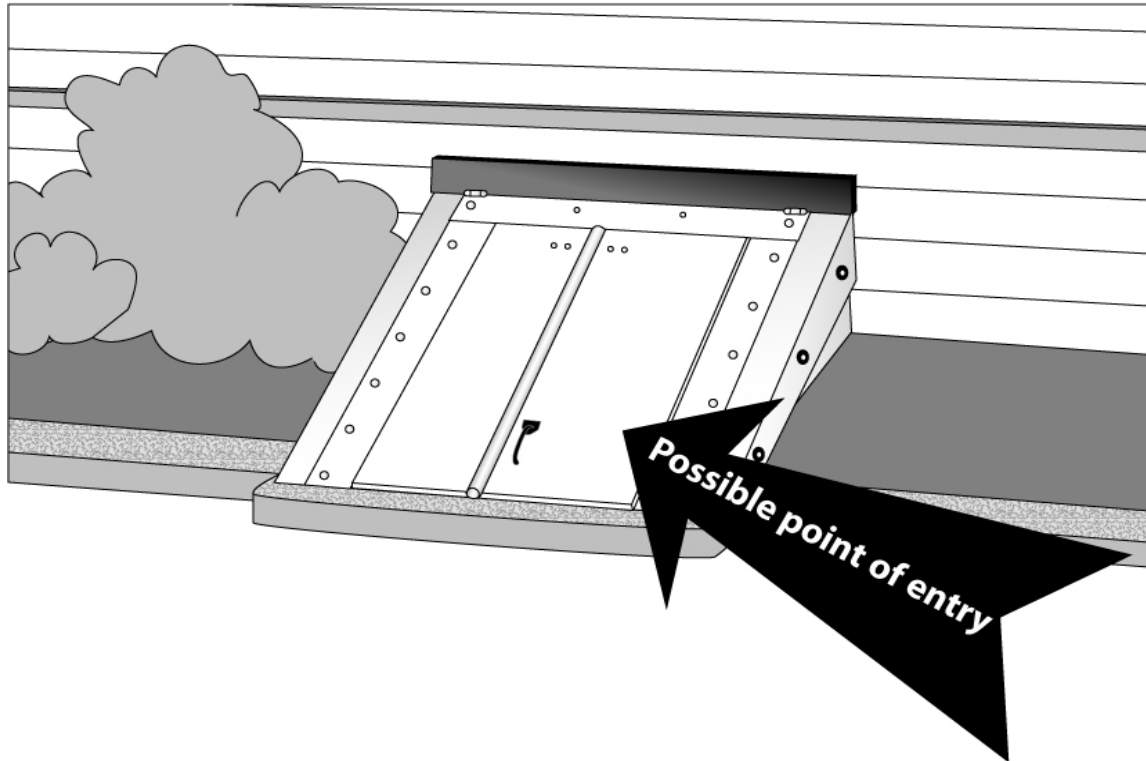

- E-11R: Roof Access. Roof access should be controlled in accordance with Standard 14 of UFC 4-010-01.

6-3.4 ROOF ACCESS

HRP residences will typically not have outside rooftop access. If an exterior means of accessing the rooftop is available, provide safeguards against this being used as an intrusion path. Standard 14 of UFC 4-010-01 discusses the potential threat of aggressors placing explosives or chemical, biological, or radiological agents on a building roof. Where possible, remove all ladders or other means of accessing the rooftop from outside the HRP residence. This step would include locking up maintenance and landscaping ladders used on the property grounds. If removing a rooftop ladder is not feasible, consider providing a ladder guard or other countermeasures to prevent intruders from climbing the ladder.

- E-12R: Residential Mailbox Guidelines. If a mail slot is a part of the residence building exterior, such as a slot in the front door, the mail slot should be blanked to prevent foreign object entry. The residential mailbox should be located a minimum of 33 ft (10 m) from the residence.

6-3.5 MAILBOX

Normally, as an operational practice, HRP mail is sorted out an off-site location. Since the residential mailbox or mail slot could be used as a hiding place or intrusion point for foreign objects, the precautions outlined above should be considered.

- E-13R: Trash Receptacles. Trash receptacles should be located a reasonable distance from the residence.

6-3.6 TRASH RECEPTACLES

Similar to the mailbox, trash receptacles should be positioned a reasonable distance away from the residence, in the event they are used to conceal an explosive device.

6-4 GOOD PRACTICES FOR HRP RESIDENCES

6-4.1 OVERHEAD DOORS

These doors offer another set of problems. The doors may not be reinforced and may contain multiple windows. Common applications are garage doors, but they may be used in the shipping and receiving areas of office buildings. Garage doors are an opening that requires additional consideration because of the size involved. Garage doors can swing outward in two sections or lift overhead. Some of the overhead coiling doors are typically constructed of three to five folding sections. The materials may be wood, composite material (plastic compound), or hollow core metal. Garage doors should be provided with a mechanical latch or lock, unless there is an automatic garage door opener. Due to security vulnerabilities associated with garage or overhead doors, the interior door from the garage into the residence should be treated as an exterior door.

6-4.2 SLIDING GLASS DOORS

Exterior sliding doors have inherent forced entry vulnerabilities and are not recommended for HRP residences. If sliding doors are present, they should be secured with a second locking mechanism such as a patio door bar or secondary lock at the bottom or top of the door as shown in Figures 6-7 and 6-8.

FIGURE 6-7. SAMPLE PATIO DOOR BAR

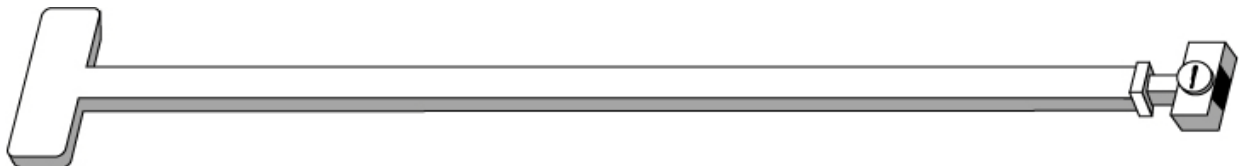
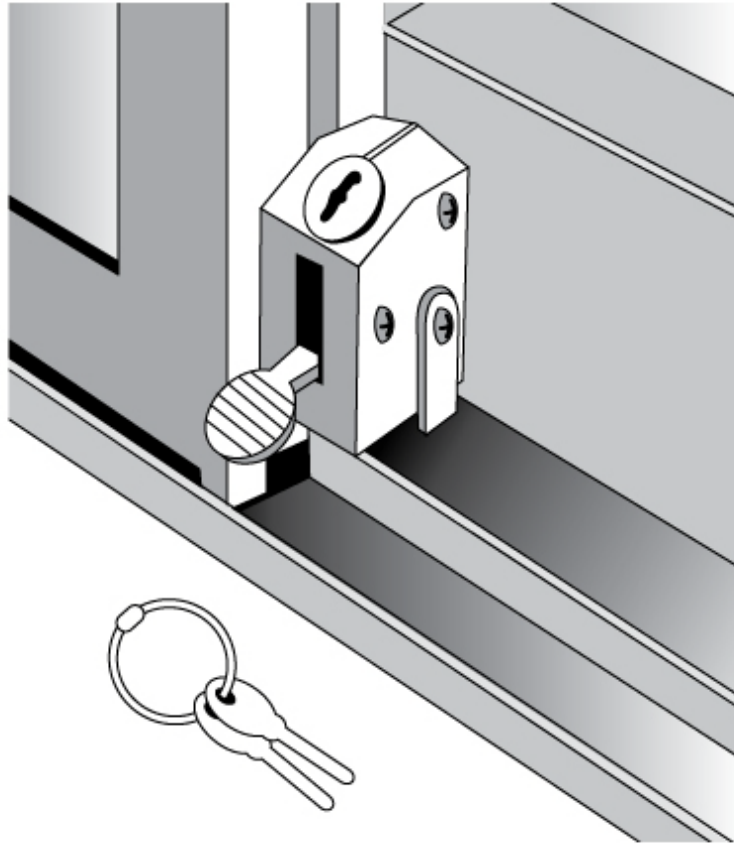

FIGURE 6-8. SECONDARY SLIDING DOOR LOCK



6-4.3 INTERIOR COURTYARDS

Interior courtyards can provide a false sense of security. Interior courtyards introduce additional security concerns in that they offer additional hiding spots and are generally designed to offer large visibility of the courtyard, through weaker glass windows, louvers, or even open-air openings. Figure 6-9 provides a section and plan view of a residence with an interior courtyard. An inspection should be made of interior courtyards to verify that all applicable countermeasures for the exterior building shell are in place for an interior courtyard.

FIGURE 6-9. INTERIOR COURTYARD

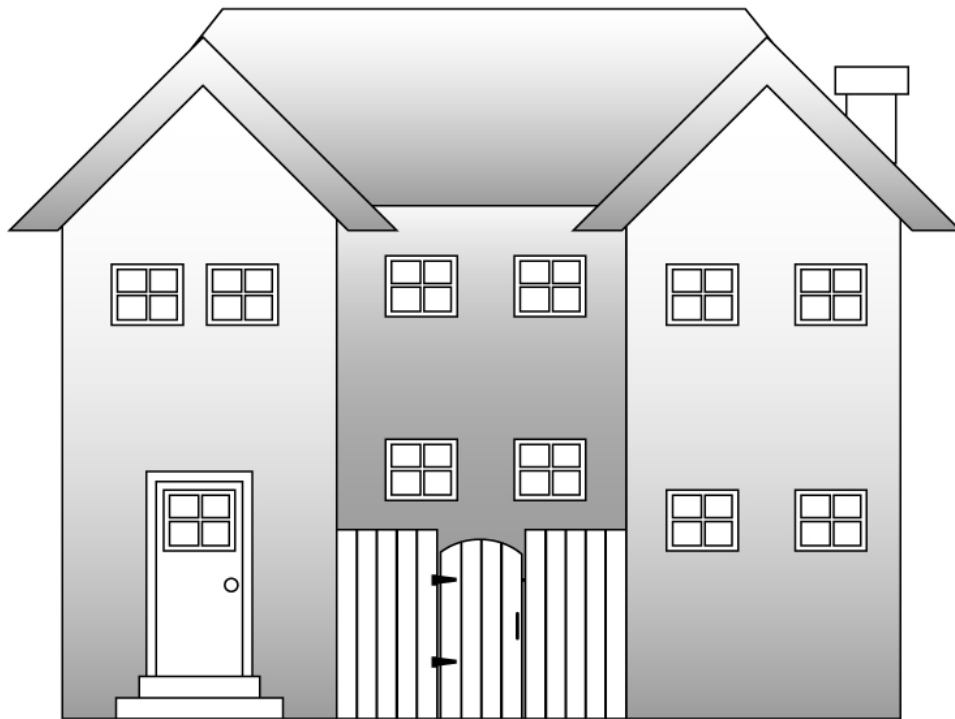
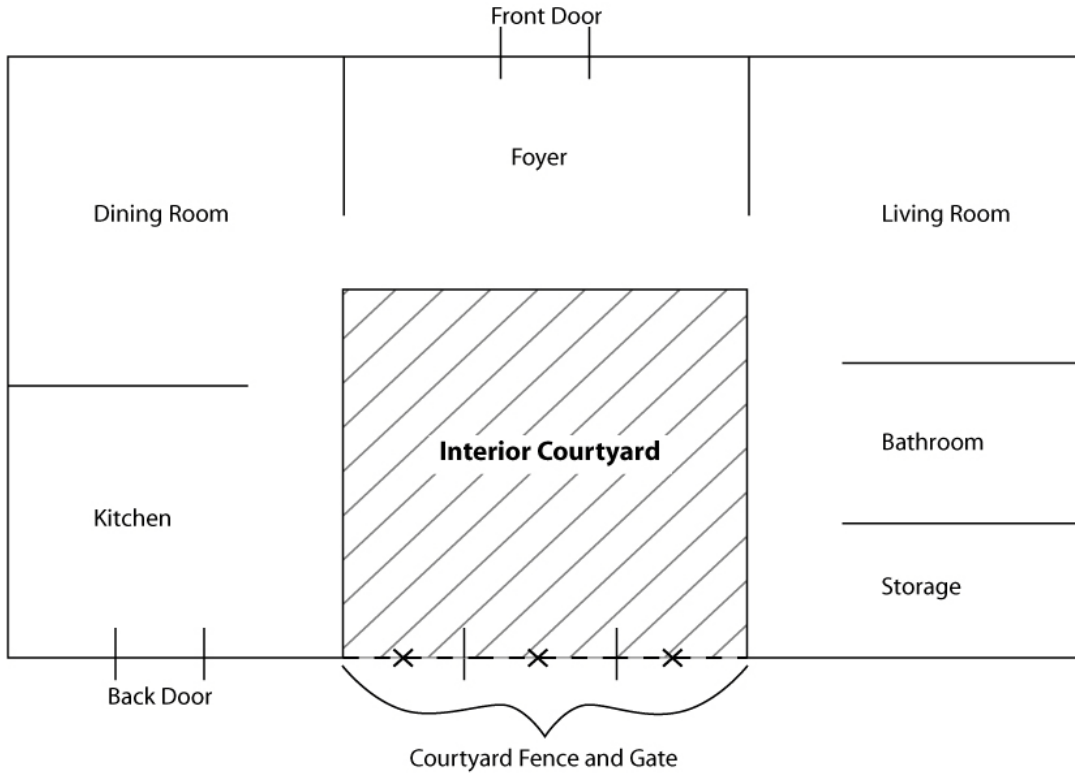

CHAPTER 7 - BUILDING INTERIOR

7-1 OVERVIEW

This chapter provides an elaboration of the building Interior (I) recommendations summarized in Chapter 2. It examines internal building issues such as skylight protection, an internal controlled perimeter around the HRP office suite, and fire alarm/ESS systems.

7-2 COMMON BUILDING-INTERIOR RECOMMENDATIONS

The following recommendations are made for both HRP offices and residences.

- I-1C: Skylights. Due to increased risks of building intrusion, select an office or residence without skylights.

7-2.1 SKYLIGHTS

Skylights present a potential vulnerability point for forced entry. Since skylights are up above the normal field-of-view, it is difficult to determine if they have been tampered with or are breached.

- I-2C: Furniture Layout. Locate furniture such that personnel are seated away from windows or the likely path of glass fragments or other projectiles to the maximum extent possible.

7-2.2 FURNITURE

Location of furniture inside a building can limit or increase exposure of inhabitants to blast fragments or direct-fire weapons. As a result, it is recommended that furniture be positioned to minimize these risks.

7-3 OFFICE BUILDING-INTERIOR RECOMMENDATIONS

The following recommendations are made for the interior office doors and frame systems.

- I-3O: Internal Controlled Access Area. Locate HRP Office in a command suite with controlled access.

7-3.1 INTERNAL SECONDARY PERIMETER

To provide an additional layer of protection (defense in depth) between areas that might be accessed by non-HRP staff and the HRP office, a secondary internal controlled access area is recommended as shown in Figure 7-1. Figure 7-1 is a conceptual relationship diagram intended to be a notional layout to indicate a possible configuration of the HRP office area. The configuration of the area may vary considerably to meet the configuration of the building and the needs of the HRP.

FIGURE 7-1. INTERNAL CONTROLLED ACCESS AREA

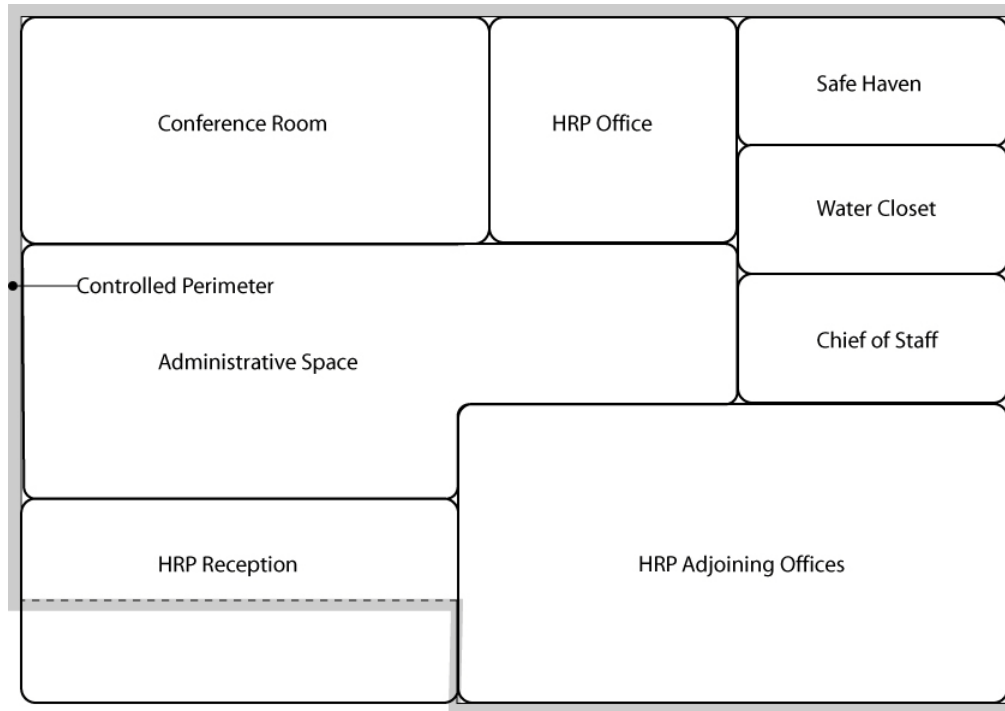

7-3.1.1 I-30 Commentary

Locating the HRP office within an office suite is recommended. Normal efficiency and protocol should require an executive reception area to screen and control visitors from the HRP. Typically, HRP offices are required to be accredited as a secure space. Space consideration should be given to designing the HRP suite and the HRP Office as a secure room. Refer to DoD Instruction 5200.1-R, *Information Security Program*.

- I-40: Primary Access Door. The HRP office and command suite door should be of solid construction and swing outward for forced entry mitigation.

7-3.2 PRIMARY ACCESS DOOR

The command suite and HRP office should be configured with one primary access door. The HRP office door should swing outward for forced entry mitigation. If metal cladding is used, the cladding should be continuous and cover the entire front and back surface of the door. Exterior door hardware should be hardened against forced entry. If the hinge pins are located on the outside (public side), the pins must be peened, brazed, or spot-welded to prevent removal. If double doors are used, an astragal should be installed on the active leaf of the door. Options for doors include:

- Solid wood core door, a minimum of 1¾ in (4.5 cm) thick, or
- Sixteen gauge metal cladding over wood or composite materials for a total thickness of 1 ¾ in (4.5 cm) thick, or

- Metal fire or acoustical protection doors, a minimum of 1¾ in (4.5 cm) thick, or
- An equivalent foreign-manufactured door, if approved by the security office.

7-3.3 OTHER ACCESS DOORS

There may be other door required for life safety egress. These doors should meet the recommendations of I-5O.

- I-5O: Other Access Doors. HRP office doors other than the primary access door should be secured with deadlocking panic hardware on the inside and have no exterior hardware.

7-3.3.1 I-5OM Commentary

Deadlocking hardware in the above recommendation refers to bolts activated by a solenoid that slide into the door leaf from somewhere along the door frame. If these doors are located in emergency egress paths, the bolt must be capable of being automatically retracted by use of panic hardware.

- I-6O: HRP Office Door Frame Construction. The office and command suite door frame system (door frame, hardware, and locks) should be of sufficient strength to preclude distortion that could cause improper alignment of the door alarm sensors, improper door closure, or degradation of security.

7-3.4 HRP OFFICE DOOR FRAME CONSTRUCTION

The intent of the I-6O is to give attention and visibility to the door frame elements surrounding the door leaf. Figure 7-2 shows a typical cross section of a door frame system. If the door jamb is made of wood, it may be possible to breach the door portal by kicking the door inward and splitting vertical, wood, door-jamb material. Metal door jambs are stronger than standard wooden door jambs. Using long screws to fasten the door jamb to the adjoining wall studs is one hardening technique. Another improvement method is using 3 in (760-mm) deck screws to fasten the striker plate and hinge plates. These longer screws can be used to penetrate into the adjoining wall studs by at least one inch and thereby possibly limiting excessive movement of the strike plate when forced. Using metal plates or hardwood helps strengthen the door jamb. If there are air gaps between the door jamb and the adjoining wall stud, the addition of shims will strengthen the door frame system. Longer-throw door bolts [1 in (250 mm)] are better than standard shorter-throw door bolts [½ in (125-mm)].

FIGURE 7-2. TOP VIEW DOOR FRAME SYSTEM

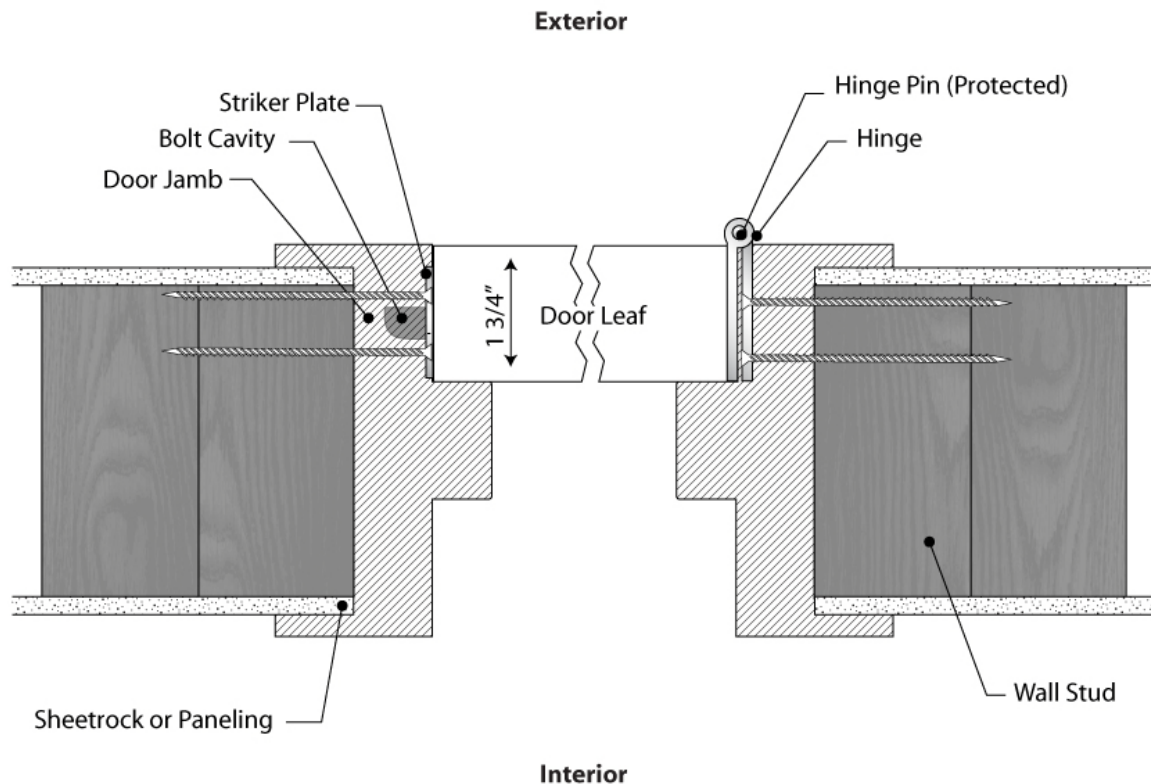

- I-70: Office Construction. The walls, floor, and ceiling of the HRP office and command suite should be made of permanent construction materials. Walls should be extended from true floor to true ceiling.

7-3.5 OFFICE CONSTRUCTION MATERIALS

Forced entry is a six-sided problem as illustrated in Figure 1-3. To offer resistance and evidence of unauthorized entry, I-6O recommends the walls, floor and ceiling to be made of permanent construction material. Examples of permanent construction material include plaster, gypsum wallboard, metal panels, hardboard, wood, and plywood. An allowed equivalent material is 18-gauge expanded steel screen.

- I-80: CCTV. Consider use of CCTV to allow security personnel to assess the perimeter of the command suite.

7-3.6 INTERIOR CCTV SYSTEM

To help detect unusual events and behavior in the area immediately around the HRP command suite, CCTV coverage is recommended.

7-4 RESIDENCE BUILDING-INTERIOR RECOMMENDATIONS

Interior recommendations address fire protection (I-9R) and IDS (I-10R).

7-4.1 FIRE PROTECTION

- I-9R: Fire Protection System. Provide a fire protection system for the HRP residence as follows:
 - Sprinklers: Sprinklers are required for all new construction per NFPA 101 and the International Residential Code (IRC) and are recommended for renovations.
 - Smoke Detection: Provide smoke alarms that comply with UL 217 or UL 268, as applicable, and are installed in accordance with NFPA 72. The smoke alarms should be capable of being connected to the security panel. Smoke alarms that are connected to the security panel must send a signal to a constantly attended location.

Recommendation I-9R references requirements for sprinkler systems from NFPA 101 and the IRC. The IRC is a stand-alone residential code, which establishes minimum regulations for one-story and two-story dwellings and townhouses up to three stories. Smoke alarms not only provide notification to the residence occupants but can provide an alert to a Dispatch Center as well. One way of providing remote notification to a remote 24/7 Dispatch Center is by taking an output from the smoke detector as a digital input to the IDS described below.

7-4.2 IDS

- I-10R: Intrusion Detection System (IDS). Provide an IDS inside the HRP residence as follows:
 - Low Level of Protection (LLOP): (a) Monitor all operable exterior openings with point sensors. (b) Provide a duress alarm in the HRP bedroom, the Safe Room/Haven, and the HRP's office in the residence. Consider the use of both fixed (wired) and wireless to provide flexible coverage and use by occupants. (c) Connect the IDS to a Dispatch Center.
 - Medium Level of Protection (MLOP): Provide LLOP criteria and provide volumetric IDS inside the residence.
 - High Level of Protection (HLOP): Provide MLOP criteria and provide two means of communication between the IDS and Dispatch Center.

Table 7-1 summarizes the HRP residence IDS recommendations. IDS' are automated systems that alert building occupants and response force when one or more intruder(s) has breached the building exterior and are inside the residence. Depending on the threat level and level of protection required, a variety of design criteria for the IDS can be employed. For basic protection, provide point sensors (balanced magnetic sensors) on operable openings, such as doors, windows, and skylights. The additional safeguard of providing duress alarms at key locations is also a good practice. The IDS system

should be connected to a central controller, which alerts building occupants and sends an alarm signal to response forces. For higher levels of protection, volumetric sensors such as dual-technology motion sensors or infrared beam pattern devices can be employed. At this level, the IDS designer has to take into account normal functional traffic with a system that is meant to detect principally nighttime intruders. The system can be set up in two modes of operation. In the unoccupied mode, the volumetric sensors are turned on when the HRP or family members are away from the residence for an extended period of time. A more advanced form of protection is to activate the system across corridors and stairwells leading to the HRP bedroom. Some means of silencing the system or bypassing would be recommended to accommodate the midnight snack run to the kitchen. For higher level of protection, some means of securing the communication link between the IDS and the Dispatch Center is recommended. The normal mode of communication is usually a leased telephone line that may be subject to compromise, such as clipping the communications cables. Options for establishing a secure communications link vary from hardened dedicated conductors, to encrypted VHF communications. Refer to Chapter 4 for recommendations on adding IDS to the ground of the residence for exterior intrusion detection. For more information on IDS, refer to the ESS UFC 4-021-02NF.

Table 7-1. IDS for HRP Residences

Level of Protection		
Low	Medium	High
<ul style="list-style-type: none"> • Monitor all exterior door and windows with point sensors. • If the residence is equipped with skylights, IDS should be mounted below the skylight. • Provide a duress alarm in HRP bedroom, the Safe Room/Haven, and residential office. • Interface the fire alarm system with the IDS to send a signal to Dispatch Center. 	<ul style="list-style-type: none"> • Monitor all exterior door and windows with point sensors. • If the residence is equipped with skylights, IDS should be mounted below the skylight. • Provide a duress alarm in HRP bedroom, the Safe Room/Haven, and residential office. • Interface the fire alarm system with the IDS to send a signal to Dispatch Center. • Provide volumetric IDS inside the residence. 	<ul style="list-style-type: none"> • Monitor all exterior door and windows with point sensors. • If the residence is equipped with skylights, IDS should be mounted below the skylight. • Provide a duress alarm in HRP bedroom, the Safe Room/Haven, and residential office. • Interface the fire alarm system with the IDS to send a signal to Dispatch Center. • Provide volumetric IDS inside the residence. • Provide two means of communication between the IDS and Security Dispatch Center.

7-5 RESIDENCE BUILDING-INTERIOR GOOD PRACTICES

7-5.1 HRP BEDROOMS

The master bedroom is best located on the top floor for two reasons. First, the higher location provides additional delay time (admittedly, seconds) against intruders ascending the floors from ground level. Additionally, in cases where there is an additional floor above the HRP bedroom, there is less awareness of possible roof penetrations, and the “semi-empty” guest floor could offer concealment for stay-behind intruders. Since few residents wish to climb or descend more than one flight of stairs to enter, leave, or greet visitors at a residence, it is not uncommon for the master bedroom to be located on the second floor of a three-story residence.

7-5.2 GUARD FORCE RESTROOM

When a PSD is assigned or likely could be assigned, appropriate restroom facilities should be planned for. For privacy reasons, certain restrooms such as the master bathroom and other restrooms for family members are not appropriate facilities for the PSD to utilize. If selecting a new residence or when starting a new lease, consideration should be given to the guard force restroom separate from that of the HRP or family. The restroom would be best segregated from other public restrooms to minimize the possibility of assailant attack. For privacy and security reasons, it would be best to have separate guest restrooms and guard force restrooms.

CHAPTER 8 - SAFE ROOM/HAVEN

8-1 OVERVIEW

This chapter provides an elaboration of the Haven (H) recommendations summarized in Chapter 2. The most internal and secure space for a protected property is the internal Safe Room or Safe Haven. It is the last layer of defense against assault by intruders. At a minimum, a Safe Room is a room with a hardened door. For this UFC, a Safe Haven is defined as a building space to which six-sided hardening of the floor, ceiling, and walls has been applied. Possible locations for Safe Room/Haven locations in residences and offices are presented along with design criteria and solutions for boundary hardening, space allowances, route considerations, communication systems, and utility needs.

8-2 COMMON RECOMMENDATIONS

- H-1C: Safe Room/Haven. A Safe Room or Safe Haven should be provided for the HRP at both the office and the residence.

8-2.1 SAFE ROOM COMMENTARY

As a basic form of executive protection, a Safe Room is recommended. The Safe Room provides additional physical protection (delay factors) to the HRP from assault by intruders. The Room/Haven should be located close to the HRP office or HRP bedroom. Ideally, the Room/Haven is located immediately adjacent to the office or bedroom. The time it takes to get into the Safe Room/Haven and secure it should be on the order of seconds. The escape path to the Safe Room/Haven should not cross the expected threat axis. The threat axis is the probable intruder and assault path, which for a residence would be the ground level floor.

8-2.1.1 Case Study H-1

An HRP residence has two spaces being considered for a Safe Room. One space is a room located immediately adjacent to the master bedroom on the second level. The alternate space is a basement located below ground on the basement level. While the basement location offers a higher level of hardening due to the masonry walls and outside earth barriers, the better location is the room off of the master bedroom. The reason is the increased risk the HRP would face in transiting from the master bedroom down two flights of stairs to get to the basement level (Paths B1, B2, and B3 in Figure 8-1). In traveling downstairs, the HRP would have to cross the ground level, which is the probable intrusion point for assailants. An alternate scheme would provide the room off the master bedroom as a Safe Room and the basement as a Safe Haven. The Safe Haven would only be used if there is sufficient pre-alert notification time to allow the HRP to travel to the basement level before intruders got into the HRP residence. Figure 8-1 on the next page illustrates some case study concepts on selecting a Safe Room/Haven location.

FIGURE 8-1. H-1 CASE STUDY FIGURE

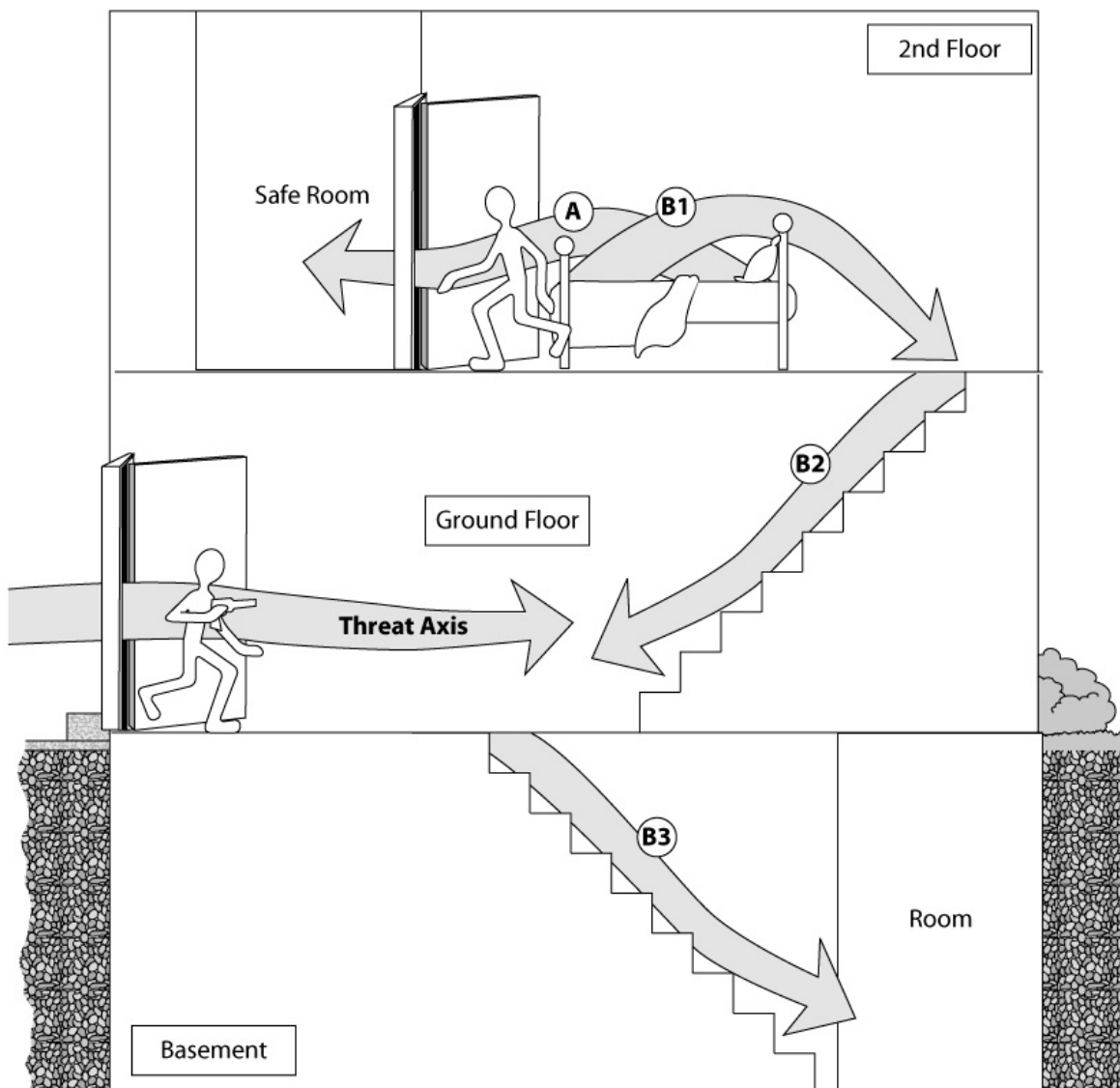

8-2.1.2 Safe Room Attributes

The recommended minimum attributes for a safe room are: (1) a hardened solid door, jamb, door hardware, and locks, (2) a duress alarm, (3) either no windows or window hardening, (4) no more than two entry doors, (5) a means of communication, (6) storage for bottled water (7) 10 ft² (1 m²) for each person who will occupy the room, and (8) an internal light source.

8-2.1.3 Entry Door

Provide a solid wood or metal entry door. While a solid door is a good initial step, the door frame and jamb should be reinforced such that they are made of material at least 1 in (260 mm) thick. The door should be provided with locking hardware. Locking

hardware can be a deadbolt, drop bar, sliding lock, or similar locking method. The entry door should normally be left open to allow unobstructed entry. An additional enhancement for the entry door is to disguise the door such that it is not obvious that it exists. Methods for disguising the safe room door include application of a large mirror façade that swings over safe room entry. Other methods incorporate creative ornamental wood to disguise the door. For illustrations of a simple sliding lock, refer to Figure 8-2. Figure 8-3 displays a robust locking system; whereas, Figure 8-4 illustrates of a door pin locking system. Table 8-1 summarizes the attributes of a Safe Room entry door.

Table 8-1. Safe Room Entry Door Attributes

Door is made of solid material
Door frame and jamb are reinforced
Door is provided with locking hardware
Door is normally left open, when not in use
Number of entry doors limited to one or two

FIGURE 8-2. SIMPLE SLIDING LOCK

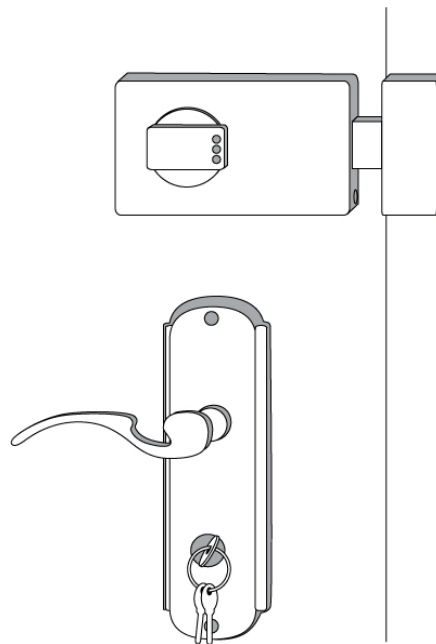

FIGURE 8-3. ROBUST INTERNAL LOCKING DOOR

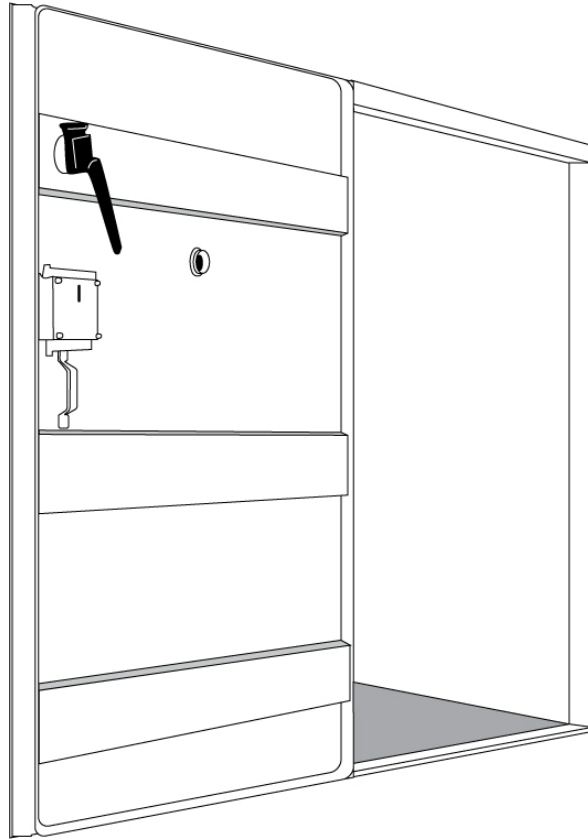
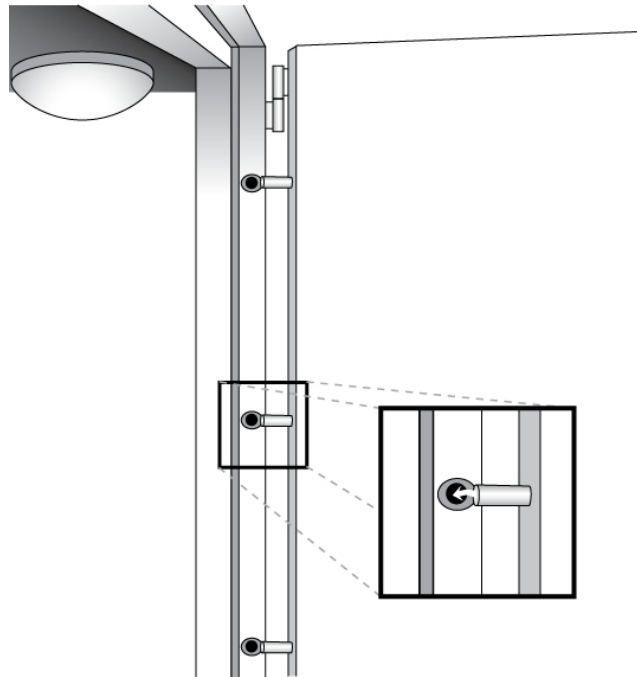

FIGURE 8-4. SECURITY DOOR PINS



8-2.1.4 Duress

A Safe Room/Haven duress alarm is the means to call for help or establish communication with outside response forces. The communications with security/police must be direct, fast, and capable of being used in a stressful, chaotic situation. Options for providing duress alarms include: (a) a dedicated cell phone or walkie-talkie with Safe Room/Haven chargers inside the room, (b) a separate dedicated landline telephone, and (c) a hardwired duress button that acts as a digital input to the IDS system for signal transmission to the offsite Dispatch Center.

8-2.1.5 Windows

As a basic recommendation, the Safe Room should have no windows. If there is an existing building with a window, the Safe Room/Haven window should meet Standard 10 of UFC 4-010-01.

8-2.1.6 Location Options for Safe Rooms

Bathrooms, walk in closets, and dressing rooms are all potential locations for a safe room. The safe room should be directly accessible from the HRP office or master bedroom. Additionally, the safe room should have only one entry door and have screening from the exterior by not having windows (recommended) or obscured glazing. The advantage of bathrooms is they have a source of water and toilet facilities.

- H-2C: Layers of Protection. To provide defense in depth, it is recommended that an additional adjacent door be hardened.

8-2.2 ADJACENT DOOR

Hardening the next adjacent outer door provides additional delay time against intruders. The adjacent door can be a master bedroom door or an outer office door as illustrated in Figure 8-5. When two doors are provided the time delay for both doors should be considered when working to achieve a delay time based on the design basis threat.

FIGURE 8-5. HARDENING AN ADDITIONAL DOOR

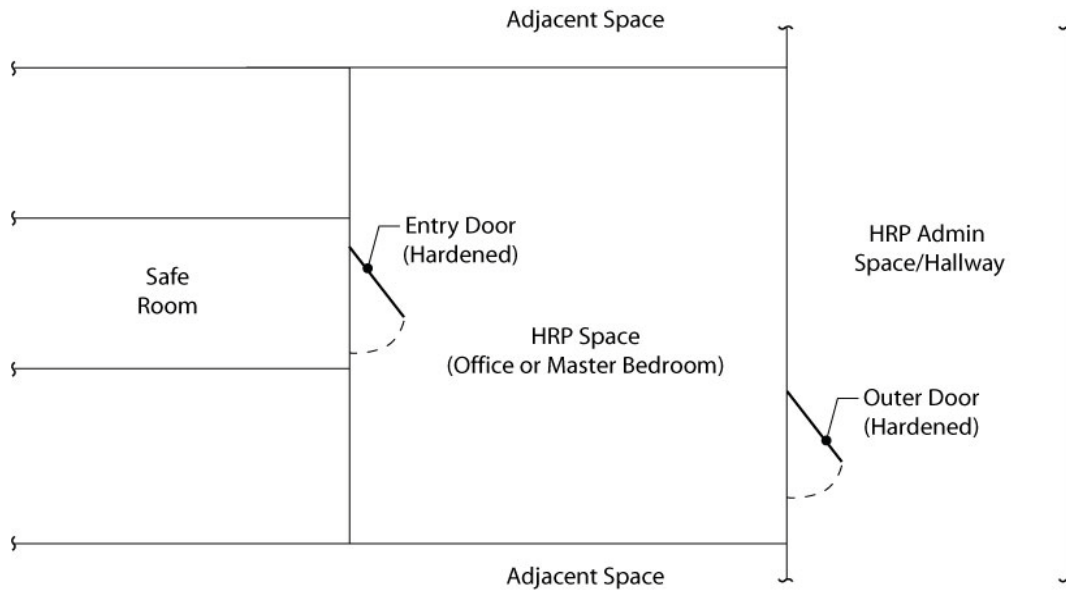

- H-3C: Safe Haven. For a high level of protection, a Safe Haven with hardened boundaries is recommended.

8-2.3 SAFE HAVEN

For HRP that require a high level of protection, additional protection measures should be implemented. The Safe Haven should have the same attributes of a Safe Room, but should be hardened for the forced entry tactic. The safe haven boundaries (floor, ceiling, and four walls) should be hardened to provide greater delay than the response time of security forces

8-2.3.1 Forced Entry Protection

The delay time recommended by attribute S-3C (Chapter 3) is 15 minutes. It is difficult to achieve a 15-minute resistance to forced entry without installing vault doors, which may not be practical. The key is to maximize the delay time to breach the Safe Haven. The Safe Haven boundaries should be hardened to resist forced entry—ideally, at least as long as time required for response forces to dispatch and arrive at the HRP site. The assumed basis for the response time is the assailants are using hand tools such as a crowbar or small sledge hammer. Additional consideration should be given to any duct and pipe penetrations such that the penetrations do not constitute a weak point to the surrounding perimeter boundaries.

8-2.3.2 Methods of Construction

There are two primary means to construct a Safe Haven in an existing building. The first option involves reinforcing the existing walls, floor and overhead (six-sided problem) to

an appropriate forced entry/ballistics resistance standard. The second method involves the internal erection of a modular Safe Haven in a larger room or space.

8-2.3.4 Additional References

For additional guidance on Safe Room/Haven hardening, refer to UFC 4-023-07, *Design to Resist Direct Fire Weapons Effects* and UFC 4-026-01, *Security Engineering: Design to Resist Forced Entry* (currently in Draft).

8-3 ADDITIONAL SAFE ROOM/HAVEN CONSIDERATIONS

8-3.1 SECURE COMMUNICATIONS

For a high level of protection, a secure communications link is recommended. Options include either a secure VHF radio, a physically protected phone line that is directly connected to both the local police and nearest U.S. security force, cell phones or walkie-talkies to a monitored station.

8-3.2 NO EXTERIOR WALLS

A good practice is to have no exterior walls on the Safe Room. This eliminates a direct path for ballistics intrusion as shown in Figure 8-6.

FIGURE 8-6. EXTERIOR WINDOWS/WALLS ON A SAFE ROOM

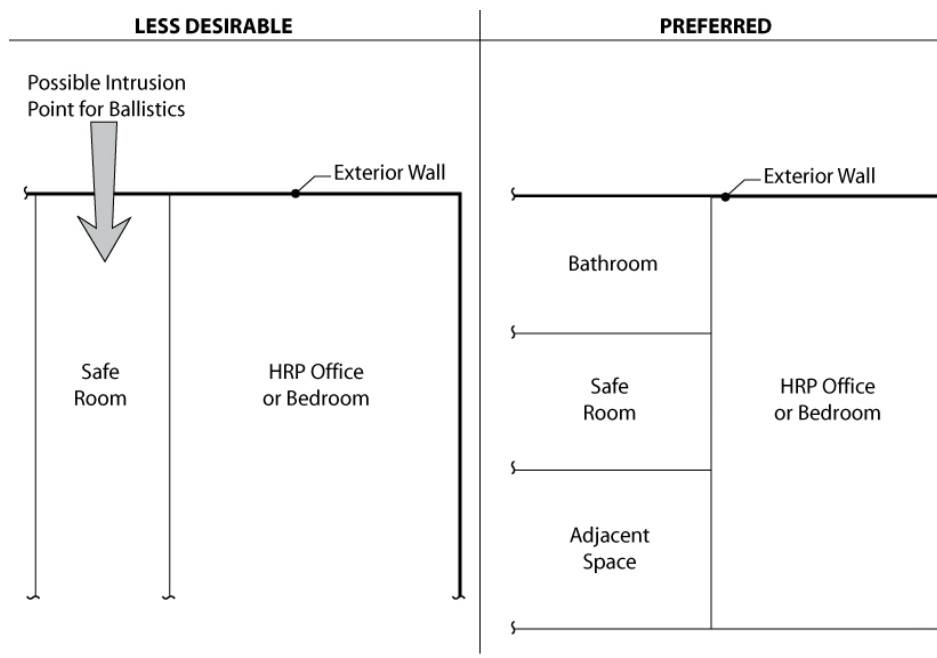

CHAPTER 9 - ADMINISTRATIVE IMPACTS ON FACILITY REQUIREMENTS

9-1 OVERVIEW

While the focus and scope of this document is on the physical facility attributes of HRP offices and residential spaces, any security solution includes administrative and operational interfaces. This chapter reviews issues of leased space challenges, congressional limits for residential improvements, host nation agreements, historic preservation issues, and response force interfaces.

9-2 LEASED SPACE CHALLENGES

There are several cases of HRP residences being leased properties. A challenge with not being the building owner is getting recommended security improvements made. Modifications to lease agreements may be required to implement protective measures for leased spaces.

9-3 CONGRESSIONAL LIMITS FOR RESIDENTIAL IMPROVEMENTS

The Military Appropriations Act, 2004 (Public Law 108-132, November 22, 2003) carried forward a 10 USC 2821 note that limits annual spending for the maintenance or repair of any general or flag officer quarters as a general provision. The law states that no more than \$35,000 may be spent on an annual basis without 30 days advance prior notification to the appropriate committees of Congress. The contracting officer should coordinate security upgrades with the annual \$35,000 repair and operation budget, or ensure the 30-day advance notification is made.

9-4 HISTORIC PRESERVATION ISSUES

HRP residences have a propensity to be located in historic areas and thereby subject to historic preservation issues or architectural review. This reality provides the security professional some formidable challenges for making changes. For example, a security upgrade to laminate windows with polycarbonate film may conflict with a prohibition from altering 19th century glass in a historic home. With the passage of the National Historic Preservation Act (NHPA) in 1996, Congress has made the Federal government and its agencies full partners and leaders in historic preservation. The DoD is among those organizations, having a number of federal historic preservation officers working for it, and according to Section 106 – Protection of Historic Properties of the NHPA, the DoD is required to take into account the effects of its undertaking on historic properties. Historic preservation mandates may also exist in foreign countries. In order to best establish a security project budget and schedule for a historic premise, early planning and evaluation of criteria should be conducted prior to concluding budgetary scope parameters.

9-4.1 PROCESS IN THE UNITED STATES

The Advisory Council on Historic Preservation (ACHP) is an organization that is guaranteed a reasonable opportunity to comment on the actions of the federal agencies. ACHP is, in fact, encouraged to integrate the Section 106 process into the earliest stages of its planning and to coordinate the necessary efforts as appropriate with other authorities' reviews required for the undertaking.

The determination of whether such an undertaking exists is the agency's (federal) official decision, which must be publicly communicated. Then, in compliance with the process outlined in the Regulation to Section 106, DoD must determine whether the undertaking is a type of activity that could affect historic properties, so defined either because they are included in the National Register of Historic Places or simply because they meet the criteria for the National Register. DoD has the responsibility to meet the requirements of Section 106 and to make sure that it can fund the related activities.

DoD, in consultation with the identified State Historic Preservation Officers (SHPO), must make an assessment of adverse effects on the identified historic properties, based on criteria found in ACHP's regulations. If ACHP agrees that there will be no adverse effect, DoD can proceed with the undertaking and any agreed-upon conditions. If ACHP finds that there is an adverse effect, or if ACHP and DoD cannot agree, DoD must begin consultation with SHPO and possibly local municipalities to seek ways to avoid, minimize, or mitigate the adverse effects. The consultation between DoD and SHPO usually results in a Memorandum of Agreement (MOA), which outlines the agreed-upon measures that DoD will take. In some cases, the consulting parties may even agree that no such measures are possible, but that the adverse effects must be accepted in the public interest.

9-4.2 ADVERSE EFFECTS

Adverse effects can be defined as property physical damage, alteration including restoration, rehabilitation, repair, maintenance, stabilization, provision of handicapped access, and change of character, up to the introduction of visual, atmospheric, or audible elements that diminish the integrity of the property. Another definition of an adverse effect can be found whenever an undertaking may alter, directly or indirectly, any of the characteristics of a historic property that qualify it for inclusion in the National Register in a manner that would diminish the integrity of the property's location, design, setting, materials, workmanship, feeling, or association.

9-4.3 PROGRAMMATIC APPROACH

Alternate procedures may be developed by DoD if compliant with the ACHP regulations. Programmatic exemptions can also be established as methods to shorten the review from the ACHP—if applicable to a category of properties—such as using similar or repetitive agreements on several historic properties or on a complex. Often, historic preservation addresses buildings to remain in existing "use." However, if the use of the property is changed, (such as from residence to office), the design professional should

consider (early in the project process) the historic preservation of existing materials and finishes, yet address the building with a holistic approach that meets new requirements while adapting to the change in use. Examples would include a need for additional square footage that is commensurate with the historic nature of the existing building, the contextual environment, and creative design parameters.

9-5 RESPONSE FORCE INTERFACE

Response forces may be DoD, host nation armed services or governmental agency, local law enforcement, or contracted private-sector response.

APPENDIX A - REFERENCES

DEPARTMENT OF DEFENSE

Department of Defense (DoD)	DoD Instruction 5200.1-R Information Security Program
	DoD Instruction O-2000.22 Designation and Physical Protection of DoD High Risk Personnel (HRP)
Department of Defense's Unified Facilities Criteria Website	UFC 3-530-01 Design: Interior and Exterior Lighting and Controls
	UFC 3-600-01 Fire Protection Engineering for Facilities
	UFC 4-010-01 DoD Minimum Antiterrorism Standards for Buildings
	UFC 4-010-02 DoD Minimum Antiterrorism Standoff Distances for Buildings (FOUO)
	UFC 4-020-01 DoD Security Engineering Facilities Planning Manual
	UFC 4-021-02NF Security Engineering: Electronic Security Systems
	UFC 4-022-01 Security Engineering: Entry Control Facilities / Access Control Points
	UFC 4-022-02 Selection and Application of Vehicle Barriers
	UFC 4-023-07 Design to Resist Direct Fire Weapons Effects
	UFC 4-026-01 Security Engineering: Design to Resist Forced Entry (currently in Draft)
	DoD 0.2000.12-H, DoD Antiterrorism Handbook

DEPARTMENT OF STATE

United States Department of State	Security Guidelines for American Families Living
-----------------------------------	--

APPENDIX B - GLOSSARY

ACRONYMS AND ABBREVIATIONS

ACHP—Advisory Council on Historic Preservation (US)

CCTV—Closed-Circuit Television

DIA—Defense Investigative Agency

DoD—Department of Defense

DoS—Department of State

ESS—Electronic Security System

GCC—Geographic Combatant Commander

HRP—High-risk Personnel

HVAC—Heating, Ventilation, and Air Conditioning

IDS—Intrusion Detection Sensors

MOA—Memorandum of Agreement

NATO—North Atlantic Treaty Organization

NFPA—National Fire Protection Association

NHPA—National Historic Preservation Act

PPO—Protective Providing Organization

PSD—Protective Service Detail

PSVA —Personal Security Vulnerability Assessment

PTZ—Pan, Tilt, Zoom

SCIF—Special Compartmented Information Facility

SHPO—State Historical Preservation Offices (US)

VBIED—Vehicle Born Improvised Explosive Device

DEFINITION OF TERMS

Clear Zone. An unobstructed area on both sides of a perimeter barrier. A clear zone is kept free of rubbish, weeds, bushes, trees and other material that might conceal anyone attempting to climb, tunnel or cut through a perimeter barrier.

Closed-Circuit Television (CCTV) System. The system that allows video assessment of alarm conditions via remote monitoring and recording of video events.

Controlled Perimeter. For the purposes of these standards, a physical boundary at which vehicle access is controlled at the perimeter of an installation, an area within an installation, or another area with restricted access. A physical boundary will be considered as a sufficient means to channel vehicles to the access control points. At a minimum, access control at a controlled perimeter requires the demonstrated capability to search for and detect explosives. Where the controlled perimeter includes a shoreline and there is no defined perimeter beyond the shoreline, the boundary will be at the mean high water mark.

Dispatch Center. The space that serves as a central monitoring and assessment facility for the access control system, closed-circuit television system, and intrusion detection system. Normally, the Dispatch Center is staffed 24 hours a day, seven days a week by trained personnel. Other names for the Dispatch Center include Security Operations Center (SOC), Security Command Center and Security Control Center (SCC), and Central Monitoring Station.

Electronic Security System (ESS). The integrated electronic system that encompasses interior and exterior Intrusion Detection Systems (IDS), Closed-Circuit Television (CCTV) systems for assessment of alarm conditions, Access Control Systems (ACS), Data Transmission Media (DTM), and alarm reporting systems for monitoring, display, or control.

High-risk Personnel. Personnel who are likely to be terrorist or criminal targets based on their grades, assignments, symbolic values, criticalities, and threat and vulnerability assessments. Examples of HRP include Geographic Combatant Commanders (GCC), key North Atlantic Treaty Organization staff, and personnel designated as HRP by GCC.

Iconic. Displaying the character of or relating to the image of an icon (image).

Intrusion Detection System (IDS). A system consisting of interior and exterior sensors, surveillance devices, and associated communication subsystems that collectively detect an intrusion of a specified site, facility, or perimeter and annunciate an alarm.

Level I. Refers to a HRP level. An individual who requires continuous protection by a PSD as recommended by a PSVA.

Level II. Refers to a HRP level. An individual who requires additional degrees of protection during periods of official duty or travel as recommended by a PSVA. The additional degrees of protection include PSD support, but not on a continuous basis.

Level III. Refers to a HRP level. An official who requires advanced individual antiterrorism awareness and personal protection training.

Physical Protection System, Physical Security System. Means of preventing unauthorized physical access to a system, such as fences, walls, locks, sensors, or surveillance.

Protective-Providing Organization (PPO). (Taken from DoDI 2000.22) Refers collectively to the U.S. Army Criminal Investigative Command, the Naval Criminal Investigative Service, the U.S. Air Force Office of Special Investigations, the Defense Criminal Investigative Service, the Pentagon Force Protection Agency, and the National Security Agency.

Protective Service Detail (PSD). (Taken from DoDI 2000.22) Trained and armed protective security officials capable of providing continuous protection for a designated individual.

Protective Security Vulnerability Assessment (PSVA). (Taken from DoDI 2000.22) An assessment to determine the vulnerability of an attack against a particular individual. Identifies specific areas of improvement to withstand, mitigate, or deter acts of violence or terrorism against the individual.

Response Forces. The back-up security forces in addition to the on-duty protective service detail staff member (bodyguard) that respond to an emergency.

Safe Haven. A hardened, inner building space that is the last barrier of defense (physical protection) against intrusion by assailants. A Safe Haven has had special hardening applied to all six axis angles to include the floor, ceiling and four walls to resist forced entry. A Safe Haven affords a higher level of protection than a Safe Room.

Safe Room. An inner room, which is the last barrier of physical protection against intrusion by assailants. A Safe Room has a hardened entry door to resist forced entry and ideally has no windows or exterior walls. A Safe Room does not have the special hardening of the floor, ceiling, and four walls that a Safe Haven has. An HRP office or residence would typically have either a Safe Room or a Safe Haven, but not both.

Standoff Distance. A distance maintained between a building a building or portion thereof and the potential location for a weapon or explosive detonation. *Taken from UFC 4-020-01.*

Unobstructed Space. Space within 33 ft (10 m) of an inhabited building that does not allow for concealment from observation of objects 6 in (150 mm) or greater in height.

APPENDIX C - RESIDENCE SURVEY
EVALUATION COVER SHEET

Residence Address:	
HRP:	
Date of Survey:	
Survey Team Members Member #1: Member #2: Member #3:	
	Significant Notes
Site Location	
Property Perimeter	
Property Grounds	
Building Exterior	
Building Interior	
Safe Haven	

Residence Survey—External Zone/Site Location

Item #	Attribute	Meets (Yes/No)	Notes/Reasons for Noncompliance	Comments/Mitigation Options	Budgetary Cost to Upgrade
S-1C	The property has a minimum of two entrance and egress routes.				
	a. Routes to the site do not have narrow or one-way streets.				
S-2C	There is a secure location to park HRP vehicle(s) when not in use.				
	a. The secure location is equipped with an IDS, or				
	b. The secure location is guarded or within sight lines of an existing guard post.				
S-3C	The property is located within 15 minutes of dispatch response forces.				
S-4C	The residence is on a DoD, DoS, NATO Compound, or host nation military installation.				
S-6R	The residence is not located in neighborhoods with iconic structures or organizations that might attract violent political activity or demonstration.				
S-7R	The architecture and lighting levels of the building and lighting level should blend into the surrounding area.				
	a. Aggressors should not be able to pick out the residence just from its appearance.				

Residence Survey—External Zone/Site Location

Item #	Attribute	Meets (Yes/No)	Notes/Reasons for Noncompliance	Comments/Mitigation Options	Budgetary Cost to Upgrade
S-8	The property does not greatly increase the HRP's commute time or exposure to threats on routes to and from the office location.				
S-9	Police, fire and health services are close-by – preferably within 15 minutes.				
S-10	The residence is in a low crime area.				
S-11	Preferably, there is no unobstructed vehicle approach perpendicular to the residence.				
				1. Subtotal: Site	

Residence Survey—Property Perimeter

Item #	Attribute	Meets (Yes/No)	Notes/Reasons for Noncompliance	Comments/Mitigation Options	Budgetary Cost to Upgrade
P-1C	Subterranean openings are impassable or are less than 96 in ² (619 cm ²).				
	a. Openings larger than 96 in ² use single or multiple grates.				
	b. If physical protection standards cannot be met, does the opening have intrusion detection devices to prevent unauthorized entrance?				
P-2R	The property boundary is encircled with a physical barrier such as a fence, curb or vegetation to establish criminal intent.				
	a. Higher level: Driveway is gated.				
	b. Higher level: 6' fence or wall.				
P-3R	A capability to view the egress routes in advance of exiting is established.				
P-4R	The number of vehicle access points to the residence is minimized.				
P-5R	CCTV is installed to view threats around the residence and perimeter.				
P-6R	Outdoor IDS is provided for early detection.				
					Subtotal: Property Perimeter

Residence Survey—Property Grounds

Item #	Attribute	Meets (Yes/No)	Notes/Reasons for Noncompliance	Comments/Mitigation Options	Budgetary Cost to Upgrade
G-1R	The standoff distance of the property is a minimum of 100 ft (33 m) from public streets or uncontrolled vehicle parking.				
G-2R	Pickup/Drop-off areas and high-visibility windows are concealed or screened from external vantage points?				
G-3R	Privately owned vehicle parking (POV) is in a controlled area.				
G-4R	Luminaries are provided at all entrance and exit locations.				
G-5R	Obstructions within 33 ft (10 m) away from the building exterior do not allow concealment of objects 6 in (15 cm) or greater in height.				
G-6R	Preferred. Is there space for a future guard booth or guard house?				
G-7R	Visitor parking is no closer than 33 feet (10 meters) from the residence?				
				Subtotal: Property Grounds	

Residence Survey—Building Exterior

Item #	Attribute	Meets (Yes/No)	Notes/Reasons for Noncompliance	Comments/Mitigation Options	Budgetary Cost to Comply
E-1C	The residence is less than three stories in height above grade (fire truck consideration).				
	a. The master bedroom is located on a floor above ground.				
E-2C	Windows are lockable from the inside.				
E-3C	The residence has a manageable number of exterior doors.				
E-4C	The unglazed portions of exterior doors are made of solid material such as metal or wood.				
E-5C	Exterior doors swing outward.				
E-6C	If exterior doors have hinges on the outside, countermeasures have been implemented to mitigate hinge removal or door tampering.				
E-7C	The exterior door jambs are a solid material at least 1 in (26 mm) thick or have been reinforced against forced entry.				
E-8R	The exterior doors have two locking mechanisms, such as a key lock and a dead bolt.				
	a. The deadbolt has a 1 in (26 mm) throw as a minimum.				
E-9R	Windows.				
	a. Meet Standard 10 of UFC 4-010-01, or				
	b. Hardened with fragment retention film?				
E-10R	Access to under building access points is				

Residence Survey—Building Exterior

Item #	Attribute	Meets (Yes/No)	Notes/Reasons for Noncompliance	Comments/Mitigation Options	Budgetary Cost to Comply
	hardened or controlled. (Crawl spaces/tunnels)				
E-11R	Roof access is controlled.				
	a. No exterior ladders.				
	b. If a ladder cannot be removed, is a means provided to prevent the ladder from being used as an intrusion path?				
E-12R	Residential Mailbox				
	a. Blank or secure mail-slots on the building exterior envelope.				
	b. Reposition a residential mailbox to at least 33 ft (10 m) away from the residence if it is not already.				
E-13R	Trash receptacles are a reasonable distance away from the residence?				
				Subtotal: Building Exterior	

Residence Survey—Building Interior

Item #	Attribute	Meets (Yes/No)	Notes/Reasons for Noncompliance	Comments/Mitigation Options	Budgetary Cost to Upgrade
I-1C	There are no skylights.				
I-2C	Furniture is located away from likely path of glass fragments or other projectiles?				
I-9R	New Construction: The residence has a fire protection system: a. Sprinklers required by NFPA/IRC b. Smoke detectors				
I-10R	The building has an intrusion detection system as follows:				
	LLOP: a. All exterior doors have point sensors				
	b. There is a duress alarm in the HRP bedroom.				
	c. There is a duress alarm in the Safe Room/Haven.				
	d. There is a duress alarm in the HRP residential office.				
	e. The IDS is connected to a Dispatch Center.				
	Medium LOP: LLOP IDS is present and volumetric sensors are provided in the residence.				
	High LOP: MLOP IDS is present and two means of communication is established between the IDS and the Dispatch Center.				

Residence Survey—Building Interior

Item #	Attribute	Meets (Yes/No)	Notes/Reasons for Noncompliance	Comments/Mitigation Options	Budgetary Cost to Upgrade
				Subtotal: Building Interior	

Residence Survey—Safe Haven

Item #	Attribute	Meets (Yes/No)	Notes/Reasons for Noncompliance	Comments/Mitigation Options	Budgetary Cost to Upgrade
H-1C	A Safe Room or Safe Haven has been provided with the following attributes:				
	a. The Safe Room door is a solid door.				
	b. There is a duress alarm in the room.				
	c. There are no windows or the windows have been hardened.				
	d. There are no more than two entry doors.				
	e. There is a means for outside communication such as cell phone or radio.				
	f. There is storage space for bottled water.				
	g. There is 10 ft ² for each anticipated occupant.				
	h. There is an internal light source.				
H-2C	An adjacent door is hardened (outside the Safe Room outer door)?				
H-3C	High LOP: A Safe Haven with hardened boundaries is recommended.				
				Subtotal: Safe Haven	