

PACKAGED STANDBY SYSTEM

INSTALLATION AND OPERATORS MANUAL

ULPSS12H2W/E

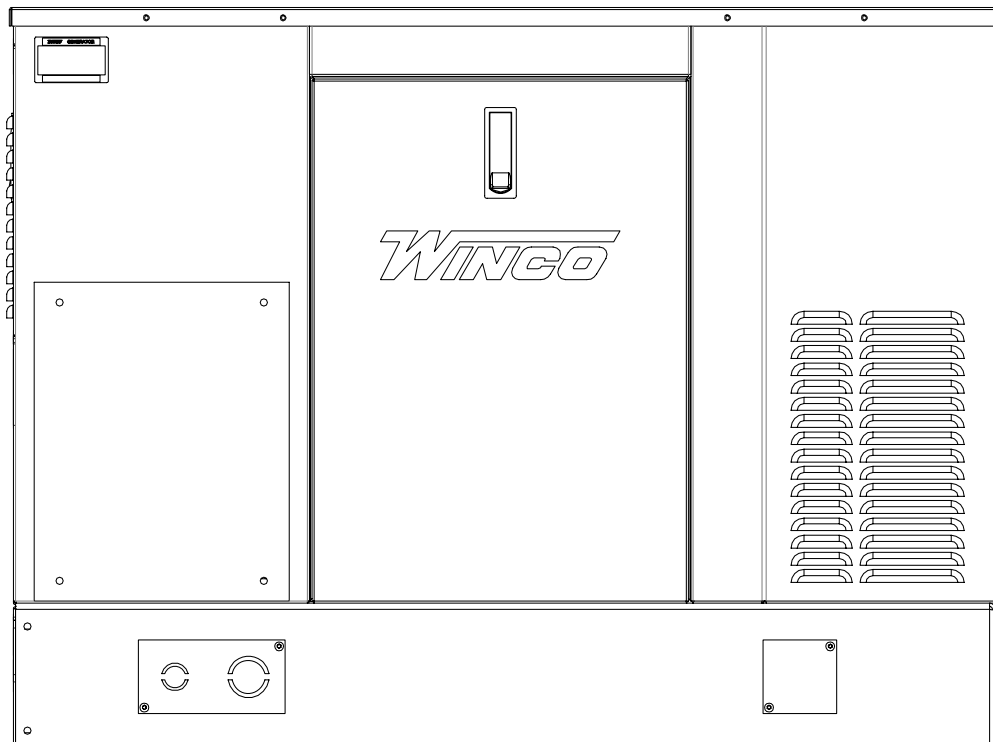

SAVE THESE INSTRUCTIONS

This manual contains important instructions that should be followed during installation and maintenance of the generator and batteries. Read and understand all instructions in the manual before starting and operating the generator set.

USING THE MANUAL

Congratulations on your choice of a Winco generator set. You have selected a high-quality, precision engineered generator set designed and tested to give you years of satisfactory service.

To get the best performance from your new engine generator set, it is important that you carefully read and follow the operating instructions in this manual.

Should you experience a problem please follow the "Troubleshooting Tables" near the end of this manual. The warranty listed in the manual describes what you can expect from WINCO should you need service assistance in the future.

TABLE OF CONTENTS

INTRODUCTION	2
GUIDE TO PRODUCT SAFETY	3
BASIC INFORMATION	
Description	4
Specifications	5
PREPARING THE UNIT	
Unpacking the Unit	5
GENERATOR SET INSTALLATION	
Installation	5
Fuel Installation	6,7
Fuel Conversions	6
Vapor Fuel Pressure Tables	8
Battery Installation	8
Connecting Battery Charger	11
TRANSFER SWITCH INSTALLATION	
AC Electrical Connections	11
DC Electrical Connections	12
INITIAL START UP	13
GENERATOR EXERCISER	14
DSE 3110 ENGINE CONTROL	15,16
FRONT PANEL CONFIGURATION	17
DSE 3110 FAULT CODES	18
MAINTENANCE	19
GENERATOR SET OUTLINE	20
GENERATOR SET PAD LAYOUT	21
TROUBLESHOOTING TABLES	22
AC & DC SCHEMATICS	23
12 MONTH WARRANTY	24

PROPER USE AND INSTALLATION

You must be sure your new engine generator set is:

- * Properly serviced before starting.
- * Operated in a well ventilated area.
- * Properly exhausted and gases safely dispersed.
- * Wired by a qualified electrician.
- * Operated only for its designed purposes.
- * Used only by operators who understand its operation.
- * Properly maintained.

COPY YOUR MODEL AND SERIAL NUMBER HERE

No other WINCO generator has the same serial number as yours. It is important that you record the number and other vital information here. If you should ever need to contact us on this unit it will help us to respond to your needs faster.

MODEL _____

SERIAL NUMBER _____

PURCHASE DATE _____

DEALER _____

DEALER PHONE # _____

SAFETY INFORMATION

This generator set has been designed and manufactured to allow safe, reliable performance. Poor maintenance, improper or careless use can result in potential deadly hazards; from electrical shock, exhaust gas asphyxiation, or fire. Please read all safety instructions carefully before installation or use. Keep these instructions handy for future reference. Take special note and follow all warnings on the unit labels and in the manuals.

ANSI SAFETY DEFINITIONS

DANGER:

DANGER indicates an imminently hazardous situation which, if not avoided, will result in death or serious injury. This signal word is to be limited to the most extreme situations.

WARNING:

WARNING indicates a potentially hazardous situation which, if not avoided, could result in death or serious injury.

CAUTION:

CAUTION indicates a potentially hazardous situation which, if not avoided, may result in minor or moderate injury. It may also be used to alert against unsafe practices.

NOTE:

CAUTION is also used on the unit labels and in this manual to indicate a situation that could result in serious damage or destruction of the equipment and possible personal injury.

1. ELECTRICAL SHOCK The output voltage present in this equipment can cause fatal electric shock. This equipment must be operated by a responsible person.

- a. Do not allow anyone to operate the generator without proper instruction.
- b. Guard against electric shock.
- c. Avoid contact with live terminals or receptacles.
- d. Use extreme care if operating this unit in rain or snow.
- e. Use only three-pronged grounded receptacles and extension cords.
- f. Be sure the unit is properly grounded to an external ground rod driven into the earth.

2. FIRE HAZARD Natural gas and L.P. present a hazard of possible explosion and/or fire.

- a. Do not refuel when the engine is running or hot. Allow the engine to cool at least two minutes before refueling.
- b. Keep fuel containers out of reach of children.
- c. Do not smoke or use open flame near the generator set or fuel tank.
- d. Keep a fire extinguisher nearby and know its proper use. Fire extinguishers rated ABC by NFPA are appropriate.
- e. Store fuel only in an approved container, and only in a well ventilated area.
- f. Follow local codes for closeness to combustible material.

3. DEADLY EXHAUST GAS Exhaust fumes from any gasoline engine contain carbon monoxide, an invisible, odorless and deadly gas that must be mixed with fresh air.

- a. Operate only in well ventilated areas.
- b. Never operate indoors.
- c. Never operate the unit in such a way as to allow exhaust gases to seep back into closed rooms (i.e. through windows, walls, floors).

4. NOISE HAZARD Excessive noise is not only tiring, but continual exposure can lead to loss of hearing.

- a. Use hearing protection when working around this equipment for long periods of time.
- b. Keep your neighbors in mind when permanently installing this equipment.

5. CLEANLINESS Keep the generator and surrounding area clean.

- a. Remove all grease, ice, snow or materials that create slippery conditions around the unit.
- b. Remove any rags or other materials that could create a potential fire hazard.
- c. Carefully clean up any gas or oil spills before starting the unit.

6. SERVICING EQUIPMENT All service, including the installation or replacement of service parts, should be preformed only by a qualified technician.

- a. Use only factory approved repair parts.
- b. Do not work on this equipment when fatigued.
- c. Never remove the protective guards, covers, or receptacle panels while the engine is running.
- d. Use extreme caution when working on electrical components. High output voltage from this equipment can cause serious injury or death.

- e. Always avoid hot mufflers, exhaust manifolds, and engine parts. They can cause severe burns instantly.
- f. Installing a generator set is not a “Do-it-yourself” project. Consult a qualified, licensed electrician or contractor. The installation must comply with all national, state, and local codes.

TESTING POLICY:

Before any generator is shipped from the factory, it is fully checked for performance. The generator is loaded to its full capacity, and the voltage, current and frequency are carefully checked.

Rated output of generators is based on engineering tests of typical units, and is subject to, and limited by, the temperature, altitude, fuel, and other conditions specified by the manufacturer of the applicable engines.

INTRODUCTION AND DESCRIPTION

The package standby system includes all times necessary for a completely automatic standby power system as standard equipment.

DESCRIPTION

The package standby system is designed to automatically provide standby power to unattended loads during electrical outages. Upon an interruption of normal electrical service the packaged standby system electrical control circuits will automatically start the engine. The generator will produce electrical power and the Automatic Transfer Switch (ATS) will automatically transfer the electrical loads to the generator set. Upon restoration of normal electrical service the emergency transfer switch will sense return of the normal commercial power. The Automatic Transfer Switch will retransfer the load back to the normal commercial power source. The engine control circuits will begin a cool-down cycle, after which the fuel supply will be shut off and the engine ignition system disabled.

These packaged standby systems consist of two major components:

1) AUTOMATIC TRANSFER SWITCH

A wall mounted ASCO 165 Automatic Transfer Switch (ATS) designed for inside installation. The transfer switch is UL1008 approved. A fourteen day electronic exerciser circuit is installed in the ATS as standard equipment. The ATS also contains the power failure sensing circuitry necessary to start and stop the engine generator set. The transfer switch is also equipped standard with a 3 second start delay, and a 15 second transfer delay to allow the engine to warm up before transferring the load to the generator. When the line power is restored the ATS has a 5 minute retransfer delay to allow the incoming utility to stabilize before transferring back to line power and then an additional 1 minute engine cool down delay before the engine shuts down. Read and understand the ATS owners manual before installing, servicing or operating the transfer switch.

UL Automatic Transfer Switch Sizes

UNIT	LINE SIDE CONTACTOR	GENERATOR SIDE CONTACTOR
ULPSS12H2W	100 AMPS	100 AMPS
	200 AMPS	200 AMPS

Both the 100 amp and the 200 amp UL Switches are available in single phase only.

2) ENGINE / GENERATOR

The engine generator set consists of a Honda, twin cylinder, four cycle air cooled engine. The engine is factory equipped to run on LP or NG fuel. The engine operates at 3600 rpm and frequency regulation is maintained by the engine governor within 4 cycles variation (62.5 Hz - 58.5 Hz) from no load to rated load. The generator is a brushless, single bearing, direct drive, rotating field design. The generator is connected to the engine's tapered (quill) crankshaft extension. The engine generator is mounted in a drip-proof enclosure for outside installation. Connection boxes and terminal blocks are provided for all customer connections (both AC output and DC control). A customer supplied 12 volt 500 CCA (BCI group 26) battery is required to complete the installation.

** NOTICE **

This unit will automatically transfer if a power outage occurs while running in an exercise mode.

SPECIFICATIONS

GENERATOR

MODEL	WATTS*	VOLTS	AMPS	HZ	PH	RPM
PSS12	12000	120/240	50.0	60	1	3600

* Derate 16% for Natural Gas operation. Derate to 7192 watts when operating on Natural Gas pressure of 4-6 inches water column. Derate 3.5% per 1000 feet elevation above sea level.

FUEL CONSUMPTION

NATURAL GAS 1000 BTU/CU FT		LP VAPOR 2520 BTU/CU FT
CF/HR	190	76.6
BTU/HR	190,000	194,000
GAL/HR	N/A	2.1
LBS/HR*	N/A	9.0

* Based on full load operation.

ENGINE SPECIFICATIONS

Refer to engine operating and maintenance instructions.

** NOTICE **

When unpacking the generator set, be sure to inspect it carefully for freight loss or damage. If loss or damage is noted at the time of delivery, require that the person making the delivery make note of the loss or damage on the freight bill, or affix his signature under the consignor's memo of the loss or damage. Contact the carrier for claim procedures.

When loss or damage is noted after delivery, segregate the damaged material, and contact the carrier for claim procedures. Be sure to retain the packaging material for carrier inspection.

"Concealed Damage" is understood to mean damage to the contents of a package which is not evident at the time of delivery by the carrier, but which is discovered later. The carrier or carriers are responsible for merchandise lost or damaged in transit. The title to goods rests with the consignee when generators are shipped F.O.B. factory, and only the consignee can legally file a claim. Please note, most carriers have a time limit for filing concealed damage claims.

**** CAUTION ****

These units are shipped with oil. Be sure to check oil levels before operating. See engine manufacturer's instruction manual for recommended oil requirements before initial starting.

UNPACKING

1. Carefully remove the carton.
2. After inspecting the engine-generator and transfer switch for external physical damage, check for the following items packed inside the carton.
 - a. Owner's manual.
 - b. Engine manufacturer's instruction manual.
3. Remove main frame hold down bolts. (4)
4. Unit can now be lifted from shipping pallet.

INSTALLATION

General Information

**** WARNING ****

Before proceeding with the installation be sure the operation selector switch is in the stop position.

These engine generator sets are designed to be mounted on a concrete pad outdoors only. As an option a prefab pad may be used as long as proper attention is paid to site preparation to insure the unit will not move after installation. The transfer switch is mounted next to your electrical entrance or distribution panel inside or outside the building. Consult a qualified, licensed electrician or contractor to install and wire the transfer switch. **The installation must comply with all national, state and local codes.**

Before beginning the installation process check the rating of the generator set and its transfer switch rating. Be certain they can handle the intended load and are compatible with the entrance voltage, phase and current ratings. Plans for installation should be prepared with proper attention to mechanical and electrical engineering detail to assure a satisfactory system installation. The information in this manual is offered only as a guide to finalizing your installation plans.

ENGINE GENERATOR SET MOUNTING

WARNING - Personal Injury

The enclosures on these units can become very hot adjacent to the exhaust areas. Special care must be taken when installing these units to insure that the risk of contact by people is minimized.

The unit's main frame should be bolted to a four to six inch thick cement pad. The engine-generator is mounted on a sub-frame which is isolated with special shock mounts on the main frame. This allows the engine-generator to vibrate without affecting the control panel on the main frame. (See page 20).

Do not install any shock mounts between the base frame and the concrete pad. Engine vibration will be transmitted to the control panel causing erroneous start/stop cycles and premature control failure.

The unit should be mounted to allow for ample working room around it. A general rule to follow is five (5) feet clearance on all sides. See NFPA Code 37 for additional clearance requirements.

FUEL INSTALLATION

The fuel supply should be as close as possible to the engine. This will reduce the installation cost of fuel runs. The information in this manual is offered to assist you in providing the proper fuel for your engine. However, this information is only provided to inform you of the engine's requirements and assist in making you aware of the decisions you must make. In no case should the instructions and information provided be interpreted to conflict with any local, state or national codes. If in doubt, always consult your local fire marshal, gas supplier or building inspector.

***** **WARNING** *****

FIRE HAZARD - All fuel runs should be installed by a licensed fuel supplier.

To connect the fuel line to the generator set you will connect your incoming fuel line to the 3/4 inch NPT fitting located on the left side of the engine-generator set. This fitting is shipped with a plastic plug installed to insure the fuel system stays clean.

For all vapor fuel systems the delivery pressure of the fuel to the fuel solenoid on the unit must be four to six ounces psi (per square inch) or 7 to 11 inches W.C. (water column).

These fuel pressures are critical; failure to provide the proper pressure can cause many problems ranging from a unit that will not start to causing damage to the fuel system.

These units are normally tested on Natural Gas and will have a fuel line connected to the NG port on the fuel outlet tee. If you are going to operate on LP you will need to move the fuel line from the NG port to the LP port on the fuel outlet tee. These two ports have different orifice inserts installed in them, which provide proper operation with no further adjustments.

When moving the fuel line from one port to the other be sure not to kink or bend the line. Use a large sweeping curve as possible and never shorten the fuel line. For proper operation the fuel line must stay the same length as it was shipped.

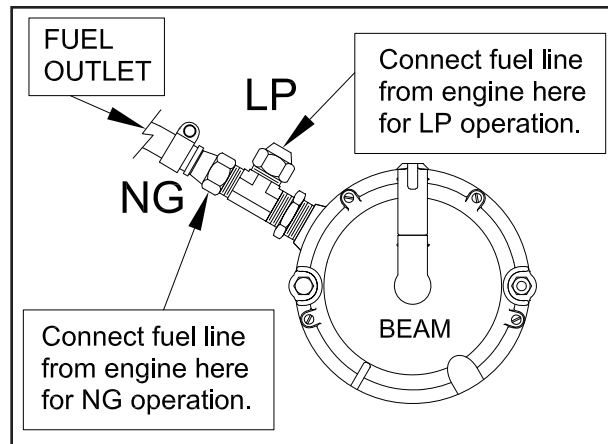

INSTALLING THE FUEL LINE

**** NOTICE ****

The engine generator sets are properly adjusted before they leave the factory. A tag is attached to the unit that specifies the fuel, natural gas (NG) or propane vapor (LP) that the unit was set up and tested on.

NATURAL GAS or LP VAPOR PIPE SIZE

Size of pipe normally required for generators operating on NATURAL GAS or LP VAPOR.

Unit location will determine the size of fuel line that is required to supply the engine with a constant fuel pressure and volume.

LIQUID PROPANE VAPOR (LP)

Refer to the tables below for fuel line size and recommended tank size. For distances of 100 feet or over, a two regulator fuel system is recommended. This is accomplished by installing a primary regulator at the tank which will reduce the tank pressure down to 10 to 15 lbs.

A low pressure regulator is installed to further reduce the fuel pressure to the required four (4) to six (6) oz. operating pressure. **This low pressure regulator must be at least 10 feet from the engine generator set, any closer installation will require a larger line be installed to provide a fuel reservoir.** This is also true for the single low pressure regulators, it should also be a minimum of 10 feet from the unit. If this is not done the demand regulator on the unit and the pressure regulator in the fuel line will interfere with each other. When the two (2) regulator system is used on LP, a fuel line size of 1/2 to 5/8 inch is generally adequate for distances up to 300 feet from the primary to the low pressure regulator. (Consult you local fuel supplier for your exact requirements). The appropriate line size from the table below is then installed from the low pressure regulator to the generator set.

FEET	SIZE OF PIPE
up to 25 FT*	3/4 " Pipe
25 - 100 FT*	1" Pipe
over 100 FT*	Use a two regulator system.

* Allow an additional 3 feet for each standard elbow. Do not use 'street ells' (restrictive).

NATURAL GAS (NG)

The primary regulator (fuel meter) on the building should deliver the correct volume and pressure to the generator set. This regulator must be sized to deliver the required BTU's to the generator set and all other appliances in the building. **If the primary regulator (fuel meter) is a high pressure regulator then a low pressure regulator must be installed to bring the pressure down to 4-6 oz. (7-11 inches water column) of pressure. This low pressure regulator must be at least 10 feet from the engine generator set, any closer installation will require a larger line be installed to provide a fuel reservoir.** If this is not done the demand regulator on the unit and the pressure regulator in the fuel line will interfere with each other. This regulator must be sized to accomidate the demand of the generator set and any other appliance connected to it. See table below for the correct size of pipe to be installed.

FEET	SIZE OF PIPE
up to 25 FT*	3/4 " Pipe
25 - 100 FT*	1" Pipe
over 100 FT*	Consult Factory

* Allow an additional 3 feet for each standard elbow. Do not use 'street ells' (restrictive).

****** WARNING ******

PERSONAL DANGER - Do not use galvanized pipe in fuel line runs. The galvanized coating can become eroded and flake off, causing possible obstructions in the regulator or fuel valve. The results could range from inoperative engine to hazardous fuel leaks.

****** CAUTION ******

Be careful when sealing gas joints. Excessive sealing compound can be drawn into the solenoid, regulator or carburetor causing an engine malfunction.

FUEL PRESSURE

LP & NG VAPOR FUEL Correct fuel pressure cannot be stressed enough. The most common cause for inoperative systems is an inadequate or incorrect fuel pressure. Performance of the engine is in direct relation to the correctness of the fuel system. Shown below is a diagram of a typical LP vapor fuel installation. Notice the following tables give two (2) different units of measuring fuel pressure. The first and most accurate is the use of a simple water manometer. A manometer is calibrated in inches of water column. The second is with a pressure gauge calibrated in ounces per square inch.

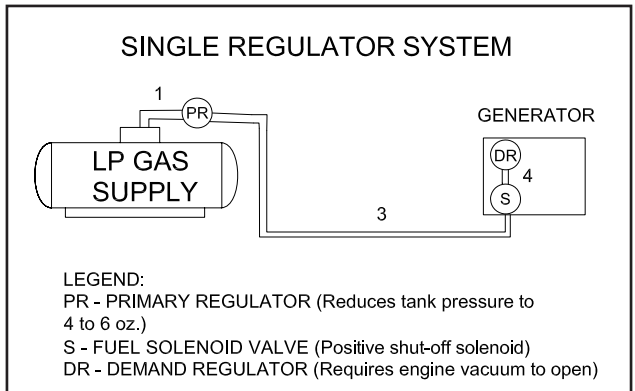
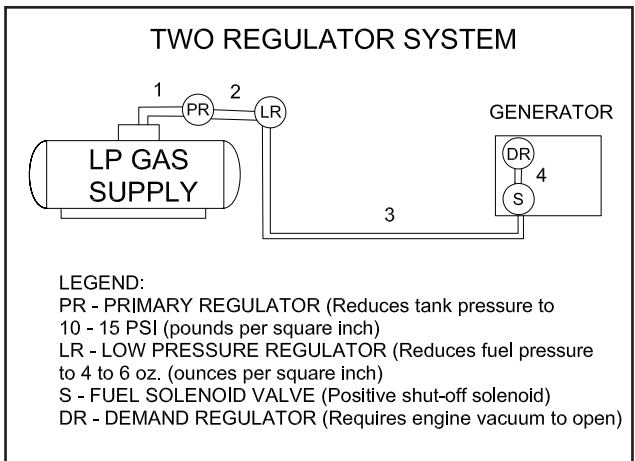

Shown below is a diagram of a natural gas (NG) installation.

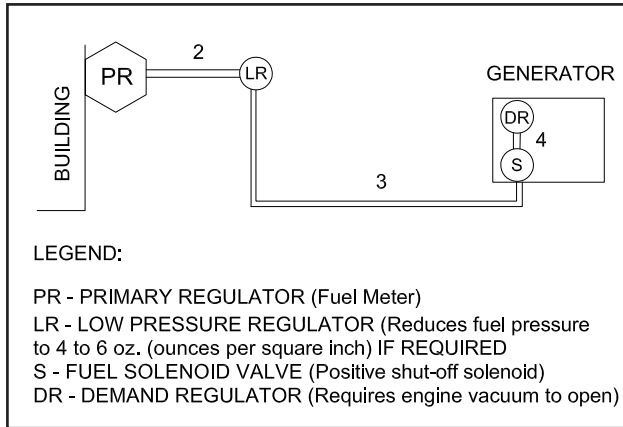

Reference numbers 2 through 4 in the diagram above are system parts supplied by the customer. Reference number 4 is on the generator.

Below are tables of the fuel pressure readings at each reference in the system.

FUEL PRESSURE TABLES

Single Low Pressure Regulator (LP Vapor only)

REF #	1	3	4
UNIT OFF	LINE PSI	7-11 IN 4-6 OZ	7-11 IN 4-6 OZ
STARTING	LINE PSI	7-11 IN 4-6 OZ	7-11 IN 4-6 OZ
NO LOAD	LINE PSI	7-11 IN 4-6 OZ	7-11 IN 4-6 OZ
FULL LOAD	LINE PSI	7-11 IN 4-6 OZ	7-11 IN 4-6 OZ

Two (2) Regulator System (LP Vapor only)

REF #	1	2	3	4
UNIT OFF	LINE PSI	10-15 LBS	7-11 IN 4-6 OZ	7-11 IN 4-6 OZ
STARTING	LINE PSI	10-15 LBS	7-11 IN 4-6 OZ	7-11 IN 4-6 OZ
NO LOAD	LINE PSI	10-15 LBS	7-11 IN 4-6 OZ	7-11 IN 4-6 OZ
FULL LOAD	LINE PSI	10-15 LBS	7-11 IN 4-6 OZ	7-11 IN 4-6 OZ

Natural Gas

REF #	2	3	4
UNIT OFF	2 PSI	7-11 IN 4-6 OZ	7-11 IN 4-6 OZ
STARTING	2 PSI	7-11 IN 4-6 OZ	7-11 IN 4-6 OZ
NO LOAD	2 PSI	7-11 IN 4-6 OZ	7-11 IN 4-6 OZ
FULL LOAD	2 PSI	7-11 IN 4-6 OZ	7-11 IN 4-6 OZ

LP TANK SIZING

Required LP tank size for LP Vapor withdrawal operating at various outside temperatures given in degrees Fahrenheit (Celsius).

TANK TEMPERATURE	TANK SIZE
60° F (16° C)	150 GALLON
32° F (0° C)	250 GALLON
0° F (18° C)	500 GALLON
-20° F (-29° C)	1000 GALLON

LP/NG FUEL CONVERSION

The ULPSS12H2W/E generator sets have been tested on **NATURAL GAS** prior to shipment. If you are going to use them on **LP vapor**, follow the procedures in FUEL INSTALLATION. See Page 6.

INSTALLING THE BATTERY

**** CAUTION ****

In the following battery installation procedure, check to be sure the selector switch remains in the "off" position. This should be your last step before initial start-up.

A customer supplied twelve-volt battery is required to complete the installation. Installation of the highest CCA rated battery, within the correct BCI group (size), will increase cold weather starting performance. *Gel batteries should not be used* with the battery tender installed in the generator enclosure.

Model	Voltage	BCI Group	MINIMUM CCA Rating
ULPSS12H2W	12	26	500

Installation and servicing of batteries must be performed or supervised only by personnel knowledgeable of batteries and the required precautions. Keep unauthorized personnel away from batteries.

When installing or replacing batteries, use the proper group/size **starting** battery. The battery should be a Maintenance Free lead acid design. Deep cycle batteries will not work for this application.

CAUTION - PERSONAL DANGER

CAUTION - NEVER dispose of a battery in a fire. The battery is capable of exploding.

CAUTION - DO NOT open or mutilate the battery. Released electrolyte is known to be harmful to the skin and eyes and to be very toxic.

These generator sets are all **NEGATIVE** ground. Be very careful not to connect the battery in reverse polarity, as this may short circuit the battery charging system on the engine.

CAUTION - A battery presents a risk of electrical shock and high short circuit current. The following precautions must be observed when working with batteries.

1. Remove watches, rings and other metal objects.
2. Use tools with insulated handles.
3. Check both the battery cable ends and the battery posts to be sure they are free of corrosion.
4. Always connect the battery positive cable first and then connect the battery negative cable. When removing the battery cables from the battery reverse the procedure, disconnect the negative cable first and then the positive cable.
5. Be sure all connections are tight and coat the terminals and cable ends with dielectric grease.

WARNING - The electrolyte is a diluted sulfuric acid that is harmful to the skin and eyes. It is electrically conductive and corrosive. The following precautions must always be taken.

- * Always wear full eye protection and protective clothing.
- * Where electrolyte contacts the skin, wash off immediately with water.
- * If electrolyte contacts the eyes, flush thoroughly and immediately with water and seek immediate medical attention.
- * Spilled electrolyte is to be washed down with an acid neutralizing agent. A common practice is to use a solution of one pound of bicarbonate of soda (baking soda) to one gallon of water. The bicarbonate of soda solution is to be added until the evidence of reaction, foaming, has ceased. The resulting liquid is to be flushed with water and the area dried.

DANGER - Explosive Fire Risk

- * Never smoke when near batteries.
- * Do not cause a flame or spark in the battery area.
- * Always discharge static electricity from your body before touching batteries by first touching a grounded metal surface.

SERVICING BATTERIES

Batteries used on these units may over time lose water. This is especially true if you are using a trickle charger to maintain your battery. When refilling the battery with water use only distilled water. Tap water will shorten the service life of the battery.

Never fill the battery above the fill line. Over filling above the upper level line may cause the electrolyte to overflow, resulting in corrosion to the engine or nearby parts. Immediately wash off any spilled electrolyte following the procedure above.

BATTERY CHARGING

Units equipped with electric start have a small flywheel charger built into the engine flywheel assembly for recharging the starting battery. This flywheel charger generates a small AC current that passes through a rectifier/regulator assembly on the engine to produce a DC charging current. This circuit is not designed to be used as a battery charging circuit to recharge dead batteries.

**** **CAUTION** ****

EQUIPMENT DAMAGE - Always connect the positive cable first and the negative cable last. When disconnecting, remove the negative cable first and the positive cable last. Failure to connect and disconnect in the proper sequence can cause equipment damage.

Observe polarities: connect the positive (+) battery terminal to the (+) cable from the engine starter; the negative (-) battery terminal is connected to the negative cable (ground) from the engine generator assembly. All connections must be clean and tight. Check the electrolyte (fluid) in the battery periodically to be sure it is above the plates. Never allow the battery to remain in a discharged condition.

**** **CAUTION** ****

EQUIPMENT DAMAGE - NEVER JUMP START these units. Doing so will destroy the engine control module rendering the unit non-operational. Remove and fully recharge the battery before attempting to start.

CUSTOMER CONNECTION AREA

CUSTOMER AC & DC CONNECTION POINTS

TORQUE SPECIFICATIONS FOR CONNECTIONS

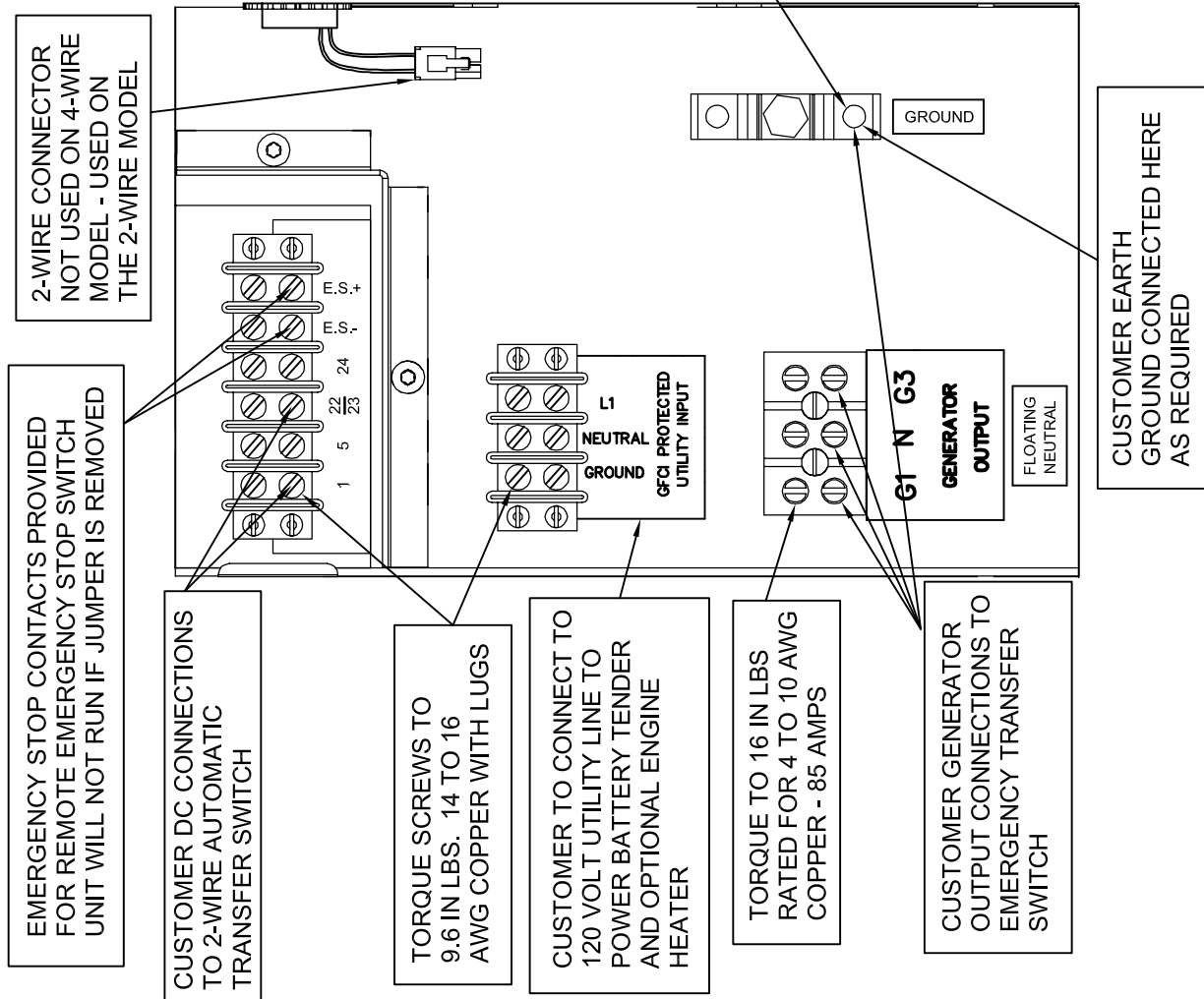

CONNECTING THE BATTERY CHARGER

A two-stage battery tender is provided on all PSS series generators. This battery tender charges at a rate of 750 mA until the battery is fully charged and then automatically switches to a 13.2 VDC float charger. The charger has an indicator light on it, red indicates it is charging, and green indicates it is in the storage mode (float charge). This charger is mounted on the generator set, located behind an access cover on the right side of the unit.

The battery tender receptacle is to be powered by a GFCI circuit and installed in accordance with the United States National Electric Code. These AC wires can be run in the same conduit as the other AC leads from the generator. It is suggested that this circuit be fused for 15 amps. Terminal block connections have been provided in the customer connection area of the engine generator set. See Page 10 for diagram.

** NOTICE **

The battery tender is not intended to recharge a battery which has become completely discharged. It is designed to produce enough current to recharge a slightly low battery, maintaining it fully charged.

MOUNTING THE AUTOMATIC TRANSFER SWITCH (ATS)

***** WARNING *****

EQUIPMENT DAMAGE - Protect the switch from construction grit and metal chips to prevent malfunction or shortened life of the switch. Contactors returned for warranty consideration with foreign materials inside of them will not be warranted.

Before installing the ATS you must first ensure that the transfer switch is large enough to handle your complete distribution panel. If you are installing a 100 amp transfer switch the main line circuit breaker must not be larger than 100 amps. If you have a 125, 150, 200 amp or larger system and want to use a 100 amp transfer switch, you will not be able to transfer the complete electrical system. In this case it will be necessary to install a secondary emergency distribution panel. NOTE: THE MAXIMUM OUTPUT OF THE GENERATOR IS 50 AMPS AT 240 VOLTS.

AC ELECTRICAL CONNECTIONS

NOTICE - CLASS 1 WIRING METHODS ARE TO BE USED FOR ALL FIELD WIRING CONNECTIONS TO TERMINALS OF A CLASS 2 CIRCUIT.

***** WARNING *****

A main line circuit breaker has been provided inside the generator housing. During all wiring installation make sure the breaker is in the off position and the generator operators switch is in the off position.

Note: This symbol  **always indicates ground where used.**

GENERATOR CONNECTIONS

Minimum conductor sizes between the generator and the ATS. Based on wire type and temperature rating. Wire has been derated for 40° C ambient temperatures.

WIRE TEMPERATURE RATING

	CU Connector	AL Connector
75° C	# 6 AWG	# 4 AWG
90° C	# 8 AWG	# 6 AWG

To gain access to the customer connections remove the end door panel opposite the muffler. All AC and DC connections to the ATS, 120 Volt power connection for battery charger, and battery installation are made behind this panel. After removing the door remove the cover over the customer connection box, using a 7/16 inch open end wrench. See pages 20 and 21 for generator set and pad layout.

Two (2) hot leads, one (1) neutral and (1) ground lead are required between the generator and the ATS. The two power leads from the generator are marked G1 and G3. Next install two leads, one neutral and one ground lead from the generator set to the distribution panel or Transfer Switch.

In addition to the power leads install a three wire 120 volt, 15 amp circuit from your distribution panel to the generator. This circuit will be used to power the battery charger, optional block heater and optional battery heater.

The last two wires you will install are the DC control leads (14 or 16 gauge) for the start circuit in the ATS. These last two connections will be discussed later in more detail.

WINCO UL ATS (ASCO 165)

See the ASCO installation manual for additional details on proper wiring of the Automatic Transfer Switch.

The standby generator terminals in the ATS are marked "ALTERNATE L2 & L6". The "hot" leads G1 and G3 from the generator are connected to the terminals L2 & L6.

The normal line power terminals in the ATS are marked "PREFERRED - L1 & L5". The "hot" line power leads are L1 and L3 from your normal power supply are connected to terminals L1 and L5.

The load terminals in the ATS are marked "LOAD - L3 & L7". The leads to the load distribution panel are connected to terminals L3 & L7.

The neutral leads from all three locations are connected to the isolated terminal lugs on the sidewall of the cabinet. This terminal block is labeled "NEUTRAL" and the terminal lugs are mounted on red isolation standoffs.

The ground leads from all locations are connected to the grounded terminal lugs also located on the side wall. This set of terminals is labeled "GROUND".

INSTALLATION NOTES

The load current carrying wires (L) and (T) must be sized to handle the maximum load current without excessive voltage drop. By code, the wire must be heavy enough to handle the full current rating of the main line circuit breaker (or fuse) in the entrance (or sub-panel) protecting the contactor switch.

All wires should be installed in rigid or flexible conduit. Because of the many different types of service, feeder, and distribution equipment, no specific wiring instructions can be provided. It is, however, recommended that **copper wire** be used. In all cases it is essential that while the load is connected to the generator, there can be absolutely no feedback from the generator to the power line or the power line to the generator. When properly installed, the normal ATS control and safety systems will eliminate all paths for feedback. Check with your local electrical inspector on applicable local, state and federal codes.

**** **WARNING** ****

A service disconnect must be installed in front of the ATS panel as the ATS is not service entrance rated. This will allow you to test the generator under load. Should you ever have to work on the switch, you will be able to disconnect the power and work on the switch cold without having the power company pull your meter.

To wire the automatic transfer switch into the existing wiring, first determine which circuits will be on the emergency load circuit. If the entire load is to be transferred, the transfer switch can be wired in directly after the watt-hour meter and the service entrance, providing the service entrance ampere rating is within the transfer switch's rated capability.

If only specific circuits are to be powered under emergency power failure conditions, and additional distribution panel designated "emergency distribution panel" must be installed.

All selected emergency circuits are removed from main distribution panels and reinstalled in the emergency distribution panel. Suggested circuits: freezer, refrigerator, furnace, emergency lights, sump pump, emergency outlet circuits, etc. Total running load must not exceed generator rating.

DC ELECTRICAL INTERCONNECTION

**** **CAUTION** ****

Never run the AC and DC wiring in the same conduit.

ASCO 165 UL SWITCH

Your DC connection points in the ASCO 165 UL ATS are on the terminal block in the upper right hand corner of the ATS panel. The terminal block (TB7) is numbered 1 through 9. These terminals will accept # 22 - # 14 AWG stranded wire. It is recommended that you use # 16 AWG for distances up to 200 feet. You need to run two (2) wires from the generator set to the transfer switch. You will be using terminals 4 and 5, wire Start # 23 will connect to terminal # 5 and wire Battery Negative # 1 will connect to terminal # 4. See table and illustration on the next page.

WIRE #	PURPOSE	RECOMMENDED COLOR
# 23	Start	Black
# 1	Battery Negative	White

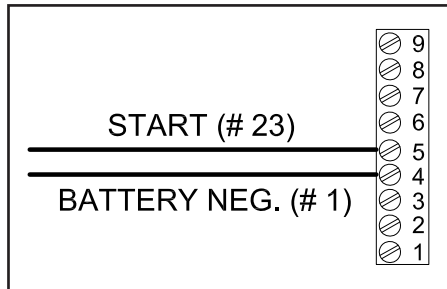

INITIAL START UP

***** **WARNING** *****

DO NOT jump start these generator sets. Starting these units on a low battery of jump starting them will cause damage to the engine control module.

Use the following checklist to verify correct installation before starting the engine:

- Engine oil. Check level & fill as required with proper grade/quantity. Refer to engine owners manual for proper levels and types.
- Unit mounting base properly bolted down.
- Clearance for service and maintenance on all sides.
- Proper fuel line material and size.
- All fuel line connections tight.
- Fuel line protected and a moisture trap installed (may be required for NG).
- LP/NG pressure OK. 4-6 oz. (7-11 in. WC).
- Battery connections clean and tight.
- Battery fully charged.
- All AC and DC wiring installed and properly protected.

LUBRICATION

Before starting the engine, check and fill the crankcase with the proper weight/grade oil, as recommended by the engine manufacturer's maintenance instructions. The necessity of using the correct oil, and keeping the crankcase full cannot be over emphasized. **DO NOT OVERFILL THE ENGINE, Use the dipstick.**

After completing the above checklist, the generator set is ready for the initial start-up test.

START UP PROCEDURE Engine Generator Set only

The engine control module (ECM) is manufactured by Deep Sea Electronics. Model 3110 is used on this engine generator set. See picture below. Additional information on the DSE 3110 is on pages 14 through 17.

Manual Operation

Press and release the red Stop/Reset button. Then press and release the green Start Engine button. The engine generator will crank and start automatically. If the engine fails to start correct the problem before proceeding.



With the engine running smoothly, check the no load voltage and frequency at wire # 1 and # 4 (L2 and L6 in the ASCO ATS) on the generator terminal block in the ATS. The voltage should be 240 volts plus or minus nominal. The frequency should be between 61.5 to 62 hertz (Hz). The voltage should also be checked between the hot terminals (L2 and L6) and the neutral to be certain of a balanced voltage output and a solid neutral connection. The voltage should be about one half of the line to line voltage.

** NOTICE **

If for any reason during the check out procedures the voltage and frequency are not correct, press the Stop/Reset button and correct the trouble before proceeding.

After verifying the voltage and frequency are correct, press the Stop/Reset button. This will shut off the engine immediately.

Transfer Switch & Engine Generator

Automatic (remote) Operation

This procedure checks the electrical operation of the automatic transfer switch. If the actual operation does not follow this procedure, consult the troubleshooting section in the transfer switch manual.

1. Turn on the preferred source (utility) circuit breaker. The utility source acceptable light should now come on as well as the transfer switch on utility light. If these lights fail to come on recheck your incoming power to insure you have 240 volts nominal. If not, troubleshoot your utility source before continuing.

***** **WARNING** *****

PERSONAL INJURY HAZARD - Install front cover in transfer switch before operation. An electrical system fault could cause a flash and severe personal injury.

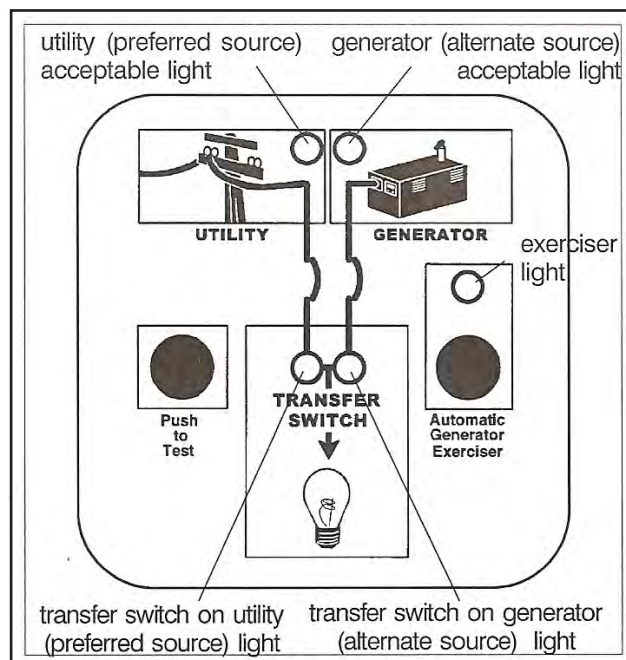

2. Press and release the **Auto** button on the engine control module (ECM). The auto mode icon will appear on the screen. The unit is now ready to be operated from the Automatic Transfer Switch.

3. Turn on the alternate source (generator) circuit breaker.

There are two ways to test your transfer switch operation: WITHOUT a load transfer or WITH a load transfer.

WITHOUT load transfer (normal exercise)

1. Press and release the **Push to Test** button. The generator set should start immediately. About 15 seconds the generator (alternate source) acceptable light comes on and stays on.

2. The generator set runs for 20 minutes. The

Transfer Switch does not transfer the load to the generator set. The **Transfer Switch** on utility (preferred source) light stays on.

3. To bypass the time delay or cancel the test, press and release the **Push to Test** button again.

4. The generator set stops and the **Generator** acceptable light goes off.

WITH Load Transfer

1. Press and hold the **Push to Test** button until the generator (alternate source) acceptable light comes on and stays on. Then release the button. This will start up your generator set.

This light indicates that the generator is running and the output voltage and frequency are within acceptable limits. Under normal conditions this light should come on in 5 to 10 seconds. If the light does not come on and stay on a malfunction has occurred. Either the unit didn't start or the voltage or frequency is incorrect. Correct the problem before continuing.

2. About 15 seconds after the generator (alternate source) acceptable light comes on, the automatic transfer switch should transfer the load from the utility to the generator. At that time the Transfer Switch generator acceptable light should come on.

3. The generator will stay connected to the load for about 5 minutes at which time the transfer switch will transfer the load back to the utility. At the time it transfers back to utility the Transfer Switch on Utility light should come on and the Transfer Switch on generator light should go out. To bypass this five minute time delay you can press and release the **Push to Test** button again at any time.

4. After the load retransfer to the utility, the generator will continue to run for about 1 minute (without a load) and then shut down. The Generator acceptable light will go off indicating the generator set has shut down.

This completes the functional test of the transfer switch and the generator set. If you want the generator to automatically start press the **Auto** button on the engine control module of the generator set. If you have additional work to do or don't want to leave the engine generator set in the automatic start mode press and release the **stop/reset** button on the generator set. In the off mode the engine generator set will not start or run automatically.

GENERATOR EXERCISER CIRCUIT

The automatic generator exerciser is configured to automatically exercise the generator for 20 minutes once every 14 days.

In order to set and test the exercise circuit the engine control module must be set in the auto mode.

SETTING THE EXERCISER CIRCUIT

Press and release the **Automatic Generator Exerciser** button. After about 8 seconds the exerciser light flashes 14 times to indicate that the exerciser circuit has been set. The number of flashes indicates the number of days until the next exercise period. This 20 minute period will occur at approximately the same time of the day the button was pressed.

DISABLING THE EXERCISER CIRCUIT

Press and hold the **Automatic Generator Exerciser** button until the light goes off, the light flashes then goes off.

ENABLING THE EXERCISER CIRCUIT

Press and hold the **Automatic Generator Exerciser** button until the light goes off, the light flashes then goes off. After about 8 seconds the exerciser light flashes fourteen times to indicate that the exerciser circuit has be re-enabled.

***** **WARNING** *****

WITH A TOTAL POWER FAILURE (UTILITY POWER FAILS AND THE GENERATOR FAILS TO START AND RUN) THE EXERCISER MUST BE RESET AFTER THE POWER IS RESTORED.

CLEARING AN "ERROR" CODE

An error codes occurs on the ASCO control board if the generator set fails to start or there is some other malfunction. BOTH Transfer Switch lights will be blinking together. The Automatic Generator Exerciser light will be blinking a number of times then pause. This number gives the error code reason from page 8 of the ASCO 165 owner's manual. To clear this code press and release the **Push to Test** button once. Then troubleshoot the problem according to the ASCO 165 owner's manual.

This completes your installation and unit testing. ALWAYS leave the system in automatic mode unless servicing the unit. For automatic operation, the auto mode icon must be displayed on the engine control module.

DSE 3110 ENGINE CONTROL

PROTECTIONS

When an alarm is present, the Common alarm LED if configured will illuminate. **The LCD display will show an icon to indicate the fault.**

WARNINGS

Warnings are non-critical alarm conditions and do not affect the operation of the generator system, they serve to draw the operators attention to an undesirable condition. The icon will appear steady in the display. Warning alarms are self-resetting when the fault condition is removed.

SHUTDOWNS

Shutdowns are critical alarm conditions that stop the engine and draw the operator's attention to an undesirable condition. Shutdown alarms are latching. **The fault must be removed and the STOP/RESET button pressed to reset the module.** The icon will appear flashing in the display.

MODULE DISPLAY

TIMER ICON

When the module is controlling the engine (starting and stopping) an animated timer icon will be displayed in the icon area to indicate that a timer is active, for example cranking time, crank rest, etc.



STOPPED ICON

When there are no alarms present, an icon will be displayed to indicate the engine is stopped and what mode the unit is in.



Stop Mode



Auto Mode



Manual Mode

RUNNING ICON

When there are no alarms present, an animated icon is displayed to indicate the engine is running.



USB ICON

When a USB connection is made to the module the USB icon is displayed.



MEMORY CORRUPTION

If either the config file or engine file becomes corrupted the unit will display the following icon.



DSE 3110 CONTROL

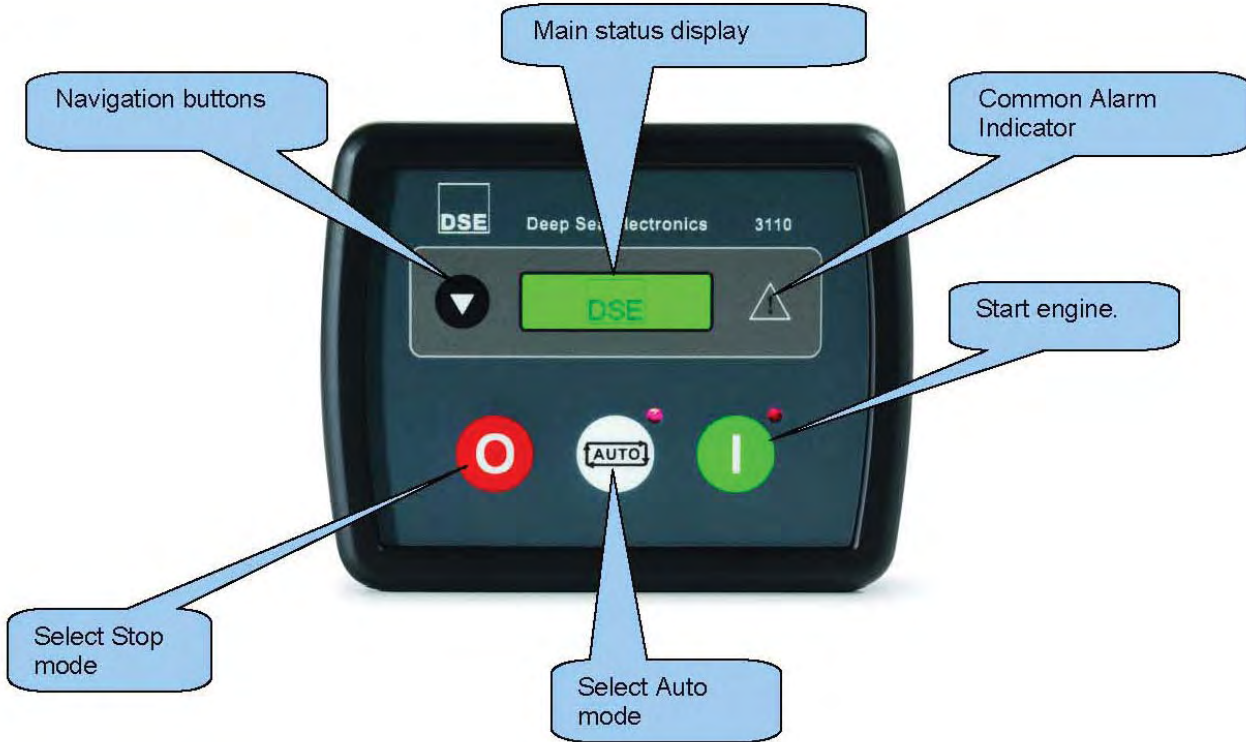





	<p>STOP/RESET (Red Button) This button places the module into its “Stop/Reset” mode. This will clear any alarm conditions for which the triggering criteria have been removed. If the engine is running and the module is in Stop mode, the module will automatically instruct the changeover device to unload the generator. (Close generator becomes inactive (if used)). The fuel supply de-energizes and the engine comes to a standstill. Should a remote start signal be present while operating in this mode, a remote start WILL NOT occur.</p>
	<p>AUTO (White Button) This button places the module into its “Automatic” mode. This mode allows the module to control the function of the generator automatically. The module will monitor the remote start input and once a start request is made, the set will be automatically started and placed on load. Upon removal of the starting signal, the module will automatically transfer the load from the generator and shut the set down observing the stop delay timer and cooling timer as necessary. The module will then wait the next start event.</p>
	<p>START (Green button) Pressing this button in auto mode will start the engine and run off load. Pressing this button in Stop/Reset mode will turn on the CAN engine ECU (when correctly configured and fitted to a compatible engine ECU).</p>
	<p>PAGE Pressing this button scrolls the display to show the various instruments.</p>

FRONT PANEL CONFIGURATION

This configuration mode allows the operator limited customizing of the way the module operates. Use the module's navigation buttons to traverse the menu and make value changes to the parameters.



1. ACCEPT button.  2. NEXT PAGE button. 
3. DECREASE VALUE / NEXT ITEM  4. INCREASE VALUE / NEXT ITEM 

ACCESSING THE FRONT PANEL

Press 1 (accept) and 2 (next page) **simultaneously (at the same time)**. This display shows the configuration icon:  The first parameter is also displayed.

EDITING A PARAMETER

Enter the editor as described above.













- * Press 2 to select the required 'page' as detailed below.
- * Press 4 to select the next parameter or 3 to select the previous parameter within the current page.
- * When viewing the parameter to be changed, press the 1 button. The value begins to flash.
- * Press 4 or 3 to adjust the value to the requested setting.
- * Press 1 to save the current value. The value stops flashing.
- * Press and hold the 1 button to exit the editor, the configuration icon  is removed from the display.

NOTE: Values representing pressure will be displayed in Bar. Values representing temperature are displayed in degrees Celsius.

NOTE: When adjusting values in the front panel editor a press and hold of the increment button will cover the full range of the item being adjusted (min to max) in under 20 seconds.

NOTE: When the editor is visible, it is exited after 5 minutes of inactivity for security.

DSE 3110 CONTROL FAULT CODES

	AUXILIARY INPUTS	Auxiliary inputs can be user configured and will display the message as written by the user.
	FAIL TO START	The engine has not fired after the preset number of start attempts
	FAIL TO STOP	The module has detected a condition that indicates that the engine is running when it has been instructed to stop. ▲NOTE:- 'Fail to Stop' could indicate a faulty oil pressure sensor - If engine is at rest check oil sensor wiring and configuration.
	LOW OIL PRESSURE	The module detects that the engine oil pressure has fallen below the low oil pressure pre-alarm setting level after the <i>Safety On</i> timer has expired.
	ENGINE HIGH OIL TEMPERATURE	The module detects that the engine oil temperature has exceeded the high engine temperature pre-alarm setting level after the <i>Safety On</i> timer has expired.
	UNDERSPEED	The engine speed has fallen below the underspeed pre alarm setting
	OVERSPEED	The engine speed has risen above the overspeed pre alarm setting
	BATTERY UNDER VOLTAGE / BATTERY OVER VOLTAGE	The DC supply has fallen below or risen above the low/high volts setting level.
	GENERATOR UNDER VOLTAGE	The generator output voltage has fallen below the pre-set pre-alarm setting after the <i>Safety On</i> timer has expired.
	GENERATOR OVER VOLTAGE	The generator output voltage has risen above the pre-set pre-alarm setting.
	GENERATOR UNDER FREQUENCY	The generator output frequency has fallen below the pre-set pre-alarm setting after the <i>Safety On</i> timer has expired.
	GENERATOR OVER FREQUENCY	The generator output frequency has risen above the pre-set pre-alarm setting.

ENGINE GENERATOR SET LAYOUT ULPSS12H2W/E

RIGHT SIDE VIEW

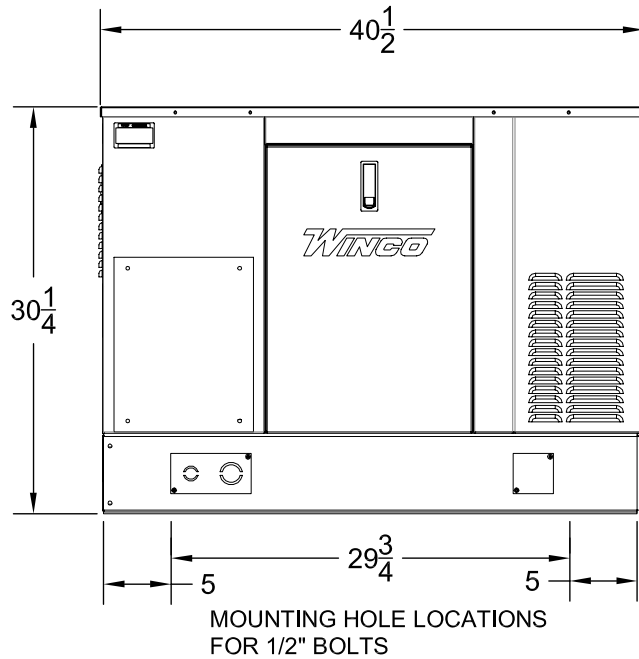

FRONT VIEW

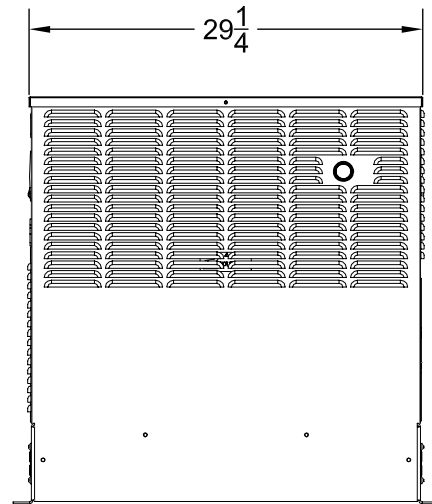

LEFT SIDE VIEW

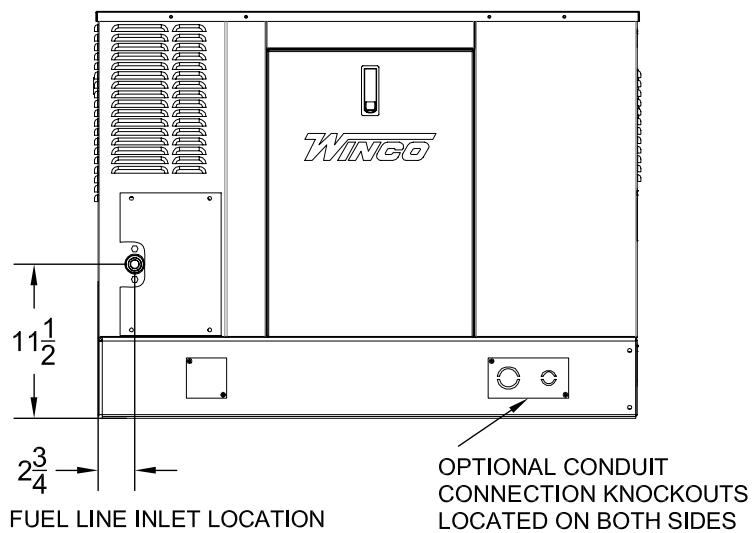

REAR VIEW

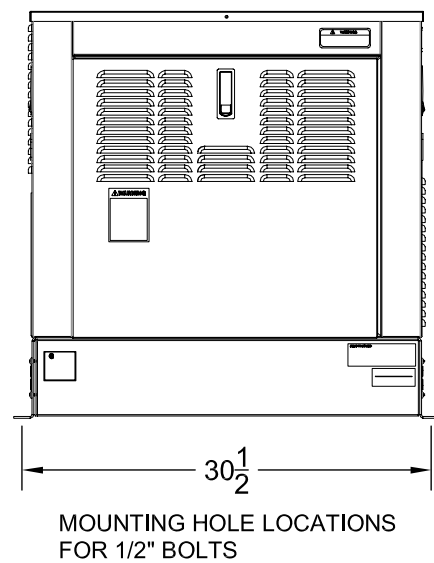

ENGINE GENERATOR SET PAD LAYOUT

RECOMMENDED CEMENT
PAD IS 4 TO 6 INCHES THICK
AND 4 INCHES LARGER THAN
THE BASE ON EACH SIDE.

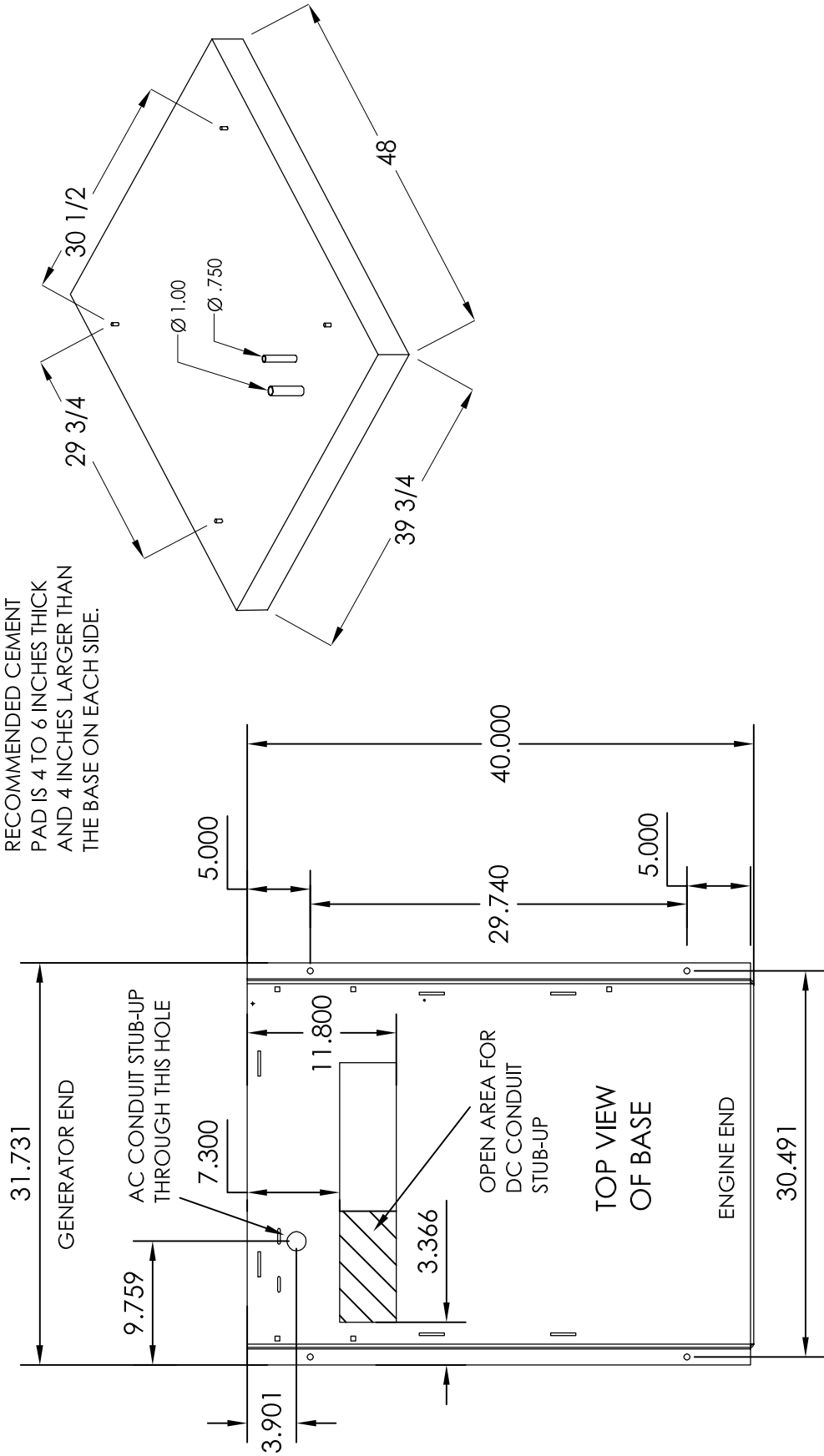

TROUBLESHOOTING TABLES

***** **WARNING** *****

NEVER JUMP START THESE UNITS. JUMP STARTING THESE UNITS WITH LOW OR BAD BATTERIES WILL CAUSE PERMANENT DAMAGE TO THE ENGINE CONTROL MODULE.

UNIT WILL NOT CRANK WHEN THE POWER FAILS.

1. Engine control module not in the "Auto" mode.
2. Transfer switch control board not closing the contacts.
3. Low or dead battery, must hold 12 volts during cranking.
4. Incorrect wiring between transfer switch and generator.
5. Loose or dirty battery terminals
6. Defective engine control module (ECM).
7. Defective starter.
8. Defective start solenoid.
9. Defective start/stop control in the transfer switch.
10. ATS panel in fault from previous run cycle.
11. Blown 2 amp fuse on generator control panel.
12. Blown 10 amp fuse on generator control panel.
13. Defective starter/fuel solenoid relay(s).

ENGINE WILL NOT CRANK USING START BUTTON ON THE GENERATOR.

1. Low or dead battery, must hold 12 volts during cranking.
2. Blown 2 amp fuse on generator control panel.
3. Blown 10 amp fuse on generator control panel.
4. Loose or dirty battery terminals.
5. Defective engine control module (ECM).
6. Defective starter.
7. Defective start solenoid.
8. Locked up engine generator set.
9. Defective starter/fuel solenoid relay(s).

ENGINE CRANKS BUT WILL NOT START

1. Improper fuel pressure being delivered to unit.
2. Fuel supply shut off.
3. Fuel supply empty.
4. Defective spark plug.
5. Defective engine ignition module.
6. Dirty air cleaner filter.
7. Defective fuel solenoid valve.
8. Low voltage from battery to fuel solenoid, must hold 12 volts during cranking.
9. Oil in the bottom of air cleaner from crankcase breather.
10. Defective starter/fuel solenoid relay(s).

ENGINE STARTS AND THEN STOPS AND FAULT ICON COMES ON.

1. Engine is low on oil.
2. No AC output from generator to engage stop crank circuit.

ENGINE WILL NOT COME UP TO SPEED AFTER IT STARTS

1. Insufficient fuel volume getting to the unit.
 - a. Fuel line too small.
 - b. Low fuel pressure.
2. AC short circuit.
3. Wiring to the ATS panel crossed or shorted.
4. Unit is overloaded. Check load amperage.

ATS PANEL WILL NOT TRANSFER TO EMERGENCY SUPPLY (GENERATOR).

1. No AC generator output from generator.
2. See Automatic Transfer Switch Manual.

ATS PANEL WILL NOT PULL IN ON NORMAL POWER.

See Automatic Transfer Switch Manual

NO AC OUTPUT FROM GENERATOR

1. Diodes on rotor blown.
2. Defective capacitor(s).
3. Defective rotor.
4. Defective stator.
5. AC short in the output leads.
6. Unit has lost its residual voltage.
7. Rotor loose on engine crankshaft.
8. Low engine speed, must be 3600 RPM.

AC AND DC GENERATOR SCHEMATIC

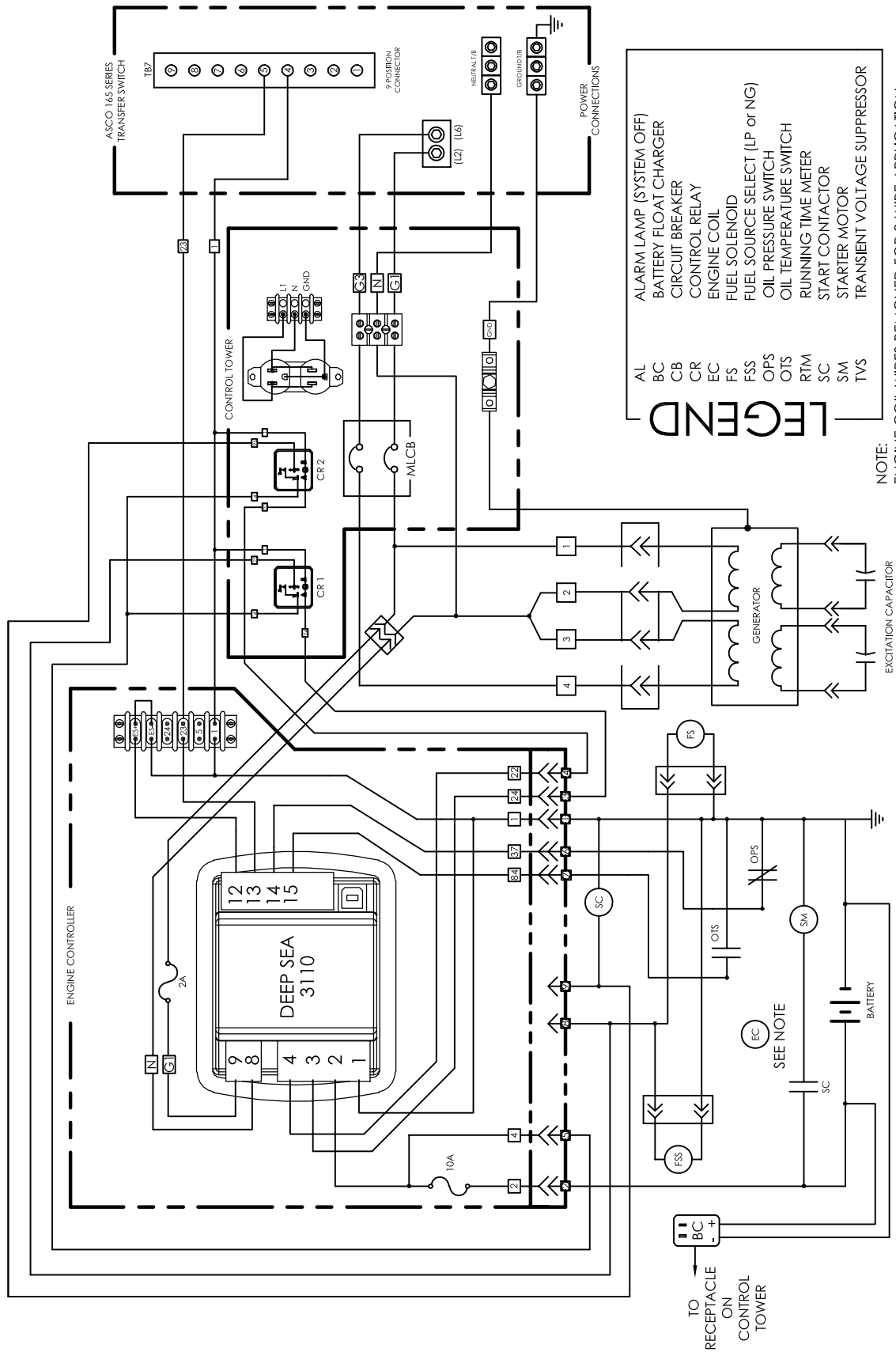

- LEGEND**
- AL ALARM LAMP (SYSTEM OFF)
 - BC BATTERY FLOAT CHARGER
 - CB CIRCUIT BREAKER
 - CR CONTROL RELAY
 - EC ENGINE COIL
 - FS FUEL SOLENOID
 - FSS FUEL SOURCE SELECT (LP or NG)
 - OPS OIL PRESSURE SWITCH
 - OTS OIL TEMPERATURE SWITCH
 - RTM RUNNING TIME METER
 - SC START CONTACTOR
 - SM STARTER MOTOR
 - TVS TRANSIENT VOLTAGE SUPPRESSOR

NOTE:
ENGINE COIL WIRES REMOVED FOR 2-WIRE APPLICATION.



12 MONTH LIMITED WARRANTY

WINCO, Incorporated warrants to the original purchaser for 12 months or 1000 hours which ever occurs first, that goods manufactured or supplied by it will be free from defects in workmanship and material, provided such goods are installed, operated and maintained in accordance with WINCO written instructions.

WINCO's sole liability, and Purchaser's sole remedy for a failure under this warranty, shall be limited to the repair of the product. At WINCO's option, material found to be defective in material or workmanship under normal use and service will be repaired or replaced. For warranty service, return the product within 12 months or 1000 hours which ever occurs first from the date of purchase, transportation charges prepaid, to your nearest WINCO Authorized Service Center or to WINCO, Inc. at LeCenter Minnesota.

THERE IS NO OTHER EXPRESS WARRANTY.

To the extent permitted by law, any and all warranties, including those of merchantability and fitness for a particular purpose, are limited to 12 months or 1000 hours which ever occurs first, from date of purchase. In no event is WINCO liable for incidental or consequential damages.

Note: Some states do not allow limitation on the duration of implied warranty and some states do not allow the exclusion or limitation of incidental or consequential damages, so the above limitations may not apply in every instance. This warranty gives you specific legal rights which may vary from state to state.

WINCO reserves the right to change or improve its products without incurring any obligations to make such changes or improvements on products purchased previously.

EXCLUSIONS:

WINCO does not warrant Engines. Engines are covered exclusively by the warranties of their respective manufacturers, see enclosed warranties.

WINCO does not warrant Batteries, or Other Component Parts that are warranted by their respective manufacturers.

WINCO does not warrant modifications or alterations which were not made by WINCO Inc.

WINCO does not warrant products which have been subjected to misuse and/or negligence or have been involved in an accident.