

ultimate ROUTER TABLE



This plan design includes just about every wish-list item we could think of for a shop-built router table. But there are a few features in particular that really stand out.

Large, thick top - It's big enough to handle most workpieces, and it's equipped with a miter track for holding jigs and other accessories. *T-track fence system* - Includes a micro-adjust feature for precision cuts and also plays a key part in the built-in dust collection system. *Storage* - Below the table, the stout base adds ample storage. And there are casters that make it easy to move the router table around your shop.

Finally, it's made from inexpensive MDF. That means this router table won't cost you much to build.

Materials

A	Sides (4)	15¼ x 30 - ¾ MDF
B	Backs (2)	8½ x 29¼ - ¾ MDF
C	Tops (2)	8½ x 14½ - ¾ MDF
D	Bottoms (2)	8½ x 17¾ - ¾ MDF
E	Doors (2)	9 x 29¾ - ¾ MDF
F	Shelves (4)	7¾ x 14 - ¾ MDF
G	Base Sides (4)	5¼ x 15¼ - ¾ MDF
H	Base Fronts (2)	5¼ x 9 - ¾ MDF
I	Cleats (1)	¾ x ¾ - 84 rgh.
J	Corner Blocks (2)	1½ x 3½ - 5⅛
K	Sides (2)	13½ x 15½ - ¾ MDF
L	Back (1)	13 x 15½ - ¾ MDF
M	Top/Bottom (2)	13 x 14¼ - ¾ MDF
N	Edging (2)	¾ x ¾ - 13
O	Long Side (1)	2½ x 8½ - ¾ MDF
P	Short Side (1)	2½ x 5½ - ¾ MDF
Q	Long Back (1)	2½ x 19¼ - ¾ MDF
R	Short Back (1)	2½ x 14¾ - ¾ MDF
S	End (1)	2½ x 4½ - ¾ MDF
T	Bottom (1)	9⅞ x 20 - ¼ Hdbd.
U	Blast Gate (1)	3¾ x 3¾ - ¼ Hdbd.
V	Support Plate (1)	¾ x 6 - 13
W	Drawer Fronts/Backs (6)	½ x 4 - 10
X	Drawer Sides (6)	½ x 4 - 13
Y	Drawer Bottoms (3)	10½ x 12½ - ¼ Hdbd.
Z	False Fronts (3)	4⅞ x 12¾ - ¾ MDF
AA	Table Core (1)	24 x 36 - 1½ MDF
BB	Table Skins (2)	24 x 36 - Plastic Laminate
CC	Table Extension Core (1)	9½ x 11 - 1½ MDF
DD	Table Extension Skins (2)	9½ x 11 - Plas. Lam.
EE	Support Arm (1)	¾ x 1½ - 12
FF	Fence Base (1)	9½ x 21 - ¾ MDF
GG	Fence Runners (2)	¼ x 5½ - 4¾
HH	Fence Sides (2)	2 x 8 - ¾ MDF
II	Fence Back (1)	2 x 3 - ¾ MDF
JJ	Fence Cap (1)	4½ x 8 - ¼ Acrylic
KK	Fence Fronts (2)	¾ x 3 - 28
LL	Fence Top (1)	¾ x 1⅞ - 28

Exploded View Details

OVERALL DIMENSIONS: 35"D x 36"W x 40⅞"H

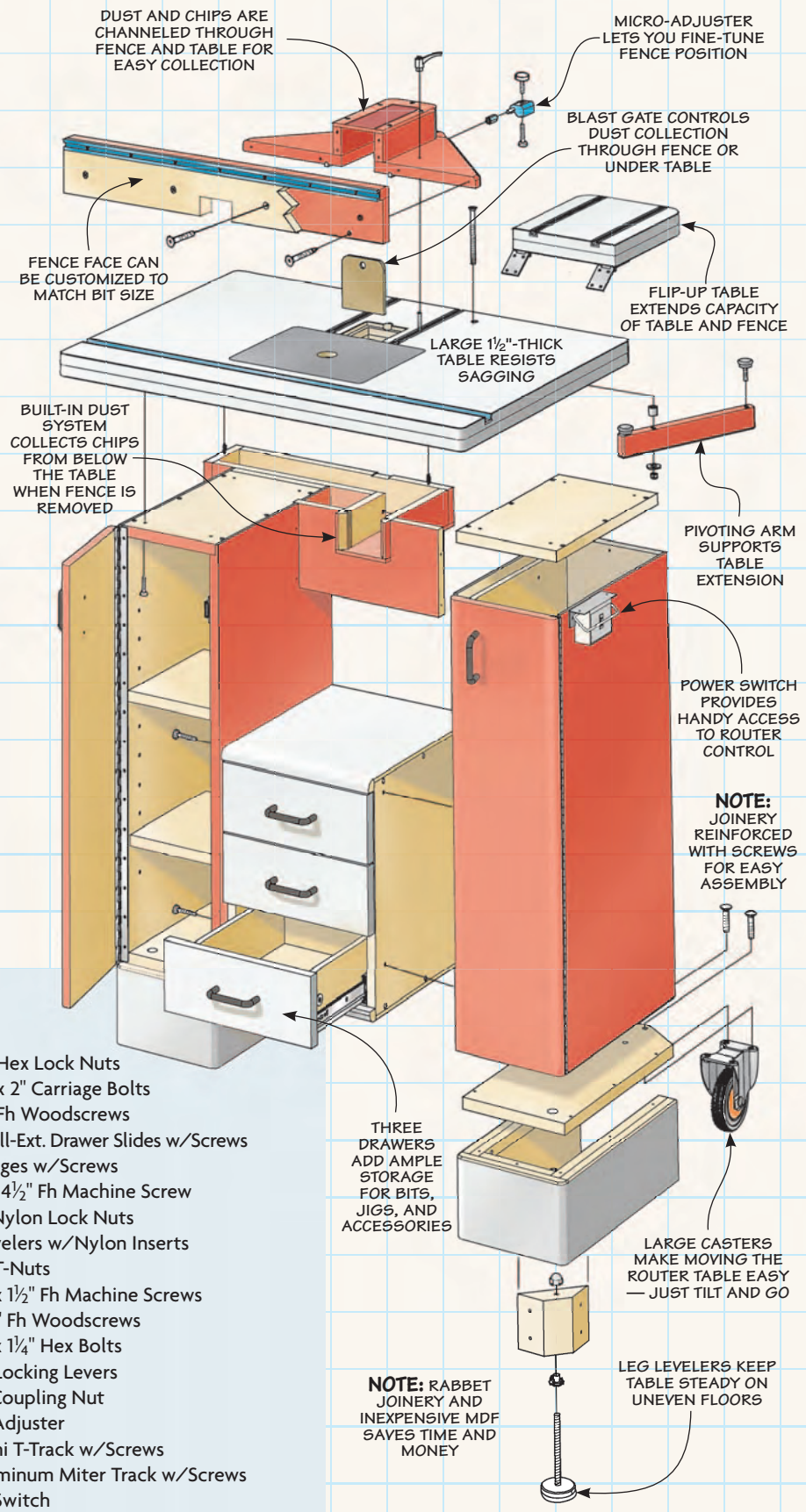

Hardware

- (24) #6 x 1½ Fh Woodscrews
- (64) #8 x 1¼ Fh Woodscrews
- (22) #8 x 1½ Fh Woodscrews
- (4) #8 x 2 Fh Woodscrews
- (2) 4" Fixed Casters
- (8) ¾"-16 x 1½" Carriage Bolts
- (10) ¾" Flat Washers
- (10) ¾"-16 Hex Nuts
- (2) ¾"-16 Leg Levelers
- (2) ¾"-16 T-Nuts
- (2) ¾"-16 Acorn Nuts
- (16) ¼"-dia. Shelf Pins
- (5) 4" Drawer/Door Pulls w/Screws
- (2) 1½" x 30" Piano Hinges w/Screws
- (2) Magnetic Catches w/Screws
- (9) #8 x ⅝" Fh Woodscrews
- (1) 2½" Dust Port
- (8) ¼" Flat Washers
- (8) ¼"-20 Hex Lock Nuts
- (8) ¼"-20 x 2" Carriage Bolts
- (6) #8 x 1" Fh Woodscrews
- (3pr.) 12" Full-Ext. Drawer Slides w/Screws
- (2) 1½" Hinges w/Screws
- (1) ¾"-16 x 4½" Fh Machine Screw
- (2) ¾"-16 Nylon Lock Nuts
- (2) Leg Levelers w/Nylon Inserts
- (4) ¼"-20 T-Nuts
- (4) ¼"-20 x 1½" Fh Machine Screws
- (5) #6 x ⅝" Fh Woodscrews
- (2) ¼"-20 x 1¼" Hex Bolts
- (2) ¼"-20 Locking Levers
- (1) ¼"-20 Coupling Nut
- (1) Micro-Adjuster
- (2) 48" Mini T-Track w/Screws
- (1) 36" Aluminum Miter Track w/Screws
- (1) Power Switch

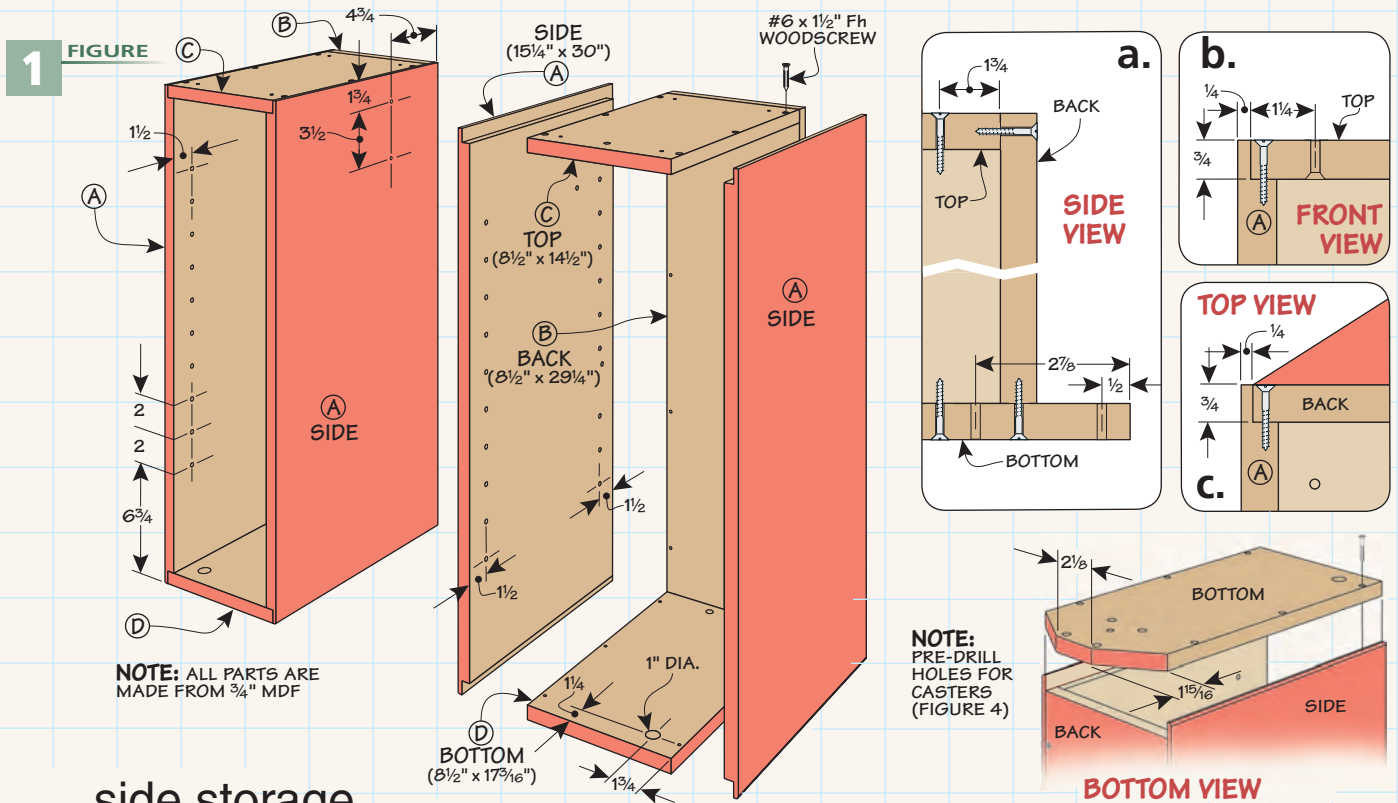

side storage Towers

The base is divided into several sections: two towers, two bases, and a drawer cabinet. This keeps the construction straightforward. Once the sections are complete, they are bolted together.

The base has two main functions. First, it's meant to provide ample support for the tabletop. To do that, it's designed in an "H" shape. This rigid assembly absorbs vibration and helps keep the top from sagging.

The second function of the base is to provide handy storage space. It doesn't take long to acquire quite a collection of router bits, jigs, and accessories. Now you can organize them in one location.

Make it Mobile. As I mentioned before, the router table is built mostly out of MDF. And that means it's heavy. So I added a pair of heavy-duty casters that allows the router table to be rolled around your shop easily.

TOWERS

I began by building the two side towers, as in Figure 1. They are

really just simple MDF boxes. Before you cut the parts to size, there are two things I want to point out. The first is the shape of the bottom piece. It's designed to project from the back. This will place the casters in just the right spot to roll the table around without it tipping over (Bottom View).

The second thing is that the back is shorter than the sides. This is

because the back rests on the bottom, as illustrated in Figure 1a.

Joinery. The construction of the towers is pretty simple — just rabbet joints reinforced with screws. You'll find the specifics in Figures 1b and 1c. This means you won't need to use a lot of clamps or spend time waiting for glue to dry. A table saw with a dado blade makes quick work of the task.

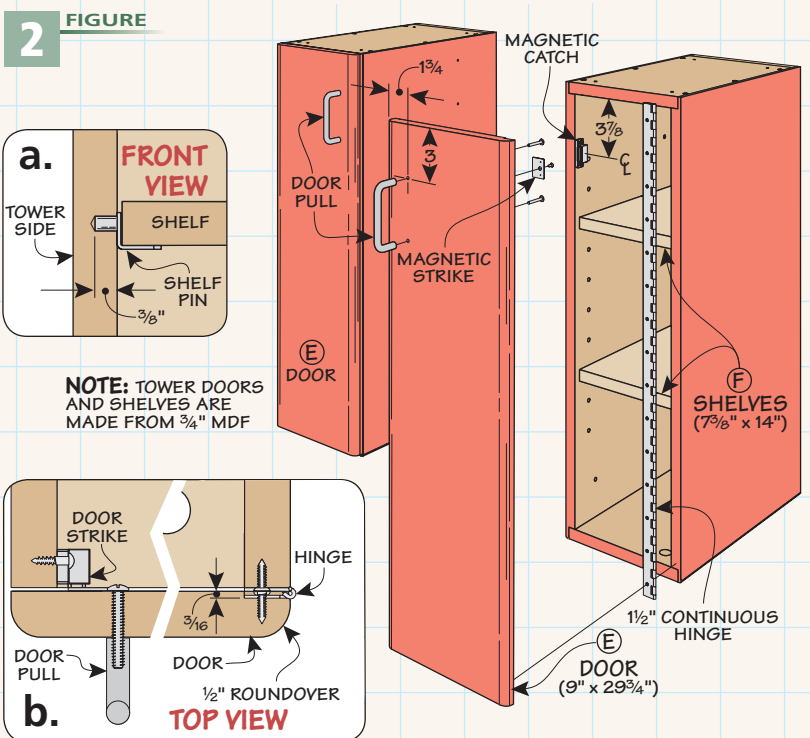

I installed the screws through the top and bottom to hide the screw heads, as shown in Figures 1b and 1c. This puts the screw holes close to the edge. To avoid splitting the sides, you'll want to take care to drill accurately sized pilot and shank holes.

Before assembling the towers, I also took the time to drill holes for shelf pins and a connector piece you'll make later. Since the towers are narrow, it's easier to do this now, as in Figure 1.

Doors. The next pieces to make are the doors (Figure 2). They're nothing more than MDF panels. They have a roundover on each long edge and a shallow rabbet on one edge to accommodate a piano hinge, as shown in Figure 2b.

Shelves. Inside the towers, I added a set of shelves (Figure 2). They're just cut to fit from MDF and rest on the pins.

BASES

Each tower sits on a short base section. The base conceals a caster and a leg leveler, as illustrated in Figure 4. The fixed caster makes moving the router table a snap. And the leveler allows the router table to remain wobble-free on uneven shop floors.

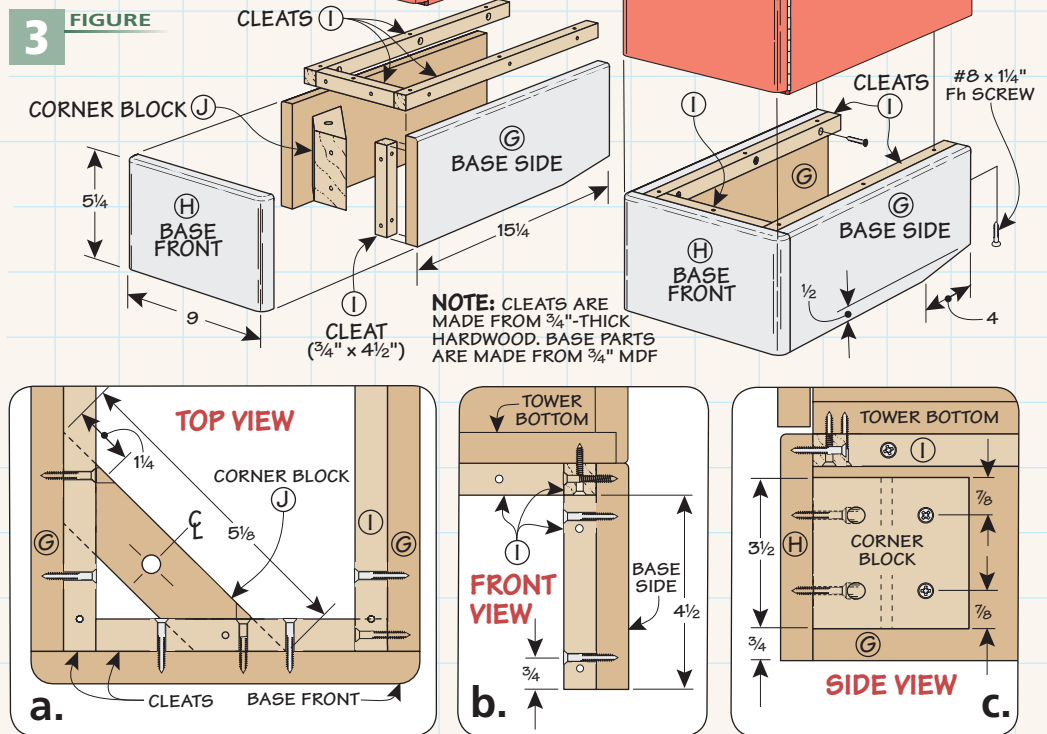

The construction of the base takes a slightly different approach than the tower. Instead of rabbets, the base is assembled with glue, screws, and cleats, as in Figure 3. The cleats also make it easy to attach the base to the tower.

Taper. The base sides have a slight taper cut along the bottom edge, as you can see in Figure 3. This detail provides clearance

when you tilt the router table back and move it around the shop.

Cleats. After cutting the base pieces to size, you can make the cleats, as shown in Figures 3a, 3b and 3c. Since access is tight, it's a good idea to pre-drill the screw holes for attaching the cleats to the base and tower. Then attach the cleats to each base piece before gluing the whole assembly together. At this point, you can attach the bases to the towers (Figure 3).

Leg Leveler. I also made a corner block for each base unit, as in Figure 4. The corner block holds a leg leveler. These non-skid levelers keep the MDF bases from touching the floor where they could get dinged up or absorb moisture.

Once you have the corner block screwed and glued in place, mark and drill an access hole in the tower bottom so you can adjust the leveler from above, as in Figure 1. To adjust the height easily with a socket wrench, an acorn nut is glued on the end of the leveler with epoxy, as illustrated in Figure 4.

Casters. All that's left is to attach the casters to the tower bottom. These are held in place with carriage bolts, washers, and nuts.

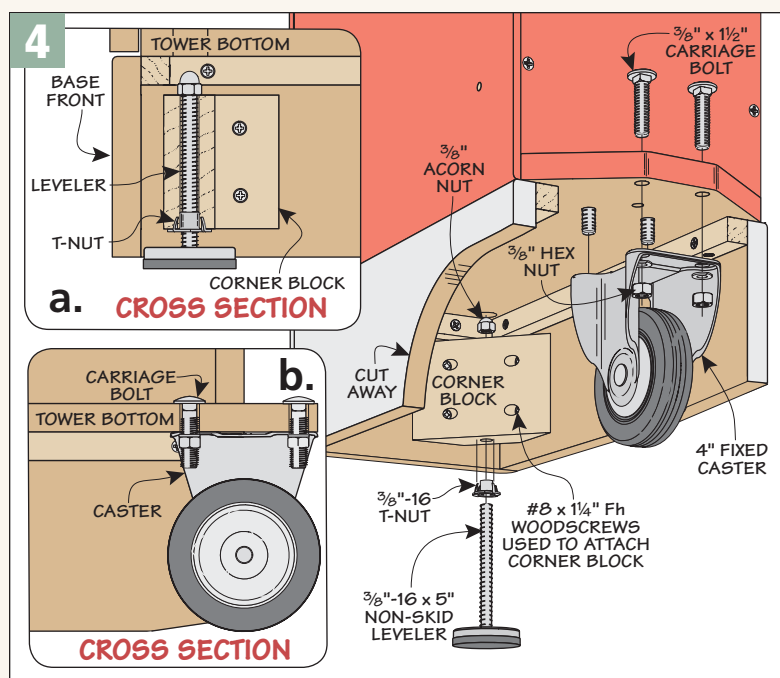

completing The Base

Turning the individual towers into a rock-solid base is the goal of the next stage of construction. To do this, the towers are joined together by a center drawer case and a hardwood support plate. And you'll also create part of the dust collection system.

DRAWER CASE

The first thing to do is build the drawer case. As you can see in Figure 5, it's made the same way as the towers — with rabbets and screws. But there are some differences I want to point out.

Joinery. The main difference is the rabbets are cut into the top and bottom and screwed together from the sides, as in Figures 5a and 5b.

Here again, the idea is to hide the screw heads when the towers are attached on either side. I also drilled holes in the case sides for attaching the case to the towers, as shown in Figure 5.

5 FIGURE

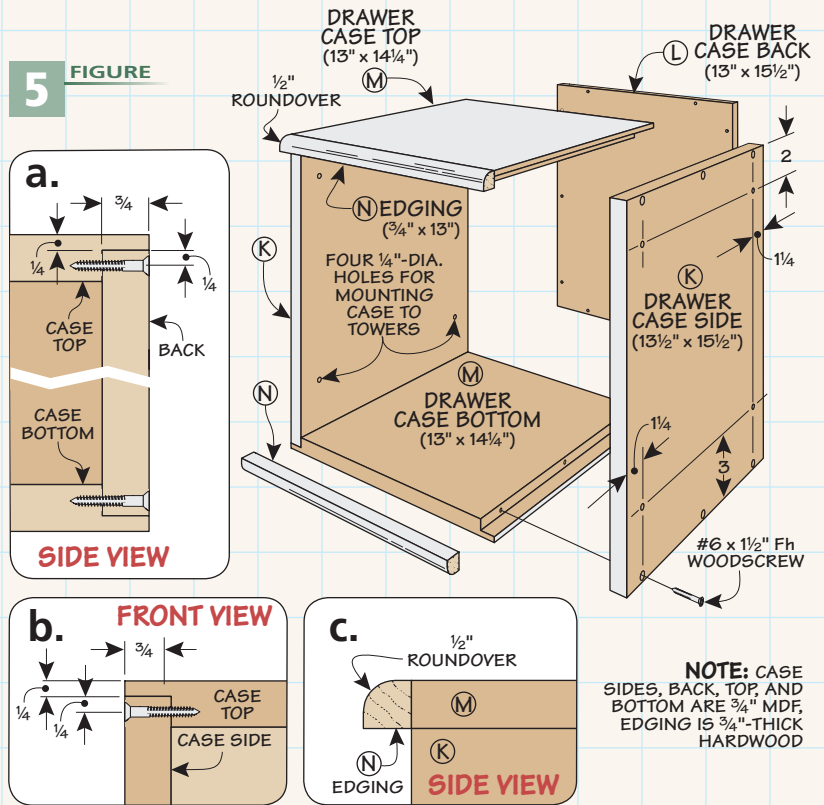

NOTE: CASE SIDES, BACK, TOP, AND BOTTOM ARE 3/4" MDF, EDGING IS 3/4"-THICK HARDWOOD

Edging. Another difference is the edging applied to the top and bottom of the case. It creates a recessed opening that the drawer fronts will fit into later on, as you can see in Figure 5c.

To make the rounded edging, I started by routing a roundover

on an extra-wide blank. The wide blank is safer and easier to control. Then I ripped the edging to width at the table saw. Finally, it's attached to the case after assembly.

Now, you'll set aside the drawer case for the time being to work on part of the dust collection system. You'll need to have it built before the base can be assembled.

DUST COLLECTION

One of the things that sets this router table apart from most isn't readily apparent — the dust collection system. With a single connection point, the table collects chips and dust from either the fence or around the router motor. The key to this is the simple L-shaped box you see in Figure 6.

The box wraps around one of the towers so that it's easy to access the dust port for attaching a shop vacuum or dust collector hose.

Simple Construction. I began by making the box pieces. You'll notice that dados in the long and short side are sized to hold a 1/4 inch hardboard blast gate (Figure 6b). Then I routed a chamfer on the leading edges to soften them and to act as a funnel to direct chips from below the table into the box.

6 FIGURE

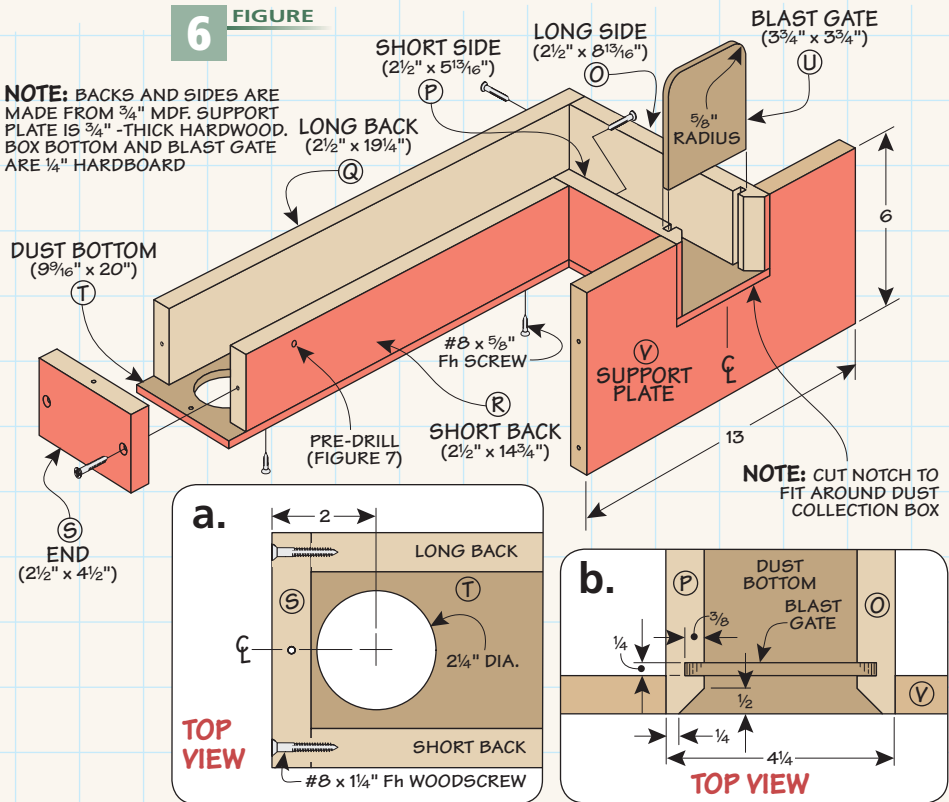

Assembling the box begins with the two L-shaped corner assemblies. The important thing here is that the assemblies are square. Then you can cut and add the end. The last piece to add is the bottom. This is a piece of hardboard with a hole drilled in it to attach a plastic dust port, as in Figure 6a.

When the box is assembled, you can make a blast gate to fit the front opening (Figure 6).

Support Plate. To center the box under the table, I added a support plate, as shown in Figure 6. It's sized to match the width of the drawer case and has a centered notch that fits around the dust box.

Assembly. At this point, you're ready to assemble the base sections. Figure 7 shows you how the pieces go together. I used clamps to keep the drawer case aligned with each tower. Then it's just a matter of using the mounting holes in the drawer case as a guide to drill matching holes in each tower, as shown in 7a. The drawer case can now be bolted to the towers with carriage bolts, washers, and nuts.

The next step is to attach the support plate at the top of the towers. It's mounted with screws (Figure 7b). Then you can fit the dust box into the opening and screw it to the left tower with a screw from the back.

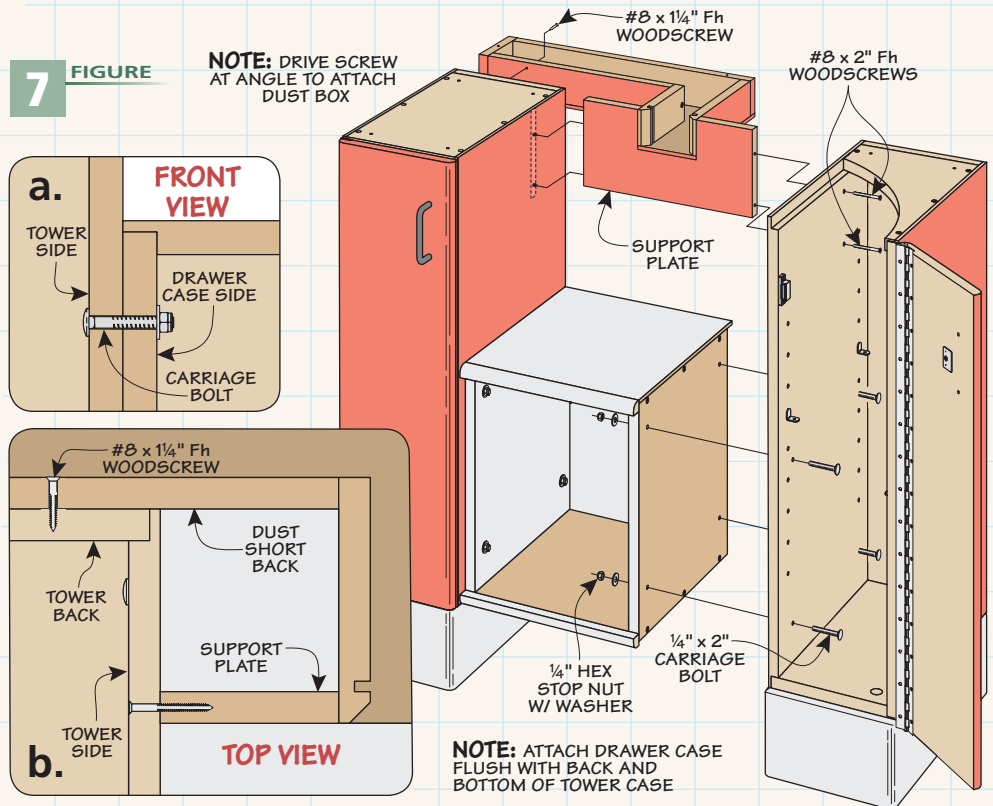

DRAWERS

All that's left to complete the base is to make the drawers that fit in the center case. And combined with the side towers, it provides a lot of versatile storage options.

As you can see in Figure 8, the three drawers are identical. To keep things simple, they're assembled with tongue and dado joinery. This is an easy joint to cut at the table saw. You can find the

details in Figure 8a. Then after cutting a groove for the drawer bottom, they can be glued up.

The drawers slide on full-extension slides. Just be sure to attach the slides at the bottom of the drawer. This way, they'll miss the hardware used to assemble the case.

Once the drawers are in place, you can cut and attach the false fronts. I sized them for an 1/8 inch gap on all edges (Figure 8b).

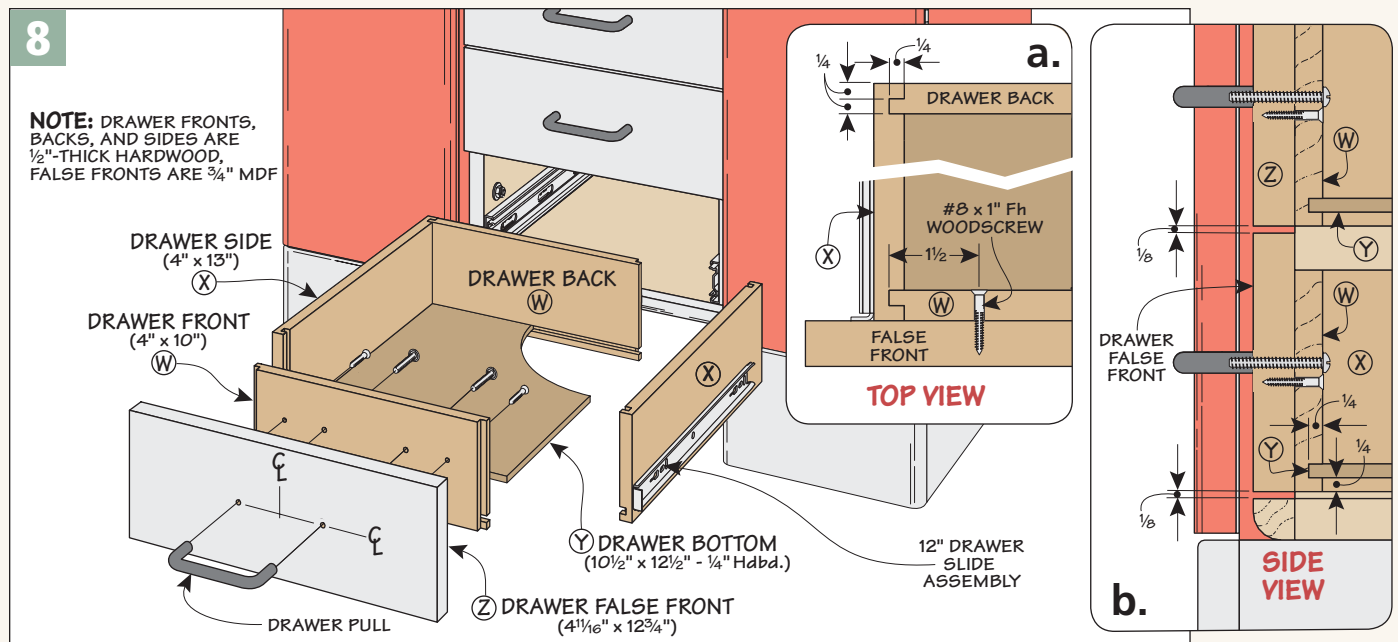

laminated Tabletop



Download a step-by-step article to install a router insert plate as well as plans for the optional door and back panel. Go to our website:

ShopNotes.com

Now that the base is complete, you can turn your attention to the top and fence. The tabletop is where all the action takes place. The router is mounted to an insert plate in the middle. And the fence is positioned using a set of T-tracks in the top. There's even an aluminum miter track that lets you use a miter gauge or other accessories.

Flip-Up Extension. This table also has a unique feature — a small table extension at the back, as shown in Figure 10. This small flip-up table provides more capacity to position the fence farther away from the bit. And it drops down when I don't need it.

In building this section of the router table you have a few goals. First, the tabletop should be as flat and smooth as possible. In addition, the table should be rigid to support the weight of the router without sagging over time. Finally, I also wanted a good way to help control the dust and chips generated by the router.

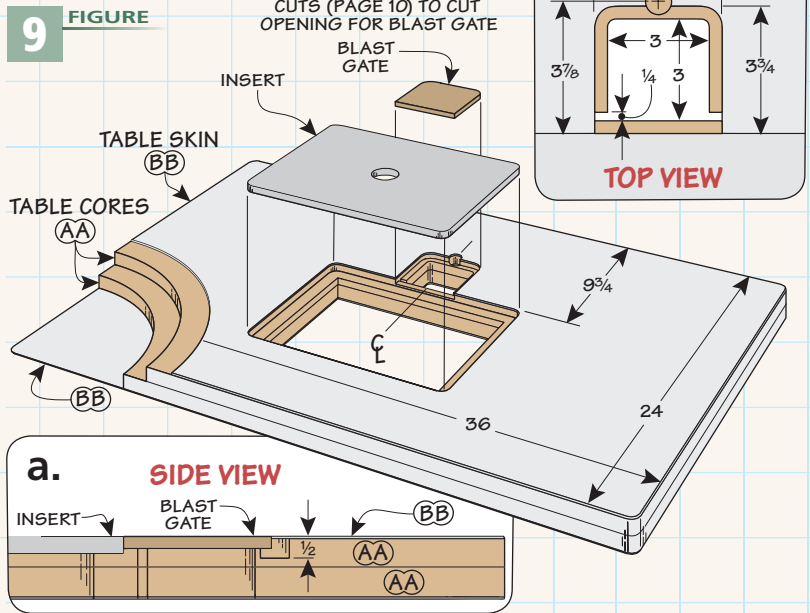

Multi-Layer Top. To accomplish these goals, I started by making the top and extension. You can see how it's made in Figures 9 and 10. In a nutshell, each table is a four-layer sandwich.

In the middle are two layers of 3/4" MDF. This creates a flat, rigid base. And the MDF helps to absorb vibration from the router for cleaner cuts. I started by cutting the pieces of MDF to size and then gluing them together, as shown

in Figure 9. The key when doing this is to keep the assembly flat. I bonded the two layers with spray contact cement. It works fast and I don't have to mess with clamps.

Laminate on the Outside. A layer of plastic laminate on the top and bottom completes the sandwich and provides a smooth,

CUT AND FILE 1/2" OFF TABLE END OF MINI T-TRACK

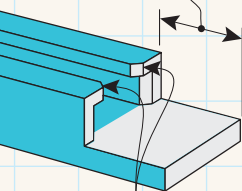

FILE SMALL CHAMFERS

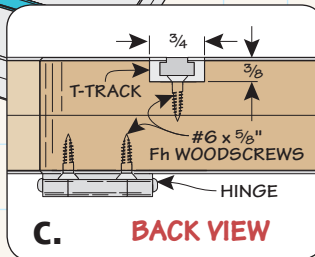
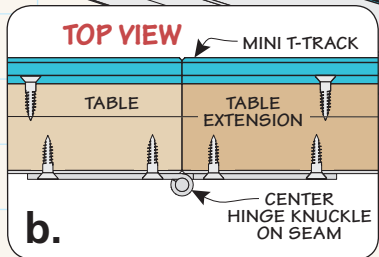
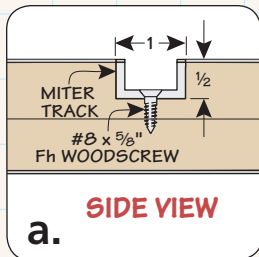
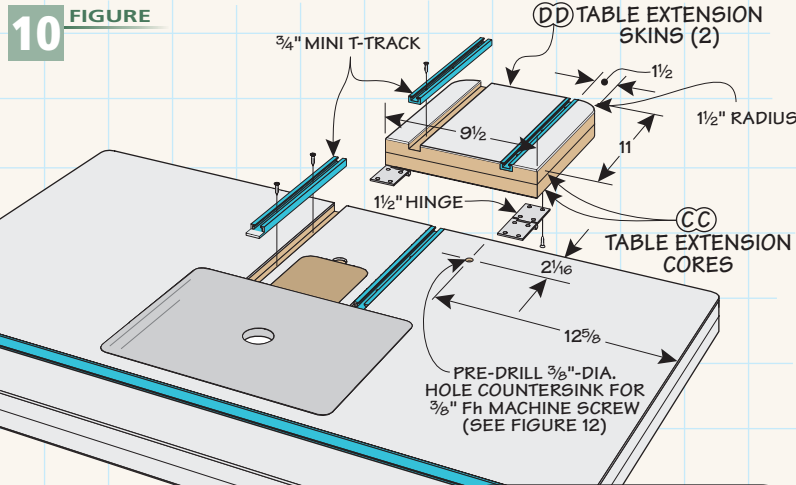

▲ Blast Gate Flush. In this position, dust and chips are collected from below the table.



▲ Flip It Up. Slip the gate into the notches vertically to allow the fence to collect debris above the table.

durable worksurface. When the laminate is in place, you can trim it flush with edges of the MDF using a router and flush trim bit.

Miter Groove. With the top glued up, you're ready to start adding a few details. One of the things to add is a miter slot for a miter gauge. The groove is sized to hold an aluminum miter track, as shown in Figures 10 and 10a.

Two Openings. Next, you'll need to create a pair of openings. The smaller opening is used to channel dust and chips to a shop vacuum. The larger opening holds a router insert plate.

I started with the smaller opening. And you can learn how it's made on page 10. As for the opening for the insert plate, I used a template that came with the plate. Don't worry, if you don't have a template, there's a step-by-step article for this on our website: www.ShopNotes.com.

T-Track. There's one other item to add to the top — the mini T-track used to position the fence. But before making the grooves for the T-track, I attached the table extension to the top with hinges.

A hand-held router is perfect for making the grooves. However, the wide grooves in the table need to line up with the narrow grooves in the fence you'll build later.

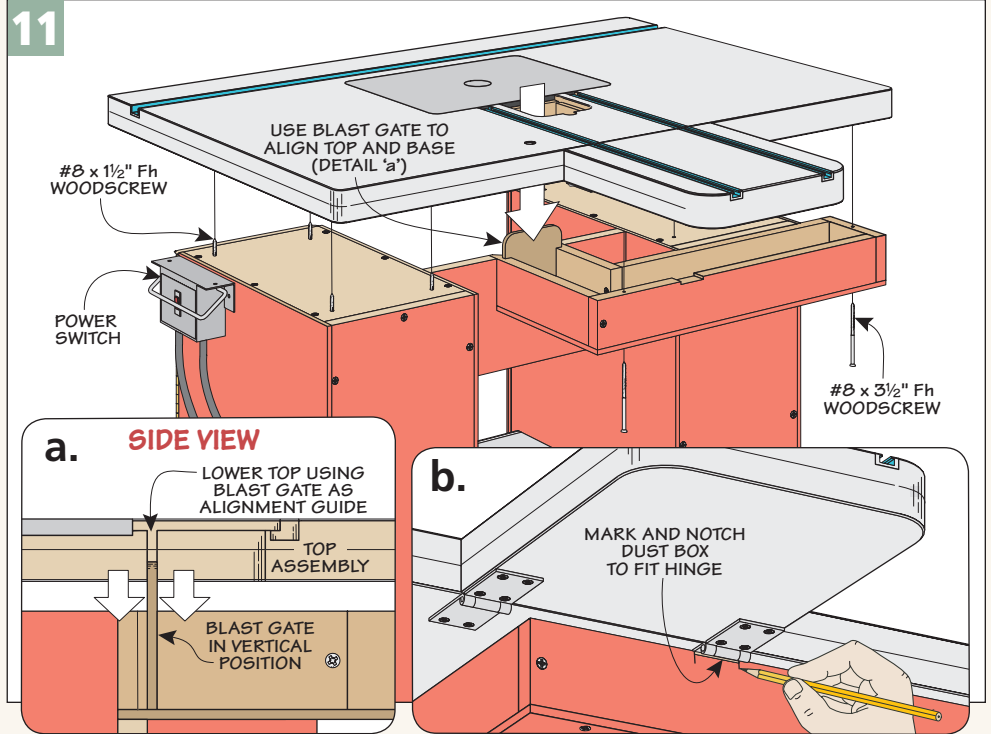

The secret to perfect alignment is to use a template. You can read more about it on page 10.

The T-track can then be cut to fit. Each piece is trimmed back at the front end, as shown in the left margin on previous page 6. This notch creates a space for the hex bolts in the fence to engage in the T-track when you set it in place.

Attach the Table. At this point, you can screw the top to the base (Figure 11). The important thing

here is to align the notches in the top with the dust box (Figure 11a). You'll also need to make a mortise in the dust box to accommodate the hinge, as in Figure 11b.

The final additions to the top are the support arm and power switch (Figure 12). The arm holds the extension level with the tabletop. A pair of leg levelers allows you to fine-tune the extension so that it's level with the top. The switch is simply screwed to the side tower.

▼ **Design Option.** A back panel and a door muffle the sound of the router. You can find plans on our website.

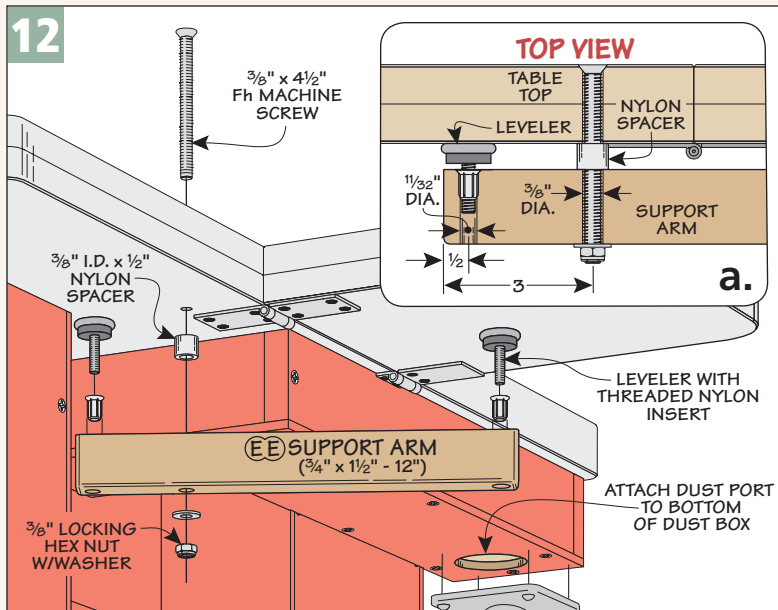



micro-adjustable Fence

At this point, the heavy work of building the router table is complete. All that remains is the fence. I know a few woodworkers who only use a straight board with a notch for a router table fence. And while that works, I wanted to add a few more features.

As I said before, the fence is also a crucial part of the dust collection system built into the router table. A channel in the back directs chips into the dust box (photo above).

Second, I added a T-track to the fence face. This allows me to attach bit guards, featherboards, or stop blocks. The face of this fence is a single, flat piece. This one-piece design isn't likely to go out of alignment or catch on the workpiece as split fences sometimes do.

Micro-Adjuster. A third feature I want to highlight is the micro-adjuster you see in the inset photo at right. And I can't tell how much hassle this saves in making fine



▲ **Fine Tuning.** This micro-adjuster makes it easy to precisely tweak the fence setting.

adjustments to the fence position. It eliminates the "tap-and-hope" method I'd been using for years.

From the Bottom Up. To make the fence, I started with the base. After cutting it to overall size, I routed grooves in the bottom edge to hold hardwood runners, as shown in the upper portion of Figure 13. These runners will guide the fence in the T-track mounted into the tabletop.

To rout the grooves, I used the same template I used for the T-track grooves. But this time, I installed a guide bushing with a 1/4"-dia. straight bit. You can find the details on page 10.

Cut to Shape. Once this is done, it's time for some shaping. There are several details to take care of on the base. The first is cutting the fence base to its final "delta-wing" shape. I did this at the band saw and then filed the edges smooth. A roundover along the back softens the top edges, as illustrated in the lower portion of Figure 13.

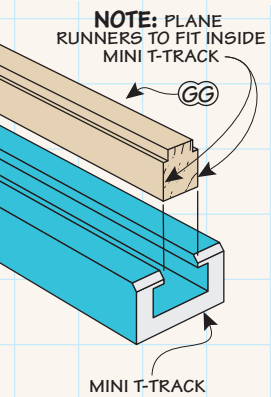

13 FIGURE

STEP 1: LAYOUT BASE BLANK

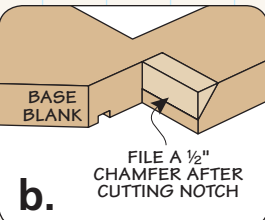
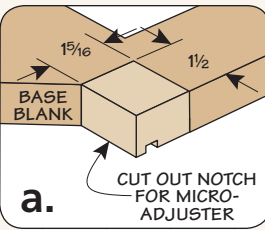
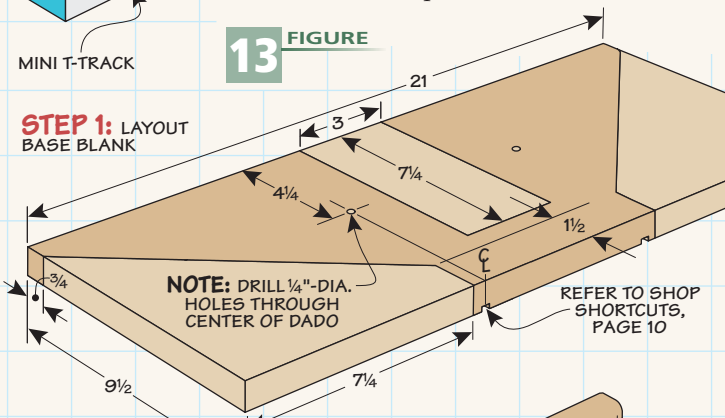

STEP 2: ASSEMBLE BASE COMPONENTS

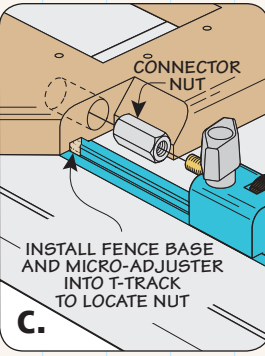
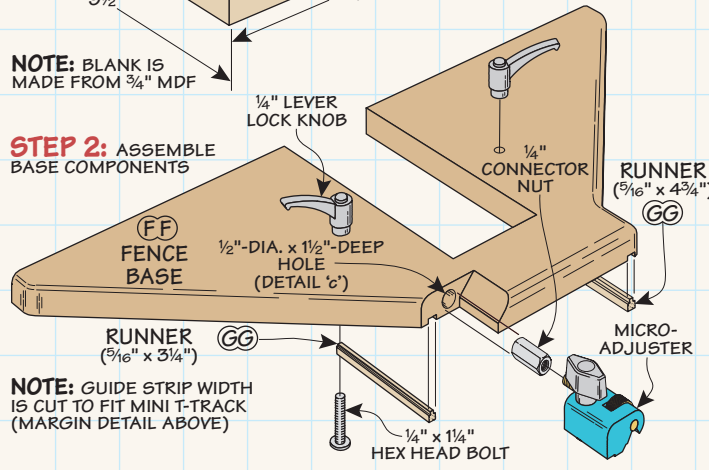

Next, I cut a small notch in one side to accommodate the micro-adjust mechanism for the fence. This is detailed in Figure 13a. To provide better access to the micro-adjuster, there's a wide chamfer on the back side of the fence base (Figure 13b). This can be done with a hand saw and a file.

A Cutout. The next step is to make a cutout for the dust and chip collection. Here again, I turned to the band saw to do the job.

There are also a couple holes drilled in the top for the locking handles that secure the fence.

Runners. Then you can make some runners to fit the grooves in the bottom of the base and the T-track. The trouble is the groove in the top of the T-track is slightly wider than the $\frac{1}{4}$ " grooves in the base. To make the runners, start by planing a wide piece of hardwood to fit the T-track (left margin on the previous page $\text{\textcircled{B}}$). Then cut a small shallow rabbet on each side to fit the groove in the fence base. Aim for a smooth sliding fit with no play. Then, rip the runners to size.

Micro-Adjuster. With the runners glued in, you can set the fence in place to install the micro-adjuster. The adjuster threads into a coupling nut in the base. And for it to

14 FIGURE

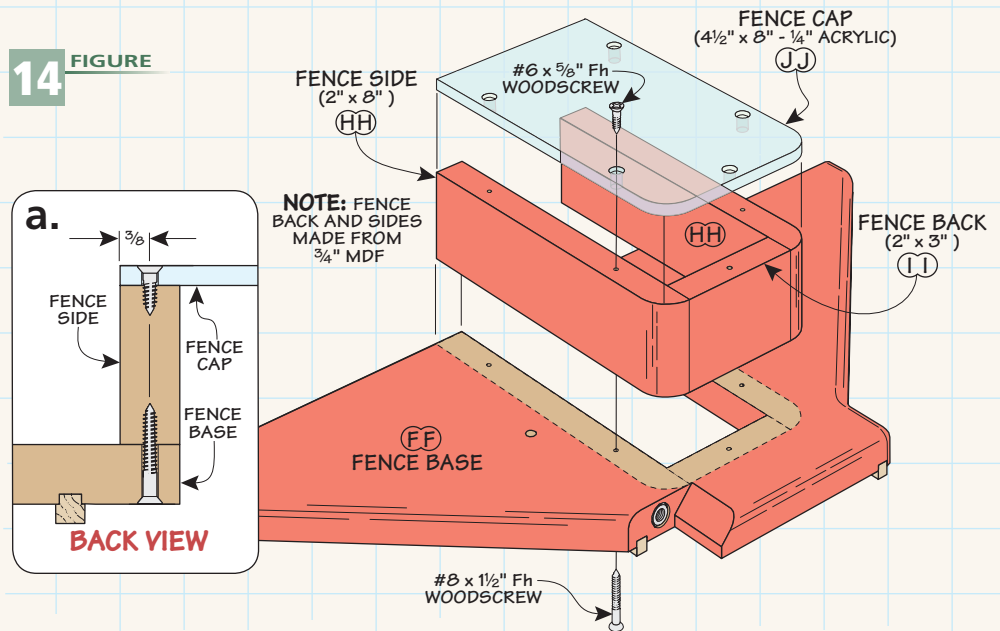

work smoothly, everything needs to be aligned perfectly. Thankfully, there's an easy way to do this.

You can see how it's done in Figure 13c. Drill an oversize hole in the edge of the fence base. Then thread the coupling nut on the micro-adjuster. I "buttered" the outside of the nut with some epoxy and then locked the adjuster into the T-track, pressing the nut into the hole. This keeps everything in alignment until the epoxy hardens.

Dust Channel. Next, I assembled the sides and back of the fence. The back edge is rounded to match the base (Figure 14).

The chute is attached to the base with glue and screws. The top of the chute is a piece of acrylic and is attached with screws (Figure 14a).

Front of the Fence. All that's left to complete the fence is the three-piece front section. Figure 15 has all the details on how it goes together. The front face is attached with machine screws. This way you can make several faces to accommodate different size bits.

At last, you're ready to drop your router into place and fire it up. Then you can enjoy the results of your efforts with smooth, accurate cuts every time.

15 FIGURE

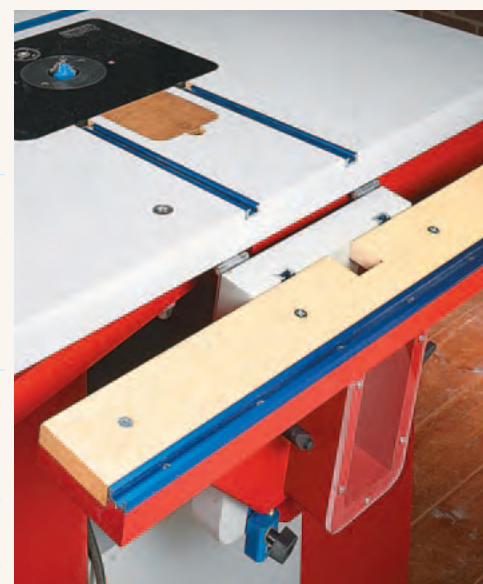
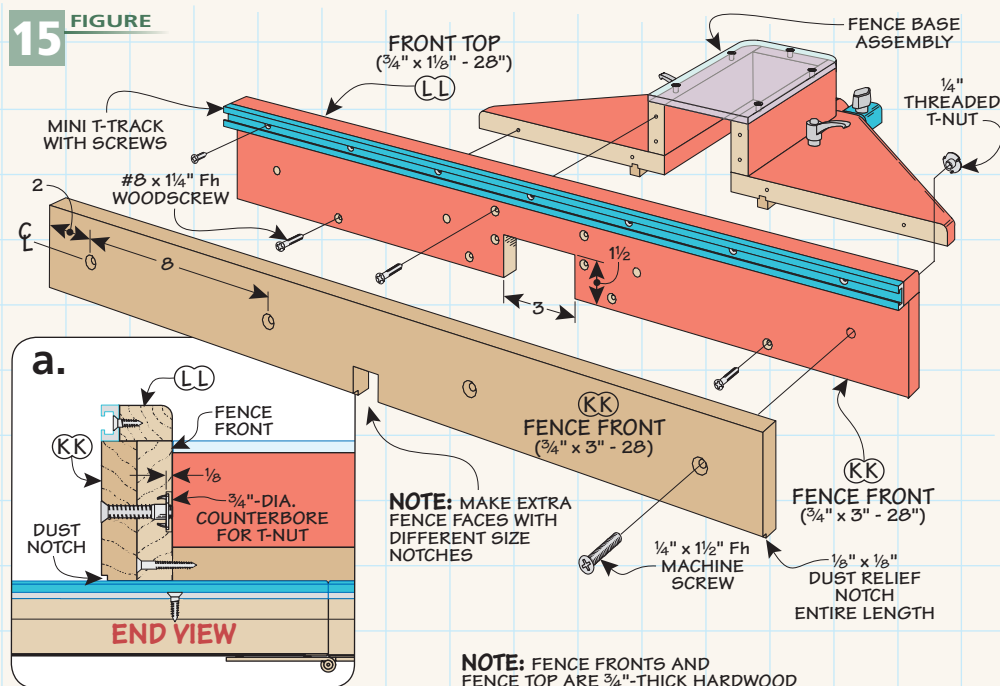

▲ Handy Storage. You can lock the fence to the extension and fold it away when you don't need it.

Making the Blast Gate Pocket

A simple blast gate and opening in our router tabletop will allow you to control how dust and chips are channeled to a shop vacuum. And you'll find creating the opening is a simple process.

Template. I started by laying out the location of the opening as you can see in the drawing at right. To create a clean, accurate opening, I made a simple template to guide a router and pattern bit.

The template is made by wrapping some hardwood scraps around the blast gate you made earlier. I attached the template to the top with double-sided tape.

After setting the bit depth to match the thickness of the blast gate, rout around the inside edge of the template (Step 1). Then to provide a finger hole for removing the blast gate, use a Forstner bit to drill a shallow counterbore along the back edge (Step 2).

Opening. In Steps 3 and 4, you can see how the opening is made. After drilling some starter holes,

you can cut out the waste with a jig saw. I cleaned up the cut edge with a file and some sandpaper.

Notches. Other details to add to the opening are a pair of notches at the front of the opening (Step 5). The notches allow the blast gate to

slide in vertically so dust and chips can be pulled through the fence opening. A hand saw and chisel make quick work of this task. The important thing here is to match the width of the notch to the thickness of the blast gate.

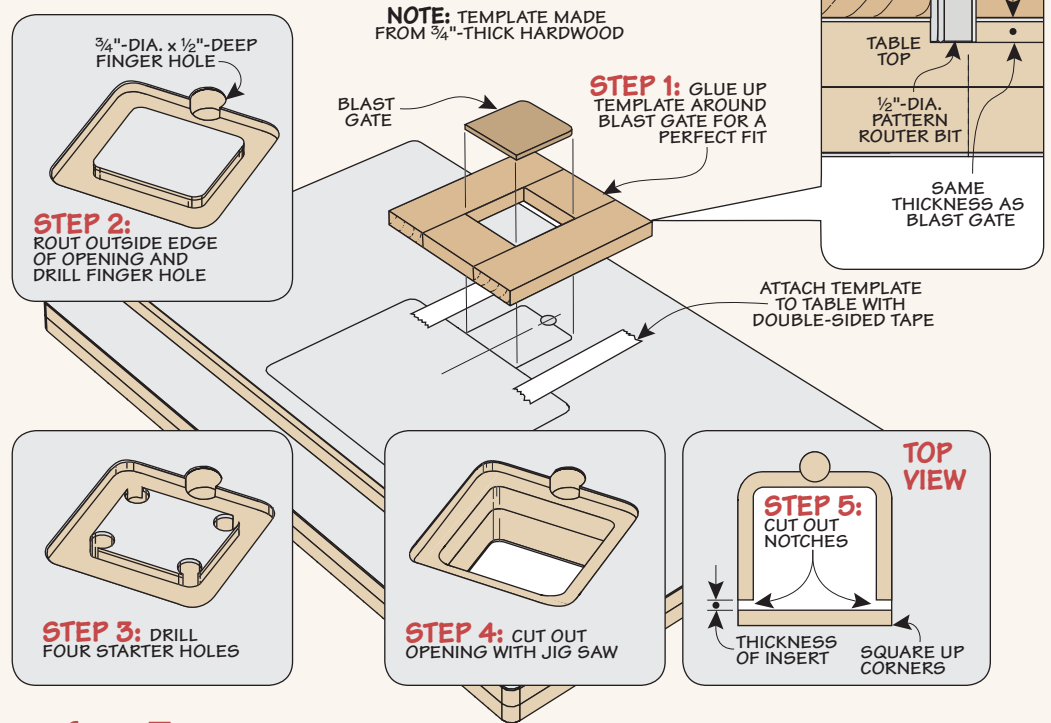

Routing Grooves for Fence

The T-track in the router table needs to be perfectly aligned with the runners in the fence for everything to operate smoothly. To accomplish this, I turned to the template shown in the drawing below and a hand-held router.

Table Grooves. After attaching the template to the table and extension, I used a 3/4"-dia. pattern bit to rout the T-track grooves, as you can see in the detail 'a.' It's a good idea to rout the grooves in several, shallow passes.

Fence Grooves. To rout the grooves in the fence base, I used a 3/4" O.D. guide bushing and a 1/4" straight bit, as in detail 'b.' The bushing guarantees that the grooves in the fence are centered over the grooves in the tabletop.

