

ULTIMATE SLIDING FRENCH DOOR ULTIMATE WOOD SLIDING FRENCH DOOR

Table of Contents

	PAGE
History	2
Part Identification	
Ultimate Wood Sliding French Door – OX or XO	4
Ultimate Wood Sliding French Door – 3 Panel OXO, 3 Panel XOO, 4 Panel OXXO Jamb Detail	5
Ultimate Wood Sliding French Door – Interior Flat Oak Sill	6
Ultimate Wood Sliding French Door In–Sash Transom	7
Ultimate Wood Sliding French Door In–Sash Transom Jamb Detail	8
Ultimate Wood Sliding French Door Direct Glaze Transom	9
Ultimate Wood Sliding French Door Stationary	10
Ultimate Sliding French Door – OX or XO	11
Ultimate Sliding French Door – 3 Panel OXO, 3 Panel XOO,4 Panel OXXO Jamb Detail	12
Ultimate Sliding French Door In–Sash Transom	13
Ultimate Sliding French Door In–Sash Transom Jamb Detail	14
Ultimate Sliding French Door Direct Glaze Transom	15
Ultimate Sliding French Door Stationary	16
Parts	
Parts	17
Auxiliary Foot Bolt Kit	23
Wood Parts	24
Vinyl Parts	25
Vinyl and Fiberglass Parts	26
Aluminum Parts	27
Weather Strip	28
Panel Replacement	29
Parts for Lock Status Sensor	30
Discontinued Limited Availability (LA) Parts	31
Discontinued Limited Availability (LA) Weather Strip and Vinyl	32
Discontinued Limited Availability (LA) Vinyl and Aluminum	33
Discontinued Limited Availability (LA) Wood Parts	34
Discontinued Limited Availability (LA) Panel Replacement	35
Discontinued No Availability (NA) Parts	36
Discontinued No Availability (NA) Vinyl, Aluminum and Fiberglass	39
Discontinued No Availability (NA) Weather Strip	40
Discontinued No Availability (NA) Wood Parts	41

Screens – See Door Screen Chapter

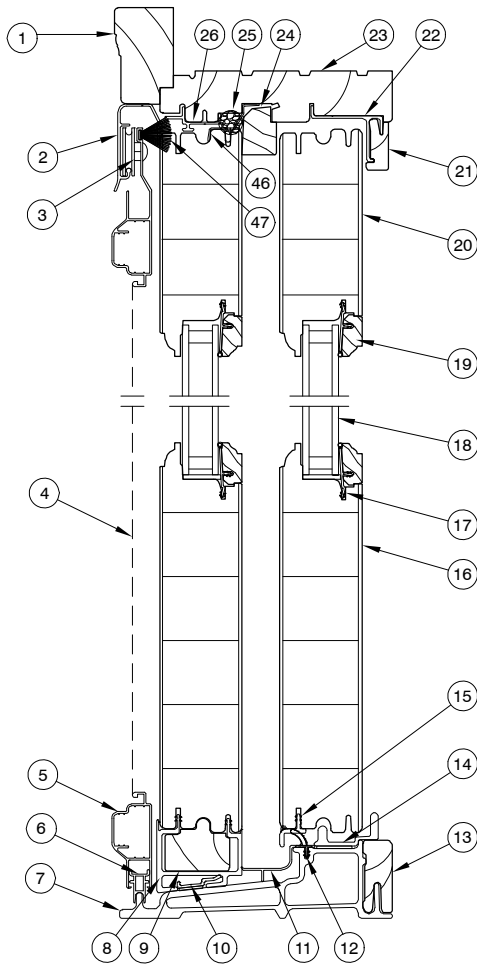
ATTENTION:

- Specification and technical data are subject to change without notice.
- Numbers listed in parentheses () are metric equivalents in millimeters rounded to the nearest whole number.

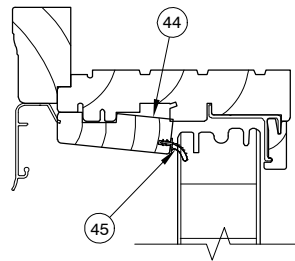
PRODUCED	UNIT TYPE	FEATURES OR CHANGES	STATUS
1991	Ultimate Wood Sliding French Door Disc LA Pre 5/6/02	Introduced the Ultimate Wood Sliding French Door. Unit features no exposed nail or staple holes, multi-point locking system, solid brass handles and top hung screen. Introduced in-sash transom. Unit features matching sight lines.	Present
1992	Ultimate Wood Sliding French Door Disc LA Pre 5/6/02	Simulated divided lite option introduced.	Present
1993	Ultimate Wood Sliding French Door Disc LA Pre 5/6/02	Optional hardware introduced including antique brass, polished or brushed chrome and white handles. Screen auto-closer introduced. Rollers, guide bars and screen width reduced 3/8".	Present
1994	Ultimate Wood Sliding French Door Disc LA Pre 5/6/02	Direct glaze transoms offered for the Ultimate Wood Sliding French Door. Transoms feature sill designed for field mulling. Added standard sizes to in-sash transoms. Flat oak sill offered for interior applications.	Present
1995	Ultimate Sliding French Door Disc LA Pre 5/6/02	Introduced the Ultimate Sliding French Door and matching in-sash transom. Unit features design similarity and options of the wood model with an extruded aluminum clad exterior.	Present
2000	Ultimate Wood Sliding French Door Disc LA Pre 5/6/02 Ultimate Sliding French Door Disc LA Pre 5/6/02	1/31/00 Redesigned and standardized frame profiles and related parts.	Present
2002	Ultimate Wood Sliding French Door Disc LA Pre 5/6/02 Ultimate Sliding French Door Disc LA Pre 5/6/02	3/02 Stone White becomes a standard color. Arctic White transitions to a select color. 8/0 height decreases by 2 1/2 inches.	Present
2002	Ultimate Sliding French Door (USFD) Ultimate Wood Sliding French Door (UWSFD)	5/02 New Ultimate hardware and screen options. New standard hardware and screen options. New frame components.	Present
2004	USFD, UWSFD	1/04 Added Oiled Rubbed Bronze and Satin Chrome to available hardware finishes.	Present
2004	USFD, UWSFD	4/12/04 Satin Nickel hardware finish introduced.	Present
2004	USFD, UWSFD	6/14/04 Ultimate Wood and Ultimate Sliding French Direct Glaze transom redesigned. Polished Chrome hardware finish retired.	Present
2005	USFD, UWSFD	6/27/05 Introduced Brass PVD and Satin Nickel PVD finishes to French door handles, and other miscellaneous parts.	Present
2006	USFD, UWSFD	7/24/06 Discontinued retro 6-5 height and replaced with 6-6 height. Frame OSM for 6-6 height is 3/4" taller than 6-5 doors. Frame OSM for 6-6 width is 11/16" wider (one panel), 1 3/8" wider (two panel) and 2 1/16" wider (three panel).	Present
2006	USFD, UWSFD	11/2006 Discontinued stationary panel top rail spacer (W8452) and replaced with a stationary bracket. Updated W7504 stationary panel head jamb cover profile.	Present
2007	USFD, UWSFD	2/20/07 Introduced raised and flat panels as a standard option for Marvin Ultimate French Doors and Ultimate Commercial Doors.	Present
2008	USFD, UWSFD	6/02/2008 Introduced charcoal high transparency screen mesh (CH HI-TRAN) as an option on all window and door products (including combinations).	Present
2008	USFD	7/28/2008 Mixed grain Douglas fir is now a standard option.	Present

PRODUCED	UNIT TYPE	FEATURES OR CHANGES	STATUS
2009	All Doors	3/23/2009 Added LoE ³ -366™ as a standard option for all products. Added Cedro Macho as a standard option for all Ultimate products.	Present
2009	USFD, UWSFD	5/26/2009 Introduced the new Low Profile Sill as an option to the Ultimate Sliding French Door.	Present
2010	All Doors	2/22/2010 Added Dark Bronze hardware finish to doors.	Present
2010	USFD, UWSFD	10/25/2010 Added 7-0 height.	Present
2011	All	04/25/2011 Added LoE-180™ as a standard option for all products. White painted interior finish option introduced for all product.	Present
2012	All	07/30/2012 Stave Core added to our description for current finger joint/edge glue construction of door panels. 10/29/2012 Interior Square Sticking/Glazing Bead option introduced. 12/17/2012 Introduced Clear interior finish option on all products.	Present
2013	All	4-29-2013 – Introduced Retro 2 Wide CNs on Full Size Heights. New CNs are 50R68, 50R70, 50R80, 60R68, 60R70, 60R80, 80R68, 80R70, 80R80. All Retro sizes, current and new, will be designated with an “R” in the CN. Introduced interior stain options. Stain colors are Wheat, Honey, Leather, Hazelnut, Cabernet and Espresso. 6/24/2013 – Direct Glaze Standardization added upgrades and improvements to direct glaze products in both Ultimate and Ultimate Wood. Glazing method is silicone and interior tape glazed. Wood bead profile is W11751. 12/16/2013 – Interior Shades option introduced.	Present
2014	All	2/24/2014 – Introduced two Pearlescent colors; Bright Silver and Copper. Discontinued two colors; Sherwood Green and Cobalt Blue. Removed screen information and added new chapter for screen to manual.	Present
2014	All	10/27/2014 – Introduced Ogee as the new standard for interior profiles.	Present
2016	All	10/31/2016 Introduced 9-0 Call No heights 10/31/2016 Obsolescence of the wood species Cedro Macho for all products.	Present
2016	All	11/1/2016 – V1012 panel drip was replaced by V1823.	Present
2017	USFD	12/18/2017 – Added availability of Lock Status Sensor.	Present
2019	All	04/29/2019 – V1194 replaces V1138 (ECN 23234)	Present

ULTIMATE WOOD SLIDING FRENCH DOOR

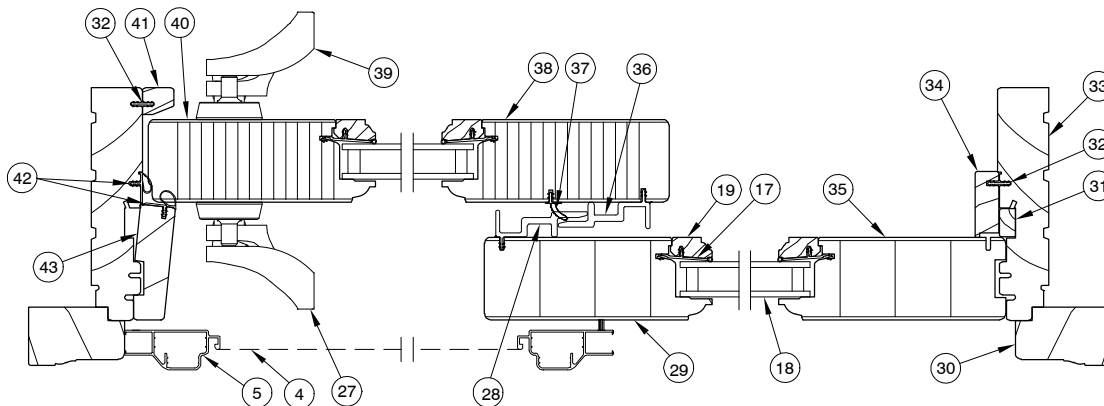


Head Jamb and Sill



**Operator
Side Detail**

1. Top Brick Mould Casing
2. Screen Track
3. Screen Roller
4. Screen
5. Screen Frame
6. Screen Bottom Guide
7. Ultrex Sill
8. Leveling Block, V1755
9. Leveling Block Filler, W8270
10. Sill Stationary Panel Retainer
11. Sill Condensation Cover, V1131
12. Sill Weather Strip, V1194
13. Sill Liner, W2528
14. Sill Roller Track, V1745
15. Panel Drip, 1823
16. Bottom Rail
17. Glazing Bead
18. Insulating Glass
19. Glazing Cap
20. Top Rail
21. Panel Guide Cover, W8040
22. Panel Guide, A1014
23. Head Jamb
24. Stationary Panel Cover, W7504
25. Backer Rod
26. Stationary Panel Top Filler
27. Exterior Handle Assembly
28. Stationary Panel Interlock, V1828
29. Stationary Meeting Stile
30. Side Brick Mould Casing
31. Stationary Jamb Filler
32. Connecting Barb, V803
33. Jamb
34. Stationary Jamb Cover, W7535
35. Stationary Jamb Stile
36. Operating Panel Interlock, V1828
37. Meeting Stile Weather Strip, V1194
38. Operating Meeting Stile
39. Interior Handle Assembly
40. Operating Locking Stile
41. Jamb Liner, W7536
42. Jamb/Jamb Parting Stop Weather Strip, V796
43. Jamb Parting Stop, W6535
44. Head Jamb Parting Stop, W6535
45. Head Jamb Parting Stop Weather Strip, V1194
46. Stationary Panel Bracket
47. Pile Weather Strip

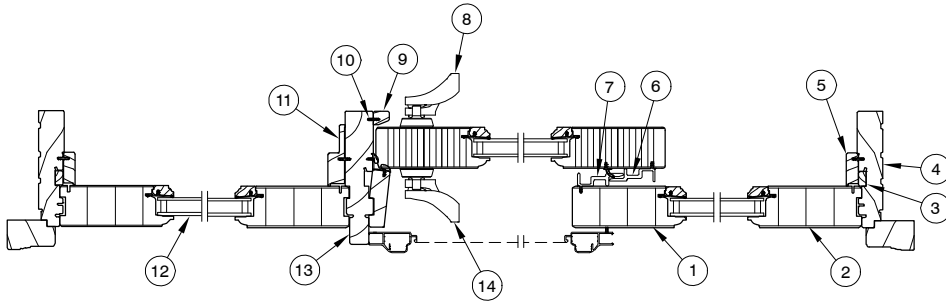


Jamb - XO

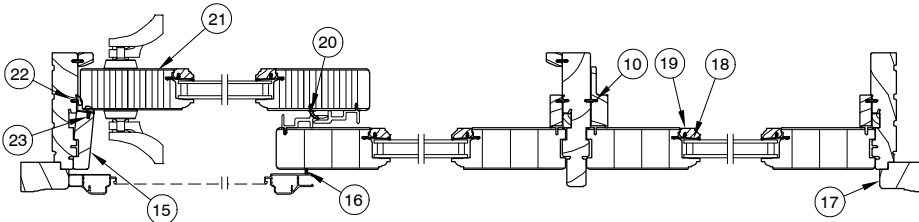
NOTE: Not to scale; specifications subject to change without notice.

ULTIMATE WOOD SLIDING FRENCH DOOR

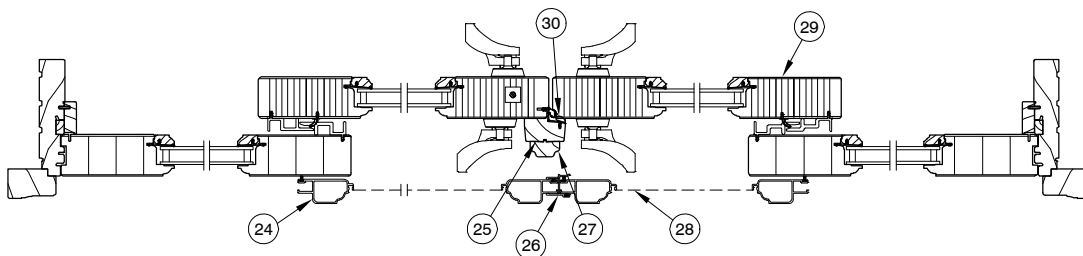
Jamb Detail



Jamb - 3 Panel OXO



Jamb - 3 Panel XOJ

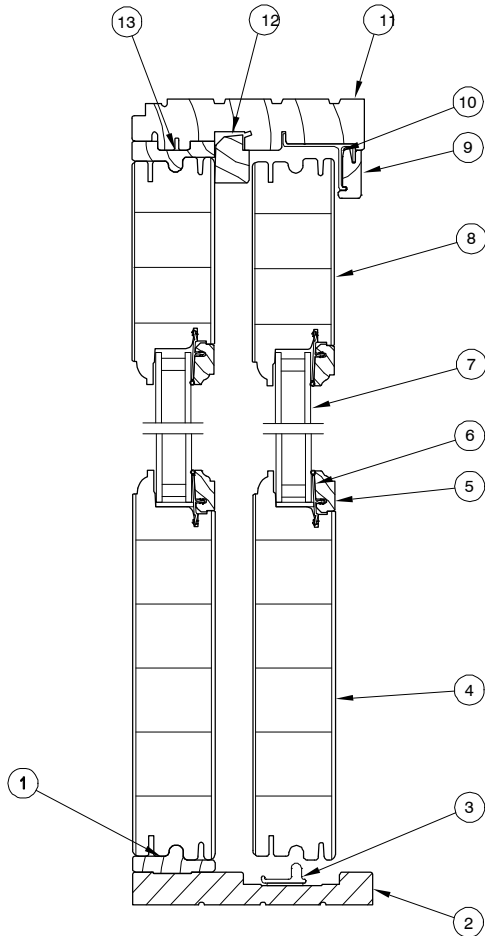


Jamb - 4 Panel OXJO

1. Stationary Meeting Stile
2. Stationary Jamb Stile
3. Stationary Panel Filler
4. Jamb
5. Stationary Jamb Cover
6. Operating Panel Interlock
7. Stationary Panel Interlock
8. Interior Handle Assembly
9. Jamb Liner
10. Connecting Barb
11. Center Jamb Cover
12. Insulating Glass
13. Center Jamb
14. Exterior Handle Assembly
15. Jamb Parting Stop
16. Screen Pile Weather Strip
17. Side Brick Mould Casing
18. Glazing Bead
19. Glazing Cap
20. Meeting Stile Weather Strip, V1194
21. Operating Locking Stile
22. Jamb Weather Strip
23. Parting Stop Weather Strip
24. Screen Frame
25. Mull Casing Bead
26. Screen Astragal
27. Mull Casing Cover
28. Screen
29. Operating Meeting Stile
30. Mull Casing Stile Weather Strip

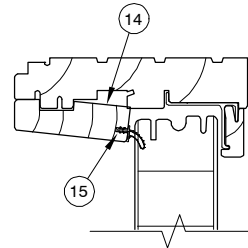
NOTE: Not to scale; specifications subject to change without notice.

**ULTIMATE WOOD SLIDING FRENCH DOOR
WITH INTERIOR FLAT OAK SILL**



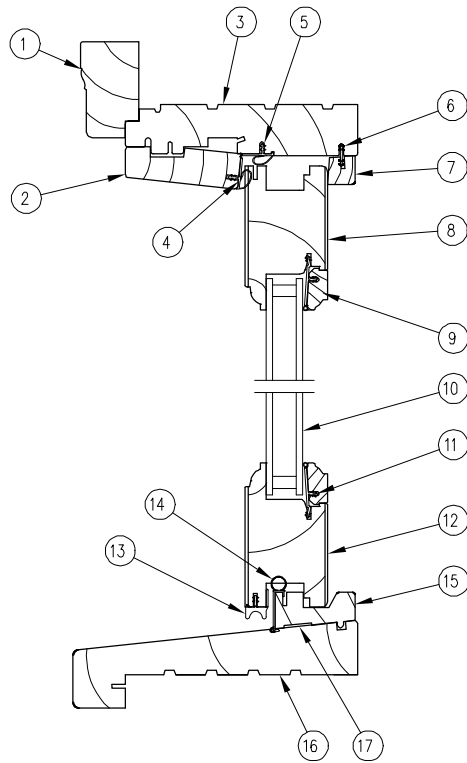
Head Jamb and Sill

1. Stationary Retaining Block
2. Interior Flat Sill
3. Sill Track
4. Bottom Rail
5. Glazing Cap
6. Glazing Bead
7. Insulating Glass
8. Top Rail
9. Panel Guide
10. Panel Guide Fastener
11. Head Jamb
12. Panel Top Track
13. Stationary Panel Top Filler
14. Head Jamb Parting Stop
15. Parting Stop Weather Strip, V1194



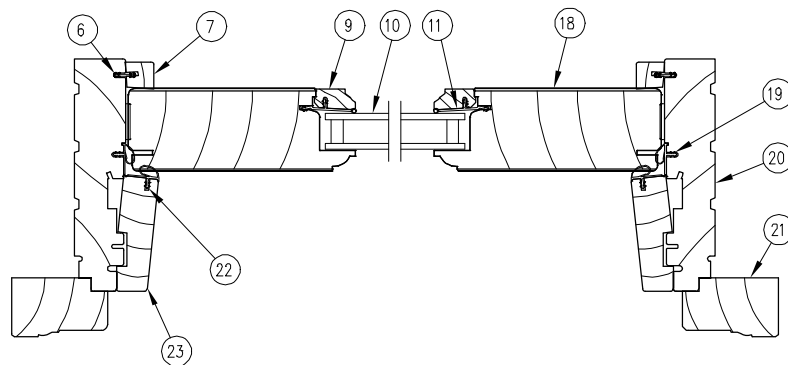
Operator Side

ULTIMATE WOOD SLIDING FRENCH DOOR TRANSOM



- 1. Top Brick Mould Casing
- 2. Head Jamb Parting Stop
- 3. Head Jamb
- 4. Parting Stop Weather Strip
- 5. Head Jamb Weather Strip
- 6. Connecting Barb
- 7. Interior Cover
- 8. Top Rail
- 9. Glazing Cap
- 10. Insulating Glass
- 11. Glazing Bead
- 12. Bottom Rail
- 13. Panel Drip
- 14. Sill Filler Weather Strip
- 15. Sill Filler
- 16. Transom Sill
- 17. Foam Tape

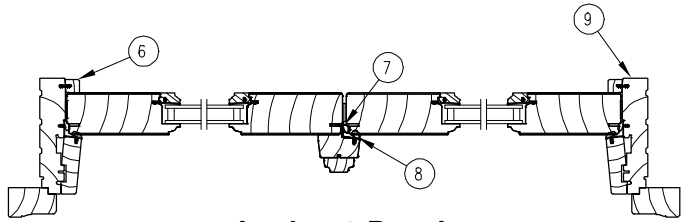
Head Jamb and Sill



Jamb

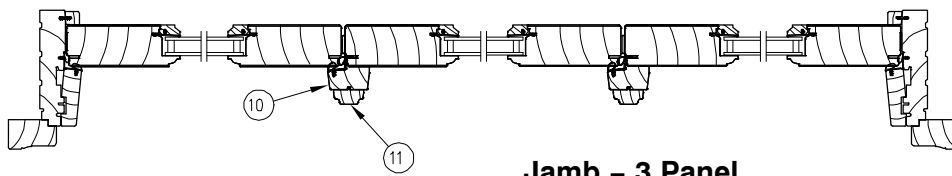
NOTE: Not to scale; specifications subject to change without notice.

**ULTIMATE WOOD SLIDING FRENCH DOOR TRANSOM
JAMB DETAIL**

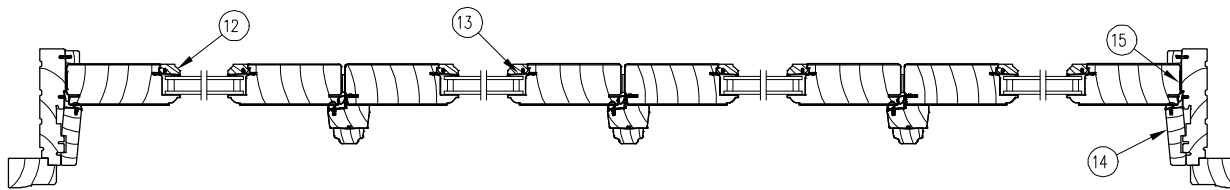


Jamb - 2 Panel

1. Side Jamb
2. Side Brick Mould Casing
3. Insulating Glass
4. Side Jamb Weather Strip
5. Side Jamb Parting Stop Weather Strip
6. Interior Cover
7. Stile Weather Strip
8. Mull Casing Weather Strip
9. Connecting Barb
10. Second Mull Casing
11. First Mull Casing
12. Glazing Cap
13. Glazing Bead
14. Side Jamb Parting Stop
15. Stationary Panel Spacer Tack



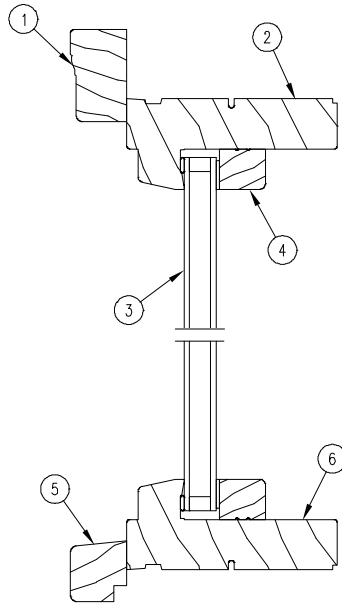
Jamb - 3 Panel



Jamb - 4 Panel

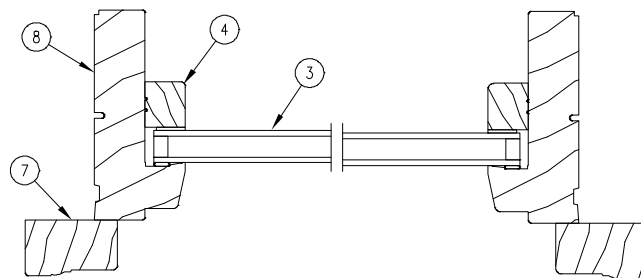
NOTE: Not to scale; specifications subject to change without notice.

ULTIMATE WOOD SLIDING FRENCH DOOR DIRECT GLAZE TRANSOM



- 1. Head Jamb Brick Mould Casing
- 2. Head Jamb
- 3. Insulating Glass
- 4. Glazing Bead (W11751)
- 5. Sill Nose
- 6. Sill
- 7. Jamb Brick Mould Casing
- 8. Jamb

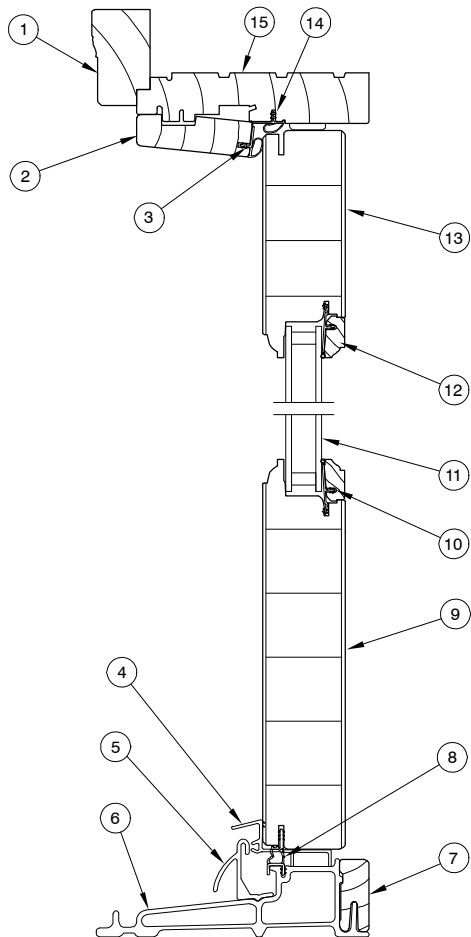
Head Jamb and Sill



Jamb

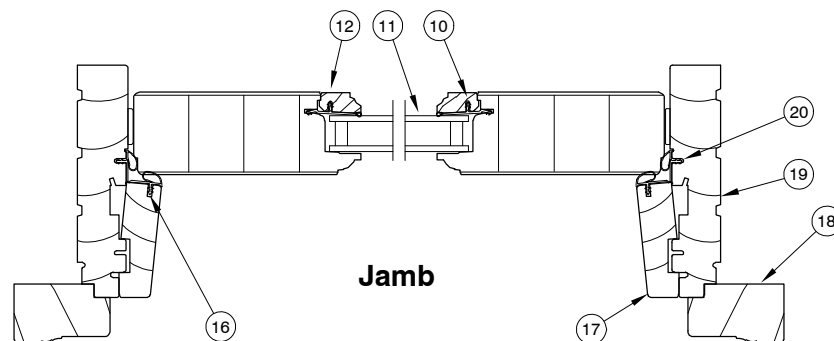
NOTE: Not to scale; specifications subject to change without notice.

ULTIMATE WOOD SLIDING FRENCH DOOR STATIONARY



- 1. Top Brick Mould Casing
- 2. Head Jamb Parting Stop
- 3. Parting Stop Weather Strip, V794
- 4. Panel Drip
- 5. Hydro Optimizer
- 6. Ultrex Sill
- 7. Sill Liner
- 8. Sill Weather Strip, V794
- 9. Bottom Rail
- 10. Glazing Bead
- 11. Insulating Glass
- 12. Glazing Cap
- 13. Top Rail
- 14. Head Jamb Weather Strip, V794
- 15. Head Jamb
- 16. Parting Stop Weather Strip, V794
- 17. Jamb Parting Stop
- 18. Side Brick Mould Casing
- 19. Jamb
- 20. Jamb Weather Strip, V794

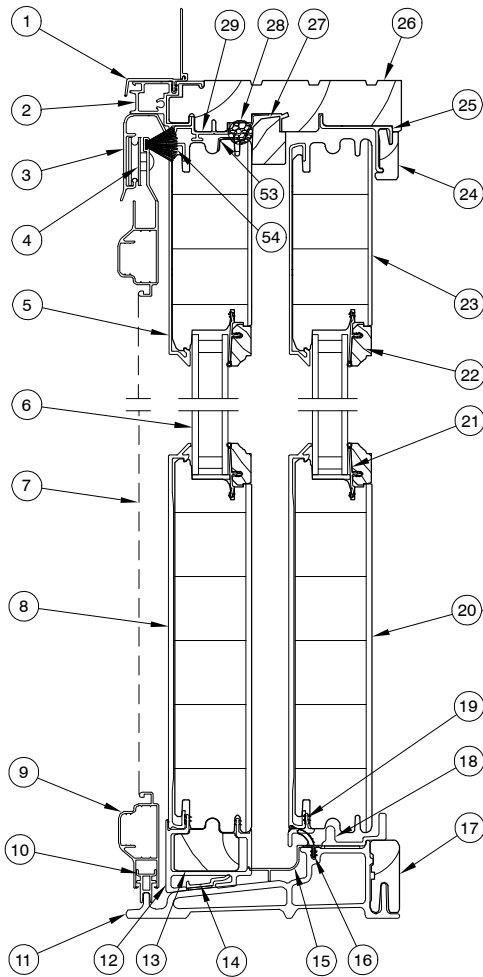
Head Jamb and Sill



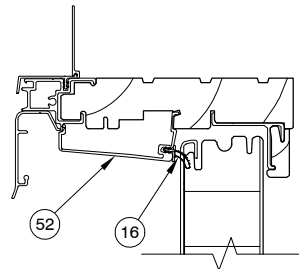
Jamb

NOTE: Not to scale; specifications subject to change without notice.

ULTIMATE SLIDING FRENCH DOOR XO

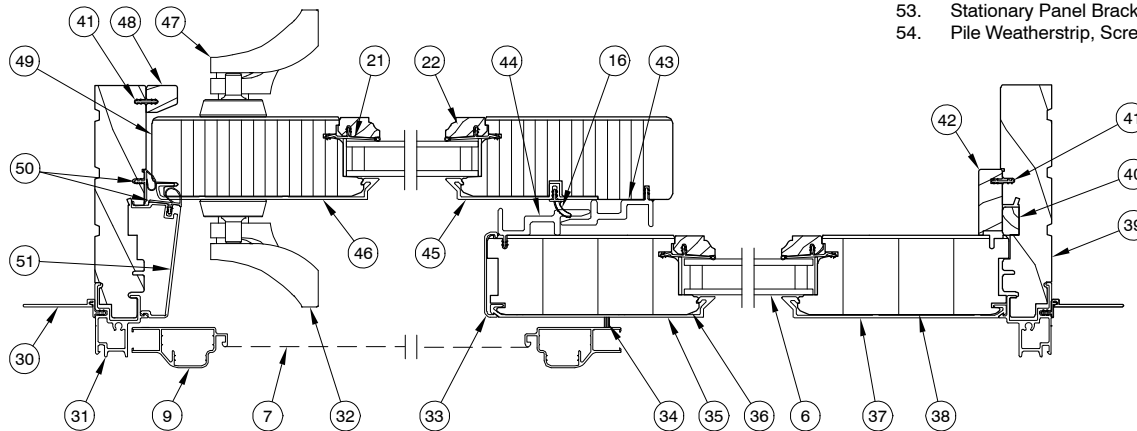


Head Jamb and Sill



Operator Side Detail

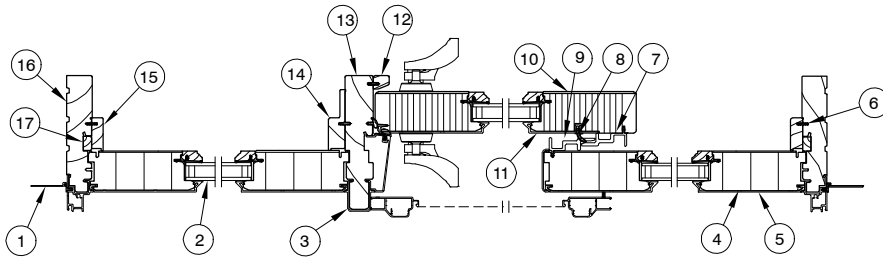
1. Head Jamb Nailing Fin/Drip Cap
2. Head Jamb Cladding
3. Screen Track
4. Screen Roller
5. Top Rail Cladding
6. Insulating Glass
7. Screen Mesh
8. Bottom Rail Cladding
9. Screen Frame
10. Screen Guide Bar
11. Sill
12. Leveling Block, V1755
13. Leveling Block Filler, W8270
14. Sill Stationary Panel Retainer
15. Sill Condensation Cover, V1131
16. Sill, Meeting Stile and Head Jamb Weather Strip, V1194
17. Sill Liner, W2528
18. Sill Roller Track, V1745
19. Panel Drip, V1823
20. Bottom Rail
21. Glazing Bead
22. Glazing Cap
23. Top Rail
24. Panel Guide Cover, W8040
25. Panel Guide, A1014
26. Head Jamb
27. Stationary Panel Cover, W7504
28. Backer Rod
29. Stationary Panel Top Filler
30. Jamb Nailing Fin
31. Jamb Cladding
32. Exterior Handle Assembly
33. Edge Cover, A778
34. Screen Pile Weather Strip
35. Stationary Meeting Stile Cladding
36. Stationary Meeting Stile
37. Stationary Jamb Stile Cladding
38. Stationary Jamb Stile
39. Jamb
40. Stationary Jamb Filler
41. Connecting Barb, V803
42. Stationary Jamb Cover, W7535
43. Operator Panel Interlock, V1828
44. Stationary Panel Interlock, V1828
45. Operating Meeting Stile Cladding
46. Operating Locking Stile Cladding
47. Interior Handle Assembly
48. Jamb Liner, W7536
49. Operating Locking Stile
50. Jamb/Jamb Parting Stop Weather Strip, V796
51. Jamb Parting Stop
52. Head Jamb Parting Stop
53. Stationary Panel Bracket
54. Pile Weatherstrip, Screen



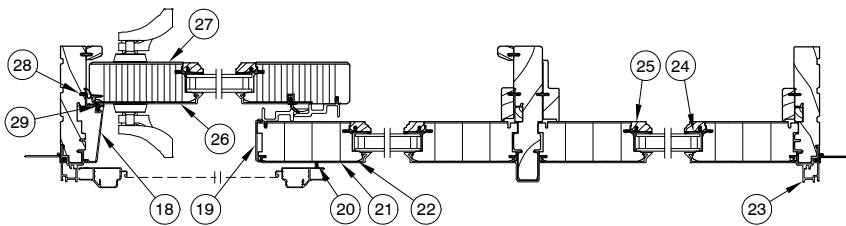
Jamb - XO

NOTE: Not to scale; specifications subject to change without notice.

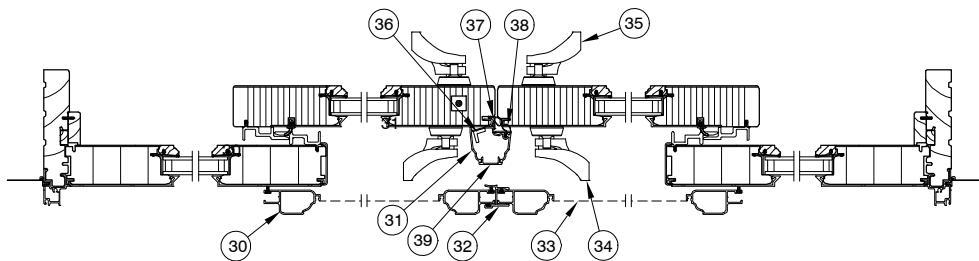
**ULTIMATE SLIDING FRENCH DOOR
JAMB DETAIL**



Jamb – 3 Panel OXO



Jamb – 3 Panel XOO

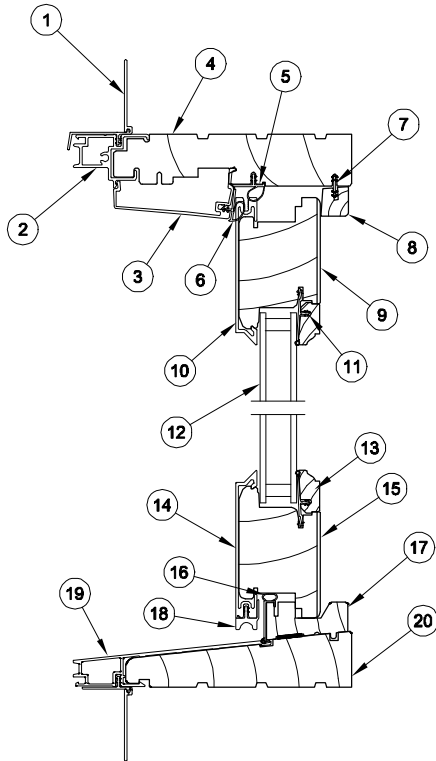


Jamb – 4 Panel OXXO

1. Jamb Nailing Fin
2. Insulated Glass
3. Center Jamb Cladding
4. Stationary Jamb Stile
5. Stationary Jamb Stile Cladding
6. Connecting Barb
7. Operating Panel Interlock
8. Meeting Stile Weather Strip, V1194
9. Stationary Panel Interlock
10. Operating Meeting Stile Cladding
11. Operating Meeting Stile
12. Jamb Liner
13. Center Jamb
14. Center Jamb Cover
15. Stationary Jamb Cover
16. Jamb
17. Stationary Jamb Filler
18. Jamb Parting Stop
19. Edge Cover
20. Screen Pile Weather Strip
21. Stationary Meeting Stile Cladding
22. Stationary Meeting Stile
23. Jamb Cladding
24. Glazing Bead
25. Glazing Cap
26. Operating Locking Stile Cladding
27. Operating Locking Stile
28. Jamb Weather Strip
29. Parting Stop Weather Strip
30. Screen Frame
31. Astragal Cladding A2047
32. Screen Astragal
33. Screen
34. Exterior Handle Assembly
35. Interior Handle Assembly
36. Base reinforcement
37. Stile Weather Strip
38. Astragal Weather Strip
39. Mull Casing Cover A775

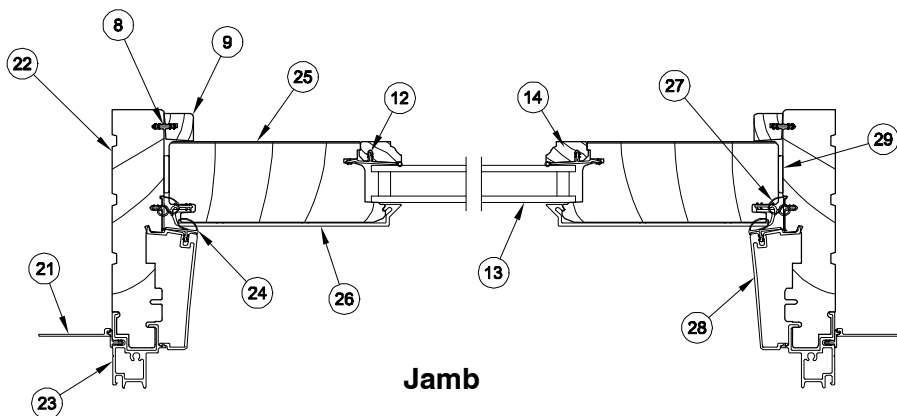
NOTE: Not to scale; specifications subject to change without notice.

**ULTIMATE SLIDING FRENCH DOOR
IN-SASH TRANSOM**



Head Jamb and Sill

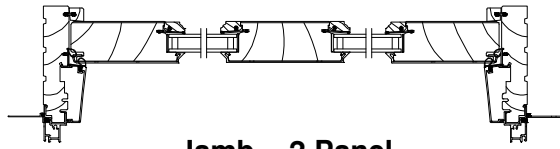
- 1. Head Jamb Nailing Fin/Drip Cap
- 2. Head Jamb Cladding
- 3. Head jamb Parting Stop
- 4. Head Jamb
- 5. Head Jamb Weather Strip
- 6. Head Jamb Parting Stop Weather Strip
- 7. Connecting Barb
- 8. Interior Cover
- 9. Top Rail
- 10. Top Rail Cladding
- 11. Glazing Bead
- 12. Insulating Glass
- 13. Glazing Cap
- 14. Bottom Rail Cladding
- 15. Bottom Rail
- 16. Sill Filler Weather Strip
- 17. Sill Filler
- 18. Panel Drip
- 19. Sill Cladding
- 20. Sill
- 21. Jamb Nailing Fin
- 22. Side Jamb
- 23. Side Jamb Cladding
- 24. Side Parting Stop Weather Strip
- 25. Stile
- 26. Stile Cladding
- 27. Side Jamb Weather Strip
- 28. Side Parting Stop
- 29. Spacer Tack



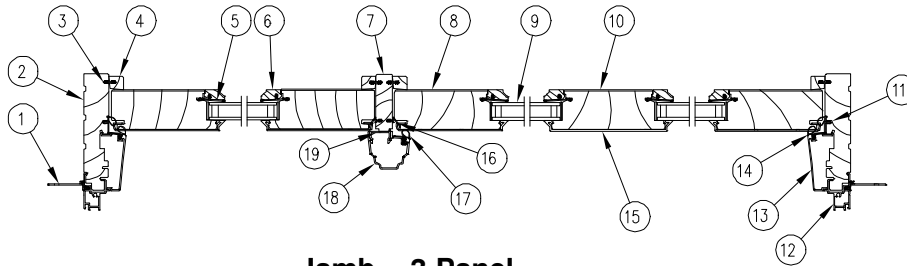
Jamb

NOTE: Not to scale; specifications subject to change without notice.

**ULTIMATE SLIDING FRENCH DOOR IN-SASH TRANSOM
JAMB DETAIL**

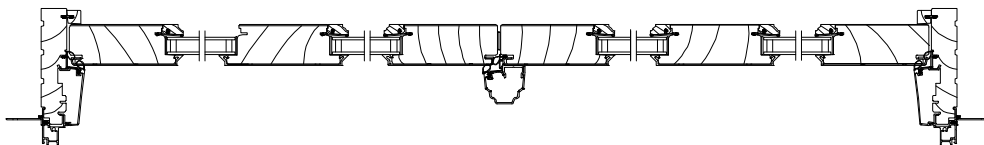


Jamb - 2 Panel



Jamb - 3 Panel

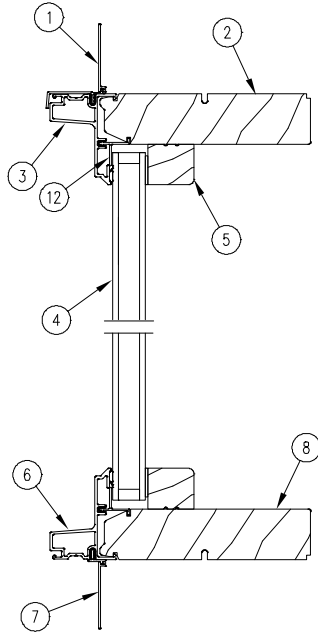
1. Jamb Nailing Fin
2. Jamb
3. Connecting Barb
4. Interior Cover
5. Glazing Bead
6. Glazing Cap
7. Center Jamb
8. Stile
9. Insulated Glass
10. Center Stile
11. Jamb Weather Strip
12. Jamb Cladding
13. Side Jamb Parting Stop
14. Parting Stop Weather Strip
15. Center Stile Cladding
16. Stile Weather Strip
17. Astragal Weather Strip
18. Astragal
19. Astragal Base



Jamb - 4 Panel

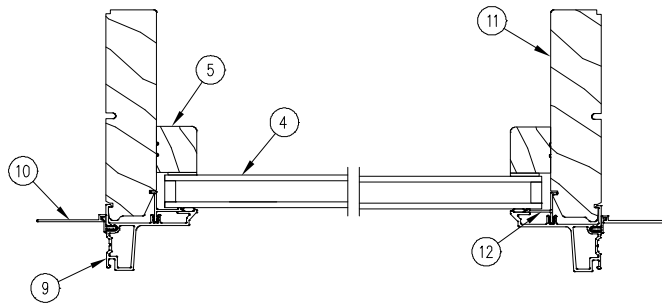
NOTE: Not to scale; specifications subject to change without notice.

**ULTIMATE SLIDING FRENCH DOOR
DIRECT GLAZE TRANSOM**



- 1. Head Jamb Nailing Fin/Drip Cap
- 2. Head Jamb
- 3. Head Jamb Cladding
- 4. Insulating Glass
- 5. Glazing Bead, W11751
- 6. Sill Cladding
- 7. Sill Nailing Fin
- 8. Sill
- 9. Jamb Cladding
- 10. Jamb Nailing Fin
- 11. Jamb
- 12. Attachment Barb

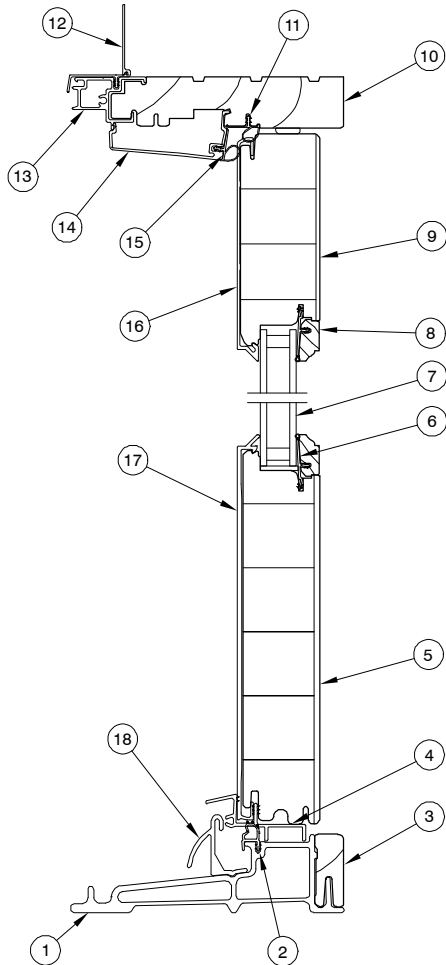
Head Jamb and Sill



Jamb

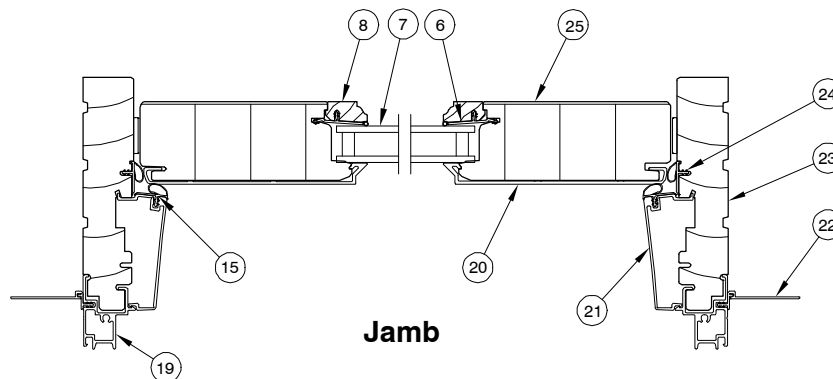
NOTE: Not to scale; specifications subject to change without notice.

**ULTIMATE SLIDING FRENCH DOOR
STATIONARY**



1. Sill
2. Sill Weather Strip, V794
3. Sill Liner
4. Stationary Panel Drip
5. Bottom Rail
6. Glazing Bead
7. Insulating Glass
8. Glazing Cap
9. Top Rail
10. Head Jamb
11. Head Jamb Weather Strip, V794
12. Head Jamb Nailing Fin/Drip Cap
13. Head Jamb Cladding
14. Head Jamb Parting Stop
15. Parting Stop Weather Strip, V794
16. Top Rail Cladding
17. Bottom Rail Cladding
18. Hydro Optimizer
19. Jamb Cladding
20. Stile Cladding
21. Jamb Parting Stop
22. Jamb Nailing Fin
23. Jamb
24. Jamb Weather Strip, V794
25. Stile

Head Jamb and Sill



Jamb

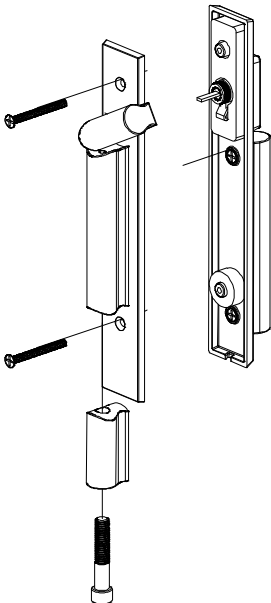
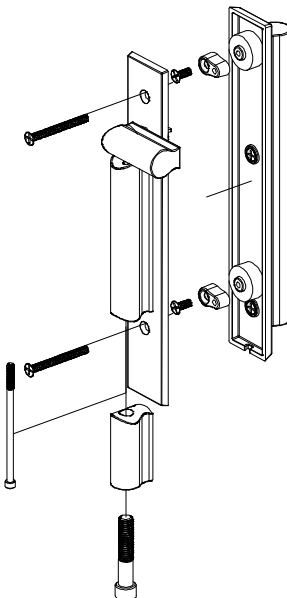
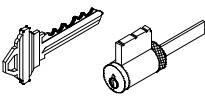

NOTE: Not to scale; specifications subject to change without notice.

ILLUSTRATION NOT TO SCALE	DESCRIPTION	OPER./COLOR	PART NO.
<p>Labels in illustration: ACTUATOR PIN, FOAM GASKET, EXTERIOR ESCUTCHEON, INTERIOR ESCUTCHEON, M5 x 12mm #10-32x7/16" hex drive PH screw, M5 x 55mm #10-32x2 1/8" Oval Head Machine Screw</p>	<p>Traditional Handle, Non-Keypad*</p> <p>Thumb Turn, Traditional with Actuator/Tail Piece For Non-Keypad Handle Includes: Actuator/Tailpiece, thumb turn washer and thumb turn push nut.</p>	<p>Wide*</p> <ul style="list-style-type: none"> Antique Brass 10830340 Satin Chrome 10830334 Oil Rubbed Bronze 10830107 Oil Rubbed Bronze PVD 10830372 Polished Chrome 10830342 Brass PVD 10830356 Satin Nickel PVD 10830424 <p>Narrow*</p> <ul style="list-style-type: none"> Satin Taupe 10830348 Dark Bronze 10830418 White 10830414 Matte Black 10830444 	
<p>Labels in illustration: ACTUATOR PIN, FOAM GASKET, EXTERIOR ESCUTCHEON, INTERIOR ESCUTCHEON, M5 x 12mm #10-32x7/16" hex drive PH screw, M5 x 50mm #10-32x2 1/8" Oval Head Machine Screw</p>	<p>Traditional Handle, Keypad*</p> <p>Thumb Turn, Traditional, No Actuator/Tailpiece For Keypad Handle Includes: Thumb turn washer and thumb turn push nut.</p>	<p>Wide*</p> <ul style="list-style-type: none"> Antique Brass 10830344 Satin Chrome 10830336 Oil Rubbed Bronze 10830106 Oil Rubbed Bronze PVD 10830380 Polished Chrome 10830346 Brass PVD 10830354 Satin Nickel PVD 10830428 <p>Narrow*</p> <ul style="list-style-type: none"> Satin Taupe 10830350 Dark Bronze 10830400 White 10830412 Matte Black 10830446 	

* Wide escutcheon 1 7/8" x 12 1/2" Narrow escutcheon 1 3/8" x 12 1/2"

ILLUSTRATION NOT TO SCALE	DESCRIPTION	OPER./COLOR	PART NO.
	<p>Traditional Inactive Handle*</p>	<p>Wide*</p> <ul style="list-style-type: none"> Antique Brass 10830360 Satin Chrome 10830338 Oil Rubbed Bronze 10830108 Oil Rubbed Bronze PVD 10830332 Polished Chrome 10830358 Brass PVD 10830362 Satin Nickel PVD 10830432 <p>Narrow*</p> <ul style="list-style-type: none"> Satin Taupe 10830352 Dark Bronze 10830420 White 10830416 Matte Black 10830448 	
	<p>Tail Piece Adaptor – Interior Shades</p>		<p>11800171</p>
	<p>#10-32 x 1 1/2" Machine Screw Extension– Interior Shades</p>		<p>11800170</p>
	<p>Escutcheon Adaptor For Inactive Handle <i>Includes:</i> 1 – #10-32x7/16 hex drive panhead stainless steel screw (00143047)</p>	<p>Zinc Diecast</p>	<p>00143048</p>
	<p>Key Cylinder (Schlage "C" keyway) For service replacement only. <i>NOTE: For Keyed Alike orders, use program C87P2.</i></p> <p><i>BS, ORBZ PVD, TP, WH, AB=Brass Face</i> <i>All other Marvin finishes=Chrome Face</i></p>	<p>Brass Face Chrome Face</p>	<p>10830211 10830208</p>
	<p>Lug Seal, Traditional</p>		<p>00142046</p>
	<p>#10-32 x 2 1/8" Phillips oval head machine screw</p>	<ul style="list-style-type: none"> Antique Brass 00143038 White 00143036 Satin Chrome 10840031 Oil Rubbed Bronze 10840032 Brass PVD 11800615 Satin Taupe 11800616 Dark Bronze 11800654 Satin Nickel PVD 11800190 Matte Black 11800181 	
	<p>M5 x 8 x 55MM PH oval head, full thread</p>	<ul style="list-style-type: none"> Satin Taupe 10148400 Dark Bronze 10148401 Oil Rubbed Bronze PVD 10148402 Satin Nickel PVD 10148403 Matte Black 10148440 	

* Wide escutcheon 1 7/8" x 12 1/2" Narrow escutcheon 1 3/8" x 12 1/2"

ILLUSTRATION NOT TO SCALE	DESCRIPTION	OPER./COLOR	PART NO.
	<p>Contemporary Handle, Keyed*</p>	<p>Dark Bronze Oil Rubbed Bronze PVD Satin Nickel PVD Matte Black</p>	<p>10148206 10148207 10148205 10148208</p>
	<p>Contemporary Handle, Non-Keyed*</p>	<p>Dark Bronze Oil Rubbed Bronze PVD Satin Nickel PVD Matte Black</p>	<p>10148215 10148216 10148217 10148218</p>
	<p>Contemporary Inactive Handle*</p>	<p>Dark Bronze Oil Rubbed Bronze PVD Satin Nickel PVD Matte Black</p>	<p>10148219 10148220 10148221 10148222</p>
	<p>Key Cylinder (Schlage "C" keyway) For service replacement only. <i>NOTE: For Keyed Alike orders, use program C87P2.</i></p> <p><i>BS, ORBZ PVD, TP, WH, AB=Brass Face</i> <i>All other Marvin finishes=Chrome Face</i></p>	<p>Brass Face Chrome Face</p>	<p>10830216 10830213</p>
	<p>Indexing Tail Piece</p>	<p>Steel</p>	<p>10830160</p>

* Traditional and Contemporary handles are not interchangeable.



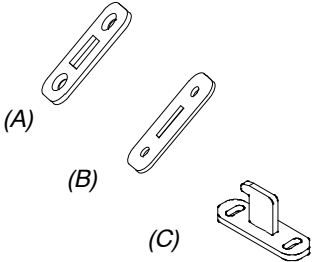
ILLUSTRATION NOT TO SCALE	DESCRIPTION	OPER./COLOR	PART NO.
	Rubber Bumper	Beige Black	02101000 02101006
 (2 point shown)	Multi Point Lock <i>Includes:</i> 1 - Multi Point lock assembly 2 pt lock - 5-#8x1 1/2" Phillips flathead stainless steel (11800850) 3 pt lock - 5-#8x1 1/2" Phillips flathead stainless steel (11800850)	Stainless Steel 2 pt. lock 3 pt. lock	05700317 05700318
	Plate Cover <i>A - Plate Cover - 11860042</i> Shim <i>B - Shim - 18900501</i> 3 required at center keeper and at bottom keeper on a 2 pt lock. Strike Hook <i>C - Strike Hook - 11860041</i> Screws each: 11800648 - #8x2.5" flathead screw 2 required per keeper when installed on inactive panel 11800645 - #8x1" flathead screw SS 2 required when installed on jamb. 11800647 - #8-32x1" flathead machine screw, 2 required when installed on center jamb. 05080250 - #8-32 thread, SS T-nut, 2 required when installed on center jamb.	Order components as needed per each application	

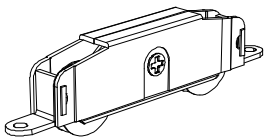
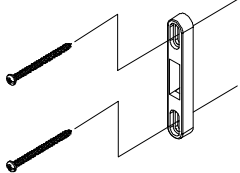
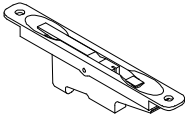
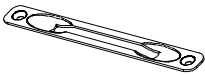
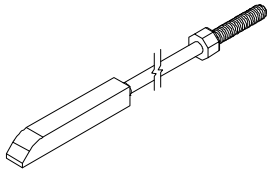
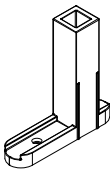
ILLUSTRATION NOT TO SCALE	DESCRIPTION	OPER./COLOR	PART NO.										
	<p>Operator Panel Roller (Tandem-Adjustable) Includes: 1 - Operator panel roller 2 - #8x1" Phillips flathead wood screws, ZYD (11800810), SS (11800645) NOTE: Must order stainless steel for coastal hardware</p>	ZYD Stainless Steel	10820003 10820004										
	<p>Head Jamb Strike Inactive Panel OXXO Includes: 1 - Strike 2 - T nuts (05080250) 2 - #8-32x3/4" panhead machine screws (11800730)</p>	ZYD	10148195										
	<p>Inactive Panel Flush Bolt Includes: 1 - Flush bolt</p>		11101780										
	<p>Cover Includes: 1 - Cover 2 - #8x 1" Phillips flathead wood screws</p>	Aluminum	11860402										
	<p>Locking Rod Includes: 1 - Locking rod with end bolt</p> <table border="1" data-bbox="625 1161 950 1339"> <thead> <tr> <th>Height</th> <th>Top Locking Rod Length</th> </tr> </thead> <tbody> <tr> <td>CN 6-8 ht</td> <td>11"</td> </tr> <tr> <td>CN 7-0 ht</td> <td>11"</td> </tr> <tr> <td>CN 8-0 ht</td> <td>27"</td> </tr> <tr> <td>CN 9-0 ht</td> <td>34 1/4"</td> </tr> </tbody> </table>	Height	Top Locking Rod Length	CN 6-8 ht	11"	CN 7-0 ht	11"	CN 8-0 ht	27"	CN 9-0 ht	34 1/4"	Stainless Steel	05700180 05700180 05700185 05700170
Height	Top Locking Rod Length												
CN 6-8 ht	11"												
CN 7-0 ht	11"												
CN 8-0 ht	27"												
CN 9-0 ht	34 1/4"												
	<p>Shoot Bolt Guide Inactive Panels - OXXO Includes: 1 - Shoot bolt guide (10815186) 1 - #8x1 1/2" Phillips panhead wood screw (11800766)</p>		10815199										


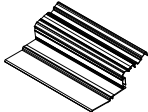

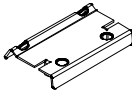
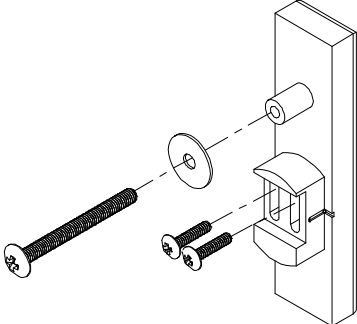
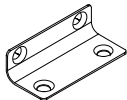
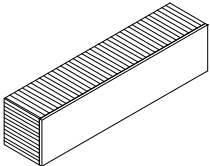
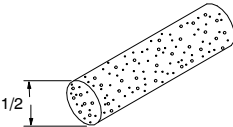

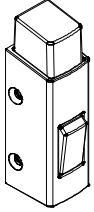
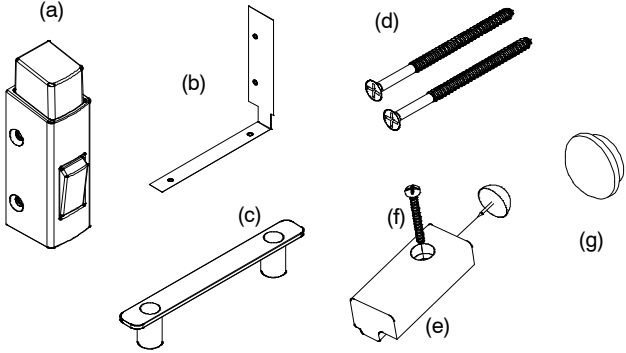
ILLUSTRATION NOT TO SCALE	DESCRIPTION	OPER./COLOR	PART NO.
	Sill Plug, Transom Ultimate only	CL	10500232
	Threshold Protector 30" length	EA Pkg of 20	11869675 11869676
	Sill Drain Filter		10500240
	Stationary Panel Head Jamb Bracket <i>Includes:</i> 1 - Bracket 4 - #8x1" flat head screws (11800810)	Galvanized steel	11860213
	Construction Lock Assembly For Marvin residential swinging and sliding doors with standard locks. <i>Includes:</i> 1 - Construction Lock Cover 1 - Construction Lock Hole Cover 1 - Washer 2 - #6-32 X 5/8" Phillips TH screws 1 - #10-32 X 2" Phillips TH screw	Each 25/Box	18450200 18450198
	Stationary Sash to Jamb Bracket <i>Includes:</i> 1 - Stationary bracket 2 - #7 x 7/8" flathead (11800758) 2 - #7 x 1 1/4" flathead (11807113)	Galvanized Steel	11841001
	Dust Block, Low Profile Sill		10500296
	Foam Backer Rod Specify Length Ultimate Only	Gray	10500204
	Sill Stationary Panel Bracket for French Door Transom MISC 0686 <i>Includes:</i> 1 - Sill stationary panel bracket 2 - #8x5/8" panhead wood screw, (11800780)	Beige	11130358

ILLUSTRATION NOT TO SCALE	DESCRIPTION	OPER./COLOR	PART NO.
	Foot Bolt	White Beige Bronze	11101777 11101778 11101779

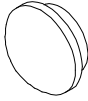


Sliding Door Auxiliary Foot Bolt Kit
Includes:

- 1- Foot bolt (a)
- 1- Installation template with installation instructions (b)
- 1 - Lock plate assembly (c)
- 2 - #8 x 2 3/4" screws (d)
- 1 - Bumper stop (e)
- 1 - #8 x 1 1/2" screw (f)
- 1 - Roller adjustment plug (g)

NOTE: Not available on low-profile sill

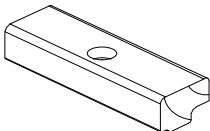
Wood Species	Color/Configuration					
	White/ XO	White /OX	Beige /XO	Beige /OX	Bronze/ XO	Bronze /OX
Pine	11101760	18900611	11101761	18900612	11101762	18900613
Cherry	18900614	18900617	18900615	18900618	18900616	18900619
Vertical Grain Douglas Fir	18900620	18900623	18900621	18900624	18900622	18900625
Mix Grain Douglas Fir	18900638	18900641	18900639	18900642	18900640	18900643
Oak	18900632	18900635	18900633	18900636	18900634	18900637
Mahogany	18900626	18900629	18900627	18900630	18900628	18900631



Roller Adjustment Plug

Wood Species	Finish										
	Bare	Prime	White	Designer Black	Clear	Wheat	Honey	Hazelnut	Leather	Espresso	Cabernet
Pine	01060619	11100952	39200619	39200620	31660619	11100910	11100911	11100912	11100913	11100914	11100915
Cherry	01060619C	-	-	-	11100916	11100917	11100918	11100919	11100920	11100921	11100922
Mahogany	01060619M	-	-	-	11100923	11100924	11100925	11100926	11100927	11100928	11100929

NOTE: Douglas fir uses Bare Mahogany plugs.



**Bumper Block,
Head Jamb or Sill**

Wood Species	Finish							Finish				
	Bare	Prime	White	Designer Black	Clear	Wheat	Honey	Hazelnut	Leather	Espresso	Cabernet	
Pine	75151605	75151808	75151807	75151809	75151800	75151801	75151802	75151803	75151804	75151805	75151806	

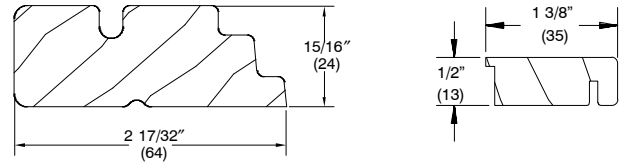
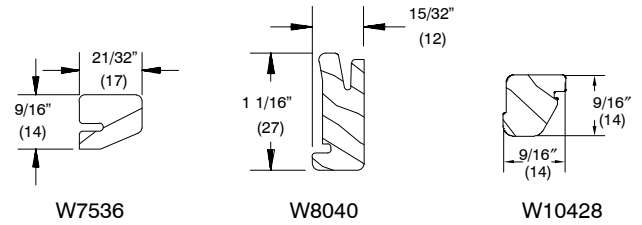
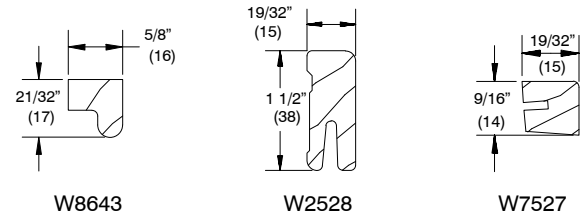
TO ORDER REPLACEMENT WOOD PARTS

When ordering replacement wood parts specify:

1. profile number;
2. rough opening;
3. handing;
4. length;
5. finish.

	Ultimate	Ultimate Wood
Stationary Panel Bottom Spacer	W8643	W8643
Sill Liner	W2528	W2528
Interior Cover (Transom)	W7527	W7527
Jamb Liner	W7536	W7536
Panel Guide	W8040	W8040
Oak Sill Liner, Low Profile Sill	W10428	W10428
Bumper Stop Block, Low Profile Sill PN 71271003 (3 3/4")	W10302	W10302
Stationary Jamb Cover	W7535	W7535
Center Jamb Cover	W7534	W7534
Leveling Block Filler	W8270	W8270
Stationary Panel Head Jamb Cover	W7504	W7504
Interior Glazing Bead Direct Glaze Transom June 24, 2013 – present	W11751	W11751
Head Jamb and Jamb Parting Stop	-	W6535
Mull Casing Cover	-	W7554
Exterior Center Jamb (Transom)	-	W7519
Mull Casing Base	-	W1455
Screen Track Filler	-	W5221
Sill Nosing – Transom (total R.O. continuous casing)	-	W12031
Sill Nosing – Transom	-	W12032
Sill Nosing – Transom	- - -	W8653

NOTE: Replacement wood parts are supplied with connecting barb (where applicable).



W10302
PN – 71271003 – 3 3/4"

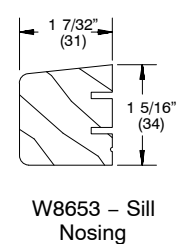
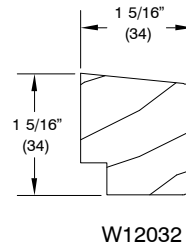
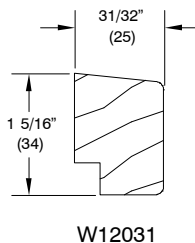
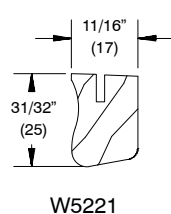
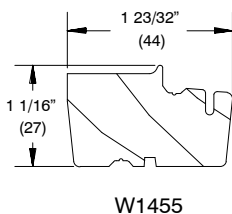
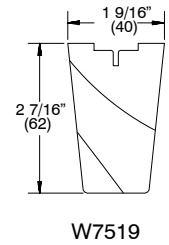
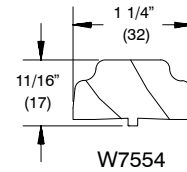
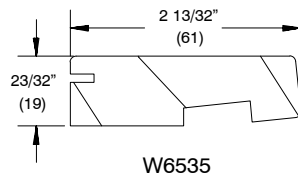
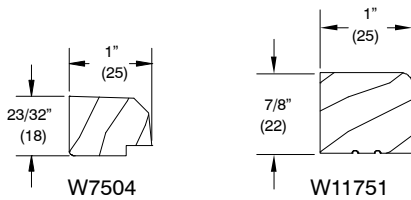
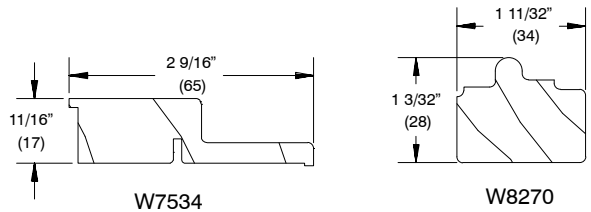
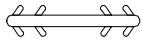
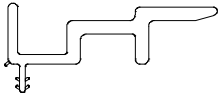


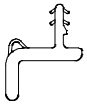
ILLUSTRATION <i>NOT TO SCALE</i>	DESCRIPTION	LENGTH	OPER./ COLOR	PART NUMBER
	<p>Connecting Barb V803 NOTE: Color may vary depending on current stock.</p>	Specify Length		15812999
	<p>Interlock, Stationary and Operating Panel V1828 Attached with #6x1 1/2" Phillips panhead Stainless Steel screws</p>	116 5/16" (2954)	Beige Black	15215499 15216499

TO ORDER REPLACEMENT PARTS

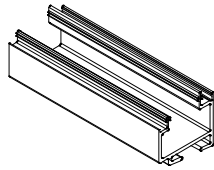
When ordering replacement parts specify:

1. profile number;
2. rough opening;
3. color
4. length;
5. handing;
6. finish.

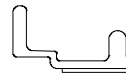
	Ultimate	Ultimate Wood
Panel Drip, Low Profile Sill – Beige or Black	V1823	V1823
Leveling Block – Beige or Black	V1755	V1755
Roller Track – Beige or Black	V1745	V1745
Ultrex Sill – Beige or Bronze	F2010	F2010
Sill, Low Profile	F2017	F2017
Roller Track, Low Profile Sill – Beige or Black	V1846	V1846
Stat Panel Seal, Low Profile Sill – Beige or Black	V1865	V1865
Condensation Cover – Beige or Black	V1131	–



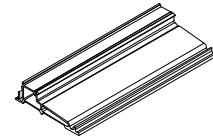
V1823



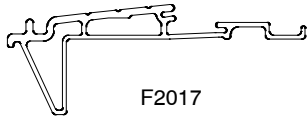
V1755



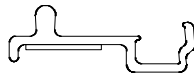
V1745



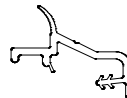
F2010



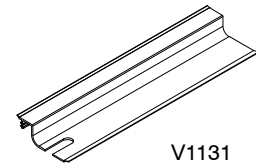
F2017



V1846



V1865



V1131

TO ORDER REPLACEMENT PARTS

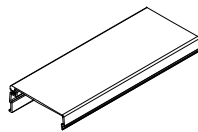
When ordering replacement parts specify:

1. profile number;
2. rough opening;
3. length;
4. handing;
5. finish.

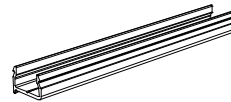
	Ultimate	Ultimate Wood
Header Panel Guide Fastener	A1014	A1014
Head Jamb, Jamb Parting Stop	A836	-
Astragal Base and Transom Center Jamb Base	A771	-
Astragal and Transom Center Jamb Cladding	A772	-
Stationary Meeting Stile Edge Cover	A778	-
Mull Fastener - Transom	A850	-
Astragal (for OXXO door)	A2047	-
Mull Casing Cover (used with A2047)	A775	-



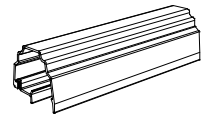
A1014



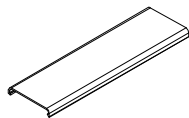
A836



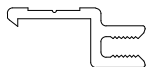
A771



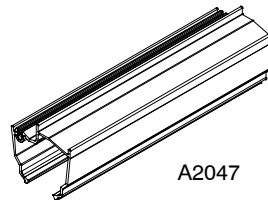
A772



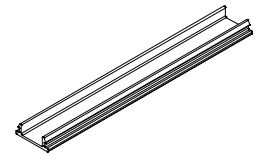
A778



A850



A2047

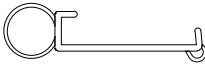
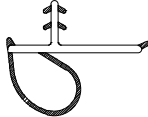
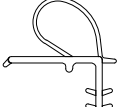
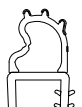
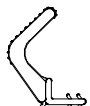

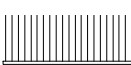




A775

ULTIMATE SLIDING FRENCH DOOR WEATHER STRIP

When ordering replacement weather strip specify:

1. quantity;
2. length;
3. part number;
4. description.

ILLUSTRATION <i>NOT TO SCALE</i>	DESCRIPTION	LENGTH	OPER./COLOR	PART NUMBER
	Bulb Weather strip, Transom Sill Filler V775	Specify Length	Beige Black	15610099 15610098
	Bulb Weather Strip, Jambs, Astragal and Transom V796	189 23/32"	Beige Black	15173298 15173398
	Mull Stile Base Weather Strip V780	150" 150"	Beige Black	15174099 15174098
	Flex-Bulb Weather Strip, Sill V794 Used on 1-wide stationary units	92 3/4" 164 3/4" 164 3/4"	Beige Beige Black	15180780 15180798 15180799
	Sill Weather Strip, Low Profile V1793	98 3/8"	Beige Black	15171899 15171999
	Weather Strip, Foam Leaf, Sill, Meeting Stile and Head Jamb Parting Stop V1194	Specify Length (LF)	Beige Black	17003595 17003596
	Dust Block Adhesive backed Stationary Panel Cover 2 1/4" x 1 3/8" x 1/2"		Gray	15600004
	Dust Block Parting Stop 1 3/8" x 3/8" x 1/2"		Gray	15600010
	Dust Block Astragal or Panel 1 3/8" x 1/4" x 3/8"			10500049

ORDERING REPLACEMENT PANELS FOR THE ULTIMATE SLIDING FRENCH DOOR

NOTE: For inactive panels with flush bolts, if panel height is greater than or equal to 104 1/2" and the door was manufactured before 08/28/2016 order appropriate Locking Rod.

To order replacement panels specify:

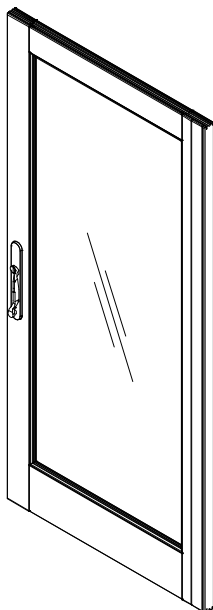
- | | |
|--|---|
| <ol style="list-style-type: none"> 1. OM of panel;
<i>NOTE: OM of panel does not include astragal.</i> 2. active, inactive or stationary (specify astragal if applicable); 3. handing; 4. Glazing 5. Finish | <ol style="list-style-type: none"> 6. Pre 2000 7. 2 point or 3 point locking door. 8. glazing bead profile <ol style="list-style-type: none"> a. bevel b. square 9. Hardware option: traditional, contemporary, or architectural |
|--|---|

ULTIMATE AND ULTIMATE WOOD SLIDING FRENCH DOOR (PRE 2000)

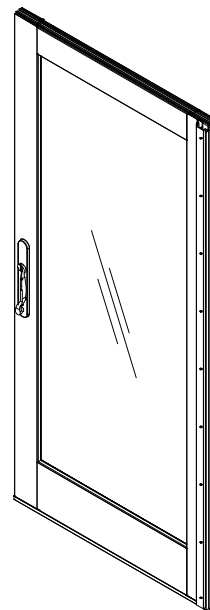
CN	Panel OSM		Panel DLO	
	Width	Height	Width	Height
2665	29 3/4"	75 3/4"	20 1/4"	62 7/8"
3065	35 3/4"	75 3/4"	26 1/4"	62 7/8"
4065	47 3/4"	75 3/4"	38 1/4"	62 7/8"
2668	31 1/4"	79"	21 3/4"	66 1/8"
3068	37 1/4"	79"	27 3/4"	66 1/8"
4068	49 1/4"	79"	39 3/4"	66 1/8"
8/0 Height		95"		82 1/8"

Units will have:

- 4 3/4" top rails, 8 1/8" bottom rails, 4 3/4" stiles
- Mushroom bolts used until 2002



**Ultimate Wood
Active Panel
Exterior View**



**Ultimate
Active Panel
Exterior View**

NOTE: Panels feature no bore (standard).
Operating panels include sweep.
Stationary panels include leveling block.

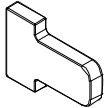
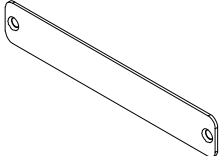
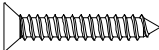

ILLUSTRATION NOT TO SCALE	DESCRIPTION	OPER./ COLOR	PART NO.
	Tailpiece, Non-keyed, Button Switch	Stainless Steel	10501844
	Cover, Transmitter	Brushed Stainless Steel	10501822
	#8-18 x 1" Type AB, Full Thread <i>Used for Transmitter Cover</i> <i>Need quantity of 2 for each part</i>		11800769
	Micro Switch Assembly	Black	10501824

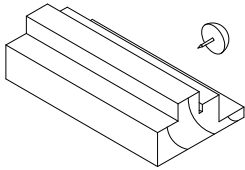
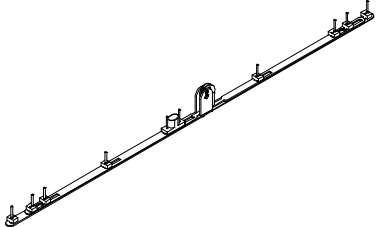

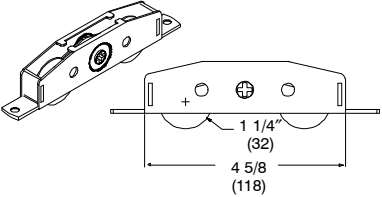
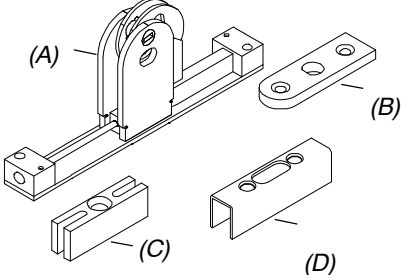
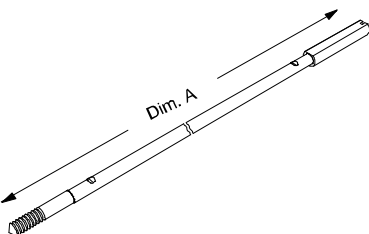
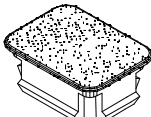

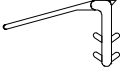
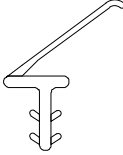
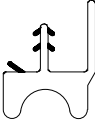
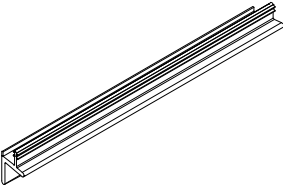
ILLUSTRATION NOT TO SCALE	DESCRIPTION	COLOR	PART NO.
	<p>Bumper Block, Head Jamb Length: 4 1/2" (with rubber bumper)</p>		75151604
	<p>Multi Lock Hardware Assembly <i>Includes:</i> 1 - Multi lock assembly 10 - #8x1 1/2" Phillips flathead wood screws (hardware assembly) Used for pre 5/2002 doors</p>	ZYD	10145001
	<p>Offset Mushroom Bolt</p>	Stainless Steel	11100412
	<p>Operator Panel Small Roller (Tandem-Adjustable) Used before 2002 <i>Includes:</i> 1 - Operator panel roller 2 - #8x1" Phillips flathead wood screws</p>	ZYD	10820000
	<p>Inactive Panel Hardware Assembly <i>Includes:</i> 1 - Hardware assembly (A) 1 - Guide plate (B) 1 - Adjustable strike slide (C) 1 - Strike cover (D) 2 - #10-24x1 1/2" Phillips flathead machine screws with T-nuts (strike) 4 - #8x1 1/2" Phillips flathead wood screws (hardware assembly and guide plate)</p>	ZYD	10510132
	<p>Locking Rod CN 8-0 ht. 53 13/32" (1357) NOTE: For special heights give dimension A.</p>		10830013
	<p>Leveling Block Cap</p>	Beige	11868010

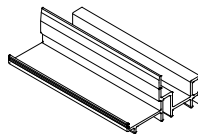
ILLUSTRATION <i>NOT TO SCALE</i>	DESCRIPTION	LENGTH	OPER./COLOR	PART NUMBER
	Bulb Weather strip, Meeting Stile V192 Used until June 2010	192"	Beige Black	15900118 15900117
	Sill Weather Strip V791	99 5/16"	Beige	15641160
	Head Jamb, Parting Stop, Astragal V795	144" 79 5/16"	Beige Black	15649099 15646069
	Panel Drip V800	150"	Beige Black	15978499 15978490
	Head Jamb, Parting Stop, Astragal V1012	60"	Beige	15979006

TO ORDER REPLACEMENT PARTS

When ordering replacement parts specify:

1. profile number;
2. rough opening;
3. length;
4. handing;
5. finish.

	Ultimate	Ultimate Wood
Leveling Block – Beige	V792	V792

Discontinued – Limited Availability (LA)

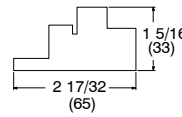
V792 – Leveling Block

When ordering replacement wood parts specify:

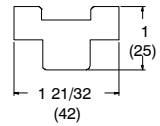
1. profile number;
2. rough opening;
3. handing;
4. length;
5. finish.

	Ultimate	Ultimate Wood
Head Jamb Filler	W7516	W7516
Stationary Panel Top Filler	---	W7506
Leveling Block Filler	W7508	W7508
Panel Guide	W7502	W7502
Astragal for OXXO	W7570	---
Astragal for OXXO		W7509
Bottom Rail Block (Stationary)	W7510	W7510
Exterior Part Stop (Transom – pre-June 24, 2013)	---	W8474
Interior Glazing Bead Direct Glaze Transom Pre-June 24, 2013	W4160	W4160
NOTE: Replacement wood parts are supplied with connecting barb (where applicable).		

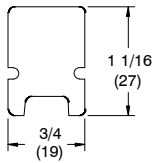
Discontinued – Limited Availability (LA)



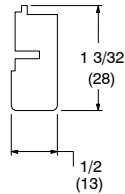
W7516 – Head Jamb Filler



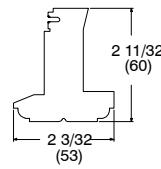
W7506 – Stationary Panel Top Filler – Wood



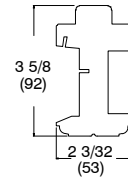
W7508 – Leveling Block Filler



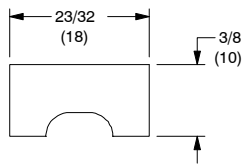
W7502 – Panel Guide



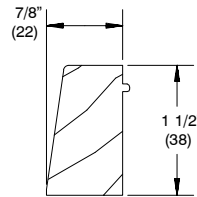
W7570 – Astragal for OXXO Ultimate



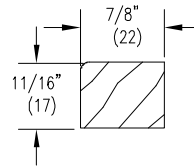
W7509 – Astragal for OXXO Ultimate Wood



W7510 – Bottom Rail Block (Stationary)



W8474 – Exterior Part Stop



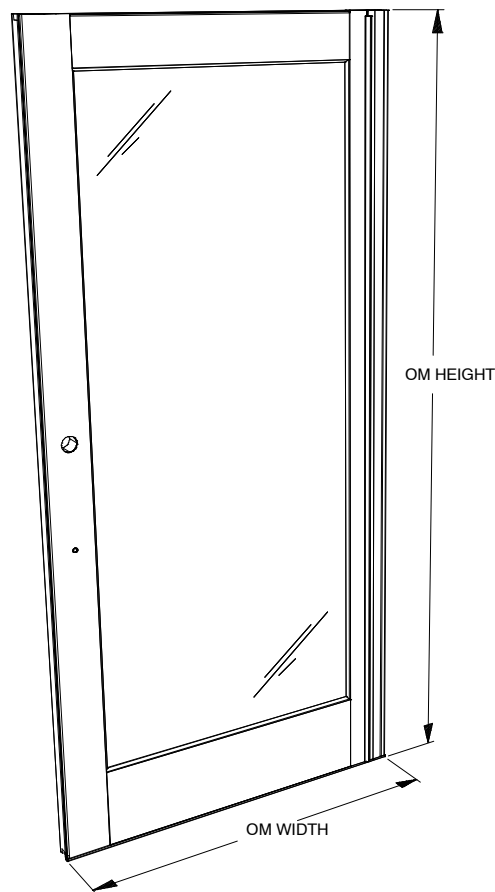
W4160

To order replacement panels specify:

1. OM of panel;
NOTE: OM of panel does not include astragal.
2. active, inactive or stationary (specify astragal if applicable);
3. handing;
4. glazing;
5. finish;
6. Pre 2002;



**Ultimate Wood Active Panel
Exterior View**



**Ultimate Active Panel
Exterior View**

NOTE: Active panels include sash rollers, meeting stile Weather Strip, panel drip and interlock.

Inactive panels include sash rollers, meeting stile Weather Strip, panel drip, interlock and astragal with mushroom bolts and Weather Strip.

Recommended order with hardware installed, if not astragal separate.

Stationary panels include panel fastener, Ultimate panels also include a stationary top filler.

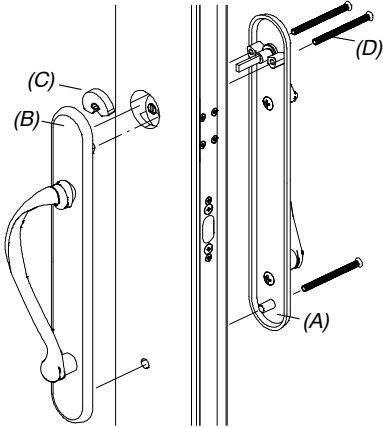
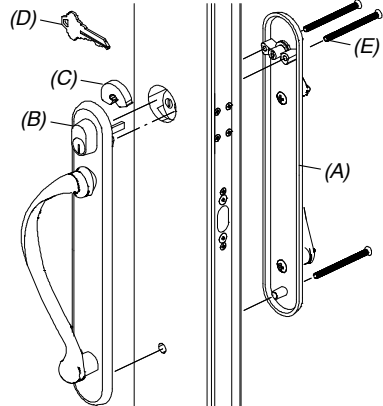
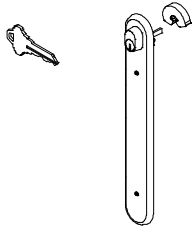

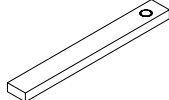

ILLUSTRATION NOT TO SCALE	DESCRIPTION	OPER./COLOR	PART NO.
	<p>Handle, Solid Brass, Non-Keyed</p>	<p>Left Hand Brass Antique Brass Polished Chrome Brushed Chrome White PVD</p> <p>Right Hand Brass Antique Brass Polished Chrome Brushed Chrome White PVD</p>	<p>No longer available</p> <p>Use current wide style handle.</p>
	<p>Handle, Solid Brass, Keyed (Schlage "C" Keyway)</p>	<p>Left Hand Brass Antique Brass Polished Chrome Brushed Chrome White PVD</p> <p>Right Hand Brass Antique Brass Polished Chrome Brushed Chrome White PVD</p>	<p>No longer available</p> <p>Use current wide style handle.</p>
	<p>Escutcheon Plate, Keyed (Schlage "C" Keyway) Non-Handed</p>	<p>Brass</p>	<p>No longer available</p>
	<p>Stop clip with screws</p>		<p>No longer available</p>
	<p>Actuator, Traditional 9/25/00 - Present</p>	<p>The actuator and Rol-pin are included in the current thumb turn/w tail piece assembly.</p>	<p>No longer available</p>
	<p>Rol-Pin, Actuator 9/25/00 - Present</p>		<p>No longer available</p>

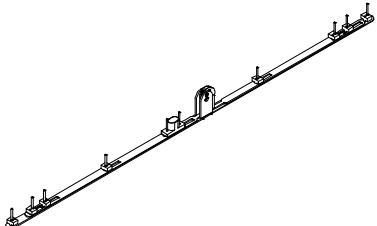

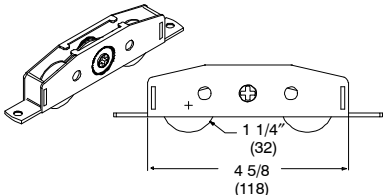
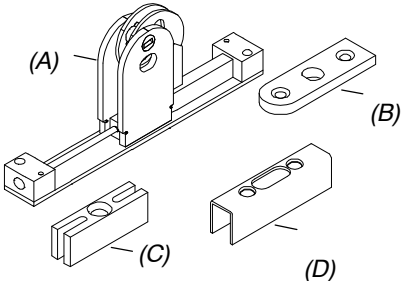
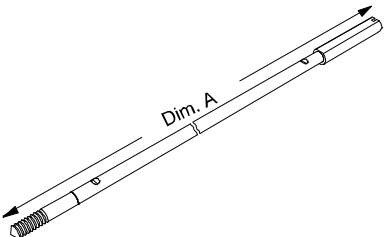
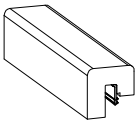
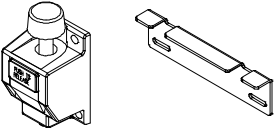
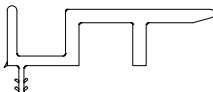
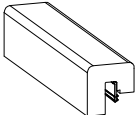

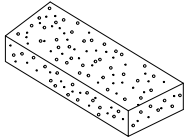
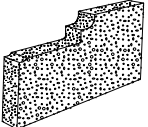
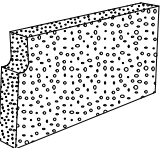
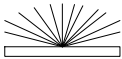
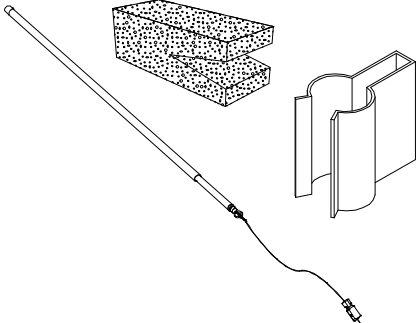
ILLUSTRATION NOT TO SCALE	DESCRIPTION	COLOR	PART NO.									
	<p>Multi Lock Hardware Assembly <i>Includes:</i> 1 - Multi lock assembly 10 - #8x1 1/2" Phillips flathead wood screws (hardware assembly) <i>Used for pre 5/2002 doors</i></p>	SS	No longer available									
	<p>Offset Mushroom Bolt</p>	ZYD	No longer available									
	<p>Operator Panel Small Roller (Tandem-Adjustable) Used before 2002 <i>Includes:</i> 1 - Operator panel roller 2 - #8x1" Phillips flathead wood screws</p>	SS	No longer available									
	<p>Inactive Panel Hardware Assembly <i>Includes:</i> 1 - Hardware assembly (A) 1 - Guide plate (B) 1 - Adjustable strike slide (C) 1 - Strike cover (D) 2 - #10-24x1 1/2" Phillips flathead machine screws with T-nuts (strike) 4 - #8x1 1/2" Phillips flathead wood screws (hardware assembly and guide plate)</p>	SS	No longer available									
	<p>Locking Rod</p> <table border="0"> <tr> <td>CN 6-5 ht.</td> <td>34 5/32"</td> <td>(868)</td> </tr> <tr> <td>CN 6-8 ht.</td> <td>37 13/32"</td> <td>(950)</td> </tr> <tr> <td>CN 8-0 ht.</td> <td>50 15/16"</td> <td>(1294)</td> </tr> </table> <p>NOTE: For special heights give dimension A.</p>	CN 6-5 ht.	34 5/32"	(868)	CN 6-8 ht.	37 13/32"	(950)	CN 8-0 ht.	50 15/16"	(1294)		No longer available
CN 6-5 ht.	34 5/32"	(868)										
CN 6-8 ht.	37 13/32"	(950)										
CN 8-0 ht.	50 15/16"	(1294)										
	<p>Door Stop, Sill V807 - 5"</p>	Beige	No longer available									

ILLUSTRATION NOT TO SCALE	DESCRIPTION	OPER./COL OR	PART NO.
	Auxiliary Foot Bolt, Package	Beige	No longer available. Replaced by Auxiliary Foot bolt Kit
	Interlock, Stationary and Operating Panel V797		No longer available. Replaced by V1828
	Door Stop, Sill V807 - 5"	Beige	No longer available
	#10-32x2" Phillips Oval Head Machine Screw	Polished Chrome	No longer available
	Foam, Leveling Block Gasket 5/16" x 3/4" x 2"	BK	No longer available
	Foam Gasket, Roller Track at Center Jamb	BK	No longer available
	Foam Gasket, Roller Track at Locking Jamb	BK	No longer available
	Pile Block, Screen Roller Bar 1/2" x 3/8" x 5/8" Adhesive backed	GY	No longer available
	Automatic Screen Door Closer Assembly	WH	No longer available

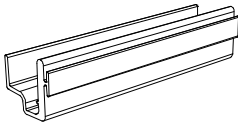
When ordering replacement parts specify:

1. profile number;
2. rough opening;
3. length;
4. handing;
5. finish.

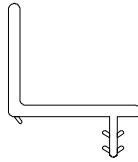
	Ultimate	Ultimate Wood
Roller Track – Beige	V786*	---
Stationary Panel Fastener and Panel Guide Fastener <i>NOTE: Color may vary depending on current stock.</i>	V793	V793
Roller Track Cover – Beige	V830*	---
Ultrex Sill – Beige	F254	F254
Screen Track	---	*A641
Sill Cover and Ultrex Sill Core Assembly – Beige	V790/F250	V790/F250
Panel Drip – Black	V1012	V1012
Sill Track (for interior oak sill)	---	A640
Stationary Panel Clad Filler	---	A703

* V786 and V830 are no longer available, no replacement.

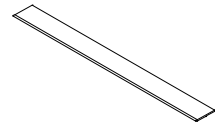
Discontinued – No Availability (NA)



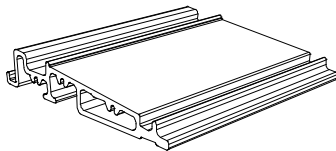
*V786 –Roller Track
No longer available



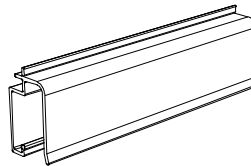
*V793 – Stationary
Panel Fastener and
Panel Guide Fastener



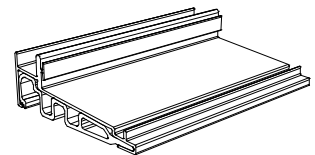
*V830 – Roller
Track Cover
No longer available



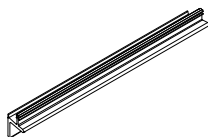
*F254 – Ultrex Sill



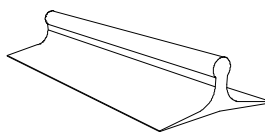
A641* – Screen Track
Replaced by A777



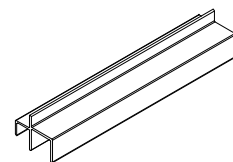
*V790/F250 – Sill cover and
Ultrex Sill Core Assembly



V1012 – Panel Drip
Black



A640 – Sill Track
(For interior oak sill)

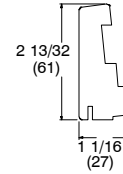


A703 – Stationary Panel
Clad Filler

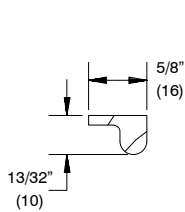
ILLUSTRATION <i>NOT TO SCALE</i>	DESCRIPTION	LENGTH	OPER./COLOR	PART NUMBER
	Weather Strip, Foam Leaf, Sill or Meeting Stile V1138		Beige Black	No longer available – replace with V1194
	Sill Weather Strip V791		Black	No longer available
	Head Jamb, Parting Stop, Astragal V1012		Black	No longer available

	Ultimate	Ultimate Wood
Head Jamb and Jamb Parting Stop	---	W7500
Stationary Panel Top Spacer	W8452	W8452
Sill Liner	W7532	---
Panel Top Track	W7583	W7583
Head Jamb Liner	W7274	W7274
Jamb Liner	W7505	W7505
Stationary Panel Top Filler	W7572	---
Stationary Jamb Filler	W7576	W7501
Center Jamb Liner	W7514	W7514
Interior Cover	W7515	W7515
Panel Top Track	---	W7503
Panel Top Track	W7573	W7573

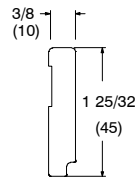
Discontinued – No Availability (NA)



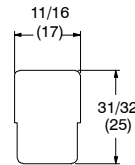
*W7500 – Head Jamb and Jamb Parting Stop – Wood



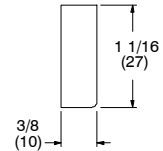
W8452



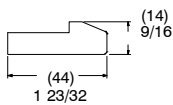
W7532 – Sill Liner (oak)



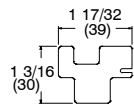
W7583 – Panel Top Track



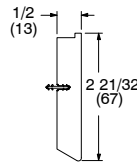
W7274 – Head Jamb Liner



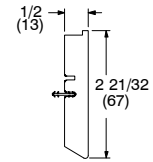
W7505 – Jamb Liner



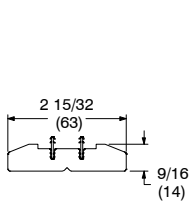
W7572 – Stationary Panel Top Filler



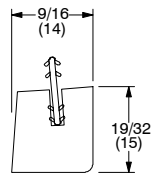
W7576 – Stationary Jamb Filler Ultimate



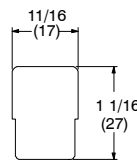
W7501 – Stationary Jamb Filler Ultimate Wood



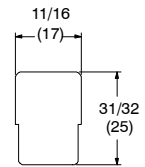
W7514 Center Jamb Liner



W7515 Interior Cover



W7503 Top Track Operator Panel Ultimate Wood



W7573 Top Track Operator Panel