

# Ultra high performance concrete materials

**A. Arora, M. Aguayo, Y. Yao, F. Kianmofrad, N. Neithalath, B. Mobasher**

**School of Sustainable Engineering and Built Environment, Arizona State  
University**

# Research Objectives

- Durability of cement-based materials due to the inherent brittleness and low tensile strength.
- Improved strength and ductility by adding fiber reinforcement.
- Enhance stiffness, shear strength
- A simplified deflection hardening bilinear moment model was derived [1].
- Materials development
- Characterization by means of testing
- Design guides Development



# Definition of UHPC

---

FHWA

a cementitious composite material composed of an optimized gradation of granular constituents, a water-to-cementitious materials ratio less than 0.25, and a high percentage of discontinuous internal fiber reinforcement

ACI  
Committee  
239

concrete that has a minimum specified compressive strength of 150 MPa (22,000 psi) with specified durability, tensile ductility and toughness requirements; fibers are generally included to achieve the specified requirement

# UHPC - Background

- Very high strength and ductility concrete
  - advances in particle packing
  - increased quality control
  - large amounts of fibers
  - very low water-to-cementing materials ratio  $C_c$
- Discontinuous pore structure that reduces liquid ingress, significantly enhancing durability
- Proprietary UHPC mixtures commonly used tend to be very expensive and does not account for local raw materials

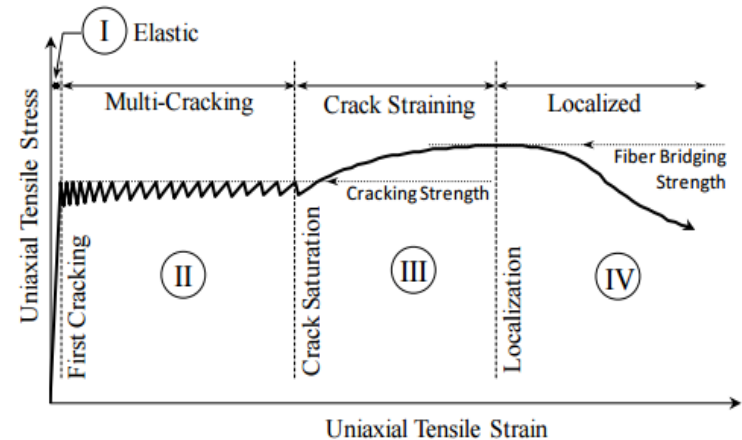

# Problem Statement

---

- How do we gain benefits of ultra-high-performance concrete (UHPC) in Arizona bridge projects without the high cost of proprietary mixes.
- A cost-effective, non-proprietary UHPC mix or mixes for use in bridge element connections during accelerated bridge construction (ABC) under Arizona conditions.

# Introduction

- Desire of energy-efficient, environment friendly, sustainable, resilient
- Ultra-high performance concrete (UHPC)
  - 150 MPa (22 ksi)
  - 1.5%~6% steel fibers
  - High strength
  - Low permeability
- Strength, ductility, impact resistance, durability, aggressive environmental and chemical resistance
- Thin sections
- Complex structural forms
- Cast by pouring, injection, extrusion





# Thin sections and complicated shapes



# Strain Softening and Strain hardening

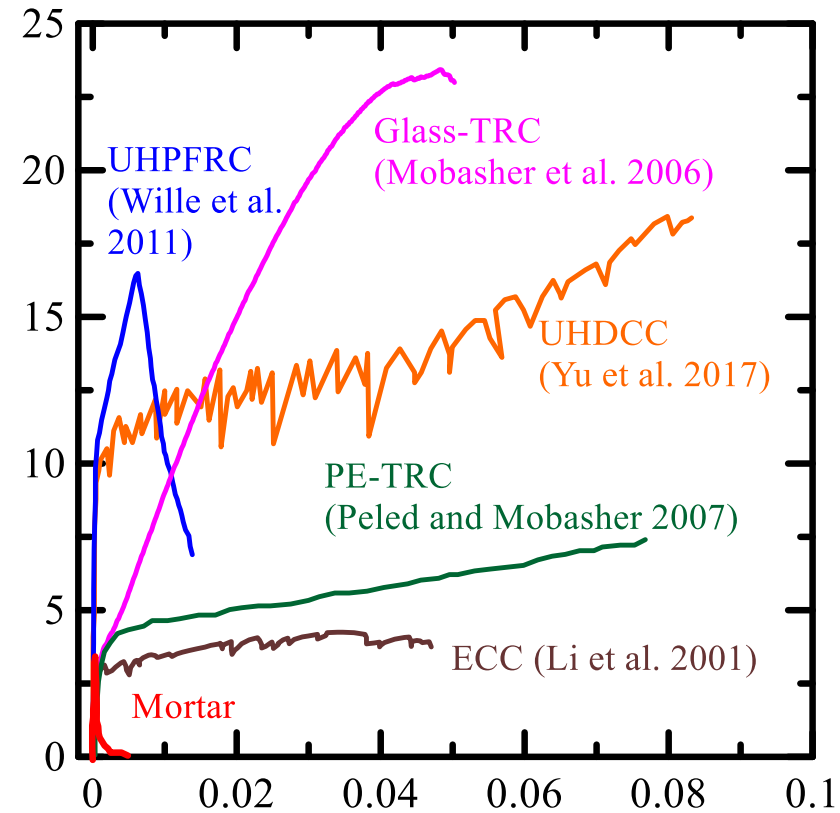
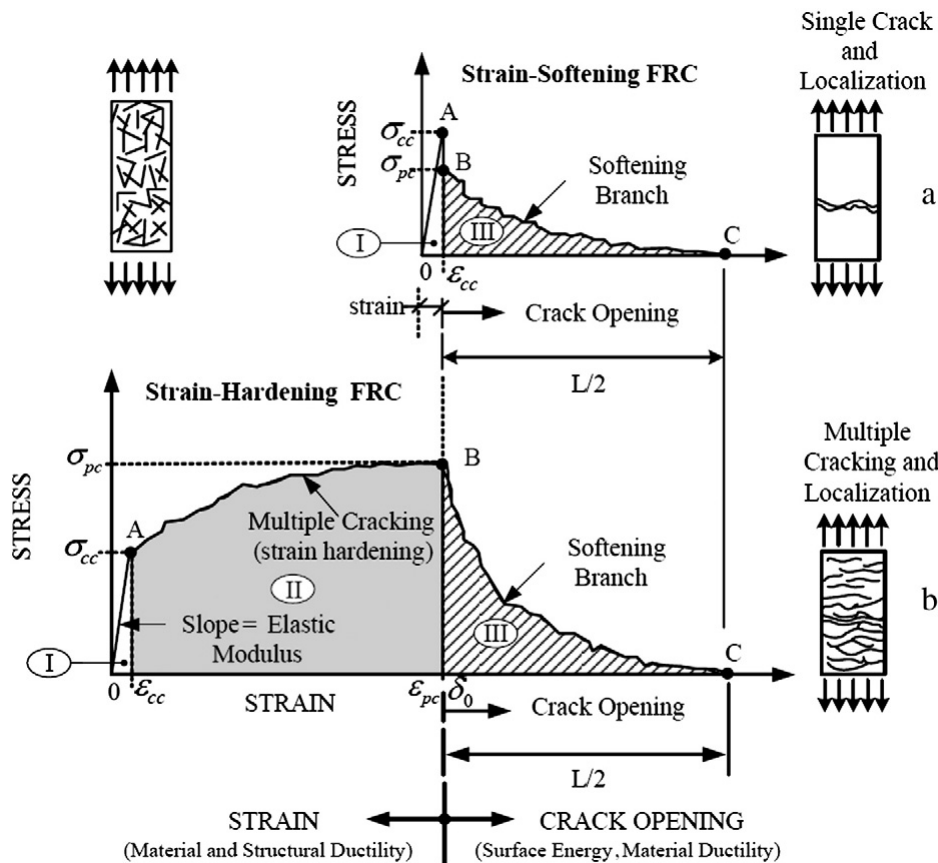

Tensile stress-strain curves of strain hardening FRCs

Typical stress-elongation curves in tension of fiber reinforced cement composites: (a) strain-softening. (b) strain-hardening.



# Toughening Due to Fiber Bridging

- Fiber debonding and pullout
- Closing Pressure
- Crack face stiffness
- Stress Intensity reduction
- Crack closure

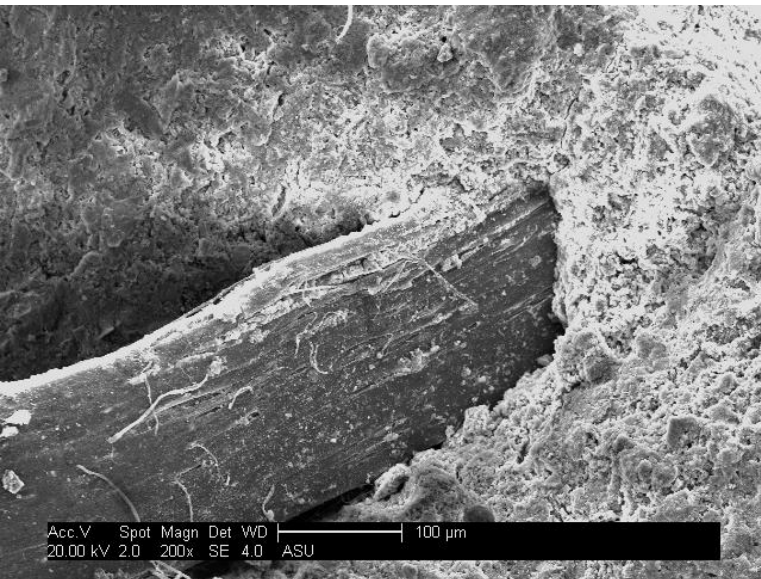
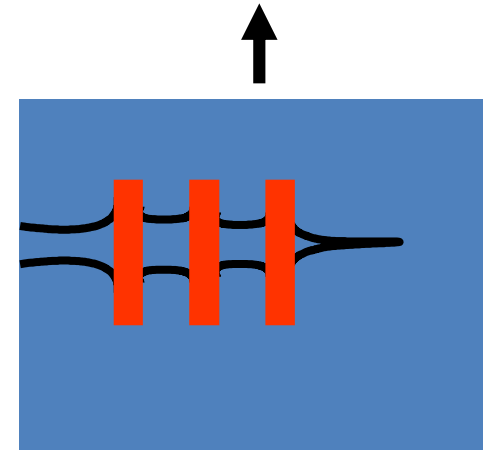

PP FRC Composites

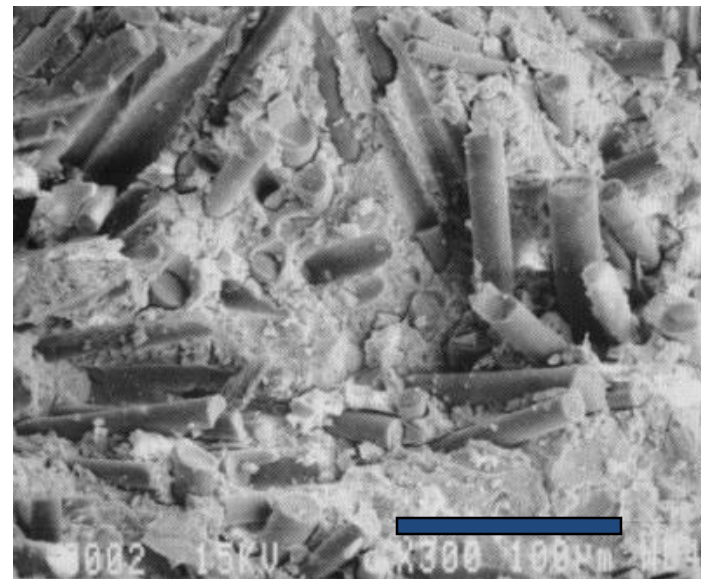

Carbon Fiber Composites

# Representation of fiber reinforced cement based composites

- Four Response Systems
  - Strain Softening/Hardening, Deflection Softening/Hardening
- Strain softening behavior
  - Discrete fiber systems
  - SFRC, PFRC, GFRC, SIMCON, SIFCON
- Strain hardening behavior
  - Discrete & continuous fiber systems
  - UHPC, Textile reinforced cement (TRC), GRFC, Ferrocement (FRC), ECC
- Load-Deflection Calculations

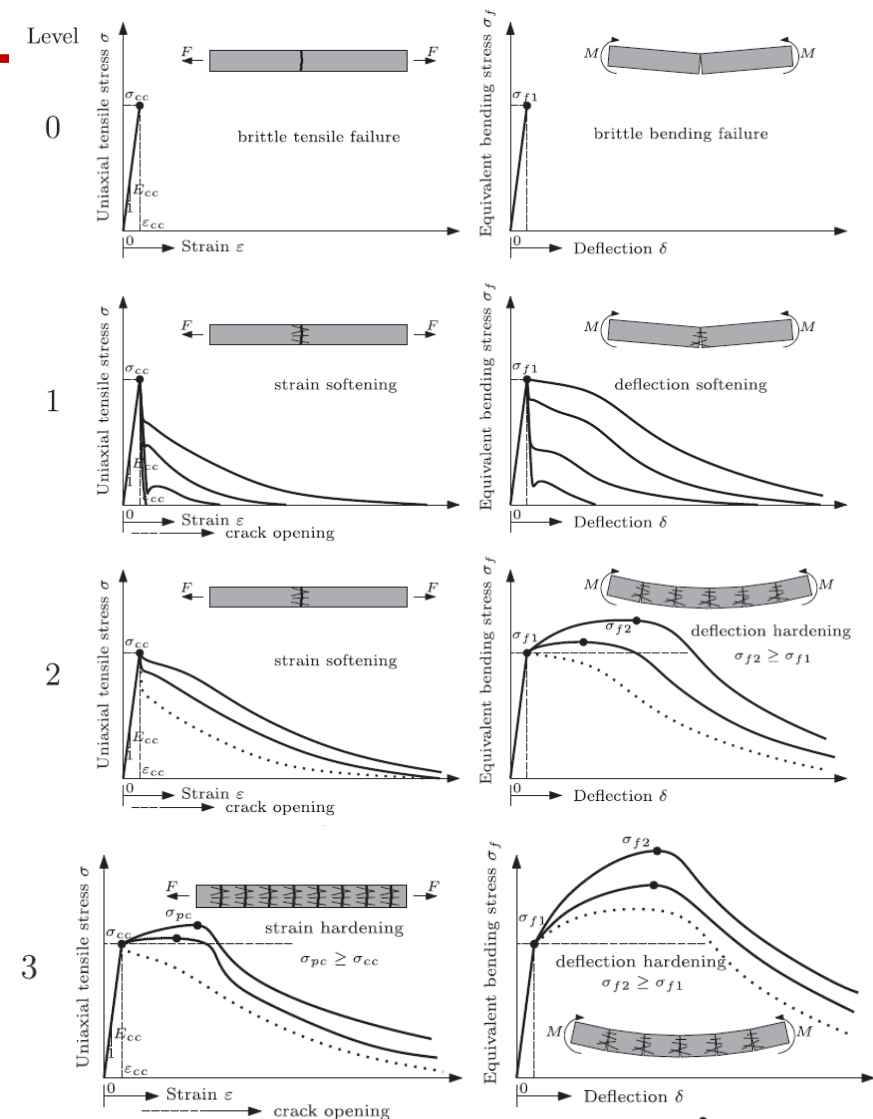

# Applications of Fiber Reinforced Concrete

---

- Fiber reinforced concrete are primarily used for applications that toughness of materials are of concerns
- Some of the applications are:

Pavement



First floor, elevated slab



Elevated slabs  
(recent development)





# Self Compacting Fiber Reinforced Concrete









# Applications of UHPC in Highways



# US UHPC Highway bridges



**Jakway Bridge, Buchanan County,  
Iowa**



**Mars Hill Bridge, Wapello County,  
Iowa**



# UHPC girders and decks



Jakway Park Bridge in Buchanan County, Iowa



# Prefabricated deck elements

- eliminate activities that are associated with conventional deck construction, which typically includes onsite installation of deck forms, overhang bracket and formwork installation, reinforcing steel placement, paving equipment set up, concrete placement, and concrete curing, all typically occurring in a sequential manner.



- Lightweight precast deck panels

# Examples of Prefabricated deck elements

- Precast Elements
  - partial-depth precast deck panels
  - full-depth precast deck panels with and without longitudinal post-tensioning
- lightweight precast deck panels
  - FRP deck panels
  - steel grid (open or filled with concrete)
  - orthotropic deck
- other prefabricated deck panels made with different materials or processes



- Full-depth precast deck panels with and without longitudinal post-tensioning



# Columns, Spread footing, Column caps



Prefabricated caps for caisson or pile foundations

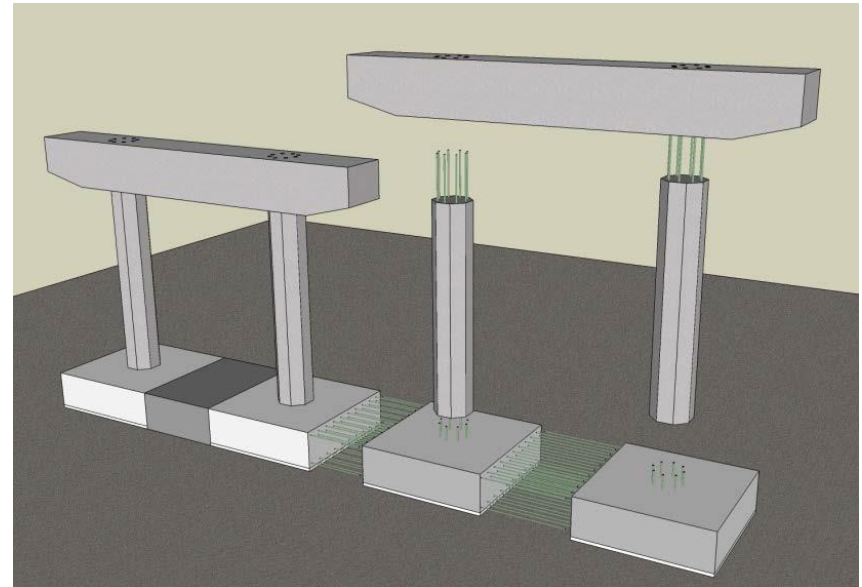

Precast spread footings, Prefabricated columns  
Prefabricated column caps

# Prefabricated Beam Elements

- “deck” and “full-width” beam elements.
- Deck beam elements eliminate conventional onsite deck forming activities.
- Examples of Deck Beam Elements: adjacent deck bulb tee beams, double tee beams , inverted tee beams, box beams , modular beams with decks.

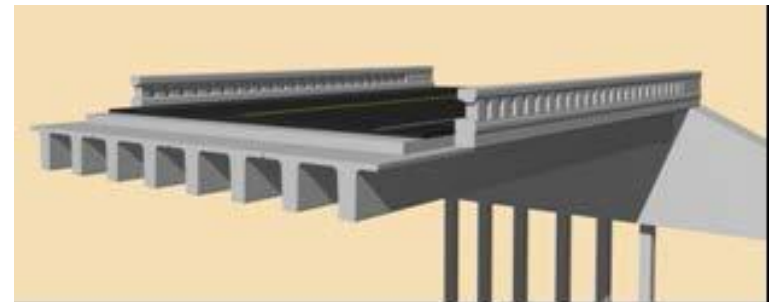
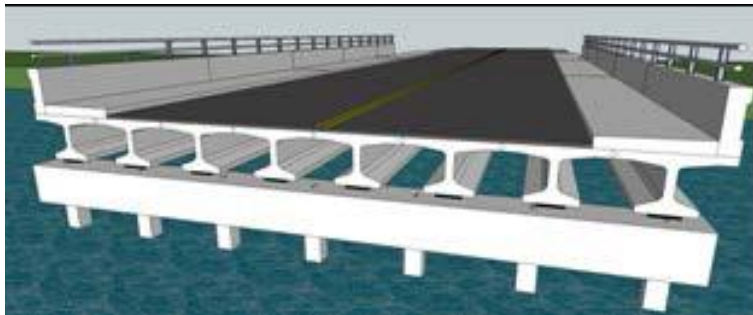
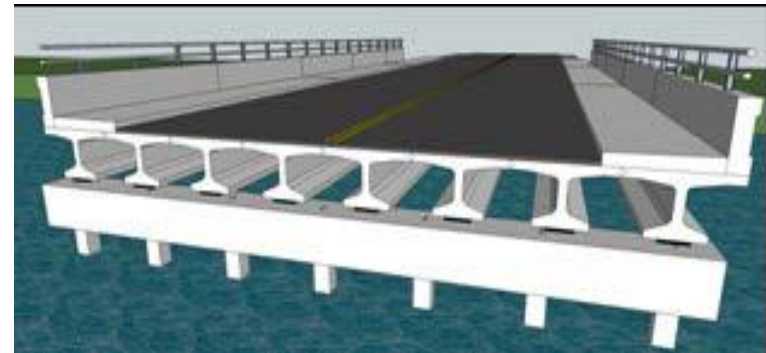
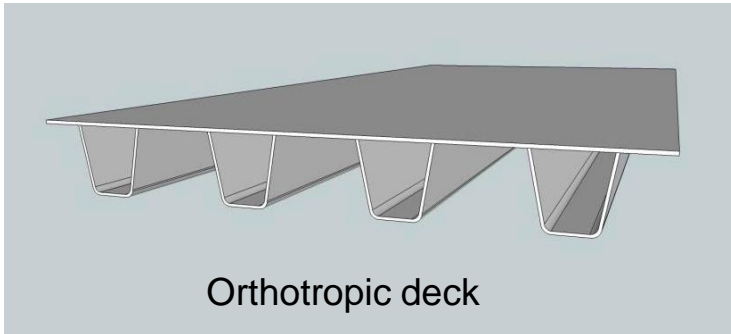



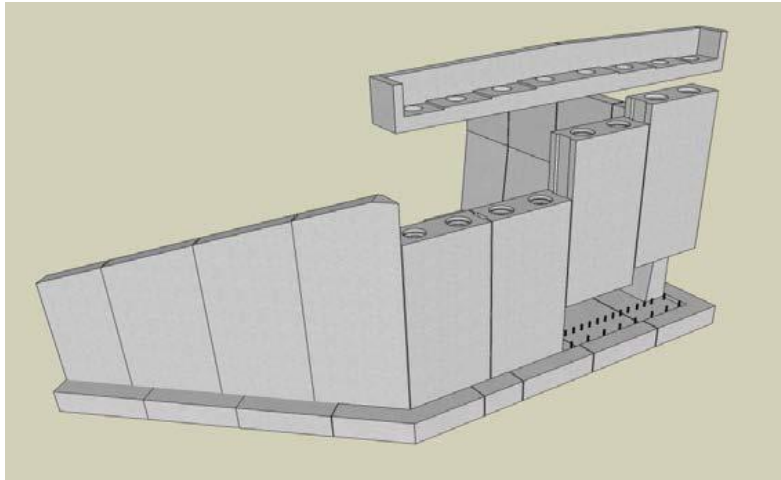

Precast footings, wing walls, or backwalls

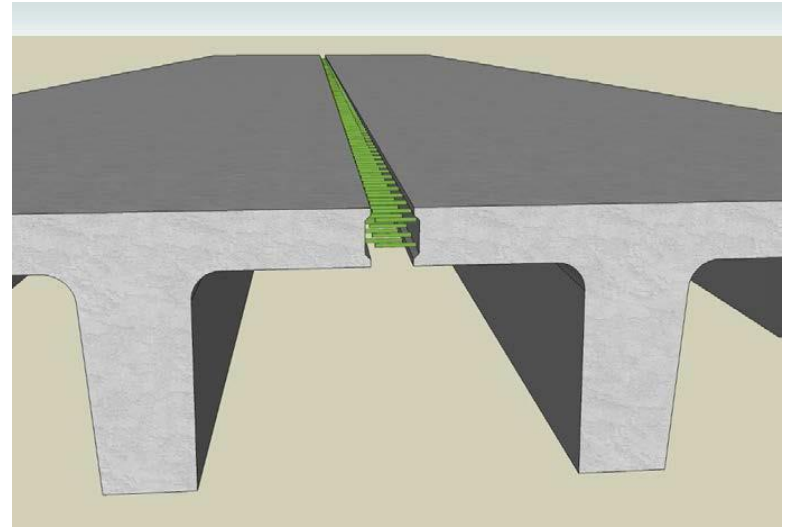

Potential UHPC Connection

# Field-cast UHPC Connections

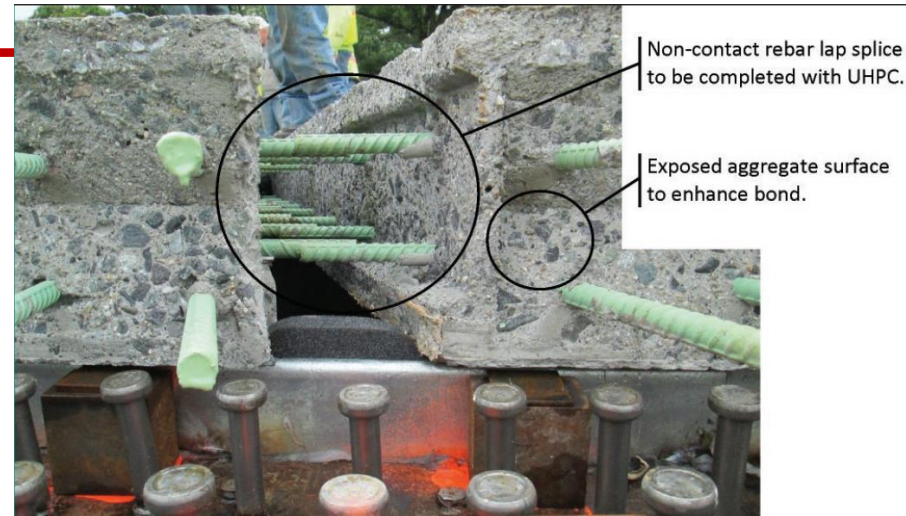
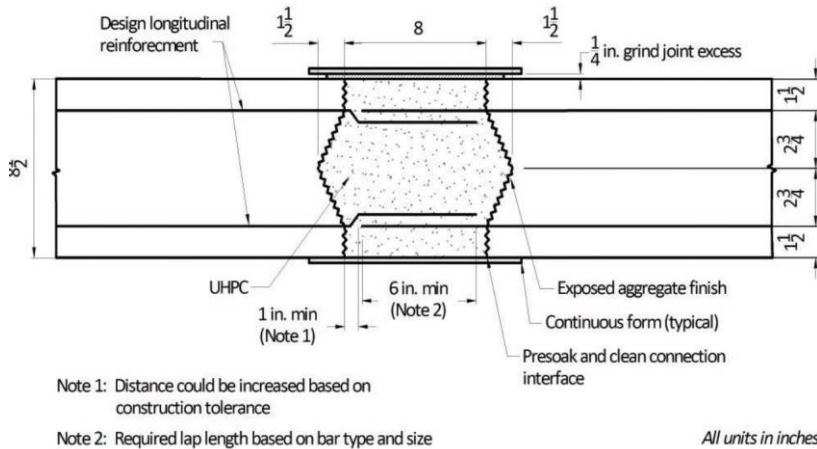

UHPC connection between precast deck panels as deployed by NYSDOT on CR47 over Trout Brook.

Deck-level connection between precast deck panels.

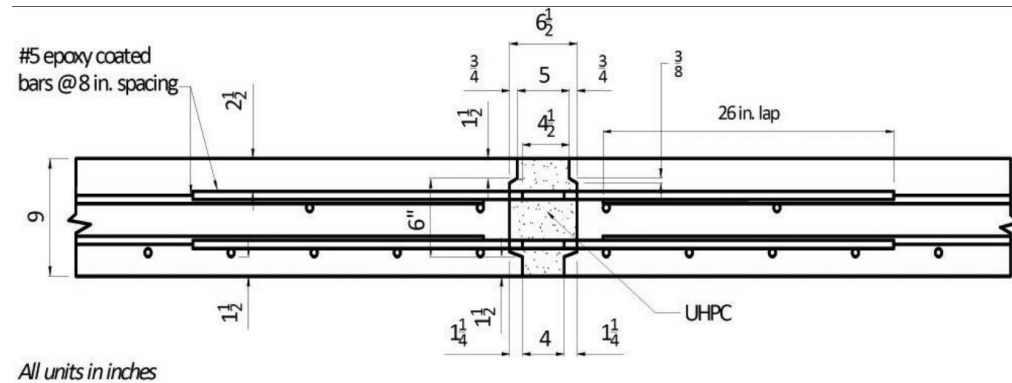

UHPC connection between precast deck panels as deployed by NYSDOT on I-81 in Syracuse, NY





# Development of Non-Proprietary Mix Designs

- Designing the ideal paste phase for UHPC
  - Local materials and combinations
  - Particle packing methods
  - Experiments and simulations
- Rheological properties

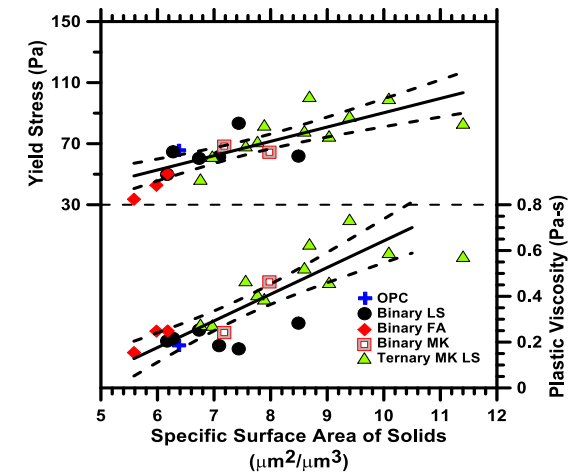
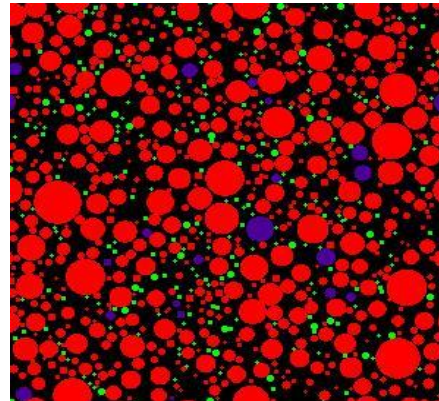
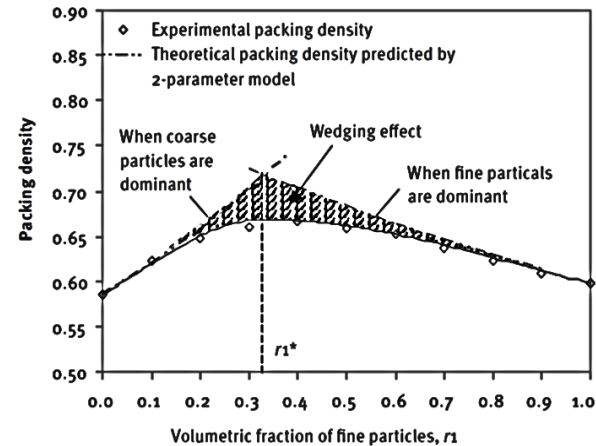

# Materials Gradation

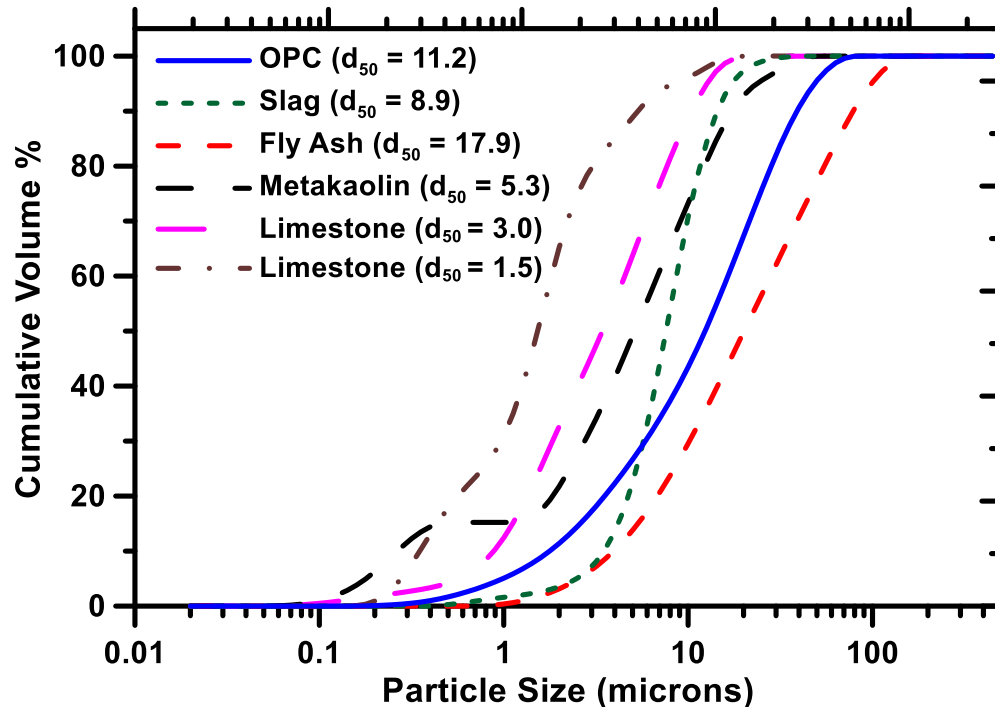

## Materials selected

- **OPC** – ASTM C150 cement
- Alumina sources – **Slag**, **Metakaolin** (pozzolanic as well as react with carbonates present in the system)
- **Limestone** – 3.0 micron and 1.5 micron. Fine limestone help with dense packing of microstructure.
- **Fly Ash** – pozzolanic, spherical particles aid with workability.

# Microstructure Packing

---

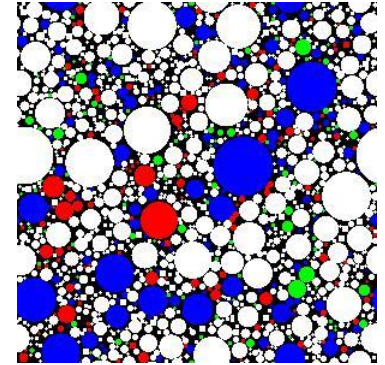
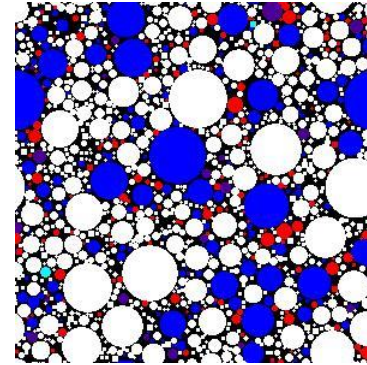
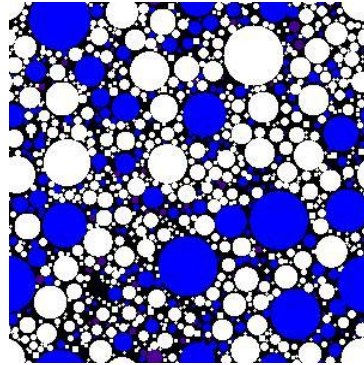
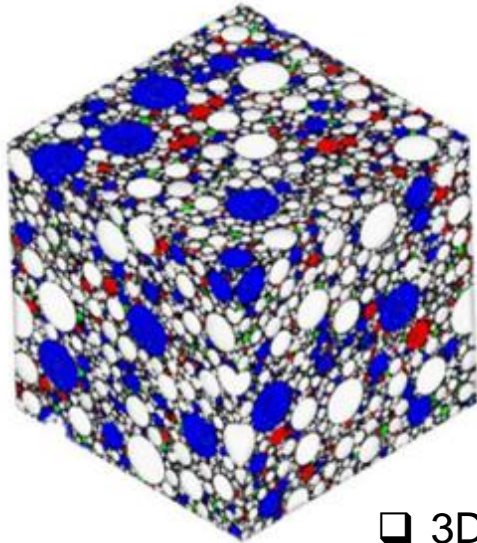

- ❑ 3D RVEs are generated using a stochastic particle packing model assuming spherical particles. OPC is represented in white, fly ash in blue, metakaolin in red and limestone in green.
- ❑ PSDs are discretized to get the number of spheres for each phase.
- ❑ These digitized microstructures are used to obtain key parameters that influence the hydration process.

# Rheology of Pastes - Results

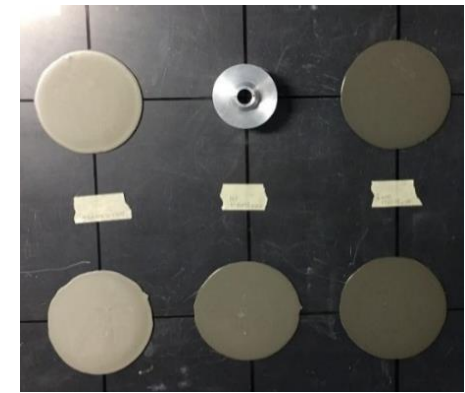
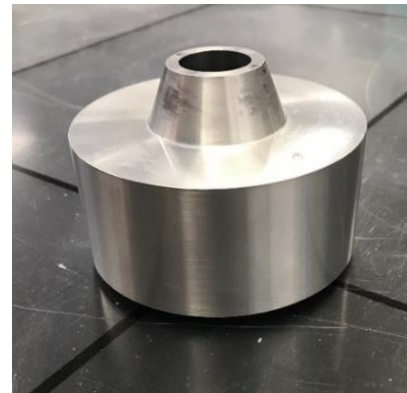
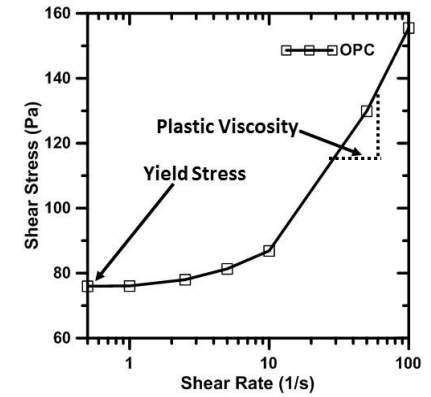
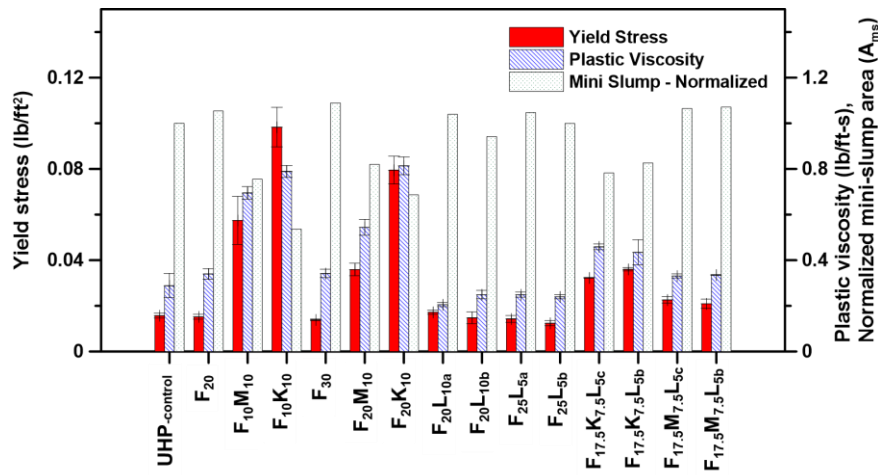

# Selection based on Overall Analysis

- Results for mixes selected using Model 1

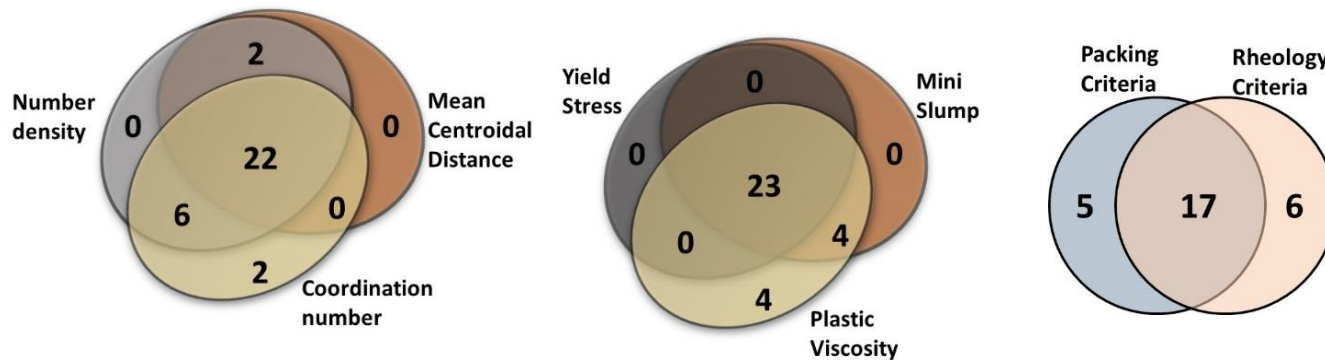

- Results for mixes selected using Model 2

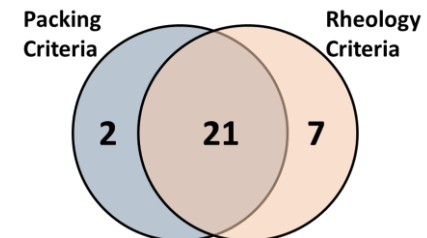



# Mix Designs Selected for Detailed Study

- Mixtures that obtained the maximum compressive strength values were selected.
- Water/cement ratio was reduced from initial value of 0.24 to 0.20 or less.
- This was achieved by optimization of water to superplasticizer ratio to have more water in the mixture while maintaining the same workability.
- Mixing at high shear rate for longer duration.

Mixture composition	Mixture ID	Replacement material (% by mass of cement)			
		Fly Ash (F)/ Slag (S)	Metakaolin (K)	Microsilica (M)	Limestone (L); d <sub>50</sub> of 1.5 or 3 μm
OPC + M + L	T_SF	0	0	20	30
OPC + S + M + L	Q_SL	17.5	0	7.5	5b,5c
OPC + S + K + L	Q_FA	17.5	7.5	0	5b,5c

# Aggregate Classes Used

- 5 different aggregate classes were used corresponding to sizes - #4, #8, #10, coarse sand with a  $d_{50} = 0.6$  mm, fine sand with a  $d_{50} = 0.2$  mm
- Steel fibers –  $d = 0.6$  mm,  $l = 13$  mm.



Mechanical Splitter used to obtain uniform gradation of particles

# Mixing Procedure

A number of mixing procedures were employed including the use of high shear Omni mixer, Hobart mixer and hand-held Dewalt spade-handle drill.

Step 1 - Aggregate + Silica Fume

Step 2 – Add OPC and Fly Ash

Step 3 – Add water and superplasticizer in increments until a cohesive mixture was obtained.

Step 4 – Add fibers





# Testing of UHPC concretes

- Mixing and placing of UHPC, rheology
- Strength and modulus development
- Toughness/Ductility

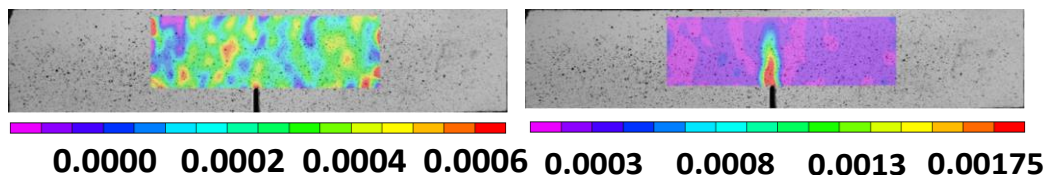
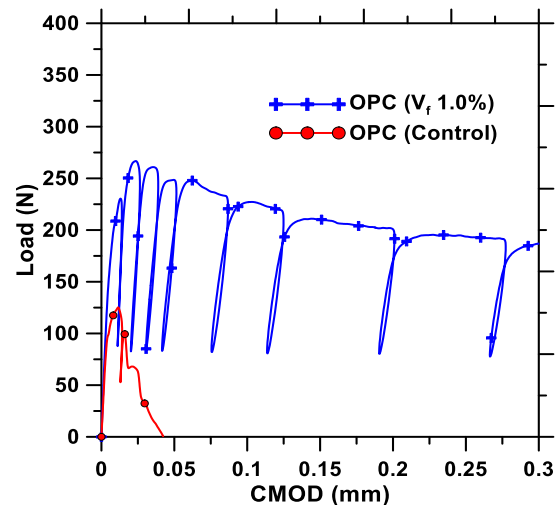
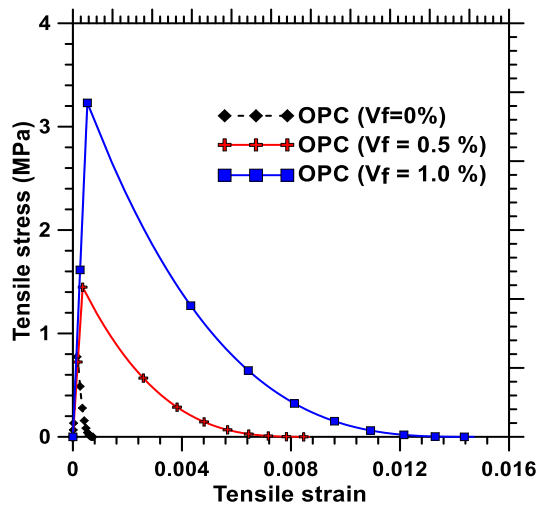

# Strength Results

- Compressive strength values for cylinders as high as 175 MPa were obtained at ~90 days of hydration.
- All samples attained a compressive strength of 125 MPa or more at 28 days.
- Heat cured samples showed higher strengths at early ages, and similar strengths at 28 days.

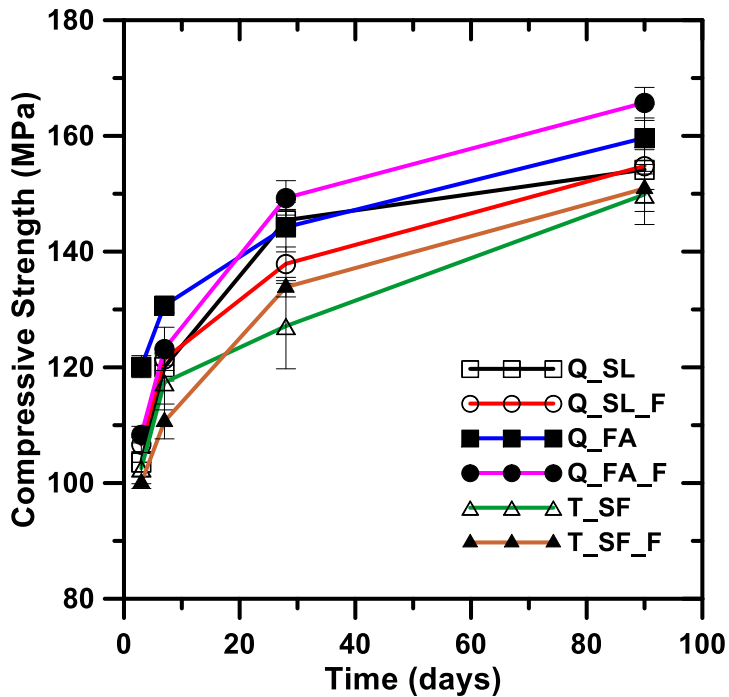

Compressive strength results for 75 mm x 150 mm cylinders

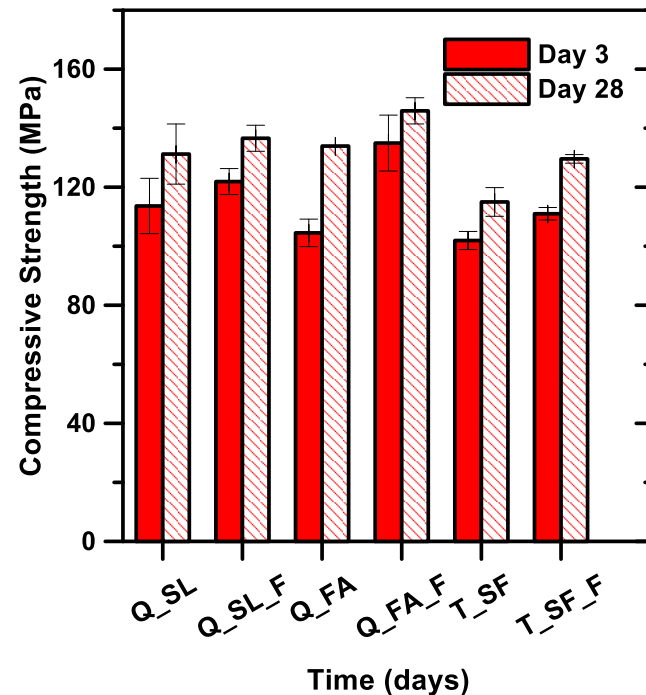

Compressive strength results for 50 mm cubes – Heat cured at 80°C

# Flexural testing

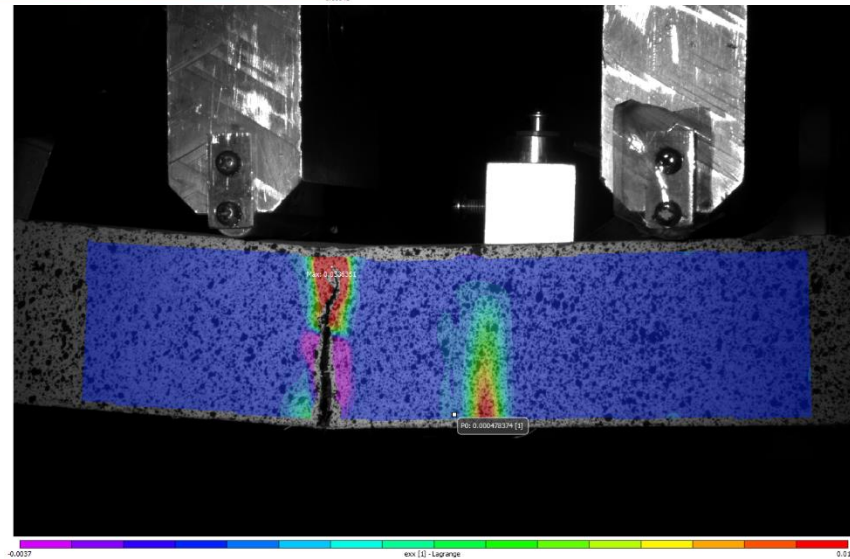
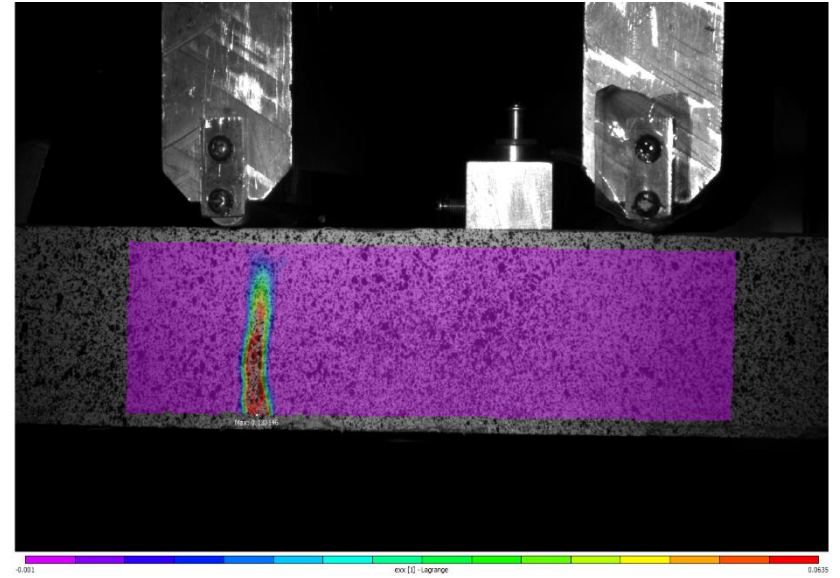
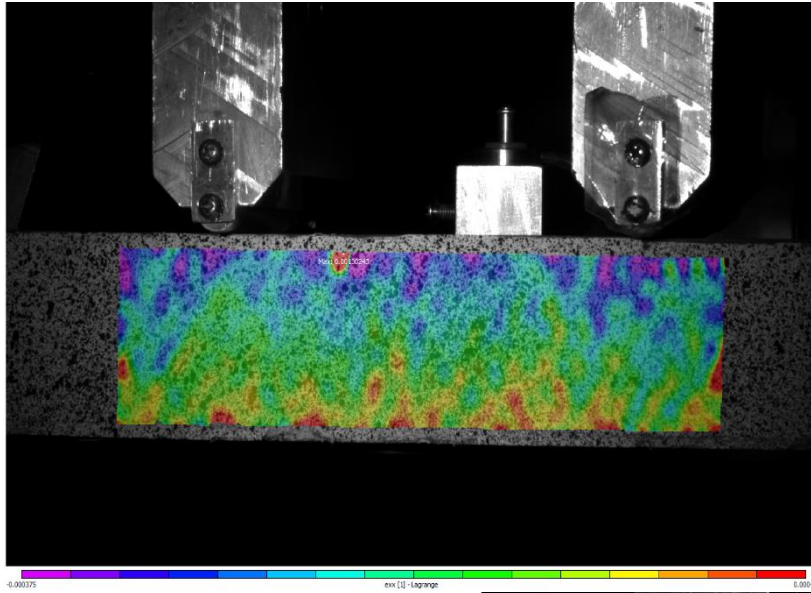



# Durability Testing of UHPC concretes

- Shrinkage cracking
  - Free shrinkage, Restrained ring
- Chloride transport resistance
  - Rapid chloride permeability test (ASTM C 1202)
  - Chloride migration (NT Build 492)
  - Relating pore structure to transport
- Freeze-thaw resistance
- Chapter documenting the test result matrix of mixtures

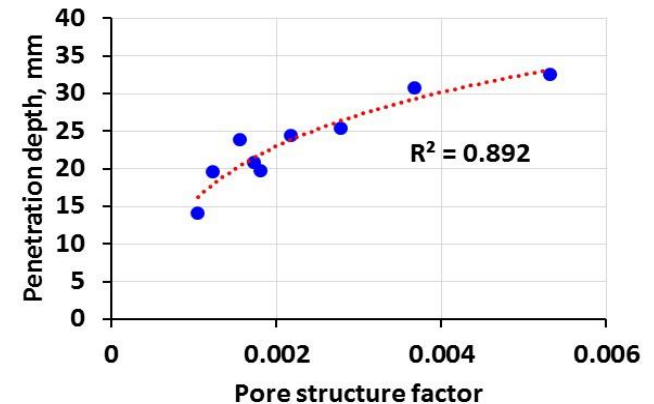

# New Design Tools for Structural Engineering



# Steel Fiber Reinforced Concrete

Composition	Amount
Cement Type I	350 kg
Fly ash	60 kg
Aggregate (1.1:1)	1800 kg
W/C	< 0.5
Supper plasticizer	1.25 % by Vol.

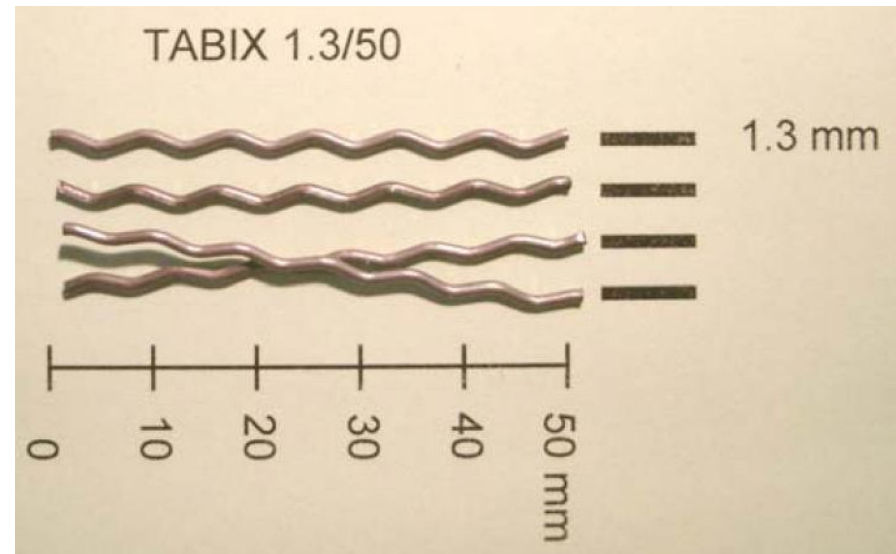

- Two volume fractions
  - $V_f = 80 \text{ kg/m}^3$
  - $V_f = 100 \text{ kg/m}^3$



# Ductile Steel Fiber Composites

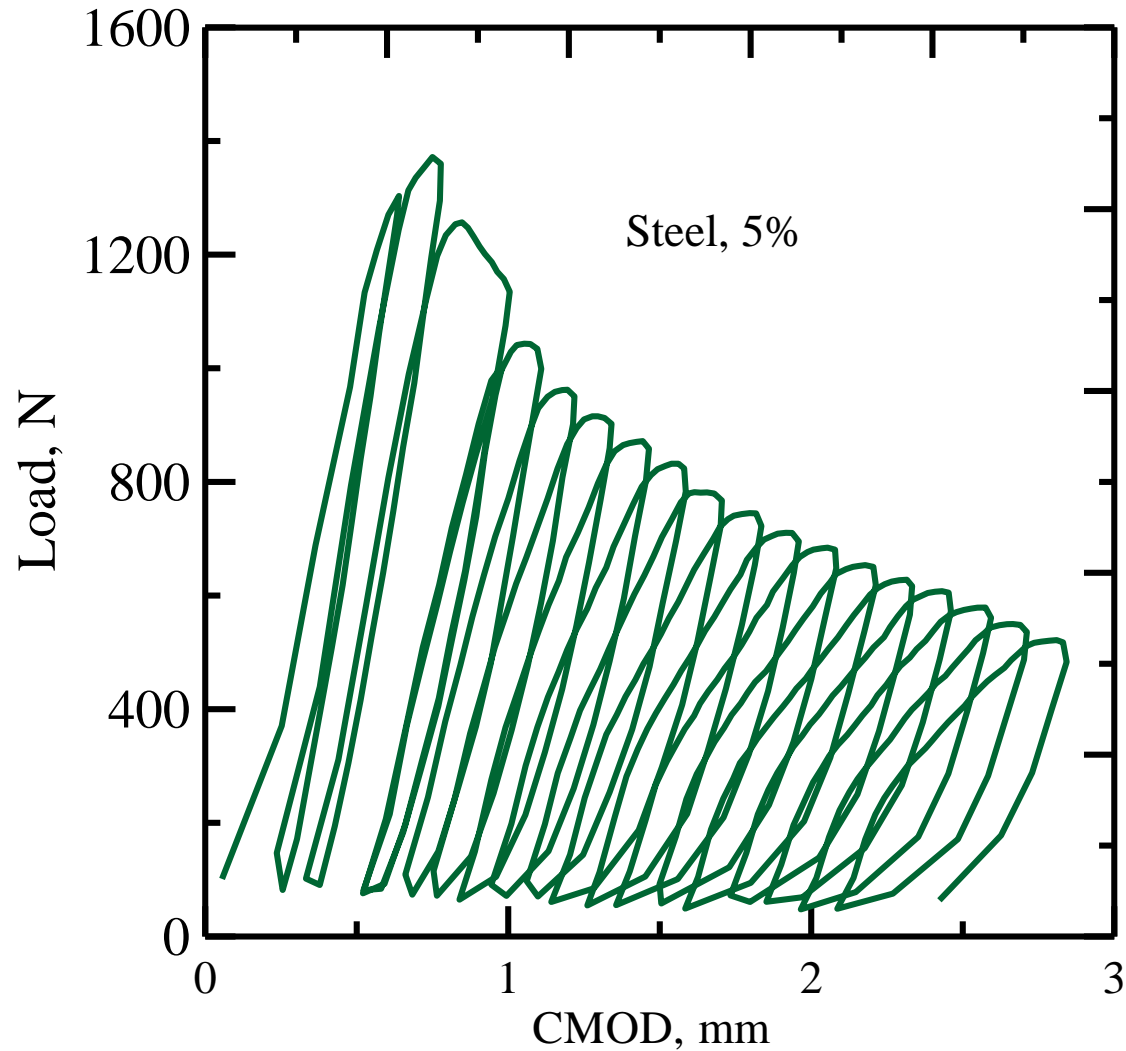

# Round Panel Test

- A round panel test is used to evaluate SFRC
- Test setup
  - displacement control
  - continuous support
  - center point load
  - measure load vs. mid span deflection
- Dimensions
  - clear diameter 1500 mm
  - thickness = 150 mm
  - stoke diameter = 150 mm



# Typical Crack Patterns

---

- The test reveals unsymmetrical multiple radial crack patterns

$V_f = 80 \text{ kg/m}^3$   
Sample 8-02

$V_f = 100 \text{ kg/m}^3$   
Sample 1-07

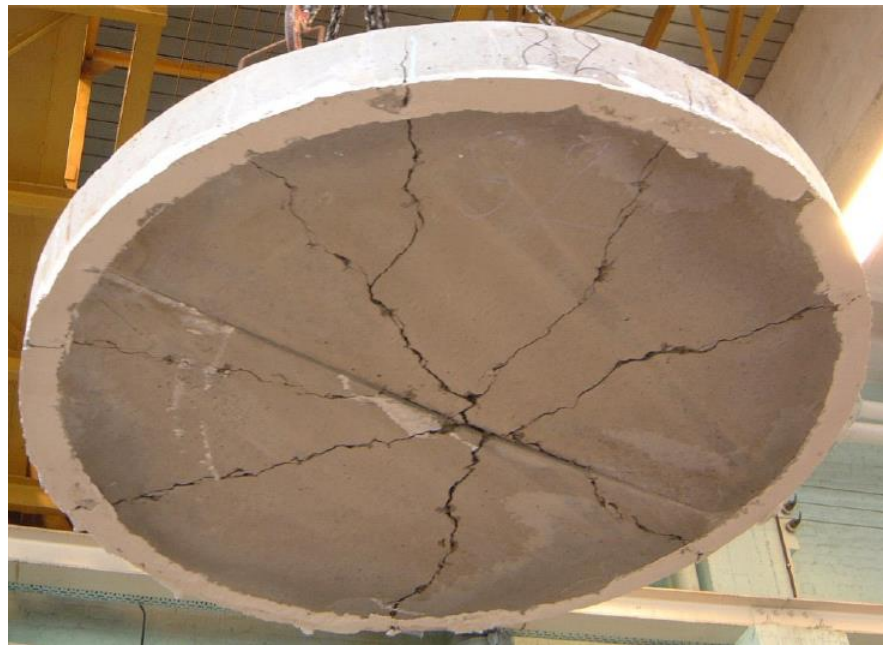



# Typical Response of a Full Model

- In elastic range, the deformation is symmetrical such that symmetric criteria can be imposed as boundary conditions to improve the efficiency of the model
- In plastic stage, strain energy density localizes in crack band regions

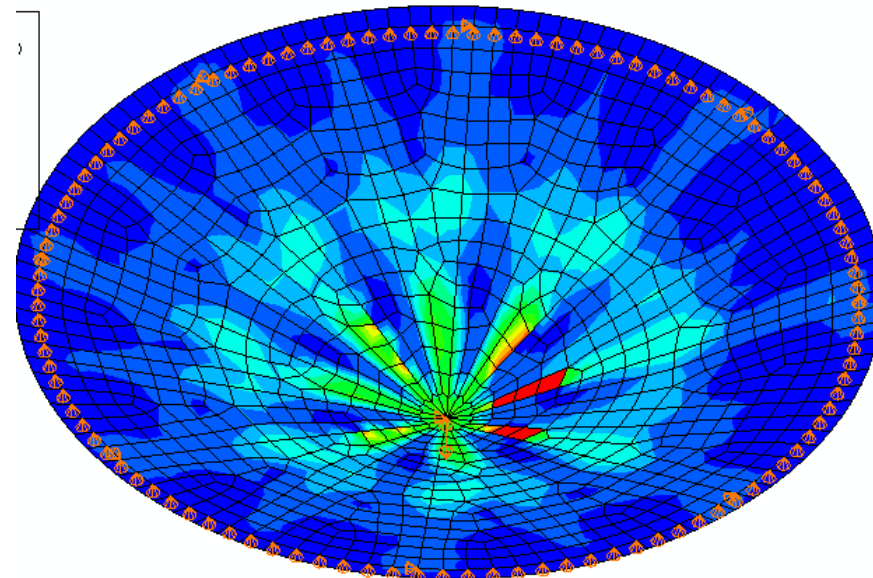
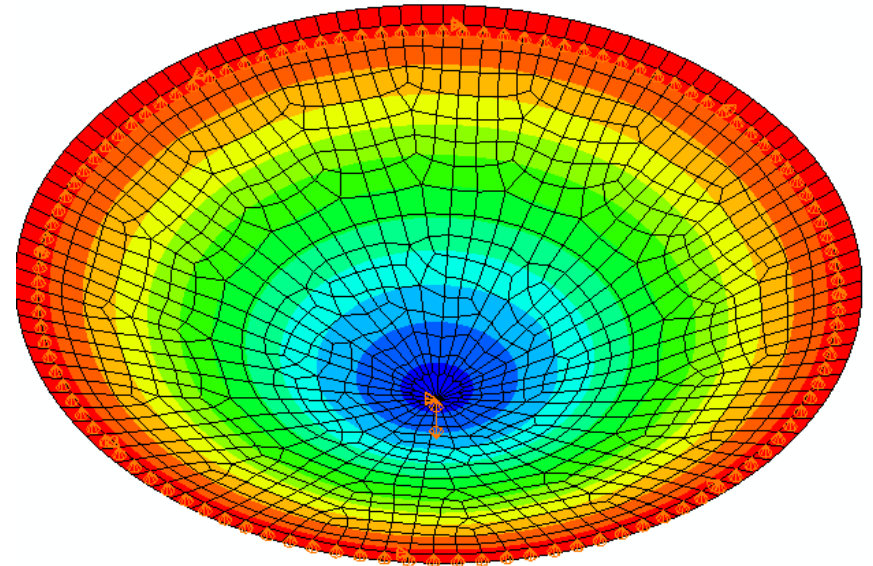

# Test Results and Averaged Response

- Load deflection responses of two mixes

$V_f = 80 \text{ kg/m}^3$

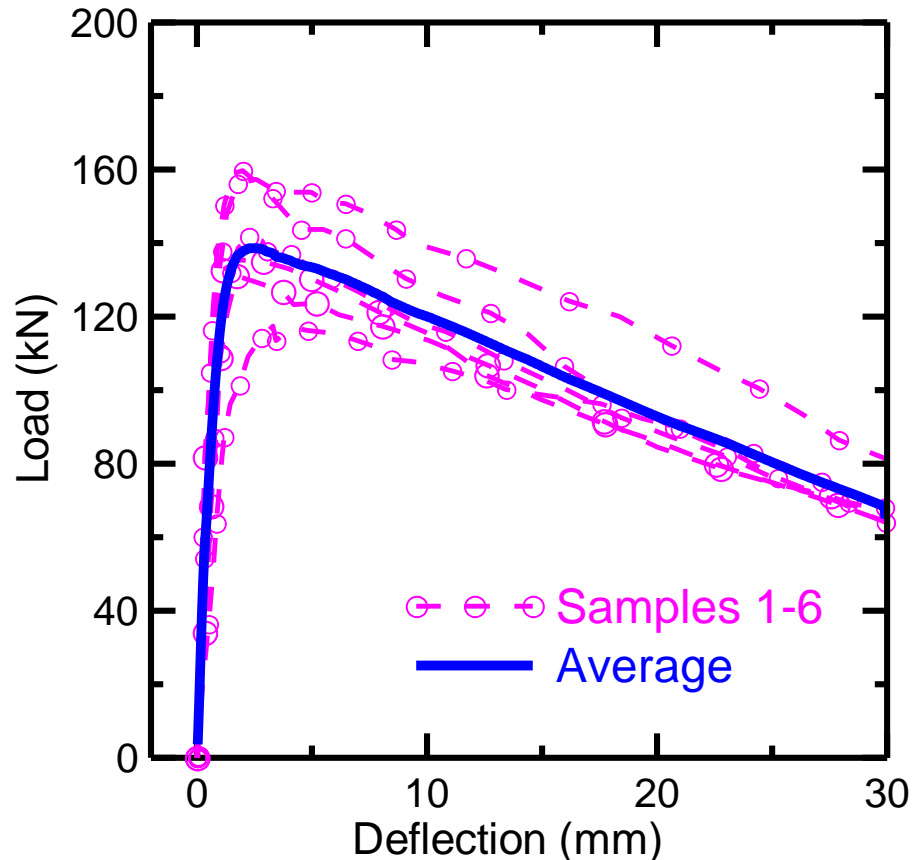

$V_f = 100 \text{ kg/m}^3$

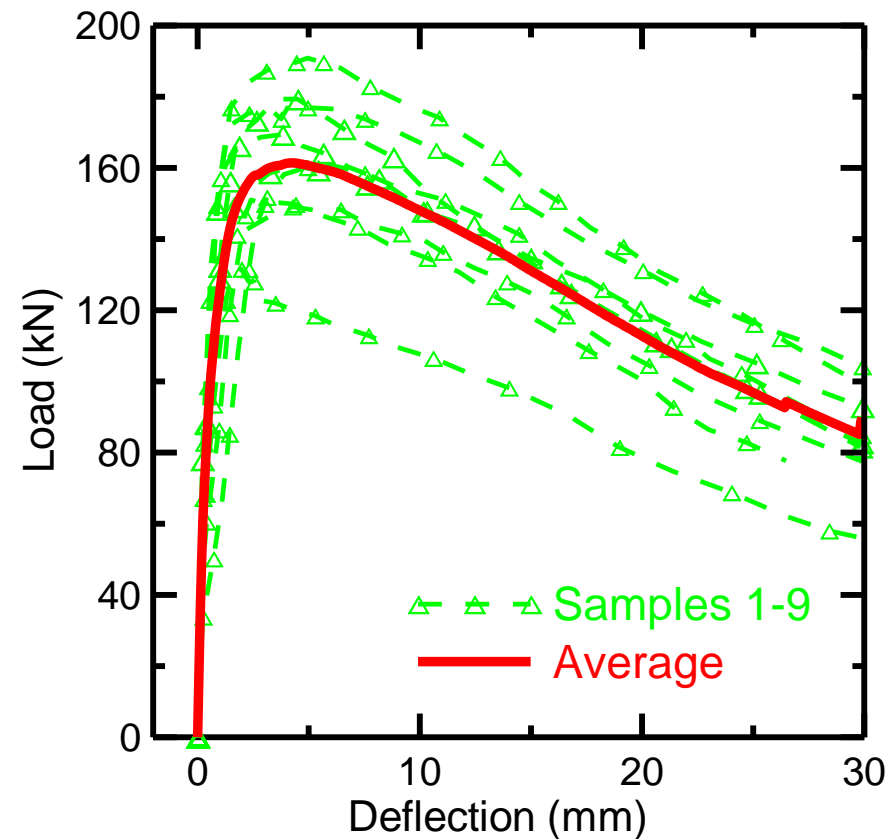

# Fracture and plasticity models

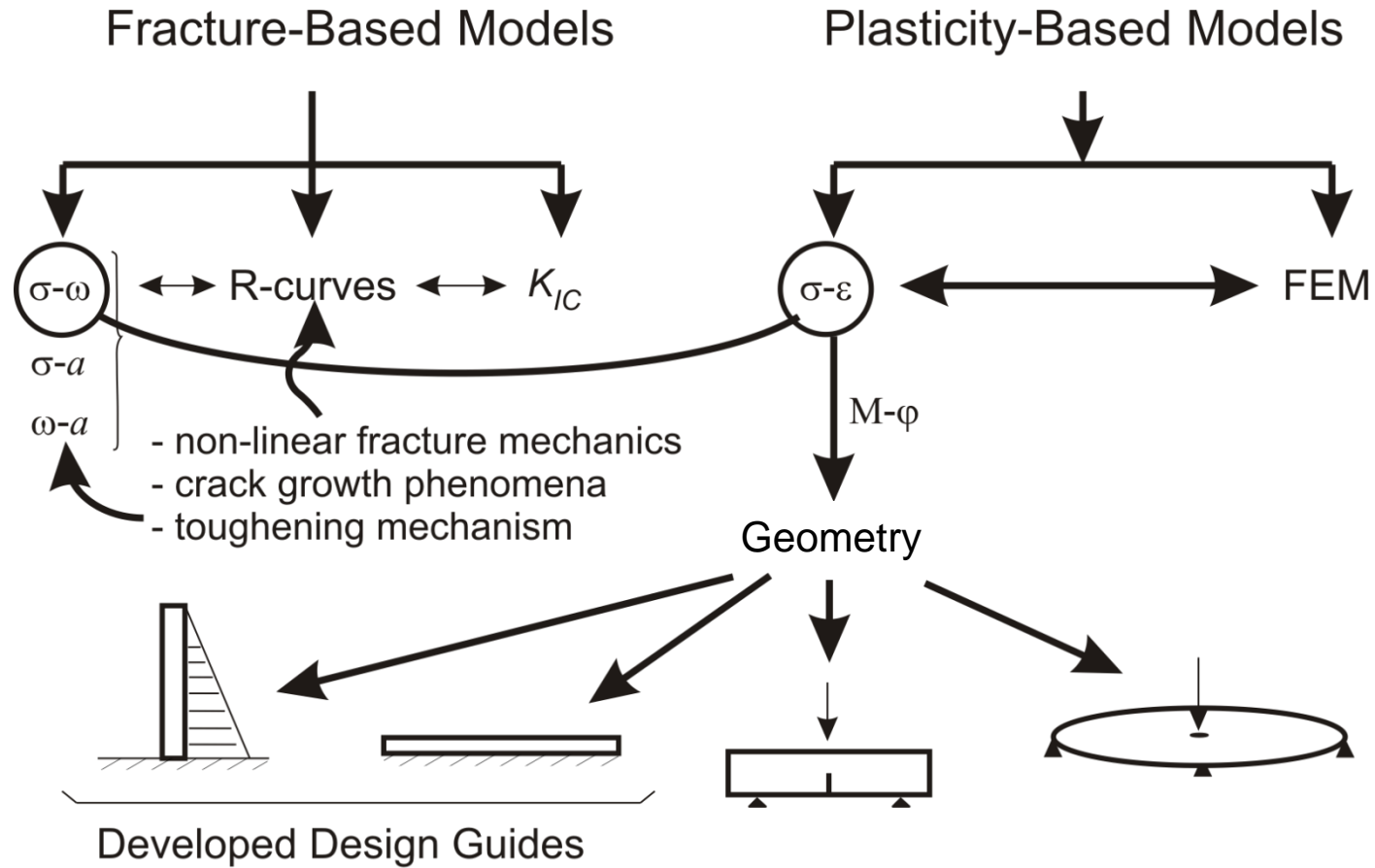



# Experimental Verification- UHPC beam

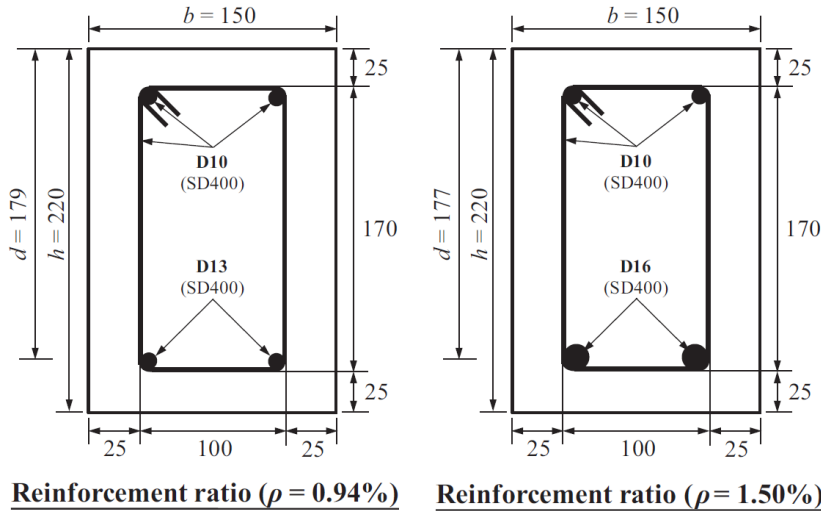

- Full size UHPC beam
- 2% of smooth/twisted steel fiber
- $f'_c = 201-232$  MPa
- $P = 0.94\%$  or  $1.5\%$

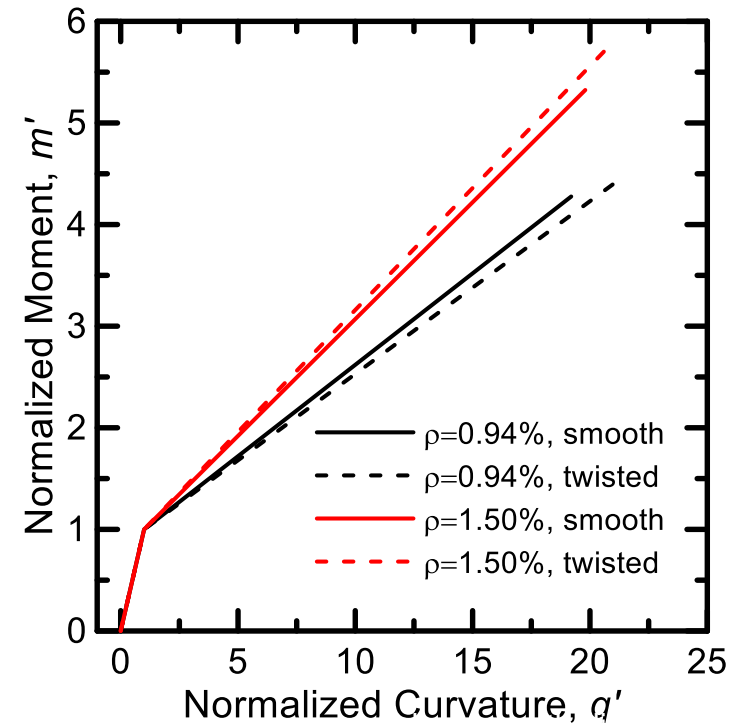
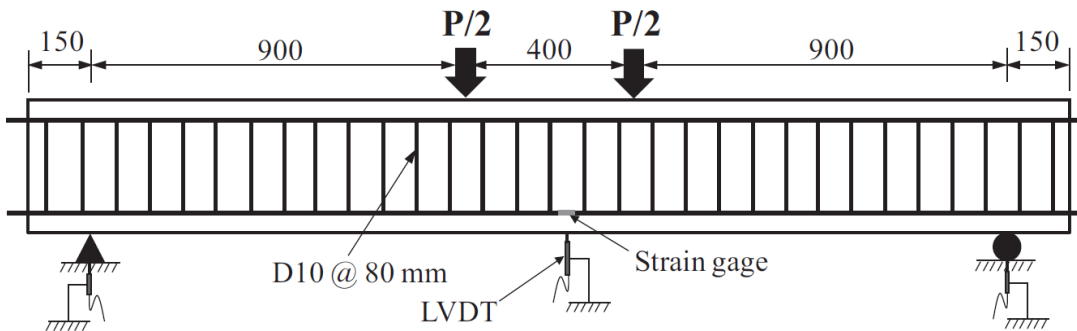

# Experimental Verification- RC with Steel fibers

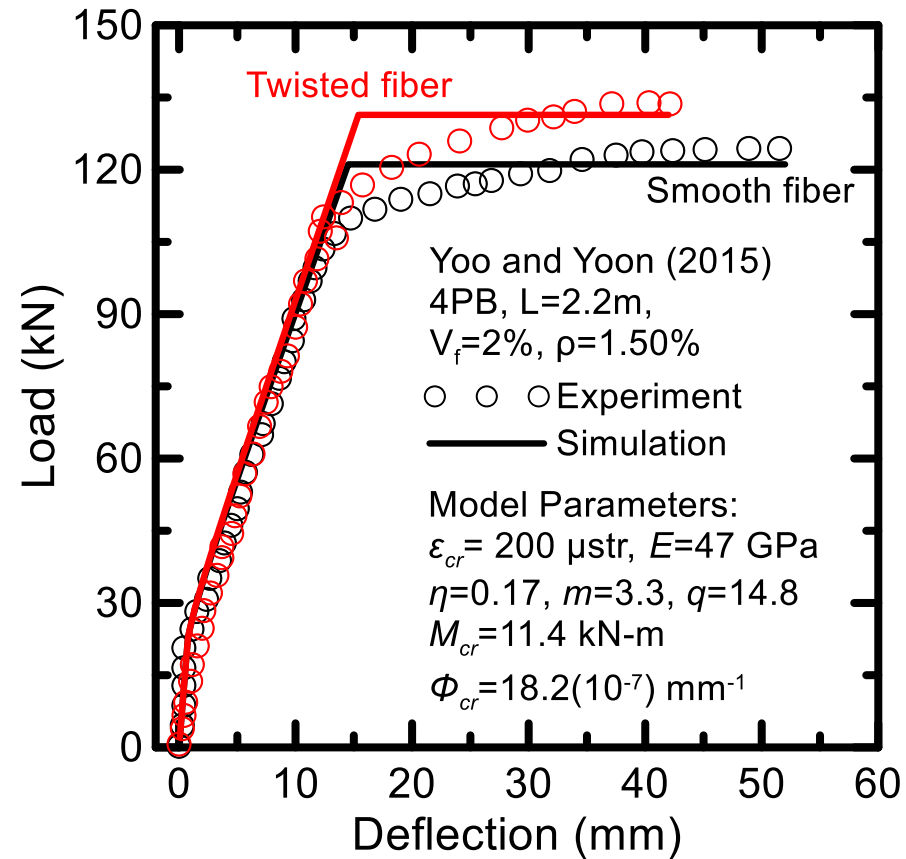
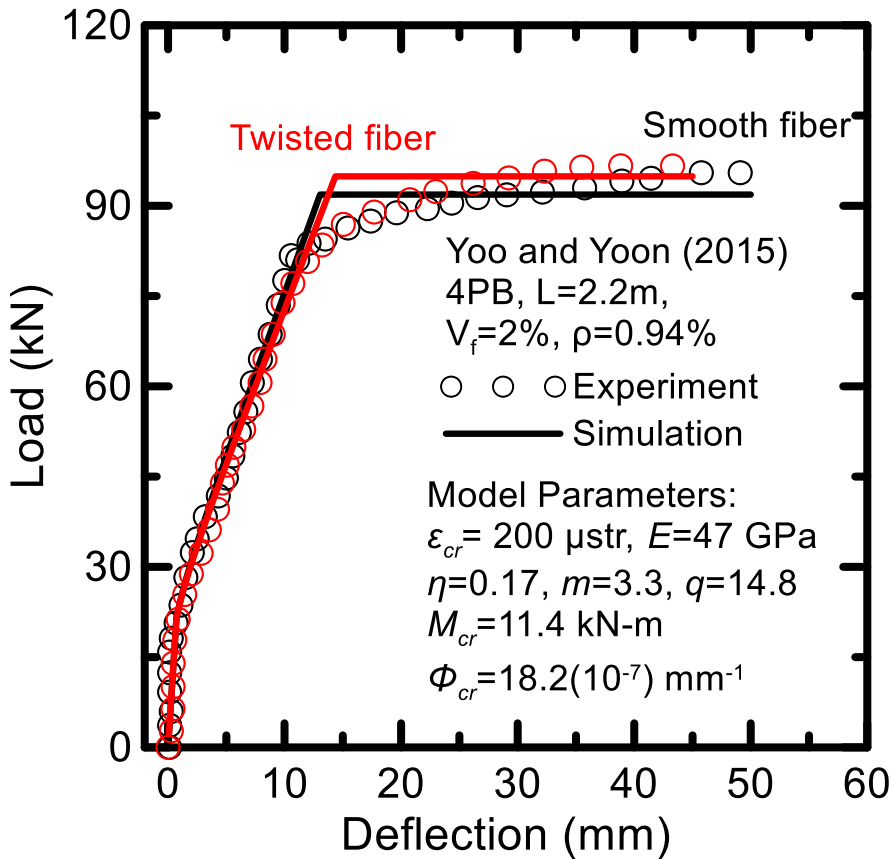

# UHPC Pi-girder: FHWA Study



Jakway Park Bridge in  
Buchanan County, Iowa

# Modelling Approach

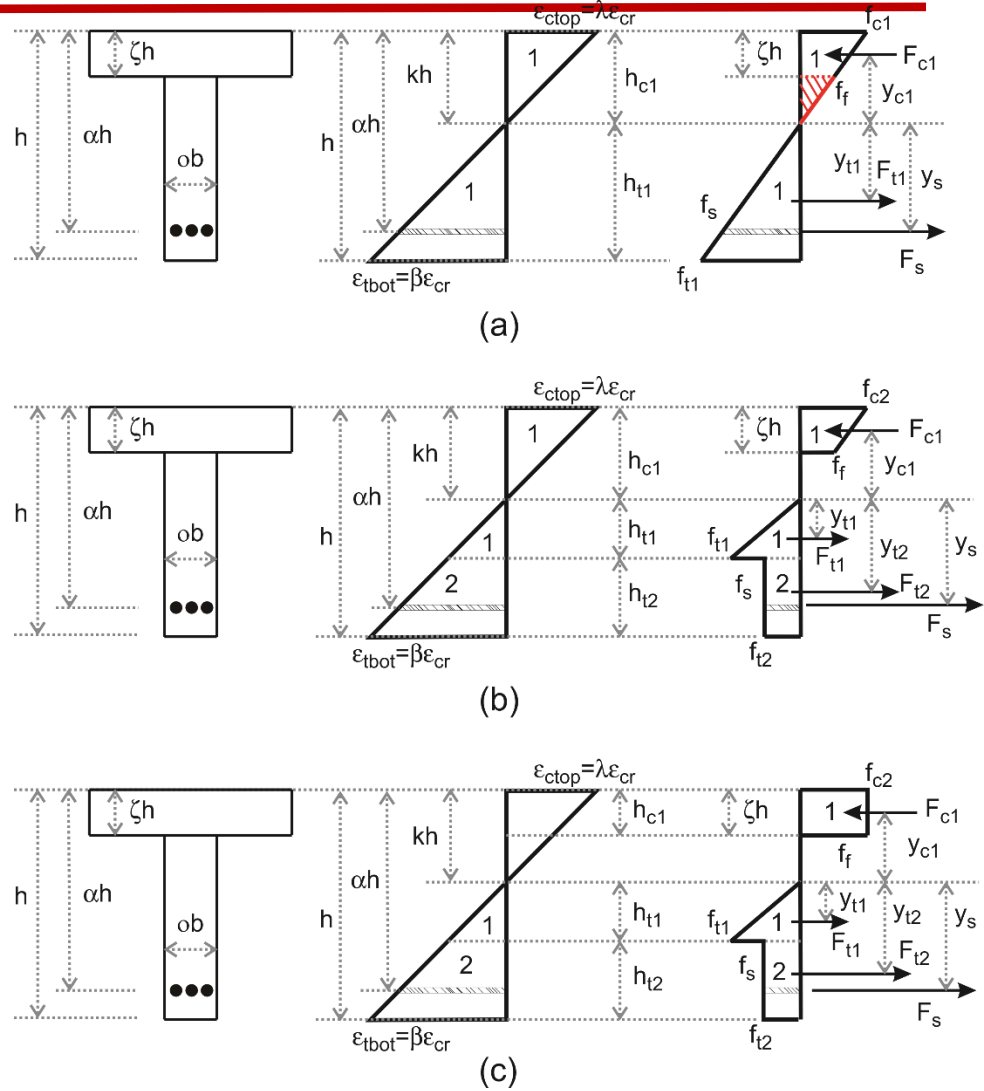
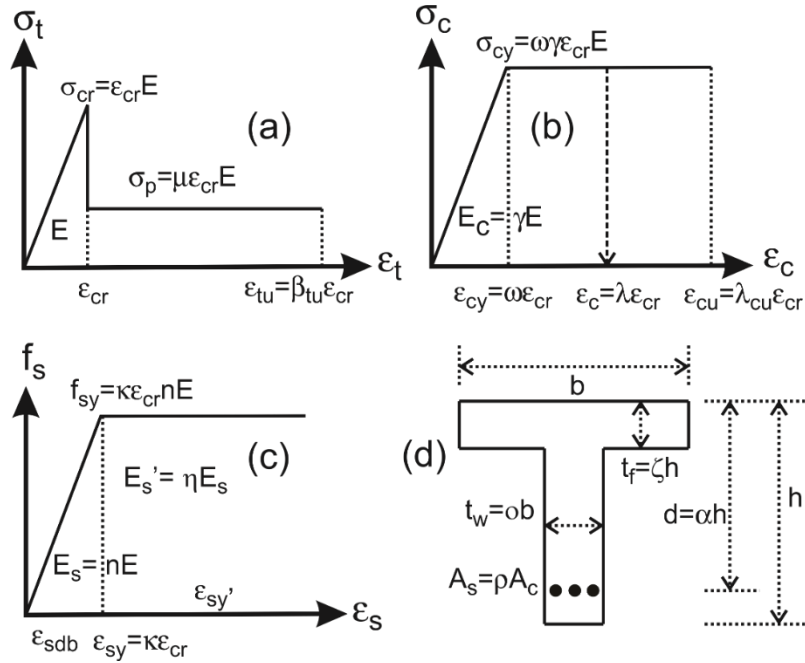



# Model Simulation

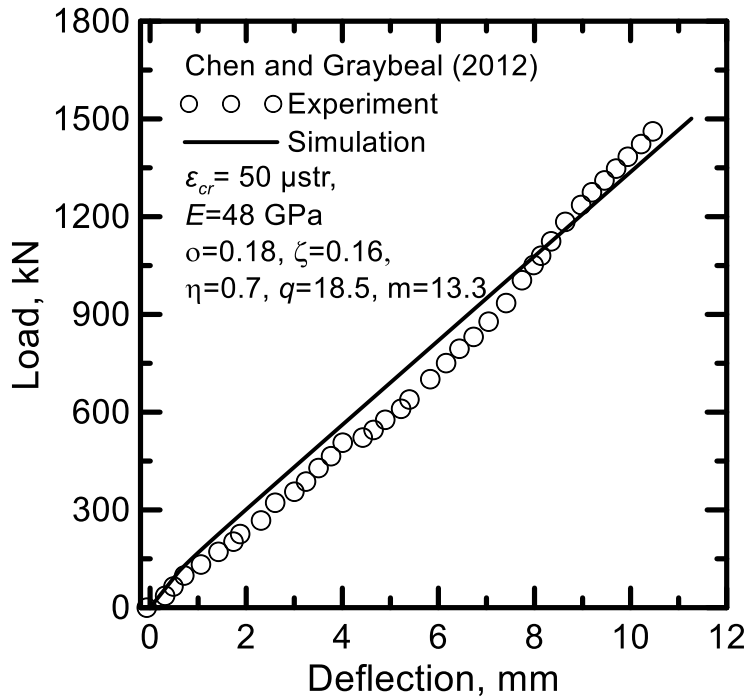
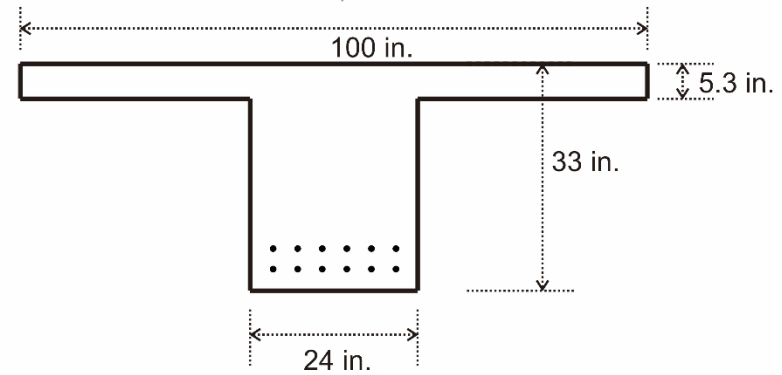
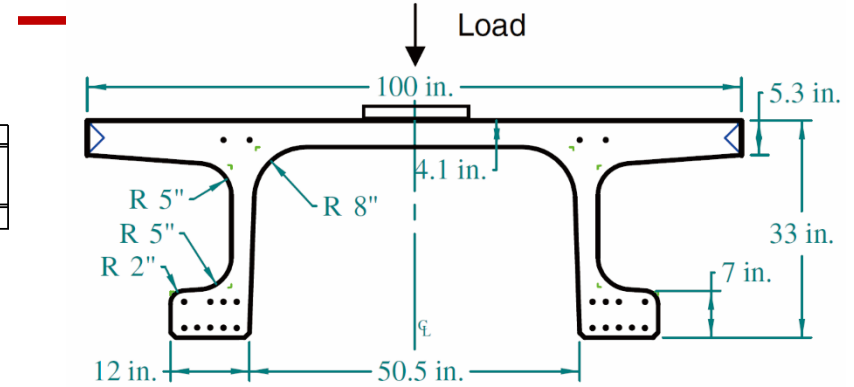
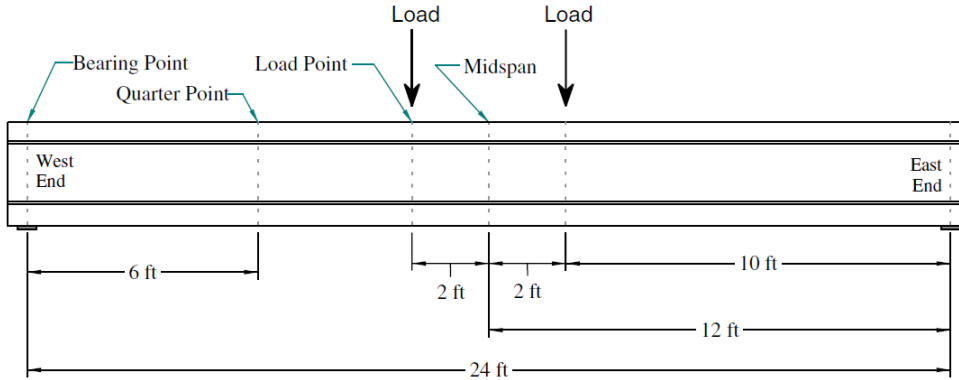

# Conclusions

---

- Reviewed existing procedures on proportioning non-proprietary UHPC mixtures and their costs;
- Develop non-proprietary, sustainable UHPC mixtures incorporating locally available cement replacement and filler materials to
  - Significantly reduce cost compared to the available proprietary systems
  - meet early age and long term performance requirements through a fundamental materials-engineering based approach (rather than the trial-and-error) approach
- Optimize the material design to arrive at mixture proportions for UHPC based on performance criteria for bridge element connections.

# Conclusions

---

- Developed detailed testing on the mechanical (strength, ductility, volume changes and crack resistance) and durability (resistance to chloride ion ingress and freezing and thawing) properties of the developed non-proprietary mixtures in accordance with ADOT approved plan, and develop cost-and-performance matrices
- Provide recommendations to, and assist FHWA and ACI on the development of specifications and Design Guides for use with UHPC mixtures.