

UNDERGROUND NATURAL GAS STORAGE
INTEGRITY & SAFE
OPERATIONS

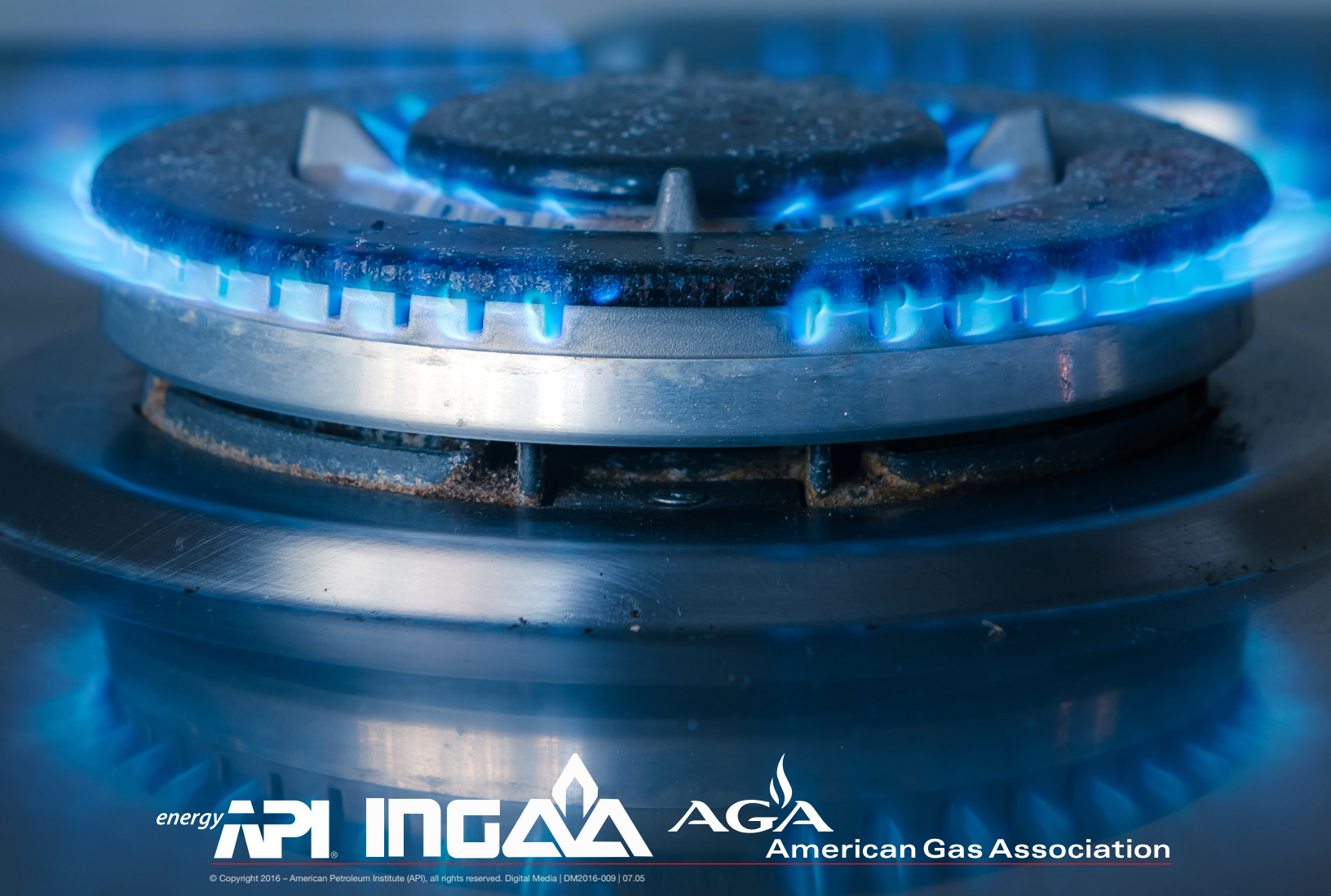

Underground Natural Gas Storage

Integrity and Safe Operations

Prepared by:

The American Petroleum Institute

The American Gas Association

The Interstate Natural Gas Association of America

Find the full report here:

<http://www.energyinfrastructure.org/energy-101/natural-gas-storage>



July 6, 2016

Introduction

The recent natural gas leak from the Aliso Canyon facility in California has prompted federal and state regulators to reexamine the regulation of underground natural gas storage facilities. The intent of this paper is to enhance the technical understanding and to provide context around the implementation of the recently developed American Petroleum Institute (API) recommended practices addressing the safe operations of underground natural gas storage facilities –API Recommended Practice 1170, Design and Operation of Solution-mined Salt Caverns Used for Natural Gas Storage, (API 1170) and API Recommended Practice 1171, Functional Integrity of Natural Gas Storage in Depleted Hydrocarbon Reservoirs and Aquifer Reservoirs, (API 1171). These standards were developed by a group of technical experts from industry and government and were published by API in 2015. They cover the design and operation of salt cavern storage and the design, construction, operation, monitoring and maintenance of depleted hydrocarbon and aquifer reservoirs.

The Aliso Canyon incident also focused the spotlight on the application of Emergency Shutdown Valve (ESV) systems as a tool for consequence mitigation of events that may occur downstream of the valve. This paper includes an appendix that provides a comprehensive review of ESV systems, including their operation, application, benefits, and reliability challenges. This appendix is intended to advance the technical understanding of ESVs and to provide context around ESV implementation.

Underground storage of natural gas is an integral component of the nation’s energy system. Our nation’s significant storage capacity – nearly four trillion cubic feet – enables utilities to offer clean natural gas to consumers throughout the year with reliable service and prices. Natural gas storage enables companies to adjust for daily and seasonal fluctuations in demand throughout the year while natural gas production remains relatively constant year-round. Without storage, customers, including power generators, transportation operators, and residential users, would be faced with potential supply shortages and highly variable prices.

Natural gas storage operators have consistently provided safe and reliable natural gas storage. Because of the critical importance storage plays in the nation’s energy portfolio, natural gas storage operators are continually searching for new equipment, processes, and methodologies to improve safety and reliability.

This paper is the product of a collaborative effort between members of the American Gas Association (AGA), the American Petroleum Institute (API), and the Interstate Natural Gas Association of America (INGAA). Portions of this paper advocate that federal and state regulators take certain regulatory actions and refrain from taking other regulatory actions.

The information included in this paper represents the industry’s best practices and decades of expertise in developing and operating natural gas storage facilities. The goal of this paper is to provide information that is instructive and helpful for regulators responsible for ensuring the continued safe and reliable delivery of natural gas for their constituents.

Executive Summary

Natural gas storage operators have recognized a need to generate a standardized set of recommended practices to provide guidance in the areas of risk and integrity management for natural gas storage wells and reservoirs. A fundamental goal of natural gas storage management is containment of the stored gas within the facility. A team that included federal and state regulators along with natural gas storage operators developed American Petroleum Institute (API) Recommended Practice 1171, Functional Integrity of Natural Gas Storage in Depleted Hydrocarbon Reservoirs and Aquifer Reservoirs (API 1171) to address the need for consistency among the industry. In September 2015, following a three-year development effort, API 1171 was published. API 1171 brings together a variety of leading industry practices for design and operations of natural gas storage facilities with risk management providing the basis. Following the release of API 1171 and PHMSA's reference to the standard in a February 2016 advisory bulletin, operators have been conducting gap analysis to compare the new standard to their own integrity management practices.

The risk-based approach to well integrity management advocated in API 1171 includes five steps: 1) Data Collection, Documentation and Review, 2) Hazard and Threat Identification, 3) Risk Assessment, 4) Risk Treatment – Developing Preventive and Mitigative Measures, and 5) Periodic Review and Reassessment. Lessons learned from historical gas storage events resulting in loss of storage containment had a role in shaping API 1171. A 2013 literature search and informal industry survey of historical natural gas storage incidents in the U.S. showed on average one major storage incident occurring per decade and less severe events occurring intermittently. While this indicates the likelihood of a major incident occurring is very low, the objective of API 1171 is to further drive down any potential risks. Recognizing that well integrity data verification and assessment must be done for every storage well in order to effectively apply the management practices in API 1171, operators are working towards uniform application of the standard.

Storage well integrity management programs are developed with a life cycle approach that includes well design, construction, commissioning, operations, maintenance, and abandonment using effective procedures, training, documentation and records retention and relying on the knowledge, skills, and experience of the personnel and the organization managing the facility. Design factors employ one or more barriers such as casing, the wellhead, and cement, to provide containment of storage gas. Specific designs using equipment, such as emergency shutdown valve systems or tubing and packer well configurations, must be evaluated using the risk management process as these designs add potential risk and no single specific approach provides a panacea to mitigate all potential integrity issues. New and existing designs can both be successfully employed within a risk-based integrity management program. Risk assessments are used as a basis for developing the integrity demonstration, verification, and monitoring tasks and for evaluating their frequency requirements. The operator's approach addresses the need for re-evaluation of risk-based conclusions, and the frequency of monitoring tasks. These monitoring tasks and other operating practices are performed by trained personnel and require documentation and continual improvement processes as part of storage integrity management.

Operators have projected full conformance with API 1171 following a final rulemaking could take 7-10 years, taking into account the gap analysis currently underway to compare the new API 1171 to individual integrity management practices, and the development and implementation of risk assessment techniques applicable to an operator's specific storage fields, integrity management plans, inspection

and maintenance practices, emergency management plans and storage well blowout contingency plans, and procedures for well and reservoir integrity tasks and activities (management of change, training and competency programs).

Overview

The underground storage of natural gas is a critical component of the natural gas supply system in the United States. On the highest demand days, storage delivers about half of the natural gas consumed. As natural gas becomes an increasing part of our national power generation and energy portfolio, these storage assets will continue to play an important role. Approximately 400 gas storage facilities, comprised of almost 17,500 storage wells provide service today. Eighty percent of storage facilities employ geologic formations, or reservoirs, that originally contained natural gas and/or oil reserves and were converted to depleted reservoir storage. The remaining facilities are engineered for gas storage using either deep, water-filled geologic formations, aquifers, or caverns that have been created in salt formations using a solution mining process¹. This paper focuses on natural gas storage well integrity in depleted reservoir and aquifer facilities and provides an in-depth discussion of Emergency Shutdown Valve systems in onshore, natural gas storage wells.

The overall objective of a storage facility integrity program is to help ensure and confirm that storage gas is confined in the system. A storage facility can be divided into four distinctive physical components: the reservoir, the well(s), the storage pipeline system and the compressor station. The latter two are regulated by the U.S. Department of Transportation (DOT) under 49 C.F.R. Part 191 and 192 and are not within the scope of this paper. The first two physical components of a gas storage facility are addressed in American Petroleum Institute (API) Recommended Practice 1171, “Functional Integrity of Natural Gas Storage in Depleted Hydrocarbon Reservoirs and Aquifer Reservoirs” (API 1171). API 1171, which was published in September 2015, represents a three-year effort by a working group including representatives from DOT’s Pipeline & Hazardous Materials Safety Administration (PHMSA), the Federal Energy Regulatory Commission (FERC), state regulators, and industry to develop natural gas storage well and reservoir integrity standards that combine consensus best practices, regulations, and concepts adapted from risk management and safety management systems.

This paper further describes natural gas storage well integrity. Natural gas storage well integrity management programs are developed with a life cycle approach that includes well design, construction, commissioning, operations, maintenance, and abandonment using effective procedures, training, documentation and records retention and relying on the knowledge, skills, and experience of the personnel and the organization managing the facility. Safety and integrity of storage wells are managed using a risk informed approach that includes identifying threats and hazards at each site, analyzing and evaluating the risk, and developing preventive and mitigative programs to manage the risk².

As part of the continual improvement process described in API 1171, this paper describes processes in place or under development by operators. API 1171 was finalized in September of 2015 and the industry is in a foundational state developing conformance with API 1171. Operators are at various stages in their efforts to enhance their existing integrity management processes to achieve conformance with the

¹ Additional background information on natural gas storage in the United States is provided in Appendix 1 via a brochure, “Supporting the American Way of Life- The Importance of Natural Gas Storage”, developed as a joint effort of the American Petroleum Institute (API), the Interstate Natural Gas Association of America (INGAA), and the American Gas Association (AGA).

² Section 8 of RP1171 describes the risk management approach for storage wells and reservoirs.

robust consensus standards established in API 1171. These efforts begin with a gap analysis to compare the new API 1171 to the operator's individual integrity management practices, and then move to the development and implementation of risk assessment techniques applicable to an operator's storage fields, integrity management plans, inspection and maintenance practices, emergency management plans and specific storage well blowout contingency plans, and procedures for well and reservoir integrity tasks and activities (management of change, training and competency programs). Operators as referenced in this paper are seeking to conform to API 1171 and have estimated that conformance can be achieved within seven to ten years of a final rulemaking.

The following discussion is organized into four sections beginning with a description of the storage well integrity management process and its strong relationship to risk management process. Lessons learned from historical storage well gas release events are reviewed in the second section. An examination of storage well integrity design factors is contained within the third section. The final section reviews operational approaches to managing storage well integrity.

1. Natural Gas Storage Well Integrity Management Process & Risk-Based Approach (API 1171 Section 8)

The natural gas storage well integrity management process starts with a comprehensive risk assessment. The assessment includes data collection, hazard and threat identification, likelihood of occurrence estimation, and consequence severity determination. Preventive, mitigative and monitoring practices are developed that can reduce the potential for an integrity compromising event. Periodic review and reevaluation of the risk assessment and the effectiveness of the safety management program complete the process³.

The risk management program discussed below and incorporated in API 1171 has three fundamental components - physical plant design, processes and human factors. The physical plant includes design features with the ability to contain pressurized storage gas. The process component includes the technical and procedural systems that promote the identification and mitigation of threats while also identifying and managing the consequences in the design, construction, commissioning, operations and abandonment phases of a storage well life cycle. The processes also include audit procedures, emergency response plans and a continual improvement cycle. Neither the physical plant nor the processes would be totally effective without effective management of human factors. Operators develop staff knowledge, skills and abilities to safely and efficiently manage their responsibilities for storage well integrity. A management team that fosters a robust health and safety culture is important to the success of human factor management. Ineffectiveness or failure in any one of these three components can lead to loss and/or escalation of a minor event into a potentially major incident.

The operator's risk assessment must take a holistic approach to storage well and field integrity to effectively manage risk. It should be noted that while this paper is focused on addressing the integrity of storage wells, some of the threats and preventive and mitigative measures pertain to both the storage wells and the storage reservoir. An example would be third party damage, such as vehicular

³ Appendix 2 is a flow chart from RP1171 presenting the various steps for well and reservoir integrity management.

impact to a wellhead (well risk) or a third party oil and gas producer drilling through the storage reservoir to a deeper formation (reservoir risk).

Step 1- Data Collection, Documentation and Review (API 1171 Section 8.3)

Good practices in well integrity management involve the collection and maintenance of information for each storage well for the life of the facility. Importance is placed on understanding how the well was originally drilled, configured, and completed; the purpose of subsequent reconditioning work and other maintenance activities; the characteristics of the geologic environment encountered by the well; reservoir and injected fluid properties; well performance capability; and wellsite information. Operators integrate these data to develop a holistic understanding of the threats and hazards presented to each storage well and to the entire storage facility.

Types of data collected include geologic information on the formations penetrated by the storage well, wellbore configuration and completion data (e.g. casing characteristics, setting depths, cement, etc.), pressure and volume data on the flow capability of the well, annular pressure and/or volume data, reservoir fluid analysis, wellhead design, and other characteristics of the subsurface in addition to information about the wellsite. Sources of data include storage operator records, third party records, and information filed with the state geologic survey and/or oil and gas regulatory agencies.

Step 2- Hazard and Threat Identification (API 1171 Section 8.4)

A hazard is a potential situation or condition that could cause the loss of or damage to a natural gas storage well. A threat can be caused by activation of a hazard. Note that due to the variety of well designs and the diverse geologic and geographic settings of wells, hazards and threats vary from one storage well to another as well as from one facility to another.

Appendix 3 includes a detailed listing of common threats and hazards to storage wells. This list was developed for API 1171 and included input from operators representing the majority of storage wells in the United States with hundreds of thousands of well-years of operational experience. API 1171 encourages operators to utilize the list and supplement it as necessary based on well-by-well, site specific assessments. Operators are also encouraged to consider the potential for interactions between specific threats and/or hazards. A lack of data is not used as justification to exclude a specific threat.

An individual storage well has one or more design features to contain the storage gas inside the wellbore and in the storage reservoir. Physical components of a well that act as barriers to the gas and protect against potential loss of containment events are the casing in the well and cement behind that pipe. Potential consequences from the failure of containment include storage gas escaping to freshwater formations or to the surface at or near the wellhead. In addition to those downhole features, the wellhead is designed to control the flow of gas from the wellbore to the pipeline system. The wellhead design can also provide access to the annulus to identify potential loss of containment from the production casing. Redundant or multiple barriers can promote higher reliability as a second barrier, such as cement behind the production casing can contain the gas if the first barrier fails. Storage operators can monitor parameters such as operating pressure, temperature and flow conditions to confirm normal operating conditions and limits and to detect abnormal conditions. Assessing the risk presented by an individual well, therefore, incorporates both the type and the quality of design features

that exist, in addition to the operator's procedures and personnel training. Some causes of the loss of containment of storage gas, based on operational experience, are discussed later in this paper.

Operators will periodically review the threats and hazards for each well to account for changes in perception of likelihood or consequence of event occurring. This review also provides the most up to date information for the risk assessment. As an example, operators will review events in the storage industry and evaluate the risk of a similar event occurring with their storage wells.

Step 3- Risk Assessment (API 1171 Section 8.5)

The operator's risk assessment uses tools and techniques that evaluate and prioritize risks so as to direct risk management activities toward promoting the functional integrity of the storage wells.

The risk assessment method includes:

1. Identification of potential threats and hazards to a given storage well,
2. Evaluation of the likelihood of events and consequences,
3. Risk ranking to develop preventive and mitigative (P&M) measures to monitor and/or reduce risk,
4. Documentation of risk evaluation and decision basis for P&M measures,
5. Provision for data feedback and validation, and,
6. A continual improvement cycle by way of periodic risk assessment reviews with updated information so as to evaluate the risk management effectiveness, and to modify/update the potential threats and hazards and P&M measures needed to address these threats and hazards.

Step 4- Risk Treatment- Developing Preventive and Mitigative Measures (API 1171 Section 8.6)

Risks to a specific storage well can be effectively managed with P&M measures which reduce the likelihood (preventive), reduce the consequence (mitigative), or by a combination of both. Appendix 4 contains a table adapted from API 1171 listing the common P&M measures for different threats or hazards. This list was collaboratively developed by operators owning the majority of storage wells in the United States and represents hundreds of thousands of well-years of experience in managing well integrity risks. The list also incorporates efforts by operators to develop new technology and represents the currently available tools, techniques and practices for storage well integrity management. Operators will continue to support new technological developments pertaining to well and reservoir integrity.

Operators are using the P&M measures identified in API 1171 to determine the applicability of each P&M measure to their wells and are supplementing the list as necessary for site specific conditions. Operators will then employ applicable API 1171 P&M measures and train their personnel on the procedures related to those measures.

Step 5- Periodic Review and Reassessment (API 1171 Section 8.7)

Storage wells can be in operation for many years and while the passage of time itself does not pose an additional threat if facility integrity is managed, the threats to each storage well can and likely will change over time. Examples include surface encroachments on well sites due to farm land being converted into housing developments or the discovery of new productive oil and gas formations below

the storage reservoir leading to third party drill activity through or in proximity of the storage formation. Therefore, operators periodically review the integrity management programs and risk assessments to update identified potential threats and to evaluate utilization of P&M measures to address the risk. The review interval is short enough so that the data and information brought into the analysis are meaningful. Operators conduct their risk management as an ongoing activity.

Operators also maintain a continual improvement cycle for risk management activities that incorporates new procedures, practices and technology when relevant to a specific storage facility. Experience has shown that significant technological advancements can occur over the long life of a storage well. Operators stay abreast of these developments and incorporate new technology and best practices as appropriate.

2. Lessons Learned from Historical Underground Natural Gas Reservoir Storage Well Events (API 1171 Sections 8.4 and 8.7)

Unplanned releases of natural gas from underground storage wells, while rare, have occurred. A literature search of historical release events was conducted in 2013 to better inform the API 1171 development team. The information compiled came from publically available sources and an informal survey of underground storage operators. The informal industry survey covered nearly 14,000 wells contained in 226 fields, and represents a sampling of over 80 percent of the natural gas storage wells in the United States. The publically available information came from newspapers, Geologic Survey reports, state oil and gas inspector notes and other available public information. These statistics exclude the Aliso Canyon incident, which commenced October 2015, after API 1171 was published.

A process safety tier ranking system referenced from API RP754, “Process Safety Indicators for the Refining and Petrochemical Industries” second edition, April 2016, (RP754), can be used to categorize the incidents from the informal industry survey and publicly available information review referenced above. Although RP754 is written for the refining and petrochemical industries, the application of the tier structure has merit since the storage incidents referenced herein represent loss of product containment. Tiers 1 and 2 are lagging indicators and are suitable for nationwide public reporting. Tiers 3 (challenges to safety systems) and 4 (operating discipline and management system performance) are leading indicators used by companies for their internal review and improvement.

As defined in RP754, Tier 1 Process Safety Events are more significant incidents that result in the unplanned loss of containment and one or more of the following consequences:

- An employee, contractor, or subcontractor “days away from work” injury and/or fatality;
- A hospital admission and/or fatality of a third-party;
- An officially declared community evacuation or community shelter-in-place including precautionary community evacuation or community shelter-in-place;
- Fire or explosion damage resulting in greater than or equal to \$100,000⁴ of direct cost.

Tier 2 Process Safety Events are unplanned loss of containment events with a lesser consequence than Tier 1 that result in one or more of the following consequences:

⁴ This reporting threshold is referenced from API754, Part 191’s incident reporting (191.3) threshold is \$50,000 in damage, which is a subset of direct cost. The authors are not suggesting modification to the reporting definitions in 191.3.

- An employee, contractor or subcontractor recordable injury;
- Fire or explosion damage resulting in greater than or equal to \$2,500 of direct cost.

The data search for unplanned storage well releases identified 61 events between 1953 and 2010. A breakdown of the incidents by decade along with an application of the RP754 Tier 1 and 2 structure (the severity of the incident) is shown in Table 1.

Decade	Number of Incidents	Injuries	Fatalities	Tier 1 Incident	Tier 2 Incident
1950-1959	2	0	0	0	1
1960-1969	10	7	4	1	4
1970-1979	15	3	0	2	9
1980-1989	7	0	0	0	3
1990-1999	18	5	0	1	8
2000-2010	9	0	0	0	5

Table 1 – Storage Well Incidents by Decade

It is worth noting that the largest number of injuries and fatalities is attributed to a single incident in 1969. The two Tier 1 incidents in the 1970’s were related to two separate well fire incidents resulting in burns to workers. After the 1970s, there was one Tier 1 incident in 1997 that was due to the overpressure of a brass valve which blew apart and injured two workers.

Based on the event data reported since 1990, and taking into account the Aliso Canyon incident, the likelihood of an event occurrence, calculated using the Center for Chemical Process Safety⁵ (CCPS) American calculation for hazardous process facilities, results in a “very unlikely” to “extremely unlikely” or “remote” classification. Implementation of API 1171 is expected to reduce this likelihood further.

Table 2 furthers the analysis by organizing the events according to the threat categories as shown.

Threat	Occurrences
Well Interventions	20
Wellbore Leak	22
Third Party/Outside Forces	6
Design	7
Wellhead/Gathering	5
Unknown	1

Table 2 – Storage Well Threats and Occurrences

This analysis shows about 30 percent of the events occurred as a result of well interventions (i.e., activities associated with the operator entering the well for some type of remedial, valve maintenance, or other work) and another 30 percent were caused by issues with the downhole tubulars. Of the

⁵ (CCPS) American Institute of Chemical Engineers (AIChE); CCPS order of magnitude event frequencies align to qualitative descriptors: “extremely unlikely to remote” is <1E-05, “very unlikely” is in a range of 1E-05 to 0.99E-03

reported wellbore leaks due to issues with downhole tubulars, 12 were of undocumented origin, four were due to casing corrosion, four due to mechanical issues, and two were the result of manufacturing defects.

Fifty-one of the reported events included an estimate of the length of time for the event to be resolved. Eleven incidents took longer than a month to contain and seventeen were resolved in less than 30 days. Twenty-three events were contained within two days with most of these contained in less than 24 hours.

Of the 61 events identified in this review, one, in 1969, resulted in seven injuries and four fatalities to the public. In 21 events, the general public was impacted through road closures, water supply replacements, building damage and evacuation of homes.

It is recognized that the frequency of Tier 1 and 2 incidents has remained flat over time. Operators continually learn from historical events which, among other things, prompted the development and use of improved casing inspection tools.

Operators currently employ a variety of methodologies to ensure the functional integrity of the storage wells they operate. The storage facilities are designed to operate within maximum operating pressure limits of the reservoir and all connecting elements from the well, wellhead assembly, and the connected pipeline system and any ancillary equipment. The development of API 1171 represents a significant effort to improve upon the process safety record through the use of a standardized risk-based approach to natural gas storage integrity.

3. Storage Well Design Factors (API 1171 Sections 6.2)

A. Wellhead Equipment (API 1171 Sections 6.2.1, 6.2.2, 6.2.3)

All wells include a system of surface-mounted valves to control flow, commonly referred to as the wellhead. Wellhead configurations have proven to be effective barriers to control flow of stored natural gas. The underground storage of natural gas began in the United States one hundred years ago. Originally, many surface-mounted valve assemblies were referred to as production style and were often fabricated in the field by welding pipeline components and valves to the well itself. Over time operators have replaced the design of the original well control configurations with more standard and conformance tested equipment. Today, the wellhead equipment used for new underground natural gas storage wells consists of equipment that conforms to API Specification 6A standards. The wellhead equipment is composed of a number of valves and components that isolate the well casings within the wellhead assembly and provide control of the well at the surface. This control allows the well to be open to or shut from the pipeline system and provides for the connection of equipment for any potential future remedial well operations. Ports on the wellhead assembly allow for the measuring and monitoring of pressures and flows from the different casings, including the flow string itself and annular space between the casings. These API 6A standard wellheads contain a master valve that allows for full diameter access to the production casing for future inspections of the well casings.

Other factors included in the specifications of the wellhead and related equipment include the expected flow rates and flow paths, potential future increases in operating pressures, any anticipated treating or

stimulation pressures, chemical composition of fluids injected and withdrawn (including those used for treating or stimulation) and servicing and maintenance needs for the wellhead as identified by the original equipment manufacturer. In designing the well, wellhead, and related equipment, operators also evaluate the future inspection, servicing, and maintenance needs for the well. Included in this evaluation are valve type and sizing factors to allow for mechanical inspection of the wellbores.

Another aspect of well design is an evaluation of the corrosive potential of any formation fluids that may enter the well or annular space of the well along with decisions made whether or not to induce current on the well casing as part of a cathodic protection system. In addition, the assessment of erosive impact of formation particulates or stimulation treatment materials is included with the well component design.

B. Well Configurations (API 1171 Section 6.3)

As with storage wellhead assemblies, storage wells have existed for many decades in various configurations. The storage well provides isolation from groundwater, controls wellbore conditions, isolates the storage gas within the storage reservoir and allows for injection into the reservoir or withdrawal from the reservoir.

Operators refer to API TR 5C3, which provides technical details regarding the strength of casing and tubing, to design casing configurations for their wells. Typically the oil and gas regulations within a given state prescribe the minimum requirements for well completions. The API published burst values in the 5C3 bulletin include a built-in 12.5 percent safety factor to allow for the manufacturing tolerance of the pipe wall. These published burst values are used by operators to confirm that their well completions can withstand the maximum anticipated operating pressures and temperatures of their wells. In many cases, storage operators construct storage wells with casings rated for significantly greater pressure containment than the pressures expected for normal operations of the storage well. Operators utilize commonly available casings, which may have higher pressure ratings than minimally required, simply because of their availability. Some operators may stimulate wells at higher pressure in the future and factor this plan into the original casing design. Operators will verify casing capability to withstand stimulation pressures prior to stimulation. In any case, operators verify that the ratings of the casings installed in the well exceed the anticipated pressure containment needs.

Storage wells extend from a few hundred feet to several thousands of feet beneath the surface. The wells connect the underground reservoir rock, where gas is stored in the porous and permeable rock formations, to the surface wellhead assembly, the system of valves and components that connect the well to the pipeline system.

Storage wells are constructed in a concentric manner with larger diameter casing installed nearest the surface and smaller diameter pipe extending from inside to deeper underground formations. The casing is composed of sections of pipe known as joints that are about 30 - 40 feet long and form the casing string that connects the reservoir to the wellhead. The joints are typically screwed together with engineered connection collars that include thread compound to assist in providing a seal for each joint, ultimately forming a continuous barrier along the entire casing string. This casing string confines the stored natural gas inside the pipe and also acts to prevent any external substances from entering the well.

As specified in API 1171, a new storage well contains at minimum two casings; the surface casing and the production casing. Cementing these casing strings, in part or wholly to the surface, provides an additional zonal isolation barrier by sealing the void space between casing strings and/or between casing and the rock formations. This system provides isolation of the stored natural gas from the surrounding rock formations, allowing the production casing to contain the flow of gas in and out of the storage reservoir. The casing and cement well barrier elements [barriers] provide the foundation for managing well integrity.

The following describes an example storage well configuration:

- Conductor casing: the conductor casing is the widest diameter pipe used in the well and is of sufficient size and strength to control the near-surface movement of earth and provide stability for future drilling operations. This pipe can be cemented in place by grouting to the surface and is not connected to the wellhead.
- Surface casing: the surface casing's main purpose is to isolate the well from sources of fresh water and to provide additional stability for deeper drilling of the well. This pipe is typically screwed together and usually cemented in place from the bottom to the surface by displacement.
- Intermediate casing: in some cases, a well may contain an intermediate casing string to isolate the well from coal, salt, other mineral deposits, and/or gas bearing zones, to control subsurface conditions and to provide additional stability for deeper drilling of the well. This pipe is typically screwed together and often cemented in place from the bottom to the surface by displacement.
- Production casing: Inside these other casings is the production string which provides access to the storage reservoir formation itself. This string provides isolation of the natural gas that is being stored. Typically, production casing is screwed together and cemented in place from the formation, either to the surface, to a level above the storage formation deemed adequate for containment, or to the casing set point of an intermediate or surface string by displacement. The casing is thus sealed in place and prevents any flow of gas or other fluids in the annular space between the pipe and the surrounding rock formation.
- Production tubing: In some cases, a smaller diameter string of pipe known as tubing, which like the casing is normally threaded pipe joined by engineered connections, is installed inside the production casing. Gas can be injected or withdrawn through the tubing, the tubing/production casing annulus or both depending on the well configuration. If tubing is used, the velocity of flow is greater due to the reduced cross sectional area of the tubing as compared to the casing, and liquids can be lifted from the bottom of the well to the surface. In this case, tubing is not cemented in place, but hangs from the surface wellhead assembly or is set on a packer which has anchoring slips and a rubber packing element that seals the space between the tubing and production casing. Tubing set on a packer seals the storage formation pressure and fluids from the production casing. The annular space between the tubing and production casing can be filled with fluid and inhibitors to protect against corrosion. If an operator drills and completes a new well with a tubing on packer completion, and the well requires high deliverability to meet design flows, the casing design results in larger diameter

pipe than would be the case for a well with similar deliverability completed without tubing. However, retro-fitting wells with tubing on packer completions results in a detrimental effect on service reliability, on peak deliverability and potentially to seasonal working gas capacity, as the cross-sectional area available for flow is reduced. An operator could drill substantially more wells to make up for the loss in order to maintain deliverability and turnover requirements. Since additional wells would be required, the overall risk impact with the storage field could be increased. An operator's site-specific risk assessment provides guidance for a decision on casing/tubing requirements for the design of new wells and the applicability for existing well completions.

C. Zonal Isolation (API 1171 Section 6.2, 6.3, 6.4)

The storage well casing, cement and wellhead assembly provide the zonal isolation, or barrier envelope, for a well. These barriers are designed to withstand the maximum operating pressures, including stimulation or treatment pressures, temperatures, flow rates, flow compositions and provide the necessary isolation of the stored natural gas from the well's surrounding environment. The well casing and wellhead assembly are confirmed to have mechanical integrity through testing and maintenance. In addition to API 1171, ISO Technical Specification document 16530-2 "Part 2: Well Integrity for the Operational Phase" includes a section defining well barriers in more detail. See Appendix 5 for examples of gas storage well configurations. Example A depicts a well showing a wellhead assembly on the surface connected to the storage zone through the production casing inside surface and conductor casings with cement sealing the annular spaces between formation and pipe and between the different casings. Example B depicts a well showing a wellhead assembly on the surface connected to the storage zone through both production casing and tubing inside surface and conductor casing. Cement is shown in Example A between the production casing and formation and between the casings. The tubing is not cemented in place and may or may not contain a packer element at the bottom to seal the annular space between tubing and casing. Without a packer, flow could occur through the tubing and/or the tubing/casing annulus; however, with a packer flow could only occur through the tubing.

On the surface, the wellhead assembly contains a master valve that provides isolation of the well from the atmosphere and the pipeline connection. The operator in some cases may decide to install tubing in a well that can either be used as a velocity string to help remove fluids or set on a packer to provide a seal for the annular space between the tubing and production casing. Additional barriers are the seals within the wellhead itself and other valves on the wellhead assembly.

The operator evaluates the entirety of the barrier envelope when making decisions regarding the inclusion of an emergency shutdown valve (ESV). A variety of criteria, as more fully described in Appendix 6, are evaluated in determining the need for an ESV in any particular well. These factors include, but are not limited to, the flow potential and flow composition and the proximity relationship to dwellings or human congregation areas, the accessibility of the well for emergency response including the proximity of the well to other wells or structures, the proximity to vehicular, air or rail traffic and industrial sites, the added protection of other barrier options, and the risks of installing and servicing the ESV itself.

Each of the above barriers is a component of protection to maintain the isolation of the stored gas in the well and to prevent any contamination from entering the well itself from the surrounding rock formations. Storage operators design the well completions to provide zonal isolation that meets or exceeds regulatory requirements of individual state oil and gas agencies.

D. Cementing Practices (API 1171 Section 6.4)

In addition to the casing in the well, the purpose of cementing is to provide a seal, or zonal isolation, primarily by preventing movement of gas or other fluids vertically behind the casing, which is an important part in maintaining well integrity. Over time, installing a seal around casing has evolved from some instances where operators placed a gelled fluid or drilling mud into the annular space between casings or casing and the rock formation to a more refined and specific process. Today, cementing is the process of mixing a slurry of cement, water and cement additives and placing it in the well by pumping it through the casing to fill the annular space between the casing and formation or previous string of casing. Once the cement has cured to sufficient compressive strength, the cement provides support to the casing, and bonds the casing to the formation for zonal isolation. Cement provides an additional barrier element and can also protect the casing from external corrosion. Cement used in well construction meets or exceeds the requirements of API Specification 10A or ASTM C 150/C 150M Standard Specification. These specifications list chemical and physical properties for different classes of cements.

E. Cement Design (API 1171 Section 6.4.4)

Placement of cement so that it completely surrounds the casing and removes all drilling mud from the annulus is important to a successful cement job. Operators face numerous challenges with cementing casing that affect the placement of cement behind the casing. Drilling fluid and borehole quality can affect both the running of casing and the displacement of the drilling fluid during cementing operations. The stability of the borehole could be compromised due to sensitivity with the cementing materials and related fluids chemistry which may lead to caving and the inability to circulate and effectively place the cement. All of these challenges are factored into the risk assessment for the well and incorporated into the cement design.

Operators use casing hardware to assist in centralizing the casing and placing uncontaminated cement around the casing. A casing shoe, which helps guide the casing through the wellbore to bottom and protects the bottom of the casing from damage, is run on the bottom of the casing. Centralizers are used in an effort to offset the casing from the borehole wall, since it is difficult to remove drilling fluid and place cement in areas where the casing is too close to the borehole wall. Float equipment is used to restrict back flow into the casing after cementing and prevent cement contamination near the shoe of the casing. Wiper plugs provide separation between the cement slurry and drilling fluids, wipe the inside of the casing of drilling fluids and cement and provide an indication of the end of displacement of the cement slurry.

Slurry design takes into account the amount of cement needed for zonal isolation and the cement top location. Pore pressures and fracture gradients are also evaluated in the slurry design. Inadequate formation competence could lead to an inability to support hydrostatic pressures of columns of cement

slurries, leading to formation breakdown, loss of cement column and the inability to place the cement as desired. Cementing back to the surface from total depth can provide additional barriers, annular isolation and additional burst protection over and above burst strength of the casing. In deeper wells, high downhole pressures due to the hydrostatic weight of the cement slurries, combined with additional friction pressures of the viscous slurries, can lead to lost circulation or inadequate annular fill. Operators can use mixed density cements, pumping a lighter weight lead cement that reduces the hydrostatic weight of the full cement column in the well, to mitigate potential lost circulation or inadequate fill. Operators may also use stage tools in the cementing design that allow sections of the well to be cemented at separate times or in stages to reduce the hydraulic head. The operator's risk assessment for the well helps them determine the best method to use in the cement design for a specific well.

Pre-flushes, high annular velocities, high slurry densities and pipe movement are other techniques that operators apply to aid in effectively removing the drilling fluid from the hole during cementing. Pre-flushes help to avoid incompatible fluid interactions with drilling mud and cement. High annular velocities with high slurry densities provide more energy to remove gelled drilling fluids and pipe movement aids in coating the cement slurry on all sides of the pipe. API 65-2 "Isolating Potential Flow Zones During Well Construction," Section 5, "Cementing Practices and Factors Affecting Cementing Success", discusses in more detail many of the areas that operators address for placement of the cement. Competent cement is an important component of the barriers that can contain storage gas if the production casing develops an integrity issue.

When zonal isolation is not achieved or the casing is compromised during the cementing process, operators utilize remedial techniques to repair the wells and provide isolation. For wells with cement to the surface, remedial techniques may include internal patches to repair casing defects or squeeze cementing to improve zonal isolation. Operators evaluate the remediation required along with any associated risks in determining the correct actions to take to repair a well. Those risks can include reduced internal diameter of the casing below the point of remediation and creation of new potential leak paths.

F. Cement Evaluation (API 1171 Section 6.4.6)

Operators use cement evaluation techniques to determine the placement and quality of the cement in a well. For a new or reconditioned storage well, API 1171 requires operators to use a cement bond log (CBL) or other means to determine the placement and bond, or sealing quality, of the cement. API TR 10TR1 reviews various types of cement evaluation logs that operators use, including the CBL, and their features and limitations. New well construction designs should include running the CBL log during the completion process while the wellbore is still full of drilling or circulating fluid. Existing wells can also be evaluated with CBL tools. The historic sonic-based CBL technology requires a liquid-filled wellbore to enable the tool to perform properly. Filling the wellbore with fluid includes added risks, from the introduction of fluid to the well, removing the fluid from the wellbore and possible corrosion from residual fluid left in the wellbore. Operators evaluate risks prior to any well intervention and incorporate these prior to running the CBL. New CBL technology, currently in the field testing mode, does not require a fluid-filled wellbore and, once validation is confirmed, may be a promising alternative for certain aspects of casing-to-cement evaluation. This new tool does not currently evaluate the cement-to-formation bonding, which the older CBL technology may provide.

G. Well Closure (Abandonment) (API 1171 Section 6.7)

A storage operator may choose to permanently close a storage well. This closure is referred to as plugging and abandoning the well. Once this decision is made, the operator designs a well closure plan to isolate the well from the storage zone and any other strata that the well penetrates. This closure of the well removes the well as a conduit for the flow of fluid between different zones penetrated by the well or from one of these zones through the well to the surface. State oil and gas regulations often specify the requirements for well closure operations.

Cement plugs, mechanical plugs or a combination of both are used to isolate the storage zone. Cement plugs are designed to be of sufficient length to provide a seal, which provides this isolation. In some areas, local regulations may require minimum plug lengths for well closure. Regulations may also require a plug across groundwater zones near the surface. Some operators close the well by filling the production casing with cement to surface. In the well closure design, operators must also account for any formations behind un-cemented casing in the well and for any equipment or hardware in the wellbore that may limit the operator's ability to properly place the cement plug. Prior to beginning well closure operations, operators kill the well and make sure that it is in a static condition. After completing the placement of plugs and allowing the cement to cure, operators verify the location and the seal of cement plugs in the well and then the well is capped and left with an identification monument, as required by regulations. After abandonment, some states require periodic review of the plugged well sites to confirm that a permanent seal is maintained.

4. Storage Well Operations

A. Well Integrity Evaluation (API 1171 Section 9)

Gas storage operators evaluate each individual well used for gas storage to determine its integrity and to ensure safe and environmentally responsible operations. Also included in the evaluation are third party wells that penetrate the storage reservoir and buffer zone or areas influenced by storage operations. As gas storage operators are not in control of third party wells, operators will have less information with which to assess the risks of such wells to storage operations.

Risk assessments are used as a basis for developing the integrity demonstration, verification, and monitoring tasks and for evaluating their frequency requirements. The operator's approach addresses the need for re-evaluation of risk-based conclusions, and the frequency of monitoring tasks.

Aspects of well integrity evaluation include the review of well design basis, drilling, completion and well workover records, wellhead inspections, casing inspections and other well logging, well pressure monitoring, and gas/fluid sampling. The outcome of these evaluations is a list of operating parameters for which operators specify bounds. Operators are putting in place monitoring systems to track the changes to these parameters with the goal of ensuring a well is always operated within its limits. Examples of parameters for which specific limits can be set include: wellhead injection and withdrawal pressures, tubing-casing annulus pressure if tubing is set on a packer, acceptable gas and fluid compositions, flow rate erosional velocity limits, operating temperatures, tubing and casing wall

thicknesses, subsidence rates in the area of the storage reservoir, operating limits to prevent hydrate formation, and maximum gas inventory.

Well operating limits will be re-evaluated upon changes to well configuration and/or condition. If a well experiences conditions outside of these limits, operators investigate the cause, document the circumstances, and determine what actions are needed to continue to operate the well.

B. Well Integrity Demonstration, Verification & Monitoring (API 1171 Section 9.3)

Operators are guided in the development of measures needed to demonstrate, verify and monitor integrity of storage wells by risk assessment. Risk assessment is not a one-time event, but rather an on-going process. Some of the factors used when verifying and demonstrating well integrity include well service life history, well design, well construction, maximum and minimum operating pressures (for injection, withdrawal and well treating), the nature of the product stored, the nature of the fluids produced, down hole and atmospheric corrosion, casing and tubing condition, the condition, depth and height of wellbore cement, the need for and types of emergency shutdown valves (surface or subsurface), how each well is operated, and the time interval since the most recent assessment and past assessment findings. Because storage wells are not all the same, risk profiles will vary and the resulting measures may also vary from well to well. There are, however, basic elements of well integrity that are evaluated and monitored at some frequency, as determined by the well's risk profile.

Visits by operating personnel to storage well sites provide opportunities for data collection as well as observations of overall conditions at the well sites. Such information is an important part of the data set needed for the Step 1 of a risk assessment. Risk assessment determines the frequency of well site visits. The general condition of the site, including the access road, fencing (if present), signage and other above-ground appurtenances is assessed by visual inspection. Encroachment activities that could impact the integrity of the well or well site are also noted and reported immediately. Operators also inspect well site valves and fittings for visual and/or auditory leaks. The inspection includes monitoring of casing pressure changes at the wellhead. If operators choose to employ leak detection technology, selection and usage decisions include factors such as detection limits for natural gas or any liquids, response time, reproducibility, accuracy, distance from source, background lighting conditions, geography and meteorology. Leak detection technology continues to evolve and operators deploy such technology when it is appropriate to do so as part of the risk-based continual improvement process.

Operators function-test the wellhead master valve and wellhead pipeline isolation valve(s) at least annually, or more frequently as determined by the risk assessment. Testing provides assurance that the valves will function as required to shut in and isolate the well for operational or emergency purposes. These valves are maintained to the same standard as other isolation valves. When testing reveals deficiencies and a valve does not meet functional requirements, the valve is repaired or replaced promptly so the well's ability to control and isolate fluid flow is not compromised.

When risk assessment indicates that emergency shutdown valves are needed, function-testing of these valves is performed at least annually or more frequently as determined by the risk assessment. The tests are conducted according to the manufacturer's recommendations and the operator's procedures. If an emergency shutdown valve on a storage well closes, it is not reopened remotely, but instead the operator reopens it manually at the well site after investigation into the cause of the closure.

Gas present in the annulus of wells can be, but is not always, an indication of loss of integrity. Storage operators collect and evaluate annular pressures and/or gas flow in cases where the outer annulus is left open. Annular pressure thresholds are determined (where not defined by regulation) from well integrity evaluation and risk assessment. The evaluation accounts for depth of casing strings on each side of the annulus, characterization of the annulus contents, pressure ratings of the casing strings and formation fluid pressures outside the casing strings. When annular pressure is detected, wellhead leaks can be eliminated or confirmed as the source of the annular gas by testing the wellhead seals where injectable packing and/or test ports are present. In some cases, annular gas can be sampled and analyzed to help determine the origin, since annular gas can occur from sources other than the gas storage reservoir.

Monitoring for defects, degradation, and corrosive and mechanical wear of tubular goods (casing, tubing or tubing/casing annulus) and evaluating the impact on well integrity is an on-going process. The frequency of monitoring is decided as part of the well integrity management plan and the underlying risk assessment that provides the basis for the integrity management plan. Tubular monitoring addresses:

- Evaluation of the integrity of the tubular goods and the identification of corrosion defects and other chemical/mechanical damage
- Corrosion potential of produced wellbore fluids and solids, including the impact of operating pressure and the analysis of partial pressures
- Corrosion potential of annular/packer fluid
- Corrosion potential of current flows associated with cathodic protection systems if applied to the well casing
- Corrosion potential of all formation fluids including fluids in formations above the storage zone
- Corrosion potential of un-cemented casing annuli including static liquid levels
- Corrosion potential of adverse current flows associated with cathodic protection systems from nearby pipelines and other production facilities

There are numerous methods used to monitor downhole conditions, including corrosion, and operators evaluate which methods to employ based on well configuration and risk assessment. Evaluation of well information, hazards and threats and the likelihood and consequence of failure drive decisions regarding tool usage and frequency of deployment for monitoring downhole conditions. When operators remove tubular goods during workovers and corrosion products are visible, samples can be sent for metallurgical analysis to help determine the cause and mechanisms of the corrosion. Some of the other tools used to evaluate downhole conditions (including corrosion) in tubing and/or casing include:

- Temperature, differential temperature and/or noise logs to look for anomalous readings that could indicate fluid movement behind pipe
- Neutron logs to look for accumulations of gas in formations outside the storage zone(s)

- Eddy-current/magnetic flux leakage logs to help determine inner and outer wall metal loss and pipe defects
- Caliper logs to evaluate inside diameter, internal corrosion and defects
- Cement bond logs to help determine cement tops and bond quality to the casing and to the formation
- Segmented bond logs to look for cement channeling
- Downhole cameras for visual inspection of the inside of the casing or tubing
- Ultrasonic imaging logs to help determine cement channeling, internal diameter, wall thickness, pipe eccentricity and defects
- Electromagnetic casing potential logs to help identify axial and radial current density, corrosion rate, external corrosion location and casing thickness

These specialized tools require specific wellbore conditions and technicians to run them and to evaluate the results. Different tools evaluate different properties of metal, fluids or voids, including anomalous readings, gas behind pipe, fluid movement, corrosion potential, metal loss (wall thinning, pits) and other defects (split pipe, ovalities, kinks, holes). Operators determine which (if any) of these tools are appropriate to use as a means of gathering data to aid in the assessment of the as-current health of key components of the well barrier envelope. These data can be part of a risk reduction program when increased or additional monitoring is indicated.

When new wells are drilled, baseline logs are run to aid in future well integrity monitoring, including logs that evaluate changes in gas located behind casing (for example neutron logs) and the condition of newly installed casing (for example magnetic flux leakage or acoustic-type casing inspection logs). Baseline logs help determine anomalies present when the pipe is first installed, and since new installed wells are tested for mechanical integrity prior to being placed in service, the presence of these same anomalies on future logs can be explained. Future log runs are useful to follow the progress of any anomalies detected and, with the aid of risk assessment, they can help operators determine when mitigative steps are needed.

Risk assessment is holistic, in that all threats to the integrity of the gas storage facility are evaluated. In addition to wellhead and wellbore mechanical damage and corrosion, operators evaluate the effects of flow erosion, hydrate forming potential, facility component flow capacity and corrosive potential of fluids present across the gas flow rate and pressure operating envelope for the facility.

Operators use the monitoring of well pressure (including shut in wells) as a means of demonstrating ongoing well integrity. Unanticipated changes to historical trends are investigated and findings and corrective actions are noted for future reference. Many times these changes are operational issues (such as faulty instrumentation) and explainable, but these anomalies deserve careful evaluation since they can also be early warnings of potential loss of well integrity.

C. Well Barriers and Potential Leak Paths (API 1171 Section 9.3)

Operators have designed and installed a number of different well completions depending on their historical experiences, practices, and site-specific conditions. A common well completion case referenced herein contains production casing without tubing. The primary root cause mechanisms for storage gas well releases for this completion are 1) wellhead component or seal failure; 2) production casing leak; or 3) a downhole annular barrier breach (i.e. cement sheath). These primary leak paths are depicted on the schematic in Appendix 5 Gas Storage Well Configuration: Example C and described more fully below:

1) *Wellhead component or seal failure*

This leak path occurs when the primary and secondary seals in the wellhead fail, allowing gas in the production casing to migrate past the seals into the production casing annulus. Leaks can also occur as a result of mechanical failure of other wellhead components such as casing slips, which can allow the production casing to drop free of the wellhead seal assembly. Observations that indicate a potential leak may exist include an increase in annular pressure or flow, dependent on the annular valve position during normal well operation mode.

For a release to occur, an initial failure takes place allowing pressurized storage gas to leave the production casing. Gas then either exits through an open annular valve or pressures up the annulus, if closed. To eliminate this type of release to the atmosphere, some operators close the annular valve while the well is in operational mode. However, if pressurized gas is trapped in the annulus and not allowed to dissipate, there is a possibility of additional secondary failures that will lead to more complex, and difficult to control, release paths, hence other operators leave the annular valves open in normal operational mode.

Diagnosing the failure mechanism requires the operator to perform one or more of the following operations; test wellhead seals, observe wellhead components for indications of leakage (noise and/or hydrate deposition), and/or perform interference testing between the production casing and production casing annulus to determine if the leak is at the surface or downhole. Leak resolution may include replacing the wellhead assembly or wellhead seals and/or repair or partial replacement of the production casing. Preventive measures such as wellbore integrity inspections, mechanical integrity testing, and annular barrier monitoring and evaluations may identify potential direct cause failure mechanisms before they occur.

2) *Production casing leak*

This leak path occurs when the production casing wall is breached. Causes include but are not limited to production casing failure due to reduced casing wall thickness from corrosion and/or the introduction of higher pressures than containable for stimulation treatments, or production casing wall collapse from outside forces such as earth movement or foreign production operations. Observations that indicate a potential leak may exist are lower than expected shut-in pressures or gas exiting somewhere outside of the structure of the wellbore.

The stored gas can escape outside the structure of the storage wellbore from deep underground and migrate through a path of least resistance upward until it reaches an alternative escape path. The escape path could be through an oil and gas, water, or abandoned well completed in a shallower permeable formation or the path could be all the way to an escape at the surface. Operators must understand subsurface geologic conditions to assess the risk of geologic migration.

Diagnosing the failure mechanism requires the operator to perform one or more of the following operations: obtain electric logs (pipe inspection, caliper, gamma ray-neutron, differential temperature, noise, spinner flow survey, etc.); install a bridge plug and pressure test the casing. Options for the operator to resolve the breach may include partially replacing the production casing, installing a casing internal patch, cladding, or liner, and/or remedial cementing. Preventive measures such as wellbore integrity inspections, mechanical integrity testing, and annular barrier monitoring and evaluations may identify potential direct cause failure mechanisms before they occur.

3) Downhole annular barrier breach

This leak path occurs when gas and/or hydrostatic pressure in the annulus exceeds the strength of the rock below the intermediate or surface casing shoe, resulting in establishment of an escape path outside the wellbore. Observations that a potential leak may exist are gas exiting somewhere beyond the structure of the wellbore.

In this case storage gas finds a path of least resistance around the intermediate casing shoe and then into the subsurface lithology where it could enter an oil and gas, water, or abandoned well completed in a shallower permeable formation, or migrate all the way to an escape at the surface.

Diagnosing the failure mechanism requires the operator to obtain electric logs (gamma ray-neutron, differential temperature, ultrasonic/noise, etc.) as needed to determine the direct cause. In order to resolve this breach, the operators will usually require remedial cementing. Preventive measures such as wellbore integrity inspections, mechanical integrity testing, and annular barrier monitoring and evaluations may identify potential direct cause failure mechanisms before they occur.

Note: for any gas release path scenario, failure of one or more barriers to storage gas containment must occur. Proactive wellbore integrity inspections and annular barrier monitoring and evaluations that result from a site-specific risk assessment model are key elements to identifying and resolving a direct failure mechanism before it occurs.

D. Site security, inspections and emergency response (API 1171 Section 10)

Storage operators assess and monitor the security and safety of their well sites and have an emergency plan in place in the unlikely chance of an event. The overall goal of the plan is to reduce the potential for an incident and to ensure the safety of the public, operating personnel, contractors, property and the environment. Thorough preparation and training enables operating personnel to recognize and respond to abnormal operating conditions or to changes in site security in a timely manner so as to minimize or prevent impacts.

Due to the variety of designs for downhole and wellhead facilities, the potential failure modes of a well can be different from well to well even in the same field. Likewise, utilization of adjacent lands by the surface owner and wellsite configuration also add diversity. Therefore, the safety and security plan are site-specific and are determined by the operator's risk assessment.

Operators take additional steps to maintain site security and safety by limiting access during drilling, workover, wireline logging and other similar activities. Additionally, operators can use fencing, barricades and other barriers to restrict access during on-going operations as determined through their site-specific assessments. The implemented security and safety measures are influenced by the well's flow potential, location, population density, natural forces, terrain and environment adjacent to the

wellsite. Operators are aware of potential ignition sources on the wellsite during well work and locate such potential ignition sources in a manner that provides for on-going safety.

Site inspections to review the safety and security of storage facilities at the well site are performed on a regular and periodic basis. Inspections are often concurrent with the collection of well data, such as annular pressures, mechanical integrity inspections, or other operational activities such as opening or closing the well. Changes in the status or condition of an item being utilized in the risk analysis are reported to the storage personnel responsible for the risk analysis process. This change will then be utilized in the next iteration of the risk analysis and the operator will implement new, additional and/or different risk preventive and mitigative measures, if necessary.

To ensure consistency and the collection of accurate information, operators are developing forms listing the inspection criteria and training personnel in how to conduct the inspection. The inspection results are saved according to the operator's document retention policy.

Operators are developing, implementing and updating emergency preparedness/response plans that cover accidental releases, equipment failures, natural disasters and third party damages. Gas storage plans are incorporated into the operator's existing emergency procedures for the pipeline system and include personnel roles and responsibilities, emergency contact information, communication protocol, procedures for response to leaks, fires and uncontrolled well releases and other information and tasks as further detailed in API 1171. Operators are training personnel using the emergency response plan. Often, operators contact local emergency responders and discuss incident scenarios and potential response alternatives.

A key component of an underground storage operator's emergency response plan that is unique to well operations is a well emergency plan which treats loss of containment or loss of control incidents occurring during well drilling, servicing or operating. Due to the potential wide variety of well emergencies, the operator's plan needs to be flexible. The plan identifies the procedures, equipment and personnel needed to respond to the situation.

E. Procedures and training (API 1171 Section 11)

Operators are updating existing and developing new processes and procedures to identify and address the safe operation, maintenance and inspection of storage wells, consistent with requirements, safety policies, regulations and applicable standards. The authors have existing safety processes and procedures established to conform with basic well safety established by state regulatory authorities or the operator's prudent practices.

As stated previously, gas storage operators are in various stages of establishing conformance with API 1171 guidance. Operators are conducting gap analyses between their current practices and API 1171 with respect to procedures and training. Closing the identified gaps to align with API 1171 is part of the process expected to be performed within the 7-10 years following a final rulemaking.

Procedures address all operations phases, including:

- Initial startup (new, modified, or acquired facilities)
- Normal operations
- Temporary operations as needs arise

- Normal shutdowns
- Emergency operations, including emergency shutdowns
- Start-up or restoration of operations following maintenance

Procedures are put in place prior to the development of a new storage facility, and address the minimum requirements for construction including drilling and other well entry work, reservoir integrity monitoring and management, operations and maintenance, emergency response, control room communications and responses, personnel safety, safety management systems, and site-specific procedures determined to be necessary by the operator.

Operators are training personnel responsible for operating, maintaining, and monitoring storage wells and reservoirs in accordance with their duties and responsibilities. Training addresses operating procedures, safety procedures, recognition of abnormal operating conditions and emergency conditions. Training programs can consist of methodologies including, but not limited to classroom, computer-based and on-the-job training. Operators review training programs periodically to determine effectiveness. Training programs are modified when changes occur in technology, processes, procedures, or facilities. Operators evaluate the effectiveness of training to verify that persons assigned to operate and maintain storage wells and reservoirs possess the knowledge, skills, and abilities necessary to carry out their duties and responsibilities including those required for start-up, operation and shutdown of storage facilities. Personnel are trained on the site-specific procedures necessary for operation of storage wells and reservoirs, as well as trained on the recognition of abnormal operating conditions. Reporting requirements, documentation, and recordkeeping requirements are included in the training.

Integrity Management programs also integrate storage well and reservoir elements so that procedures and programs work together to promote the integrity of the storage facility. Data required include geologic information on the formations penetrated by the storage well, wellbore configuration and completion data (e.g. casing characteristics, setting depths, cement, etc.), pressure and volume data on the flow capability of the well and reservoir, annular pressure and/or volume data, reservoir fluid analysis, wellhead design, and other characteristics of the subsurface in addition to information about the wellsite.

Operators establish regular review frequencies for the procedures and use management of change to provide for orderly review and acknowledgement of changes and the impacts to integrity and safety. Procedures are modified to account for changes in operating conditions, advancements in technology, regulatory changes, abnormal operating conditions, or as experience dictates.

Operators retain the records necessary to administer the procedures and establish retention requirements for specific records. Whenever changes are made to the operating procedures, operating personnel are notified and trained as necessary and the training is documented. Records management includes requirements for identification, collection, storage, protection, retrieval, retention time and disposition of records.

Operators maintain records of well configuration (as-built), well construction and well work activities for the life of the facility. These records include, as applicable and available:

- Wellhead equipment and valves
- Well casing
- Casing cementing practices
- Completion and stimulation
- Monitoring of construction activities
- Testing and commissioning
- Well remediation
- Well closure

Operators use pipeline public awareness and damage prevention communications that include information regarding the utilization of damage prevention notification systems, education of the public on the hazards related to unintended releases, indications of a release, procedures for reporting the release and actions to be taken for public safety during the release.

Appendix 1

Background - Underground Storage of Natural Gas in the U.S.



SUPPORTING THE AMERICAN WAY OF LIFE



THE IMPORTANCE OF
NATURAL GAS STORAGE

WHERE NATURAL GAS STORAGE IS LOCATED?



Underground storage of natural gas is an integral component of the nation's energy system, and our nation's significant storage capacity enables utilities to offer clean natural gas to consumers throughout the year with reliable service and prices.¹

This use results in significant seasonal variations in which natural gas consumption is highest during the winter time and lowest during mild-weather months. Natural gas storage enables supply to match demand on any given day throughout the year.

Natural Gas Working Storage Levels

Energy Information Administration, "Weekly Natural Gas Storage Report, History," January 8, 2016.

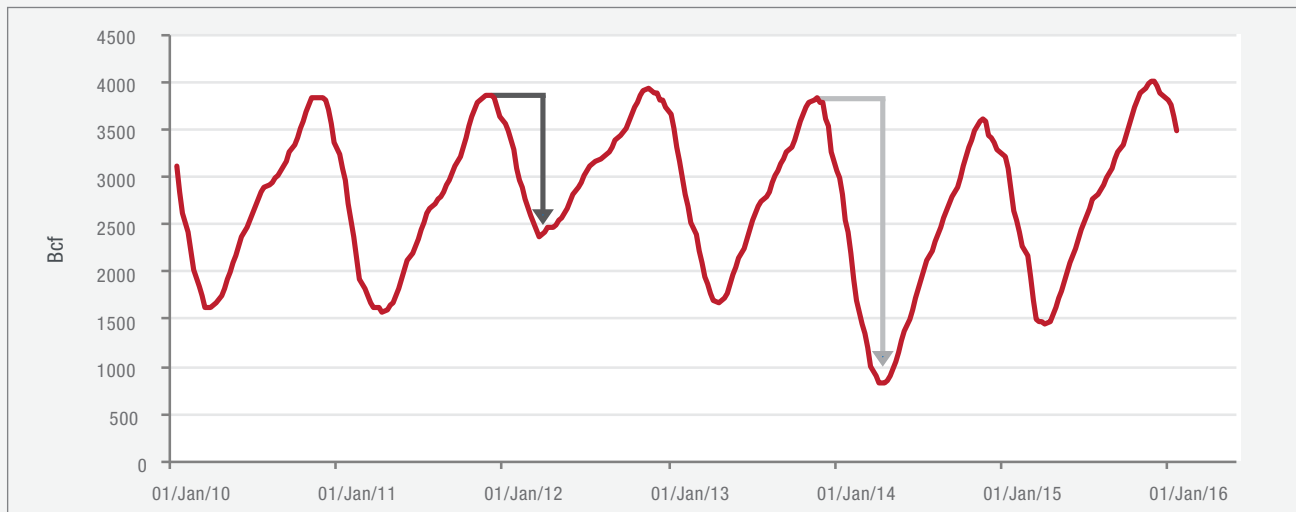

The chart above shows how storage fluctuates with the weather. During the mild winter of 2012, the gas withdrawn from storage was far more moderate (see black arrow). In contrast, in 2014, the year of the Polar Vortex, natural gas storage was "drawn down" sharply (see grey arrow). But even in the mildest of winters, such as 2012, natural gas withdrawals from storage were vital to meeting winter natural gas demand.

Where Natural Gas Underground Storage Fields are Located

Type of Storage and Total Field Capacity, July 2014

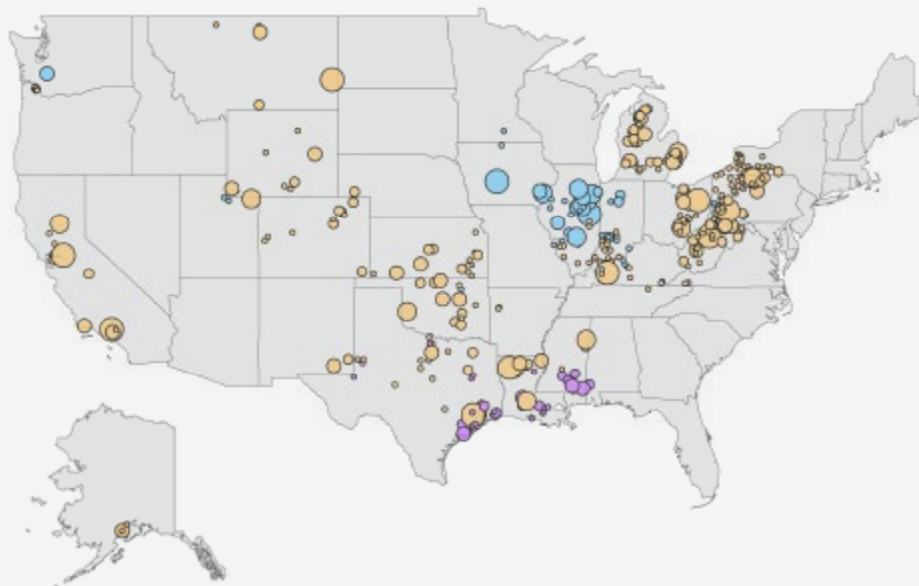

Type of Storage

- Depleted Fields
- Salt Formations
- Depleted Aquifers

Total Field Capacity (Billion Cubic Feet)

- Less than 14.5
- 14.5 to 37.8
- 37.8 to 73
- 73 to 122
- Greater than 122

¹ Energy Information Administration, "Natural Gas Explained, Use of Natural Gas," accessed January 15, 2016, http://www.eia.gov/energyexplained/index.cfm?page=natural_gas_use

NOTE: that the map includes both active and inactive fields.

SOURCE: EIA Energy Mapping System; EIA-191 Monthly Underground Gas Storage Report July 2014

HOW IS NATURAL GAS STORED?

How is Natural Gas Stored?

Natural gas is stored underground primarily in three reservoir types: depleted oil and gas fields, depleted aquifers, and in salt beds and salt caverns. Natural gas may also be stored above ground in refrigerated tanks, as liquefied natural gas (LNG).

Types of Natural Gas Underground Storage

Depleted Natural Gas or Oil Fields

Of the approximately 400 active underground storage facilities in the U.S., about 79 percent are depleted natural gas or oil fields. Conversion of an oil or gas field from production to storage takes advantage of existing infrastructure such as wells, gathering systems, and pipeline connections. Depleted oil and gas reservoirs are the most commonly used underground storage sites because of their relatively wide availability.

Salt Formations

Salt formation storage facilities (also known as salt caverns or salt beds) make up about 10 percent of all facilities. These subsurface salt formations are primarily located in the Gulf Coast states. Salt formations provide very high withdrawal and injection rates.

Depleted Aquifers

Natural aquifers may be suitable for gas storage if the water-bearing sedimentary rock formation is overlaid with an impermeable cap rock. They are not part of drinking water aquifers and make up only about 10 percent of storage facilities.

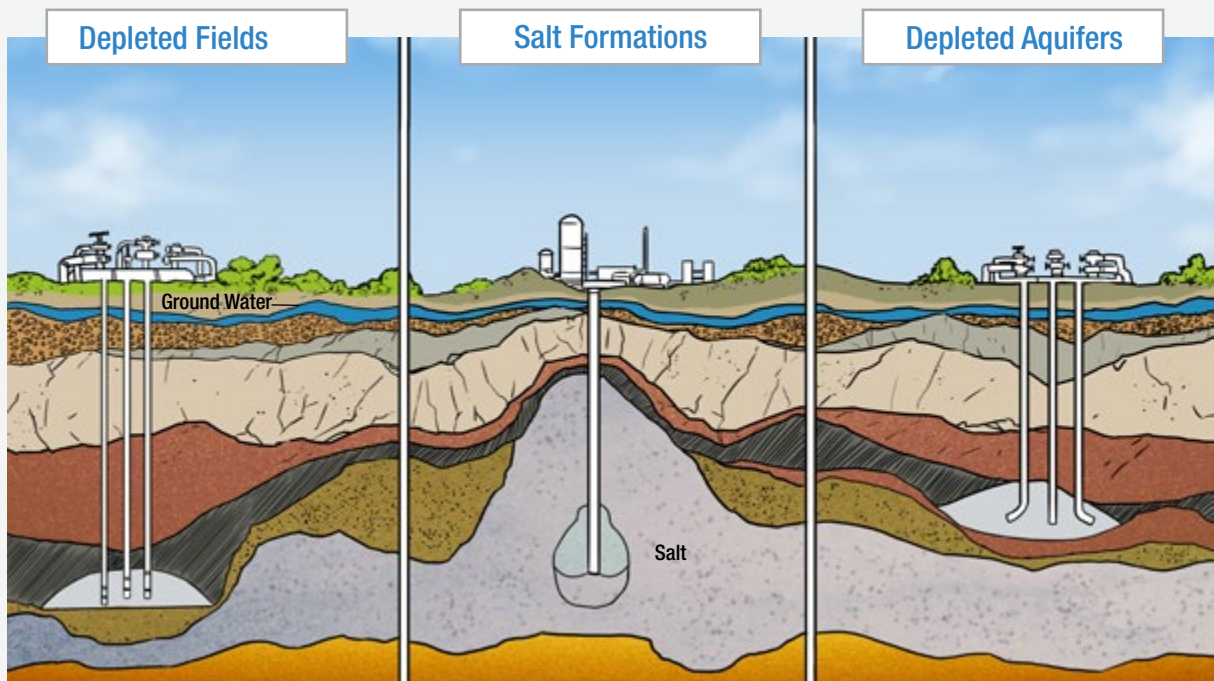

SAFETY IN UNDERGROUND STORAGE OF NATURAL GAS

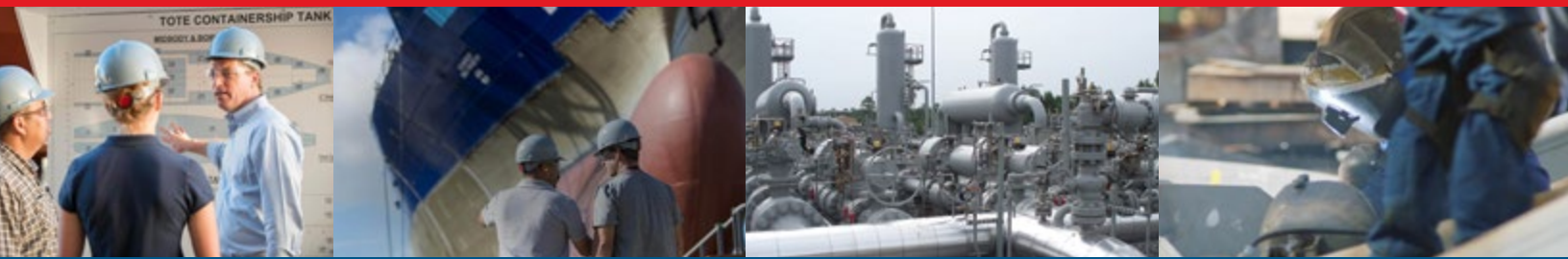

Underground natural gas storage operators are committed to ensuring the safety and integrity of their facilities. The industry's construction, operation and integrity management protocols are overseen by multiple agencies at the state and federal level with jurisdiction over underground storage facilities:

- The Federal Energy Regulatory Commission (FERC) regulates projects connected to interstate pipeline systems. FERC is responsible for authorizing the construction or expansion of storage facilities and the terms and conditions of service (i.e., open access) and the rates charged by these providers.
- The Pipeline and Hazardous Materials Safety Administration (PHMSA) is authorized to regulate the safety of natural gas transportation and storage.
- Intrastate storage may fall under the regulatory authority of various state government entities depending upon the state. For example, underground storage in Texas is under the authority of the TX Railroad Commission – Oil & Gas Division. Often state utility commissions as well as state environmental or natural resource agencies set the rules governing intrastate underground storage.

Beyond federal and state regulation, industry has taken the initiative to work with external stakeholders to develop two recommended practices (RPs)—accredited by the American National Standards Institute—for underground storage. RP 1170 and 1171 provide guidance to operators on how to design, operate, and ensure the integrity of underground storage for natural gas.

Underground Storage by the Numbers

- Approximately 400 active storage facilities in 30 states, made up of depleted natural gas or oil fields (80%), depleted aquifers (10%) and salt caverns (10%)
- Approximately 20% of all natural gas consumed during the winter is supplied by underground storage
- Underground storage capacity increased 18.2% between 2002 and 2014
- Approximately 4 trillion cubic feet of natural gas can be stored underground, or enough to meet an average states residential natural gas consumption for more than 20 years



Appendix 2
 Various Steps for Well & Reservoir Integrity Management Evaluation

Source: API Recommended Practice 1171, Figure 1

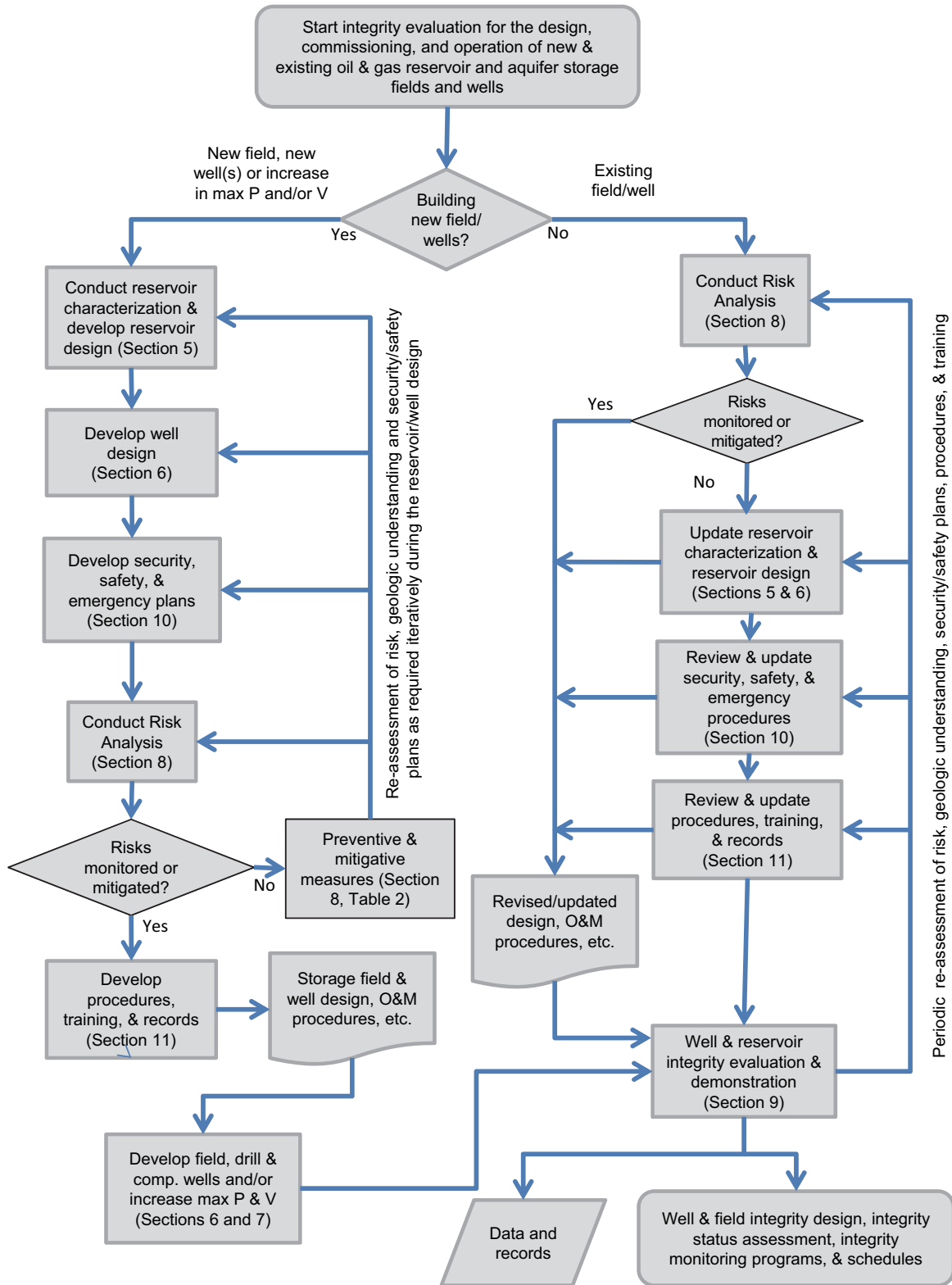

Appendix 3 Storage Well Potential Threats and Consequences

Source: adapted from API Recommended Practice 1171, Table 1

Threat or Hazard	Threat/Hazard Description	Potential Consequences
Well integrity (corrosion, material defect, erosion, equipment failure, annular flow)	Gas containment failure due to inadequately sealed storage well(s), e.g. casing corrosion, cement bond failure, material defect, valve failure, gasket failure, thread leaks, etc.	<ul style="list-style-type: none"> • Loss of stored gas inventory • Damage to well site facilities and equipment • Safety hazard to company personnel and the public • Loss of use of water sources and/or wells • Decrease or loss of field performance
Design	Gas containment failure due to inadequate completed wells, sealed plugged well(s), failure of cement squeeze job perforations or stage tool, pressure rating of components, etc.	<ul style="list-style-type: none"> • Release of gas to the atmosphere • Damage to well site facilities and equipment • Safety hazard to company personnel and the public • Loss of use of water sources and/or wells • Loss of stored gas inventory • Decrease or loss of field performance
Operation and maintenance activities	<ul style="list-style-type: none"> • Inadequate procedures • Failure to follow procedures • Inadequate training • Inexperienced personnel and/or supervision 	<ul style="list-style-type: none"> • Loss of stored gas inventory • Damage to well site facilities and equipment • Safety hazard to company personnel and the public • Loss of use of water sources and/or wells • Decrease or loss of field performance
Well intervention	Gas containment failure due to loss of control of a storage well while drilling, reconditioning, stimulation, logging, working on downhole safety valves, etc.	<ul style="list-style-type: none"> • Damage to drilling rig or service rig • Loss of tools in wellbore • Hazard to operator and service company personnel • Safety hazard to public • Decrease or loss of field performance • Loss of well
Third party damage (intentional/unintentional damage)	Intentional/ unintentional damage	<ul style="list-style-type: none"> • Accidental impact by moving objects (e.g. farm equipment, cars, trucks, etc.), vandalism, terrorism that could result in damage to facilities: <ul style="list-style-type: none"> ○ Loss of ancillary facilities ○ Well on/off status change ○ Impact to service reliability ○ Impact to neighboring public, storage gas loss
Outside force-natural causes	Weather related and ground movement	<ul style="list-style-type: none"> • Heavy rains, floods, lightning, earth movements, groundwater table changes, subsidence, etc. that could result in: <ul style="list-style-type: none"> ○ Damage to facilities/impact to service reliability

© 2015 American Petroleum Institute. All rights reserved

Other use is prohibited without express written consent.

Appendix 4
Storage Well Preventive and Mitigative Programs

Source: adapted from API Recommended Practice 1171, Table 2

Threat or Hazard	Preventive/Mitigative Treatment or Monitoring Programs
Well integrity (corrosion, material defect, erosion, equipment failure, annular flow)	<ul style="list-style-type: none"> • Casing condition and inspection program • Monitoring pressure, rate and inventory • Cement analysis and evaluation • Internal corrosion monitoring • Plugged and abandoned well review and surveillance • Monitor annular pressures, rates, or temperatures • Subsurface and surface shutdown valves • Monitor cathodic protection as applicable • Operate, maintain and inspect valves and other components
Design	<ul style="list-style-type: none"> • Collect and evaluate plugged and abandoned well records and rework or plug • Develop design standards for new wells • Evaluate current completion of existing wells for functional integrity and determine if remediation monitoring is required
Operation and maintenance activities	<ul style="list-style-type: none"> • Procedures • Training of personnel and contractors and establishment of procedures
Well intervention	<ul style="list-style-type: none"> • Implement training and safety programs for company and contractor personnel • Develop detailed drilling and well servicing procedures

© 2015 American Petroleum Institute. All rights reserved

Other use is prohibited without express written consent.

Appendix 5

Well Configuration Examples A, B, and C

Gas Storage Well Configuration: Example A
Depleted Reservoirs and Aquifers

Note: Not To Scale

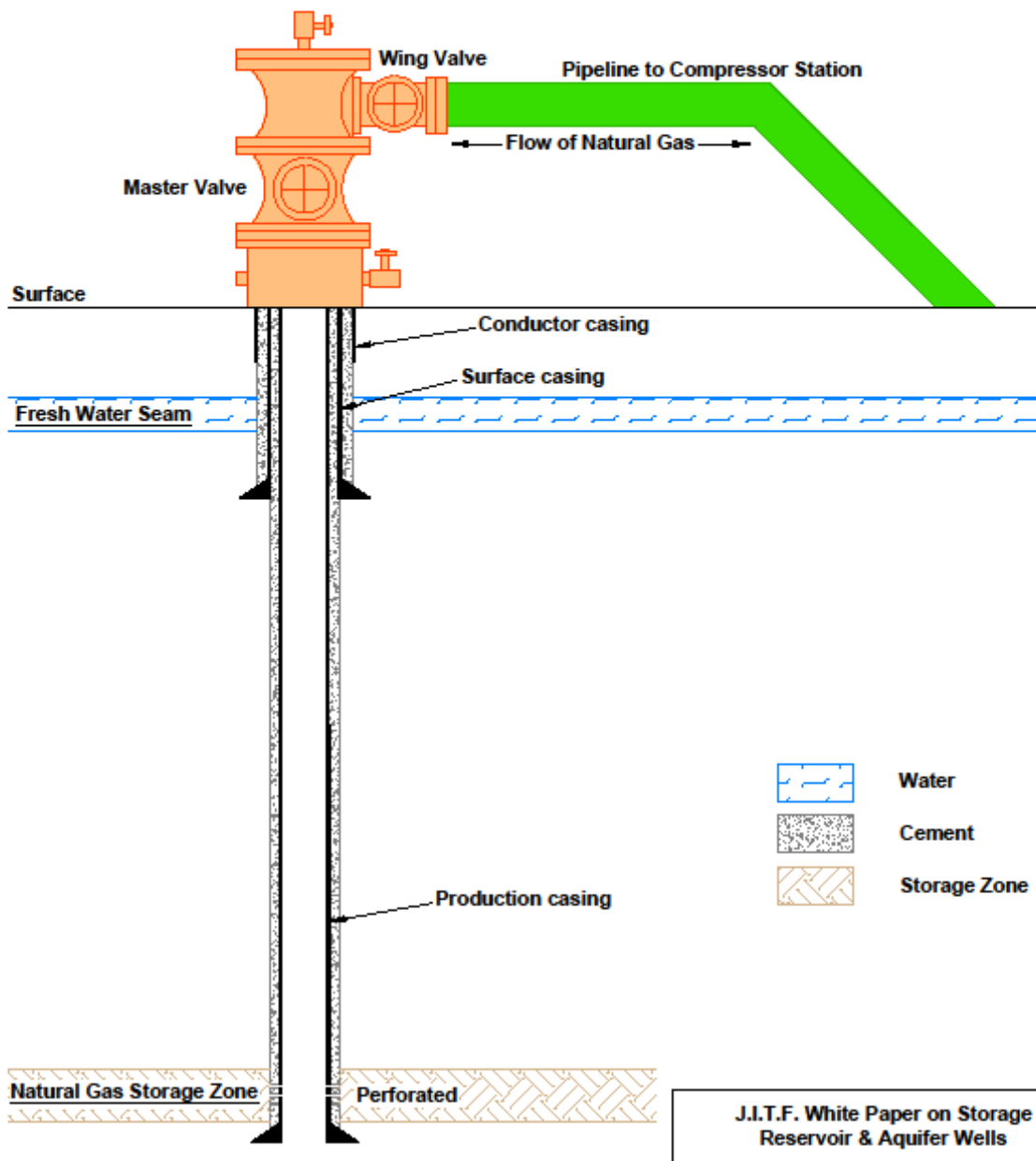

Gas Storage Well Configuration: Example B
Depleted Reservoirs and Aquifers

Note: Not To Scale

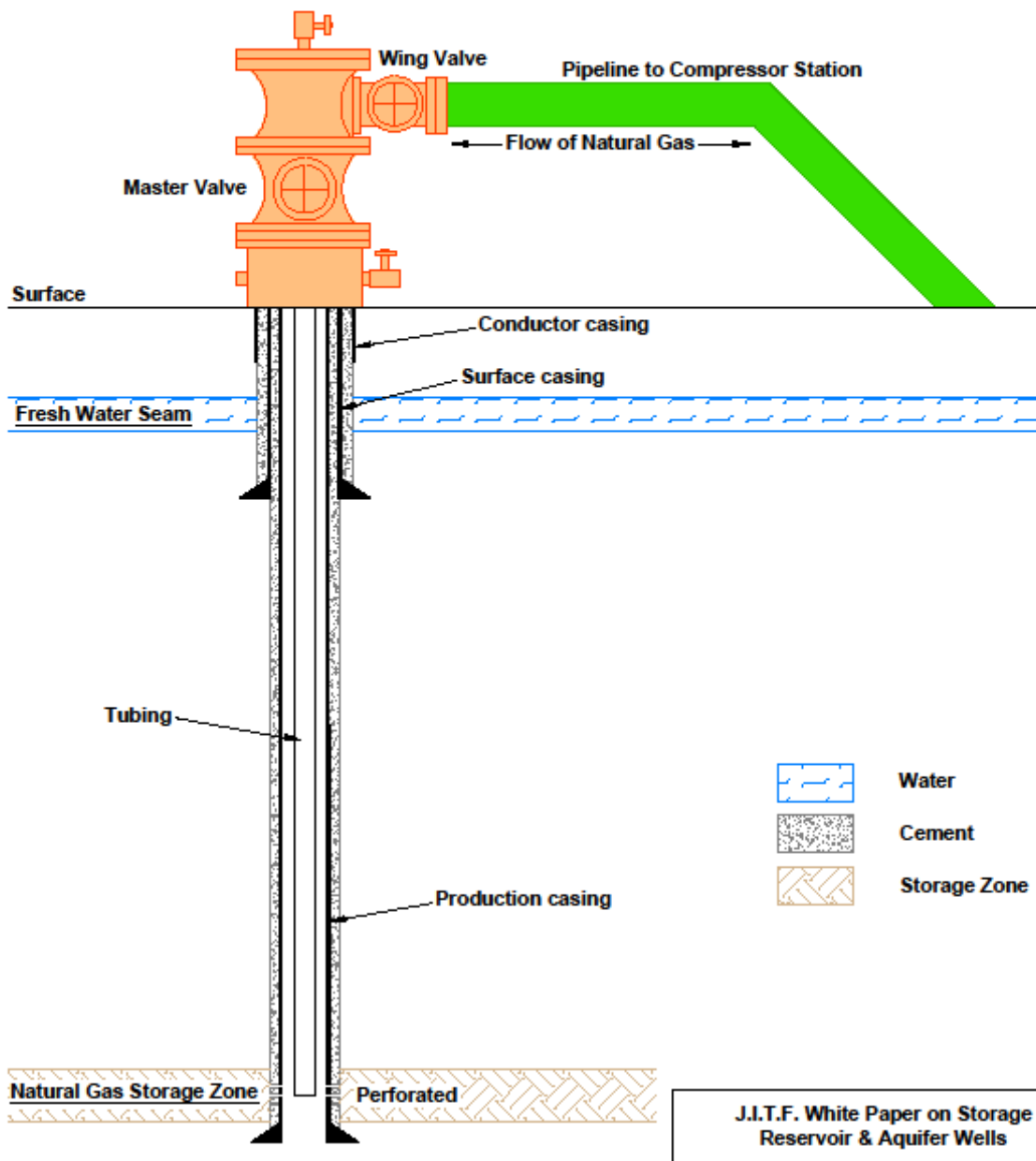

Gas Storage Well Configuration: Example C
Depleted Reservoirs and Aquifers

Note: Not To Scale

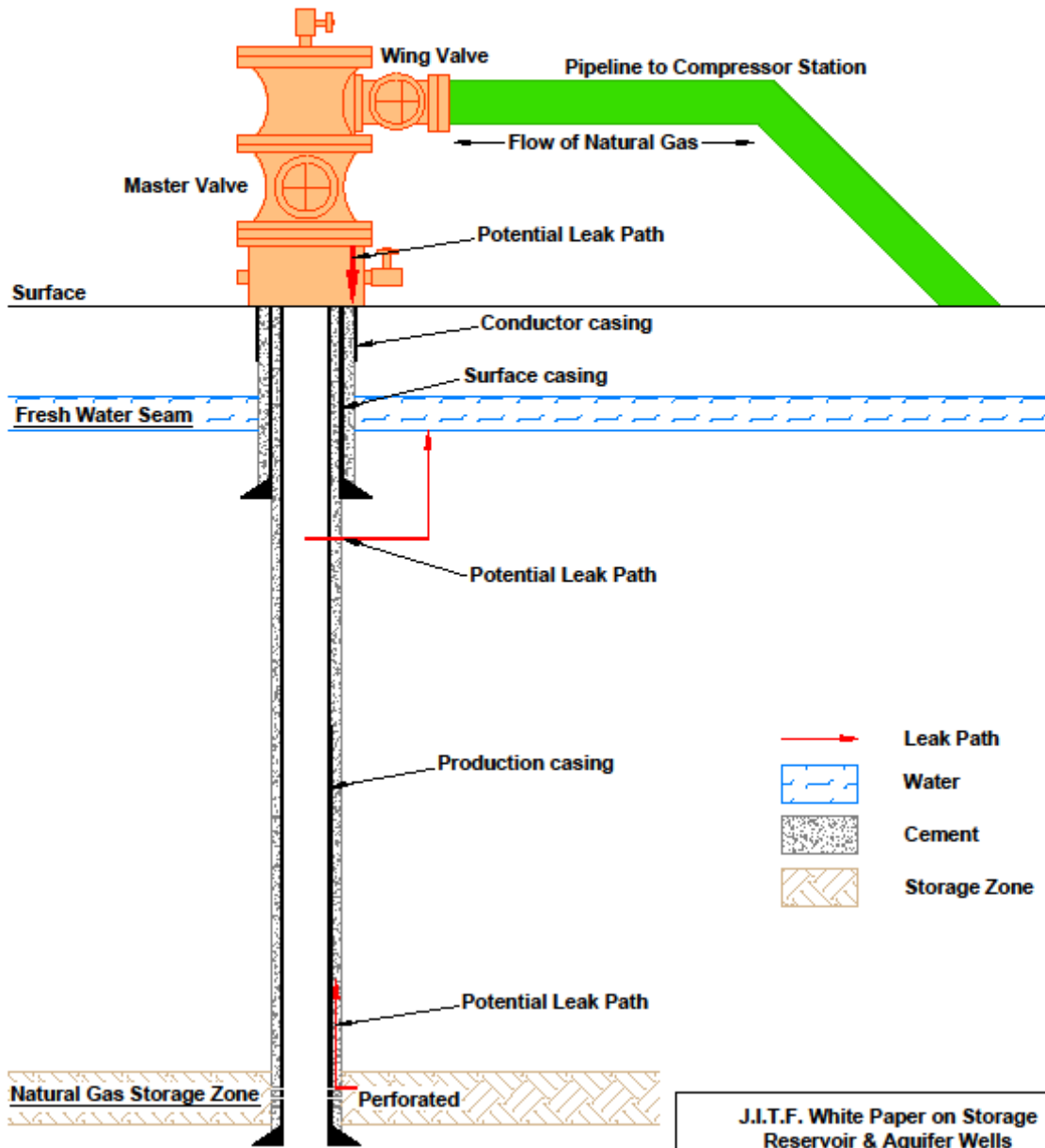

J.I.T.F. White Paper on Storage Reservoir & Aquifer Wells

Appendix 6

Emergency Shutdown Valve Systems in Natural Gas Storage Wells: Application, Historical Use and Reliability, and Risk Assessment for Decision-Making in Regard to Application

Executive Summary

This Appendix explains Emergency Shutdown Valve (ESV) systems, their use and application in natural gas storage, operating experience and reliability, standards and regulations, and risk assessment related to decision-making on ESV application. ESVs can be installed above ground as Surface Safety Valves (SSV) or below ground as Subsurface Safety Valves (SSSV). Above ground systems are much easier to assess, test, and maintain, but their ability to provide physical barrier control can be limited if the wellhead becomes damaged. Underground valves can sense abnormal surface conditions and close, but are more difficult to operate and, in the experience of this Joint Industry Task Force (JITF) team, have additional issues that affect reliability and safety. Based on industry surveys, this team estimates that approximately three to five percent of storage wells currently have SSSVs. This Appendix explains ESV systems, summarizes some available reliability information, summarizes the benefits and reliability issues experienced by storage operators, and provides storage operator industry perspective. Appendices provide company operating experience testimonials, literature reviews of ESV reliability and risk management guidance.

Natural gas storage operators have consistently provided safe and reliable natural gas storage. As natural gas storage is critical for meeting peak hourly, daily and seasonal user demand for natural gas, natural gas storage operators are continually searching for new equipment, processes, and methodologies to improve safety and reliability. ESVs have a long operating history in natural gas storage fields. Gas storage operators have employed SSSVs since the 1960s and 1970s. SSSV use increased in the 1980s and 1990s in production and storage settings. Natural gas storage operators began installing SSSVs within their storage wells to act as a physical control barrier, activating during pressure, temperature, or surface damage events. Several companies within the natural gas storage industry embraced SSSVs to provide an additional barrier control for high risk storage wells. Operators began installing SSSVs at locations of concern such as roadways or near homes to provide an additional level of safety in case a breach at the wellhead occurred. In the period since their first installations, storage operators have gained experience with operating and maintaining SSSVs, have a better understanding of their safety benefits, and have learned the additional reliability challenges and risks that come with their application.

The benefits of ESV systems include risk reduction related to consequence mitigation by limiting the magnitude and duration of an event that occurs downstream of the valve. The ESV system provides a means of automatic or controllable shut-off of flow and thus could have a protective effect to places of habitation, roads, human gathering places, environmentally sensitive areas, other industrial infrastructure, including inter-related gas storage facilities, or other sensitive receptors. The fail-safe, automatic or controllable functionality of ESV systems protect against uncertain events such as natural forces (earth movements, seismic activity, floods, severe weather events and other earth forces) or human-induced activity that could have adverse impact on well integrity. ESV system technology is a proven technology that has been extended to wider applications in terms of depth, location, diameter and pressure-temperature-flow regimes.

In the period since the 1960s, natural gas storage operators have observed a variety of challenges associated with ESV system use in the subsurface (SSSV), including the impairment of storage service reliability, increased risks to field operators (workers) and the public due to increased well re-entry (service) rates and related loss-of-containment potential, and increased challenges with emergency intervention operations. SSSV do not arrest all leaks, only those severe enough to activate the valve. A

shallow SSSV installation does not shut-down the flow of gas through a deep casing breach or other event upstream of the valve. Shallow SSSVs are designed to limit the amount of escaping gas in a catastrophic surface or near-surface event. SSSVs might not seal gas tight over time because the conditions in which they operate are harsh in terms of exposure to high velocity, large pressure variations, liquids, sand and other particulates.

Key observations discussed in this Appendix include:

- 1) ESV systems are a physical control, or barrier, requiring a specific set of conditions in order to activate.
- 2) An ESV system, if functioning properly during the specific event for which it was designed, can reduce the consequences of an event by minimizing duration and impact.
- 3) ESV system valve setting (location in the well) determines the risk reduction benefit for a particular event.
- 4) ESV in the downhole well environment have reliability and safety issues:
 - a. Reliability rates (Mean Time to Failure (MTTF), Mean Time to Repair (MTTR)) have well-established ranges for immediate service impacts (corrective maintenance) as well as longer-term functional failures requiring well re-entry and repair or replacement (based on industry literature review and storage operator testimony).
 - b. SSSVs can have service reliability impairment due to tubing string/ valve flow diameter restrictions along some length of the wellbore (storage operator testimony).

Table 1. Probability Descriptors per the Center for Chemical Process Safety (CCPS) American Institute of Chemical Engineers (AIChE)

Descriptor	Decimal Notation (Incidents per well-year)	Scientific Notation (Incidents per well-year)
Likely	> 0.01	> 1.0E-02
Unlikely	0.001 to 0.0099	1.0E-03 to 9.9E-03
Very Unlikely	0.00001 to 0.00099	1.0E-05 to 9.9E-04
Extremely Unlikely to Remote	< 0.00001	< 1.0E-05

- 5) SSSVs can mitigate the impact of a casing or casing/cement system loss-of-control/loss of containment event. The frequency of these events - as established in industry literature for the broader applications in the oil and gas exploration and production industry - is “very unlikely” (The Center for Chemical Process Safety defines “very unlikely” as in the range 1E-05 to 0.99E-04 per well-year – Table 1). Natural gas storage well casing failure and cement failure rates are in the “very unlikely” range of E-05 per well-year. Wells with two or more passive physical barriers (such as a casing string and a full cement sheath, etc.) have failure rates at least one order of magnitude less than a single technical barrier system, AND have inherent reliability if there is no degradation of these barriers by time-dependent decay modes such as corrosion. Failure rates quoted here are from industry surveys and literature sources referenced in this Appendix, including published papers from the Society of Petroleum Engineers, and the March 2005 report to the Gas Research Institute under Contract No. 8604, Project No. 809833, “Risk Assessment Methodology For Accidental Natural Gas and Highly Volatile Liquid Releases From Underground

Storage, Near-Well Equipment,” prepared by Glenn DeWolf, Katherine Searcy, Douglas Orr and Christopher Loughran on behalf of URS Corporation.

- 6) Wells with an SSSV can provide the entire well system with a failure rate of up to one order of magnitude less than that for a well system with only one physical passive barrier; however, SSSV have reliability weaknesses which increase the number of well re-entries and erode the risk reduction benefit by service impairment, service reliability impairment, and increased risk of loss of containment and increase the risk of worker safety due to well re-entry for servicing, repairing, or replacing the SSSV. The information to support the conclusion is from storage operator testimony, industry literature, and the Gas Research Institute report noted in conclusion #5.

Conclusions and Recommendations

Based on the operational knowledge of those assisting in the creation of this Appendix, and the research conducted by this team, there are advantages and disadvantages associated with SSSV.

The benefits include risk reduction related to consequence mitigation by limiting the magnitude and duration of an event that occurs downstream of the valve. The ESV system provides a means of automatic or controllable shut-off of flow and thus could have a protective effect to places of habitation, roads, human gathering places, environmentally sensitive areas, other industrial infrastructure, including inter-related gas storage facilities, or other sensitive receptors. The fail-safe, automatic or controllable functionality of ESV systems protects in particular against uncertain events such as natural forces (earth movements, seismic activity, floods, severe weather events, and other earth forces) or human-induced activity that could have adverse impact on well integrity. ESV system technology is a proven technology that has been extended to wider applications in terms of depth, location, diameter and pressure-temperature-flow regimes.

The disadvantages of ESV systems, particularly SSSVs, include functional reliability weaknesses for components of ESV systems, potential impairment of storage service reliability, increased risk to workers and the public due to increased well re-entry (service) rates and related loss-of-containment potential, and increased challenges with emergency intervention operations.

Therefore, it is recommended that the natural gas storage industry support, develop, and implement risk-based integrity management plans to mitigate risks, reduce potential adverse impacts, consider ways to mitigate the consequences of a casing or casing/cement system loss-of-control/loss of containment event, while balancing potential unintended consequences related to the application of equipment like ESVs, SSVs, and SSSVs. Government and industry are already taking steps to implement risk based Integrity Management plans for natural gas underground storage.

The authors align with the recommendations made in PHMSA’s Storage Advisory in Docket No. PHMSA – 2016-0016” with respect to decision-making around the use of ESV or alternatives. Specifically, the PHMSA advisory bullet #4 recommends periodic function tests for all ESV systems and the repair of deficiencies and failures, or the removal of the well from service, or employment of alternative and equivalently effective safety measures. PHMSA advisory bullet #5 recommends that operators evaluate the need for subsurface safety valves on new, removed, or replaced tubing strings or production casing using risk assessment aligning to API 1171 criteria as a minimum, and that where subsurface safety valves are not installed, the operator use the risk assessment to inform decisions on integrity inspection frequencies, reassessment intervals, and well integrity issue or incident mitigation criteria. The risk

assessment, decision, and rationale regarding application or potential application of an ESV system on a natural gas storage well (in a depleted hydrocarbon or aquifer reservoir) is a duty of a storage operator under the requirements of API 1171, Clause 6.2.5. The authors highlight the risk management process recommended to operators for use in the decision-making processes. Good decision making is transparent and assesses the outcomes of past decisions.

The authors recommend that storage operators engage in the following continual improvement actions:

- ✓ Follow the risk management process and minimum evaluation requirements in API 1171, Section 8, and clause 6.2.5, and share lessons learned and good practices through industry associations;
- ✓ Follow the additional guidance around risk management discussed in this Appendix and establish a consensus as to some uniform, minimum risk management process detail;
- ✓ Develop templates and methods to gather and share information regarding reliability of various well barrier element system components, including surface and subsurface ESV systems;
- ✓ Establish partnerships between operator groups and stakeholder groups to evaluate reliability of ESV systems and system components, with goals to establish, evaluate, and report safety performance and develop guidelines for good practices in integrity management and ESV system reliability management; and
- ✓ Collaborate through industry associations and regulatory agencies to develop common integrity management goals and establish regular forums where operating experiences can be shared and employee knowledge, skills, and experiences can be developed and enhanced.

Section 1. Overview

This Appendix was developed to assist with the understanding of emergency shutdown valve (ESV) systems, including type, typical application, usage, reliability, and determination of need based on site specific risk assessment. The data presented in this Appendix is a combination of available industry publications, recommended practices, standards, company experience and historical data.

An ESV system includes an actuated valve designed to close upon reaching previously defined operating threshold parameters. Common parameters include, but are not limited to, pressure, temperature, or flow rate. Valves can be actuated by mechanical, electrical, pneumatic, or gas-driven means. ESV systems can be located above or below the ground surface on gas storage wells. Below grade ESV systems can be further classified into shallow or deep set designs.

An ESV system typically consists of several components, including but not limited to:

- 1) Valve Control System (VCS) – Portion of an ESV system where logic is utilized to perform a specific action or set of actions upon reaching a pre-determined parameter (such as pressure, temperature, or flow rate thresholds). This system typically consists of a manifold, sensors, and a power source to control the valve. Hydraulic, electrical, mechanical, or other means are used to control the valve.
- 2) Valve – Typically a gate (flapper) or ball valve depending on its location within the well, wellhead tree, or adjacent to the wellhead. Based on the site specific characteristics of the well, the location of the valve could include:

- a. Surface Controlled Surface Safety Valve (SCSV) – A valve placed above grade in the wellhead tree or adjacent to the wellhead which is controlled by a surface VCS.
 - b. Surface Controlled Subsurface Safety Valve (SCSSV) – A valve placed below grade in the well casing or tubing which is controlled by a surface VCS.
 - c. Subsurface Controlled Subsurface Safety Valve (SSCSV) – A valve placed below grade in a well casing or tubing which is controlled by a subsurface VCS.
- 3) Emergency Shutdown Valve System (ESV) – Components of an overall system including, but not limited to, a valve, the VCS, tubing or lines used to control the valve, flow couplings, or other downhole or surface assemblies used in the control and operation of the valve.

ESV systems are used in numerous applications, including offshore and gas storage environments. In offshore production wells, ESV systems are used below the mud line, or the sea floor, to control a well in the event of damage to the exposed part of the wellbore above the mud line from causes such as a hurricane, boat anchors, or other external event. Surface ESV systems are also used in cavern storage. API 1170, *Design and Operation of Solution-mined Salt Caverns Used for Natural Gas Storage*, requires the use of surface ESV systems in cavern storage wells. Both API 1171, *Functional Integrity of Natural Gas Storage in Depleted Hydrocarbon Reservoirs and Aquifer Reservoirs*, and CSA Z341, *Storage of Hydrocarbons in Underground Formations*, require that a site specific risk assessment be performed for each well in reservoir storage to determine if an ESV system should be installed per the specific conditions at the location. Numerous other industry publications and standards recommend material, service, or maintenance guidelines for ESV systems.

An ESV system is a tool available to operators and is not intended to be a one size fits all solution. A gas storage well ESV can assist in controlling unrestricted flow from a well or wellhead for a specific set of conditions for which it is designed. But, based on available literature, a downhole ESV system reduces consequences of relatively few events since the likelihood of a loss of containment event occurring during normal operations is unlikely.

While an ESV can assist in controlling the unrestricted flow from a well or wellhead and thus serve a risk reduction role, literature sources and company experience suggest the application of ESV systems could add additional risk due to reliability issues with the components of the ESV system. Industry experience has established evidence of mean time to repair/mean time to failure and direct and secondary reliability issues related to flow interruptions, test failures, partial closures, and service capacity and reliability. The reliability issues cause an increased well re-entry (service) rate, which also carries a loss-of-containment risk.

Secondary methods can be employed to detect, respond to, and reduce a loss of control event into the tolerable risk range with or without an ESV system. Secondary methods include, but are not limited to: gas/flame detection monitoring equipment, annulus pressure monitoring, emergency plans for rapid response well kill or control, pressure test verification of containment barriers, pressure monitoring and control equipment, and, during workovers, regular blow-out preventer (BOP) testing and maintenance of dual barriers.

When evaluating the use of an ESV on a well, operators typically follow a defined decision making process, which includes:

- 1) Objectives clarification, where the operator defines the goals of their analysis by reviewing site specific conditions, operational characteristics, and environmental factors relevant to their operation.
- 2) Identify risk sources including hazards, threats, and potential hazardous situations. This analysis should also identify barriers to loss of containment events and identify gaps in the condition and effectiveness of barriers. Reliability issues with barriers could be common to other parts of the oil and gas industry and storage operators should consult technical literature sources.
- 3) Determine likelihood of well failure (loss of containment events) and potential impacts based on site specific conditions and incident duration.
- 4) Operators should follow a site-specific, risk-based assessment. After the assessments, operators prioritize wells by the risk estimated in the assessments and establish programs to prevent events by reducing the likelihood of the causes of gas containment failure and mitigating the consequences of a loss-of-containment event. This analysis should be performed on a well by well basis.

Consequence mitigation factors that tend to influence the decision to install an ESV system include proximity to places of habitation, roads, human gathering places, environmentally sensitive areas, other industrial infrastructure, including inter-related gas storage facilities, or other sensitive receptors. Event potential factors that could influence the decision to install ESV systems could include site-specific potential for impact due to natural forces (earth movements, seismic activity, floods, severe weather events, and other earth forces) or human-induced activity that could lead to forces adverse to well integrity.

Operators can develop risk management plans that might include ESV systems for wells defined in the integrity assessments as located within a significant impact radius potential of receptors or potentially subject to uncontrollable events from human or natural forces; the risk assessment and risk management plan should focus particularly on wells with capacity to flow at high rates and/or long durations.

Section 2. Description of ESV Systems

Locations of ESVs

Emergency Shutdown Valves can be located above ground (surface safety valves (SSV)) or below ground (subsurface safety valves (SSSV)). Operators choose the appropriate locations and configurations to meet their specific needs. API 14B, *Design, Installation, Repair and Operation Subsurface Safety Valve Systems*, provides definitions for safety valve systems, types, and components (API 14B - 3.20 SSSV system equipment; 3.21 surface-controlled subsurface safety valve SCSSV; 3.22 subsurface-controlled subsurface safety valve SSCSV; 3.23 subsurface safety valve SSSV; 3.24 surface control system; 3.25 surface safety valve SSV).

2.1 Surface Safety Valves

The SSV is part of a safety system to isolate the wellhead from the associated surface piping. This system consists of an isolation valve (typically a gate valve), a valve actuator/operator, and a valve control system (VCS). As this system is entirely above ground, all components are easily accessible for verification, testing and maintenance. Under normal operation, the VCS holds the SSV open. If the VCS detects an operational anomaly at the wellhead, such as excessive pressure or temperature, it allows the actuator to close the SSV.

2.2 Subsurface Safety Valves (SSSV)

The SSSV is a part of a flow shutdown system installed within a well to prevent uncontrolled flow. The SSSV can be in-line with the production tubing (tubing-retrievable) or be installed within the production casing (wireline-retrievable). There are several different SSSV configurations, each with their own advantages and disadvantages. The characteristics that differentiate the configurations of SSSVs are the locations of the valves (shallow-set vs. deep-set) and locations of the VCS (surface controlled vs. subsurface controlled).

Operators make decisions on the use and subsurface location of the SSSV based on a risk assessment balancing the risk reduction benefits of consequence mitigation and protection of potential receptors with the risk increase related to reliability of the SSSV, as described in more detail in following sections. The SSSV setting depth is a function of what the operator is trying to protect and the potential consequences the operator is trying to reduce. An operator could consider installing a shallow-set SSSV if the most significant threats relate to wellhead or surface network failure; an operator could consider installing a deep-set SSSV if there could be increased risk of casing or tubing failure deeper in the well.

Increasing the depth of the SSSV installation increases the technical difficulty and reliability related to surface-controlled systems and can also decrease flow capacity and reliability in many wells. Subsurface-controlled valves require set-points of flow rate/flow velocity or pressure differential in order to activate, which means that the subsurface-controlled valve will not activate until these conditions occur and there will be leaks of some magnitude for which the valve will not close. The working inventory pressure range and flow rate and velocity range of many storage wells complicates the set-point design and applicability of subsurface-controlled valves.

Deeper-set surface-controlled SSSV reliability issues are related to adverse mechanical operability impacts that can result from changes in flow or solids and liquids in the flow stream. The SSSV valve closure mechanism can be fouled or deteriorated by collection of organic and/or inorganic solids, erosion or corrosion of mechanical elements, or scouring, any of which can reduce functional performance and reliability. The effectiveness of the surface control system depends on the integrity of the hydraulic VCS control line and the control fluid, both of which are reduced due to the complications related to increased depth. (API 14B defines “control line” as the conduit utilized to transmit control signals to the surface-controlled subsurface safety valve. The “surface control system” is the surface equipment including manifolding, sensors, and power source to control the subsurface valve). Deeper-set surface-controlled SSSV systems have higher rates of reliability issues because the system itself is “bigger,” deeper, and therefore exposed to more hazards than shallower-set systems – as an

example, depth limits exist due to inability to overcome fluid mechanics and pressure drop in small-diameter control line tubing. Literature reviews summarized in Appendix 2 document lower reliability rates for deep-set systems.

2.2.1 Surface-Controlled Subsurface Safety Valve (SCSSV)

A Surface-Controlled Subsurface Safety Valve has its VCS above ground. Typically, the control system controls the SSSV with a hydraulic pressure line. If the control system senses an upset or becomes unresponsive, the SSSV internal spring closes the valve.

2.2.2 Subsurface-Controlled Subsurface Safety Valve (SSCSV)

A subsurface-controlled subsurface safety valve is a self-controlling valve. It is configured to close based on the differential pressure through the valve (where differential pressure can be associated with gas flow/velocity) or by pressure in the tubing (pressure type).

2.2.3 Subsurface Safety Valves Deep-Set

A deep-set SSSV (see Figure 1) is installed near the bottom of the well, generally thousands of feet below the surface.

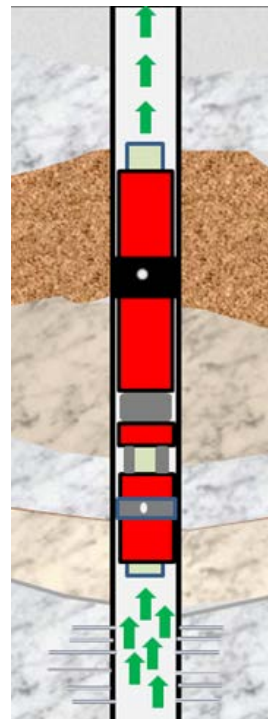

Figure 1: *Subsurface Safety Valves Deep-Set*

2.2.4 Subsurface Safety Valves Shallow-set

A shallow-set SSSV is installed below the wellhead but near ground level. Typical depth below ground level for a shallow-set SSSV range is within 200 feet of the wellhead.

Section 3. Application and Experience with ESV in Underground Natural Gas Storage

The following discussion examines the benefits and potential risks of SSSV.

Brief history

SSSVs are typically installed in offshore oil and gas production wells where there is a chance the wellhead can be broken off above the sea floor due to mudslides, dragging ship anchors, and tropical storms damaging drilling or production platforms or vessels. The subsurface valves are typically installed in the production tubing upon completion of the well, ~100 feet below the mud line.

Onshore, several North American natural gas storage companies installed SSSVs in a subset of the former production wells when the depleted reservoirs were converted to gas storage. These shut-off valves were generally installed less than 200' below the surface in the depleted reservoir wells and in a few aquifer storage wells near residential communities or high traffic roads. The valves are designed to fail closed upon loss of hydraulic pressure supplied by the VCS.

Natural gas storage operators carefully evaluate new installations of SSSV. As described in the operator testimonials located in Appendix 1, there are potential benefits from installing SSSVs but there are also operational impacts and a number of risks associated with the installation and operation of SSSV.

Benefits of SSSVs/DHSVs

SSSVs can be an effective means of significantly reducing the gas flow from a well if the wellhead is catastrophically damaged or severed or if a large leak occurs in the casing or tubing above the setting depth of the valve. As discussed in Section 2.2.3 and 2.2.4, an SSSV can be installed as a deep-set or shallow-set valve within well tubing, just below the wellhead, and/or in the casing above the casing perforations, several thousand feet below the wellhead. In a shallow-set installation, generally within 200 feet below the wellhead, the SSSV closes in the event the wellhead is extensively damaged or a tubing leak develops below the wellhead and above the SSSV. For the deep-set location (near the bottom of the well), the SSSV paired with a packer and a full tubing string could potentially isolate the entire tubing string if the wellhead is damaged or the tubing develops a leak. As most deep-set SSSVs are hydraulically controlled by a VCS, the maximum depth is often limited by the allowable hydraulic pressure at the SSSV.

The SSSV and the SSV are intended to function as consequence mitigation barriers, closing down flow from a well in the event of a large, even catastrophic leak. An "event" of significant magnitude or force must occur in order for the valve to activate; the event must cause a loss of control pressure or a substantial pressure, flow, or velocity change. Whereas casing and cement around the casing function as "passive" technical (physical) barriers to contain the gas at all times and with no special effort, ESV systems are technical control barriers that function only in the case of a triggering event. The distinction in barrier category is critical in order to understand that the functional purpose, reliability, and set point location of the ESV system limit its risk reduction capability to only those scenarios in which the ESV system would activate. However, since wells have limited means of shut-off in the event of a leak, ESV systems provide a means to perform a self-activated closure and thus ESV have risk reduction value in selected situations where flow from a well would be at high rate for an extended period and not be controllable within reasonably short time periods through other means. API 1171 requires that storage

operators evaluate the risk reduction value of ESV systems in each well and use the risk assessment to decide on use of an ESV system in any particular well.

While the operator testimonials in Appendix 1 represent well over 5,000 well-years of operation with SSSV, it is difficult to find cases where operators cite instances where the SSSV functioned in response to a legitimate triggering event.

Operational Impacts of deploying SSSV in Depleted Reservoirs and Aquifers

Per Section 2.2, there are two typical SSSV installation types and they have different impacts on operations. The first installation type is a tubing-conveyed SSSV installed in a tubing string, generally with a very similar cross-sectional flow area as the tubing. The second is a wireline-conveyed SSSV installed in the flow tubular, which sets the entire assembly inside the flow tubing and therefore has a smaller cross-sectional flow area than the tubing. The tubing-conveyed and the wireline-conveyed systems can be installed at various depths, although if the operation of the valve is surface-controlled, the depth of setting is influenced by the design and reliability of the control line and control fluid. Well operating pressure, flow fluid composition, flow tubing size, and other factors, in addition to the control line and control fluid, influence the setting depth restrictions for a Surface Controlled Subsurface Safety Valve (SCSSV). Natural gas storage operators, when using SCSSV, generally have installed the valves at shallow depths.

New wells planned with SSSVs and tubing have customized wellheads designed to support the connections and the weight of the tubing and the SSSV. The new wellheads contain fittings with bowls designed to suspend and secure the tubing hanger. Existing wells must be taken out-of-service to install tubing and SSSVs. Installing an SSSV on tubing in an existing well requires many steps to modify and add the connections necessary to support tubing and SSSV controls to the existing wellhead. Generally a new wellhead is required after obtaining the location-specific design. The existing wellhead must be removed and modified or replaced. Before removing the wellhead the well must be shut down and controlled (“killed”) to render it safe, then heavy equipment (a rig and related equipment rated for the forces expected during the well intervention/service work) is brought in to disassemble and remove the wellhead and install a blowout preventer (“BOP”). Tubing and SSSV assembly (with control lines) are installed in the well and the tubing is hung in the new wellhead assembly, which includes a tubing hanger and tubing valve. Note that this new tubing valve becomes the master valve controlling flow from the well when the flow is coming from the tubing only. Once the downhole installation is complete and pressure tested, the surface control system is connected and tested to ensure functioning of the SSSV in accordance with standards and specifications.

From that point forward, the SSSV and its controls will be tested annually, or more frequently if conditions warrant, to ensure proper operation. The well must be taken out-of-service during SSSV system removal, installation, testing, intervention, modification and repair and/or wellhead modifications related to the SSSV system. Natural gas storage operators must make risk-based decisions with respect to taking a well out of service if an SSSV fails a function test; the decisions are predicated on the values of safety, environmental stewardship, and storage service reliability.

Installing tubing and an SSSV within the well reduces the cross-sectional flowing area by approximately 50 percent, depending on the size of the tubing - if the tubing is half the diameter of the casing, the flowing area is reduced ~75 percent. The reduction in flowing area causes a pressure drop which could

reduce deliverability during critical periods from a negligible range to more than 50 percent, depending on the well flow capability and operating pressure range. If the flow deliverability requirements remain the same for a gas storage field, then new gas storage wells must be drilled to make up for the lost capacity. Each storage well operator must carefully evaluate the deliverability impact of tubing and SSSVs to ensure their fields can deliver the gas to serve market demand, including residential heating and power needs on a peak or cold, high-demand winter day, as well as on the last day of withdrawal, when storage field pressures are much less at the low end of seasonal inventory.

An SSSV installed in the tubing string adds operational challenges and safety considerations. The operator incurs additional risks to extricate the tubing and the SSSV from the well in order to perform the manufacturer-recommended maintenance to the valve or when the valve fails to properly operate or seal during testing. SSSV and tubing removal might require a snubbing unit, much larger equipment than the more typical wireline truck used to run tools, which increases risk to operating personnel charged with removing the valve when maintenance is required.

Casing mounted SSSVs are typically installed using wireline. In both cases the valve itself restricts the flow path, which can cause pressure loss which reduces deliverability, contributes to a buildup of paraffin or inorganic scales, increases maintenance demands for valve service, and causes unnecessary shut-ins when the valve closes prematurely or fails open, closed or partially closed.

Additional Risk Introduced by SSSVs

The risks introduced to a well associated with SSSV include the installation, malfunction and failure of the SSSV components. Adding SSSVs to existing wells requires shutting in the well, killing the well - usually by installing plugs and adding water to control well pressure - replacing the wellhead and installing the SSSV, often on a tubing/packer string. These steps, while manageable, expose the operator and environment to risks of uncontrolled releases. Well servicing exposes workers and nearby public to loss of energy in the event of well re-entry to remove and service a valve after an unintended closure or malfunction of the SSSV.

SSSVs can fail and/or function improperly due to a number of circumstances including but not limited to hydraulic leaks and contamination by solids, which impair the function of SV components. Surface controlled SSSVs have suffered from control failures, seal and tubing leaks and malfunctions which cause the valve to close. A tubing-retrievable SSSV is connected to the tubing and lowered in the well with a drilling or service rig. If a leak develops in the hydraulic control line or any of the seals, a drilling or service rig must be brought in to retrieve the SSSV from the well. Until a rig can be brought in, the well remains closed and unable to deliver gas. Every time the SSSV is removed from the well for replacement, repair, or servicing, some methane is vented to the atmosphere. While the gas loss quantity per installation is minimal, if SSSVs were required for all gas wells, then the gas loss volume would multiply by thousands. As SSSV have some well-established reliability ranges, the increased well interventions to pull the valve for well casing inspection or to service and repair the valve would increase methane emissions.

API 1171 recommends periodic inspection of the production casing integrity. Inspecting the casing involves the use of tools that make contact with the casing wall to detect the location, size, and shape of any defect that may be present. Many of the analytical tools available to perform detailed casing inspection require removal of the tubing, SSSV and packer isolating the tubing. Because SSSVs and

tubing are installed inside the well casing, they impede the entry and exit of analytical tools, such as well profile calipers, into and from the well. This impedes an operator's ability to proactively assess the integrity of the well via casing inspection and flow logging/detection programs. In order to maintain surveillance of the condition of the casing, casing inspection tools and flow detection devices can be run inside a "casing" completion, and follow-up surveys can be directed to various frequencies depending on the findings of a survey or depending on a combination of other factors that recommend for inspection. An SSSV/tubing string installation increases the cost and complexity of casing condition monitoring.

SSSVs do not arrest all leaks. A shallow SSSV installation does not shutdown the flow of gas through a deep casing breach occurring below the set point of the SSSV. Shallow SSSVs are only designed to limit the amount of escaping gas in a catastrophic surface event. The closure mechanisms might not actuate in the event of a steady but small leak that does not meet some threshold of pressure or flow differential or velocity.

SSSVs are not completely gas tight over time due to the normal yet relatively harsh operating conditions in many storage well situations. The sealing surfaces can be exposed to the flow of gas, water, and other components such as sand. A scratch of just a few thousandths of an inch may prevent a flapper or ball SSSV from achieving a complete seal. The SSSV can still be effective in minimizing gas loss in an extreme abnormal event. Specifications such as API 14B define an allowable leakage rate that must be carefully reviewed for practicality as it would not make sense to extract a SSSV hundreds to thousands of feet below the earth's surface for a trace leak that is only detectable during a test when the valve may be in very good condition and fully capable of arresting nearly all of the flow in a catastrophic surface issue.

SSSVs prevent the installation of a full size plug in the well, impeding resolution of a potentially hazardous situation or significant leak event. SSSVs, regardless of where they are installed, are only effective in limiting a leak that is located above the SSSV. However in the very unlikely event that a downhole leak occurs, the SSSV reduces the operator's ability to deliver an effective treatment because repair tools must be small enough to fit through the SSSV without getting caught in the length of the SSSV profile. Generally, for efficient well intervention and isolation in a leak event, restrictions inside the casing could and often do need removal. Deep set subsurface safety valves increase risk of problems and prevent the operator from setting a plug to control a well unless an additional packer is set beneath the point where the SSSV is set; such an arrangement retains a risk due to time and complexity for extraction of the tubing string and SSSV, relying on the lower packer plug to hold for a long period of time and hoping that no problems occur with the extraction or re-insertion.

Cost of SSSVs in Depleted Reservoirs and Aquifers

Two of the operator-authors of this Appendix developed independent estimates of installation and servicing costs related to ESV systems, particularly SSSV, and associated costs for a full tubing string on an isolation packer and wellhead accommodations; the operators also estimated the cost of drilling new wells and equipping those wells with SSSV on full tubing strings. The operators developing the estimates represent nearly 2000 natural gas storage wells and 40 gas storage reservoirs, a wide range of pressure, depth, flow potential and geographic location. The cost estimates of each operator's independent determination compared favorably and so the summary below represents the range found by both analyses.

There are five major costs associated with SSSVs: the cost of the valve, the cost of installation, the routine operations and maintenance (O&M) costs relating directly and indirectly to the presence of an SSSV system, the life cycle costs of the SSSV system itself including capital replacement costs, and the cost of additional facilities because of the loss in throughput and other risk and risk treatment interdependencies.

The direct cost of an SSSV depends on size, and typically ranges from \$15,000 - \$140,000. The total estimated installed cost for a SSSV/full tubing string and packer in a 7" production casing string is ~\$250,000 per well, with a wide range - greater for deep wells and lower for shallow wells. Considering that there are approximately 12,000 to 14,000 gas storage wells in the United States without tubing/packer and SSSVs, the cost for installation in all wells would be on the order of \$2 to \$4 billion. Operations and maintenance costs could average \$2,000 per well annually, for a range of \$25 - \$50 million for basic maintenance added across the gas storage industry. The life cycle cost could be significant based on reported reliability of the valves. Some wells may require workover or snubbing rigs and multiple valve replacements over a 100-year well lifetime at an estimated total industry cost of \$10 billion, or roughly \$100 million annually.

The cost for replacement of lost capacity resulting from the installation of tubing, packer, and the SSSV can be represented by the cost of drilling additional wells. New well drilling requirements depend on a number of factors and how those factors contribute to deliverability and/or service reliability impairment if SSSV on full tubing strings were installed; the impact factors include well depth, pressure, flow potential, and the significance to the amount of cross-sectional flow area restriction along a length of the well. The new well drilling analysis assumed that horizontal drilling techniques would be used to provide the service restoration. The analysis yielded an estimate in the range of 1,000 to 5,000 new wells that could be required to replace the lost deliverability resulting from installation of SSSV on tubing. The well replacement cost range is estimated to be between \$2 and \$10 billion.

SSSVs in Salt Cavern Storage Wells

Salt cavern gas storage facilities have been developed for gas storage. These underground facilities tend to be 1970s-2010 vintage facilities and were developed using new drilling and well completion techniques, utilizing multiple concentric large diameter casings, ranging from 16 inches up to 42 inches, whereas the traditional production wells are less than 10 inches in diameter. The cavern wells have a minimum of two barriers into the salt. Wellhead shut-off valves are installed on every well. Emergency Shutdown Valves (Surface Valves) are required by API 1170 and CSA Z341.2. Surface valves enable the operator to isolate both the gas well and the gathering piping system. Because SSVs are above ground, they are easier to inspect and maintain as compared to subsurface valve systems. The stroke and operation of the valve can be observed directly by the technician and adjustments can be made when deemed necessary. Service ports and grease fittings are readily accessible and can be serviced annually with minimum effort or special tools.

Comparison and Contrast of SSSV and a SSV

Both SSSV and SSV are comprised of multiple components to ensure that they fail closed when needed. As depicted in Figure 2, the SSSV offers a narrow flow path (light green) whereas the SSV ball valve shown to the right is full opening (steel ball port is the same size as the piping) causing virtually no

restriction. The SSSV must be removed to be serviced. Above ground valves can be readily serviced, in many cases without impeding the flow of gas.

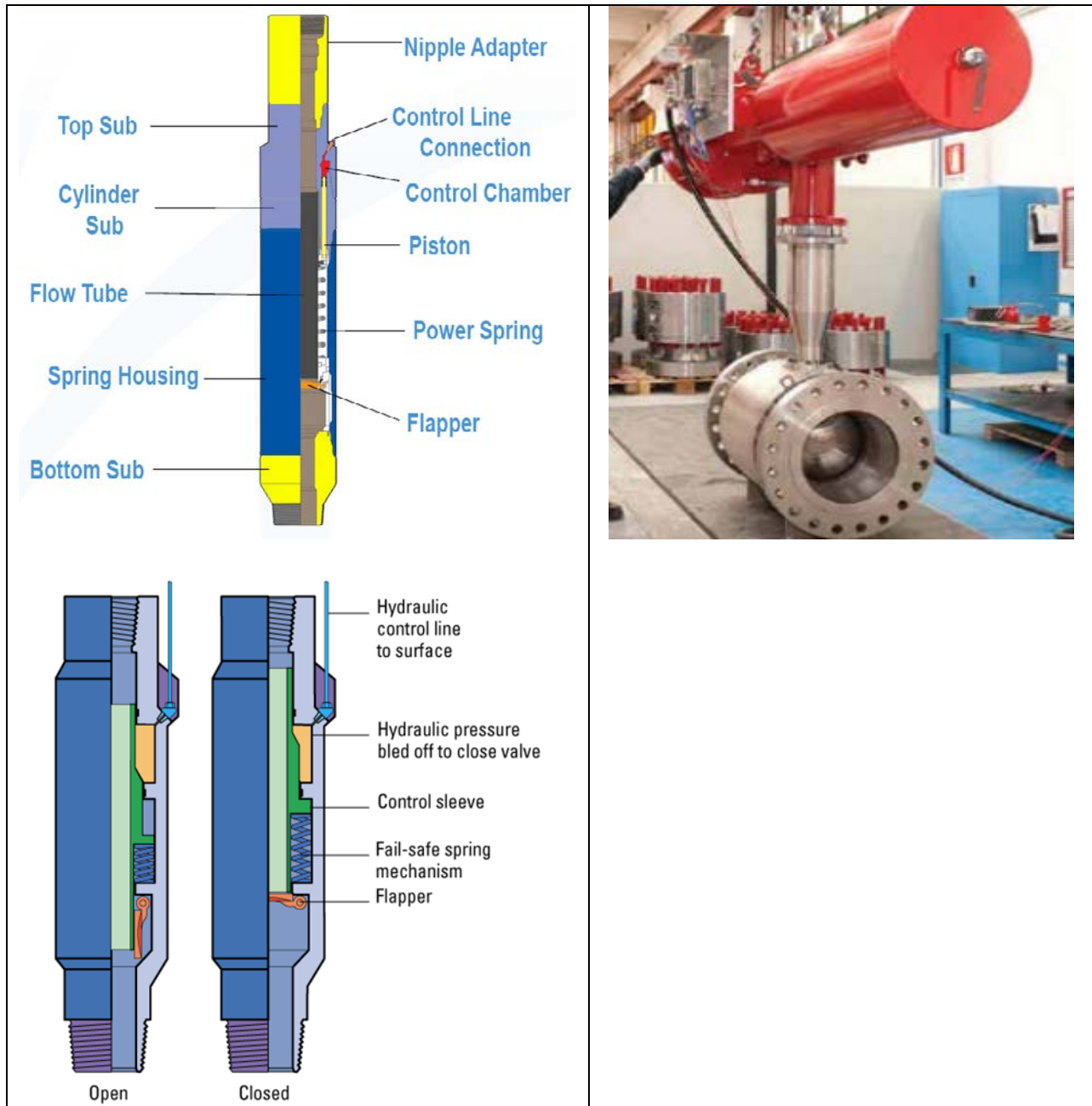

Figure 2. (Left, top and bottom) Subsurface Safety Valve profile (flapper type), and (right) Surface Safety Valve (ball valve type). (Figures courtesy of Baker Hughes)

ESV Reliability - Company Operating Experience

Five storage operators shared their experiences of operating wells with various ESV systems. The dataset from these five operators represents nearly 200,000 well-years of total storage well operation, and over 5,000 well-years of ESV system operation, most of it downhole safety valve system operation.

Appendix 1 contains each operator's more detailed discussion of the experience, the risk assessment used, the reliability and safety issues involved, and the performance impact of subsurface safety valves in particular.

The storage operators represented in Appendix 1 provide some quantitative reliability information: safety valve function test and operating failure rates are in the 0.01-0.03 failures per well-year range – note that this failure rate is inclusive of all causes of failure, not just the mechanical failure of the valve mechanism itself.

Re-entry-and-removal/replacement rates for subsurface safety valves are in the range of 0.1-0.2 entries per well-year, a rate that is composed of entries for SV inspection and repair, entries for test/function failures, and entries for casing inspection.

Flow and function reliability issues related to downhole safety valves include hydrates, salt, or paraffin bridging in the safety valve assembly, or function test failures due to the same types of bridging agents fouling the flapper closure mechanisms. The corrective maintenance issue, or reliability issue, rates are in the range of 0.15 per well-year of operation. However, the annual corrective maintenance rate varies with storage field/well use and winter severity. Corrective maintenance actions include flushing with solvents such as water, methanol, or heated diesel oil, and in many instances these are successful in restoring flow and proper valve function.

Some storage operators report substantial flow restrictions due to subsurface safety valve installation. High deliverability well flow can be adversely impacted by restrictions in flow diameter along the length of the tubing string on which the safety valve is run. The decrease in flow due to the tubing and subsurface safety valve system could cause the operator to drill more wells to replace lost service reliability. Additional tubing, packer, and safety valve systems could increase the number of well re-entries due to known reliability rates related to mean time to repair/mean time to failure for tubing, packer, safety valves and additional wellhead components.

Storage well applications of ESV and related equipment, loss of containment rates, well component failure rates and inter-dependent risk

In 2011, a survey of ESV systems in non-cavern storage wells solicited storage operators to provide voluntary responses to a number of questions, including whether the operator used any type of ESV system (surface or subsurface) on any wells in their storage assets, the criteria used for decision-making on application of ESV systems, and whether the operator was evaluating use of ESV systems of any type in the future.

The survey yielded responses from 22 storage operators representing more than 8,500 wells, or about half of all storage wells in North America. Approximately 30 percent of the operators did not use any ESV system in their wells, but approximately 11 percent of all wells represented in responses had some

type of ESV system and some wells had both surface and subsurface systems. Overall, only four percent of wells represented in the survey had subsurface safety valve systems.

The reasons for ESV system use included well flow potential in ~27 percent of cases, well pressure in 18 percent of cases, proximity to receptors in 27percent of cases, loss prevention in 27 percent of cases, and other or no reason given in 23 percent of cases (some respondents cited multiple reasons thus the percentages do not total 100 percent). Only two of 22 respondents indicated they were considering additional ESV system installations and were using risk assessment to make the decisions.

In addition to the storage operator shared information, Appendix 2 contains summaries of several Society of Petroleum Engineers papers regarding reliability of safety valve systems.

The authors also referred to the March 2005 report to the Gas Research Institute under Contract No. 8604, Project No. 809833, "Risk Assessment Methodology For Accidental Natural Gas and Highly Volatile Liquid Releases From Underground Storage, Near-Well Equipment," prepared by Glenn DeWolf, Katherine Searcy, Douglas Orr, and Christopher Loughran on behalf of URS Corporation.

The discussion of ESV systems and their applicability and reliability necessarily involves a discussion of the reliability of the entire well system and the inter-dependent nature of physical components and human interactions in the analysis of risk. Loss of containment rates and reliability rates obtained from the compilation of sources is summarized in Table 2 and contains a summary of well and selected well component failure rates. Reliability rates for tubing/packer systems and wellhead systems are included in Table 2 along with casing, cement, and loss-of-containment during drilling or service intervention ("workover") since all components and work types represent failure paths leading to potential loss of containment events.

Table 2. Summary of Well and Selected Well Component Failure Rates, Reliability Rates, and Impact Analysis

case	min	max	mean	source
loss of containment, drlg - "known areas", per well	0.0002	0.0003	0.00025	compilation, industry data
loss of containment, workover, per well	0.00007	0.0004	0.000235	compilation, industry data
loss of containment, re-entries, per re-entry	0.0000891	0.000341	0.000215	URS (2005)
loss of containment, re-entries, per re-entry			0.000680	Durham and Pavely (SPE #56934)
tbg/csg fail, per well-yr			0.0000034	Busch, Policky, Llewellyn (1985)
tbg fail, per well-yr			0.002	Busch, Policky, Llewellyn (1985)
wh fail, per well-yr			0.000012	Busch, Policky, Llewellyn (1985)
cement - failure per well-yr			0.000064	URS (2005)
casing (no cement) - failure per well-yr	0.000016	0.000029	0.000023	URS (2005)
csg fail (2 or 2+ barrier - csg, cmt, etc), well-yr		0.000015	0.000007	one storage operator testimonial
well fail with shallow set SCSSV - per well-yr			0.000049	URS (2005)
well fail with shallow set SCSSV - per well-yr	0.00006	0.00008		Moines and Iversen (1990) OTC #6462
Surface SV fail, per demand			0.000000071	URS (2005)
Subsurface SV failure, per demand	0.000004	0.000020		URS (2005)
SSSV functional failure/repair per well-yr	0.01	0.03		Storage operator experience

SSSV functional failure/repair per well-yr	0.02	0.03	Durham and Pavely (SPE #56934)
SSSV functional failure/repair per well-yr			Moines and Strand (SPE #63112) - 1999 MTTF
tubing-packer systems - repair/re-entry per well-yr			0.027 one storage operator testimonial

The authors of this Appendix estimated the current storage industry usage rates of ESV systems and tubing/packer systems based on the industry surveys referenced above and informal discussions and personal communications. The first few lines of Table 3 show the estimate that three to five percent of natural gas storage wells have SSSV and 10-25 percent of natural gas storage wells have a full tubing string set into an isolation packer.

The authors estimated the impact to service reliability and well service intervention rates if the use of SSSV and tubing/packer systems were applied to all natural gas storage wells, in order to demonstrate the inter-dependent nature of well component reliability and well intervention risk. The authors estimate that the widespread installation of tubing/packer and SSSV would result in a service reliability replacement demand that could result in a five to 25 percent increase in the number of storage wells. The total impact of all SSSV and tubing/packer installations is summarized for both existing wells and potential new well additions to show that there would be a likely impact to more than 16,000 storage wells. The remaining rows of Table 3 show the authors' estimates of failure rates of the components and failure rates due to well servicing loss of containment. The risk of loss of containment is increased by the count rate addition due to installation multiplied by the re-entry rate due to component failure, multiplied by the loss-of-containment rates during well intervention.

Table 3. Impact Estimate

		min	max
Number of storage wells, approximate (AGA Underground Storage Survey 2013)	17600		
Estimated percentage with SSSV (Author estimates)	4	3	5
Estimated wells with SSSV (Author estimates)	704	528	880
Estimated percentage with tubing-packer systems (Author estimates)	13	10	25
Estimated wells with tubing-packer systems (Author estimates)	2288	1760	4400
Estimated percent well additions for tubing restrictions to restore and maintain deliverability and capacity (Author analysis estimate)	10	5	25
Estimated well additions (percentage in line above converted to a number) (Author analysis estimate)	1760	880	4400
Added SSSV and tubing/packer systems (if "all wells must") (Author analysis)	14608	15312	12320
Including new wells (if "all wells must") (Author analysis)	16368	16192	16720
Minimum re-entry rate per well-yr SSSV+tbg/pkr system MTTR (Author estimates and company testimony)	0.037		
Increased re-entries, minimum estimate, per year (min) (Author estimates)	606	599	619
Maximum re-entry rate per well-yr SSSV+tbg/pkr system MTTR (Author estimates)	0.062		
Increased re-entries, maximum estimate, per year (max) (Author estimates)	1015	1004	1037

Loss of control, well re-entry (high value, Durham/Pavely)	0.00068		
number of wells re-entered for MTTR (max) (Author estimates)		1037	
expected number of loss of control incidents, per year, for wells re-entered for SSSV/tbg reliability (HIGH VALUE) (Author analysis/estimate)			0.705
Loss of control, well re-entry (low value, URS)	0.000215		
number of wells re-entered for MTTR (max) (Author estimate)		599	
expected number of loss of control incidents, per year, for wells re-entered for SSSV/tbg reliability (LOW VALUE) (Author estimate)			0.129

The authors summarize from Tables 2 and 3 that while SSSV systems can decrease risk in a loss of containment event, a greater application of subsurface well components and the inter-dependencies of equipment reliability rates and well intervention loss of containment rates would nullify the risk-reduction benefits of SSSV and could increase the risk of loss of containment.

Section 4. Standards and regulations applicable to the use of ESV

The natural gas storage industry integrity management in North America is guided by several standards. API 1170 - Design and Operation of Solution-mined Salt Caverns Used for Natural Gas Storage, and API 1171 - Functional Integrity of Natural Gas Storage in Depleted Hydrocarbon Reservoirs and Aquifer Reservoirs, were published in 2015.

API 1171, in Clause 6.2.5, specifies that operators evaluate the need for an emergency shutdown valve in wells using as a minimum set of variables: distance from dwellings, potential dwellings, or outside areas where people frequent or congregate, fluid composition and maximum flow potential, distance from wellheads and other surface equipment, site access availability for remedial and emergency equipment, proximity to public transportation or industrial facilities, the current and future/expected state of development in the area, regional topography, drainage, and environmental considerations, and the added risk created by installation and servicing requirements relative to the ESV system and alternative protection/mitigation measures.

API 1171 specifies minimum annual shutdown valve system function testing and requires that a closed ESV system be manually reopened at the site of the valve after an inspection and not opened from a remote location.

API 1170 has a number of requirements for surface emergency shut down valves (ESD). Clause 8.4.1 of API 1170 requires ESD equipment during cavern development when solution mining under gas, re-watering, or de-brining. All flow courses from the wellhead to the production lines are required to have ESD, and the ESD should be connected to the SCADA system for control and monitoring (Clause 8.5.2). The ESD valve must be installed at or near the wing valve off the wellhead (Clause 9.2.2). Finally, Clause 9.4.4 covers periodic testing recommendations, which includes tests of all components of the system.

In Canada, the Canadian Standards Association (CSA) Z341 series apply (Storage of hydrocarbons in underground formations). In CSA Z341.1-14, Reservoir storage, an ESD valve is required if the operator determines the need as a result of a risk assessment (as per Clause 7.1) or if very close to a building designed for occupancy. The applicable radius of impact equation makes a simple relationship of

pressure and well casing diameter to the radial distance from the building (see Clause 9.3.2.1). The radius-pressure-casing size relationship is based on an assumption of worst case well flow capacity, ignition of the gas, and a heat flux of 5.0 kW/m² representing a 30-second burn threshold, as per the Gas Research Institute project GRI-00/0189.

API 1171 and CSA Z341.1 are very similar in the risk assessment consequence criteria; Z341.1 requires evaluation, in addition to proximity to potentially occupied buildings, of proximity to adjacent wells and other surface developments, the number of wells connected in common to surface pipe networks, the reaction time of the operator to shut in wells, and the storage capacity of the facility.

CSA Z341.1 requires that when an ESV system is used a valve must be installed on each flowline to the wellhead and as close as possible to the wellhead, pressure rated to maximum operating pressure of the well-pipe system, fail-closed and capable of position monitoring, remote and local operation, and automatic activation. If a subsurface safety valve is installed, it must be function tested twice per year and repaired or replaced if the function test fails. Greater function test frequency is recommended when operating conditions include corrosive agents, fouling/depositing/scaling agents, or the valve experiences large variations in temperature and pressure. Z341.1 also requires testing of the ESV control system once per year, including instrumentation, valving, shutdowns, wiring connections, and circuit integrity and closure times (Clause 10.2.2).

CSA Z341.2-14, Salt cavern storage, is similar to API 1170 in its requirements for salt cavern well ESV systems. Clause 9.3 has the same location and operability requirements as in Z341.1, but adds that closure times should be set to minimize hammering and that activation can occur by over-pressuring or under-pressuring of the hydrocarbon system, over-pressuring of the brine system, and high hydrocarbon temperature.

Material, Installation, and Service Specifications

API 14A (ISO 10432), Specification for Subsurface Safety Valve Equipment, provides functional applications compatibility, technical specifications for design, materials and manufacturing requirements, repair and redress, and shipping, storing and handling. The 14A Annexes cover testing, validation, and verification requirements.

API 14B (ISO 10417), Design, Installation, Repair and Operation of Subsurface Safety Valve Systems, covers system configuration, equipment, documentation and data control. The Annexes cover redress, installation, operations, sizing of the system, testing, and failure reporting. API 14B covers acceptable leak rates when performing function tests.

API 14C addresses surface safety systems on offshore production platforms.

API 6AV2 superseded API 14H and treats surface safety valves and underwater safety valves.

General Well Integrity / Integrity Management Systems

ISO 16530-1, Petroleum and natural gas industries — Well integrity — Part 1: Life cycle governance, was published in 2015. ISO 16530-1 identifies an SSSV as a possible well barrier (Clause 4.7.3.4). ESD/SSV should be tested in accordance with API 6AV2 (Clause 4.9.2.2).

ISO advocates definition of Safety Critical Elements (SCE); all parts of an ESD system are to be considered SCE (Clause 6.4.5) and increased maintenance frequency is recommended, along with documentation. In ISO 16530-2, Clause 15.4.2, notes that higher frequencies of function testing of SSSV can reduce problems found when verification testing is performed.

Operating limits and verification tests are to be operator-defined; Clause 5.6.2 includes considerations for SCSSV such as setting depth, control line actuation pressure, and well conditions.

ISO 16530 Appendix F provides a description of surface and subsurface safety valves (ESD), their function, and possible failure modes. A surface safety valve, the function of which is to provide shutdown and isolation of the well to production process/flow lines, can fail due to malfunction, mechanical damage, control line pressure problems, incomplete closure or unacceptable leakage. For a surface controlled subsurface safety valve, the function can fail due to lost communication with the control line, leakage above acceptance criteria, failure to close on demand or in an acceptable amount of time, mechanical damage, or other malfunctions. ISO cites the API 14B threshold acceptable leak rate as 15 SCF/min for gas (approximately ~22 Mscf/d).

Regulations

The authors are not aware of any state oil and gas regulations that require the use of downhole safety valves in onshore wells. Surface safety systems, including emergency shut down valves, are required in cavern storage operations in a number of states. In the US and Canada, cavern storage operations need surface safety systems, including emergency shutdown valves, and the requirement is embodied in the industry recommended practices of API 1170 and CSA Z341.2.

The Bureau of Safety and Environmental Enforcement (BSEE) regulations (Title 30, Chapter II, Subchapter B, Part 250, Subpart H, §250.801) require offshore production wells capable of flow to have downhole safety valves and platform safety systems, including emergency shut down systems.

- 250.801 (c) stipulates a preference for surface-controlled subsurface safety valves installed in a tubing string and requires that such a valve be installed when the tubing is next serviced.
- The depth of the valve must be at least 100' below the mud line.
- The need for a safety device in offshore wells is due to lack of accessibility to the well and the hazards of the offshore environment. Where a subsurface safety valve is not installed, the well shall be attended "...in the immediate vicinity..."

BSEE 250.802-250.808 addresses surface safety systems, which must be installed on all production facilities offshore. The regulations address design, installation, testing, quality requirements for closure times and leak rates, and other related performance factors, including personnel competence, training, and attentiveness to the safety systems.

In summary, regulations requiring emergency systems inclusive of surface or subsurface safety valves exist today in settings where risk of loss of containment is elevated due to:

- High consequences of failure, including rates of flow and radius of impact, fire potential, and escape capability of workers or the public;

- Discharge into water, air, or land is difficult to confine and contain within a limited space;
- Accessibility and timeliness of human intervention emergency response services is hampered due to well location;
- Impact to other infrastructure could create cascading events; and
- Hazards are difficult to anticipate and manage, and such hazards might include forces of nature, high pressure, high temperature, flow stream composition, rate, and extended volume potential, and duration of a loss of containment after a loss of containment event occurs.

Section 5. Risk management and decision-making

Section 8 of API 1171 requires that operators develop risk management processes with risk source identification, risk analysis, evaluation of risk and the ability to control risk by implementing risk treatments such as preventive, mitigative, and monitoring programs or well remediation. API 1171 requires that storage operators perform periodic review and reassessment of the risk management process.

API 1171 requires operators to assess the risk of gas containment failure due to a number of causes including inadequate mechanical isolation caused by time-independent design features, construction/as-built features, material defects, material deficiencies and misapplications (inappropriate casing joint thread design, for example), or time-dependent decay of barriers due to corrosion, erosion, cement/cement bond degradation or disbondment, valve failure, gasket failure, etc.; loss of control while drilling, completing, or service interventions; third party actions; natural forces of earth systems – weather, ground movements, floods, etc.; and other causes.

Operators are advised to rank and prioritize risk and establish programs that prevent events by reducing the likelihood of the causes of gas containment failure and mitigate the consequences of a loss-of-containment event.

Throughout API 1171, operators are advised to use risk assessments to inform decision-making related to many integrity management practices.

CSA Z341.1 requires risk assessment (Clause 7.1) and provides guidelines for risk assessment in Appendix B. Similar to API 1171, CSA Appendix B emphasizes the use of risk assessment in decision-making regarding design, well construction and completion, location, operations, maintenance, monitoring, plugging, and site restoration.

ISO 16530-1 provides guidance on relating well integrity program task frequency to the risk identified in the operator's risk assessment.

Objectives and Contexts

The risk management process is a decision-making process. The first step requires clarification of objectives set into the external contexts of the operator's environment and the internal context of each operator's company.

The primary objectives of each and every storage operator are 1) protecting human life, both of the public at large, locally in immediate areas of impact, and workers engaged in operations and support operations, 2) providing reliable service, 3) stewardship of the environment, and 4) the protection of property and financial resources. This four-fold aspect sets the fundamental, values-driven part of the gas storage operations objectives.

The operator defines the internal and external contexts of their storage operations and site specific contexts, the risk analysis method to use and the decision criteria.

Risk Source Identification

Operators identify the sources of risk – hazards, threats, and hazardous situations – that could affect the storage wells; then the operators identify the barriers and controls in place that prevent the risk sources from activating into events or that mitigate the consequences of events. Tables 1 and 2 in Section 8 of API 1171 provide a template of hazards and barriers/controls for operators to use when assessing site specific and company-specific risk sources and risk control programs.

Risk Analysis

Risk analysis estimates the likelihood of well failure and the likelihood-severity range of consequential impact.

The literature survey summarized in Appendix 2 provides ranges of well component failure modes and rates with and without ESV systems. Fault tree analyses in several studies have indicated up to an order of magnitude reduction in failure with subsurface safety valves installed, although when adding in the workover rates due to safety valve reliability, the overall rates of loss of containment with and without safety valves can be in the same order of magnitude.

The historical rate of significant well failures during operation is in the E-05 per well-year range, while loss-of-containment during well interventions is in the E-04 to E-05 range (per well entry). While the use of safety valves in the downhole environment can reduce likelihood of some failures if they occur uphole or downstream from the safety valve location, the failure rates with and without safety valves are in ranges described qualitatively as very unlikely (E-04 to E-05, as defined for hazardous process facilities by the Center for Chemical Process Safety (CCPS), American Institute of Chemical Engineers (AIChE); CCPS order of magnitude event frequencies align to qualitative descriptors: “extremely unlikely to remote” is $<1E-05$, “very unlikely” is in a range $1E-05$ to $0.99E-03$, “unlikely” is in a range $0.99E-03$ to $0.99E-02$, and “likely” is $>1E-02$).

The failure likelihood for which a subsurface safety valve is designed to protect against is “very unlikely,” so that when the consequence potential also is small, the estimated risk without a subsurface safety valve almost surely will be acceptable, or tolerable with risk controls other than subsurface safety valves.

A storage operator can evaluate the likelihood for a well to have a loss-of-containment event on the basis of the well’s as-built condition, including the number and quality of barriers such as casing, cement, or shut-off devices; on condition assessments of those barriers against operating conditions (casing integrity logs and the recency of the information, cement integrity logs, annulus pressure

observations, pressure tests, function tests); maintenance, monitoring, and inspection of primary barriers and well conditions; and frequency and reasons to enter (intervene in) the well.

In events where safety, environment, and service reliability could be threatened, operators often take a precautionary approach – which says that when the chance of something happening is increasingly remote but the severity of the impact is potentially large, a cautious approach should be taken. The precautionary approach can be invoked when there is a need to focus the risk analysis on the consequence potential because of the number, density, and/or critical importance of potential receptors. Operators can identify receptors in a potential impact area and estimate the potential impacts those receptors could experience should a loss of containment event occur at a well. Operators can assess conditions which affect the likelihood of failure events and their escalation: the as-built condition of the well, the number of containment barriers and their state of integrity, the extent and competency of integrity monitoring, maintenance, testing, and verification plans, as well as the extent, competency and response capability of emergency action plans.

Consequence impact severity of a loss of containment event can be related to storage field or well deliverability at a casing-constrained open flow rate, the well count in a storage field, and each well's flow potential. Service reliability impact can be related to the consequence of taking the well and/or field out-of-service or changing the mode of operation due to an event. Safety consequences can be related to population density and proximity; environmental consequence impacts can be related to proximity to sensitive areas and the containment capability of an event's emission of fluid during/after an event.

Literature review indicates that distances of 75-100 feet (~30m) or less render high risk estimates for well failure impact on receptors, although the impact radius is dependent on the well's flow capability (SPE #145428, Powell and Van Scyoc, "Well Site Screening: The Critical Few" – see Appendix 2 for a summary). If a well has any significant pressure and flow capacity, there is potential to adversely impact people, property, and the environment within such a close range. Operators can analyze consequence impact severity for gradually increasing distances away from a well, basing the analysis on flow rate, potential duration, fluid composition, noise, odor and heat/fire potential.

Downhole loss of containment represents a specific failure scenario. Operators can estimate impact radius and severity related to downhole loss of containment and potential migration in subsurface zones. Subsurface migration potential can be related to production casing and cement quality and isolation capability, the presence of permeable pathways in the uphole geologic strata, and the pressure and volume drive from the well and reservoir.

The population density around a well and workforce engagement in activities at/in a well must be assessed. Population density and proximity can be assessed at two levels – within an operator's assessment of immediate and/or potential impact radius, and at a wider radius which might be affected under specific circumstances of a release, such as those with a long duration, significant release volume, and widespread impact due to noise, noxious odor, or underground release and transport. The radius of impact is generally taken to be a circular area, with the immediate impact radius defining an area where isolation and removal or close monitoring of receptors is necessary – an "immediate/initial isolation zone" or "IIZ." A potential impact radius is an area that could be impacted if changes in the circumstances of an event cause an escalation of the event; such circumstances could include duration, flow, secondary effects such as fire, odor, liquids, external effects such as atmospheric and weather conditions, and changes in receptors during the course of the event. The potential impact radius can be

termed an “emergency planning zone,” or “EPZ.” An even wider radius of potential impact can be termed an “emergency awareness zone,” or “EAZ,” which is an area that could be impacted in specific events that include long duration, significant release volume, and widespread impact due to noise, noxious odor, or underground release and transport. During a specific event, conditions could be such that a protective action zone (“PAZ”) is determined for time- and condition-dependent factors, such as wind direction. The PAZ can change as influencing factors change, which requires operator awareness and incident command and control to set and communicate the emergency zones. The concept of a PAZ is that receptors inside the EPZ and/or EAZ might need specific protections or evacuations under special circumstances during a storage well release event. Storage operators can define the IIZ, EPZ, and EAZ, as illustrated conceptually below, for wells or groups of wells in their storage fields and describe in their emergency plans how these zones are determined.

Figure 3. Schematic of Storage Well Emergency Planning Zones. IIZ = Initial Isolation Zone, pre-defined; EPZ = Emergency Planning Zone, generally pre-defined and may expand to the EAZ = Emergency Awareness Zone. PAZ = Protective Action Zone, determined for time- and condition-dependent factors (wind, topography, etc.)

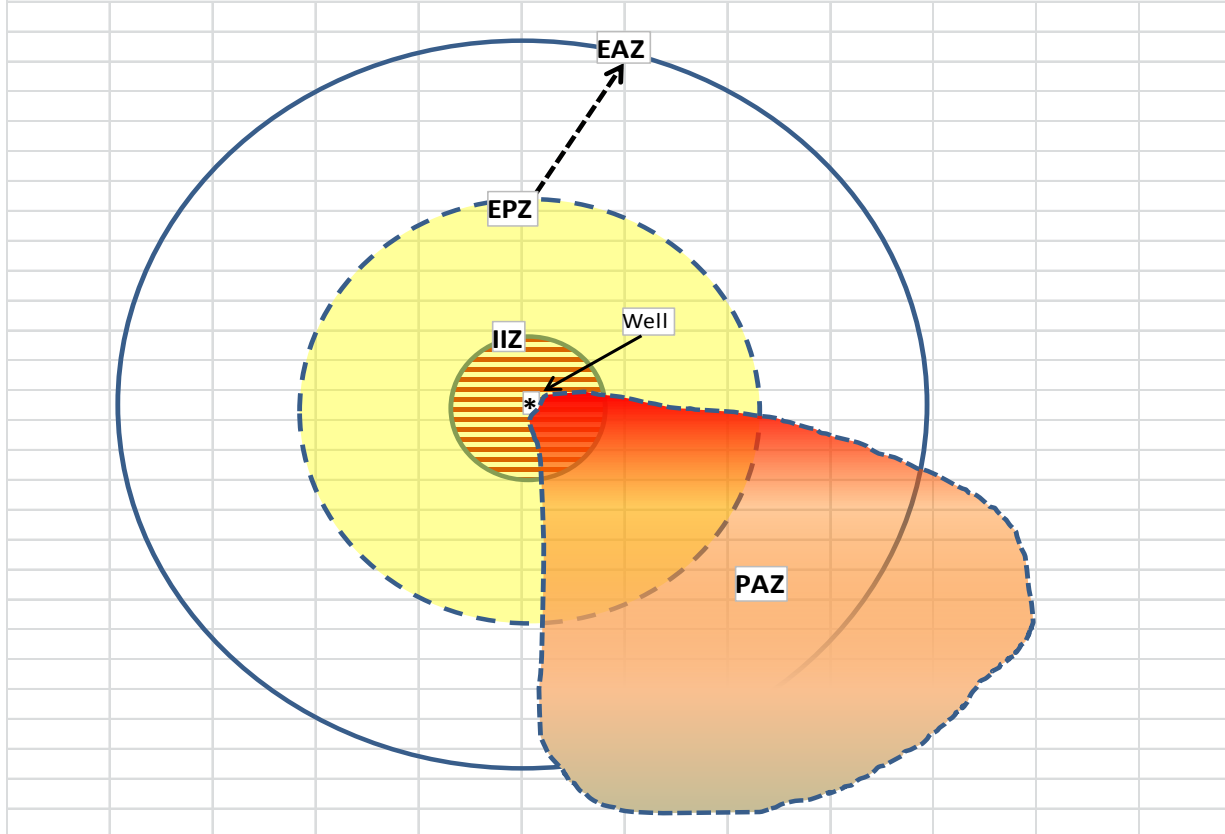

Site access for remedial and emergency equipment is a factor in the risk assessment. The ability to limit the consequences of a loss-of-containment event is evaluated by the operator on the basis of the emergency response plan quality (including training and readiness of the operator’s employees and contractors), the means of timely alert to or awareness of abnormal operating conditions at the well level (which requires the setting of well operating limits for pressure, flow, temperature, and annular conditions and then monitoring with those limits in mind), the ability to control the well via interventionist means (rather than by component means such as automatic or manual valves or reliefs),

and the time required to respond to an abnormal condition or a loss of containment condition and bring the well integrity back to a state of gas containment.

The added risk created by installation and servicing requirements relative to well equipment, such as the ESV system, should be analyzed. The installation of a subsurface safety valve carries a burden of well intervention to service the valve when it fails. The failure rate for safety valve systems can be estimated from operator testimonials and literature review. Much of the literature uses a data set from the offshore world. The operator testimonials add to existing literature and establish ranges of reliability and well re-entry frequency in the natural gas storage world.

Evaluation of Risk

The storage operator's evaluation criteria is used to rank and prioritize wells identified as having significant risks in the analysis step, and if necessary a further analysis and comparison can be conducted for decisions on use of an ESV system or alternative risk controls.

Storage operators have made many decisions regarding the installation and maintenance of ESV systems. Consensus decision-making has seen very few new installations of subsurface safety valves but somewhat a trend to replacing subsurface valves with surface safety valves. Operators have made decisions on ESV system use in complex, well-specific applications given the full range of site-specific risk inputs set against objectives of protecting people, property, and the environment, and protecting the workforce that must engage in well interventions and maintain service reliability.

It is the nature of risk management decisions that uncertainty remains after decisions are made. Storage operators can monitor the reliability of their storage wells, particularly those wells that have a surface or subsurface safety valve. Reliability information could be shared among operators in a uniform, consistent format so that a body of information could be assembled for learning and continual improvement in safety and reliability. The factors to which the risk analysis is most sensitive might be clarified, and, where appropriate, those same factors could be subjected to reliability improvement techniques.

Risk Treatment Alternatives

ESV systems are designed to activate in the event of a loss of containment or abnormal condition of flow, pressure differential, or variation in control energy. ESV systems are consequence mitigation devices and their effectiveness and value can be compared to alternative risk reduction measures.

The likelihood of a loss of containment event can be reduced by decreasing event initiator potential and/or increasing the redundancy of preventive barriers. The potential consequences of a loss of containment event can be reduced by employing mitigation barriers that reduce the duration and/or magnitude of the event. This section describes a number of alternatives to risk reduction. Operator data can be collected and analyzed to assess the effectiveness of alternative risk reduction measures, the reliability of risk reduction systems, and any new risk that might be introduced by each alternative.

Preventive Measures

Storage operators can employ protections to wellhead or near-wellhead pipe to prevent access and prevent vehicular collisions and animal and human interference. Surface methods can include installation of SSV on the wellhead or at the wing of the wellhead.

Operators could add downhole barriers or increase the robustness of existing downhole barriers if feasible, in order to add layers of protection so that if one barrier decays or fails, a second barrier exists to prevent loss of containment. Figures 4 and 5 show the concepts of barriers and the risk reduction by use of redundant barriers. Addition of tubing set into an isolation packer adds a layer of protection but restricts cross-sectional flow area.

Operators can assess the potential for successful addition of cement and advanced formation sealers in the area behind the casing. Cement can be added behind casing where it was not originally placed if deemed practical and cost-efficient. Remedial cementing could increase the amount of cement behind primary casing through perforating the casing and cementing, milling windows in the casing and cementing, or cutting and pulling free old casing and then inserting new liners and cementing the liners in place with a full cement sheath. When successful, such placement strengthens the cement sheath as a barrier to flow and as a next barrier to loss of containment should the casing fail. However, remedial cementing using these methods impairs the primary casing string by putting holes in the pipe, which must then be sealed. The impairment of the casing creates a new risk and the sealing method must be assured, or another barrier installed, such as a liner or tubing on an isolation packer or a liner cemented inside the casing.

Most of the options that increase the number and/or robustness of downhole barriers have an attendant reduction in cross-sectional flow area, which could lead to a need to drill additional wells to provide the same storage service capacity and reliability. All options, except those for liners cemented in place and cement additions, decrease reliability over the operating life cycle due to the introduction of additional mechanical components. The remedial or barrier addition options also can prevent or decrease the ease of use of other barrier monitoring tools such as casing inspection and fluid movement monitoring devices.

Passive physical barriers such as casing (liners) and cement have inherent reliability in that they are designed to function all the time to contain the stored gas and prevent back-side fluid movement. Storage operators can monitor the condition and effectiveness of the passive physical barriers to monitor the effects of time- and service-dependent decay modes.

Figure 4. Schematic Example of Single Barrier and Multi-Barrier Wellbore

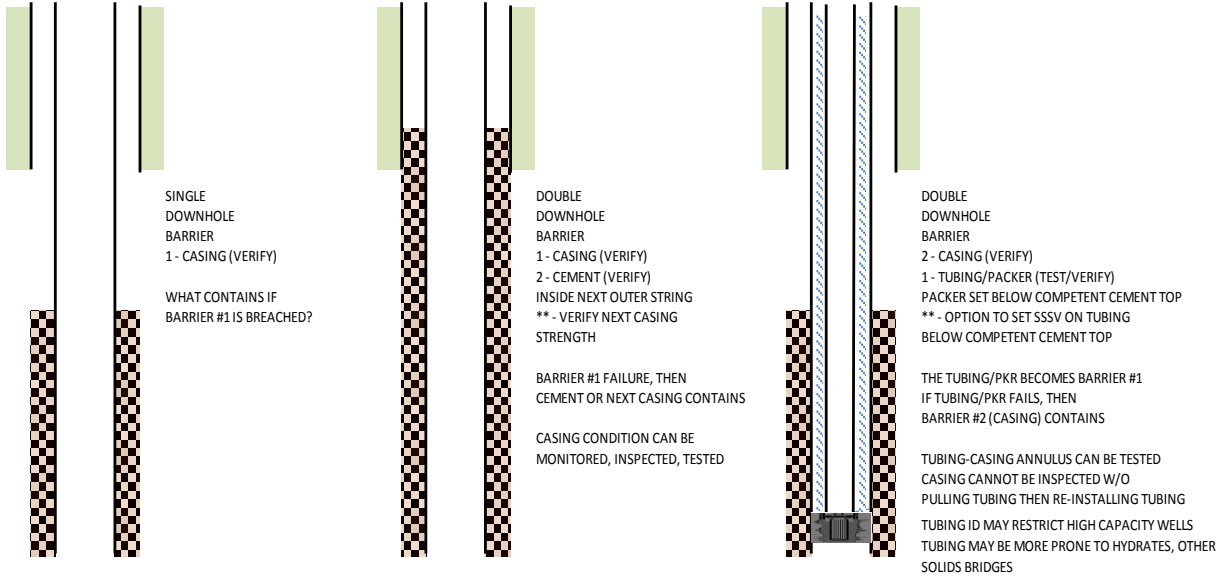

Tubing is rated XX% above maximum design pressure
Cement has compressive strength of X,XXX psi
At the surface there are three barriers
Production casing
Surface casing
Cement

Tubing is rated XX% above maximum design pressure
Cement has compressive strength of X,XXX psi
At the surface there are three barriers
Production casing rated at XX% above design pressure

Tubing is rated XX% above maximum design pressure
Cement has compressive strength of X,XXX psi
At the surface there are four barriers
Tubing- casing annulus filled with corrosion inhibiting

Figure 5. Example Risk Assessment Outline, Single Barrier Well

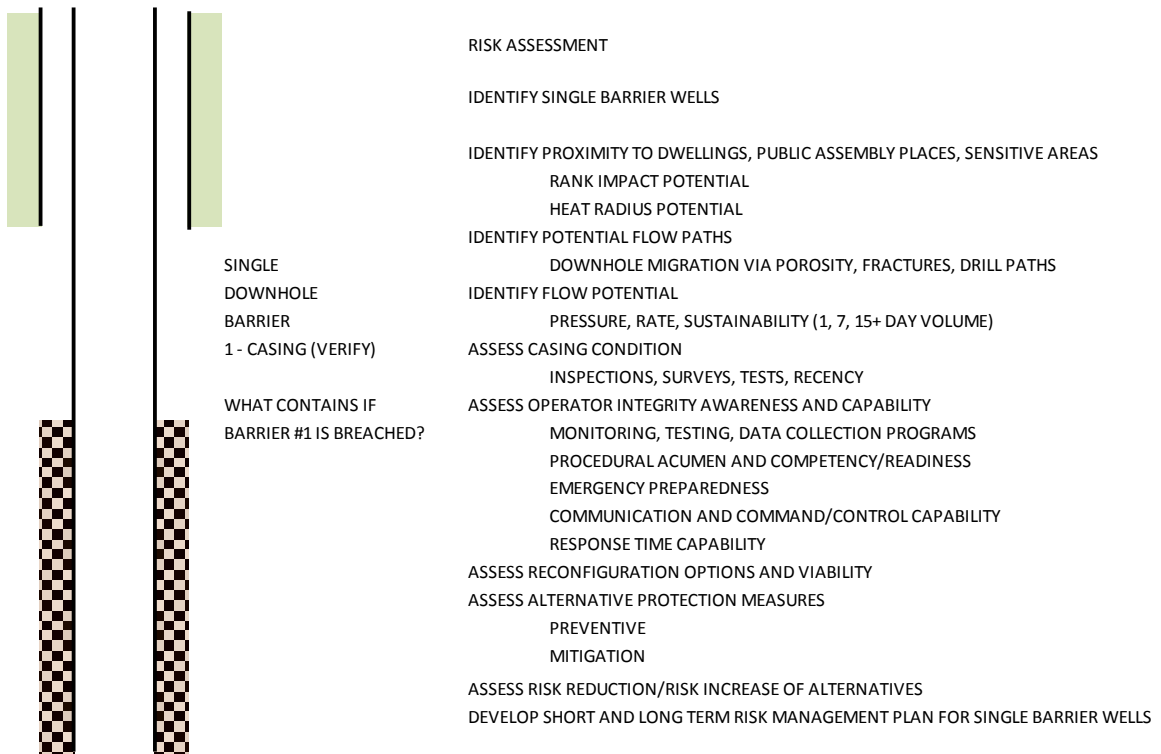

Monitoring, inspection, and testing of well barriers, using methods such as those described below, can reduce the likelihood of events by providing operators with information on barrier condition and effectiveness. Certain techniques requiring well intervention – the insertion of devices in a pressure-bearing well – come with the ever-present risk of loss-of-well-control.

Casing inspection logging with magnetic flux leakage tools can provide information on baseline casing condition and changes in casing condition by repeat surveys thereafter over the well life cycle. Casing condition affected by internal or external corrosion or mechanical wear events can be identified in such surveys. Ultra-sonic tools also can be useful in assessing casing condition and detecting certain anomalies. Operators generally look for consistency of methods over the course of time as each method of casing inspection has some weaknesses. Casing condition affected by significant earth movement events could be revealed by some types of casing inspection surveys such as internal calipers or downhole video surveys, if there is reasonable before- and after-event comparison capability.

Fluid analysis for chemical composition, microbial activity, and acid gases and water assist operators in understanding the corrosion potential of the well fluids and designing corrosion monitoring and mitigation programs. Ultra-sonic pipe wall thickness sensors can be used in above grade piping adjacent to wellhead to check for metal loss; this method is non-invasive and thus has no impact on deliverability or reliability.

Cement integrity surveys, typically with sonic-based tools, can verify the extent and fluid isolation potential of the cement sheath around the casing. Operators lacking knowledge of the cement condition can acquire this information as a means of performing well integrity assessments necessary to risk-based decisions.

Consequence Mitigation

The installation of an SSSV adds a downhole barrier designed to respond to an event, and thus by definition an SSSV is a consequence mitigation barrier. The SSSV activates in response to significant changes in pressure or flow or loss of hydraulic or pneumatic control - events that have a high threshold of deviation from the norm. For small deviations, it is possible, and in fact very likely, for the SSSV to not activate, as for example in the case of a well leak through a pin-hole or small corrosion or mechanical defect feature. The SSSV installation system can reduce cross-sectional flow area and increase the number of service interventions over the life of the well. Consequence mitigation by the SSSV is ineffective in a well where the loss of containment is below the valve or where the valve failed to function. Flexibility of well intervention is decreased by the presence of the SSSV. Kill options might be reduced due to the position of the SSSV and its cross-sectional flow area. The presence of the SSSV system could increase risk in the well intervention operations due to the additional tubing, the valve, and control lines. In the event any of the system is caught in the wellhead during an incident, the master gate valve might not function properly and the event intensity and duration could increase.

Flow and pressure monitoring at the wellhead, including annulus pressure monitoring, is an effective means of detecting abnormal operating conditions. Downhole pressure-temperature devices can be installed in wells to provide additional direct measurement closer to the reservoir; near-reservoir level monitoring could be a valuable addition to wellhead pressure and temperature monitoring in certain wells where significant pressure and temperature changes occur along the length of the well profile. A storage operator's pressure and flow monitoring program and training of staff to awareness of and

response to abnormal operating conditions is a consequence mitigation measure that can be highly effective in minimizing the impact of an event. Early detection of events and efficient response to events is essential to minimizing escalation and thus limiting consequences. Setting of well operating limits and monitoring and inspection of well operating conditions such as pressure, temperature, and flow rate are critical to detection of abnormal conditions to which a response should be given. Operators can assess the consequence mitigation value of data gathering and requirements and training around review of the data and actions in response to abnormalities relative to well operating conditions. Operators can make risk-informed decisions on changes to their program of data gathering and staff training in order to focus resources in the most necessary places and increase process safety reliability.

Well intervention in response to a loss-of-containment event is often practical in many wells and serves to mitigate consequences when the well can be safely entered. A full discussion of well intervention methods and safe work practices is not the intent of this Appendix. However a quick listing of potential intervention methods includes isolation of pressure and flow by setting downhole plugs by electric line or coiled tubing, killing the well by pumping fluid from the surface or through coiled tubing, or through a working tubing string snubbed into the well. In some wells, a deep-set packer can offer the opportunity to set a wireline plug to isolate the reservoir from the well above the packer set point. The deep-set packer system provides a benefit to entry and isolation of a well using a small diameter plug, smaller than the casing internal diameter, where the wellbore internal diameter might be restricted due to casing deformation or buildup of organic or inorganic scales and bridging materials that might preclude a full-bore plug from being set in the casing. Once the well is in a state of control it is possible to conduct additional work to investigate the loss of containment and begin remedial work.

A developed and tested emergency response plan that specifically addresses potential loss of containment events in storage wells during normal operation and during well drilling, servicing, or intervention is necessary to consequence mitigation. Operator emergency response plans should include definition of roles and responsibilities within an incident command structure, the communication and coordination with civil emergency responders, contractors and emergency response material sources, and assistance or coordination with industry partners who could be helpful if an event occurred. Operator personnel are expected to be familiar with the plan and trained in its application.

Emergency preparedness planning links to well integrity documentation. Well integrity assessments allow operators to document as-built and as-current conditions and provide information to the operator necessary for risk-informed decisions. Well integrity loss-of-containment incidents require decisions on whether or not to take the well out of service, repair the well, or plug and abandon the well. In the absence of loss of containment events, well integrity assessments help operators allocate risk management resources on those wells ranked highest in risk. Operators can focus well integrity assessment on wells within a specifically determined radius of places of habitation, roads, human gathering places, or environmentally sensitive areas. Operators can develop risk management plans for wells defined in the integrity assessments as located within a significant impact radius potential of receptors and with capacity to flow at high rates and/or long durations.

Section 6. Summary

Conclusions

The natural gas storage industry has experience using various forms of ESVs. This Appendix provides testimonials from five companies with thousands of operating well-years with ESVs and in total almost 200,000 operating well-years. The overall record of safety in terms of loss of containment events is in the frequency range described as “very unlikely.”

Natural gas storage operators focus their well integrity efforts on the condition and effectiveness of the inherently reliable passive technical barriers of casing and cement. Operators can define as-built, as-identified conditions of barriers and define the limits of pressure and flow under which wells should be operated and monitored. Condition assessment of casing and cement are critical to ongoing integrity management. Installation of additional downhole equipment can impede or make more difficult the condition assessments of casing and cement.

A number of natural gas storage operators have used and still employ both SSV and SSSV. The use of either surface or subsurface ESV systems is an operator-based decision made in view of a wide variety of site-specific factors. Industry sources indicate that installation of a SSSV might decrease the risk by nearly an order of magnitude as compared to the risk due to failure of a primary barrier, such as casing. However, the effectiveness of an SSSV as an additional downhole barrier depends on its location and what the valve location is designed to protect or limit; the effectiveness of an SSSV also depends on the valve system reliability and the valve actuation potential against the potential created by an actual event.

SSSV reliability issues can increase potential for loss of containment events due to the well re-entry to pull and repair or replace the valve. Industry literature cited herein supports the company testimonies with respect to SSSV reliability issues. The reliability issues with SSSV detract from the risk reduction benefit gained by adding SSSV as a downhole barrier.

Storage operator testimony suggests SSSV systems have had, in some wells, adverse consequences on flow capacity and flow reliability, due to the flow profile restrictions that are part of the design of the valves and/or of the valve installation system.

The natural gas storage industry focuses on the values of safety, environmental stewardship and service reliability. Operators are expected to conform to API 1170 and API 1171 standards with respect to decision-making on use of ESVs. API 1170 and 1171 were developed by a consortium including state and federal regulatory agency representatives and some of the most knowledgeable natural gas professionals in the industry. The authors expect that the API 1170 and 1171 practices will be applied across the industry while recognizing the need for unique solutions because of the geological diversity, operator experience, and historical context.

The authors align with the recommendations made in PHMSA’s Storage Advisory, Docket No. PHMSA–2016–0016: Safe Operations of Underground Storage Facilities for Natural Gas, with respect to decision-making around the use of ESV or alternatives. Specifically, the PHMSA advisory bullet #4 recommends periodic function tests for all ESV systems and the repair of deficiencies and failures, or the removal of the well from service, or employment of alternative and equivalently effective safety measures. PHMSA

advisory bullet #5 recommends that operators evaluate the need for subsurface safety valves on new, removed, or replaced tubing strings or production casing using risk assessment aligning to API 1171 criteria as a minimum, and that where subsurface safety valves are not installed, the operator use the risk assessment to inform decisions on integrity inspection frequencies, reassessment intervals, and well integrity issue or incident mitigation criteria.

Further the PHMSA advisory recommends that storage operators implement API 1170 and API 1171, and the Interstate Oil and Gas Compact Commission's (IOGCC) Natural Gas Storage in Salt Caverns—A Guide for State Regulators (IOGCC Guide). Developed under a joint effort of regulators and industry, API 1170 and API 1171 are based on the premise that well life cycle integrity management requires good design, construction and operating practices. For the operations life cycle stage, site-specific risk assessments and integrity program and plan inspection, monitoring, testing and well intervention and remediation tasks are to be based on the operator's risk assessments, knowledge, experience and skill.

Recommendations for Continual Improvement Actions

The risk assessment, decision and rationale regarding application or potential application of an ESV system on a natural gas storage well in a depleted hydrocarbon or aquifer reservoir is a duty of a storage operator under the requirements of API 1171, Clause 6.2.5. The authors highlight the risk management process recommended to operators for use in the decision-making processes. Good decision making is transparent and assesses the outcomes of past decisions.

The authors recommend that storage operators engage in the following continual improvement actions:

- ✓ Follow the risk management process and minimum evaluation requirements in API 1171, Section 8, and clause 6.2.5, and share lessons learned and good practices through industry associations;
- ✓ Follow the additional guidance around risk management discussed in this Appendix and establish a consensus as to some uniform, minimum risk management process detail;
- ✓ Develop templates and methods to gather and share information regarding reliability of various well barrier element system components, including surface and subsurface ESV systems;
- ✓ Establish partnerships between operator groups and stakeholder groups to evaluate reliability of ESV systems and system components, with goals to establish, evaluate, and report safety performance, and develop guidelines for good practices in integrity management and ESV system reliability management; and
- ✓ Collaborate through industry associations and regulatory agencies to develop common integrity management goals and establish regular forums where operating experiences can be shared and employee knowledge, skills, and experiences can be developed and enhanced.

APPENDIX 6.1. COMPANY EXPERIENCES AND OBSERVATION WITH RESPECT TO ESVs

The company testimonies represented in this Appendix are from five storage operators with a combined experience of nearly 200,000 well-years of operation and over 5000 well-years of operation of

subsurface safety valves. The five-company operator group represents a set of 68 depleted reservoir storage fields with over 3,400 wells, of which approximately 200 have subsurface safety valves and more than 200 have surface safety valves. The wells in this group represent operating pressures ranging from 200 psig to 4,000 psig and maximum flow rate potential of up to 500 MMcf/d.

Company A

Basic Statistics:

Of Company A’s wells, nine percent have shallow, hydraulic surface controlled subsurface shut-off valves (SCSSV) and 15 percent of wellhead mains or their wing assemblies are pneumatically controlled by surface shut-off valves.

Brief Underground Storage History

Company A operates gas storage facilities in depleted reservoirs, aquifers, and salt caverns in conformance with all state and federal regulatory requirements. Several of the depleted reservoirs had subsurface shut off valves installed while in production service. As the fields, dating from the 1950s to 1980s, were converted to gas storage service and new wells were added, new surface controlled subsurface shut-off valves (SCSSVs) aka “disaster valves” or “downhole safety valves” (DHSV) were installed as a matter of conformity to past practices and because the term “safety” seemed to suggest a level of prudence. However, within a few years of installation, many of the subsurface shut off valves began to fail for a variety of reasons including but not limited to: sticking mechanisms, leaking hydraulic pumps and lines, control panel leaks, bad regulators, failed seals and flapper valves becoming stuck in open, closed, or partially open positions.

Company A’s ongoing decisions to employ subsurface “safety,” more aptly “shut-off” valves, are influenced by its risk assessments and experience with the reliability of DHSV systems. The valves are typically complex sliding or flapper devices, some consisting of more than 100 components, as shown in Figure 1, with tight clearances that can be contaminated, clogged, degraded, and worn, resulting in hydraulic leaks and valve failures. Because of reliability concerns, DHSV valves are no longer installed as a normal practice in new wells, and they are removed from existing wells when maintenance allows.

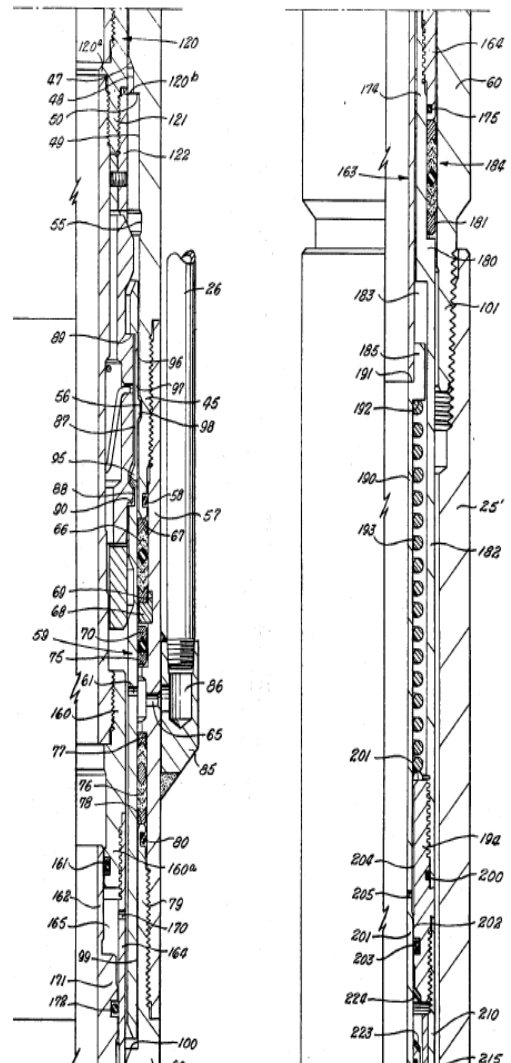

Figure 1. Disaster Valve US Patent 3874634

Reliability

Company A has experienced numerous DHSV failures across multiple storage companies using different manufacturer's subsurface shut-off valves. Company A's experience has been that the reduction in flow area through the valve presents an opportunity for hydrates, paraffin, salts, or other solids to build-up resulting in failure of the SCSSV. Additionally, there have been reliability issues with shut-off valve control line system hydraulics resulting in false closures, blockage of flow, and damage to inspection tools used for assessing well integrity. More than 50 percent of the SCSSVs originally installed in Company A's fields, over the lifetime of the well, experienced a reliability issue and have been removed or locked open for further analyses because a failure of the valve and/or its ancillary systems could have significant negative impact on gas deliverability during a critical period of market need.

Safety

SSSVs used in gas storage originated from the valves installed in subsea production wells where underwater mud slides could shear off the wellhead. SSSVs were believed to provide a fail-safe means of shutting in the gas storage well and isolating the conduit to the reservoir from any surface disaster, including complete shearing off of the wellhead assembly.

In the more than 40 years that Company A has been operating wells with SSSV assemblies, its gas storage fields have not experienced shearing at the wellhead. The majority of the wells are far from the roadway so that the threat of high-speed vehicular collision with a wellhead is remote. Collision risk events can be prevented by installing anchored fencing or guard/buttress systems.

Integrity

A risk related to DHSV/SCSSVs is from normal maintenance operations related to servicing the downhole valves themselves and the need to remove and re-install the valves due to other well work, such as casing inspections. The pressures that must be contained while removing the DHSV from a storage well range from hundreds to thousands of pounds per square inch, resulting in a force capable of launching heavy equipment into the air. Thus, working on a DHSV to maintain its integrity and reliability presents a level of risk that should be carefully considered.

DHSV/SCSSVs fit within the gas well casing and restrict the flow area reducing deliverability. This means wells with SCSSVs cannot be controlled with conventional plugs. In order to be inspected, deep DHSVs require the removal of thousands of feet of tubing while the well is under pressure. The risks during well work, and the restriction caused by the DHSV, and the additional methane that is released to remove and service the DHSV, are all factors that must be carefully considered before installing a DHSV.

Conclusion

Company A has been proactively analyzing its well integrity and removing failed DHSV/SCSSVs not only to prevent a catastrophic loss of gas deliverability to the market place, including residential heating and power plants during critical periods of need, but also to increase safety during work and maintenance to reduce methane emissions. Company A believes it is better to focus on gas well integrity rather than install valves downhole that in all likelihood will never be used and can actually increase the risk of an incident during well interventions.

Company C

Of Company C's portfolio, three percent of wells have hydraulically surface-controlled subsurface safety valves, and the majority of which are deep set and the rest are shallow set pusher type; additionally, one percent of wells have pneumatically controlled surface ESD valves.

Safety valves have been in service 10-30 years. Safety valves in service are in wells within a several hundred foot proximity to residences, businesses or schools. Company C had several safety valves in one field in the past due to coal mining. Decisions were made to plug these wells and not drill and complete future wells unless they are drilled through a pillar. Company C has had subsurface safety valves close due to control line leaks.

Subsurface safety valves in these storage wells drastically reduce flow by 40-50 percent, but the company has not noticed reduction in flow through wells with surface ESD valves.

The company decided to use concrete and or steel barriers around wells where necessary to reduce risk, as alternatives to safety valves.

Brief Underground Storage History

Company C operates storage facilities in depleted reservoirs, aquifers, and salt caverns in conformance with all state and federal regulatory requirements. Several of the reservoirs had SSSVs installed due to proximity to residences, schools, or were in an underground coal mining area. Safety valves are tested once a year to assure that SSSV will close and then are pumped open again. Most failures have occurred due to surface control failure. All storage wells are on a regular workover schedule which includes casing inspection logs. Each storage well has at least two casing inspection logs in its history. Wells are serviced every 10-15 years. The company has experienced one serious well control incident in the last 50 years.

Safety

The majority of Company C wells are in remote areas and it is the Company's assessment that SSSV are not warranted. Wells in fields with animals have either pipe or concrete barricades around the well. Generally 50% of the wells have either a safety valve or barrier around the well.

Company E

Basic Statistics:

Company E operates numerous depleted storage reservoirs, where approximately 2.5 percent of wells have shallow-set surface-controlled subsurface safety valves (SCSSVs), which are hydraulically controlled and approximately eight percent have surface-controlled surface safety valves (SCSVs) with a fusible element, which are hydraulically controlled and located in the wellhead stack (spring-actuated, fail closed design).

Brief Underground Storage History

Company E operates storage facilities in depleted reservoirs in conformance with all state and federal regulatory requirements. Several of the depleted reservoirs had SCSSVs installed while in original

production or conversion to storage operations once the fields were depleted. The remaining SCSSVs date from the late 1960s to early 1970s, with the exception of two valves which were installed in the mid-1990s. As the fields were converted to gas storage service and new wells were added, new subsurface control subsurface safety valves were generally installed as risk mitigation to wells within the flight path of neighboring aircraft. However, within a few years of installation, many of the subsurface safety valves began to fail for a variety of reasons, including increased corrosion of valve, materials plugging the valve bore, and reliability with the hydraulic control and tubing system used to control the valves.

Risk Basis for Safety Valve Installation:

Company E's current risk assessment considers the principles of API 1171 requirements, using the following factors in evaluating the potential applicability of any type of safety valve:

Flow potential of the well at maximum reservoir pressure

Proximity of the well to:

- ✓ People in permanent dwellings
- ✓ People in public gathering places
- ✓ Probable frequency/density of people in recreational areas
- ✓ Transportation corridors, public or private, including air, roads, rail, waterways
- ✓ Environmentally sensitive areas
- ✓ Other storage wells, storage infrastructure, or other industrial infrastructure
- ✓ Ability to control the well through fluid pumping (well kill) or other interventions
- ✓ Safety valve reliability experience and safety risk to well service personnel engaging in well interventions

Company E views safety valves as a mitigative measure in the event of a significant sudden failure of the gathering lines, the near-well flow line or other equipment adjacent to the wellhead. Casing failures at depth are possible but the event likelihood is remote, in the 1×10^{-4} to 1×10^{-5} range (published literature). Company E operates in a region where forces causing induced stress on wells and casing are remote, leaving human causes as the main influence in well operation / catastrophic failure potential.

Of all the analytical factors, the proximity of the well to potential heat-affected radius (which is a result of maximum flow rate) are the most heavily weighted factors in decisions on whether to employ a safety valve.

Reliability:

Company E has experienced numerous failures with the same manufacturer's subsurface safety valves. Experience indicates a reduction in flow area through the valve presents an opportunity for hydrates, paraffin, salts, or other solids to build-up. The build-up may result in a failure of the SCSSV to operate as designed. Additionally there are reliability issues with safety valve control systems and hydraulics resulting in false closures.

Company E has documented valve malfunctions and test failures, and those failures necessitated additional well interventions.

Safety:

The SCSSVs systems were originally installed to provide a fail-safe means of shutting in the well and isolating the conduit to the reservoir from any surface disaster, including complete shearing off of the wellhead assembly.

In the nearly 50 years that Company E has been operating wells with SCSSVs, the system has never experienced an incident which threatened a violent shearing at the wellhead. The majority of the wells are not located near roadways, so the threat of high-speed vehicular collision with a wellhead is remote. A majority of these wells are protected against collision by a guard rail. The wells do not exist in a high-risk earthquake or earth shear zone. Some wells do exist proximal to flight paths of heavy and/or high speed aircraft, but the probability of occurrence is remote. Likewise, sabotage or terrorist acts could target wellheads, but individual wells can be considered at low risk of being targeted due to their distance from the general public and due to the choices of easier targets.

The biggest risk with SCSSVs is from remedial operations related to servicing the safety valves themselves or the need to remove and re-install the valves due to other well work, such as casing inspections. This is noted extensively in the professional literature.

If the risk of well incident or worker injury is present every time a valve is retrieved and reinstalled, then company personnel have had several hundred well intervention events in their operating history where an incident could have happened. In the same time frame, the company is aware of three insignificant collisions with a wellhead in the system (light duty trucks and farm equipment). The company has never experienced plane crashes or terrorist events at or near any wellhead. The company's experience and knowledge of similar operators' experiences mimics professional literature, in that risks during well intervention are significantly more likely to create an incident than shearing of a wellhead.

During the 1990s, Company E reached a point where about 10% of wells had SCSSVs. Nearly 75% of the SCSSVs have subsequently been removed since the mid-1990s. The SCSSVs were originally removed during corresponding well interventions, but a specific program to actively remove the SCSSVs and replace them with SCSVs was initiated in the early 2000s.

Company J***Basic Statistics and History:***

Company J operates a relatively small fleet of wells but approximately 30 percent of wells have SCSSV.

Reliability:

Company J has experienced multiple problems with subsurface safety valves installed in the 1980's. As Company J did not keep detailed logs of SSSV maintenance prior to 2016, Company J cannot substantiate if the failed SSSVs were properly maintained per the manufacturer's specifications.

- In testing and maintaining SSSVs, Company J has documented eight valve test failures. These failures were not limited to one facility or location.
- Company J currently has seven SSSVs that it has decided not to test or operate as Company J has observed similar SSSVs fail in a closed position. Company J highly believes that a significant

percentage would fail closed if operated and would require an immediate wireline job to reopen the SSSV to operate the well.

- Company J plans to remove SSSV from two wells and not reinstall or replace the valves.
- Company J has observed reliability issues with safety valve control line system hydraulics resulting in false closures, and flow restrictions.

Safety:

SSSVs were installed to prevent a loss of containment and provide an additional shut-in mechanism at the wellhead.

- In its operating history, no Company J wellhead has been sheared. No incidents or near misses that could have caused wellhead shearing.
- The majority of Company J's storage fields are in remote or rural locations away from densely populated areas and major roads.
- Placement of SSSVs is along roadways and structures intended for human occupancy.

Subsurface safety valves are not a panacea as they can complicate operations, may limit tubing inspection options, and require additional maintenance.

Company S

Basic Statistics:

In Company S' portfolio, 12 percent of wells have shallow-set surface-controlled subsurface safety valves, hydraulically controlled, three percent have surface safety valves, pneumatically controlled, on the wellhead and/or at the immediate wing of the wellhead.

Risk Basis for Safety Valve Installation:

Company S' risk assessment follows the principle of API 1171 requirements (at Section 6.2.5), using the following factors in evaluating the potential applicability of any type of safety valve:

Flow potential of the well at maximum reservoir pressure

Reservoir storage volume and depletion rate potential

Proximity of the well to:

- People in permanent dwellings – immediate radius
- People in public gathering places – immediate radius
- Probable frequency/density of people in recreational areas
- Transportation corridors, public or private, including air, roads, rail, waterways – immediate radius
- Environmentally sensitive areas – immediate radius
- Other storage wells, storage infrastructure, or other industrial infrastructure
- Population density in a wider (three to five mile) radius

Ability to control the well through fluid pumping (well kill) or other interventions

Safety valve reliability experience and safety risk to well service personnel engaging in well interventions

Fluid composition – range of gas composition, liquid hydrocarbon potential, freshwater potential, saltwater potential

Well construction (as built, current state), including number and quality of casing and cement sheath barriers, and the casing geometry (diameter, inclination, depth)

Company S views safety valves as consequence reduction controls in the event of a significant sudden failure of the gathering lines, the near-well flow line or other equipment, the wellhead, or a near-surface (shallow-depth) casing rupture or shear. Casing failures at depth are possible but the event likelihood is remote, in the 1×10^{-4} to 1×10^{-5} range (company experience and published literature). Casing failures with apertures large enough to have significant flow rates must be induced by human or natural forces that place increased tensile, compression, or axial force on casing, which might be weakened by time-related degradation mechanisms such as corrosion. Drawing on the extensive operating history in the areas where Company S operates, Company S knows that natural forces causing induced stress are rare, leaving human causes as the main influence in well operation/catastrophic failure potential.

Likelihood analysis (of a large rupture) is driven by the as built/current state of the well and the well's proximity to strike impact or potential stress-inducing forces.

Consequence analysis is driven by well potential, reservoir volume and rate of pressure depletion, proximity to sensitive receptors (people, environment, other infrastructure, particularly in an immediate radius affected by heat stress and ignition potential should an uncontrolled well flow ignite), and fluid composition, and consequence reduction measures including kill potential, emergency preparedness and anticipated effectiveness of emergency response measures including response time and perceived well controllability.

Of all the analytical factors, the proximity of the well to impact receptors or impact deliveries and the potential heat-affected radius (which is a result of maximum flow rate) are the most heavily weighted factors in decisions on whether to employ a safety valve.

Company S' ongoing decisions to employ safety valves is influenced by its experience in the reliability of safety valve systems.

Reliability:

Reliability is expressed in valve function failure during normal operation, or valve failure during semi-annual function tests. Experience has been that the upper assembly creates a restriction that is a favorite hydrate, paraffin, salt, or other solids bridging area, leading to decreased reliability and time and expense involved in finding and remediating the bridging. There have been reliability issues with safety valve control line system hydraulics and false closures due to control line leaks or temperature changes.

Company S has seen valve malfunctions and test failures at a rate of one to two percent of all valves in inventory per year (0.015 failures per well-year of operation).

The total entry-and-removal/replacement of subsurface safety valves has a rate of 0.141 entries per well-year, composed of 0.047 entries per well-year for SV inspection and repair, 0.015 per well-year for

test/function failures, and 0.079 per well-year for casing inspection. Thus, the reliability issue reasons for re-entry are ~0.062 entries per well-year.

The total re-entry rate is a significant factor in the safety impact analysis used in decision-making around safety valve disposition.

In addition to well re-entry to pull the valves, Company S has tracked flow and function reliability issues related to downhole safety valves for the period 2005-2016. Flow and function reliability issues include hydrates, salt, or paraffin bridging in the safety valve assembly, or function test failures due to the same types of bridging agents fouling the flapper closure mechanisms. Although 2016 represents a partial year thus far, the corrective maintenance issue (reliability issue) rate is 0.151 per well-year of operation. Company S observes that the annual corrective maintenance rate varies from as low as 0.061 per well-year in warm, small-withdrawal volume winters to 0.224-0.293 per well year in cold, deep-withdrawal winters. The overwhelming majority of corrective maintenance actions involve flushing with solvents such as water, methanol, or heated diesel oil, and in over 90 percent of instances these are successful in restoring flow and proper valve function.

Safety:

The SSSV systems were installed in order to provide a fail-safe means of shutting in the well and isolating the conduit to the reservoir from any surface disaster, including complete shearing off of the wellhead assembly.

In the more than 36 years that Company S has been operating wells with SSSV assemblies, the system has never experienced an incident that approximated or threatened a violent shearing at the wellhead. The majority of the wells are far from any roadway so that the real threat of high-speed vehicular collision with a wellhead is extremely remote, and such an event can be protected against via anchored fencing or guard/buttress systems. The wells do not exist in a high-risk earthquake or earth shear zone. Certain wells do exist more proximal to flight paths of heavy and/or high speed aircraft; although a well blowout from a plane crash is protected against with a SSSV given the depth of setting, such events have a very low probability of occurring. Likewise, terrorist acts could take out wellheads, but individual wells can be considered at low risk of being targeted due to their distance from the general public and due to the choices of easier targets.

The biggest risk related to surface-controlled subsurface safety valves is from remedial operations related to servicing the safety valves themselves or the need to remove and re-install the valves due to other well work, such as casing inspections, and this has been noted over the years in the professional literature. For example, a 1985 Journal of Petroleum Technology (JPT) article ("Subsurface Safety Valves: Safety Asset or Safety Liability?", Busch, Policky, Llewelyn, JPT October 1985) quoted a survey of well blowouts from 1979-1982 (in the non-communist world). Of the 271 blowouts, 216 were blowouts while drilling and 55 were production related. For the production related blowouts, the largest percentage (14 of 55) occurred during workover operations.

If the risk of well incident or worker injury is present every time an upper assembly is retrieved and reinstalled, then Company S has had several hundred well intervention events in the past 36 years where something could have happened. The Company S experience and knowledge of similar operators' experiences mimics that reflected in the literature, which is that risks during well intervention

are more likely to create an incident than is the chance that a more direct disastrous event, such as a casing failure or combined casing/cement failure, would create an incident.

While it is prudent to maintain the SSSV systems because of the prevalent need to provide a fail-safe shut down of the well conduit to the reservoir and protect workers, the public, and adjacent infrastructure, Company S looks for ways to minimize the interventions that invite incidents.

Regulatory requirements to install subsurface safety valves and full tubing strings on all Company S wells would require ~\$150-\$190 million for existing wells and addition of ~75 new wells at ~\$120-\$140 million in order to retain the same storage service capabilities. Maintenance rates would increase, causing O&M expense to increase by \$2-4 million per year (\$40-120 million over 20-30 years) and the risk of loss of control due to well entry and service work would increase 10-12 fold, directly aligning with the increase in the number of safety valves and tubing/packer strings.

APPENDIX 6.2. INDUSTRY LITERATURE REVIEW – OPERATING EXPERIENCE

A 2005 Gas Research Institute study, Project No. 809833, RISK ASSESSMENT METHODOLOGY FOR ACCIDENTAL NATURAL GAS AND HIGHLY VOLATILE LIQUID RELEASES FROM UNDERGROUND STORAGE, NEAR-WELL EQUIPMENT, performed by URS Corporation under Contract No. 8604, provided both a literature review and survey techniques to arrive at component reliability estimates and failure rates of storage wells from all component failures and combined reliability causes. A fault-tree analysis methodology was adapted and used to predict failure rates of $4.9\text{E-}05$ to $7.7\text{E-}04$ with and without a downhole safety valve (DHSV), respectively, and a sensitivity range using several well configurations and applying uncertainty ranges to variables to push the 'without safety valve' rate to $1.7\text{E-}04$ to $7.7\text{E-}04$. URS estimated the probability of the same types of releases catching fire to be lower, in the $2.1\text{E-}05$ to $9.7\text{E-}05$ range.

From survey data, URS estimated well failures occurring due to downhole safety valve maintenance at $1.78\text{E-}05$, which is somewhat less likely than failures due to cement ($6.4\text{E-}05$) but similar to failures due to casing failure (1.6 to $2.9\text{E-}05$) vehicular strikes ($1.78\text{E-}05$) and falling objects ($1.34\text{E-}05$). All these individual rates are “very unlikely” in terms of likelihood of occurrence.

Safety valve failures to close on demand are in the range of $1.95\text{E-}05$ to $4.38\text{E-}06$ per demand and surface safety valves by analogy are interpreted as having a failure to close at a very low $7.01\text{E-}08$ per demand.

It is worthwhile noting that “failure” resulting in gas release during a well drilling or re-entry for service is one to two orders of magnitude greater than most failures due to well equipment: $3.41\text{E-}04$ to $8.91\text{E-}05$ per entry.

URS noted in the report that process safety general principles understand that the number of catastrophic incidents is a small percentage of lesser incidents that could have had catastrophic results; API 754 and other process safety standard performance indicator tiering apply this understanding.

URS noted that record keeping and data analysis were key to studying reliability and failure in a quantitative fashion, and encouraged uniform tracking of industry data for reliability issues and failures at the component level, along with evaluation of maintenance activities and reliability engineering improvement efforts, in order to develop continual improvement.

Moines and Iversen (1990, OTC 6462, Reliability Management of Subsurface-Controlled Subsurface Safety Valves for the ROGI Project), demonstrated in a 1990 paper that SCSSV failure was the primary cause of workover operations initiated due to completion equipment failures in offshore operations – 450 per 10,000 well years. The authors noted that reliability methods can be used to increase reliability and in particular that working with the manufacturer to enhance reliability in the design phase was essential. The paper reviews seven configurations of downhole safety valves, from shallow set, tubing retrievable surface controlled systems to deep set, surface controlled systems; the shallow systems were complemented with dual safety valves. Reliability data indicate that the deep set systems fare poorest, with failure rates of $1\text{-}3\text{E-}04$ and shallow systems at $0.6\text{-}0.8\text{E-}04$; the various dual-valve combinations reduce failure by an order of magnitude, to $0.3\text{-}0.6\text{E-}05$.

Moines and Strand followed up in 2000 with SPE #63112, “Application of a Completion Equipment Reliability Database in Decision Making”, where historical evolution in reliability of subsurface safety valves (SCSSV) is demonstrated from what was largely a North Sea data set. The paper advocates a screening matrix to characterize risk and push the bounds of risk acceptance given consequence analysis so as to not compromise safety overall. Increasing test frequency is advised when there is an actual failure or a heightened risk of a well barrier failure.

Moines and Strand look at the issue of SCSSV removal from subsea completions and suggest that this be addressed on the basis of local/regional requirements and likelihood and consequence impact factors. The authors note a significant improvement in SCSSV performance occurred in their data set from Mean Time to Failure (MTTF) of 14.2 years in 1983 to 36.7 years in 1999. A trend toward design standardization using single rod piston, flapper type tubing retrievable safety valves without equalizing feature is credited with the increased SCSSV reliability and reduction in well interventions. SCSSV reliability improvements can be made by applying a system reliability approach encompassing the valve and its mechanical components as well as the control line, control line protectors, tubing hanger/x-mas tree interface and the surface hydraulic control unit.

Durham and Paveley, SPE 56934 “Radical Solutions Required: Completions Without Packers and Downhole Safety Valves Can Be Safe”, 1999, found blowout frequency during workover in the 6.8E-04 range for their data set, with SCSSV workover frequency .02-.03 per year. The authors assess likelihood and consequence, where consequence is on a safety-environment-cost basis, and show that the elimination of packers and downhole safety valves from completions can be tolerated, providing an increase in cost efficiency through reduction in equipment and well interventions. The risk assessment method includes fault trees and failure mode, effect, and criticality analyses, combined with quantitative analysis of an uncontrolled hydrocarbon release.

A key to the methodology is the addition of loss of control risk due to equipment failure. The authors establish loss of control frequencies for component failure and for workovers from worldwide data, then they relate completion component reliability to the need for workover to get the combined risk. Like a fault tree, the release potential is the sum of component failure leading to loss of containment plus the chance of workover loss of control, where workover loss of control is component failure rate=well workover rate multiplied by the chance of a workover loss of control incident.

Secondary controls can be employed to reduce criticality of a loss of control failure into the tolerable range with or without a safety valve, and these include gas/flame detection monitoring equipment, annulus pressure monitoring, emergency plans in place for rapid response well kill or control, pressure test verification of containment barriers, pressure monitoring and control equipment, and, during workovers, regular BOP testing and maintenance of dual barriers.

A downhole safety valve reduces consequences of relatively few events and only during normal operations, so the authors advise that the consequence level be assessed quantitatively. The likelihood of a loss of containment event during normal operations is low but the service of the valves has a greater chance of loss of control.

Powell and Van Scyoc (2011), SPE #145428, “Well Site Screening: The Critical Few”, note that risk screening should be applied to define the most critical wells and then resources expended at those sites to gain the most benefit. It is impractical and unnecessary to use the same integrity maintenance, monitoring, and verification strategy at every well, and, rather, operators should see more rigorous

integrity management practices at high risk wells. Powell and Van Scyoc developed and applied a structured risk assessment approach, with a goal to reduce risk to as low as reasonably practicable for continued safe operation.

Powell and Van Scyoc assessment criteria included well type and status (a reflection of the well as-built and current condition), maximum well pressure, maximum/normal flow rate, and fluid production characteristics as inputs, along with consequence impact attributes ranked by H₂S exposure, flammability limits, and extent of liquid pool spread for releases at the surface, all compared to distance to population and environmental receptors. The authors divided their well set into three tiers defined relative to the H₂S radius of exposure, gas dispersion radius at 50 percent of the lower flammability limit, and a 24 hour liquid release spread radius; the tier divisions, they noted, generally reflected regulatory practices and were otherwise conservative. Thus, the authors used a consequence-basis to risk-tier their wells without respect to likelihood for a well failure. The risk-tiers support different levels of integrity activity requirements – testing, inspection, monitoring, and other activities, including for the highest risk wells.

Powell and Van Scyoc noted lessons learned from the application of the screening. First, the method had no approach to handle downhole, subsurface product releases. Such a model or method is necessary, along with guidance for inspection, testing, and monitoring programs. Second, the method does not permit input variables that might be related to more than one release scenario (casing, tubing, flowline scenario for a single specific well). Input variables could be established for various well types, for which separate impact evaluations could be done for multiple major release scenarios. Third, they identified a need to incorporate wellbore fluid levels, well type, and pressure for screening impact susceptibility of underground sources of drinking water.

APPENDIX 6.3. ADDITIONAL NOTES AND GUIDANCE ON THE RISK MANAGEMENT PROCESS

Determining objectives and internal/external context

Each gas storage operator sets risk management objectives in the context of their own company's internal operating environment and capability. The operating environment includes the company's operating history and institutional knowledge, organizational structure for command-and-control of resources and influence by internal stakeholders. A company's capability is influenced by the knowledge, skills, and experiences of individual contributors, corporate structures, and the embodiment of controls within procedures, training, supervisory control and reinforcement and continual improvement activities.

The gas storage operator sets the risk management objectives in the context of the external operating environment, which includes, at a minimum, the concerns of public stakeholders and regulatory agencies, regulatory trends, natural gas infrastructure development and enabling trends, gas storage business trends, industry concerns as embodied in/through industry associations, industry recommended practices and guidelines, professional literature, academic research, and a wider body of knowledge, skills and experiences than any one company could have.

The risk analysis method – various forms of qualitative, semi-quantitative, or quantitative - depends on the company's capability, in and through its individual contributors' capability, to apply the risk analysis method in a consistent manner and achieve meaningful results. If past data aggregation and analysis has not been quantitative, it might be difficult initially to apply fully quantitative methods.

A similar risk analysis methodology could be desirable across the industry; however, one approach might be to start at a basic, semi-quantitative level, advising collection of reliability and safety data, so that continual improvement can be achieved along a path to more fully quantitative risk analysis methods. Industry literature reviewed indicates that there is potential to begin at a semi-quantitative level since some general failure rates are known and safety valve reliability experiences are known by some operators.

Analysis of risk: well-specific applications

Similar to impact factors and assessments used by Powell and Van Scyoc, storage operators could assess gas dispersion radius at 50 percent of the lower flammability limit, and a 24-hour liquid release spread radius. Alternatively, operators could apply CSA Z341.1 impact assessment following Gas Research Institute project GRI-00/0189 radius-pressure-casing size relationship, which uses worst case well flow capacity, ignition of the gas, and a heat flux of 5.0 kW/m², representing a 30-second burn threshold.

Population density for widespread impact assessment could be tiered as follows:

- 0-1 per square mile
- 1-10 per square mile
- 10-100 per square mile
- 100-1000 per square mile
- 1000-10,000 per square mile
- >10,000 per square mile

Operators can assess impact potential due to fluid composition and maximum flow potential in two ways: at the maximum daily rate, and at an extended duration. The operator can assess each well's maximum flow capability, constrained by casing inner diameter, at absolute wellhead flow potential at maximum pressure. The extended flow capability (extended release volume) of the well can be calculated over various intervals. The operator could assume a maximum case of decline in reservoir pressure solely due to a leak at the well, or assume a minimum case where in a period extended beyond a few days, field withdrawal could be orchestrated to bring reservoir pressure down more rapidly. The operator can assess the potential of the well to release product other than dry natural gas; wells that could produce water, liquid hydrocarbon, solids, or noxious or hazardous gas constituents could be rated as potentially more severely impactful. The volume of greenhouse gas emissions and the local/global impact can be addressed in the assessment.

Evaluation of Risk

The operator can develop a decision tree specific to the question of whether a safety valve system is needed at each well. For wells that already have a safety valve, the decision tree could help the operator to demonstrate that the safety valve system is needed and located in the best place, or that the safety valve system is needed but not located in the best place, or that the safety valve system is not needed.

When the risk evaluation indicates that a specific well's loss-of-containment potential and impact potential are severe enough to warrant evaluation of the risk reduction with a safety valve, the operator can evaluate alternative means of reducing risk. With each alternative, the operator can assess both the risk reduction potential of the alternative as well as the risk increase potential related to the alternative.

Worldwide, safety risk thresholds are values-based and often stated for individual risk in terms of fatalities per capita per year, and a near-universal threshold of unacceptable risk in a tolerable risk framework is one in 10,000 fatalities per capita per year, whereas a widely acceptable risk threshold on the lower end of a tolerable risk framework is at one in 1,000,000 fatalities per capita per year.

Environmental risk thresholds are not well-established. However, most guidance on risk acceptability scaling is a mix of values-based/bounded constraint/utility basis relating to the number and type of receptors impacted (which often relates directly to radius of impact and what is in the radius of impact), the environmental impact duration, and the environmental recovery time.

Service reliability risk thresholds are not well-established since the evaluation criteria are usually utility-based (cost/benefit); the risk acceptability scaling is site specific and relates to the local impacts, duration, and service alternatives.

