

Understanding Carrier Aggregation

1 - Executive Summary	3
2 - Introduction	3
Motivation for developing Carrier Aggregation (CA).....	3
Current deployment	3
3 - HSPA+ Carrier Aggregation	4
3GPP HSPA+ evolution overview	5
Release-8	5
Release-9	5
Release-10	6
Release-11	8
Detailed principle of multi-carrier in HSPA Release-8 and beyond	9
4 - LTE-A Carrier Aggregation	12
Type of Carrier Aggregation	12
Deployment strategies	12
E-UTRA CA bands notation	13
UE bandwidth class	14
Channel bandwidths per operating band for CA	15
E-UTRAN aspects	17
Impact of Carrier Aggregation on signaling aspects	18
Transport (MAC) layer aspects	19
Carrier activation/deactivation and discontinuous reception DRX.....	20
Physical layer aspects	20
Downlink channel quality	20
Uplink control signaling	20
Uplink channel quality	21
Uplink transmit power control	21
Downlink radio link monitoring	21
Timing and synchronization.....	21
Cross-carrier scheduling	21
Radio Resource Control (RRC) aspects	22
RRC UE capability transfer procedure	22
Scell addition and removal	23
Handover	24
5 - Testing CA: implementation and verification challenges	24
RF development testing	24
User Equipment (UE) transmitter and receiver aspects of Carrier Aggregation.....	24
Solutions to generate RF LTE-A CA signal	28
Solutions to analyze RF LTE-A CA signal.....	29
Protocol development testing	30
Anritsu protocol testing solution	30
System level test	34
Performance testing	34
Anritsu maximum performance testing	34
Battery life testing	35
Conformance testing	36
Conformance tests overview	36
Example of RF conformance testing	37
Example of signaling conformance testing	38
6 - Conclusion	39
7 - Bibliography	39
8 - Appendix	40
Carrier Aggregation E-UTRA channel numbers	40

1 - Executive Summary

This Understanding Guide gives an overview of the Carrier Aggregation evolution in HSPA and LTE networks, discusses implication on the architecture and the User Equipment. A special focus will be made on the testing method to troubleshoot and evaluate the performance of carrier aggregation devices.

Anritsu has been actively involved in 3GPP Carrier Aggregation standardization (WG5), simulation and demonstration since the establishment of the Work Items.

2 - Introduction

Motivation for developing Carrier Aggregation (CA)

The idea of multi-carrier usage has been driven by operators' increasing technology and operational challenges in terms of data capacity. The initial UMTS deployments focused mainly on coverage maximization, and thus, a single carrier capacity was adequate to cope with the subscriber requirements.

Recently, rapid data user growth took place due to several factors on top of HSPA availability; better user experience for broadband multimedia applications, high speed internet and availability of relatively cheap smartphones handsets. Therefore operators acquired several spectrum licenses and deployed HSPA networks with multiple carriers to meet the capacity requirements, and in the first deployed scenario these multiple carriers were operated independently on L2 & L1. That type of scenario requires a strict Radio Resource Management and layer coordination to define load balancing criteria.

The bursty and unpredictable nature of data IP packet is making management of load balancing over carriers very inefficient. The idea of joining the carrier resource allocation emerged and led to the development of the 3GPP feature called "Dual-Cell HSDPA Operation on Adjacent Carriers" in the Release-8. The main advantage of joining resource allocation and load balancing across the carriers is to achieve better resource utilization and spectrum efficiency since the probability of having unused resources is reduced. This phenomenon is sometimes also referred to "trunking efficiency". Further evolution of HSPA CA will be developed in the next chapter. Following HSPA+ introduction, the Carrier aggregation then has been introduced also in LTE-A in 3GPP Release-10.

The overall goal of the Carrier Aggregation is on one hand, to provide enhanced and consistent user experience across the cell by:

- Maximizing the peak data rate and throughput by combining peak capacities and throughput performance available at different frequencies.
- Improving mobility, by mitigating the relative inefficiencies that may be inherent in wireless deployments in non-contiguous carrier often spread across different spectrum bands.
- Providing a better and more consistent QoS to users thanks to the load-balancing across frequencies and systems. A user suffering from congestion in one band can be scheduler seamlessly access unused capacity available at another frequency or system.
- Enabling interference management with intelligent allocations of resources.

On the other hand, it is providing to operators a cost effective solution to increase their current network throughput and capacity through minor software upgrade to their sites already using several frequencies.

Current deployment

HSPA+, which corresponds to the Release-7 onward, is currently the mainstream system technology for delivering mobile broadband services across the world.

At this date of November 2012, GSA report capturing the global status of network commitments, deployments and commercial launches, confirms that:

- 294 operators have committed to HSPA+ network deployments.
- 254 HSPA+ systems are in commercial service in 118 countries representing 52% of all HSPA operators.
- 102 operators have commercially launched DC-HSPA+ systems.

HSPA carrier aggregation has been introduced in Release-8 and the UEs supporting it are available in the market. DC-HSPA+ network deployment is a main trend in 2012.

3 - HSPA+ Carrier Aggregation

The section will focus on the evolution of carrier aggregation on HSPA through the 3GPP releases.

3GPP HSPA+ Evolution overview

The Dual Carrier DC-HSDPA is a 3GPP Release-8 feature and is already a reality in numerous commercial deployments in the world. The DC-HSDPA is limited to 2 adjacent carriers of 5 MHz. In Release-9 the adjacent carrier limitation is overcome, to provide a Dual Band HSDPA operation with separate frequency bands with MIMO. The uplink is also considered, and the Dual Carrier HSPA is introduced.

In the following release, the standardization the framework developed during the previous rounds of multi-carrier standardization in 3GPP is reused to provide a 4-Carrier HSDPA in Release-10 on two separate frequency bands.

A natural step in Release-11 is to provide a support up to 8-Carriers HSDPA aggregating up to 40 MHz of spectrum meeting the requirement of ITU for a real 4G/IMT-Advanced. Release-11 also brings support aggregation of non-adjacent carriers on the same frequency band.

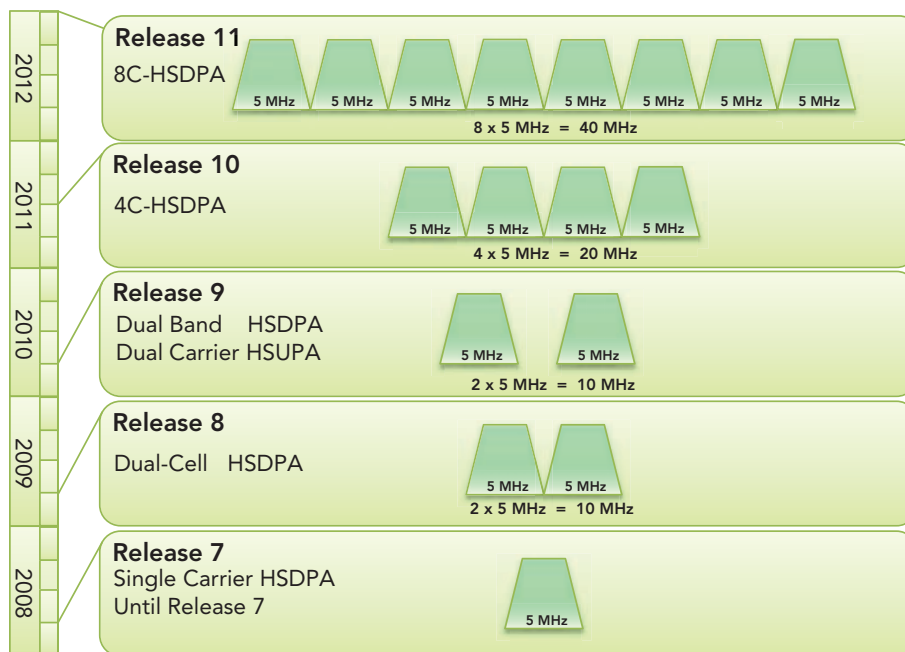

Figure 1 - Evolution of HSPA Carrier Aggregation.

The peak rate capabilities provided by each evolution is improved significantly. Carrier aggregation is one of only a few features to provide such a clear capacity improvement on the network.

As seen on Figure 2, from a downlink theoretical peak data rate in Release-7 of 28 Mbps, each release doubles this peak, to reach in Release-11 a throughput of 336 Mbps with 2x2 MIMO and a throughput of 672 Mbps when combined with 4x4 MIMO.

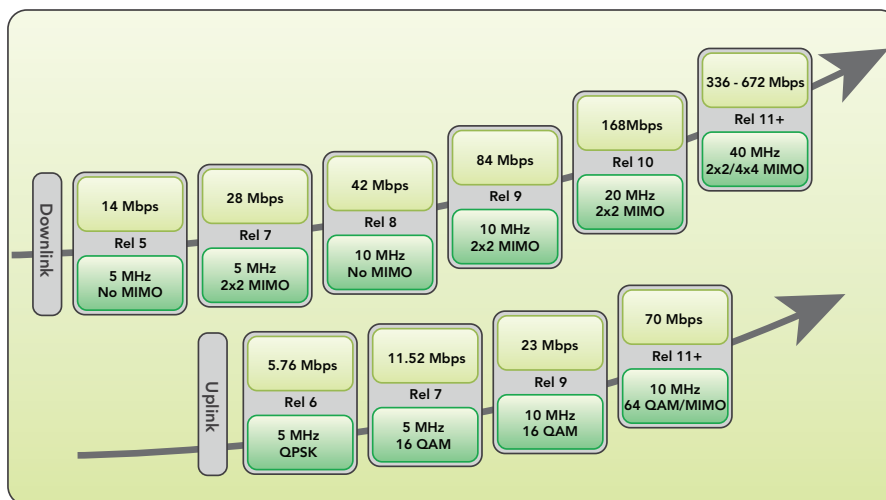

Figure 2 - Evolution of throughput in HSPA with Carrier Aggregation.

The evolution of HSPA is pushing the peak data rates to approach LTE Advanced performances, allowing this mature technology to continue its life while LTE is deployed. The following chapter describes in details those evolutions. However, the UE complexity and the power consumption related to multicarrier in W-CDMA might be slow down further release adoption.

Release-8

Dual-Cell HSDPA operation on adjacent carriers

The version of carrier aggregation was first introduced in Release-8 with the feature called “Dual-Cell HSDPA Operation on Adjacent Carriers” This technique doubles the peak rate (with 64QAM) from 21Mbps to 42Mbps without the use of MIMO. This feature combines 2 carriers of adjacent 5 MHz bandwidth. A dual carrier user can be scheduled over either of the 5 MHz carrier.

The channel non-related to HSDPA technology stays in so called “primary serving cell”, the physical layer procedures rely also on this primary serving cell. The transport channel chain are independent, they perform coding, modulation and Hybrid Automatic Repeat request (HARQ) retransmissions separately in a similar fashion as MIMO. This feature is described in detail in the following chapter as it lays the base for all the evolution of multicarrier feature in HSPA.

Release-9

HSPA+ Enhancements for REL-9: Dual-Carrier HSUPA

The same needs in term of capacity drove the support for a similar dual-carrier in Uplink. Hence, the dual-carrier HSUPA operation on adjacent uplink carriers is introduced in Release-9. It relies on the same principle as DC-HSDPA: it then doubles the uplink rate up to 23 Mbps using 16QAM. Moreover, it is well know that UE in uplink condition is often more limited by the bandwidth rather than by the actual transmit uplink power. The advantage of DC-HSUPA in terms of data rate and availability are then substantial.

A DC-HSUPA user can transmit over two E-DCH 2 ms TTI transport channels, one on each uplink carrier. The user is served by a same NodeB, over two different cells, on the same sector. The secondary carrier can be activated or deactivated through HS-SCCH orders. Each active HSUPA carrier mechanism are largely independent from each other, they perform their own grant signaling, power control and soft handover.

One strong limitation of the DC-HSUPA is that it has to be configured with the DC-HSDPA operation; the secondary uplink carrier can only be active when the secondary downlink secondary is also active. The main reason is that the secondary downlink carries channel that are essential for uplink operation (F-DPCH, E-AGCH, E-RGCH, E-HICH). On the opposite the uplink secondary is not necessary for the secondary downlink operation since HS-DPCCH is always mapped on the primary uplink carrier.

Support for different bands for DC-HSDPA (Dual Band DC-HSDPA)

To provide additional operation mode to the DC-HSDPA release-8, where bands had to be adjacent, release-9 introduced supports for non-adjacent bands with the support of MIMO through a feature called dual-band DC-HSDPA (DB-DC-HSDPA) operation. It expands the operators' deployments possibilities which spectrum license is often distributed over several different bands. The throughput improvement to be expected compared to DC-HSDPA operation is little as it relies on the same principle, however performance might be increased thanks to the additional capacity gains from trunking and frequency domain due to the non- collocated bands having different propagations losses and interferences systems.

In DB-DC-HSDPA the uplink transmission is restricted to only one carrier. The uplink carrier can be configured by the network on any of the two frequency bands.

In Release-9, dual-band HSDPA operation is specified for three different band combinations, one for each ITU region:

- Band I (2100 MHz) and Band V (850 MHz)
- Band I (2100 MHz) and Band VIII (900 MHz)
- Band II (1900 MHz) and Band IV (2100/1700 MHz)

Release-9 left the possibility to add further band combination in the following releases matching release-9 requirements. In Release-10, the new combinations were added:

- Band I (2100 MHz) and Band XI (1450 MHz)
- Band II (1900 MHz) and Band V (850 MHz)

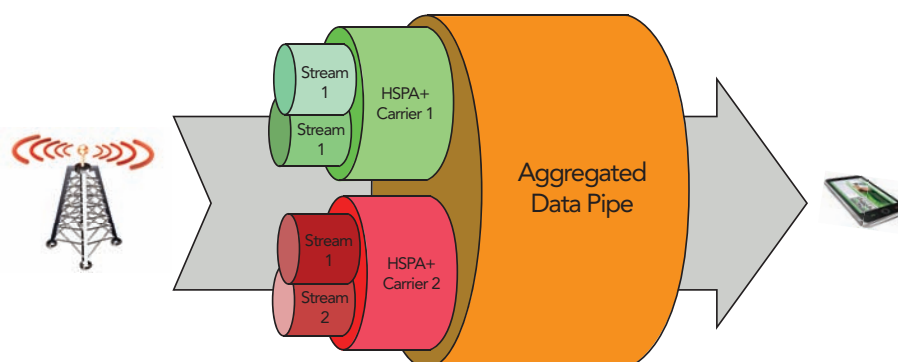

Figure 3 - Rel-9 - graphical representation of MIMO combined with CA.

Release 10

Four Carrier HSDPA

The support for four carrier non-contiguous HSDPA (4C-HSDPA) operation is introduced in Rel-10. It relies on the same principles as Rel-8 DC-HSDPA and the Rel-9 dual-band with MIMO. The 4C-HSDPA allows the NodeB to schedule one user transmission on up to four 5 MHz carriers simultaneously.

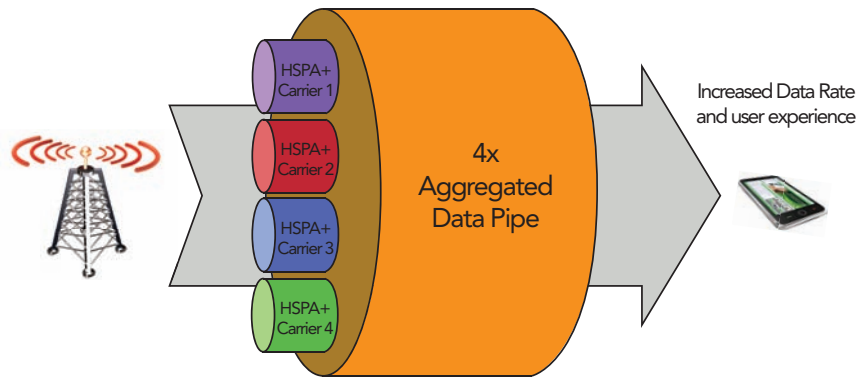

Figure 4 - Rel-10 4C-HSDPA graphical representation without MIMO.

Using the highest modulation scheme (64 QAM) and the downlink MIMO 2X2 configured on each downlink carriers it is possible to reach a theoretical peak data rate of 168 Mbps. It doubles the performance achievable with (DB)-DC-HSDPA.

For 4C-HSDPA the carrier usage can be spread over two frequency bands. The structure follows a similar structure as Rel-9 DB-DC-HSDPA operation. The following band combinations are supported (one for each ITU region):

- Band I (2100 MHz) and Band V (850 MHz):
One or two carriers in Band I simultaneously, as one or two carriers in Band V
- Band I (2100 MHz) and Band VIII (900 MHz):
Two or three in Band I simultaneously, as one carrier is configured in Band VIII
- Band II (1900 MHz) and Band IV (2100/1700 MHz):
One or two carriers in Band II simultaneously, as one or two 5 carriers in Band IV

It is also possible to configure only three adjacent carriers in Band I (2100 MHz). The possible 4C-HSDPA release-10 configurations are illustrated in Figure 5.

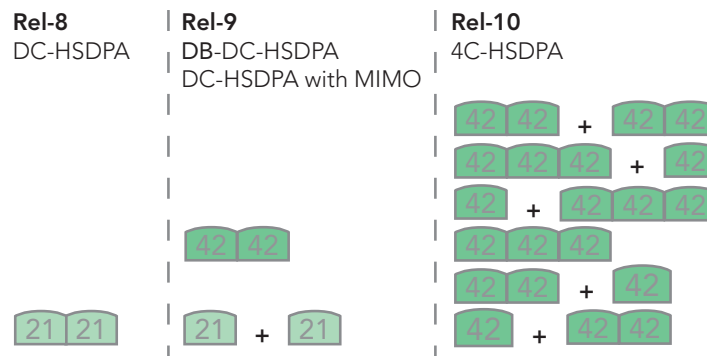

Figure 5 - Rel-10 4C-HSDPA Band combination.

Similarly as release-9, the further addition of band combinations is possible in the following releases.

The figure 5 shows that carriers are specified to be adjacent in release-10. This structure has been chosen for receiver integration simplicity, reducing the number of receivers required for a typical UE Release-10 compatible. However, from a protocol perspective, the specification allows non-contiguous bands.

The structure of 4C-HSDPA operation reuses to a large extent the L1/L2 solutions standardized for Rel-8 DC-HSDPA, and Rel-9 DC-HSDPA with MIMO.

- The L1 changes are limited to changes of the L1 feedback channel (HS-DPCCH).
More specifically, to accommodate the doubling in L1 feedback information, the spreading factor for this

physical channel was reduced from 256 to 128.

- The L2 changes are limited to increased UE buffer sizes for the RLC AM and MAC- (e)hs buffers, for example, and with 4C-HSDPA, this means that a UE can be scheduled in both the primary serving cell and the secondary serving cells over a total of four HS-DSCH transport channels.

As in previous multi-carrier features, HARQ retransmissions, coding and modulation are performed independently for activated downlink carriers and streams. The HS-SCCH orders transmitted by the serving NodeB also remain the mechanism to handle activation/deactivation of the secondary carriers.

In Release-10 a special work on supporting 3 carriers without MIMO was implemented. A new codebook was introduced to support those configurations and to maintain the similar HS- DPSCCH uplink coverage as in previous release.

Release-11

Carrier HSDPA – 8-Carrier HSDPA - 40 MHz of Carrier Aggregation

In Release-11, the potential of carrier aggregation with HSDPA is extended to up to 8 carriers with a potential use of 40 MHz aggregate within one UE. There is no need for the carrier to be adjacent, and it is possible to aggregate them from more than one frequency band.

In a similar fashion as other multi-carrier features standardized in Rel-8 to Rel-10. This feature is expecting to bring similar throughput gains. The peak throughput is theoretically doubled compared to the 4-carrier HSDPA from Release-10.

The deployment of 8C-HSDPA is limited to only one uplink carrier. The associated uplink signaling, which carries the CQI and Acknowledgements will be carried over two separate HS-DPCCHs. The solution standardized in Rel-10 for 4C-HSDPA will be reused: two SF128 channelization codes to transmit the associated signaling.

To support the increased bit rates, the L2 has been changed with a MAC-ehs window size increased. The RLC layer space is also increased. MIMO can be configured independently per carrier. The STTD and single-stream MIMO Mobility will be handled in similar fashion as Rel-10: uniquely based on the primary carrier.

Release 12 and Beyond

The aggregation of LTE and HSDPA was proposed in Release-11 by Nokia [R1-111060] but has been postponed to release 12. A study Item called “LTE and HSDPA Carrier Aggregation” is currently under investigation as part as release 12.

The idea of exploiting HSDPA and LTE as the same time came from the potential difficulties for operators needing to operate both technologies in parallel and facing the realities of limited spectrum availability.

The motivation behind any aggregation either in HSDPA or LTE is to provide higher peak rates to end users, being able to dynamically balance load over the multiple deployed carriers and provide best possible spectrum utilization. The same motivation is very much in place also in a multiradio environment, where both LTE and HSPA systems coexist. This inter-RAT carrier aggregation would provide gains for highest at low/medium load and they benefit both the cell edge and the cell center UEs.

Considering classical user profile seen on actual network which is very much bursty, inter-RAT load-balanced handover is clearly not a solution. Compared to an inter-RAT load balancing scenario, the usage of a combined scheduler would allow to dynamically balance the downlink load (TTI granularity) and would maximize the reuse of existing LTE and HSDPA multi-carrier implementations. The carrier aggregation scheduling is a MAC layer functionality, thus joint scheduling does from the model point of view require the MAC layer communications between LTE and HSDPA.

From an uplink perspective the aggregation is less appealing due to UE power consumption constrains and radio coverage.

On top of scheduling flexibility and data rate gains, HSPA+LTE aggregation would potentially bring more flexibility for re-farming strategies for HSPA spectrum.

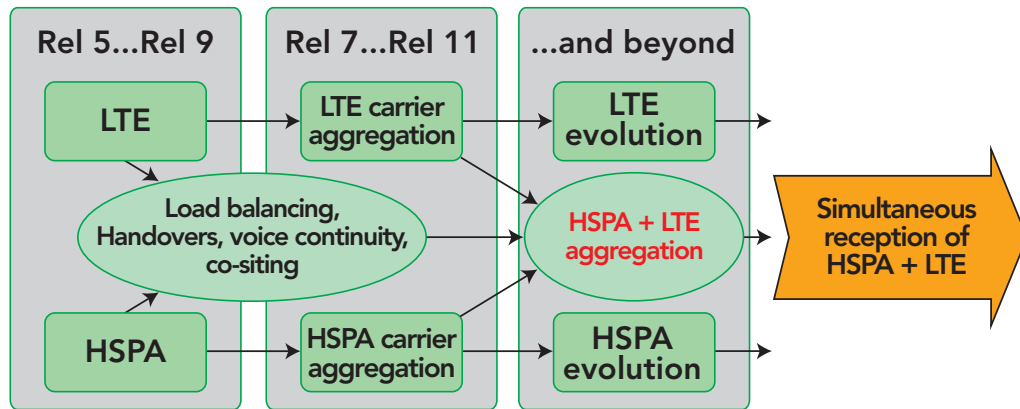

Figure 6 - Rel-12 and beyond : Aggregation LTE + HSPA.
(4Gamerica representation)

Detailed Principle of multicarrier in HSPA Release-8 and beyond

This section focuses on the Dual Carrier feature introduced in Release-8 called DC-HSPDA, which is part of the 3GPP multi-carrier evolution path. The structure of the multi-carrier principle in HSPA is evolving from this first implementation ground.

As stated previously, the basic idea of the multi-carrier is to achieve better resource utilization and spectrum efficiency by means of joint resource allocation and load balancing across the carriers. Thus, in the case of DC-HSDPA, two adjacent 5 MHz downlink carriers can be bundled by the network. The DC-capable HSPA UEs can be assigned resources simultaneously on both carriers. The dual-carrier is a natural evolution of HSDPA, allowing theoretically doubling the user peak data rate up to 42 Mbps using 16QAM.

However, the Dual-carrier is subjected to the following restrictions in 3GPP Release-8:

- The dual-carrier transmission only applies to HSDPA physical channels;
- The two carriers belong to the same Node-B and are on adjacent carriers;
- The two carriers do not use MIMO to serve UEs configured for dual-carrier operation;
- UEs configured in DC-HSDPA do not support transmit diversity closed loop mode 1 (CLM1), but only STTD.

However, as we have seen in the previous section, the HSPA evolution through the 3GPP releases overcomes the restriction by allowing different combinations of non-adjacent bands.

The dual-carrier offers higher resource utilization efficiency through dynamic multiplexing of users, improving the load sharing and allowing theoretically doubling the instantaneous data rates by assigning all the code and power resource to a single user in a TTI. By increasing transmission speeds the round-trip delay time is reduced. The 10 MHz bandwidth is also used to schedule UEs more efficiently around fading conditions, bringing frequency selectivity gain and improved QoS gain from joint scheduling.

Figure 7 illustrates how users could be scheduled according to fading conditions. Three users are considered, UE1 and UE2 are single-carrier devices and are respectively on carrier F1 and F2. The UE3 is a Dual-carrier device. Radio resources are shared between UE according to fading conditions.

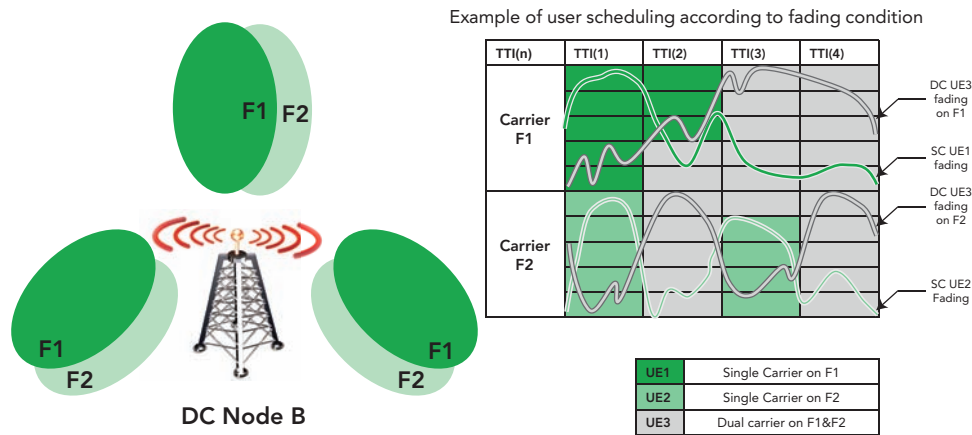

Figure 7 - DC Node B & Example of user scheduling according to fading condition.

We recall that NodeB and UE schedulers are vendors implementation dependent and are not fully standardized by 3GPP.

Of course the evolution to multicarrier also comes at the expense of UE and Node B complexity, for which hardware implementation is challenging. We will develop those aspects in testing section.

DC-HSDPA feature description

The 3GPP defines the two carriers in Release-8 and are referred as follows:

- The serving HS-DSCH cell (or Anchor carrier): the UE's anchor carrier has all the physical channels including DPCH/F-DPCH, E-HICH, E-AGCH, and E-RGCH. This carrier also has an associated uplink;
- The secondary serving HS-DSCH cell (or supplementary carrier): during dual carrier operation in CELL_DCH state, the UE's supplementary carrier is the downlink carrier which is not the UE's anchor carrier.

The Figure 8 shows channel DC operation: It can be noticed that the same cell can be primary cell to one UE and secondary cell to another. The UE Primary cell requires both HSUPA and F-DPCH in addition to DCHSDPA and has both DL and UL Tx, secondary cell has only DL Tx.

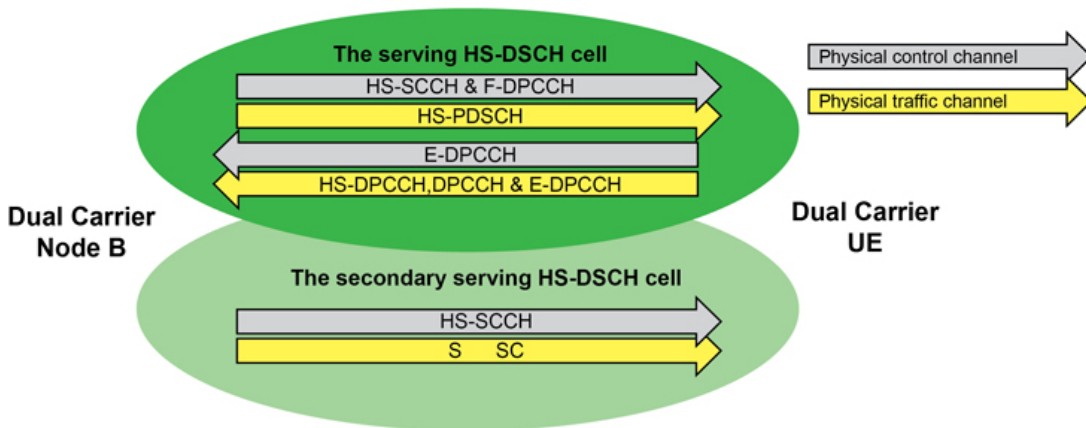

Figure 8 - Dual carrier channels mapping in DC-HSDPA.

The activation and deactivation orders of the secondary serving cell are signaled through new HSSCCH orders, with one bit indicating whether the HS-SCCH order is a secondary serving HS-DSCH cell activation or de-activation order [25.212].

Mobility procedures are supported based on the serving HS-DSCH cell. This does not pose any problem since the two cells are on adjacent carriers and thus experiment almost the same path loss from the various Node Bs.

The work on the physical layer specifications concentrated on the control channels design in order to support DC-HSDPA operations. The design choices are explained below.

HS-SCCH design

The UE monitors a maximum of 6 HS-SCCH in total (with a maximum of 4 HS-SCCH per carrier). This number was agreed as a compromise between limiting the complexity of UEs (Rel-8 HSDPA requires UEs to be capable of monitoring up to 4 HS-SCCHs on a single carrier), and limiting the blocking probability (i.e. the probability that a packet cannot be scheduled because there is no control channel available) which increases when the number of HS-SCCH decreases. Moreover, it was agreed that the HS-SCCH is mapped on the same carrier as the data transmission of the HS-PDSCHs it controls.

The UE shall be able to receive up to one HS-DSCH or HS-SCCH order from the serving HS-DSCH cell and up to one HS-DSCH or HS-SCCH order from the secondary serving HS-DSCH cell simultaneously.

The main advantages of controlling the activation/deactivation and user mapping of carriers through HS-SCCH are:

- Improved Dynamic load balancing: A multicarrier user can be configured by the S-RNC to have different primary serving cells, improving congestion management flexibility and potentially improving data rates.
- UE battery savings: Deactivating a particular carrier enables the UE switches off the corresponding receiver chain. This can yield significant battery savings in burst traffic scenarios.

ACK/NACK and CQI reporting

ACK/NACK and CQI reports are carried by a single-code HS-DPCCH. This choice was preferred to a dual-code HS-DPCCH design because the single code scheme outperforms the latter from a cubic metric perspective (i.e. is easier to handle by the UE transmit power amplifier, and requires a lower power margin), thus providing enhanced UL coverage.

The CQI reporting scheme reuses the MIMO solution, i.e. the CQI is 10 bits when the secondary serving cell is activated (like for dual-stream MIMO), instead of 5 bits otherwise (as for single-stream MIMO). When the secondary serving cell is activated, the composite CQI report is constructed from two individual CQI reports. The ACK/NACK reporting is also based on the solution for MIMO with 2 codewords transmission.

Performance

Performance comparisons of DC-HSDPA with 2xSC-HSDPA reported in [25.825] showed that DC-HSDPA increases the user and sector throughput for full-buffer traffic, especially in low load conditions. The gains depend significantly on the load in the system: The gain decreases as the number of users increases, because the multi-user diversity per cell (carrier) increases as well, thus reducing the performance difference between DC- and SC-HSDPA. Figure 9 shows the gain in sector throughput as a function of number of users per sector. As we can see, DC-HSDPA gain is more pronounced at low loads. At 2 users per sector, the gain in sector throughput is 25%. At 32 users per sector, it is 7%.

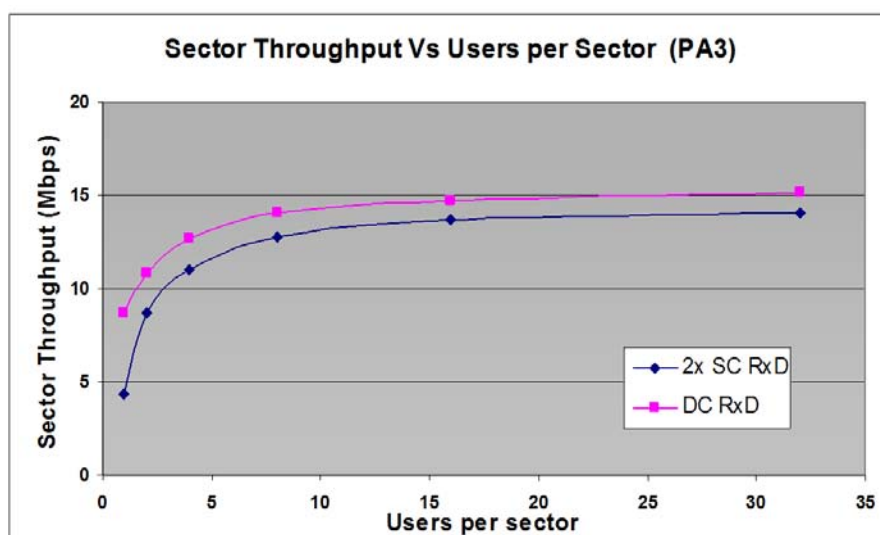

Figure 9 - Capacity gain from DC HSDPA over 2xSC-HSDPA [TS 28.825].

In addition, low geometry users gain more in terms of throughput than high geometry users.

The DC is highly beneficial to bursty traffic such as web browsing or VoIP. It has been shown that DC-HSDPA results in a doubling of burst rates for low to medium loads. At low to medium loads, for a given burst rate, DC-HSDPA can support more than twice the number of users when compared to 2xSC-HSDPA.

4 - LTE-A Carrier Aggregation

In Release-10 of the 3GPP specifications, the groundwork laid in Release-8 and Release-9 by DC-HSPA is introduced in the LTE-Advanced specification.

This functionality – known as carrier aggregation (CA) – is a core capability of LTE-Advanced. CA permits LTE to achieve the goals mandated by IMT-Advanced while maintaining backward compatibility with Release-8 and 9 LTE. LTE Advanced CA permits the LTE radio interface to be configured with any number (up to five) carriers, of any bandwidth, including differing bandwidths, in any frequency band. Carrier aggregation can be used for both FDD and TDD. In the following chapter, Release-10 principles are presented as well as the extension provided in Release-11.

Type of carrier aggregation

For downlink CA, the downlink and uplink can be configured completely independently, with only the limitation that the number of uplink carriers cannot exceed the number of downlink carriers. Each aggregated carrier is referred to as a component carrier, CC. The component carrier can have a bandwidth of 1.4, 3, 5, 10, 15 or 20 MHz. With a maximum of five component carriers, the maximum aggregated bandwidth is 100 MHz. Three types of allocation have been defined in 3GPP to meet different operator’s spectrum scenarios.

Intra-band contiguous

The simplest way for an operator to arrange aggregation would be to use contiguous component carriers within the same operating frequency band, so called intra-band contiguous. A contiguous bandwidth wider than 20 MHz is not a likely scenario given frequency allocations today, however it could be common in the future when new spectrum bands like 3.5 GHz are allocated in various parts of the world. The spacing between center frequencies of contiguously aggregated CCs is a multiple of 300 kHz to be compatible with the 100 kHz frequency raster of Release-8/9 and preserving orthogonality of the subcarriers with 15 kHz spacing.

Intra and Inter-band non-contiguous

Most operators in North America or Europe are currently facing the problem of a fragmented spectrum. The non-contiguous allocation has been specified to fit those scenarios, the allocation could either be intra-band, i.e. the component carriers belong to the same operating frequency band, but have a gap or gaps in between, or it could be inter-band, in which case the component carriers belong to different operating frequency bands. The different types of CA allocation are illustrated on the next page:

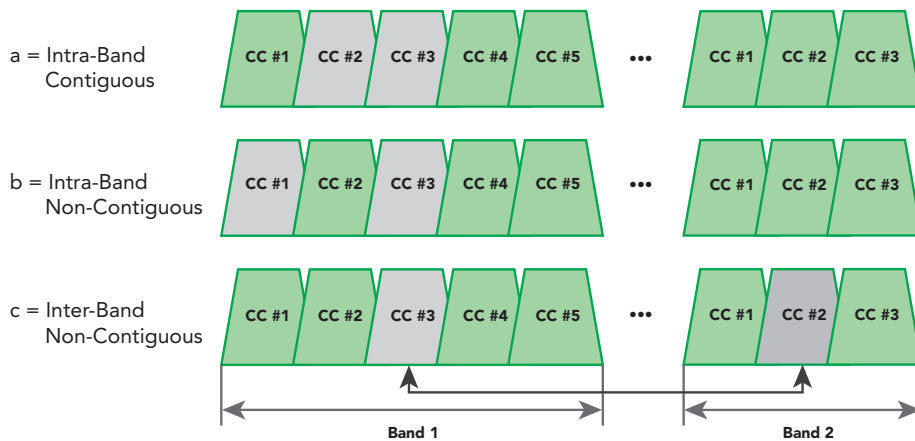

Figure 10 - Different type of CA allocation in LTE-A.

Deployment strategies

The possibilities enabled by the usage of several aggregated frequency bands allow a large variety of deployment

scenarios for the operator. In this section, some choices are presented.

Intra-Band Contiguous

- One of the probable scenarios is that F1 and F2 cells are co-located and overlaid, providing nearly an identical coverage. Both layers provide sufficient coverage, and mobility can be supported on both layers. Likely scenario is when F1 and F2 are on same band having a similar pathloss profile.
- Another scenario would be a diverse coverage where F1 and F2 are co-located: F2 antennas are directed to the cell boundaries of F1, or in F1 holes, so that the coverage is improved and/or the cell edge throughput is increased.

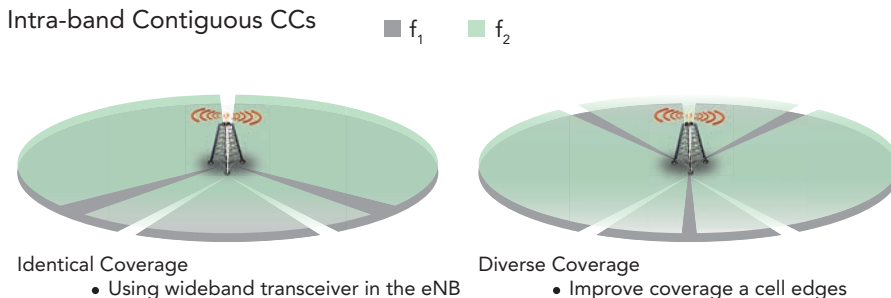

Inter-Band Non-Contiguous

The usage of non-contiguous bands changes the scenario possibilities for operators due to the different band propagation profile and hardware constrains.

- A Remote Radio Heads (RRH) scenario can be considered when F1 (lower frequency) provides macro coverage and RRHs on F2 (higher frequency) are used to improve throughput at hot spots. The mobility is performed based on F1 coverage. Likely scenario is when F1 and F2 are of different bands.
- In HetNet scenario, it can be expected to see numerous small cells and relays working on various frequency bands.

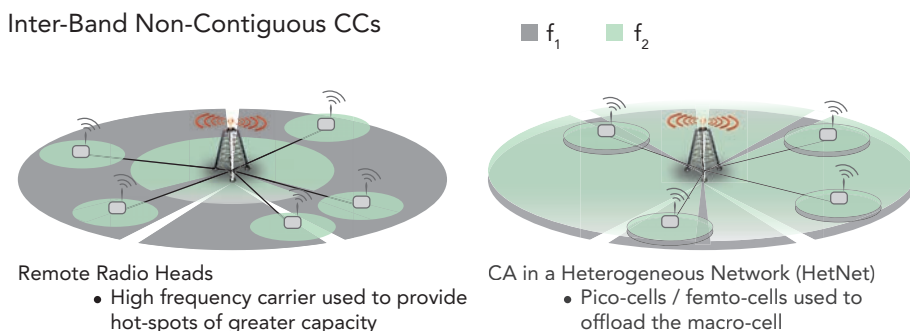

E-UTRA CA Bands Notation

With the introduction of CA in Release-10, the aggregation of bands has been specified for specific sets of CA Bands which correspond to a combination of E-UTRA operating bands. As we can see on the table 1 and 2, the CA configuration is mainly driven by operators who are focused on their needs based on their potential frequency blocks licensing. The formatting for the CA bands is as follows:

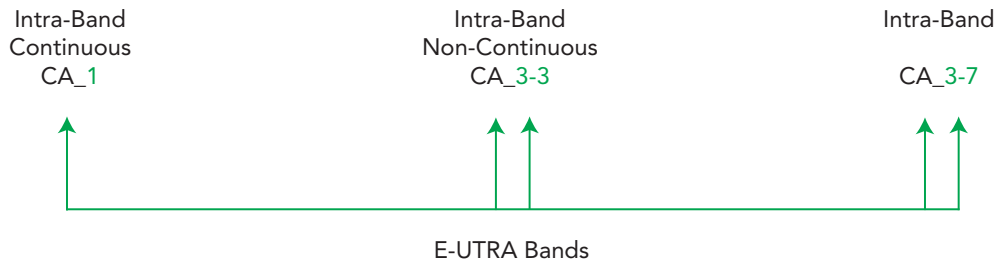

Intra-Band

In Release-10, the Intra-band carrier aggregation configuration is limited to two component carriers: one paired band (Band 1) and one unpaired (Band 40) band.

Carrier Aggregation Operating Bands						
3GPP Rel	Work Item Rapporteur	E-UTRA CA Bands	E-UTRA Bands	Uplink (UL) operating band BS receive/UE transmit $F_{UL,low} - F_{UL,high}$	Downlink (DL) operating band BS transmit/UE receive $F_{DL,low} - F_{DL,high}$	Duplex Mode
Rel-10		CA_1	1	1920 MHz - 1980 MHz	2110 MHz - 2170 MHz	FDD
		CA_40	40	2300 MHz - 2400 MHz	2300 MHz - 2400 MHz	TDD
Rel-11	Huawei	CA_38	38	2570 MHz - 2620 MHz	2570 MHz - 2620 MHz	TDD
	China Unicom	CA_7	7	2500 MHz - 2570 MHz	2620 MHz - 2690 MHz	FDD
	Clearwire	CA_41	41	2496 MHz - 2690 MHz	2496 MHz - 2690 MHz	TDD

Table 1 - Release Intra-Band contiguous CA operating bands (TS 36.101 r11).

Inter-Band

In Release-10, the Inter-band carrier aggregation case the configuration is limited to bands 1 and 5. Driven by operator worldwide demands, further studies in Release-11 are considered for instance to investigate “European” scenario for Bands 3 and 7.

Inter-Band Carrier Aggregation Operating Bands						
3GPP Rel	Work Item Rapporteur	E-UTRA CA Bands	E-UTRA Bands	Uplink (UL) operating band BS receive/UE transmit $F_{UL,low} - F_{UL,high}$	Downlink (DL) operating band BS transmit/UE receive $F_{DL,low} - F_{DL,high}$	Duplex Mode
Rel-10		CA_1-5	1	1920 MHz - 1980 MHz	2110 MHz - 2170 MHz	FDD
			5	824 MHz - 849 MHz	869 MHz - 894 MHz	
Rel-10	KDDI	CA_1-18	1	1920 MHz - 1980 MHz	2110 MHz - 2170 MHz	FDD
			18	815 MHz - 830 MHz	860 MHz - 894 MHz	
	NTT DoCoMo	CA_1-19	1	1920 MHz - 1980 MHz	2110 MHz - 2170 MHz	FDD
			19	830 MHz - 845 MHz	875 MHz - 890 MHz	
	NTT DoCoMo	CA_1-21	1	1920 MHz - 1980 MHz	2110 MHz - 2170 MHz	FDD
			21	1447.9 MHz - 1462.9 MHz	1495.9 MHz - 1510.9 MHz	
	AT&T	CA_2-17	2	1850 MHz - 1910 MHz	1930 MHz - 1990 MHz	FDD
			17	704 MHz - 716 MHz	734 MHz - 746 MHz	
	SK Telecom	CA_3-5	3	1710 MHz - 1785 MHz	1805 MHz - 1880 MHz	FDD
			5	824 MHz - 849 MHz	869 MHz - 894 MHz	
	TeliaSonera	CA_3-7	3	1710 MHz - 1785 MHz	1805 MHz - 1880 MHz	FDD
			7	2500 MHz - 2570 MHz	2620 MHz - 2690 MHz	
	Vodafone	CA_3-20	3	1710 MHz - 1785 MHz	1805 MHz - 1880 MHz	FDD
			20	832 MHz - 862 MHz	791 MHz - 821 MHz	
	Cox Communications	CA_4-12	4	1710 MHz - 1755 MHz	2110 MHz - 2155 MHz	FDD
			12	699 MHz - 716 MHz	629 MHz - 746 MHz	
	Ericsson/Verizon	CA_4-13	4	1710 MHz - 1755 MHz	2110 MHz - 2155 MHz	FDD
			13	777 MHz - 787 MHz	746 MHz - 756 MHz	
AT&T	CA_4-17	4	1710 MHz - 1755 MHz	2110 MHz - 2155 MHz	FDD	
		17	704 MHz - 716 MHz	734 MHz - 746 MHz		
Orange, Huawei	CA7-20	7	2500 MHz - 2570 MHz	2620 MHz - 2690 MHz	FDD	
		20	832 MHz - 862 MHz	791 MHz - 821 MHz		

Table 2 - Inter-Band CA operating bands (TS 36.101 r11).

UE Bandwidth Class

The introduction of CA renders the previous conceptions of “frequency band” and “bandwidth” ambiguous. Indeed, LTE systems can operate on variable bandwidth for a given band ranging from 1.4 MHz to 20 MHz. Therefore 3GPP has introduced terminology and notation which serve to more clearly express the radio interface configuration. The UE’s are defined by a CA Bandwidth Class.

For intra-band contiguous carrier aggregation, UE’s CA Bandwidth Class is defined according to their number of CCs supported and their Aggregated Transmission Bandwidth corresponding to Number of aggregated Resource Block (NRB, agg).

The following table summarizes the currently-defined carrier aggregation bandwidth classes in Release-11:

UE Bandwidth Class (TS36.101 r11)			
Bandwidth Class	Aggregated Transmission Bandwidth Configuration	Maximum number of CC	Aggregated Bandwidth Equivalent
A	$N_{RB,agg} \leq 100$	1	Up to 20 MHz
B	$N_{RB,agg} \leq 100$	2	Up to 20 MHz
C	$100 < N_{RB,agg} \leq 200$	2	20 MHz to 40 MHz
D	$200 < N_{RB,agg} \leq [300]$	For Further Study	
E	$[300] < N_{RB,agg} \leq [400]$		
F	$[400] < N_{RB,agg} \leq [500]$		

Table 3 - UE Bandwidth Class (TS36.101 r11).

CA bandwidth classes from D to F are at the time of this writing still under study.

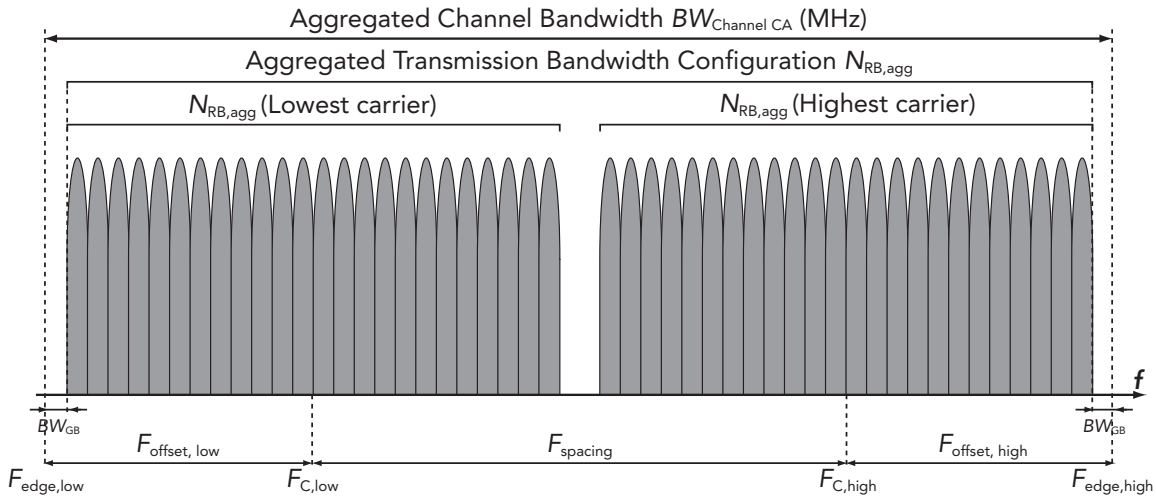

Figure 11 - Definition of Aggregated channel bandwidth and aggregated channel bandwidth edges.

Channel bandwidths per operating band for CA

After the Random Access Procedure, the UE capability procedure will take place to establish an ESP bearer. An LTE-Advance capable UE will report extra information to the network regarding its CA bands support capabilities. The capabilities are notified per frequency band, independently for downlink and uplink. It will define the proper carrier aggregation configuration set to be used.

The carrier aggregation configuration is a combination of operating bands, in association with the carrier aggregation bandwidth class of the UE, for each band. It determines which band to be used and the channel bandwidth allocated

on each operating band.

Here is an example of a configuration set for different scenarios:

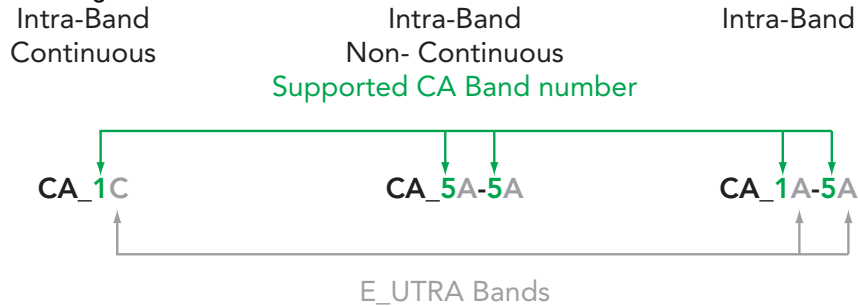

As example, the configuration CA_5A-5A indicates that the UE can receive or transmit two separate carriers in Band 5. The A gives the UE Bandwidth Class indicating, as explained previously, that the UE is capable to operate on a maximum of 100 Resource Blocks (RB) across both bands (Corresponding to a 20 MHz Bandwidth).

A UE can indicate support of several bandwidth combination sets per band combination of operating bands.

Combination set

Within the aggregation configuration, the UE can report a combination set, which defines where to allocate the resource blocks.

As example, the table give us two combination set for the CA_1C configuration.

1C configuration states that the UE can operate on Band 1, with 2 components carriers, with a maximum of 200 RB. The combination set then states that the allocation of those 200 RBs can be either 75 RB on both band or 100 RB on both band.

Intra-Band combination set

In the case of Intra-Band, the bandwidth combination set is defined by a number of consecutive resource block allocated on each component carrier. The combination is chosen among 50 RB (10 MHz), 75 RB (15 MHz) and 100 RB (20 MHz).

CA Configuration / N _{RB agg}							
CA Configuration	E-UTRA Bands	50RB+100RB (10 MHz + 20 MHz)	75RB + 100RB (15 MHz + 15 MHz)	75RB + 100RB (15 MHz + 20 MHz)	100RB + 100RB (20 MHz + 20 MHz)	Maximum aggregated bandwidth (MHz)	Bandwidth combination set
CA_1C	1		Yes		Yes	40	0
CA_7C	7		Yes		Yes		
CA_38C	38		Yes		Yes		
CA_40C	40	Yes	Yes		Yes	40	0
CA_41C	41	Yes	Yes	Yes	Yes	40	0

RB = Resource Block

Table 4 - E-UTRA CA configurations and bandwidth combination sets defined for Intra-Band Contiguous.

Inter-band combination set

Similarly to Intra-Band, Inter-Band has a bandwidth combination set defined for each carrier aggregation configuration, however the combinations rely on the channel occupied bandwidth instead of the number of resource blocks (see table 4). The 10 MHz allocation is supported by all the configurations, however the 5 MHz, 15 MHz and 20 MHz is less common, and the small bandwidth allocation, 1.4 MHz and 3 MHz, is only supported by one configuration so far in Release-11.

CA operating / Channel bandwidth									
CA Configuration	E-URTA Bands	1.4 MHz	3 MHz	5 MHz	10 MHz	15 MHz	20 MHz	Maximum aggregated bandwidth (MHz)	Bandwidth combination set
CA_1A-5A	1				Yes			20	0
	5				Yes				
CA_1A-18A	1			Yes	Yes	Yes	Yes		
	18			Yes	Yes	Yes			
CA_1A-19A	1			Yes	Yes	Yes	Yes	0	0
	19			Yes	Yes	Yes			
CA_1A-21A	1			Yes	Yes	Yes	Yes	35	35
	21			Yes	Yes	Yes			
CA_2A-17A	2			Yes	Yes				
	17			Yes	Yes				
CA_3A-5A	3				Yes	Yes	Yes	30	0
	5			Yes	Yes				
	3				Yes			20	1
	5			Yes	Yes				
CA_3A-7A	3			Yes	Yes	Yes	Yes		
	7				Yes	Yes	Yes		
CA_3A-20A	3			Yes	Yes	Yes	Yes		
	20			Yes	Yes				
CA_4A-12A	4	Yes	Yes	Yes	Yes				
	12			Yes	Yes				
CA_4A-13A	4			Yes	Yes	Yes	Yes		
	13				Yes				
CA_4A-17A	4			Yes	Yes			20	0
	17			Yes	Yes				
CA_7A-20A	7				Yes	Yes	Yes		
	20			Yes	Yes				

Table 5 - E-UTRA CA configurations and bandwidth combination sets defined for Inter- Band CA.

E-UTRAN Aspects

In support of CA, Release-10 introduces a distinction between a primary cell (PCell) and a secondary cell (SCell).

The PCell is the main cell with which the UE communicates as defined as the cell with which RRC signalling messages are exchanged, or equivalently by the existence of the physical uplink control channel (PUCCH), of which there is exactly one for a given UE. One PCell is always active in RRC_CONNECTED mode while one or more SCells may be active. Additional SCells can only be configured after connection establishment, in CONNECTED mode, to provide additional radio resource.

All PCells and SCells are known collectively as serving cells. The component carriers on which the PCell and SCell are based are the primary component carrier (PCC) and secondary component carrier (SCC), respectively. Physical Share Channels are transmitted on both (PDSCH/PUSCH).

- A PCell is equipped with one physical downlink control channel (PDCCH) and one physical uplink control channel (PUCCH).
 - The Measurement and mobility procedure are based on PCell.
 - Random access procedure is performed over PCell.
 - A PCell cannot be deactivated.
- An SCell could be equipped with a one physical downlink control channel (PDCCH) or not, depending on UE capabilities. An SCell never has a PUCCH.
 - MAC layer based dynamic activation/deactivation procedure is supported for SCell for UE battery saving.

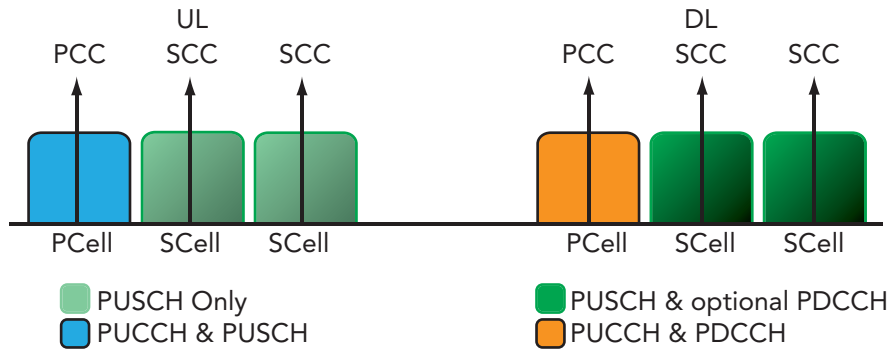

Figure 12 - Channel Mapping of PCell and SCell.

The relation between a Primary Cell (PCC) in downlink and uplink is signalled in the system information block type 2 (SIB type 2) on the logical broadcast channel (BCCH) carried by the physical shared channel (DL-SCH). The SIB2 contains radio resource configuration information that is common for all UEs. A PCC for a given UE is not linked to the cell configuration; the allocation is device based as described previously. The PCC allocation can however be modified by the network during handover procedures. Different carrier aggregation capable UEs within a cell can have different PCC on different band.

Impact of Carrier aggregation on signaling aspects

From the signaling aspect, the carrier aggregation is only impacting a limited number of protocol layers, the UE connected to the Primary Cell, will perceive the additional Secondary cells as additional resource to transmit data. Indeed, the procedures as Non-Access Stratum (NAS), key exchange or mobility are carried by the Primary Cell.

For the other layer such as Packet Data Convergence Protocol (PDCP) and Radio Link Control (RLC) layer, carrier aggregation signaling is completely transparent.

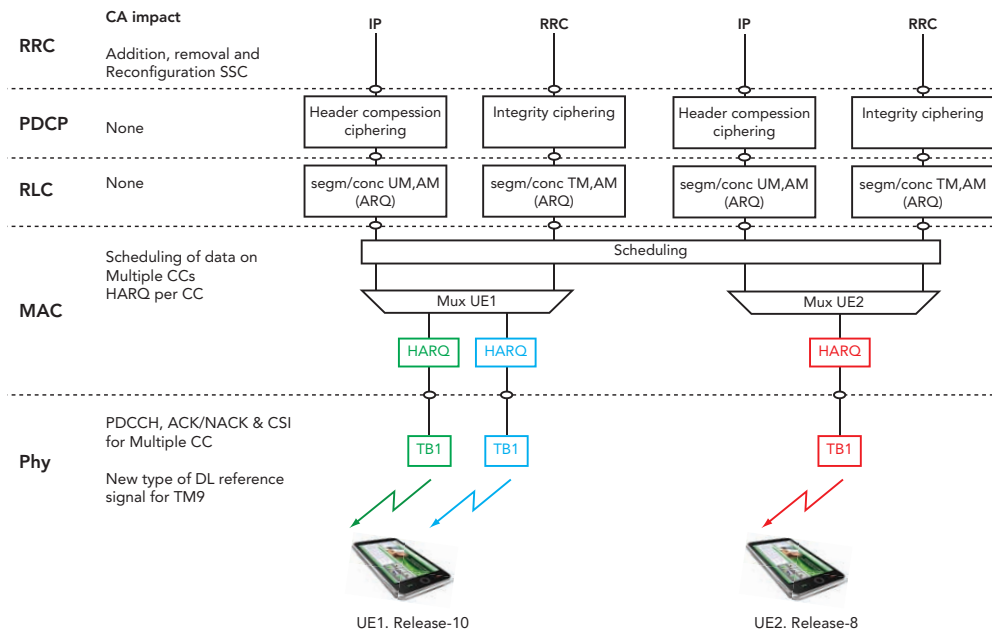

Figure 13 - Impact of Carrier Aggregation on transmission chain.

From a UE design perspective a minor aspect of the RLC was changed in comparison to Rel-8, the RLC layer has now to provide higher data rates by having a larger buffer size.

The UE category specified in TS 36.336 defines this buffer size. Three new categories, category 6, 7 and 8 are specified in Release-10 to support this buffer increase.

UE Categories (3GPP TS 36.306 R11)									
UE Category	Downlink					Uplink			
	Peak rate Mbps (DL/UL)	Max number DL-SCH TB bits/TTI	Max number DL-SCH TB bits/TTI	Total soft channel bits	Max SM Layers	Max number UL-SCH TB bits/TTI	Max number UL-SCH TB bits/TTI	Support 64QAM UL	
1	10/5	10296	10296	250368	1	5160	5160	No	
2	50/25	51024	51024	1237248	2	25456	25456	No	
3	100/50	102048	75376	1237248	2	51024	51024	No	
4	150/50	150752	75376	1827072	2	51024	51024	No	
5	300/75	299552	149776	3667200	4	75376	75376	Yes	
6	300/50	301504	149776 (4 layers) 75376 (2 layers)	3654144	2 or 4	51024	51024	No	
7	300/150	301504	149776 (4 Layers) 75376 (2 layers)	3654144	2 or 4	102048	51024	No	
8	1200/600	2998560	299856	35982720	8	1497760	1497760	Yes	

Table 6 - UE Categories (3GPP 36.366 r11).

It should be noted that category 6, 7 & 8 implicitly implies carrier aggregation support, however earlier UE category from 2 to 5, specified in Release-8, can also be capable of carrier aggregation.

Transport (MAC) layer aspects

From the Medium Access Control (MAC) perspective, the carrier aggregation simply brings additional conduits, the MAC layer hence plays the role of multiplexing entity for the aggregated component carriers.

Each MAC entity will provide to his corresponding CC its own Physical Layer (PHY) entity, providing resource mapping, data modulation, HARQ, and channel coding.

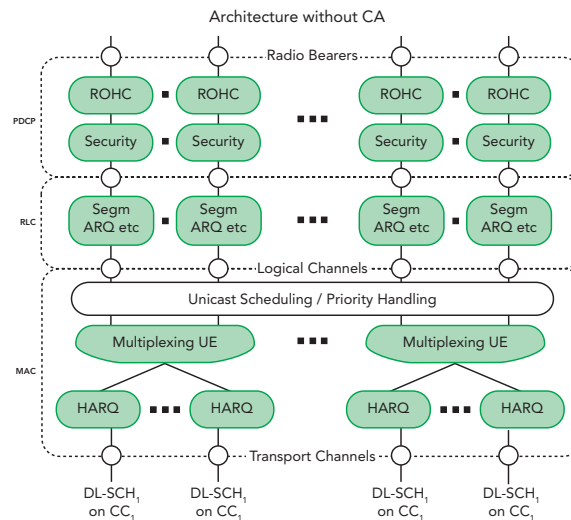

Figure 14 - Evolution of Architecture for LTE-A Carrier Aggregation.

Clearly, in order to take advantage of the aggregated bandwidth and produce the desired throughput increases, the base station's MAC layer scheduler must have knowledge of all active CCs. This differs from pre-Release-10 LTE schedulers, which need consider only one cell- carrier at a time.

In order for a CA-enabled base station's MAC scheduler to sequence downlink allocations and uplink grants optimally, it must consider the downlink and uplink channel conditions across the entire aggregated bandwidth. This increases the complexity of the base station scheduler and could result in some unusual scheduling outcomes. For example, the scheduler could decide to send all of a given UE's downlink transport blocks on CC1, but to receive all of that UE's uplink transport blocks on CC2.

In the absence of MIMO, a CA-enabled scheduler allocates, at most, one transport block per SCH per TTI. The HARQ processes delivering the various transport blocks within a TTI (across SCHs) are independent.

Carrier activation/deactivation and Discontinuous Reception DRX

The activation of an additional CC is done through MAC control element. When an additional CC is activated for a given subframe, the actual resource for scheduling is available 8 subframes later (8 ms). At this point, a new timer called sCellDeactivationTimer-r10 will also start, if no scheduling information is provided by the PDCCH within this timer, the SCell will be deactivated at the MAC layer.

The RRC Configured timer is the same timer for all SCells. As shown on Figure 15, the UE deactivates SCell if no activity before timer expires however, the deactivation of a given SCell can also be controlled by the network using using MAC header control elements.

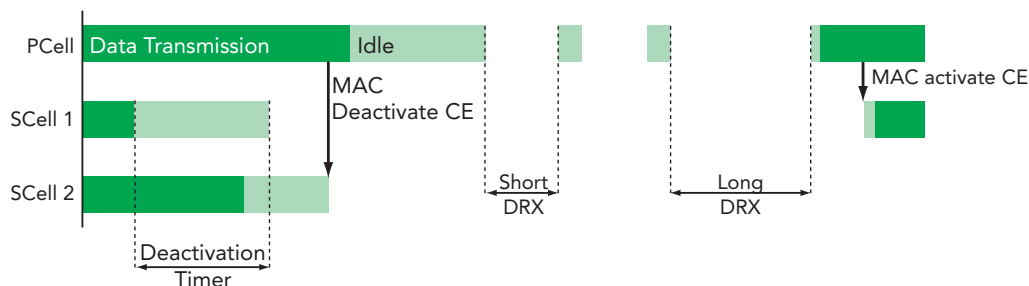

Figure 15 - SCell activation/Deactivation RRC timer.

As mentioned earlier, even with no traffic a PCell will always be active or in DRX mode.

Physical Layer Aspects

Downlink channel quality

Downlink channel quality in LTE Release-8 and 9 is estimated at the UE via the channel state information (CSI) Information Element (IE). In the absence of MIMO, CSI reduces to the familiar channel quality indicator (CQI). Release-10 does not change this, but the existence of multiple CCs means that CQI must be evaluated and reported for each CC individually when CA is active.

The CQI, as well as downlink HARQ ACK/NACK indicators and other information, is reported to the base station via the uplink control information (UCI) IE. As seen in previously, there is exactly one PUCCH and it is on the PCell regardless of the number of CCs, hence the UCI for each CC should be reported via this PUCCH if the terminal does not have a PUSCH configured. In order to distinguish which UCI belongs to a given CC, the header of the UCI contains a carrier indicator field (CIF)

Since it is possible to require the UE to report CQI periodically, and since UEs do not necessarily support simultaneous transmission of PUCCH and PUSCH, CQI also could be reported on the PUSCH, if the PUSCH happens to be active at the time of a periodic reporting instance.

Basically, in the context of CA, this means that CQI could be transmitted on an SCell if an SCell uplink burst is ongoing while a PCell burst is not.

Uplink control signaling

Uplink control signalling carried by the single PUCCH, when the terminal does not have a valid scheduling grant, had to be changed to support the increase HARQ Acknowledgements of the additional carriers. The Release-8 PUCCH known as format 1b with was only defined to support up to 4 bits, can only support a maximum of 2 CCs.

To enable terminals capable of more than two downlink component carrier and 4 bits of acknowledgement, a new PUCCH known as "format 3" in Release-10 has been defined.

It enables a full range of ACK/NACK to be transmitted bits: Up to 10 ACK/NACK bits for FDD and Up to 20 ACK/NACK bits for TDD. Instead of using Zadoff-Chu sequences as other PUCCH format it uses similar to PUSCH transmissions (DFT-S-OFDM). The HARQ are concatenated with Scheduling bit request, block coding is applied, followed by cell specific scrambling.

Uplink channel quality

Uplink channel quality, again per LTE Release-8 and 9, is estimated at the base station via sounding reference symbols (SRS) transmitted by the UE. CA implies that channel sounding could be required on multiple CCs. Release-10 introduces enhancements to permit the base station to request periodic SRS transmission on SCells in addition to PCells, though this function is optional at the UE.

Uplink transmit power control

Uplink transmit power control (TPC) commands are transported to the UE via the downlink control information (DCI) IE. The one PUCCH and one or more PUSCHs can be power controlled independently. TPC commands for the PUCCH are always received on the PCell's PDCCH. But the TPC commands for the SCells could be received either through the SCell's PDCCH, or through the PCell's PDCCH. Again, component carrier distinction is accomplished through the presence of the CIF in the DCI IE.

Downlink radio link monitoring

When operating in CA mode, the UE evaluates radio link quality and declares radio link failure only through the PCell. This is intuitive as the SCell represents only additional traffic channel bandwidth rather than a conduit for the channel control information.

From an operator network design perspective, it could be a performance advantage, due to superior propagation characteristics, to use the lower-frequency cells as PCells and the higher-frequency cells as SCells, particularly in the context of Inter-Band CA.

Timing and synchronization

The PCell and the SCell(s) are normally to be transmitted by the same base station. The path length between the base station and the UE therefore is normally to be the same for all carriers. This is the case regardless of frequency band. Thus, there is a single timing advance value applied to all uplink transmissions, regardless of whether they occur on the PCell or an SCell.

In the case of non-co-located cells belonging to the same NodeB such as HetNet scenario using Inter-Band carrier aggregations where antennas are distributed and connected via fibre links, the use of multiple timing advance is necessary.

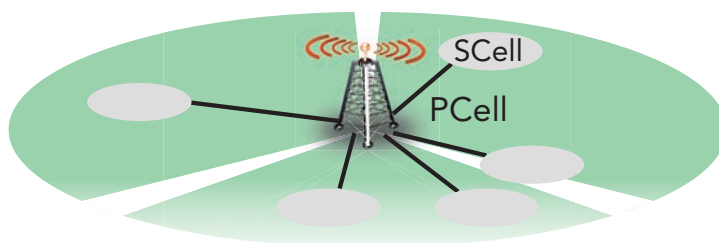

Figure 16 - Non co-located site, carrier aggregation.

Once the UE is synchronised with the PCell, it has to obtain synchronisation from the SCells situated in a different physical location. Immediately after the SCell activation, the NodeB PCell will request a RACH on the SCell. This RACH request is carried over PDCCH signalling from the PCell. This RACH is then used to measure the timing offset of the SCell.

In the case of multiple component carriers having same timing requirements, they will be group under a timing advance group in order to saving resource Control signalling. More than one timing advance group might be used in Hetnet deployment scenario.

Cross-Carrier scheduling

The Cross-Carrier scheduling is an optional feature for the UE introduced in Release-10, its activation is possible through the RRC during the UE capability transfer procedure. The objective of this feature is to reduce interference in Heterogeneous Network (HetNet) scenarios with carrier aggregation where a combination of macros, smalls-cells and relays is used. Cross-carrier scheduling is only used to schedule resources on an SCell without PDCCH.

As with other functionality described above, the carrier responsible for the delivering scheduling information in the

context of cross-carrier scheduling is indicated by the Carrier Indicator Field (CIF) in the Downlink Control Information (DCI). This scheduling also supports HetNet and asymmetric configurations.

The Figure 17 represents a case of CA scheduling (FDD). The CIF (Carrier Indicator Field) on PDCCH (represented by grey) indicates on which carrier the scheduled resource is located.

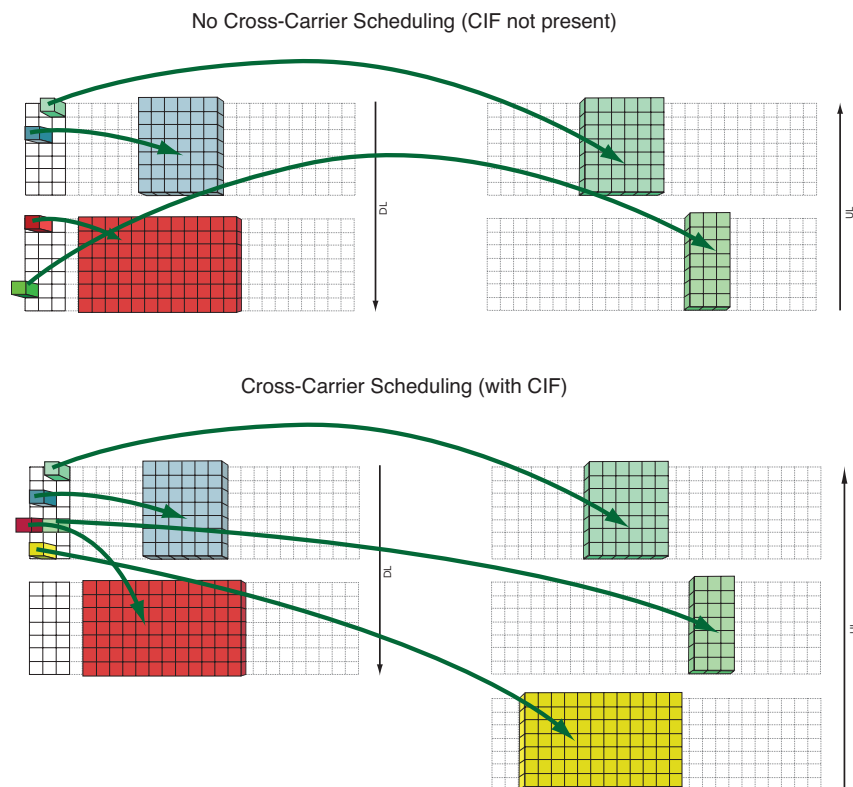

Figure 17 - Cross-Carrier scheduling.

It should be noted that a PCell cannot be cross scheduled; it is always scheduled through its own PDCCH

Another impact of the cross-scheduling is that the UE is not decoding the PCFICH on the Secondary Cell anymore, the number OFDM symbols is then unknown at beginning of each subframe. Hence, a mechanism referred to as PDSCH-Start allow the signaling of this information to the UE during activation of cross-carrier scheduling. The PDSCH-Start is ranging from 1 to 4 OFDM symbols based on the component carrier bandwidth

Radio Resource Control (RRC) Aspects

RRC UE Capability transfer procedure

Given the flexibility of CA, the E-UTRAN must be informed of the details of the UE's support for CA. This is accomplished via the RRC UE Capability Transfer procedure during the establishment of an EPS bearer. The CA-related information sent by the UE related to this procedure is summarized below:

UE category – CA support is implied by UE categories 6, 7, and 8. However it does not indicate the support for a particular carrier aggregation configuration, which is signalled separately.

Cross-carrier scheduling support – Indicates that the UE can receive scheduling orders regarding SCells from the PCell.

Simultaneous PUCCH and PUSCH transmission support – For CA-capable UEs, implies that the UE can support simultaneous PUCCH and PUSCH transmission on different CCs.

Multi-cluster PUSCH within a CC support – Indicates baseband (non-band-specific) support for multi-cluster PUSCH transmission within CCs. (Explained in testing section)

Non-contiguous uplink resource allocation within a CC support – Indicates that RF (band- specific) supports non-contiguous uplink resource allocations within CCs.

Supported band combinations – Indicates the specific frequency band and channel bandwidth configurations that the UE can utilize in support of CA.

Event A6 reporting support – Indicates that the UE is able to report Event A6, which occurs when a neighbor PCell becomes stronger than a serving SCell by an offset.

SCell addition during handover to E-UTRA support – Indicates that the UE can support E-UTRAN inbound inter-radio access technology (IRAT) handover directly into CA mode.

Periodic SRS transmission on all CCs support – Indicates that the UE can transmit periodic SRSs on all SCells.

The message exchanges can be summarized as follows:

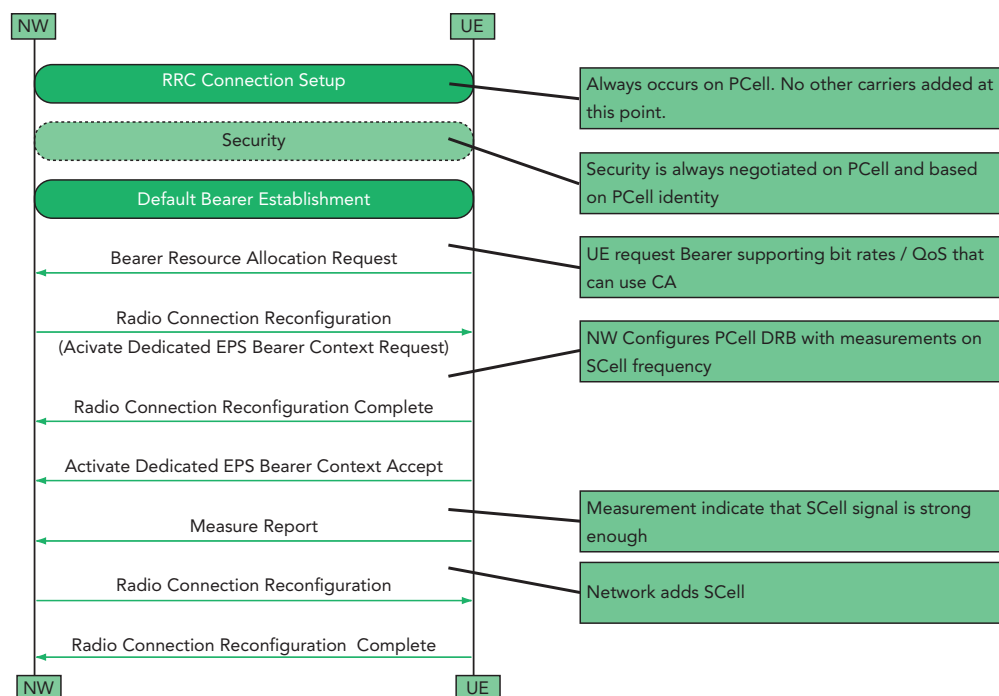

SCell addition and removal

The carrier aggregation additional SCells cannot be activated immediately at the time of RRC establishment. Thus, there is no provision in the RRC Connection Setup procedure for SCells.

SCells are added and removed from the set of serving cells through the RRC Connection Reconfiguration procedure. Note that, since intra-LTE handover is treated as an RRC connection reconfiguration, SCell “handover” is supported. The CA-related information sent by the base station pursuant to this the RRC Connection Reconfiguration procedure is summarized below.

- **Cross-carrier scheduling configuration** – Indicates, among other things, if scheduling for the referenced SCell is handled by that SCell or by another cell.
- **SCell PUSCH configuration** – Indicates, among other things, whether resource block group hopping is utilized on the SCell.
- **SCell uplink power control configuration** – Carries a number of primitives related to SCell uplink TPC, including the path loss reference linking parameter.
- **SCell CQI reporting configuration** – Carries a number of primitives related to CQI measurements reporting for SCells.

Handover

Handover processing for LTE in Release-10 is largely the same as Releases 8 and 9, except that clarifications are made to refer to PCell in the measurement-related RRC signaling messages.

Release-10 does introduce one new measurement event: Event A6. As indicated above, Event A6 occurs when a neighboring cell's strength becomes better than an SCell's strength by an offset.

In the case of Intra-Band SCell's, this event is less useful, as the strength of the PCell and the SCells usually is very similar. However, with Inter-Band serving cells, the strength of a neighbouring PCell could be significantly different from a serving SCell. Depending on network conditions – such as traffic load distribution – it could be advantageous to execute a handover to the cell identified by Event A6.

5 - Testing CA: Implementation and Verification Challenges

The implementation and the testing of CA is clearly challenging considering the range of options available in 3GPP standards for the designer to implement in hardware and algorithms.

In the following sections, testing will be covered from different perspectives. Potential design implementation choices and their impacts will receive special focus.

In the first section, RF Testing will be covered, including a closer look at the receiver and transmitter tests to be performed and the potential requirement for extensive intermodulation testing - specially in an intra-band environment.

In the second section, Protocol Development Testing will be covered, starting with basic Release 8 testing, then focusing on special features related to CA such as RRC procedures to add and remove SCells. A drill-down will be presented regarding signaling on the control channel (PDCCH/PUCCH) and resource allocations and grants on the shared channel (PDSCH/PUSCH).

The third section will focus on Performance Testing, and considerations such as maximum data rate, different fading on each CC, and device battery life will be investigated.

Finally, Conformance Testing will be explored, including new requirements introduced in Release 10 to support CA from the RF/ RRM and signaling perspective.

RF development testing

Historically, base stations have been designed to support multiple cells and multiple carriers, so are well-positioned to support CA. But CA represents a significant RF design change for UEs.

With the possible exception of the simplest CA scenario – contiguous CCs – there are substantial increases in transceiver complexity required to support CA. Non-contiguous downlink CCs necessitate multiple, independent receive chains at the UE.

Non-contiguous uplink CCs can be generated through multiple digital processing chains and a shared transmit front end (with various up-conversion options) as long as the CCs are Intra-Band. But in order to support Inter-Band uplink CCs, multiple independent transmit chains are required.

Due to the increase in transceiver complexity resulting from CA as well as requirements for newer operating bands, additional challenges exist to meet the UE transceiver performance standards established in Release-8, 9, and 10.

User Equipment (UE) transmitter and receiver aspects of Carrier Aggregation

Output power dynamics are correlated to UE architecture chosen, which can be based on a single or multiple Power Amplifiers (PAs). The following figures illustrate a mix of options considered by 3GPP as possible implementations for UE Power Amplifier (PA) architectures to support the different types of carrier aggregation.

Intra-Band scenario

- Intra-Band Contiguous

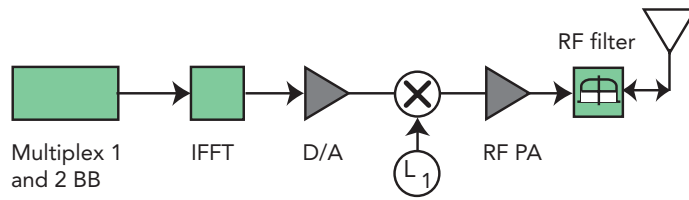

Single (baseband + IFFY + DAC + mixer + PA)

• Intra-Band Contiguous and Non Contiguous

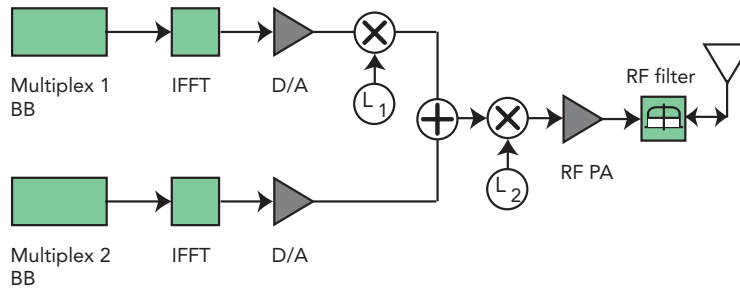

Multiple (baseband + IFFT + DAC),
Single (stage-1 IF mixer + combiner @ IF + stage-2 RF mixer + PA)

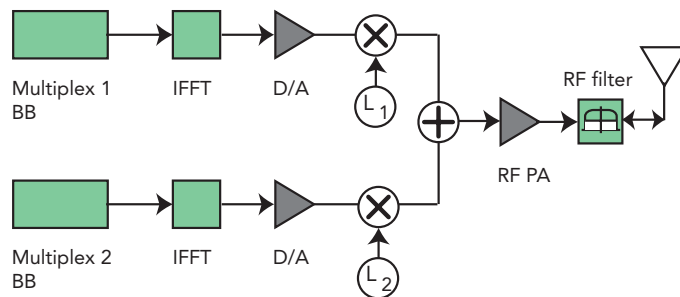

Multiple (baseband + IFFT + DAC + mixer),
Low power combiner @ RF, and single PA

Inter-Band scenario

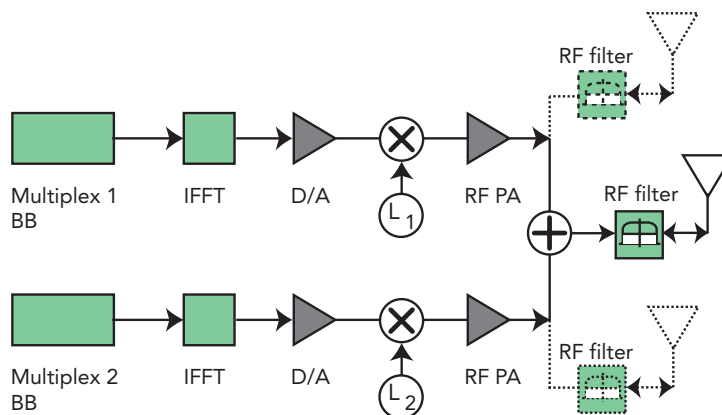

Multiple (baseband + IFFT + DAC + mixer + PA), high-power combiner to single antenna OR dual antenna (MIMO) 3GPP TR 36.815 further advancements for E-UTRA; LTE-Advanced feasibility studies in RAN WG4

Looking at the different architectural designs, the fundamental choice when it comes to Carrier Aggregation design are basically either a wideband or a narrowband approach:

- **Wideband transceiver to cover all bands** - implying the use of expensive wideband RF components and ultra-high performance ADCs/DACs with baseband processing bandwidth ≥ 20 MHz. Designing wideband transceivers brings numerous challenges:
 - Frequency dependent path loss: Path loss increases nonlinearly with higher frequencies.
 - Doppler frequency shift: Doppler effects increase at higher frequencies
 - Noise power: The effective noise increases with bandwidth
 - Receiver input signal: Wider bandwidth receivers mean that more unwanted signals will be received from other sources
 - Nonlinearity of components in analog receiver: Demodulation can be affected by distortion and intermodulation created by additional signals.
 - Maximum input signal: The receiver must have sufficient dynamic range to avoid overload conditions.

Clearly, the coverage of all the bands by only one transceiver chain is only applicable for intra-band aggregation of contiguous CCs, but it has the advantage of keeping the UE receiver complexity low.

- **Multiple narrowband transceivers to cover each band** - with the disadvantage of increased complexity and cost for each band, and baseband processing bandwidth ≤ 20 MHz. This design is applicable for both intra-band contiguous and non-contiguous as well as inter-band aggregations. Since Inter-Band CA requires a second transmit chain, it leads inevitably to a more complex device design, with higher power consumption impacting the device battery life. In Release 10, a complete narrowband approach could lead to the use of 16 transceivers assuming 2 CCs and 8x8 MIMO in the Downlink.

From an RF perspective, Intra-Band Contiguous aggregated carriers have similar properties to a corresponding wider bandwidth carrier being transmitted and received. The inter-band architecture represents a major challenge for UE design since multiple simultaneous chains have to coexist.

The radio environment and frequency plan for the UE are also challenging in terms of intermodulation and cross-modulation. There is a need to design front-end components that help reduce harmonics and other intermodulation products to meet 3GPP requirements.

As for any system, the PA configuration needs to be tuned to remain in the linear region by taking into account any additional back-off requirements. Back-offs must be minimized, however, since this comes at the expense of lower power efficiency and shorter battery life.

The factors that determine the necessary UE PA back-off come from the 3GPP requirements specifically for carrier aggregation [TS 36.521].

On the transmit side - conformance to peak and dynamic output power, output signal quality, adjacent channel leakage, spurious emissions, and intermodulation standards must be verified in the context of CA and new operating bands.

On the receive side - sensitivity, selectivity, blocking, spurious response, intermodulation, and spurious emissions must be verified under the same conditions.

LTE-A uplink with multiple carriers

The new multiple SC-FDMA and clustered DFT-S-OFDMA waveforms supported in Release 10 (due to carrier aggregation and the concurrent transmission of PUSCH and PUCCH) impose more stringent linearity requirements on the PA than was the case for LTE Release-8 and 9. The UE will need to use less transmitter power for the amplifier to remain in the linear region.

Small resource assignments at the band edge behave as tones, and hence may produce highly concentrated Inter-Modulation Distortion (IMD) products. Therefore, for the concurrent transmission of PUCCH and PUSCH, the Spectral Emission Mask (SEM) is expected to be the limiting requirement (as it is, for instance, for LTE Release-8 with full resource block allocation).

Clustered DFT-S-OFDM

The Single Carrier Frequency Division Multiplexing (SC-FDMA) technology chosen by 3GPP in Release-8 was more suitable than classical OFDMA for the uplink transmission because of its advantageous low Peak-To-Average Power Ratio (PAPR) property. A low PAPR avoids the generation of nonlinearities (transmit and modulation harmonics). In brief, in SC-FDMA systems, the data symbols are transmitted serially in the time domain rather than in parallel as in OFDMA, thus reducing the envelope fluctuations in the transmit waveform.

The introduction of multiple CCs puts further constraints in SC-FDMA signal generation. It will not be possible to maintain the single carrier property for transmission bandwidth larger than a single CC because the edges of each CC are usually reserved for uplink control channels.

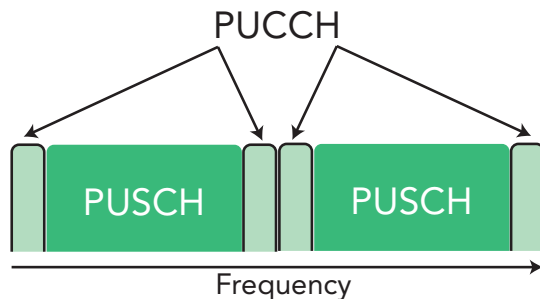
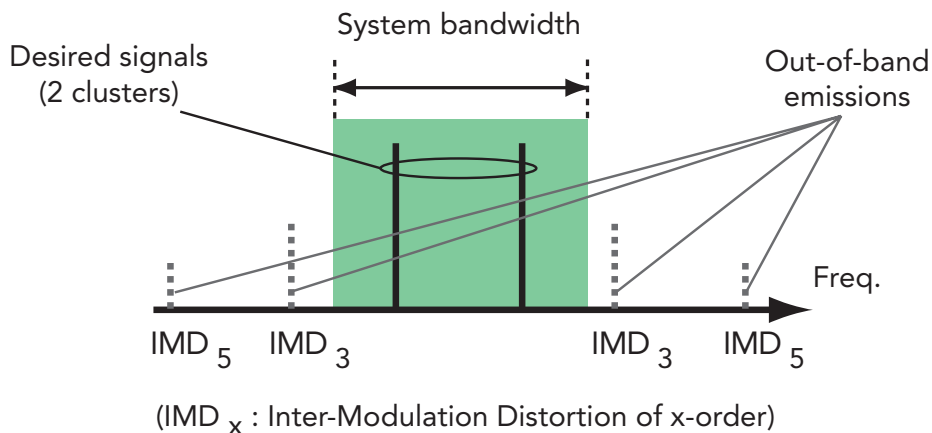

Figure 18 - Example of contiguous aggregation of two uplink CCs without clustering.

In Release 8 the SC-FDMA scheme was referred as DFT-spread-OFDMA. A new uplink waveform has been introduced in Release 10 called clustered DFT-S-OFDM or (NxDFT-s-OFDM) to support multiple uplink transmission over CCs. The DFT-spread signals are divided into several frequency components and then mapped non-contiguously on the frequency resource. Hence, improvement of cell throughput is expected through enhanced channel-dependent frequency scheduling, where frequency resources with good channel quality are assigned to each UE.

The new transmission scheme over several CC means that a larger power back-off is required in order to avoid the generation of non-linearities, and hence shorter battery life when transmitting. However, this scheme has been chosen by 3GPP as it is backward compatible with previous versions and is still more efficient in term of PAPR (or Cubic Metric) than classical OFDMA [ref AAU].



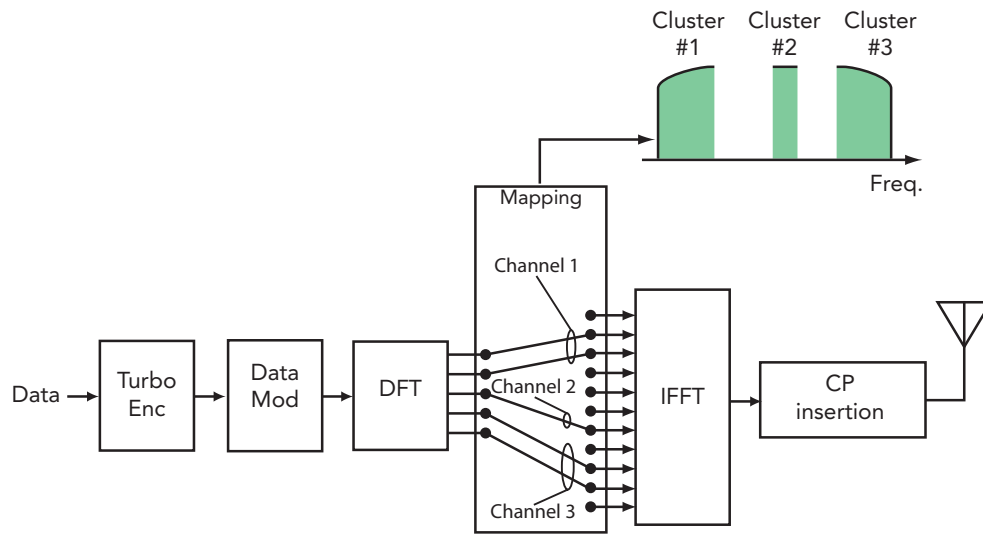

Figure 19 - Representation of clustered DFT-Spread-OFDDM.

Solutions to generate RF LTE-A CA signals

Anritsu's MG3710A Vector Signal Generator is an ideally suited solution to produce LTE-A signals for the downlink and uplink and to perform R&D testing on front-end devices or base station radio components.

MG3710A can generate all CA signal in one unit

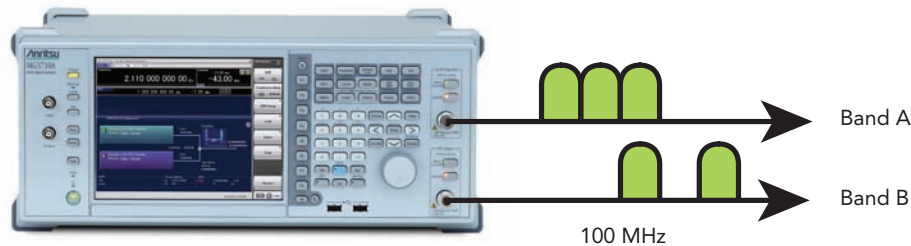

Figure 20 - MG3710A Vector Signal Generator.

- LTE-A uplink and downlink signals
- FDD and TDD LTE
- Up to 5 component carriers
- 160 MHz BW generation
- Inter-Band non-contiguous generation with Dual RF

Using the graphical, PC-based application IQ Producer connected to the signal generator, it is straightforward to generate the required waveform for your RF testing. The generated waveform patterns are in compliance with the LTE FDD and TDD specifications in 3GPP TS 36.211, TS 36.212, and TS 36.213 standards. The signal can also be created and generated automatically by just pushing a “Capture & Play” button directly on the equipment itself.

IQProducer: In easy setup mode, options are limited to the main parameters. LTE-Advanced waveform patterns can be generated by setting bands for the carrier aggregation mode and component carriers.

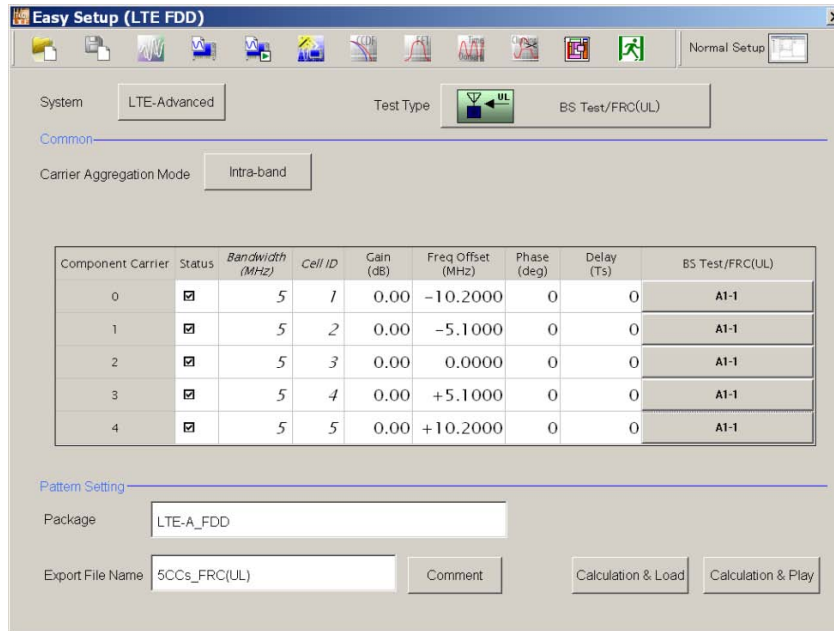

Figure 21 - IQ Producer interface setting panel for easy setup (TS36.141).

Solutions to analyze RF LTE-A CA signals

Anritsu's MS269x and MS2830A Vector Signal Analyzers offer sophisticated measurements of both the LTE uplink and downlink, with optional integrated Vector Signal Generator capability. Measurement technology developed by Anritsu allows modulation analysis to be measured in 1 sweep for the maximum of 5 component carriers specified for LTE-A. Measurement results, such as EVM and frequency error, are available for each band and component carriers on one unique screen, improving testing efficiency.

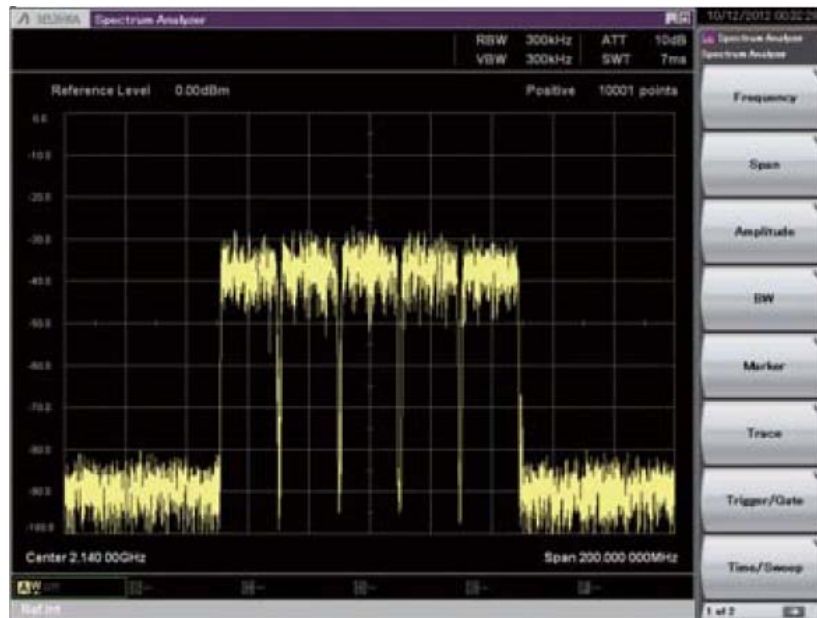

Figure 22 - Spectrum analyzer MS269x/MS2830A .
Example of Spectrum of LTE- Advanced signal (Component Carrier: Bandwidth 20 MHz, 5CC)

Result		Average & Max		10 / 10	
Band	#0	#1	#2	#3	#4
Center Freq [MHz]	2110.00	1960.00		1842.50	
Status					
Storage Count	10 / 10	**** / ****		**** / ****	
Modulation Analysis					
Freq Error [Hz]	0.04 / 0.69	0.09 / 0.60	0.02 / 0.71	0.33 / 1.10	0.37 / 0.97
PDSCH EVM [%]	0.86 / 0.90	0.81 / 0.86	0.79 / 0.77	0.79 / 0.83	1.03 / 1.06
Band Power [dBm]	-5.89 / -5.89	-13.06 / -13.06	-12.69 / -12.69	-12.74 / -12.74	-12.86 / -12.94
RS Power [dBm]	-43.66 / -43.66	-43.83 / -43.83	-43.47 / -43.47	-43.52 / -43.52	-43.63 / -43.62
OSTP [dBm]	-12.86 / -12.86	-13.03 / -13.03	-12.68 / -12.68	-12.73 / -12.73	-12.84 / -12.83

CC	#0	#1	#2	#3	#4
Band	#0	#0	#0	#0	#0
Freq Offset [MHz]	-39.60	-19.80	0.00	19.80	39.60
Freq Error [Hz]	-0.48 / -1.06	-0.02 / 0.60	0.02 / 0.71	0.33 / 1.10	0.37 / 0.97
PDSCH EVM [%]	0.93 / 0.90	0.81 / 0.86	0.79 / 0.77	0.79 / 0.83	1.03 / 1.06
CC Power [dBm]	-13.05 / -13.05	-13.07 / -13.06	-12.69 / -12.69	-12.74 / -12.74	-12.86 / -12.94
RS Power [dBm]	-43.84 / -43.83	-43.83 / -43.83	-43.47 / -43.47	-43.52 / -43.52	-43.63 / -43.62
OSTP [dBm]	-13.04 / -13.04	-13.03 / -13.03	-12.68 / -12.68	-12.73 / -12.73	-12.84 / -12.83

Figure 23 - Measurement software MX269020A-001.
Example of Batch Measurement Result Display (Component Carrier: CC #0 to #4)

One-Box test solutions for LTE-A CA

Anritsu's MT8821C Radio Communication Analyzer offers highly accurate RF measurements for LTE-A CA UEs, and includes LTE network simulation capability to allow for measurements in a call or with no call processing. Both LTE FDD/TDD formats are supported, including broad calibration and functional test capability. When used in the LTE-A Carrier Aggregation mode, the MT8821C provides options for up to 8 RFs for support of up to 4 downlink carriers with 2x2 MIMO in one box.

One-Box test solutions for LTE-A CA

Anritsu's MT8820C Radio Communication Analyzer offers highly accurate RF measurements for LTE-A CA UEs, and includes LTE network simulation capability to allow for measurements in a call or with no call processing. Both LTE FDD/TDD formats are supported, including broad calibration and functional test capability.

When used in the LTE-A Carrier Aggregation mode, the MT8820C provides options for 2 carrier SISO testing using 1 MT8820C, or 2 carrier 2x2 MIMO testing using 2 MT8820Cs.

Protocol Development Testing

Since CA was designed specifically to be backward-compatible with Release-8 and 9 carriers, most of the procedures employed in Release-10 function in a manner similar to the previous releases. Some of the basic protocol extensions to support CA include:

- Radio Resource Control (RRC) supporting the addition and removal of SCells through RRC reconfiguration.
- PDCCH control signaling on multiple CCs simultaneously.
- PUCCH control signaling on a single CC with information pertaining to each CC.
- PDSCH allocations on multiple CCs simultaneously.
- PUSCH grants on multiple CCs simultaneously.

These "fundamental" protocol extensions must be part of any CA verification effort. In addition to these basic protocol extensions for CA, there are numerous protocol extensions, directly related to CA or with implications in the context of CA, which are optional for the UE.

Some of them are:

- RRC support for SCell measurement reporting (Event A6).
- IRAT handover to E-UTRAN with active SCells.
- Cross-carrier scheduling (one PDCCH serving multiple PDSCHs).

- Simultaneous PUCCH and PUSCH transmission.
- Multi-cluster PUSCH within a CC.
- Non-contiguous uplink resource allocation within a CC.
- Periodic SRS transmission on all CCs.

Clearly, the power and flexibility of the Carrier Aggregation function demands advanced, flexible verification.

Anritsu protocol testing solution

Anritsu has integrated the key Carrier Aggregation protocol components in its leading edge protocol test systems.

The Anritsu MD8430A LTE Signaling Tester combined with Rapid Test Designer (RTD) is the most comprehensive and flexible solution for protocol development system for next-generation wireless UEs implementing LTE-A Carrier Aggregation.

The RTD solution is firmly established as a proven multi- standard graphical flow chart tool for many test activities from chipset developers and handset integrators to network operators.

RTD is designed to simulate the many different legacy networks that may be deployed alongside LTE such as W-CDMA, GSM and C2K-based technologies. It allows the user to define a wide range of handover scenarios and can also be integrated into systems that go beyond “over the air protocol” and provide performance and evaluation of many other critical parameters.

RTD’s unique flowchart solution allows graphical connection of signaling blocks to define test flows, with no programming language expertise required to create custom-designed protocol scripts. The development environment includes functional blocks for layer 1 to layer 3 signaling. Scenario creation is easy using test package libraries and extensive procedure libraries with preconfigured messages and signaling.

The following figure outlines the RTD capabilities related to LTE-A Carrier aggregation:

CA – LTE-A Protocol testing capabilities

- DL Carrier Aggregation
 - DL : 2x2 MIMO with 2CCs [Rel.10]
 - UL : SISO 1CC
- Category 6 UE support 2 layers
 - L1 T-put 300 Mbps,
 - L2 T-put 150 Mbps.
- Simultaneous PUCCH/PUSCH
- Cross Carrier Scheduling
- PUCCH format 3
- FDD/TDD

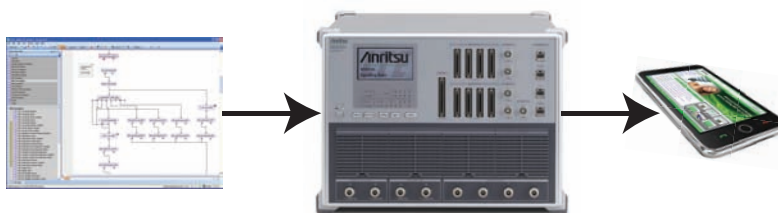

Figure 24 - Overview of CA Anritsu testing capabilities.

Practical example of protocol testing for carrier aggregation

Testing complex UEs fitted with multi-mode roaming capability across a wide range of network scenarios is essential to prove a design. RTD provides a cost-effective and rapid solution to design custom scripts through use of preconfigured scenarios. In this section, we explore some representative CA testing possibilities offered by RTD to analyze the complex algorithms involved in the protocol stack.

Here is a summary of the development operations that RTD allows the user to perform using the user-friendly graphical interface and potential to connect several different legacy network technologies:

- Core Operation
 - Carrier Aggregation UE Capability Reporting
 - Secondary Cell Addition, Modification and Release
 - Secondary Cell Activation/Deactivation
 - Measurement Reporting and Event Handling
 - CDRX

- Mobility Scenarios
 - Secondary Cell Mobility without Primary Cell Handover
 - Primary Cell Handover with Secondary Cell Mobility
- Failure and Negative Testing
 - Invalid Configuration Handling
 - Radio Link Failure/RRC Connection Re-establishment
- Battery Life Testing

Creation of CA scenario

Use existing scenario and configure each stage or create your own scenario: drag and drop the procedure.

Pick the procedure from the library:

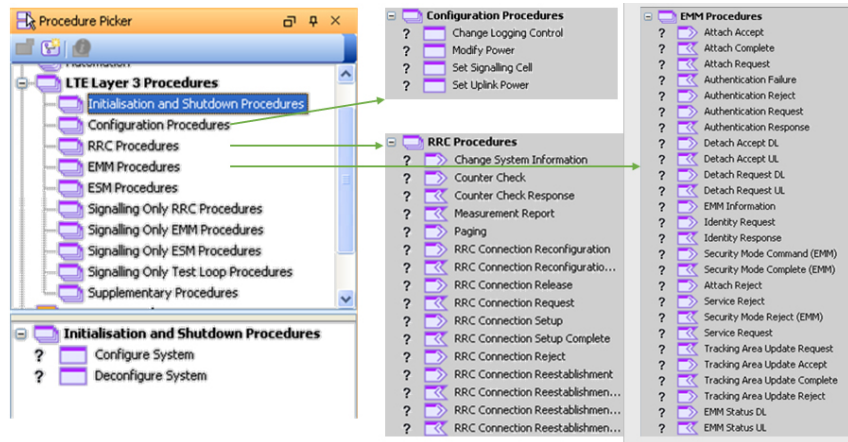

Create your own logical flowchart.
High level view:

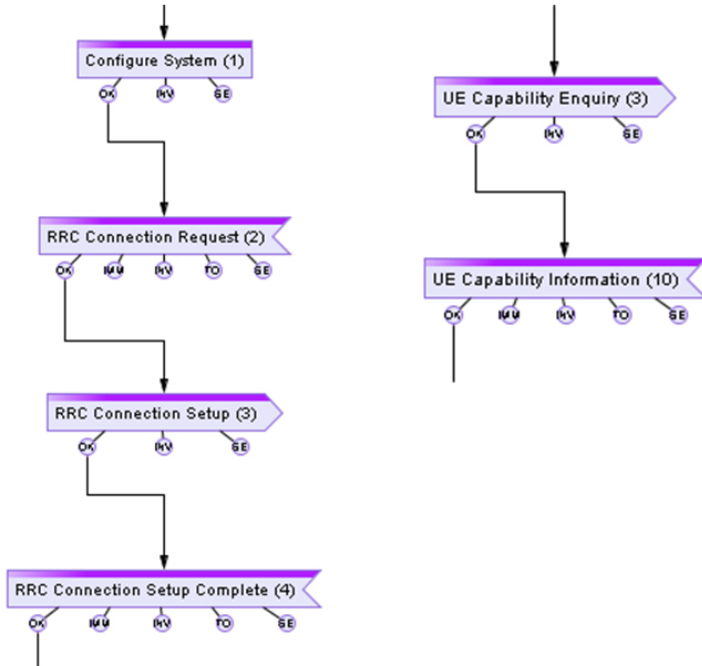

Complete RRC connection setup procedure is managed purely at L3.

All L1/L2 configurations are derived from the L3 messages and configuration parameters of Configure system and RRC connection.

The flowchart acts as a running test script controlling the message exchange with the DUT. It allows the user to accurately establish correct device behavior.

Example of flow related to carrier aggregation:

The flow chart has events that can be manually triggered using the event panel.

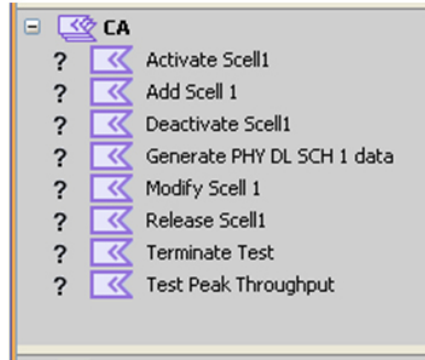

Setup of CA for 2 Carriers for Band 4 and 17

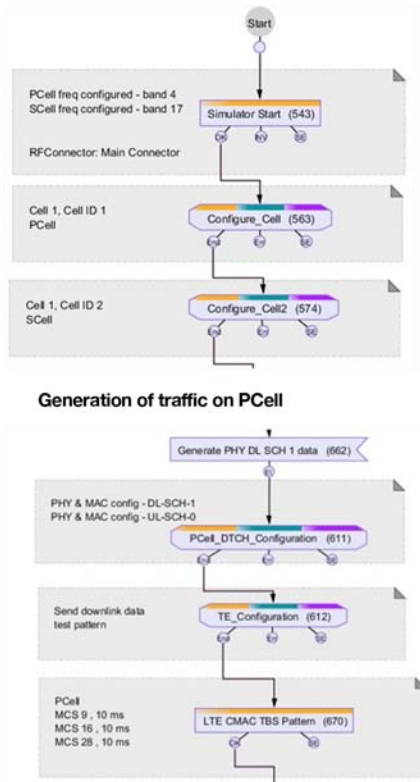

SCell 1 - Addition and configuration

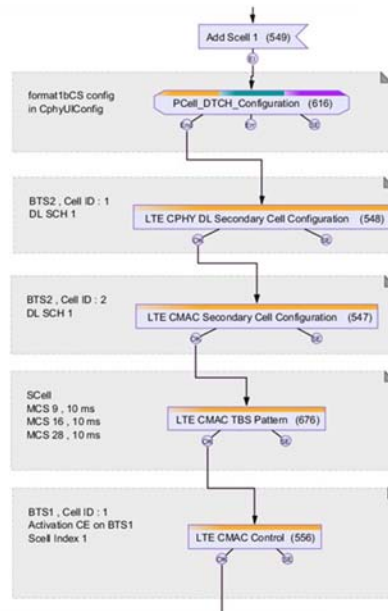

Protocol analysis

The protocol messages are presented for log analysis and debug. This multiple representation of the protocol exchange provides an easy means to pinpoint and fix complex issues.

- Analyze your live call flow using the Protocol analyzer. Here is an example of an addition of SCell:

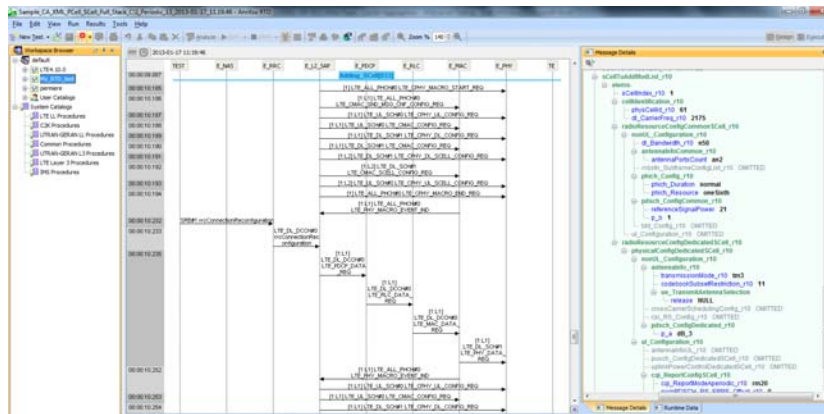
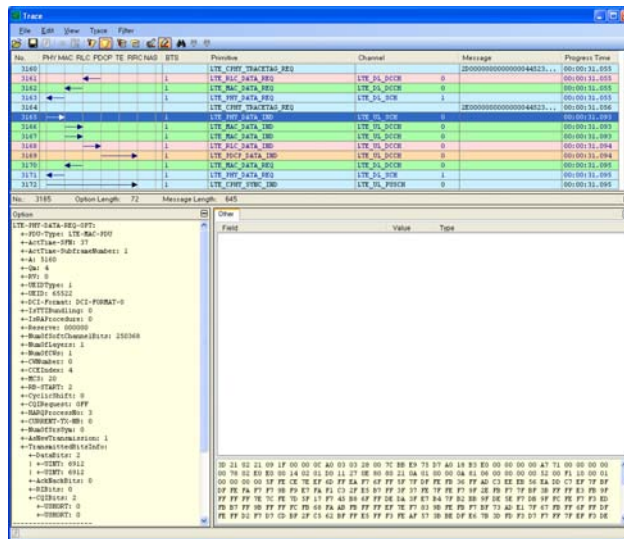

Figure 25 - Example of SCell Addition Protocol flow.

- Trace mode view:



System Level Test

Performance testing

Looking at the maximum performance achievable from a theoretical point of view, Release-10 LTE introduces three new UE categories – 6, 7, and 8. With the exception of Category 8, which is specifically designed to deliver the highest specification requirements of IMT-Advanced (e.g. 8x8 MIMO), the new UE categories do not introduce significantly higher data rates than the Category 5 that was already available in Releases 8 and 9. Categories 6 and 7, however, do introduce new ways in which those data rates can be achieved. Prior to Release-10, the two degrees of freedom available to deliver traffic channel data rates were (a) channel bandwidth and (b) MIMO layers.

Release-10 adds component carriers to this list as an additional degree of freedom. The following table summarizes the ways in which a Category 6/7 UE can support its peak downlink traffic channel capability of approximately 300 Mbps:

3GPP Release	User Equipment Category	Maximum L1 datarate Downlink	Maximum DL MIMO layers	Maximum L1 datarate Uplink
Release 8	Category 1	10.3 Mbit/s	1	5.2 Mbit/s
Release 8	Category 2	51.0 Mbit/s	2	25.5 Mbit/s
Release 8	Category 3	102.0 Mbit/s	2	51.0 Mbit/s
Release 8	Category 4	150.8 Mbit/s	2	51.0 Mbit/s
Release 8	Category 5	299.6 Mbit/s	4	75.4 Mbit/s
Release 10	Category 6	301.5 Mbit/s	2 or 4	51.0 Mbit/s
Release 10	Category 7	301.5 Mbit/s	2 or 4	102.0 Mbit/s
Release 10	Category 8	2998.6 Mbit/s	8	1497.8 Mbit/s

Figure 26 - User equipment (UE) categories.

Anritsu maximum performance testing

Anritsu Corporation launched the industry's first call-based LTE Advanced Carrier Aggregation testing capability in February 2012 with commercialization of CA capability for its MD8430A LTE Signaling Tester.

The MD8430A upgrade leverages the four available RFs, and provides 300 MB/s downlink throughput (FDD LTE) using two 2x2 MIMO Component Carriers (CCs).

The MD8430A-085 LTE Carrier Aggregation option for the MD8430A is available now for testing LTE Category 6 wireless devices.

The MD8430A LTE Signaling Tester is capable of simulating up to six LTE eNode Bs with up to four RFs. A variety of MIMO modes are available, including simulation of four SISO, two 2x2 MIMO, or one 4x2 MIMO downlink.

The MD8430A is also the central component of Anritsu's ME7834L LTE Mobile Device Test System and the ME7873L LTE RF/RRM Conformance (RFCT) Test Systems. The ME7834L provides both Protocol Conformance Test (PCT) and Carrier Acceptance Test (CAT) protocol capability, and the ME7873L supports both RF Conformance and RF Supplementary (CAT) tests. Anritsu supports the industry's largest number of validated PCT and RFCT test cases available.

From the system level perspective, several tests related to throughput stability can be easily configured to ensure the device's overall performance:

- Sustained maximum throughput.
- Throughput with different channel conditions on each CC.
- Different modes or operations on each CC.
- Independent power control, UE sounding, different hopping configurations.
- Loss of signal on Primary CC.
- Loss of synchronization on one or both CCs.
- Continual addition and removal of Secondary CCs.
- Inter-RAT handovers from multiple CCs.
- Change of network between R8/9 and R10.
- Inclusion of multi-step transitions, e.g. R8 GERAN R10.

Maximum throughput testing with RTD

The following example of UE throughput testing with RTD uses a Category 6 device with 2 CCs of 10 MHz with 2x2 MIMO. The physical throughput downlink reaches 74 Mbps on each Component Carrier.

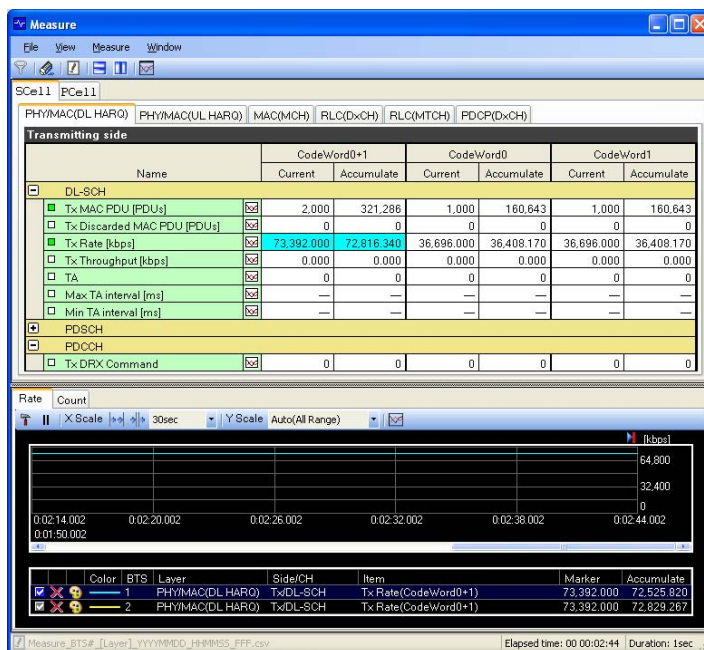
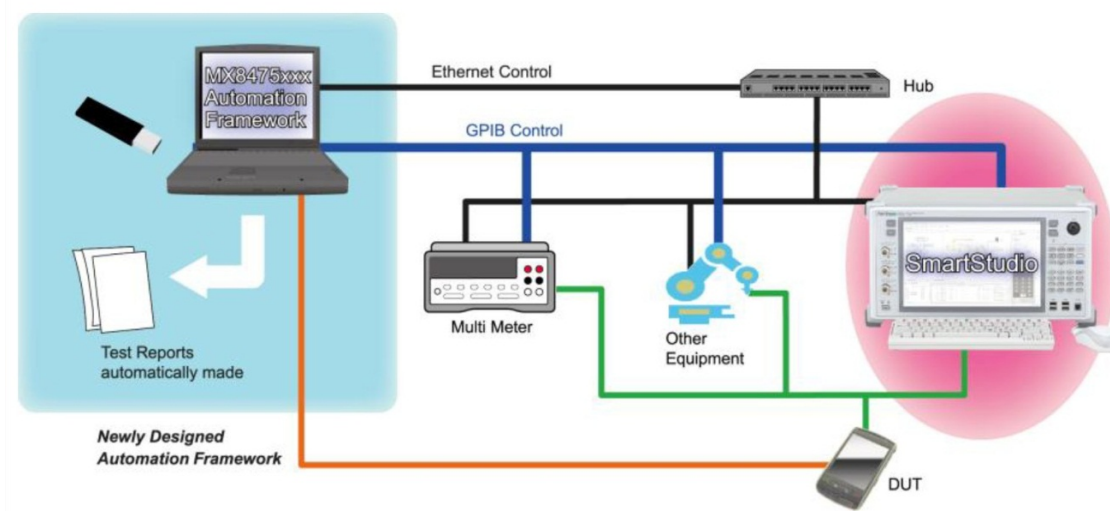

Figure 27 - Throughput testing category UE LTE Cat 6 - 2CC of 10 MHz - 2x2 MIMO.

Battery life testing

One of the key concerns with carrier aggregation testing is the actual battery drain caused by usage of the additional hardware chain. When coupled with a power supply, RTD provides a simple way of designing and testing the actual battery consumption of LTE-A devices.



The MD8475A is an ideal tool to perform testing according the GSMA standard: TS.09 Battery Life Measurement.

Conformance Testing

In Release-10, a new set of RF RRM conformance tests has been defined in 3GPP TS 36.521, specifically targeted toward Carrier Aggregation. In addition, a new set of Protocol conformance tests has been defined in 3GPP TS 36.523, also targeted at Carrier Aggregation.

RF/RRM Conformance Tests Overview

RF/RRM tests	
6.2.3A	Maximum Power Reduction (MPR) for CA
6.3.3A	Transmit OFF Power for CA
6.3.4A	General ON/OFF time mask for CA
6.5.1A	Frequency Error for CA
6.6.1A	Occupied bandwidth for CA
6.6.2.3A	Adjacent Channel Leakage power Ratio for CA
6.6.3.1A	Transmitter Spurious emissions for CA
7.3A	FDD PDSCH Single Antenna Port Performance (CA)
8.2.1.1.1_A	FDD PDSCH Open Loop Spatial Multiplexing 2x2 (CA)
8.2.1.3.1_A	TDD PDSCH Single Antenna Port Performance (CA)
8.2.2.1.1_A	TDD PDSCH Open Loop Spatial Multiplexing 2x2 (CA)
8.2.2.3.1_A	FDD Absolute RSRQ Accuracy for E-URTA Carrier Aggregation
9.2.5.1	FDD Relative RSRQ Accuracy for E-URTA Carrier Aggregation
9.2.6.1	TDD Absolute RSRQ Accuracy for E-URTA Carrier Aggregation
9.2.6.2	FDD Relative RSRQ Accuracy for E-URTA Carrier Aggregation

Protocol Tests Overview

Protocol	Tests
7.1.3.11	Additional of new CA test case: CA / Correct HARQ process handling / DCCH and DTCH / PCell and SCell
7.1.4.21	CA/UE power headroom reporting / Extended PHR
7.1.9.1	CA/Activation/Deactivation of SCells Activation/Deactivation MAC control element reception/ sCellDeactivationTimer
8.2.2.3	CA/RRC connection reconfiguration/SCell addition/modification/release/Success
8.2.2.4	CA/RRC connection reconfiguration/SCell SI change/Success
8.2.2.5	CA/RRC connection reconfiguration/SCell Addition without UL/Success
8.2.4.17	CA/RRC connection reconfiguration/Handover/Success/PCell Change and SCell addition
8.2.4.18	CA/RRC connection reconfiguration/Handover/Success/SCell release
8.3.1.17	CA/Measurement configuration control and reporting/Intra E-UTRAN measurement/Event A6
8.3.1.18	CA/Measurement configuration control and reporting/Intra E-UTRAN measurement/Additional measurement reporting

Through Anritsu involvement in the standardization process in the different 3GPP standards bodies, Anritsu is able to provide the state-of-the art coverage of these conformance tests.

Example of RF Conformance Testing

- Test Case TS36.521-1 Clause 6.2.3A: Maximum Power Reduction (MPR) for CA. The purpose behind this test is to verify if the UE correctly implements the possibility offered to reduce the maximum transmit power for demanding conditions (high RB allocations, high modulation orders) within the limits fixed by 3GPP.

MPR is a trade-off between meeting signal quality and out-of-band emissions and cell capacity/range.

PCC N _{RB}	SCCs N _{RB}	PCC & SCC RB allocation	N _{RB, s} Proc	PCC & SCC RB allocations (L _{CRB} @ RB _{1st/1st})		
75	75	N/A for this test	QPSK	16	P_16@0	S_0@0
75	75		QPSK	75	P_75@0	S_0@0
75	75		QPSK	150	P_75@0	S_75@0
75	75		16QAM	16	P_16@0	S_0@0
75	75		16QAM	75	P_75@0	S_0@0
75	75		16QAM	150	P_75@0	S_75@0
100	50		QPSK	12	P_12@0	S_0@0
100	50		QPSK	50	P_50@0	S_0@0
100	50		QPSK	150	P_100@0	S_50@0
100	50		16QAM	12	P_12@0	S_0@0
100	50		16QAM	50	P_50@0	S_0@0
100	50		16QAM	150	P_100@0	S_50@0
100	100		QPSK	18	P_18@0	S_0@0
100	100		QPSK	100	P_100@0	S_0@0
100	100		QPSK	200	P_100@0	S_100@0
100	100		16QAM	18	P_18@0	S_0@0
100	100		16QAM	100	P_100@0	S_0@0
100	100		16QAM	200	P_100@0	S_100@0

NOTE 1: CA Configuration Test CC Combination settings are checked separately for each CA Configuration, which applicable aggregated channel bandwidths are specified in Table 5.4.2A.1-1.

The test is run using a Reference Measurement Channel (RMC) configuration with this Resource Block allocation and Modulation scheme.

Each row represents one iteration of the test.

This table defines the allowed power reduction for the UE. Currently 3GPP RAN 5 are still defining the test tolerances.

Modulation	CA bandwidth Class C			MPR (dB)
	50 RB + 100 RB	75 RB + 75 RB	100 RB + 100 RB	
QPSK	> 12 and ≤ 50	> 16 and ≤ 75	> 18 and ≤ 100	≤ 1
QPSK	> 50	> 75	> 100	≤ 2
16 QAM	≤ 12	≤ 16	≤ 18	≤ 1
16 QAM	> 12 and ≤ 50	> 16 and ≤ 75	> 18 and ≤ 100	≤ 2
16 QAM	> 50	> 75	> 100	≤ 3

Test setup

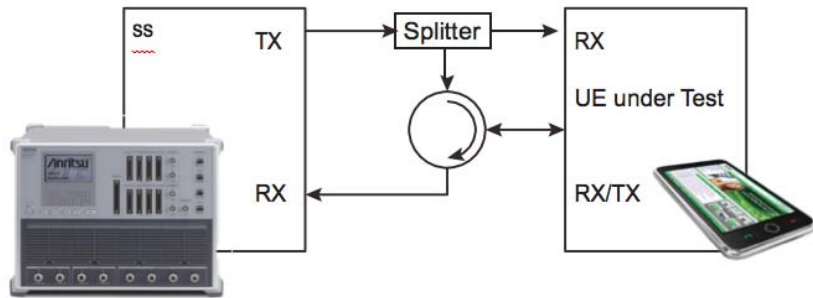

Example of Signaling Conformance Testing

- 8.2.2.3 CA / RRC connection reconfiguration / SCell addition/modification/release / Success

3GPP flow states

3GPP flow States					
St	Procedure	Message Sequence		TP	Verdict
		U-S	Message		
1	The SS transmits an RRC Connection Reconfiguration message on Cell 1 to setup Frequency measurement	←	RRC Connection Reconfiguration		
2	The UE transmits an RRC Connection Reconfiguration Complete message on Cell 1.	→	RRC Connection Reconfiguration Complete		
3	The SS changes Cell 3 parameters according to row "T1" in table 8.2.2.3.1.3-1.				
4	The UE transmits a Measurement Report message on Cell 1 to report event A3 with the measured RSRP, RSRQ value for Cell 3.	→	Measurement Report		
5	The SS transmits an RRC Connection Reconfiguration Complete message containing an sCellToAddModList with SCell Cell 3 addition.	←	RRC Connection Reconfiguration		
6	Check Does the UE transmit and RRC Connection Reconfiguration Complete message?	→	RRC Connection Reconfiguration Complete	1	P
7	The SS transmits and RRC Connection Reconfiguration Complete message containing an sCell To Add Mod List with SCell Cell 3 modification and including meas Config to release measurement gap.	←	RRC Connection Reconfiguration		
8	Check: Does the UE transmit an RRC Connection Reconfiguration Complete message?	→	RRC Connection Reconfiguration Complete	2	P
9	The SS changes Cell 3 parameters according to the row "T2" in table 8.2.2.3.1.3.2-1.				
10	The UE transmits a Measurement Report message on Cell 1 to report event A3 with the measured RSRP, RSRQ value for Cell 3.	→	MeasurementReport		
11	The SS transmits RRC Connection Reconfiguration message containing an sCell To Release List with an sCellIndex equalling to the Cell 3 cell index in the current UE configuration.	←	RRC Connection Reconfiguration		
12	Check: Does the UE transmit an RRC Connection Reconfiguration Complete message?	→	RRC Connection Reconfiguration Complete	3	P
13	Check: Does the test result of generic test procedure in TS 36.508 subclause 6.4.2.3 indicate that the UE is in E_UTRA RRC_CONNECTED stat on Cell ?			1	

Test setup

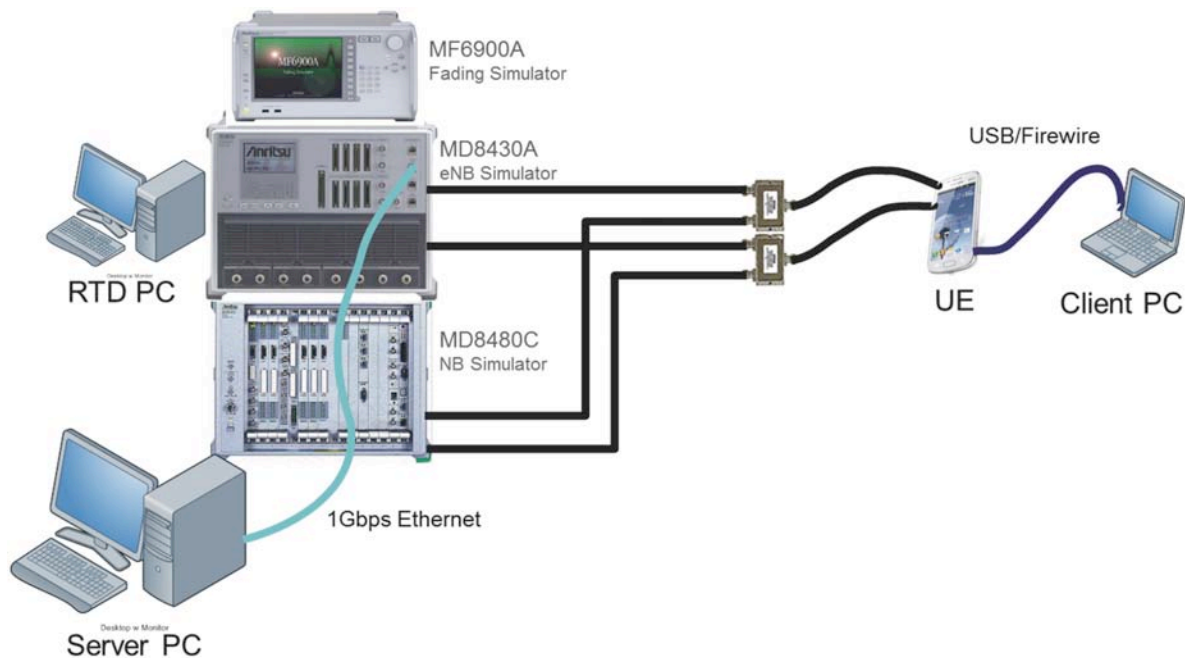

6 - Conclusion

The substantial growth foreseen in mobile data usage will continue to drive demand for more network capacity and higher peak data rates. Spectrum congestion and availability limits the ability to provide this capacity with a conventional single carrier approach. Carrier Aggregation will be one of the key technologies to meet the data expansion needs with the anticipated availability of new fragmented spectrum over the coming years. Carrier Aggregation will also play a major role in interference management in LTE-A using SON systems.

Carrier Aggregation proves to be a highly flexible solution with excellent re-use of existing standards and an easy route to provide backwards compatibility with legacy devices. The industry roadmaps confirm the widespread adoption of this technology for both HSPA+ and LTE-A.

However, as we have seen, Carrier Aggregation brings extensive technical challenges especially in term of design and testing. Anritsu supports the evolution to Carrier Aggregation with a full portfolio of both HSPA and LTE-Advanced capabilities.

7 - Bibliography

- 3GPP. Carrier Aggregation explained. May 2012. <http://www.3gpp.org/Carrier-Aggregation-explained>.
- R1-084225, "Comparison between Clustered DFT-s-OFDM and OFDM for supporting non-contiguous RB allocation within a component carrier". November 2008.
- TR 36.815 Further Advancements for E-UTRA; LTE-Advanced feasibility studies in RAN WG4. 2012.
- TR 36.823 Carrier Aggregation Enhancements; UE and BS radio transmission and reception (Release-11). 2012.
- TS 36.101 User Equipment (UE) radio transmission and reception. 2012.
- TS 36.300 Overall description; Stage 2 (Release-11). September 2012.
- TS 36.331 Radio Resource Control (RRC); Protocol specification. 2012.
- 4GAmericas. HSPA+LTE Carrier aggregation. June 2012.
- Erick Dahlman, Stefan Parkvall, Johan Skold. LTE/LTE-Advanced for Mobile Broadband. 2012.
- GSA. GSA report. December 2012. <http://www.gsacom.com/>.
- Takashi Iwai, Atsushi Matsumoto, Shinsuke Takaoka. "System Performance of Clustered DFT-S-OFDM Considering Maximum Allowable Transmit Power." Communications (ICC), 2011 IEEE International. 2011.

8 - Appendix

Carrier Aggregation E-UTRA channel numbers

E-UTRA Band / Channel Bandwidth							
3GPP TS 36.101 vers 10.4.0 Release 10							
E-UTRA Operating Band	Downlink			Uplink			Duplex Mode
	$F_{DL_{low}}$ (MHz)	N_{OBS_DL}	Range of N_{DL}	$F_{UL_{low}}$ (MHz)	N_{OBS_UL}	Range of N_{UL}	
1	2110	0	0 - 599	1920		18000 - 18599	FDD
2	1930	600	600 - 1199	1850		18600 - 19199	FDD
3	1805	1200	1200 - 1949	1710		19200 - 19949	FDD
4	2110	1950	1950 - 2399	1710		19950 - 20399	FDD
5	869	2400	2400 - 2649	824		20400 - 20649	FDD
6	875	2650	2650 - 2749	830		20650 - 20749	FDD
7	2620	2750	2750 - 3449	2500		20750 - 21449	FDD
8	925	3450	3450 - 3799	880		21450 - 21799	FDD
9	1844.9	3800	3800 - 4149	1749.9		21800 - 22149	FDD
10	2110	4150	4150 - 4749	1710		22150 - 22749	FDD
11	1475.9	4750	4750 - 4949	1427.9		22750 - 22949	FDD
12	729	5010	5010 - 5179	699		23010 - 23179	FDD
13	746	5180	5180 - 5279	777		23180 - 23279	FDD
14	758	5280	5280 - 5379	788		23280 - 23379	FDD
...							FDD
17	734	5730	5730 - 5849	704		23730 - 23849	FDD
18	860	5850	5850 - 5999	815		23850 - 23999	FDD
19	875	6000	6000 - 6149	830		24000 - 24149	FDD
20	791	6150	6150 - 6449	832		24150 - 24449	FDD
21	1495.9	6450	6450 - 6599	1447.9		24450 - 24599	FDD
22	3510	6600	6600 - 7399	3410		24600 - 25399	FDD
23	2180	7500	7500 - 7699	2000		25500 - 25699	FDD
24	1525	7700	7700 - 8039	1626.5		25700 - 26039	FDD
25	1930	8040	8040 - 8689	1850		26040 - 26689	FDD
...							
33	1900	36000	36000 - 36199	1900		36000 - 36199	TDD
34	2010	36200	36200 - 36349	2010		36200 - 36349	TDD
35	1850	36350	36350 - 36949	1850		36350 - 36949	TDD
36	1930	36950	36950 - 37549	1930		36950 - 37549	TDD
37	1910	37550	37550 - 37749	1910		37550 - 37749	TDD
38	2570	37750	37750 - 38249	2570		37750 - 38249	TDD
39	1880	38250	38250 - 38649	1880		38250 - 38649	TDD
40	2300	38650	38650 - 39649	2300		38650 - 39649	TDD
41	2496	39650	39650 - 41589	2496		39650 - 41589	TDD
42	3400	41590	41590 - 43589	3400		41590 - 43589	TDD
43	3600	43590	43590 - 45589	3600		43590 - 45589	TDD

NOTE: The channel numbers that designate carrier frequencies so close to the operating band edges that the carrier extends beyond the operating band edge shall not be used. This implies that the first 7, 15, 25, 50, 75 and 100 channel numbers at the lower operating band edge and the last 6, 14, 24, 49, 74 and 99 channel numbers at the upper operating band edge shall not be used for channel bandwidths of 1.4, 3, 5, 10, 15 and 20 MHz respectively.

ME7834L PCT - LTE, All Bands Covered

FDD	
Band 1 Japan, Asia, EU 	Band 2 US, Canada, S. America
Band 3 France, Poland, Nordic, Korea 	Band 4 Americas, Canada 
Band 5 US, Canada, Aus, Korea 	Band 7 Europe, HK 
Band 8 Korea 	Band 11 Japan 
Band 12 US, Canada, (AWS) 	Band 13 Verizon, US, Canada 
Band 14 US, Canada, Public safety 	Band 17 AT&T, US 
Band 18 Japan, KDDI 	Band 19, 21, 28 Japan 
Band 20 Europe, Germany 	Band 25, 26, 27 US, Canada, South America 
TDD	
Band 38 Europe, Japan, Taiwan 	Band 39 China 
Band 40 Australia, China, India 	Band 41 US, China, Japan 



Specification are subject to change without notice.

United States

Anritsu Company

1155 East Collins Blvd, Suite 100
Richardson, TX 75081, U.S.A.
Toll Free: 1-800-267-4878
Phone: +1-972-644-1777
Fax: +1-972-671-1877

Canada

Anritsu Electronics Ltd.

700 Silver Seven Road, Suite 120
Kanata, Ontario K2V 1C3, Canada
Phone: +1-613-591-2003
Fax: +1-613-591-1006

Brazil

Anritsu Eletrônica Ltda.

Praça Amadeu Amaral, 27 - 1 Andar
01327-010 Bela Vista, São Paulo, Brazil
Phone: +55-11-3283-2511
Fax: +55-11-3288-6940

Mexico

Anritsu Company, S.A. de C.V.

Av. Ejército Nacional No. 579 Piso 9, Col. Granada
11520 México, D.F., México
Phone: +52-55-1101-2370
Fax: +52-55-5254-3147

United Kingdom

Anritsu EMEA Ltd.

200 Capability Green
Luton, Bedfordshire LU1 3LU
United Kingdom
Phone: +44-1582-433280
Fax: +44-1582-731303

France

Anritsu S.A.

12 Avenue du Québec
Bâtiment Iris 1-Silic 612
91140 Villebon-sur-Yvette, France
Phone: +33-1-60-92-15-50
Fax: +33-1-64-46-10-65

Germany

Anritsu GmbH

Nemetschek Haus, Konrad-Zuse-Platz 1
81829 München, Germany
Phone: +49-89-442308-0
Fax: +49-89-442308-55

Italy

Anritsu S.r.l.

Via Elio Vittorini 129
00144 Roma, Italy
Phone: +39-06-509-9711
Fax: +39-06-502-2425

Sweden

Anritsu AB

Kistagången 20B
164 40 KISTA, Sweden
Phone: +46-8-534-707-00
Fax: +46-8-534-707-30

Finland

Anritsu AB

Teknobulevardi 3-5
FI-01530 Vantaa, Finland
Phone: +358-20-741-8100
Fax: +358-20-741-8111

Denmark

Anritsu A/S

Kay Fiskers Plads 9
2300 Copenhagen S, Denmark
Phone: +45-7211-2200
Fax: +45-7211-2210

Russia

Anritsu EMEA Ltd.

Representation Office in Russia
Tverskaya str. 16/2, bld. 1, 7th floor
Russia, 125009, Moscow
Phone: +7-495-363-1694
Fax: +7-495-935-8962

United Arab Emirates

Anritsu EMEA Ltd.

Dubai Liaison Office
P O Box 500413 - Dubai Internet City
Al Thuraya Building, Tower 1, Suite 701, 7th Floor
Dubai, United Arab Emirates
Phone: +971-4-3670352
Fax: +971-4-3688460

Singapore

Anritsu Pte. Ltd.

11 Chang Charn Road, #04-01, Shriro House
Singapore 159640
Phone: +65-6282-2400
Fax: +65-6282-2533

India

Anritsu India Private Limited

2nd & 3rd Floor, #837/1, Binnamangla 1st Stage
Indiranagar, 100ft Road, Bangalore - 560038, India
Phone: +91-80-4058-1300
Fax: +91-80-4058-1301

P.R. China (Shanghai)

Anritsu (China) Co., Ltd.

27th Floor, Tower A
New Caohejing International Business Center
No. 391 Gui Ping Road Shanghai, Xu Hui Di
District
Shanghai 200233, P.R. China
Phone: +86-21-6237-0898
Fax: +86-21-6237-0899

P.R. China (Hong Kong)

Anritsu Company Ltd.

Unit 1006-7, 10/F., Greenfield Tower
Concordia Plaza
No. 1 Science Museum Road, Tsim Sha Tsui East
Kowloon, Hong Kong, P. R. China
Phone: +852-2301-4980
Fax: +852-2301-3545

Japan

Anritsu Corporation

8-5, Tamura-cho, Atsugi-shi
Kanagawa, 243-0016 Japan
Phone: +81-46-296-1221
Fax: +81-46-296-1238

Korea

Anritsu Corporation, Ltd.

5FL, 235 Pangyoyeok-ro, Bundang-gu
Seongnam-si
Gyeonggi-do, 463-400 Korea
Phone: +82-31-696-7750
Fax: +82-31-696-7751

Australia

Anritsu Pty Ltd.

Unit 21/270 Ferntree Gully Road
Notting Hill, Victoria, 3168, Australia
Phone: +61-3-9558-8177
Fax: +61-3-9558-8255

Taiwan

Anritsu Company Inc.

7F, No. 316, Sec. 1, Neihu Rd, Taipei 114, Taiwan
Phone: +886-2-8751-1816
Fax: +886-2-8751-1817