



# Understanding Wood Movement

Proven methods for dealing with expansion and contraction

BY CHRISTIAN BECKSVOORT

For centuries, granite has been quarried along the Maine coast. Way back in the woods behind my shop, on a granite outcropping, sit a few leftover slabs 10 in. thick by 2 ft. wide by 12 ft. long. The granite faces show a series of ½-in. holes drilled 12 in. to 18 in. apart. The old-timers would have driven dried wood into these holes, then walked down the row pouring water onto the wood. Eventually, the granite slabs would split apart. When wood cells absorb water, they swell and expand, and not even granite can stop it.

So forget about pins, glue, screws, or fancy joinery; wood will move and break apart your work if you don't follow the rules.

The exact amount of wood movement depends on any combination of several factors, including the environment (the degree to which humidity fluctuates) and how the lumber has been sawn (see below).

The amount of movement also varies among wood species, particularly among the hardwoods. For example, beech, hickory, oak, and hard maple move substantially more than cherry, walnut, and butternut.

Last, the type of finish you apply to a piece affects wood movement. Because light skin finishes such as wax and oil allow greater moisture absorption, wood that has been coated with either of them moves more than wood that has been finished with deeper-penetrating sealants such as urethane and lacquer.

As a professional woodworker, I can't afford to cut corners when it comes to wood movement. So I devote my energy to building furniture right the first time—whether it's a chest, a case, a bed, or a table.

## How wood moves

### GRAIN ORIENTATION DETERMINES THE AMOUNT OF MOVEMENT

You can predict how lumber will behave by looking at the growth rings. Flatsawn boards revealing long ring sections that are parallel to the pith of the log will move the greatest amount.

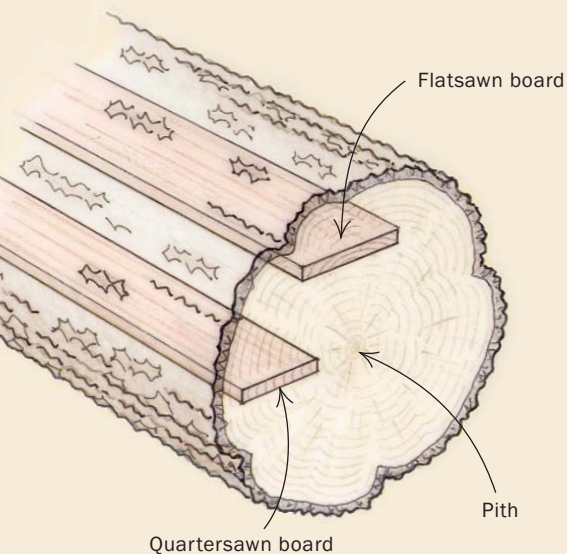

#### FLATSAWN BOARD

Most seasonal movement in a board is along the rings. With annual rings nearly parallel to the surface, flatsawn boards exhibit more seasonal movement and are prone to cupping.

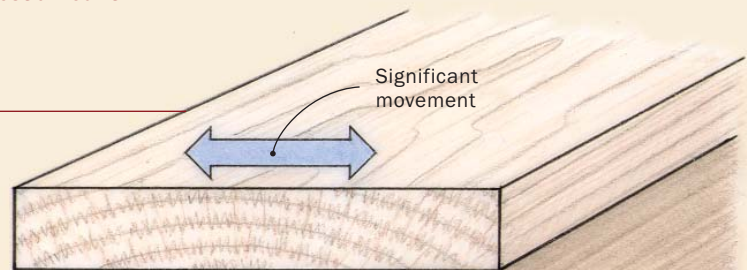

#### QUARTERSAWN BOARD

A quartersawn board has annual rings running perpendicular to the surface, so the board will experience far less seasonal movement and will be less likely to cup.

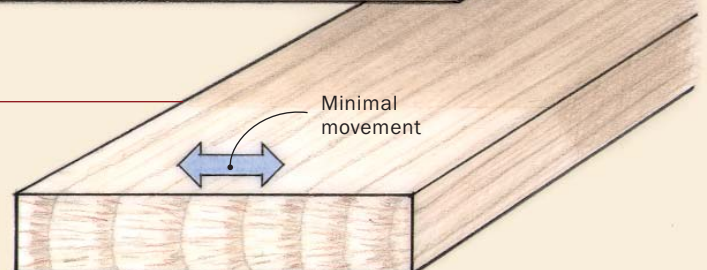

# BLANKET CHESTS

## SLAB CONSTRUCTION ALLOWS ENTIRE PIECE TO MOVE

A blanket chest, in which the grain runs in a band around the entire box, is an example of slab construction. The depth and width of the chest remain constant, because the wood does not move lengthwise. But the wood does change in height in response to changes in humidity. The blanket chest gets slightly taller in summer and shorter in winter. Because movement in the top is from front to back, the hasps of the lock don't always fit. The solution is to use quartersawn wood for the top, file the hasp parts to increase clearance, and use a good sealing finish.



Seasonal expansion and contraction occurs across the grain of a board.

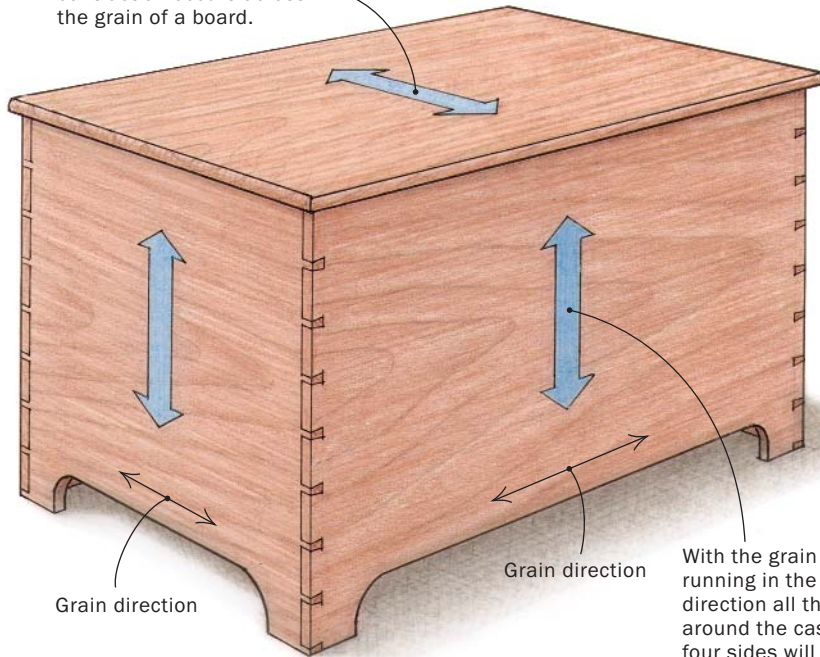

With the grain running in the same direction all the way around the case, all four sides will move in the same direction.

## BOTTOM FLOATS IN GROOVES

Grooves are cut into the four sides of the chest to hold the bottom. The bottom is sized so that there's enough space in the grooves to allow for seasonal movement.

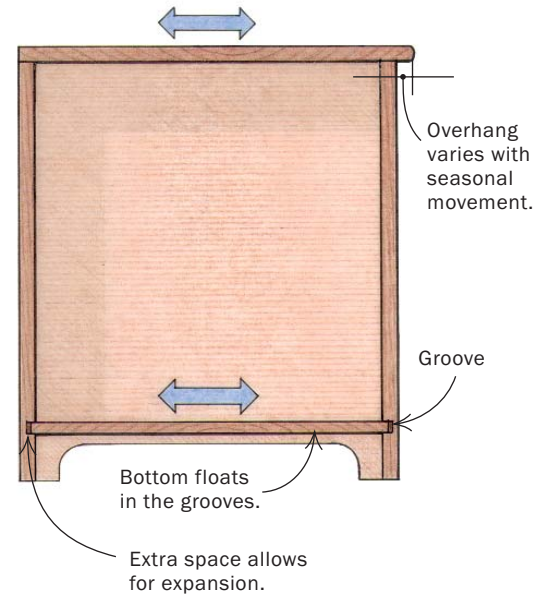

## FRAME-AND-PANEL CONSTRUCTION ISOLATES MOVEMENT

Your approach to controlling wood movement will depend a lot on whether the piece is made using slab or frame-and-panel construction.

Slab construction is typical in chests, table-tops, and headboards and consists of single, wide boards or narrow boards glued up edge to edge. With solid-wood slabs, you have to worry about cross-grain movement, which can be significant with large widths.

Frame-and-panel construction, on the other hand, minimizes the effects of wood movement by isolating large areas (the panel) and restricting movement to relatively small areas (the frame). The panel is set into grooves of the appropriate depth, but it is not glued in place. Instead, this "floating" panel is free to expand and contract within the frame.

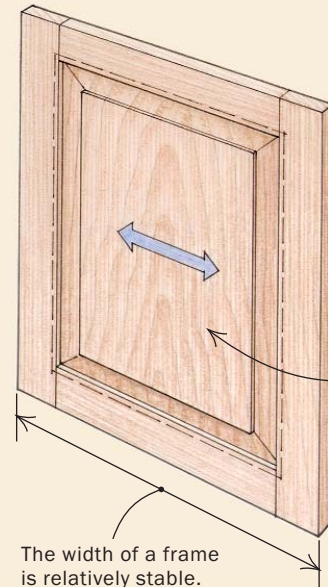
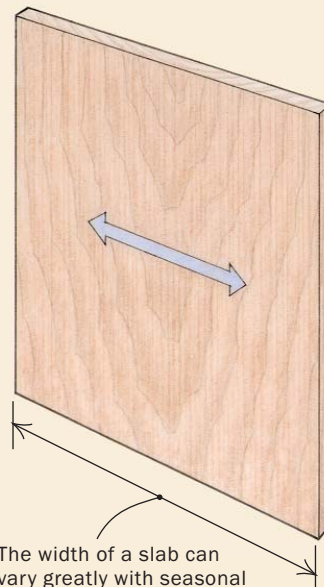

Frame-and-panel construction allows the panel to move within the stable frame.



## BEDS

### SLAB HEADBOARDS NEED EXTRALONG MORTISES

A slab headboard that's 12 in. to 14 in. wide may move up to  $\frac{1}{4}$  in., which means the mortise into which it fits needs to be that much wider. If the headboard is to be pinned and glued in the middle (fixed), leave an  $\frac{1}{8}$ -in. space at the top and bottom of the mortise. But the headboards on some beds, such as pencil-posts, sit loosely in the mortises on the posts. The unit is held together by bolts in the rails. Extratall headboards (as in old Victorian styles or sleigh beds) require extradeep grooves or large shoulders and mortises.

#### ATTACHING A FIXED HEADBOARD

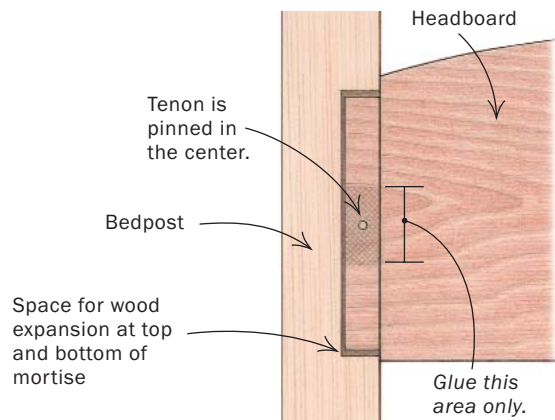

#### ATTACHING LOOSE HEADBOARDS

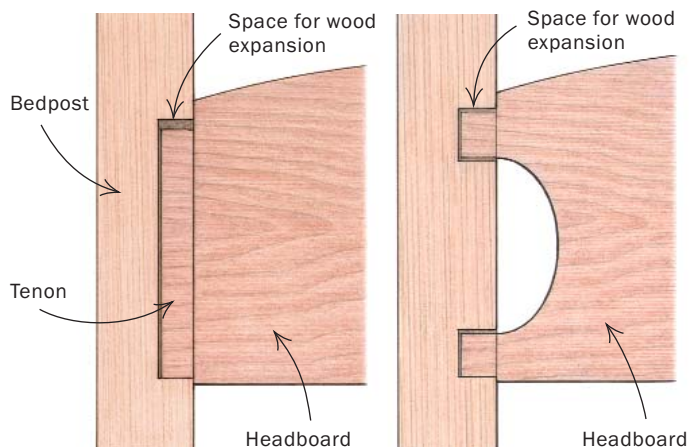

## TABLES



### BREADBOARD CONSTRUCTION KEEPS TABLETOPS FLAT

Breadboard ends are added to tabletops to help prevent the top from warping or cupping. But they must be attached so as to allow the top to expand and contract.

The preferred method for making breadboards is a single tongue with cutouts. For a stronger joint, parts of the tongue are cut out to within  $\frac{1}{4}$  in. to  $\frac{1}{2}$  in. of the shoulder, and the corresponding areas of the mortise are left in place to hold the weak faces of the breadboard together.

The trickiest part of construction is pinning and gluing the breadboard ends. I like to plane a slight ( $\frac{1}{16}$ -in.) concave bow into the breadboard to keep the ends tight against the table. I make the mortise longer than the tongue, center the breadboard, and clamp both ends onto the table. I drill a  $\frac{3}{16}$ -in.-dia. hole in the center and then one (for narrow tabletops) or two holes (for wider ones) on either side of center.

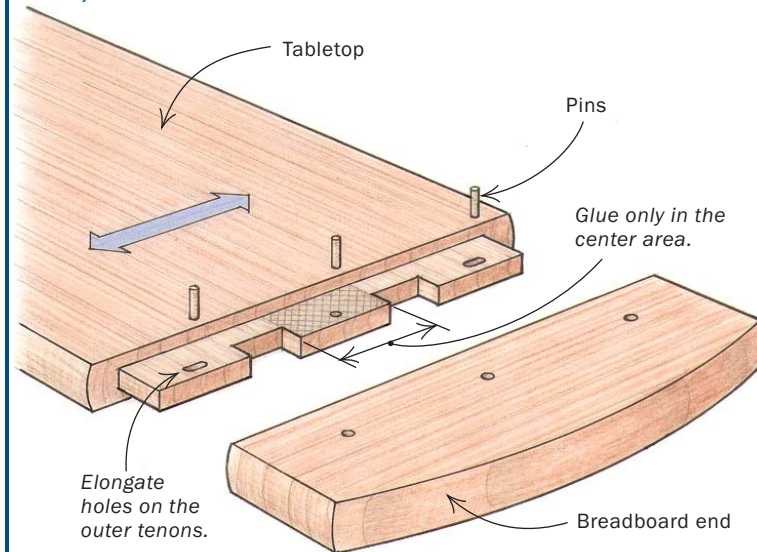

I remove the breadboard end and scribe a line along the edge of the holes closest to the end. Next, I elongate all but the center holes with a  $\frac{3}{16}$ -in. rat-tail file. The farther from center, the longer the oval. For very dry wood (6% moisture content or less), elongate away from the center to allow the top to expand. For wet wood (12% moisture content or more), elongate toward the center to allow for shrinkage. Do not file beyond the scribe lines; doing so will relieve the pressure holding the breadboard to the table shoulder.

## MORTISE-AND-TENONS THAT BREATHE

You may have surmised that cross-grain gluing is a no-no. That is correct up to a point. Wood has a small amount of give to it, and aliphatic resin (yellow) glue is slightly elastic. So you can feel relatively safe making cross-grain joints, such as mortise-and-tenons, as long as the tenons aren't too wide. With cherry, for example, I limit cross-grain joints to a width of 5 in. As a precaution, I glue only the top half of the joint. Theoretically, the top of the rail will stay flush, and the bottom will move ever so slightly. That also should work for hardwoods that are less well-behaved than cherry.

## NARROW APRONS CAN BE GLUED AND PINNED

In general, tenons for aprons that are less than 5 in. wide can be glued and pinned, but glue only the top portion of the joint.

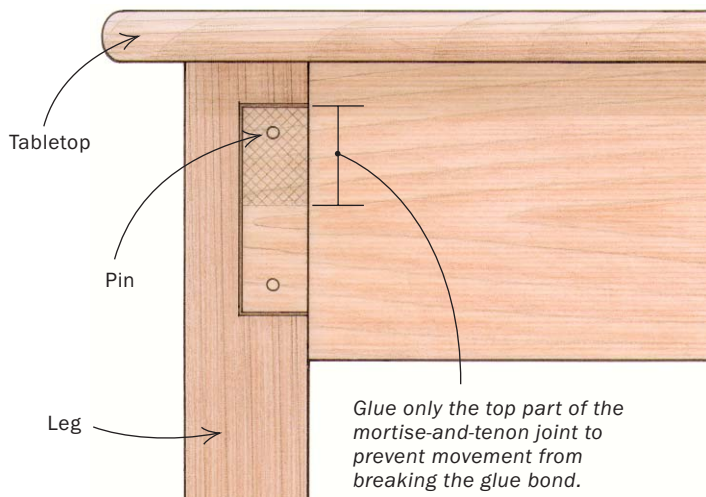

## WIDE APRONS USE FLOATING PINS

The tenon of a wide apron requires space at the bottom for expansion. A fixed pin at the top forces movement downward.

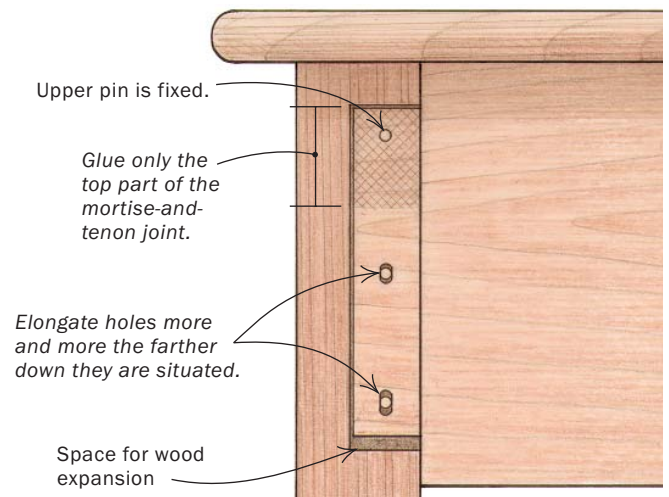

## TABLETOPS NEED ROOM TO MOVE

No matter how I go about attaching a top to its base, I anchor it firmly in the middle, ensuring that both halves are free to move equally. As a matter of course, I orient the grain in the long direction to minimize the amount of movement.

A good way to attach tops is to make 1/4-in. grooves, or a series of 1/4-in. slots, 1/2 in. below the inside top of the rail. I then install shopmade wood buttons, which grip the grooves and screw to the underside of the top. The buttons at the ends of the tabletop can go to the full depth of the groove, while the buttons along the sides must be placed according to the wood's moisture content and the time of year. (Fit them tighter in summer, looser in winter.)

For a table with rails substantially thicker than 3/4 in., I countersink 1/2-in.-dia. holes from the bottom of the rails. Then I drill 1/4-in. holes all the way through. I use a rat-tail file to elongate holes away from the center. Holes in the center of the end rails stay as they are. Because the wood movement is side to side, the ovals in the

long rails run across the thickness of the rail. That's why I don't recommend this method for thin rails.

For more details on attaching tops, see *FWW* #62, pp. 58-59 and *FWW* #112, pp. 54-57.

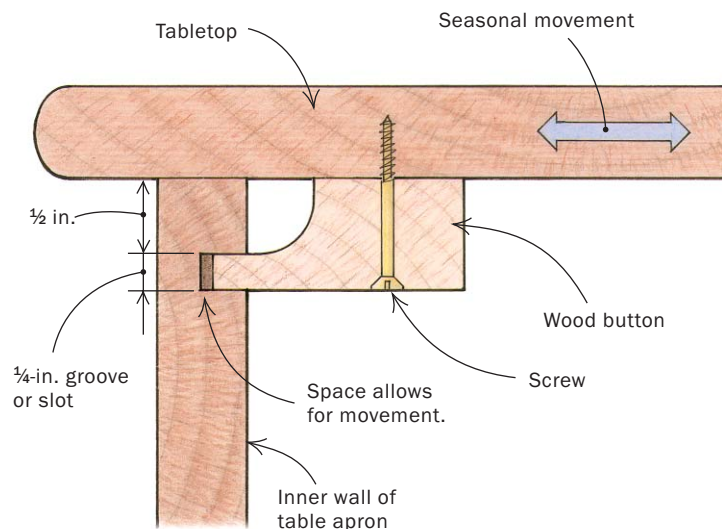

## CASE PIECES

### WEB FRAMES PROVIDE UNDETECTABLE MOVEMENT

Web frames provide lightweight, low-movement alternatives to solid drawer dividers. For frame-and-panel cases, web frames are merely four slats—mortised and tenoned and then glued. For slab-constructed cases, web frames become a bit more involved. I start with four slats. Two are dovetailed into the sides of the case; one slat in the front, and one in the back (flush with the back rabbet). Before gluing, I rout a dado to connect the front and back dovetails. Then I cut a mortise into each end of both dovetailed slats. I measure the length of the drawer runners and add the depth of the two mortises, minus  $\frac{1}{16}$  in. for dry wood, or minus  $\frac{3}{16}$  in. for damp wood. I glue the front slat into the dovetailed slots and then cut the tenons on the front-to-back runners. The front tenon is glued into the mortise, and the runner is forced into the connecting dado. The back slat is then glued into its dovetail slot, but the back mortise-and-tenon is not glued.

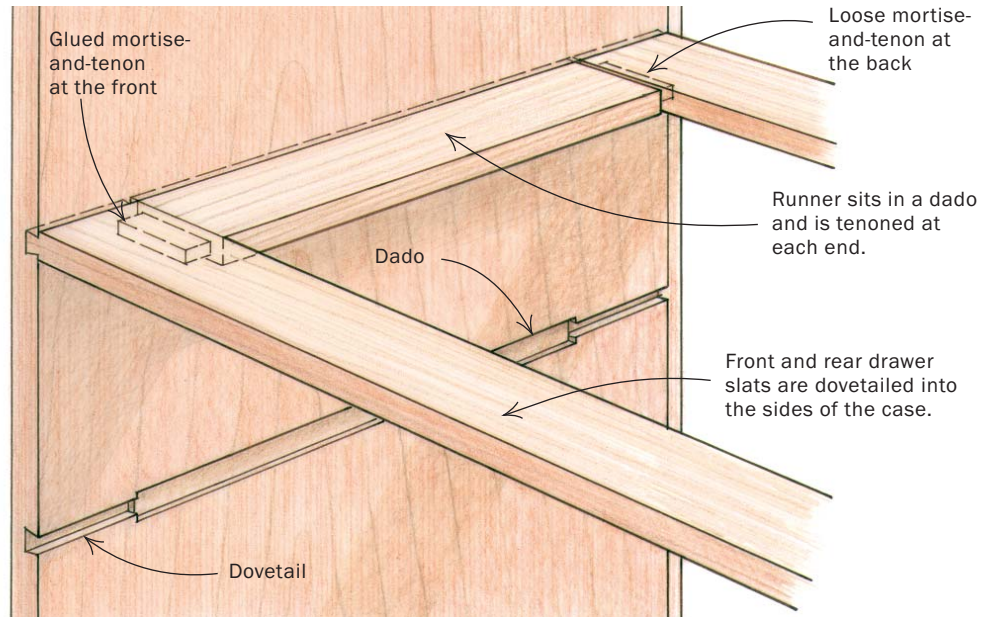

### FITTING DOORS AND DRAWERS

The issue of wood movement in doors and drawers must be taken into account. Because they will change in width over the course of a year, I install slab doors only in narrower case openings using quartersawn wood and then stabilize the door with battens.

Frame-and-panel doors are much less of a headache. For quartersawn cherry, I aim for a gap at the lock side of the door that is between the thickness of a nickel ( $\frac{5}{64}$  in.) and a dime ( $\frac{3}{64}$  in.). The hinge-side gap is constant year-round; the top gap is a dime fit; and the bottom gap is a nickel fit.

Fitting drawers is bit more involved. Again, I prefer to use quartersawn stock to minimize wood movement. I start by making drawers the same size as the opening, side to side. When assembled, I trim them to fit, with a  $\frac{1}{64}$ -in. (minimum) to  $\frac{1}{16}$ -in. (maximum) total side clearance.

The top-to-bottom dimension is another story. The opening is constant, but the drawer front changes in height. I also make my front about  $\frac{1}{32}$  in. narrower than the sides by planing that amount off the bottom (after cutting the grooves for the drawer bottom).

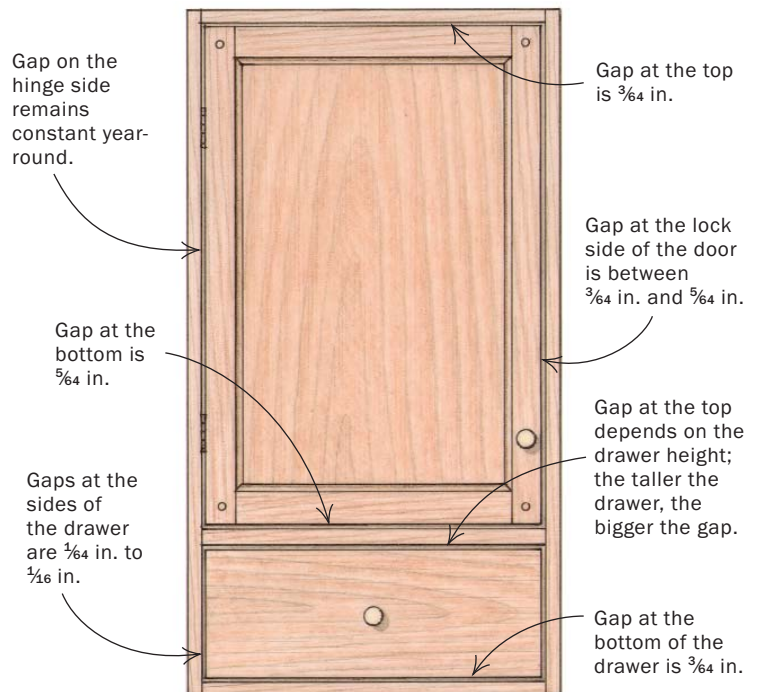



## A FRAME-AND-PANEL BACK ACCOMMODATES MOVEMENT

Building high-end furniture and having a preference for solid wood, I make my backs as frame-and-panel units, set into rabbets and glued into place. This method creates a totally sealed back, which allows for movement yet provides racking resistance.

The success of this method depends on the width and grain orientation of the outside frame members. Because the frame is glued into the rabbets, any excess wood movement will break out the lips of the side and top rabbets. I have determined that by using quartersawn cherry no wider than 1¾ in. for the sides and top of the frame members, there is enough give in the wood to accommodate any potential movement. Less well-behaved woods require correspondingly narrower stock. In any event, the stock must be quartersawn.

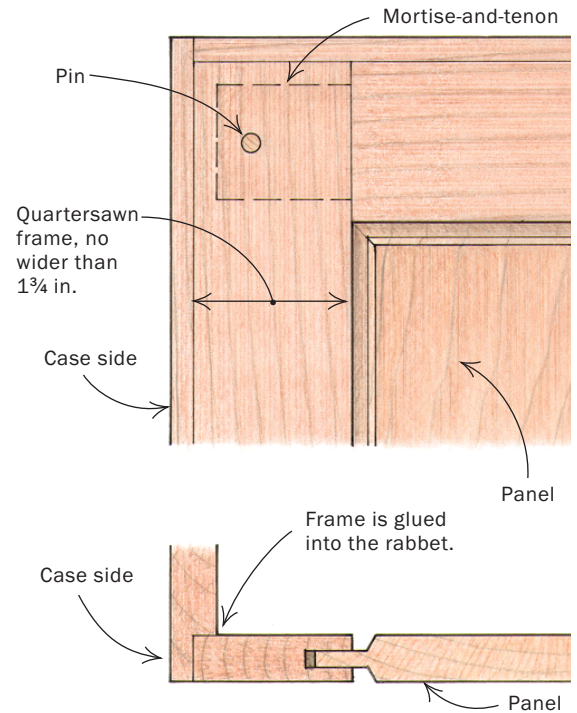

## SIDE MOLDINGS THAT HOLD

Most antiques that I've looked at have the side molding glued (and/or screwed) at the miter and nailed the rest of the way back. As the case side moves over the years, the nail holes widen and the nails lose their grip. The long-lasting solution is to use dovetailed keys and slots.

I cut my molding and miter the corners to fit. The side molding receives a dovetail slot that runs its full length, in the meatiest portion of the molding, not necessarily its center.

To locate the dovetail keys, I hold the molding in position, then make knife marks on the case side at the top and bottom of the slot, at both the forward miter and at the back. I connect these tick marks, then cut a dovetail key the length of the cabinet side. Ideally, you want it to be 0.003 in. to 0.005 in. thinner than the depth of the slot to draw the molding tight. Then I mark the strip into

five or six equal parts. Into each segment I drill and countersink two holes to accept #4 flathead screws, 1 in. apart. Between these holes, I drill for a 20-ga. brad, apply a drop of glue around the underside of the brad hole, and position the strip between scribe lines. I nail the brads, then sink the screws. Once the long length of the dovetail key has been installed, I chisel out a ¾-in. section at each pencil mark, leaving five or six perfectly aligned dovetail keys.

