

# Unilock Elements 2010 Product Catalog



Effective: February 4, 2010

**Creation Begins With  
The Elements.™**



**HARMONY**  
OUTDOOR LIVING INC.

The logo for Harmony Outdoor Living Inc. features three stylized icons in a row: a red square with a white starburst, a green square with a white flame, and a dark green square with a white crescent moon. Below the icons, the word "HARMONY" is written in a large, bold, serif font, and "OUTDOOR LIVING INC." is written in a smaller, all-caps, sans-serif font below it.

<b>Table of Contents</b>	<b>Pages</b>
<b>Concorde Fireplace Series</b>	<b>3 - 4</b>
<b>Cordova Collection</b>	<b>5 - 8</b>
<b>Tuscany Collection</b>	<b>9 - 12</b>
<b>Barcelona Collection</b>	<b>13 - 15</b>
<b>Kensington Collection</b>	<b>16 - 18</b>
<b>Cityscape Collection</b>	<b>19 - 21</b>
<b>Additional Elements</b>	<b>22 - 24</b>
<b>Seatwall Options</b>	<b>25 - 26</b>
<b>Unilock Custom Collection</b>	<b>27 - 59</b>
<b>Kitchens &amp; Islands</b>	<b>60 - 73</b>
<b>Components</b>	<b>74 - 76</b>
<b>Stainless Grills &amp; Accessories</b>	<b>77 - 80</b>

# Concorde Fireplace Series



The Concorde Fireplace Series addresses the need and request for a lower-priced fireplace set. They feature the same 36" firebox as the other collections and a built-in hearth. They have less detail than the other collections, but are still a beautiful option for those on a budget. All pieces are available in several accent options.

**Concorde Arched Fireplace (36" Wood)**



Product ID—CNFPAW

The Concorde fireplace comes in two pieces consisting of a top unit and a bottom unit (with built-in hearth). The UL Listed stainless steel outdoor rated firebox has a 25 year warranty. Arched accents are available in choice of: Copthorne, Holland Premier, Hollandstone, Il Campo, Series 3000, Umbriano, or Unigranite. Comes with round metal termination cap.

Available upgrades: Low voltage lighting, Accent changes.

Approximate weight : Call for details.

Rough dimensions : 40" D x 52" W x 91.5" H

**Concorde Straight Fireplace (36" Wood)**



Product ID—CNFPSW

The Concorde fireplace comes in two pieces consisting of a top unit and a bottom unit (with built-in hearth). The UL Listed stainless steel outdoor rated firebox has a 25 year warranty. Straight accents are available in choice of: Copthorne, Holland Premier, Hollandstone, Il Campo, Series 3000, Umbriano, or Unigranite. Comes with round metal termination cap.

Available upgrades: Low voltage lighting, Accent changes.

Approximate weight : Call for details.

Rough dimensions : 40" D x 52" W x 91.5 H

**Concorde Arched Fireplace (36" Gas)**



Product ID—CNFPABG (gas burning, without chimney)  
Product ID—CNFPATG (gas burning, with chimney/top)

The Concorde Gas Fireplace comes as a one piece unit with a finished top (with built-in hearth). The UL Listed stainless steel outdoor rated firebox has a 25 year warranty and includes a log set. Available as natural gas or LP (must specify). Arched accents are available in choice of: Copthorne, Holland Premier, Hollandstone, Il Campo, Series 3000, Umbriano, or Unigranite.

Available upgrades: Remote Control, Stainless Front Cover, Low voltage lighting, Accent changes, Chimney (same appearance as wood burning).

Approximate weight : Call for details.

Rough dimensions : 40" D x 52" W x 50.75" H

**Concorde Straight Fireplace (36" Gas)**



Product ID—CNFPSBG (gas burning, without chimney)  
Product ID—CNFPSTG (gas burning, with chimney/top)

The Concorde Gas Fireplace comes as a one piece unit with a finished top (with built-in hearth). The UL Listed stainless steel outdoor rated firebox has a 25 year warranty and includes a log set. Available as natural gas or LP (must specify). Straight accents are available in choice of: Copthorne, Holland Premier, Hollandstone, Il Campo, Series 3000, Umbriano, or Unigranite.

Available upgrades: Remote Control, Stainless Front Cover, Low voltage lighting, Accent changes, Chimney (same appearance as wood burning).

Approximate weight : Call for details.

Rough dimensions : 40" D x 52" W x 50.75" H

**Concorde Wood Boxes**



*\*Sold as a set.*

Product ID—CNWDBX

The Concorde Wood Boxes come as a set consisting of a right and left box for storing wood. Accents are available in choice of: Copthorne, Holland Premier, Hollandstone, Il Campo, Series 3000, Umbriano, or Unigranite. Note: The "floor" is not included with this set.

Available upgrades: Accent changes.

Approximate weight : Call for details.

Rough dimensions : 28" D x 28" W x 34.75" H

# The Cordova Collection



The Cordova Collection is a beautiful combination of Brussels Dimensional, and the clean and contemporary look of Series 3000 accents. The Cordova's clean elegant lines make it very compatible to most landscape designs.

**Cordova Fireplace (36" - Wood)**



The Cordova fireplace comes standard in two pieces consisting of a top unit and a bottom unit. The UL Listed stainless steel outdoor rated firebox has a 25 year warranty.  
Available upgrades: Low voltage lighting, Accent changes, Glass Doors.

Approximate weight : Bottom unit—3510 lbs.      Rough dimensions : 36" D x 60" W x 102" H  
Top unit—2291 lbs.

Product ID—COFRPW (36" Fireplace)  
Product ID—COFRPW42 (42" Fireplace)

**Cordova Fireplace (36" - Gas)**



The Cordova Gas Fireplace comes as a one piece unit with a finished top. The UL Listed stainless steel outdoor rated firebox has a 25 year warranty and includes a log set. Available as natural gas or LP (must specify).  
Available upgrades: Remote Control, Stainless Front Cover, Low voltage lighting, Accent changes, Chimney (same appearance as wood burning).

Approximate weight : Bottom unit—3784 lbs.      Rough dimensions : 36" D x 60" W x 50.75" H  
With optional top unit—5894 lbs.

Product ID—COFRPBG (gas burning, without chimney)  
Product ID—COFRPTG (gas burning, with chimney/top)

**Cordova Wood Boxes**

The Cordova Wood Boxes come as a set consisting of a right and left box for storing wood.  
Available upgrades: Low voltage lighting, Accent changes.



*\*Sold as a set.*

Approximate weight per box : 1870 lbs.  
Rough dimensions : 28" D x 36" W x 42.75" H

Product ID—COWDBX

**Cordova Hearth**

The Cordova Straight Hearth is a one piece unit that keys into the fireplace.  
Available upgrades: Accent changes.



Approximate weight : 1030 lbs.  
Rough dimensions : 24" D x 60" W x 11" H

Product ID—COHTS

**Cordova Fireplace Water Feature Pair**

The Cordova Small Water Features are one piece units designed to sit on opposite sides of a Cordova fireplace. These water features are sold as a pair and feature a LED lit waterfall (12" spillway) (available in either amber, blue, red, or white). The stainless steel basin and water pump come with the unit.

Available upgrades: Accent changes, Low voltage lighting.



*\*Sold as a set.*

Approximate weight : Call for details.  
Rough dimensions : 48" D x 24" W x 50" H

Product ID—COWFPR

**Cordova Fire Table (Wood/Gas)**



The Cordova Fire Table is a one piece unit with a stainless steel basin and spark screen (wood version only). Gas version comes with gas fire ring, beaded glass, and stainless access door. Available as natural gas or LP (must specify).

Available upgrades: Low voltage lighting, Accent changes, Stainless Lid.

Approximate weight : Wood—3084 lbs.      Rough dimensions : 44" D x 44" W x 45.75" H  
 Gas—3234 lbs.      Table top dimensions : 51.75" x 51.75"

Product ID—CORFT (wood burning)

Product ID—CORFTG (gas burning)

**Cordova Fire Pit (Wood/Gas)**



The Cordova Fire Pit is a one piece unit that comes with a steel liner and a spark screen cover (wood version only). Gas version comes with gas fire ring and beaded glass. Available as natural gas or LP (must specify)

Available upgrades: Low voltage lighting, Accent changes, Stainless Lid.

Approximate weight : 2859 lbs.  
 Rough dimensions : 48" D x 48" W x 26.5" H

Product ID—COFRPIT (wood burning)

Product ID—COFRPITG (gas burning)

**Cordova Water Feature (24")**



The Cordova Water Feature is a one piece unit that features a LED lit waterfall (24" spillway) (available in either amber, blue, red, or white). The stainless steel basin and water pump come with the unit.

Available upgrades: Accent changes, Low voltage lighting.

Approximate weight : 3300 lbs.  
 Rough dimensions : 44.5" D x 51.75" W x 49.25" H

Product ID—COWATFT

**Cordova Brick Oven (Wood)**



The Cordova Brick Oven comes in two pieces. The top unit features a wood-fired brick oven and the bottom unit is designed as a wood storage holder. All operating instructions, tools, and warranty information are included with the unit. Includes pizza peel and brush.

Available upgrades: Accent changes, Low voltage lighting.

Approximate weight : Bottom unit—2860 lbs.  
 Top unit—3620 lbs.  
 Rough dimensions : 48" D x 48" W x 96.75" H

Product ID—COBRO

**Cordova Grill Island**



*\* Grill & doors not included. See OCS Stainless Grills & Accessories section for details.*

*As shown:  
 3 Burner Grill w/ Infra Red  
 30" Double Door*

The Cordova Grill Island is a one piece unit that has a cutout for a grill insert. Maximum cutout dimensions : 36"W x 25"D x 10"H. Custom grill cutouts available. ALL CUTOUT DIMENSIONS MUST BE SPECIFIED WHEN ORDERING.

Available upgrades: Accent changes, Custom door and drawer options, Low voltage lighting, Available without a top (call for details).

Approximate weight: 4160 lbs.  
 Rough dimensions : 36" D x 75" W x 42.75" H

Product ID—COGRISL

**Cordova Bar Island**



The Cordova Bar Island is a one piece unit that has approximately 20 sq ft of counter space. The back of the bar has refrigerator, door, and/or drawer openings.

Available upgrades: Accent changes, Custom door and drawer options, Low voltage lighting. The bar can be ordered without a top (call for details).

*\* Doors & fridge not included. See OCS Stainless Grills & Accessories section for details.*

*As shown:  
30" Double Door*

Approximate weight : 4110 lbs.

Rough dimensions : 32" D x 71" W x 48.25" H

Product ID—COBAR

**Cordova Wet Bar**



The Cordova Wet Bar is a one piece unit that comes standard with a sink. The back of the bar is designed for a refrigerator, door, and/or drawer openings.

Available upgrades: Accent changes, Custom door and drawer options, Low voltage lighting. The bar can be ordered without a top (call for details).

*\* Doors & fridge not included. See OCS Stainless Grills & Accessories section for details.*

*As shown:  
30" Double Door*

Approximate weight : 4128 lbs.

Rough dimensions : 32" D x 71" W x 48.25" H

Product ID—COWBR

**Cordova Mailbox**



The Cordova Mailbox is a one piece unit. Available with a cream or black cast aluminum mailbox insert.

Available upgrades: Accent changes, Low voltage lighting, Address engraving (call for details).

Approximate weight : 1835 lbs.

Rough dimensions : 24" D x 24" W x 68.5" H

Product ID—COMAIL

**Cordova Pillar (24" W)**



The Cordova Pillar is a one piece unit and is available with one to four Series 3000 insets.

Available upgrades: Low voltage lighting, Accent changes.

Approximate weight : 24" (1 inset)—1231 lbs.  
28" (1 inset)—1625 lbs.

Rough dimensions : 24" Column—24" D x 24" W x 38.5" H  
28" Column—28" D x 28" W x 43" H

Product ID—COPL124 (24" 1 inset)

Product ID—COPL324 (24" 3 insets)

Product ID—COPL224 (24" 2 insets)

Product ID—COPL424 (24" 4 insets)

**Cordova Pillar-Water Feature**



The Cordova Pillar-Water Feature is a one piece unit. It features a LED lit waterfall (12" spillway) (available in either amber, blue, red, or white). The stainless steel basin and water pump come with the unit. Shorter version available (call for details).

Available upgrades: Accent changes, Low voltage lighting, Address engraving (call for details).

Approximate weight : Call for details.

Rough dimensions : 48" D x 24" W x 58.75" H

Product ID—COPLWT



# The Tuscany Collection



The Tuscany Collection utilizes a striking combination of Brussels Dimensional, and the classic look of Copthorne accents. The Tuscany line features flowing arches and rounded Brussels Fullnose to create a soft comforting environment.

**Tuscany Fireplace (36" - Wood)**



The Tuscany fireplace comes standard in two pieces consisting of a top unit and a bottom unit. The UL Listed stainless steel outdoor rated firebox has a 25 year warranty.  
Available upgrades: Low voltage lighting, Accent changes, Glass Doors.

Approximate weight : Bottom unit—3510 lbs.      Rough dimensions : 36" D x 60" W x 102" H  
Top unit—2291 lbs.

Product ID—TUFRPW (36" Fireplace)  
Product ID—TUFRPW42 (42" Fireplace)

**Tuscany Fireplace (36" - Gas)**



The Tuscany Gas Fireplace comes as a one piece unit with a finished top. The UL Listed stainless steel outdoor rated firebox has a 25 year warranty and includes a log set. Available as natural gas or LP (must specify).  
Available upgrades: Remote Control, Stainless Front Cover, Low voltage lighting, Accent changes, Chimney (same appearance as wood burning).

Approximate weight : Bottom unit—3784 lbs.      Rough dimensions : 36" D x 60" W x 50.75" H  
With optional top unit—5894 lbs.

Product ID—TUFRPBG (gas burning, without chimney)  
Product ID—TUFRPTG (gas burning, with chimney/top)

**Tuscany Wood Boxes**



*\*Sold as a set.*

The Tuscany Wood Boxes come as a set consisting of a right and left box for storing wood.  
Available upgrades: Low voltage lighting, Accent changes.

Approximate weight per box : 1870 lbs.  
Rough dimensions : 28" D x 36" W x 42.75" H

Product ID—TUWDBXC (Basketweave Copthorne Top)  
Product ID—TUWDBXU (Umbriano Top)

**Tuscany Hearth (Arched or Straight)**



The Tuscany Hearth is a one piece unit that keys into the fireplace.  
Available upgrades: Accent changes.

Approximate weight : 990 lbs.  
Rough dimensions : 24" D x 60" W x 11" H

Product ID—TUHTAC (45 Copthorne Top)(straight)  
Product ID—TUHTSU (Umbriano Top)(straight)

Product ID—TUHTAC (45 Copthorne Top)(arched)  
Product ID—TUHTAU (Umbriano Top)(arched)

**Tuscany Fireplace Water Feature Pair**

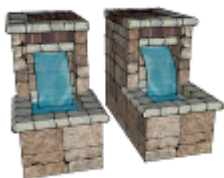

*\*Sold as a set.*

The Tuscany Small Water Features are one piece units designed to sit on opposite sides of a Tuscan fireplace. These water features are sold as a pair and feature a LED lit waterfall (12" spillway) (available in either amber, blue, red, or white). The stainless steel basin and water pump come with the unit.  
Available upgrades: Accent changes, Low voltage lighting.

Approximate weight : Call for details.  
Rough dimensions : 48" D x 24" W x 50.25" H

Product ID—TUWFPR

**Tuscany Fire Table (Wood/Gas)**



The Tuscany Fire Table is a one piece unit with a stainless steel basin and spark screen (wood version only). Gas version comes with gas fire ring, beaded glass, and stainless access door. Available as natural gas or LP (must specify).

Available upgrades: Low voltage lighting, Accent changes, Stainless Lid.

Approximate weight : Wood—2926 lbs.  
Gas—3076 lbs.

Rough dimensions : 44.5" D x 44.5" W x 45.5" H  
Tabletop dimensions : 48" x 48"

Product ID—TURFT (wood burning)

Product ID—TURFTG (gas burning)

**Tuscany Fire Pit (Wood/Gas)**



The Tuscany Fire Pit is a one piece unit that comes with a steel liner and a spark screen cover (wood version only). Gas version comes with gas fire ring and beaded glass. Available as natural gas or LP (must specify)

Available upgrades: Low voltage lighting, Accent changes, Stainless Lid.

Approximate weight : 2777 lbs.

Rough dimensions : 48" D x 48" W x 26.5" H

Product ID—TUFRPIT (wood burning)

Product ID—TUFRPITG (gas burning)

**Tuscany Water Feature (24")**



The Tuscany Water Feature is a one piece unit that features a LED lit waterfall (24" spillway) (available in either amber, blue, red, or white). The stainless steel basin and water pump come with the unit.

Available upgrades: Accent changes, Low voltage lighting.

Approximate weight : 3170 lbs.

Rough dimensions : 44.5" D x 51.75" W x 50.5" H

Product ID—TUWATFT

**Tuscany Brick Oven (Wood)**



The Tuscany Brick Oven comes in two pieces. The top unit features a wood-fired brick oven and the bottom unit is designed as a wood storage holder. All operating instructions, tools, and warranty information are included with the unit. Includes pizza peel and brush.

Available upgrades: Accent changes, Low voltage lighting.

Approximate weight : Bottom unit—2860 lbs.

Top unit—3620 lbs.

Rough dimensions : 48" D x 48" W x 96.75" H

Product ID—TUBRO

**Tuscany Grill Island**



*\* Grill & doors not included. See OCS Stainless Grills & Accessories section for details.*

*As shown:  
3 Burner Grill w/ Infra Red  
30" Double Door*

The Tuscany Grill Island is a one piece unit that has a cutout for a grill insert. Maximum cutout dimensions : 36"W x 25"D x 10"H. Custom grill cutouts available. ALL CUTOUT DIMENSIONS MUST BE SPECIFIED WHEN ORDERING.

Available upgrades: Accent changes, Custom door and drawer options, Low voltage lighting, Available without a top (call for details).

Approximate weight : 4160lbs.

Rough dimensions : 36" D x 72" W x 42.75" H

Product ID—TUGRISL

**Tuscany Bar Island**



The Tuscany Bar Island is a one piece unit that has approximately 20 sq ft of counter space. The back of the bar has refrigerator, door, and/or drawer openings.

Available upgrades: Accent changes, Custom door and drawer options, Low voltage lighting. The bar can be ordered without a top (call for details).

*\* Doors & fridge not included. See OCS Stainless Grills & Accessories section for details.*

Approximate weight : 410 lbs.

Rough dimensions : 32.5" D x 71" W x 44.5" H

**As shown:  
30" Double Door**

Product ID—TUBAR

**Tuscany Wet Bar**



The Tuscany Wet Bar is a one piece unit that comes standard with a sink. The back of the bar is designed for a refrigerator, door, and/or drawer openings.

Available upgrades: Accent changes, Custom door and drawer options, Low voltage lighting. The bar can be ordered without a top (call for details).

*\* Doors & fridge not included. See OCS Stainless Grills & Accessories section for details.*

Approximate weight : 4129 lbs.

Rough dimensions : 32.5" D x 71" W x 48.25" H

**As shown:  
30" Double Door**

Product ID—TUWBR

**Tuscany Mailbox**



The Tuscany Mailbox is a one piece unit. Available with a cream or black cast aluminum mailbox insert.

Available upgrades: Accent changes, Low voltage lighting, Address engraving (call for details).

Approximate weight : 1708 lbs.

Rough dimensions : 24" D x 24" W x 48.25" H

Product ID—TUMAIL

**Tuscany Pillar (24"W)**



The Tuscany Pillar is a one piece unit and is available with one to four Copthorne insets.

Available upgrades: Low voltage lighting, Accent changes.

Approximate weight : 24" (1 inset)—1231 lbs.  
28" (1 inset)—1625 lbs.

Rough dimensions : 24" Column—24" D x 24" W x 38.5" H  
28" Column—28" D x 28" W x 43" H

Product ID—TUPL124 (24" 1 inset)

Product ID—TUPL324 (24" 3 insets)

Product ID—TUPL224 (24" 2 insets)

Product ID—TUPL424 (24" 4 insets)

**Tuscany Pillar-Water Feature**



The Tuscany Pillar-Water Feature is a one piece unit. It features a LED lit waterfall (12" spillway) (available in either amber, blue, red, or white). The stainless steel basin and water pump come with the unit. Shorter version available (call for details).

Available upgrades: Accent changes, Low voltage lighting, Address engraving (call for details).

Approximate weight : Call for details.

Rough dimensions : 48" D x 24" W x 59" H

Product ID—TUPLWT

# The Barcelona Collection



The Barcelona Collection features the timeless feel of Brussels Dimensional and unique split Unigranite accents. The Roman arch theme throughout makes a lasting impression and is sure to compliment any home.

**Barcelona Fireplace (36" - Wood)**



The Barcelona fireplace comes standard in two pieces consisting of a top unit and a bottom unit. The UL Listed stainless steel outdoor rated firebox has a 25 year warranty.  
Available upgrades: Low voltage lighting, Accent changes.

Approximate weight : Bottom unit—3880 lbs.      Rough dimensions : 32" D x 60" W x 105.75" H  
Top unit—1801 lbs.

Product ID—BRFRPW (36" Fireplace)  
Product ID—BRFRPW42 (42" Fireplace)

**Barcelona Fireplace (36" Gas)**



The Barcelona Gas Fireplace comes as a one piece unit with a finished top. The UL Listed stainless steel outdoor rated firebox has a 25 year warranty and includes a log set. Available as natural gas or LP (must specify).  
Available upgrades: Remote Control, Low voltage lighting, Accent changes, Chimney (same appearance as wood burning).

Approximate weight : Call for details.      Rough dimensions : 32" D x 60" W x 56" H

Product ID—BRFRPBG (gas burning, without chimney)

**Barcelona Wood Boxes**

The Barcelona Wood Boxes come as a set consisting of a right and left box for storing wood.  
Available upgrades: Low voltage lighting, Accent changes.



*\*Sold as a set.*

Approximate weight per box : Call for details.  
Rough dimensions : 28" D x 36" W x 38.75" H

Product ID—BRWDBX

**Barcelona Hearth (Arched)**

The Barcelona Arched Hearth is a one piece unit that keys into the fireplace.  
Available upgrades: Accent changes.

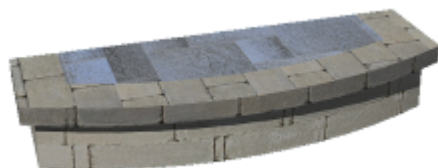

Approximate weight : 1120 lbs.  
Rough dimensions : 20" D x 60" W x 11" H

Product ID—BRHTA

**Barcelona Fireplace Water Feature Pair**



*\*Sold as a set.*

The Barcelona Small Water Features are one piece units designed to sit on opposite sides of a Barcelona fireplace. These water features are sold as a pair and feature a LED lit waterfall (12" spillway) (available in either amber, blue, red, or white). The stainless steel basin and water pump come with the unit.  
Available upgrades: Accent changes, Low voltage lighting.

Approximate weight : 3760 lbs.  
Rough dimensions : 48" D x 24" W x 42.75" H

Product ID—BRWFPR

**Barcelona Fire Table (Wood/Gas)**



The Barcelona Fire Table is a one piece unit with a stainless steel basin and spark screen (wood version only). Gas version comes with gas fire ring, beaded glass, and stainless access door. Available as natural gas or LP (must specify).

Available upgrades: Low voltage lighting, Accent changes, Stainless Lid.

Approximate weight : Call for details.

Rough dimensions : 44" D x 44" W x 44.25" H  
Tabletop dimensions : 48" x 48"

Product ID—BRRFT (wood burning)

Product ID—BRRFTG (gas burning)

**Barcelona Fire Pit (Wood/Gas)**

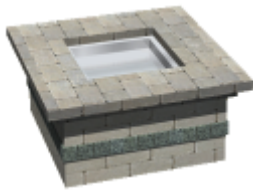

The Barcelona Fire Pit is a one piece unit that comes with a steel liner and a spark screen cover (wood version only). Gas version comes with gas fire ring and lava rock. Available as natural gas or LP (must specify)

Available upgrades: Low voltage lighting, Accent changes, Stainless Lid.

Approximate weight : Call for details.

Rough dimensions : 44" D x 44" W x 25.5" H  
Tabletop dimensions : 54" x 54"

Product ID—BRFRPIT (wood burning)

Product ID—BRFRPITG (gas burning)

**Barcelona Water Feature (24")**



The Barcelona Water Feature is a one piece unit that features a LED lit waterfall (24" spillway) (available in either amber, blue, red, or white). The stainless steel basin and water pump come with the unit.

Available upgrades: Accent changes, Low voltage lighting.

Approximate weight : Call for details.

Rough dimensions : 44" D x 52" W x 56" H

Product ID—BRWATFT

**Barcelona Brick Oven (Wood)**



The Barcelona Brick Oven comes in two pieces. The top unit features a wood-fired brick oven and the bottom unit is designed as a wood storage holder. All operating instructions, tools, and warranty information are included with the unit. Includes pizza peel and brush.

Available upgrades: Accent changes, Low voltage lighting.

Approximate weight : Call for details.

Rough dimensions : 48" D x 48" W x 94.75" H

Product ID—BRBRO

**Barcelona Grill Island**



*\* Grill & doors not included. See OCS Stainless Grills & Accessories section for details.*

*As shown:*

*3 Burner Grill w/ Infra Red  
30" Double Door*

The Barcelona Grill Island is a one piece unit that has a cutout for a grill insert. Maximum cutout dimensions : 36W x 25D x 10H. Custom grill cutouts available. ALL CUTOUT DIMENSIONS MUST BE SPECIFIED WHEN ORDERING.

Available upgrades: Accent changes, Custom door and drawer options, Low voltage lighting, Available without a top (call for details).

Approximate weight : Call for details.

Rough dimensions : 36" D x 76" W x 42.75" H

Product ID—BRGRISL

# The Kensington Collection



The larger scale of the Kensington Collection incorporates an impressive array of Brussels Dimensional, Estate Wall, Brussels Fullnose Coping, and Copthorne Accents. This collection offers clients a stately and elegant appearance.



**Kensington Fireplace (36" -Wood)**



The Kensington fireplace comes standard in two pieces consisting of a top unit and a bottom unit. The UL Listed stainless steel outdoor rated firebox has a 25 year warranty.  
Available upgrades: Low voltage lighting, Accent changes, Glass Doors.

Approximate weight : Bottom unit—5100 lbs.      Rough dimensions : 36" D x 63" W x 114" H  
Top unit—2731 lbs.

Product ID—KEFRPW (36" Fireplace)  
Product ID—KEFRPW42 (42" Fireplace)

**Kensington Fireplace (36" - Gas)**



The Kensington Gas Fireplace comes as a one piece unit with a finished top. The UL Listed stainless steel outdoor rated firebox has a 25 year warranty and includes a log set. Available as natural gas or LP (must specify).  
Available upgrades: Remote Control, Stainless Front Cover, Low voltage lighting, Accent changes, Chimney (same appearance as wood burning).

Approximate weight : Call for details.      Rough dimensions : 36" D x 63" W x 62" H

Product ID—KEFRPBG (gas burning, without chimney)

**Kensington Wood Boxes**



*\*Sold as a set.*

The Kensington Wood Boxes come as a set consisting of a right and left box for storing wood.  
Available upgrades: Low voltage lighting, Accent changes.

Approximate weight per box : Call for details.  
Rough dimensions : 28" D x 44" W x 46" H

Product ID—KEWDBX

**Kensington Hearth (Arched)**



The Kensington Arched Hearth is a one piece unit that keys into the fireplace.  
Available upgrades: Accent changes.

Approximate weight : Call for details.  
Rough dimensions : 24" D x 63" W x 11" H

Product ID—KEHTA

**Kensington Fireplace Water Feature Pair**



*\*Sold as a set.*

The Kensington Small Water Features are one piece units designed to sit on opposite sides of a Kensington fireplace. These water features are sold as a pair and feature a LED lit waterfall (12" spillway) (available in either amber, blue, red, or white). The stainless steel basin and water pump come with the unit.  
Available upgrades: Accent changes, Low voltage lighting.

Approximate weight : 3760 lbs.  
Rough dimensions : 48" D x 24" W x 46" H

Product ID—KEWFPR

**Kensington Fire Table (Wood/Gas)**



The Kensington Fire Table is a one piece unit with a stainless steel basin and spark screen (wood version only). Gas version comes with gas fire ring, beaded glass, and stainless access door. Available as natural gas or LP (must specify).

Available upgrades: Low voltage lighting, Accent changes, Stainless Lid.

Approximate weight : Call for details.

Rough dimensions : 44" D x 44" W x 44" H  
Tabletop dimensions : 48" x 48"

Product ID—KERFT (wood burning)

Product ID—KERFTG (gas burning)

**Kensington Fire Pit (Wood/Gas)**



The Kensington Fire Pit is a one piece unit that comes with a steel liner and a spark screen cover (wood version only). Gas version comes with linear gas burner, decorative rock, and stainless cover. Available as natural gas or LP (must specify)

Available upgrades: Low voltage lighting, Accent changes, Stainless Lid.

Approximate weight : Call for details.

Rough dimensions : 36" D x 64" W x 30" H  
Tabletop dimensions : 41" x 69"

Product ID—KEFRPIT (wood burning)

Product ID—KEFRPITG (gas burning)

**Kensington Water Feature**

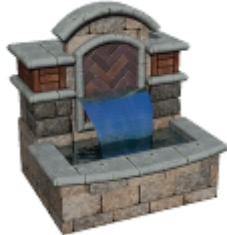

The Kensington Water Feature is a one piece unit that features a LED lit waterfall (24" spillway) (available in either amber, blue, red, or white). The stainless steel basin and water pump come with the unit.

Available upgrades: Accent changes, Low voltage lighting.

Approximate weight : Call for details.

Rough dimensions : 44" D x 52" W x 60" H

Product ID—KEWATFT

**Kensington Brick Oven**



The Kensington Brick Oven comes in two pieces. The top unit features a wood-fired brick oven and the bottom unit is designed as a wood storage holder. All operating instructions, tools, and warranty information are included with the unit. Includes pizza peel and brush.

Available upgrades: Accent changes, Low voltage lighting.

Approximate weight : Call for details.

Rough dimensions : 48" D x 48" W x 93" H

Product ID—KEBRO

**Kensington Grill Island**

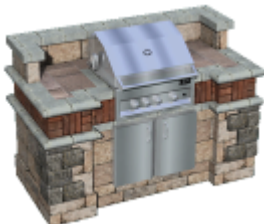

*\* Grill & doors not included. See OCS Stainless Grills & Accessories section for details.*

*As shown:  
3 Burner Grill w/ Infra Red  
30" Double Door*

The Kensington Grill Island is a one piece unit that has a cutout for a grill insert. Maximum cutout dimensions : 36W x 25D x 10H. Custom grill cutouts available. ALL CUTOUT DIMENSIONS MUST BE SPECIFIED WHEN ORDERING.

Available upgrades: Accent changes, Custom door and drawer options, Low voltage lighting, Available without a top (call for details).

Approximate weight : Call for details.

Rough dimensions : 36" D x 76" W x 52.25" H

Product ID—KEGRISL

# Cityscape Collection



We now have a solution for those smaller scale urban lot settings! Introducing the Unilock Cityscape Element Collection. This collection was designed with the following criteria in mind. All the Elements are designed to be no greater than 32" deep so that they can fit through a gate. All the Elements are less than 1600 lbs (with the exception of the brick oven top unit – which is closer to 2100 lbs) so that a narrow access walk behind loader can be used for installs. The fireplace, fire pit, and fire table all feature a unique “green” VioFlame Bio Ethanol burner – which should meet the burn codes of most metropolitan areas, especially where wood burning is prohibited. The bar and grill island feature an optional Kenyon electric grill, again meeting the code requirements of many major cities. All Elements come standard with Unilock’s Ledgestone coping – in any color available.

The accent materials can be specified as well and include Copthorne, Holland Premier, Hollandstone, Il Campo, Series 3000, Umbriano, or Unigranite. This flexibility will allow your clients to tailor their Cityscape Elements to fit their particular style. Note: Call for specific weights prior to ordering.

---

**Cityscape Fireplace (Straight or Arched)**



The Cityscape fireplace comes standard in two pieces consisting of a top unit and a bottom unit. This unit features a Bio Ethanol stainless burner (not available in gas or wood burning). Please specify straight or arched style, specific accent choice, and colors when ordering.

Available upgrades: Low voltage lighting.

Approximate weight : Call for details.

Rough dimensions : 22.5" D x 48" W x 72.75" H

Product ID—CTFRP

---

**Cityscape Fire Table**



The Cityscape Fire Table is a one piece unit. This unit features a Bio Ethanol stainless burner (not available in gas or wood burning). Please specify specific accent choice and colors when ordering.

Available upgrades: Low voltage lighting.

Approximate weight : Call for details.

Rough dimensions : 28" D x 28" W x 46" H

Tabletop dimensions : 36.5" x 36.5"

Product ID—CTRFT

---

**Cityscape Fire Pit**



The Cityscape Fire Pit is a one piece unit. This unit features two Bio Ethanol stainless burners (not available in gas or wood burning). Please specify specific accent choice and colors when ordering.

Available upgrades: Low voltage lighting.

Approximate weight : Call for details.

Rough dimensions : 22.5" D x 37" W x 18.75" H

Tabletop dimensions : 31.5" x 45.5"

Product ID—CTFRPIT

---

**Cityscape Water Feature (12")**



The Cityscape Water Feature is a one piece unit that features a LED lit waterfall (12" spillway) (available in either amber, blue, red, or white). The stainless steel basin and water pump come with the unit. Please specify specific accent choice and colors when ordering.

Available upgrades: Low voltage lighting.

Approximate weight : Call for details.

Rough dimensions : 30" D x 36" W x 45.75" H

Product ID—CTWATFT

---

### Cityscape Brick Oven (Wood)



The Cityscape Brick Oven comes in two pieces. The top unit features a wood-fired brick oven and the bottom unit is designed as a wood storage holder. All operating instructions, tools, and warranty information are included with the unit. Includes pizza peel and brush. Please specify specific accent choice and colors when ordering.

Available upgrades: Low voltage lighting.

Approximate weight : Call for details.

Rough dimensions : 36" D x 43.5" W x 86" H

Product ID—CTBRO

---

### Cityscape Grill/Bar Island



The Cityscape Grill/Bar Island is a two piece unit that has a cutout for an electric Kenyon grill insert. Custom grill cutouts available (call for details). ALL CUTOUT DIMENSIONS MUST BE SPECIFIED WHEN ORDERING. Please specify specific accent choice and colors when ordering.

Available upgrades: Custom door and drawer options, Low voltage lighting, Available without a top (call for details).

*\* Grill & door not included. See  
OCS Stainless Grills &  
Accessories section for details.*

*As shown:  
3 Burner Grill w/ Infra Red  
Single Deluxe Door*

Approximate weight : Call for details.

Rough dimensions : 28.5" D x 56" W x 46" H

Product ID—CTGRISL

---

### Cityscape Pillar



The Cityscape Pillar is a one piece unit and includes two insets (opposite sides). Please specify specific accent choice and colors when ordering.

Available upgrades: Low voltage lighting.

Approximate weight : Call for details.

Rough dimensions : 23.5" D x 23.5" W x 39" H

Product ID—CTPL224

# Additional Elements



These additional elements set the tone for an ideal gathering place for family and friends, or an intimate retreat for two.

**Athens Fireplace (Wood)**



\* Wood boxes available, please call for details.

Product ID—ATFRP (36" Fireplace)  
Product ID—ATFRP42 (42" Fireplace)

The Athens fireplace comes standard in two pieces consisting of a top unit and a bottom unit. The UL Listed stainless steel outdoor rated firebox has a 25 year warranty.

Available upgrades: Low voltage lighting, Accent changes, Glass Doors.

Approximate weight (36" Fireplace) : Bottom unit—2881 lbs.  
Top unit—2600 lbs.

Rough dimensions (36" Fireplace) : 37" D x 67" W x 109.25 H

**Bordeaux Fireplace (Wood)**



\* Wood boxes available, please call for details.

Product ID—BDFRP (36" Fireplace)  
Product ID—BDFRP42 (42" Fireplace)

The Bordeaux fireplace comes standard in two pieces consisting of a top unit and a bottom unit. The UL Listed stainless steel outdoor rated firebox has a 25 year warranty.

Available upgrades: Low voltage lighting, Accent changes, Glass Doors.

Approximate weight (36" Fireplace): Bottom unit—2221 lbs.  
Top unit—4380 lbs.

Rough dimensions (36" Fireplace) : 32.5" D x 60" W x 100.75" H

**Geneva Fireplace (Wood)**



Product ID—GEFRP (36" Fireplace)  
Product ID—GEFRP42 (42" Fireplace)

Product ID—GEWDBX (wood boxes)  
Product ID—GEHTA (hearth)

The Geneva fireplace comes standard in two pieces consisting of a top unit and a bottom unit. The UL Listed stainless steel outdoor rated firebox has a 25 year warranty.

Available upgrades: Low voltage lighting, Accent changes, Glass Doors.

Approximate weight (36" Fireplace) : Bottom unit—24441 lbs.  
Top unit—4350 lbs.

Rough dimensions (36" Fireplace) : 37.25" D x 60" W x 104.5" H

**Zurich Fireplace (Wood)**



\* Wood boxes available, please call for details.

The Zurich fireplace comes standard in two pieces consisting of a top unit and a bottom unit. The UL Listed stainless steel outdoor rated firebox has a 25 year warranty.

Available upgrades: Low voltage lighting, Accent changes, Glass Doors.

Approximate weight (36" Fireplace): Bottom unit—2981 lbs.  
Top unit—4805 lbs.

Rough dimensions (36" Fireplace) : 36" D x 68.5" W x 114" H

Product ID—ZUFRP (36" Fireplace)

Product ID—ZUFRP42 (42" Fireplace)

**Hamburg Fireplace (Wood)**



\* Light & wood mantle not included.

The Hamburg fireplace comes standard in two pieces consisting of a top unit and a bottom unit. The UL Listed stainless steel outdoor rated firebox has a 25 year warranty.

Available upgrades: Low voltage lighting, Accent changes, Glass Doors.

Approximate weight (36" Fireplace) : Bottom unit—3843 lbs.  
Middle unit—2800 lbs.  
Top unit—2703 lbs.  
Wood Box—1870 lbs.  
Planters—1870 lbs. ea. (3740 pair)

Rough dimensions (36" Fireplace) : 33.75" D x 60" W x 109.25" H (Fireplace Only)  
42" D x 148" W x 109.25" H (Set)

Product ID—HMFRP (36" Fireplace)

Product ID—HMFRP42 (42" Fireplace)

Product ID—HMPL (planters)

Product ID—HMWDBX (lower wood box unit)

**Hamburg Brick Oven (Wood)**



The Hamburg Brick Oven comes in two pieces. The top unit features a wood-fired brick oven and the bottom unit is designed as a wood storage holder. All operating instructions, tools, and warranty information are included with the unit. Includes pizza peel and brush.

Available upgrades: Accent changes, Low voltage lighting.

Approximate weight : Bottom unit—2444 lbs.  
Top unit—4350 lbs.

Rough dimensions : 48" D x 48" W x 104.5" H

Product ID—HMBRO



# Seatwall Options



This section includes pricing for modular seatwalls and decorative seatwall insets. This can provide your clients with a wide array of attractive options to add a unique twist to any outdoor living space.

--- Wall Insets ---



Wall Inset 204



Approximate weight : 205 lbs.

Rough dimensions : 24" D x 24" W x 7" H

Product ID—WLST204

Wall Inset 200



Approximate weight : 205 lbs.

Rough dimensions : 23.75" D x 23.75" W x 8" H

Product ID—WLST200

Wall Inset 205



Approximate weight : 190 lbs.

Rough dimensions : 24" D x 24" W x 7" H

Product ID—WLST205

Wall Inset 201



Approximate weight : 160 lbs.

Rough dimensions : 24" D x 24" W x 7" H

Product ID—WLST201

- 24" H Brussels Dimensional Seatwalls -



Wall Inset 202



Approximate weight : 180 lbs.

Rough dimensions : 24" D x 28" W x 7" H

*\*Glass not included. Call for pricing & color chart.*

Product ID—WLST202

Curved



Modular curved seatwalls include 24" (4" designed to be buried) of Brussels Dimensional plus a 3" Brussels XL cap. **Walls are priced per lineal foot.**

Approximate weight : call for details.

Rough dimensions : custom

Product ID—WLCUS

Wall Inset 203



Approximate weight : 200 lbs.

Rough dimensions : 24" D x 24" W x 7" H

Product ID—WLST203

Straight



Modular straight seatwalls include 24" (4" designed to be buried) of Brussels Dimensional plus a 3" Brussels XL cap. **Walls are priced per lineal foot.**

Approximate weight : call for details.

Rough dimensions : custom

Product ID—WLCUS

# Unilock Custom Collection



With the wide variety of pavers and wall materials that Unilock manufactures, we realized that there is a desire to be able to create Elements that are unique. Your clients can now create Elements that fit in perfectly with the creative outdoor living projects they are designing. We are answering that request with our exciting new Unilock Custom Elements Collection. We have taken the ever popular Tuscany platform and tweaked it slightly to create three new Custom “styles”.

**Unilock Custom Elements Collection**

Three distinct styles (arched, peaked, straight) allow for almost endless customization. You and your clients can now decide on the following details:

- body color
- accent brick style
- accent color
- 4” decorative saw tooth or accent brick banding
- inset and arch shapes
- inset patterns
- coping material
- lighting



Since the platform is the same, the price is still very competitive with a standard Tuscan fireplace. All the standard Elements are incorporated in the collection such as: fireplaces, wood boxes, hearths, brick ovens, grill and bar islands, fire tables, fire pits, water features, and pillars. Here are a few examples of Unilock Custom Elements:



Gas Fireplace:  
Arched

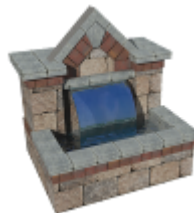

Water Feature:  
Peaked



Grill Island:  
Straight

In an effort to simplify each item when ordering, we’ve standardized each type of Custom Element. On the first page you will see some examples of each style (Arched, Peaked, and Straight) and on the second page you will find a detail of each Element that also doubles as an order form. If your dealer or contractor is interested in a Custom Element, you can then print those two pages back to back and send it to them as an order form. Please contact us at 877-332-6842 if you have any questions. It may take some time in the beginning to walk you through the process. All these components are also available on Sketch Up Warehouse.

**NOTE: BASE PRICE DOES NOT INCLUDE ANY BANDING, INSETS, OR COPING UPGRADES. BRUSSELS XL IS STANDARD FOR COPING.**

***Five Step Order Process:***

1. Pick the style and main body color
2. Pick the accent brick and color
3. Pick your coping upgrades
4. Total up your order, sign, date, and send to Harmony
5. Harmony will return sales order confirmation

**Main Body & Accent Colors**

Main Body Colors



Coffee Creek



Limestone



Sierra



Prairie



Sandstone

Accent Colors

Fullnose



Limestone

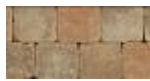

Prairie



Sandstone

Ledgestone



Blue



Buff

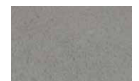

Gray

Copthorne



Burgandy Red



Burnt Clay



Old Oak



Old Oak/  
Burgandy Red/  
Burnt Clay

Richcliff



Pebble  
Taupe



Dawn Mist



Pebble Taupe/  
Dawn Mist

Umbriano

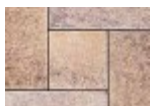

Autumn  
Sunset



Midnight Sky



Winter  
Marvel



Summer  
Rose

Il Campo



Coffee  
Creek



Heritage  
Brown



Oakwood

Series 3000



Mineral Ice  
Grey



Mocha  
Brown



Onyx Black



Chardonnay  
Tan

Unigranite

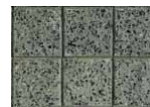

Slate



Black



Rose

Hollandstone



Autumn Red



Rustic Red



Prairie



River



Sierra



Buff



Red



Charcoal

Holland Premier



Charleston



Heritage  
Brown

Note: Colors may vary. See actual samples when determining color choices.

**Fireplace**

Straight



As shown: Main body color is Brussels Dimensional Sierra, Coping is Ledgestone Coping Gray, & Accent is Series 3000 Black.

Peaked



As shown: Main body color is Brussels Dimensional Sierra, Coping is Brussels XL Limestone, & Accent is Hollandstone Premier Charlston.

Arched



As shown: Main body color is Brussels Dimensional Sierra, Coping is Fullnose Limestone, & Accent is Richcliff Dawn Mist.

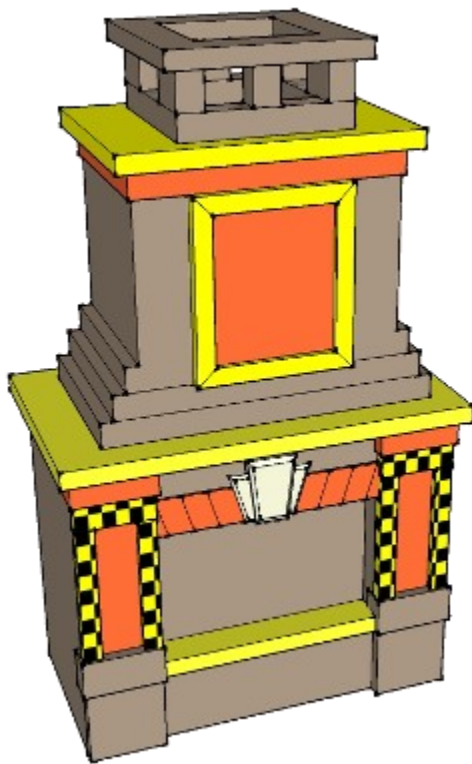

**Color Legend :**

- ◆ Main Body
- ◆ Coping & Inset Trim
- ◆ Insets & Banding
- ◆ Will match chosen coping color but will be Brussels Material.

**Note :** If Ledgestone is chosen for coping, color combinations will be as follows:

- Blue or gray coping = Limestone
- Buff coping = Sandstone

Unilock Custom Fireplace Order Form

A : Style & Main Body Color (Brussels XL coping is standard) ◆

- Style : [ ] Arched [ ] Peaked [ ] Straight
Main Body Color : [ ] Sandstone [ ] Limestone [ ] Sierra [ ] Prairie

Base Price (does not include any banding, accents, or insets).....Price : \$

B : Accent Brick & Color Upgrades ◆

- Copthorne : [ ] 3 Color Blend [ ] Burgundy Red [ ] Burnt Clay [ ] Old Oak
Richcliff : [ ] 2 Color Blend [ ] Pebble Taupe [ ] Dawn Mist

Upgrade Price .....Add : \$

- Hollandstone : [ ] Autumn Red [ ] Rustic Red [ ] Prairie [ ] River [ ] Sierra [ ] Buff [ ] Red [ ] Charcoal
Umbriano : [ ] Autumn Sunset [ ] Midnight Sky [ ] Winter Marvel [ ] Summer Rose
Il Campo : [ ] Coffee Creek [ ] Heritage Brown [ ] Oak wood [ ] Summer Rose

- Series 3000 : [ ] Mineral Ice Grey [ ] Mocha Brown [ ] Onyx Black [ ] Chardonnay Tan
Unigranite : [ ] Slate [ ] Black [ ] Red
Holland Premier : [ ] Charleston [ ] Heritage Brown

Upgrade Price .....Add : \$

Requested Inset Pattern : \_\_\_\_\_
(Example: 45° Herringbone, Running Bond, & Stack Bond, etc.)

C : Coping ◆

- Fullnose : [ ] Limestone [ ] Prairie [ ] Sandstone

Upgrade Price .....Add : \$

- Ledgestone: [ ] Blue [ ] Buff [ ] Gray

Upgrade Price .....Add : \$

Contact Name: \_\_\_\_\_ Base Price : \$ \_\_\_\_\_

Phone/Email : \_\_\_\_\_ Accent & Upgrades : \$ \_\_\_\_\_

PO # : \_\_\_\_\_ Date : \_\_\_\_\_ Coping : \$ \_\_\_\_\_

Signature : \_\_\_\_\_ TOTAL : \$ \_\_\_\_\_

# Gas Fireplace

Straight



As shown: Main body color is Brussels Dimensional Sierra, Coping is LedgeStone Coping Gray, & Accent is Series 3000 Black.

Peaked



As shown: Main body color is Brussels Dimensional Sierra, Coping is Brussels XL Limestone, & Accent is Hollandstone Premier Charlston.

Arched



As shown: Main body color is Brussels Dimensional Sierra, Coping is Fullnose Limestone, & Accent is Richcliff Dawn Mist.

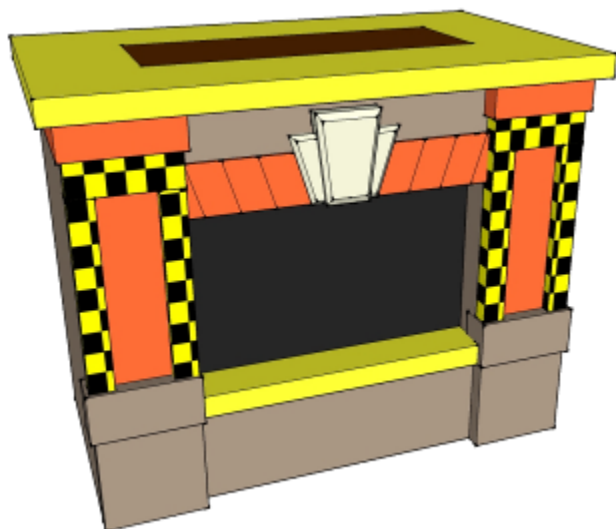

**Color Legend :**

- ◆ Main Body
- ◆ Coping & Inset Trim
- ◆ Insets & Banding
- ◆ Umbriano (select color)
- ◆ Will match chosen coping color but will be Brussels Material.

**Note :** If LedgeStone is chosen for coping, color combinations will be as follows:

- Blue or gray coping = Limestone
- Buff coping = Sandstone



Unilock Custom Gas Fireplace Order Form

A : Style & Main Body Color (Brussels XL coping is standard) ◆

- Style : [ ] Arched [ ] Peaked [ ] Straight
Main Body Color : [ ] Sandstone [ ] Limestone [ ] Sierra [ ] Prairie

Base Price (does not include any banding, accents, or insets).....Price : \$

B : Accent Brick & Color Upgrades ◆

- Copthorne : [ ] 3 Color Blend [ ] Burgundy Red [ ] Burnt Clay [ ] Old Oak
Richcliff : [ ] 2 Color Blend [ ] Pebble Taupe [ ] Dawn Mist

Upgrade Price .....Add : \$

- Hollandstone : [ ] Autumn Red [ ] Rustic Red [ ] Prairie [ ] River [ ] Sierra [ ] Buff [ ] Red [ ] Charcoal
Umbriano : [ ] Autumn Sunset [ ] Midnight Sky [ ] Winter Marvel [ ] Summer Rose
Il Campo : [ ] Coffee Creek [ ] Heritage Brown [ ] Oak wood [ ] Summer Rose

- Series 3000 : [ ] Mineral Ice Grey [ ] Mocha Brown [ ] Onyx Black [ ] Chardonnay Tan
Unigranite : [ ] Slate [ ] Black [ ] Red
Holland Premier : [ ] Charleston [ ] Heritage Brown

Upgrade Price .....Add : \$

Requested Inset Pattern : \_\_\_\_\_
(Example: 45° Herringbone, Running Bond, & Stack Bond, etc.)

C : Coping ◆

- Fullnose : [ ] Limestone [ ] Prairie [ ] Sandstone

Upgrade Price .....Add : \$

- Ledgestone: [ ] Blue [ ] Buff [ ] Gray

Upgrade Price .....Add : \$

Contact Name: \_\_\_\_\_ Base Price : \$ \_\_\_\_\_

Phone/Email : \_\_\_\_\_ Accent & Upgrades : \$ \_\_\_\_\_

PO # : \_\_\_\_\_ Date : \_\_\_\_\_ Coping : \$ \_\_\_\_\_

Signature : \_\_\_\_\_ TOTAL : \$ \_\_\_\_\_

# Wood Boxes

Straight

Peaked

Arched



As shown: Main body color is Brussels Dimensional Sierra, Coping is Ledgestone Coping Gray, & Accent is Series 3000 Black.

As shown: Main body color is Brussels Dimensional Sierra, Coping is Brussels XL Limestone, & Accent is Hollandstone Premier Charlston.

As shown: Main body color is Brussels Dimensional Sierra, Coping is Fullnose Limestone, & Accent is Richcliff Dawn Mist.

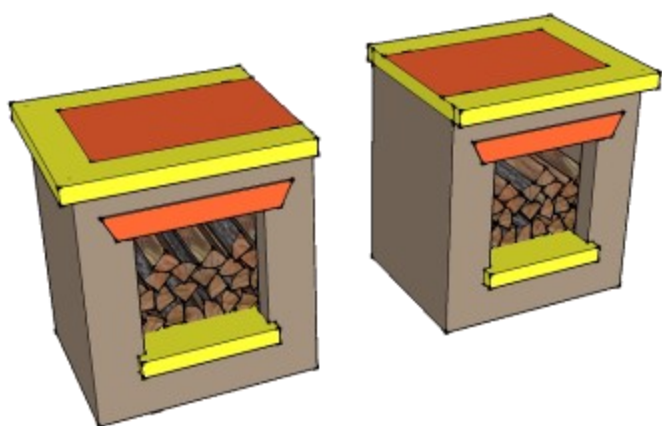

**Color Legend :**

- Main Body
- Coping & Inset Trim
- Insets & Banding

Unilock Custom Wood Box Set Order Form

A : Style & Main Body Color (Brussels XL coping is standard) ◆

- Style : [ ] Arched [ ] Peaked [ ] Straight
Main Body Color : [ ] Sandstone [ ] Limestone [ ] Sierra [ ] Prairie

Base Price (does not include any banding, accents, or insets).....Price : \$

B : Accent Brick & Color Upgrades ◆

- Copthorne : [ ] 3 Color Blend [ ] Burgundy Red [ ] Burnt Clay [ ] Old Oak
Richcliff : [ ] 2 Color Blend [ ] Pebble Taupe [ ] Dawn Mist

Upgrade Price .....Add : \$

- Hollandstone : [ ] Autumn Red [ ] Rustic Red [ ] Prairie [ ] River [ ] Sierra [ ] Buff [ ] Red [ ] Charcoal
Umbriano : [ ] Autumn Sunset [ ] Midnight Sky [ ] Winter Marvel [ ] Summer Rose
Il Campo : [ ] Coffee Creek [ ] Heritage Brown [ ] Oak wood [ ] Summer Rose

- Series 3000 : [ ] Mineral Ice Grey [ ] Mocha Brown [ ] Onyx Black [ ] Chardonnay Tan
Unigranite : [ ] Slate [ ] Black [ ] Red
Holland Premier : [ ] Charleston [ ] Heritage Brown

Upgrade Price .....Add : \$

Requested Inset Pattern : \_\_\_\_\_
(Example: 45° Herringbone, Running Bond, & Stack Bond, etc.)

C : Coping ◆

- Fullnose : [ ] Limestone [ ] Prairie [ ] Sandstone

Upgrade Price .....Add : \$

- Ledgestone: [ ] Blue [ ] Buff [ ] Gray

Upgrade Price .....Add : \$

Contact Name: \_\_\_\_\_ Base Price : \$ \_\_\_\_\_

Phone/Email : \_\_\_\_\_ Accent & Upgrades : \$ \_\_\_\_\_

PO # : \_\_\_\_\_ Date : \_\_\_\_\_ Coping : \$ \_\_\_\_\_

Signature : \_\_\_\_\_ TOTAL : \$ \_\_\_\_\_

# Hearth

Straight

Peaked

Arched



As shown: Main body color is Brussels Dimensional Sierra, Coping is Ledgestone Coping Gray, & Accent is Series 3000 Black.

As shown: Main body color is Brussels Dimensional Sierra, Coping is Brussels XL Limestone, & Accent is Hollandstone Premier Charleston.

As shown: Main body color is Brussels Dimensional Sierra, Coping is Fullnose Limestone, & Accent is Richcliff Dawn Mist.

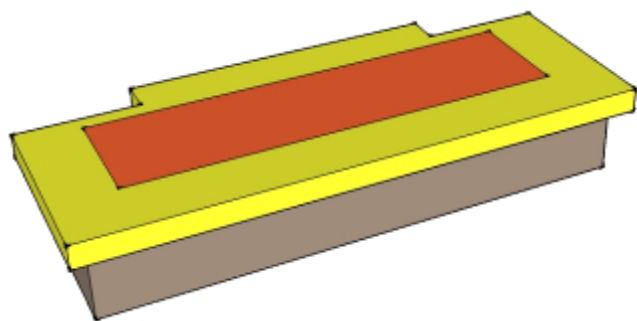

Color Legend :

- ◆ Main Body
- ◆ Coping & Inset Trim
- ◆ Insets & Banding

Unilock Custom Hearth Order Form

A : Style & Main Body Color (Brussels XL coping is standard) ◆

- Style : [ ] Arched [ ] Peaked [ ] Straight
Main Body Color : [ ] Sandstone [ ] Limestone [ ] Sierra [ ] Prairie

Base Price (does not include any banding, accents, or insets).....Price : \$

B : Accent Brick & Color Upgrades ◆

- Copthorne : [ ] 3 Color Blend [ ] Burgundy Red [ ] Burnt Clay [ ] Old Oak
Richcliff : [ ] 2 Color Blend [ ] Pebble Taupe [ ] Dawn Mist

Upgrade Price .....Add : \$

- Hollandstone : [ ] Autumn Red [ ] Rustic Red [ ] Prairie [ ] River [ ] Sierra [ ] Buff [ ] Red [ ] Charcoal
Umbriano : [ ] Autumn Sunset [ ] Midnight Sky [ ] Winter Marvel [ ] Summer Rose
Il Campo : [ ] Coffee Creek [ ] Heritage Brown [ ] Oak wood [ ] Summer Rose

- Series 3000 : [ ] Mineral Ice Grey [ ] Mocha Brown [ ] Onyx Black [ ] Chardonnay Tan
Unigranite : [ ] Slate [ ] Black [ ] Red
Holland Premier : [ ] Charleston [ ] Heritage Brown

Upgrade Price .....Add : \$

Requested Inset Pattern : \_\_\_\_\_
(Example: 45° Herringbone, Running Bond, & Stack Bond, etc.)

C : Coping ◆

- Fullnose : [ ] Limestone [ ] Prairie [ ] Sandstone

Upgrade Price .....Add : \$

- Ledgestone: [ ] Blue [ ] Buff [ ] Gray

Upgrade Price .....Add : \$

Contact Name: \_\_\_\_\_ Base Price : \$ \_\_\_\_\_

Phone/Email : \_\_\_\_\_ Accent & Upgrades : \$ \_\_\_\_\_

PO # : \_\_\_\_\_ Date : \_\_\_\_\_ Coping : \$ \_\_\_\_\_

Signature : \_\_\_\_\_ TOTAL : \$ \_\_\_\_\_

# Fireplace Water Feature Set



As shown: Main body color is Brussels Dimensional Sierra, Coping is Fullnose Limestone, & Accent is Richcliff Dawn Mist.

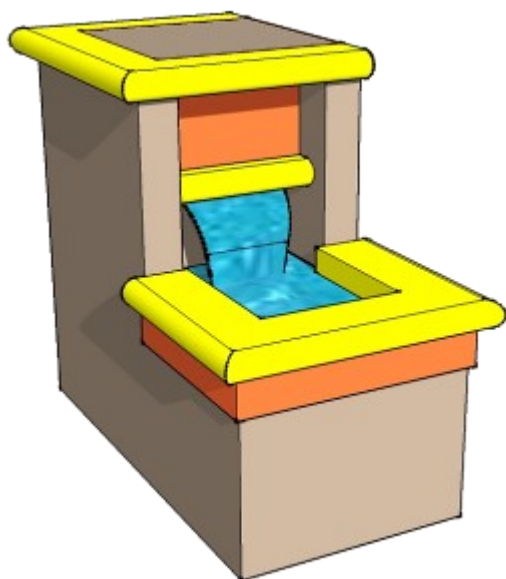

Color Legend :

- ◆ Main Body
- ◆ Coping & Inset Trim
- ◆ Insets & Banding

Unilock Custom Fireplace Water Feature Set Order Form

A : Style & Main Body Color (Brussels XL coping is standard) ◆

Main Body Color :  Sandstone  Limestone  Sierra  Prairie

Base Price (does not include any banding, accents, or insets).....Price : \$

B : Accent Brick & Color Upgrades ◆

Copthorne :  3 Color Blend  Burgundy Red  Burnt Clay  Old Oak
Richcliff :  2 Color Blend  Pebble Taupe  Dawn Mist

Upgrade Price .....Add : \$

Hollandstone :  Autumn Red  Rustic Red  Prairie  River
Sierra  Buff  Red  Charcoal
Umbriano :  Autumn Sunset  Midnight Sky  Winter Marvel  Summer Rose
Il Campo :  Coffee Creek  Heritage Brown  Oak wood  Summer Rose

Series 3000 :  Mineral Ice Grey  Mocha Brown  Onyx Black  Chardonnay Tan
Unigranite :  Slate  Black  Red
Holland Premier :  Charleston  Heritage Brown

Upgrade Price .....Add : \$

Requested Inset Pattern : \_\_\_\_\_
(Example: 45° Herringbone, Running Bond, & Stack Bond, etc.)

C : Coping ◆

Fullnose :  Limestone  Prairie  Sandstone

Upgrade Price .....Add : \$

Ledgestone:  Blue  Buff  Gray

Upgrade Price .....Add : \$

Contact Name: \_\_\_\_\_ Base Price : \$ \_\_\_\_\_

Phone/Email : \_\_\_\_\_ Accent & Upgrades : \$ \_\_\_\_\_

PO # : \_\_\_\_\_ Date : \_\_\_\_\_ Coping : \$ \_\_\_\_\_

Signature : \_\_\_\_\_ TOTAL : \$ \_\_\_\_\_

**Fire Table**

Straight



As shown: Main body color is Brussels Dimensional Sierra, Coping is Ledgestone Coping Gray, & Accent is Series 3000 Black.

Peaked



As shown: Main body color is Brussels Dimensional Sierra, Coping is Brussels XL Limestone, & Accent is Hollandstone Premier Charlston.

Arched



As shown: Main body color is Brussels Dimensional Sierra, Coping is Fullnose Limestone, & Accent is Richcliff Dawn Mist.

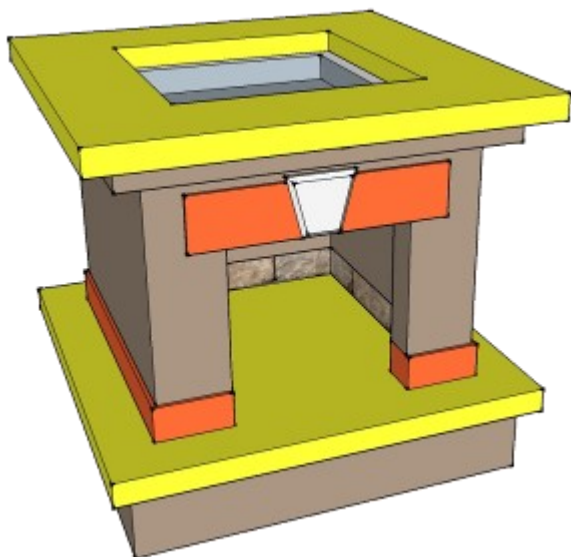

**Color Legend :**

- ◆ Main Body
- ◆ Coping & Inset Trim
- ◆ Insets & Banding



**Unilock Custom Fire Table Order Form**

**A : Style & Main Body Color** (Brussels XL coping is standard) ◆

- Style :     Arched                       Peaked                       Straight
- Main Body Color :             Sandstone                       Limestone                       Sierra                       Prairie

Base Price (does not include any banding, accents, or insets).....Price : \$

**B : Accent Brick & Color Upgrades** ◆

- Copthorne :     3 Color Blend                      Richcliff :             2 Color Blend
- Burgundy Red     Pebble Taupe
- Burnt Clay     Dawn Mist
- Old Oak

Upgrade Price .....Add : \$

- |  |  |  |
|--|--|--|
| <p>Hollandstone :</p> <p><input type="checkbox"/> Autumn Red                      <input type="checkbox"/> Sierra</p> <p><input type="checkbox"/> Rustic Red                              <input type="checkbox"/> Buff</p> <p><input type="checkbox"/> Prairie                                      <input type="checkbox"/> Red</p> <p><input type="checkbox"/> River    <input type="checkbox"/> Charcoal</p> | <p>Umbriano :</p> <p><input type="checkbox"/> Autumn Sunset</p> <p><input type="checkbox"/> Midnight Sky</p> <p><input type="checkbox"/> Winter Marvel</p> <p><input type="checkbox"/> Summer Rose</p> | <p>Il Campo :</p> <p><input type="checkbox"/> Coffee Creek</p> <p><input type="checkbox"/> Heritage Brown</p> <p><input type="checkbox"/> Oak wood</p> <p><input type="checkbox"/> Summer Rose</p> |
|--|--|--|

- |   |   |  |
|---|---|--|
| <p>Series 3000 :</p> <p><input type="checkbox"/> Mineral Ice Grey</p> <p><input type="checkbox"/> Mocha Brown</p> <p><input type="checkbox"/> Onyx Black</p> <p><input type="checkbox"/> Chardonnay Tan</p> | <p>Unigranite :</p> <p><input type="checkbox"/> Slate</p> <p><input type="checkbox"/> Black</p> <p><input type="checkbox"/> Red</p> | <p>Holland Premier :</p> <p><input type="checkbox"/> Charleston</p> <p><input type="checkbox"/> Heritage Brown</p> |
|---|---|--|

Upgrade Price .....Add : \$

**Requested Inset Pattern :** \_\_\_\_\_  
 (Example: 45° Herringbone, Running Bond, & Stack Bond, etc.)

**C : Coping** ◆

- Fullnose :     Limestone                       Prairie                       Sandstone

Upgrade Price .....Add : \$

- Ledgestone:     Blue                       Buff                       Gray

Upgrade Price .....Add : \$

Contact Name: _____	Base Price : \$ _____
Phone/Email : _____	Accent & Upgrades : \$ _____
PO # : _____      Date : _____	Coping : \$ _____
Signature : _____	<b>TOTAL : \$ _____</b>

**Fire Pit**



As shown: Main body color is Brussels Dimensional Sierra, Coping is Fullnose Limestone, & Accent is Holandstone Premier Charlston.

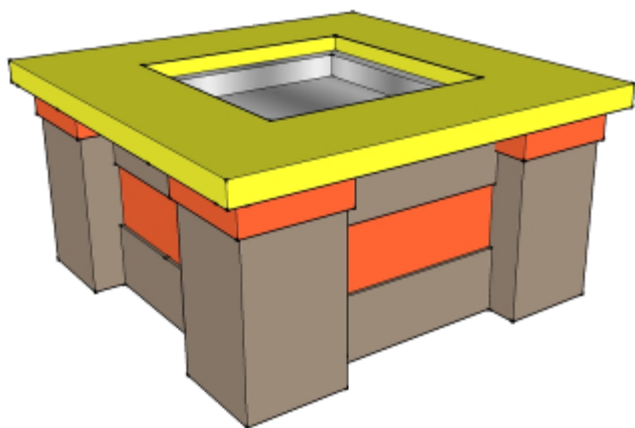

Color Legend :

- ◆ Main Body
- ◆ Coping & Inset Trim
- ◆ Insets & Banding

Unilock Custom Fire Pit Order Form

A : Style & Main Body Color (Brussels XL coping is standard) ◆

Main Body Color :  Sandstone  Limestone  Sierra  Prairie

Base Price (does not include any banding, accents, or insets).....Price : \$

B : Accent Brick & Color Upgrades ◆

Copthorne :  3 Color Blend  Burgundy Red  Burnt Clay  Old Oak
Richcliff :  2 Color Blend  Pebble Taupe  Dawn Mist

Upgrade Price .....Add : \$

Hollandstone :  Autumn Red  Rustic Red  Prairie  River
Sierra  Buff  Red  Charcoal
Umbriano :  Autumn Sunset  Midnight Sky  Winter Marvel  Summer Rose
Il Campo :  Coffee Creek  Heritage Brown  Oak wood  Summer Rose

Series 3000 :  Mineral Ice Grey  Mocha Brown  Onyx Black  Chardonnay Tan
Unigranite :  Slate  Black  Red
Holland Premier :  Charleston  Heritage Brown

Upgrade Price .....Add : \$

Requested Inset Pattern : \_\_\_\_\_
(Example: 45° Herringbone, Running Bond, & Stack Bond, etc.)

C : Coping ◆

Fullnose :  Limestone  Prairie  Sandstone

Upgrade Price .....Add : \$

Ledgestone:  Blue  Buff  Gray

Upgrade Price .....Add : \$

Contact Name: \_\_\_\_\_ Base Price : \$ \_\_\_\_\_

Phone/Email : \_\_\_\_\_ Accent & Upgrades : \$ \_\_\_\_\_

PO # : \_\_\_\_\_ Date : \_\_\_\_\_ Coping : \$ \_\_\_\_\_

Signature : \_\_\_\_\_ TOTAL : \$ \_\_\_\_\_

# Water Feature

Straight



As shown: Main body color is Brussels Dimensional Sierra, Coping is Ledgestone Coping Gray, & Accent is Series 3000 Black.

Peaked



As shown: Main body color is Brussels Dimensional Sierra, Coping is Brussels XL Limestone, & Accent is Hollandstone Premier Charlston.

Arched



As shown: Main body color is Brussels Dimensional Sierra, Coping is Fullnose Limestone, & Accent is Richcliff Dawn Mist.

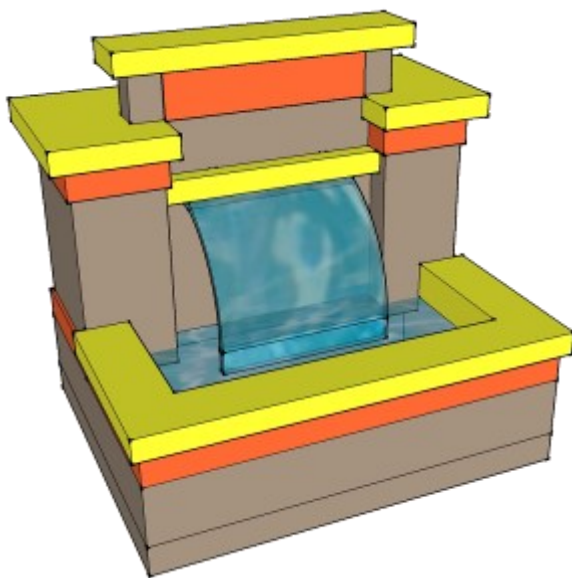

**Color Legend :**

- ◆ Main Body
- ◆ Coping & Inset Trim
- ◆ Insets & Banding

Unilock Custom Water Feature Order Form

A : Style & Main Body Color (Brussels XL coping is standard) ◆

- Style : [ ] Arched [ ] Peaked [ ] Straight
Main Body Color : [ ] Sandstone [ ] Limestone [ ] Sierra [ ] Prairie

Base Price (does not include any banding, accents, or insets).....Price : \$

B : Accent Brick & Color Upgrades ◆

- Copthorne : [ ] 3 Color Blend [ ] Burgundy Red [ ] Burnt Clay [ ] Old Oak
Richcliff : [ ] 2 Color Blend [ ] Pebble Taupe [ ] Dawn Mist

Upgrade Price .....Add : \$

- Hollandstone : [ ] Autumn Red [ ] Rustic Red [ ] Prairie [ ] River [ ] Sierra [ ] Buff [ ] Red [ ] Charcoal
Umbriano : [ ] Autumn Sunset [ ] Midnight Sky [ ] Winter Marvel [ ] Summer Rose
Il Campo : [ ] Coffee Creek [ ] Heritage Brown [ ] Oak wood [ ] Summer Rose

- Series 3000 : [ ] Mineral Ice Grey [ ] Mocha Brown [ ] Onyx Black [ ] Chardonnay Tan
Unigranite : [ ] Slate [ ] Black [ ] Red
Holland Premier : [ ] Charleston [ ] Heritage Brown

Upgrade Price .....Add : \$

Requested Inset Pattern : \_\_\_\_\_
(Example: 45° Herringbone, Running Bond, & Stack Bond, etc.)

C : Coping ◆

- Fullnose : [ ] Limestone [ ] Prairie [ ] Sandstone

Upgrade Price .....Add : \$

- Ledgestone: [ ] Blue [ ] Buff [ ] Gray

Upgrade Price .....Add : \$

Contact Name: \_\_\_\_\_ Base Price : \$ \_\_\_\_\_
Phone/Email : \_\_\_\_\_ Accent & Upgrades : \$ \_\_\_\_\_
PO # : \_\_\_\_\_ Date : \_\_\_\_\_ Coping : \$ \_\_\_\_\_
Signature : \_\_\_\_\_ TOTAL : \$ \_\_\_\_\_

# Standard Brick Oven

Straight



As shown: Main body color is Brussels Dimensional Sierra, Coping is Ledgestone Coping Gray, & Accent is Series 3000 Black.

Peaked



As shown: Main body color is Brussels Dimensional Sierra, Coping is Brussels XL Limestone, & Accent is Hollandstone Premier Charlston.

Arched



As shown: Main body color is Brussels Dimensional Sierra, Coping is Fullnose Limestone, & Accent is Richcliff Dawn Mist.

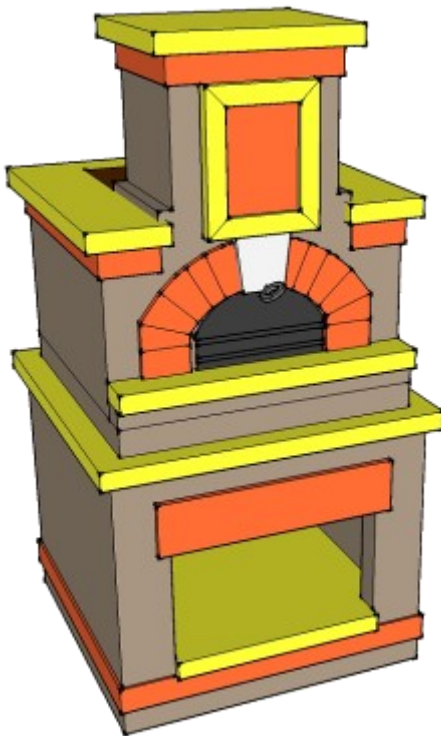

Color Legend :

- ◆ Main Body
- ◆ Coping & Inset Trim
- ◆ Insets & Banding

Unilock Custom Standard Brick Oven Order Form

A : Style & Main Body Color (Brussels XL coping is standard) ◆

- Style : [ ] Arched [ ] Peaked [ ] Straight
Main Body Color : [ ] Sandstone [ ] Limestone [ ] Sierra [ ] Prairie

Base Price (does not include any banding, accents, or insets).....Price : \$

B : Accent Brick & Color Upgrades ◆

- Copthorne : [ ] 3 Color Blend [ ] Burgundy Red [ ] Burnt Clay [ ] Old Oak
Richcliff : [ ] 2 Color Blend [ ] Pebble Taupe [ ] Dawn Mist

Upgrade Price .....Add : \$

- Hollandstone : [ ] Autumn Red [ ] Rustic Red [ ] Prairie [ ] River [ ] Sierra [ ] Buff [ ] Red [ ] Charcoal
Umbriano : [ ] Autumn Sunset [ ] Midnight Sky [ ] Winter Marvel [ ] Summer Rose
Il Campo : [ ] Coffee Creek [ ] Heritage Brown [ ] Oak wood [ ] Summer Rose

- Series 3000 : [ ] Mineral Ice Grey [ ] Mocha Brown [ ] Onyx Black [ ] Chardonnay Tan
Unigranite : [ ] Slate [ ] Black [ ] Red
Holland Premier : [ ] Charleston [ ] Heritage Brown

Upgrade Price .....Add : \$

Requested Inset Pattern : \_\_\_\_\_
(Example: 45° Herringbone, Running Bond, & Stack Bond, etc.)

C : Coping ◆

- Fullnose : [ ] Limestone [ ] Prairie [ ] Sandstone

Upgrade Price .....Add : \$

- Ledgestone: [ ] Blue [ ] Buff [ ] Gray

Upgrade Price .....Add : \$

Contact Name: \_\_\_\_\_ Base Price : \$ \_\_\_\_\_

Phone/Email : \_\_\_\_\_ Accent & Upgrades : \$ \_\_\_\_\_

PO # : \_\_\_\_\_ Date : \_\_\_\_\_ Coping : \$ \_\_\_\_\_

Signature : \_\_\_\_\_ TOTAL : \$ \_\_\_\_\_

**Gabled Brick Oven**

Straight



As shown: Main body color is Brussels Dimensional Sierra, Coping is Ledgestone Coping Gray, & Accent is Series 3000 Black.

Peaked



As shown: Main body color is Brussels Dimensional Sierra, Coping is Brussels XL Limestone, & Accent is Hollandstone Premier Charlston.



Arched

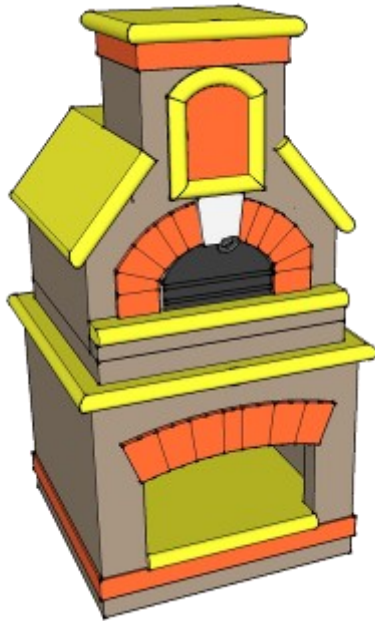

As shown: Main body color is Brussels Dimensional Sierra, Coping is Fullnose Limestone, & Accent is Richcliff Dawn Mist.



**Color Legend :**

-  Main Body
-  Coping & Inset Trim
-  Insets & Banding



Unilock Custom Gabled Brick Oven Order Form

A : Style & Main Body Color (Brussels XL coping is standard) ◆

- Style : [ ] Arched [ ] Peaked [ ] Straight
Main Body Color : [ ] Sandstone [ ] Limestone [ ] Sierra [ ] Prairie

Base Price (does not include any banding, accents, or insets).....Price : \$

B : Accent Brick & Color Upgrades ◆

- Copthorne : [ ] 3 Color Blend [ ] Burgundy Red [ ] Burnt Clay [ ] Old Oak
Richcliff : [ ] 2 Color Blend [ ] Pebble Taupe [ ] Dawn Mist

Upgrade Price .....Add : \$

- Hollandstone : [ ] Autumn Red [ ] Rustic Red [ ] Prairie [ ] River [ ] Sierra [ ] Buff [ ] Red [ ] Charcoal
Umbriano : [ ] Autumn Sunset [ ] Midnight Sky [ ] Winter Marvel [ ] Summer Rose
Il Campo : [ ] Coffee Creek [ ] Heritage Brown [ ] Oak wood [ ] Summer Rose

- Series 3000 : [ ] Mineral Ice Grey [ ] Mocha Brown [ ] Onyx Black [ ] Chardonnay Tan
Unigranite : [ ] Slate [ ] Black [ ] Red
Holland Premier : [ ] Charleston [ ] Heritage Brown

Upgrade Price .....Add : \$

Requested Inset Pattern : \_\_\_\_\_
(Example: 45° Herringbone, Running Bond, & Stack Bond, etc.)

C : Coping ◆

- Fullnose : [ ] Limestone [ ] Prairie [ ] Sandstone

Upgrade Price .....Add : \$

- Ledgestone: [ ] Blue [ ] Buff [ ] Gray

Upgrade Price .....Add : \$

Contact Name: \_\_\_\_\_ Base Price : \$ \_\_\_\_\_

Phone/Email : \_\_\_\_\_ Accent & Upgrades : \$ \_\_\_\_\_

PO # : \_\_\_\_\_ Date : \_\_\_\_\_ Coping : \$ \_\_\_\_\_

Signature : \_\_\_\_\_ TOTAL : \$ \_\_\_\_\_

# Grill Island

Straight



As shown: Main body color is Brussels Dimensional Sierra, Coping is LedgeStone Coping Gray, & Accent is Series 3000 Black.

Peaked



As shown: Main body color is Brussels Dimensional Sierra, Coping is Brussels XL Limestone, & Accent is Hollandstone Premier Charlston.

Arched



As shown: Main body color is Brussels Dimensional Sierra, Coping is Fullnose Limestone, & Accent is Richcliff Dawn Mist.

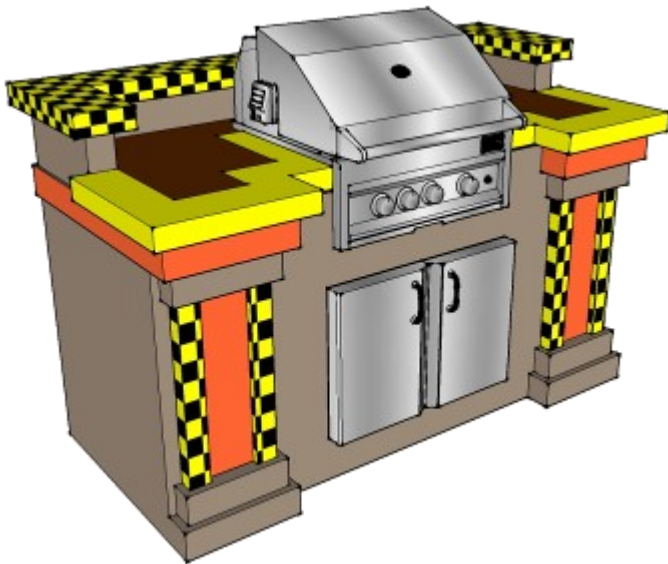

**Color Legend :**

- ◆ Main Body
- ◆ Coping & Inset Trim
- ◆ Insets & Banding
- ◆ Umbriano (select color)
- ◆ Will match chosen coping color but will be Brussels Material.

**Note :** If LedgeStone is chosen for coping, color combinations will be as follows:

- Blue or gray coping = Limestone
- Buff coping = Sandstone

**Unilock Custom Grill Island Order Form**

**A : Style & Main Body Color** (Brussels XL coping is standard) ◆

- Style :     Arched                       Peaked                       Straight
- Main Body Color :             Sandstone                       Limestone                       Sierra                       Prairie

Base Price (does not include any banding, accents, or insets).....Price : \$

**B : Accent Brick & Color Upgrades** ◆

- Copthorne :     3 Color Blend                      Richcliff :             2 Color Blend
- Burgundy Red     Pebble Taupe
- Burnt Clay     Dawn Mist
- Old Oak

Upgrade Price .....Add : \$

- |  |  |  |
|--|--|--|
| <p>Hollandstone :</p> <p><input type="checkbox"/> Autumn Red                      <input type="checkbox"/> Sierra</p> <p><input type="checkbox"/> Rustic Red                              <input type="checkbox"/> Buff</p> <p><input type="checkbox"/> Prairie                                      <input type="checkbox"/> Red</p> <p><input type="checkbox"/> River    <input type="checkbox"/> Charcoal</p> | <p>Umbriano :</p> <p><input type="checkbox"/> Autumn Sunset</p> <p><input type="checkbox"/> Midnight Sky</p> <p><input type="checkbox"/> Winter Marvel</p> <p><input type="checkbox"/> Summer Rose</p> | <p>Il Campo :</p> <p><input type="checkbox"/> Coffee Creek</p> <p><input type="checkbox"/> Heritage Brown</p> <p><input type="checkbox"/> Oak wood</p> <p><input type="checkbox"/> Summer Rose</p> |
|--|--|--|

- |   |   |  |
|---|---|--|
| <p>Series 3000 :</p> <p><input type="checkbox"/> Mineral Ice Grey</p> <p><input type="checkbox"/> Mocha Brown</p> <p><input type="checkbox"/> Onyx Black</p> <p><input type="checkbox"/> Chardonnay Tan</p> | <p>Unigranite :</p> <p><input type="checkbox"/> Slate</p> <p><input type="checkbox"/> Black</p> <p><input type="checkbox"/> Red</p> | <p>Holland Premier :</p> <p><input type="checkbox"/> Charleston</p> <p><input type="checkbox"/> Heritage Brown</p> |
|---|---|--|

Upgrade Price .....Add : \$

**Requested Inset Pattern :** \_\_\_\_\_  
 (Example: 45° Herringbone, Running Bond, & Stack Bond, etc.)

**C : Coping** ◆

- Fullnose :     Limestone                       Prairie                       Sandstone

Upgrade Price .....Add : \$

- Ledgestone:     Blue                       Buff                       Gray

Upgrade Price .....Add : \$

Contact Name: \_\_\_\_\_ Base Price : \$ \_\_\_\_\_

Phone/Email : \_\_\_\_\_ Accent & Upgrades : \$ \_\_\_\_\_

PO # : \_\_\_\_\_ Date : \_\_\_\_\_ Coping : \$ \_\_\_\_\_

Signature : \_\_\_\_\_ TOTAL : \$ \_\_\_\_\_

**Bar Island**

Straight

Peaked

Arched



As shown: Main body color is Brussels Dimensional Sierra, Coping is Ledgestone Coping Gray, & Accent is Series 3000 Black.

As shown: Main body color is Brussels Dimensional Sierra, Coping is Brussels XL Limestone, & Accent is Hollandstone Premier Charlston.

As shown: Main body color is Brussels Dimensional Sierra, Coping is Fullnose Limestone, & Accent is Richcliff Dawn Mist.

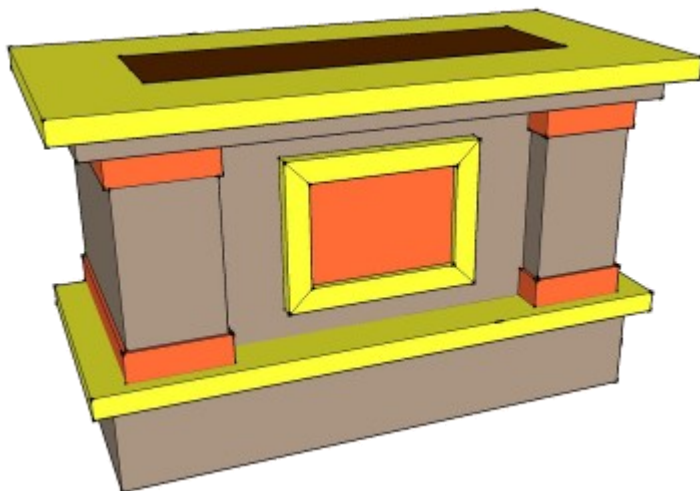

Color Legend :

- ◆ Main Body
- ◆ Coping & Inset Trim
- ◆ Insets & Banding
- ◆ Umbriano (select color)

Unilock Custom Bar Island Order Form

A : Style & Main Body Color (Brussels XL coping is standard) ◆

- Style : [ ] Arched [ ] Peaked [ ] Straight
Main Body Color : [ ] Sandstone [ ] Limestone [ ] Sierra [ ] Prairie

Base Price (does not include any banding, accents, or insets).....Price : \$

B : Accent Brick & Color Upgrades ◆

- Copthorne : [ ] 3 Color Blend [ ] Burgundy Red [ ] Burnt Clay [ ] Old Oak
Richcliff : [ ] 2 Color Blend [ ] Pebble Taupe [ ] Dawn Mist

Upgrade Price .....Add : \$

- Hollandstone : [ ] Autumn Red [ ] Rustic Red [ ] Prairie [ ] River [ ] Sierra [ ] Buff [ ] Red [ ] Charcoal
Umbriano : [ ] Autumn Sunset [ ] Midnight Sky [ ] Winter Marvel [ ] Summer Rose
Il Campo : [ ] Coffee Creek [ ] Heritage Brown [ ] Oak wood [ ] Summer Rose

- Series 3000 : [ ] Mineral Ice Grey [ ] Mocha Brown [ ] Onyx Black [ ] Chardonnay Tan
Unigranite : [ ] Slate [ ] Black [ ] Red
Holland Premier : [ ] Charleston [ ] Heritage Brown

Upgrade Price .....Add : \$

Requested Inset Pattern : \_\_\_\_\_
(Example: 45° Herringbone, Running Bond, & Stack Bond, etc.)

C : Coping ◆

- Fullnose : [ ] Limestone [ ] Prairie [ ] Sandstone

Upgrade Price .....Add : \$

- Ledgestone: [ ] Blue [ ] Buff [ ] Gray

Upgrade Price .....Add : \$

Contact Name: \_\_\_\_\_ Base Price : \$ \_\_\_\_\_

Phone/Email : \_\_\_\_\_ Accent & Upgrades : \$ \_\_\_\_\_

PO # : \_\_\_\_\_ Date : \_\_\_\_\_ Coping : \$ \_\_\_\_\_

Signature : \_\_\_\_\_ TOTAL : \$ \_\_\_\_\_

**Wet Bar**

Straight



As shown: Main body color is Brussels Dimensional Sierra, Coping is Ledgestone Coping Gray, & Accent is Series 3000 Black.

Peaked



As shown: Main body color is Brussels Dimensional Sierra, Coping is Brussels XL Limestone, & Accent is Hollandstone Premier Charlston.

Arched



As shown: Main body color is Brussels Dimensional Sierra, Coping is Fullnose Limestone, & Accent is Richcliff Dawn Mist.

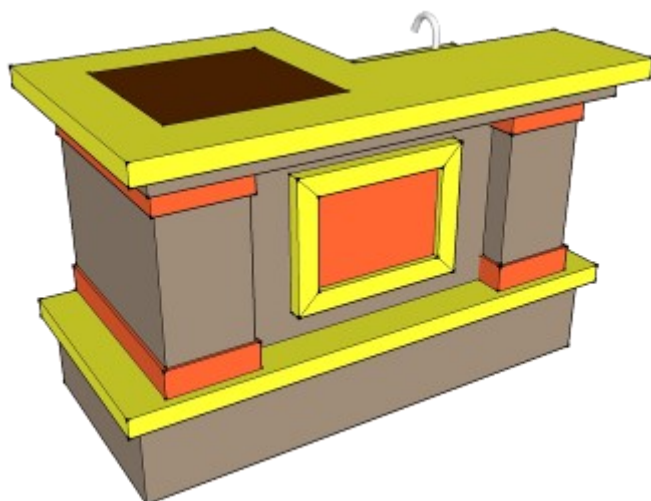

Color Legend :

- ◆ Main Body
- ◆ Coping & Inset Trim
- ◆ Insets & Banding
- ◆ Umbriano (select color)

**Unilock Custom Wet Bar Order Form**

**A : Style & Main Body Color** (Brussels XL coping is standard) ◆

- Style :     Arched                     Peaked                     Straight
- Main Body Color :             Sandstone                     Limestone                     Sierra                     Prairie

Base Price (does not include any banding, accents, or insets).....Price : \$

**B : Accent Brick & Color Upgrades** ◆

- Copthorne :     3 Color Blend                    Richcliff :             2 Color Blend
- Burgundy Red                     Pebble Taupe
- Burnt Clay                     Dawn Mist
- Old Oak

Upgrade Price .....Add : \$

- |  |  |  |
|--|--|--|
| <p>Hollandstone :</p> <p><input type="checkbox"/> Autumn Red                    <input type="checkbox"/> Sierra</p> <p><input type="checkbox"/> Rustic Red                    <input type="checkbox"/> Buff</p> <p><input type="checkbox"/> Prairie                    <input type="checkbox"/> Red</p> <p><input type="checkbox"/> River                    <input type="checkbox"/> Charcoal</p> | <p>Umbriano :</p> <p><input type="checkbox"/> Autumn Sunset</p> <p><input type="checkbox"/> Midnight Sky</p> <p><input type="checkbox"/> Winter Marvel</p> <p><input type="checkbox"/> Summer Rose</p> | <p>Il Campo :</p> <p><input type="checkbox"/> Coffee Creek</p> <p><input type="checkbox"/> Heritage Brown</p> <p><input type="checkbox"/> Oak wood</p> <p><input type="checkbox"/> Summer Rose</p> |
|--|--|--|

- |   |   |  |
|---|---|--|
| <p>Series 3000 :</p> <p><input type="checkbox"/> Mineral Ice Grey</p> <p><input type="checkbox"/> Mocha Brown</p> <p><input type="checkbox"/> Onyx Black</p> <p><input type="checkbox"/> Chardonnay Tan</p> | <p>Unigranite :</p> <p><input type="checkbox"/> Slate</p> <p><input type="checkbox"/> Black</p> <p><input type="checkbox"/> Red</p> | <p>Holland Premier :</p> <p><input type="checkbox"/> Charleston</p> <p><input type="checkbox"/> Heritage Brown</p> |
|---|---|--|

Upgrade Price .....Add : \$

**Requested Inset Pattern :** \_\_\_\_\_  
 (Example: 45° Herringbone, Running Bond, & Stack Bond, etc.)

**C : Coping** ◆

- Fullnose :     Limestone                     Prairie                     Sandstone

Upgrade Price .....Add : \$

- Ledgestone:     Blue                     Buff                     Gray

Upgrade Price .....Add : \$

Contact Name: _____	Base Price : \$ _____
Phone/Email : _____	Accent & Upgrades : \$ _____
PO # : _____      Date : _____	Coping : \$ _____
Signature : _____	<b>TOTAL : \$</b> _____

24" Pillar



As shown: Main body color is Brussels Dimensional Sandstone, Coping is Brussels Standard Sandstone, & Accent is Il Campo Heritage Brown.

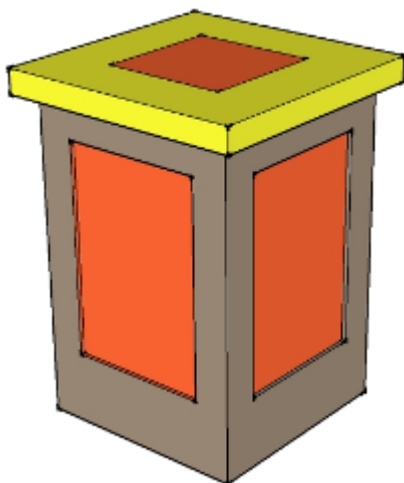

Color Legend :

- ◆ Main Body
- ◆ Coping & Inset Trim
- ◆ Insets & Banding



Unilock Custom Pillar Order Form

A : Style & Main Body Color (Brussels XL coping is standard) ◆

Main Body Color : [ ] Sandstone [ ] Limestone [ ] Sierra [ ] Prairie

Base Price (does not include any banding, accents, or insets).....Price : \$

B : Accent Brick & Color Upgrades ◆

Copthorne : [ ] 3 Color Blend [ ] Burgundy Red [ ] Burnt Clay [ ] Old Oak
Richcliff : [ ] 2 Color Blend [ ] Pebble Taupe [ ] Dawn Mist
Upgrade Price (1 inset).....Add : \$
Upgrade Price (2 insets).....Add : \$
Upgrade Price (3 insets).....Add : \$
Upgrade Price (4 insets).....Add : \$

Hollandstone : [ ] Autumn Red [ ] Rustic Red [ ] Prairie [ ] River [ ] Sierra [ ] Buff [ ] Red [ ] Charcoal
Umbriano : [ ] Autumn Sunset [ ] Midnight Sky [ ] Winter Marvel [ ] Summer Rose
Il Campo : [ ] Coffee Creek [ ] Heritage Brown [ ] Oak wood [ ] Summer Rose
Series 3000 : [ ] Mineral Ice Grey [ ] Mocha Brown [ ] Onyx Black [ ] Chardonnay Tan
Unigranite : [ ] Slate [ ] Black [ ] Red
Holland Premier : [ ] Charleston [ ] Heritage Brown

Upgrade Price (1 inset).....Add : \$
Upgrade Price (2 insets).....Add : \$
Upgrade Price (3 insets).....Add : \$
Upgrade Price (4 insets).....Add : \$

Requested Inset Pattern : \_\_\_\_\_
(Example: 45° Herringbone, Running Bond, & Stack Bond, etc.)

C : Coping ◆

Fullnose : [ ] Limestone [ ] Prairie [ ] Sandstone

Upgrade Price .....Add : \$

Ledgestone: [ ] Blue [ ] Buff [ ] Gray

Upgrade Price .....Add : \$

Contact Name: \_\_\_\_\_ Base Price : \$ \_\_\_\_\_

Phone/Email : \_\_\_\_\_ Accent & Upgrades : \$ \_\_\_\_\_

PO # : \_\_\_\_\_ Date : \_\_\_\_\_ Coping : \$ \_\_\_\_\_

Signature : \_\_\_\_\_ TOTAL : \$ \_\_\_\_\_

Wall Section - 8" D x 48" W x 24" H



As shown: Main body color is Brussels Dimensional Sandstone, Coping is Brussels XL Sandstone, & Accent is Il Campo Heritage Brown.

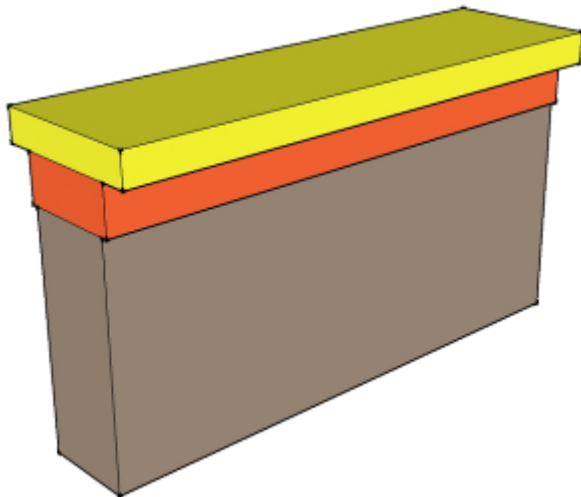

Color Legend :

◆ Main Body

◆ Coping & Inset Trim

◆ Insets & Banding

Unilock Custom Wall Section Order Form

A : Style & Main Body Color (Brussels XL coping is standard) ◆

Main Body Color : [ ] Sandstone [ ] Limestone [ ] Sierra [ ] Prairie

Base Price (does not include any banding, accents, or insets).....Price : \$

B : Accent Brick & Color Upgrades ◆

Copthorne : [ ] 3 Color Blend [ ] Burgundy Red [ ] Burnt Clay [ ] Old Oak
Richcliff : [ ] 2 Color Blend [ ] Pebble Taupe [ ] Dawn Mist

Upgrade Price Per 48" .....Add : \$

Hollandstone : [ ] Autumn Red [ ] Rustic Red [ ] Prairie [ ] River [ ] Sierra [ ] Buff [ ] Red [ ] Charcoal
Umbriano : [ ] Autumn Sunset [ ] Midnight Sky [ ] Winter Marvel [ ] Summer Rose
Il Campo : [ ] Coffee Creek [ ] Heritage Brown [ ] Oak wood [ ] Summer Rose

Series 3000 : [ ] Mineral Ice Grey [ ] Mocha Brown [ ] Onyx Black [ ] Chardonnay Tan
Unigranite : [ ] Slate [ ] Black [ ] Red
Holland Premier : [ ] Charleston [ ] Heritage Brown

Upgrade Price Per 48" .....Add : \$

Requested Inset Pattern : \_\_\_\_\_
(Example: 45° Herringbone, Running Bond, & Stack Bond, etc.)

C : Coping ◆

Fullnose : [ ] Limestone [ ] Prairie [ ] Sandstone

Upgrade Price Per 48" .....Add : \$

Ledgestone: [ ] Blue [ ] Buff [ ] Gray

Upgrade Price Per 48" .....Add : \$

Contact Name: \_\_\_\_\_ Base Price : \$ \_\_\_\_\_

Phone/Email : \_\_\_\_\_ Accent & Upgrades : \$ \_\_\_\_\_

PO # : \_\_\_\_\_ Date : \_\_\_\_\_ Coping : \$ \_\_\_\_\_

Signature : \_\_\_\_\_ TOTAL : \$ \_\_\_\_\_

# Kitchens & Islands



## Unilock Custom Kitchen Series

As outdoor living continues to grow in popularity, so does the complexity of outdoor kitchens. We are excited to announce that we now have a solution for creating elaborate and customizable outdoor kitchens. These kitchens are available in either pre-designed configurations or in modular cabinet form – similar to how an interior kitchen would be designed. Each pre-designed kitchen is shown with a list of stainless components. All the components are manufactured by OCS and are available through Harmony. In the following pages, you will first see our four kitchen series. Each series features five-six examples of outdoor kitchens in progressively larger sizes and features. The series are divided into the following groups:



**-100 Series (Straight)**

**-200 Series (45 Degree)**

**-300 Series (L Shapes)**

**-400 Series (U Shapes)**

All pre-designed kitchen examples are shown with Copthorne accents. Keep in mind, however, that accents (4" Banding and Insets) are available in the following choices: Copthorne, Holland Premier, Hollandstone, Il Campo, Series 3000, Umbriano, or Unigranite. Also, all units are available with XL, Fullnose, or Ledgestone coping and foot rail. Please note that kitchens are priced as shown with the options in each example.

**NOTE: BASE PRICE DOES NOT INCLUDE ANY BANDING, INSETS, OR COPING UPGRADES. BRUSSELS XL IS STANDARD FOR COPING. PLUMBING AND ELECTRICAL ARE NOT INCLUDED AND MUST BE DONE ON SITE.**

Note: All these kitchens and modular components will be available on Google Sketch Up Warehouse (keywords Harmony Outdoor Living or Unilock), if you'd like to download them and incorporate them (to scale) within your designs.

# Kitchens & Islands



## Modular Kitchen Components

After the **Pre-Designed Kitchen Series** section you will find the individual **Modular Kitchen Components** themselves. Feel free to let your creativity run wild and mix and match the different components. Keep in mind, you must always have an End Cap, Brick Oven, or Fireplace, on each end of the kitchen. In between you can create endless configurations using corners, 45s, and filler cabinets. Be sure to also check out some of the specialty cabinets, such as wine racks, refrigerator cabinets, and niches. Also, each component will show what the maximum cutout is for a grill or top unit, and the maximum dimension for any doors or drawers. Each component is color-coded to show the upgrade options available for banding, insets, coping, and foot rail.

When creating an outdoor kitchen, it is critical that you contact us directly to ensure that all the stainless components and configurations are possible. We will convert your concepts to a 3D full color rendering to ensure that you are getting exactly what you want.

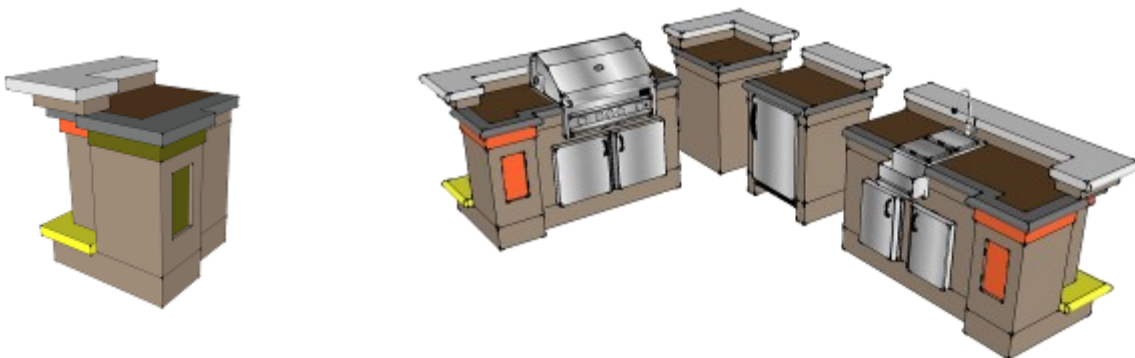

**NOTE: BASE PRICE DOES NOT INCLUDE ANY BANDING, INSETS, OR COPING UPGRADES. BRUSSELS XL IS STANDARD FOR COPING. ALL CUTOUTS ARE LISTED AS ADDITIONAL FEES. PLUMBING AND ELECTRICAL ARE NOT INCLUDED AND MUST BE DONE ON SITE.**

Note: All these kitchens and modular components will be available on Google Sketch Up Warehouse (keywords Harmony Outdoor Living or Unilock), if you'd like to download them and incorporate them (to scale) within your designs.

**115 Kitchen**



\* Low voltage lighting not included.

Approximate weight : Call for details.

Rough dimensions : 40" D x 168" W x 49.5" H

Modules

Left End Cabinet (72")	KUECL72
Cabinet (24")	KUFC24
Right End Cabinet (72")	KUECR72

OCS Stainless Grills & Accessories

5 Burner With Infra Red	S52B4SRB
Double Slide In Burner	SBS2SP
16" Cocktail Station	D14CS
Ice Chest	MDIG27SS
42" Double Door	D4221DS
Single Deluxe Door	D1521DS
Double Drawer	DR21S
Triple Drawer	DR31S
Oklite	
TikiCap (2)	

Upgrade Costs

- Bar Ledge : Fullnose
- Foot Rail : Fullnose
- Counter Coping : Fullnose
- 4" Banding : Cophorne

Additional Cutout Fees

- Grills
- Beverage Center / Side Burner / Ice Chests
- Doors / Drawers
- Outlet Cutout (outlet not included)

**120 Kitchen**

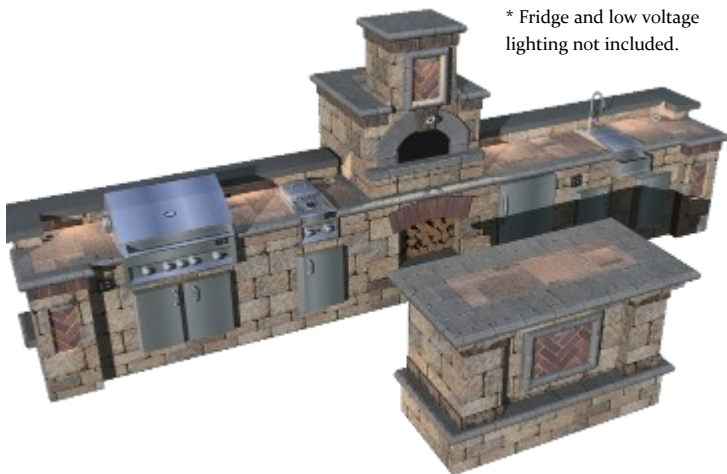

\* Fridge and low voltage lighting not included.

Approximate weight : Call for details.

Rough dimensions : 144" D x 264" W x 49.5" H

Modules

Left End Cabinet (72")	KUECL72
Cabinet (36")	KUFC36
Brick Oven	TUBRO
Fridge Cabinet (32")	KURC32
Right End Cabinet (72")	KUECR72
Bar Island	TUBAR

OCS Stainless Grills & Accessories

4 Burner With Infra Red	S42B4SRB
Double Slide In Burner	SBS2SP
16" Cocktail Station	D14CS
30" Double Door	D3021DS
42" Double Door	D4221DS
Single Deluxe Door (3)	D1521DS
Oklite	
TikiCap (2)	

Upgrade Costs

- Bar Ledge : Fullnose
- Foot Rail : Fullnose
- Counter Coping : Fullnose
- 4" Banding : Cophorne

Additional Cutout Fees

- Grills
- Beverage Center / Side Burner / Ice Chest
- Doors / Drawers
- Outlet Cutout (outlet not included)

# 100 Series

## 105 Kitchen



Approximate weight : Call for details.

Rough dimensions : 40" D x 108" W x 49.5" H

### Modules

Left End Cabinet (72")	KUECL72
Right End Cabinet (36")	KUECR36

### OCS Stainless Grills & Accessories

4 Burner With Infra Red	S42B4SRB
Double Slide In Burner	SBS2SP
Triple Drawer	DR31S
42" Double Door	D4221DS
Oklite	
TikiCap	

### Upgrade Costs

Bar Ledge : Fullnose  
 Foot Rail : Fullnose  
 Counter Coping : Fullnose  
 4" Banding : Copthorne

### Additional Cutout Fees

Grill  
 Beverage Center / Side Burner / Ice Chest  
 Doors / Drawers  
 Outlet Cutout (outlet not included)

## 110 Kitchen



\* Fridge not included.

Approximate weight : Call for details.

Rough dimensions : 40" D x 176" W x 49.5" H

### Modules

Left End Cabinet (72")	KUECL72
Fridge Cabinet (32")	KURC32
Right End Cabinet (72")	KUECR36

### OCS Stainless Grills & Accessories

5 Burner With Infra Red	S52B4SRB
16" Cocktail Station	D14CS
Ice Chest	MDIG27SS
42" Double Door	D4221DS
Single Deluxe Door	D1521DS
Double Drawer	DR21S
Oklite	
TikiCap	

### Upgrade Costs

Bar Ledge : Fullnose  
 Foot Rail : Fullnose  
 Counter Coping : Fullnose  
 4" Banding : Copthorne

### Additional Cutout Fees

Grills  
 Beverage Center / Side Burner / Ice Chest  
 Doors / Drawers  
 Outlet Cutout (outlet not included)

**125 Kitchen**



\* Fridge not included.

Approximate weight : Call for details.

Rough dimensions : 40" D x 164" W x 49.5" H

Modules

Gas Fireplace	TUFRPGB
Fridge Cabinet (32")	KURC32
Right End Cabinet (72")	KUECR72

OCS Stainless Grills & Accessories

5 Burner With Infra Red	S52B4SRB
42" Double Door	D4221DS
Oklite	
TikiCap	

Upgrade Costs

- Bar Ledge : Fullnose
- Foot Rail : Fullnose
- Counter Coping : Fullnose
- 4" Banding : Copthorne

Additional Cutout Fees

- Grills
- Doors / Drawers
- Outlet Cutout (outlet not included)

**130 Kitchen**

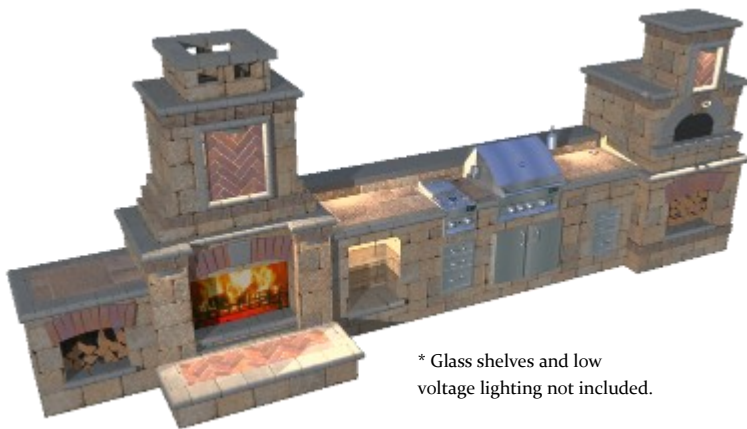

\* Glass shelves and low voltage lighting not included.

Approximate weight : Call for details.

Rough dimensions : 64" D x 276" W x 49.5" H

Modules

Wood Box	TUWDBX
Fireplace (36" - wood)	TUFRPW
Hearth	TUHTSC
Niche/Display Cabinet (36")	KUNC36
Cabinet (72")	KUFC72
Cabinet (24")	KUFC24
Brick Oven	TUBRO

OCS Stainless Grills & Accessories

3 Burner With Infra Red	S32B4SRB
Double Slide In Burner	SBS2SP
Triple Drawer (2)	DR31S
30" Double Door	D3021DS
Oklite	
TikiCap	

Upgrade Costs

- Bar Ledge : Fullnose
- Foot Rail : Fullnose
- Counter Coping : Fullnose
- 4" Banding : Copthorne

Additional Cutout Fees

- Grills
- Beverage Center / Side Burner / Ice Chest
- Doors / Drawers
- Outlet Cutout (outlet not included)
- Display Shelving Tabs (specify shelf location)



# 200 Series

## 205 Kitchen

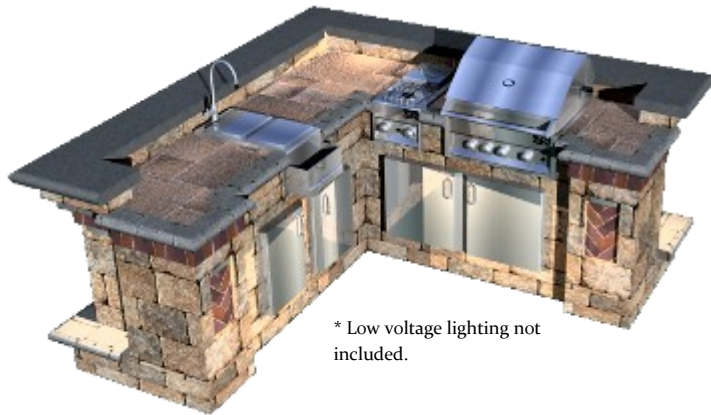

\* Low voltage lighting not included.

Approximate weight : Call for details.

Rough dimensions : 108" D x 108" W x 49.5" H

### Modules

Left End Cabinet (72")	KUECL72
Corner Cabinet (90°)	KUCC90
Right End Cabinet (72")	KUECR72

### OCS Stainless Grills & Accessories

3 Burner With Infra Red	S32B4SRB
Double Slide In Burner	SBS2SP
16" Cocktail Station	D14CS
42" Double Door	D4221DS
Single Deluxe Door (2)	D1521DS
Oklite	
TikiCap	

### Upgrade Costs

Bar Ledge : Fullnose
Foot Rail : Fullnose
Counter Coping : Fullnose
4" Banding : Copthorne

### Additional Cutout Fees

Grills
Beverage Center / Side Burner / Ice Chest
Doors / Drawers
Outlet Cutout (outlet not included)

## 210 Kitchen

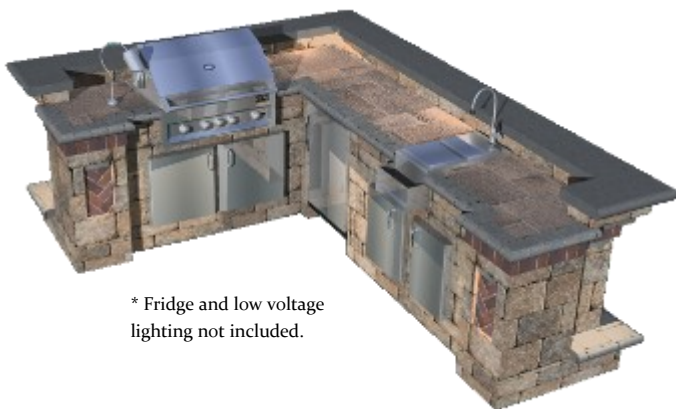

\* Fridge and low voltage lighting not included.

Approximate weight : Call for details.

Rough dimensions : 136" D x 104" W x 49.5" H

### Modules

Left End Cabinet (72")	KUECL72
Corner Cabinet (90°)	KUCC90
Fridge Cabinet (32")	KURC32
Right End Cabinet (72")	KUECR72

### OCS Stainless Grills & Accessories

4 Burner With Infra Red	S42B4SRB
16" Cocktail Station	D14CS
42" Double Door	D4221DS
Single Deluxe Door (2)	D1521DS
Oklite	
TikiCap	

### Upgrade Costs

Bar Ledge : Fullnose
Foot Rail : Fullnose
Counter Coping : Fullnose
4" Banding : Copthorne

### Additional Cutout Fees

Grills
Beverage Center / Side Burner / Ice Chest
Doors / Drawers
Outlet Cutout (outlet not included)

**215 Kitchen**

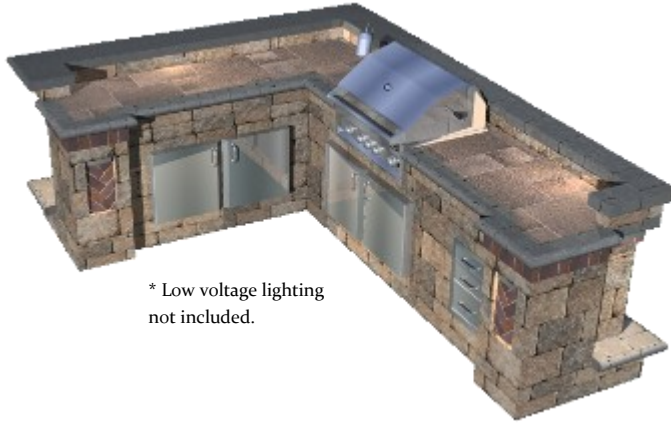

\* Low voltage lighting not included.

Approximate weight : Call for details.  
 Rough dimensions : 104" D x 136" W x 49.5" H

Modules

Left End Cabinet (72")	KUECL72
Corner Cabinet (90°)	KUCC90
Cabinet (72")	KUFC72
Right End Cabinet (36")	KUECR36

OCS Stainless Grills & Accessories

4 Burner With Infra Red	S42B4SRB
Triple Drawer	DR31S
42" Double Door (2)	D4221DS
Oklite	
TikiCap	

Upgrade Costs

Bar Ledge : Fullnose  
 Foot Rail : Fullnose  
 Counter Coping : Fullnose  
 4" Banding : Copthorne

Additional Cutout Fees

Grills  
 Doors / Drawers  
 Outlet Cutout (outlet not included)

**220 Kitchen**

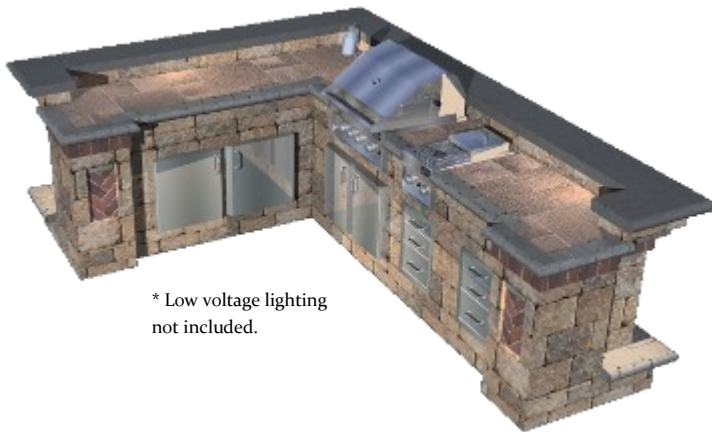

\* Low voltage lighting not included.

Approximate weight : Call for details.  
 Rough dimensions : 104" D x 136" W x 49.5" H

Modules

Left End Cabinet (72")	KUECL72
Corner Cabinet (90°)	KUCC90
Cabinet (72")	KUFC72
Right End Cabinet (36")	KUECR36

OCS Stainless Grills & Accessories

3 Burner With Infra Red	S32B4SRB
Double Slide In Burner	SBS2SP
Triple Drawer (2)	DR31S
30" Double Door	D3021DS
42" Double Door	D4221DS
Oklite	
TikiCap	

Upgrade Costs

Bar Ledge : Fullnose  
 Foot Rail : Fullnose  
 Counter Coping : Fullnose  
 4" Banding : Copthorne

Additional Cutout Fees

Grills  
 Beverage Center / Side Burner / Ice Chest  
 Doors / Drawers  
 Outlet Cutout (outlet not included)

**225 Kitchen**

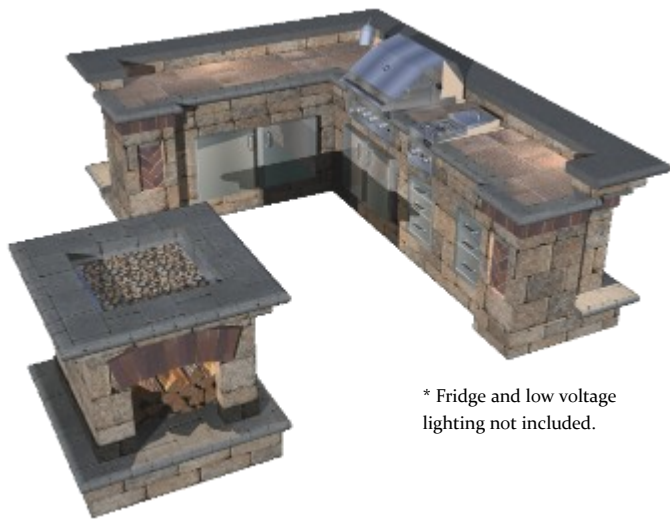

\* Fridge and low voltage lighting not included.

Approximate weight : Call for details.

Rough dimensions : 148" D x 1148" W x 49.5" H

Modules

Left End Cabinet (72")	KUECL72
Corner Cabinet (90°)	KUCC90
Cabinet (72")	KUFC72
Right End Cabinet (36")	KUECR36
Firetable	TURFT

OCS Stainless Grills & Accessories

3 Burner With Infra Red	S32B4SRB
Double Slide In Burner	SBS2SP
Triple Drawer (2)	DR31S
30" Double Door	D3021DS
42" Double Door	D4221DS
Oklite	
TikiCap	

Upgrade Costs

- Bar Ledge : Fullnose
- Foot Rail : Fullnose
- Counter Coping : Fullnose
- 4" Banding : Copthorne

Additional Cutout Fees

- Grills
- Beverage Center / Side Burner / Ice Chest
- Doors / Drawers
- Outlet Cutout (outlet not included)

# 300 Series

## 305 Kitchen



\* Low voltage lighting not included.

Approximate weight : Call for details.

Rough dimensions : 94" D x 166" W x 49.5" H

### Modules

Left End Cabinet (72")	KUECL72
Corner Cabinet (45")	KUCC45
Right End Cabinet (72")	KUECR72

### OCS Stainless Grills & Accessories

3 Burner With Infra Red	S32B4SRB
Double Slide In Burner	SBS2SP
16" Cocktail Station	D14CS
Ice Chest	MDIG27SS
42" Double Door	D4221DS
Single Deluxe Door	D1521DS
Double Drawer	DR21S
Oklite	
TikiCap	

### Upgrade Costs

Bar Ledge : Fullnose
Foot Rail : Fullnose
Counter Coping : Fullnose
4" Banding : Copthorne

### Additional Cutout Fees

Grills
Beverage Center / Side Burner / Ice Chest
Doors / Drawers
Outlet Cutout (outlet not included)

## 310 Kitchen

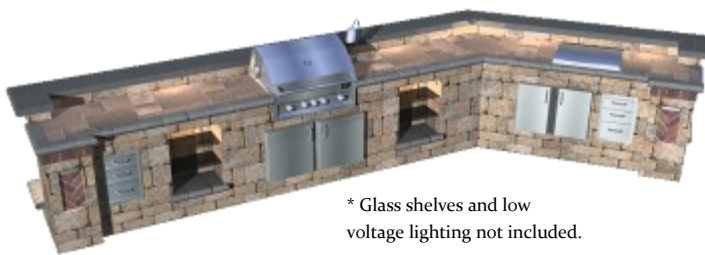

\* Glass shelves and low voltage lighting not included.

Approximate weight : Call for details.

Rough dimensions : 94" D x 262" W x 49.5" H

### OCS Stainless Grills & Accessories

4 Burner With Infra Red	S42B4SRB
Ice Chest	MDIG27SS
Triple Drawer (2)	DR31S
30" Double Door	D3021DS
42" Double Door	D4221DS
Oklite	
TikiCap	

### Upgrade Costs

Bar Ledge : Fullnose
Foot Rail : Fullnose
Counter Coping : Fullnose
4" Banding : Copthorne

### Additional Cutout Fees

Grills
Beverage Center / Side Burner / Ice Chest
Doors / Drawers
Outlet Cutout (outlet not included)
Display Shelving Tabs (specify shelf location)

### Modules

Left End Cabinet (36")	KUECL36
Niche/Display Cabinet (36")	KUNC36
Cabinet (60")	KUFC60
Niche/Display Cabinet (36")	KUNC36
Corner Cabinet (45")	KUCC45
Right End Cabinet (72")	KUECR72

**315 Kitchen**

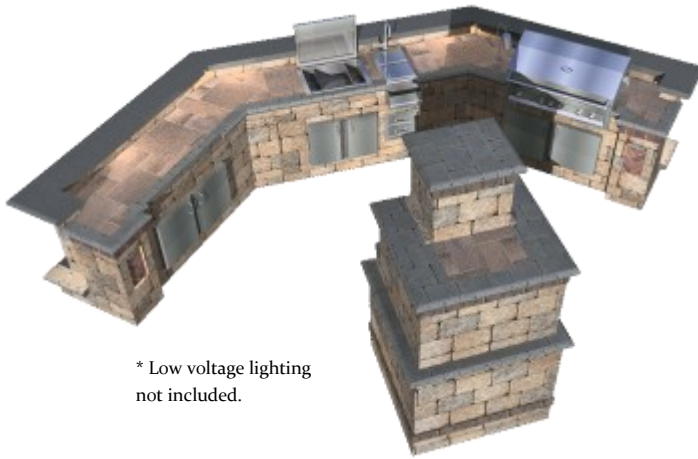

\* Low voltage lighting not included.

Approximate weight : Call for details.

Rough dimensions : 184" D x 184" W x 49.5" H

Modules

Left End Cabinet (72")	KUECL72
Corner Cabinet (45°)	KUCC45
Cabinet (72")	KUFC72
Corner Cabinet (45°)	KUCC45
Right End Cabinet (72")	KUECR72
Brick Oven	TUBRO

OCS Stainless Grills & Accessories

5 Burner With Infra Red	S52B4SRB
Ice Chest	MDIG27SS
16" Cocktail Station	D14CS
Double Drawer	DR21S
30" Double Door	D3021DS
42" Double Door (2)	D4221DS
Oklite	
TikiCap	

Upgrade Costs

Bar Ledge : Fullnose  
 Foot Rail : Fullnose  
 Counter Coping : Fullnose  
 4" Banding : Copthorne

Additional Cutout Fees

Grills  
 Beverage Center / Side Burner / Ice Chest  
 Doors / Drawers  
 Outlet Cutout (outlet not included)

**320 Kitchen**

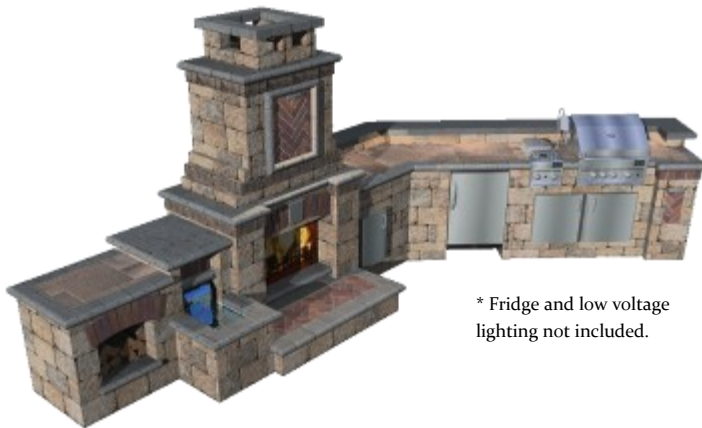

\* Fridge and low voltage lighting not included.

Approximate weight : Call for details.

Rough dimensions : 114" D x 260" W x 49.5" H

Modules

Wood Box	TUWDBXU
Fireplace Water Feature	TUWFPR
Fireplace (36" - wood)	TUFRPW
Straight Hearth	TUHTSC
Cabinet (24")	KUFC24
Corner Cabinet (45°)	KUCC45
Fridge Cabinet (32")	KURC32
Right End Cabinet (72")	KUECR72

OCS Stainless Grills & Accessories

3 Burner With Infra Red	S32B4SRB
Double Slide In Burner	SBS2SP
Single Deluxe Door	D1521DS
42" Double Door	D4221DS
Oklite	
TikiCap	

Upgrade Costs

Bar Ledge : Fullnose  
 Foot Rail : Fullnose  
 Counter Coping : Fullnose  
 4" Banding : Copthorne

Additional Cutout Fees

Grills  
 Beverage Center / Side Burner / Ice Chest  
 Doors / Drawers  
 Outlet Cutout (outlet not included)

**325 Kitchen**

\* Fridge and low voltage lighting not included.

Approximate weight : Call for details.

Rough dimensions : 192" D x 180" W x 49.5" H

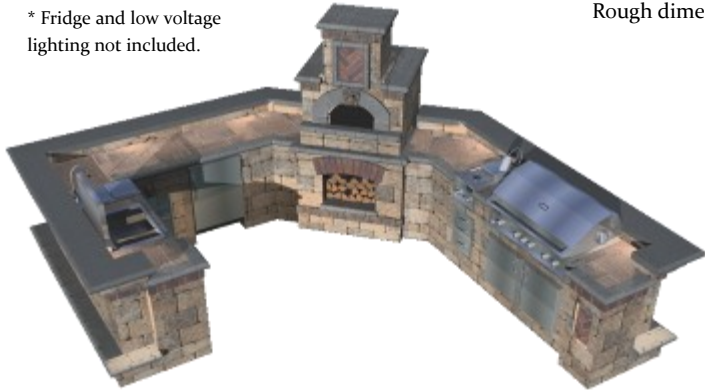

OCS Stainless Grills & Accessories

5 Burner With Infra Red	S52B4SRB
Double Slide In Burner	SBS2SP
16" Cocktail Station	D14CS
Ice Chest	MDIG27SS
Triple Drawer (2)	DR31S
Single Deluxe Door	D1521DS
42" Double Door	D4221DS
Oklite	
TikiCap	

Upgrade Costs

Bar Ledge : Fullnose
Foot Rail : Fullnose
Counter Coping : Fullnose
4" Banding : Copthorne

Additional Cutout Fees

Grills
Beverage Center / Side Burner / Ice Chest
Doors / Drawers
Outlet Cutout (outlet not included)

Modules

Left End Cabinet (72")	KUECL72
Corner Cabinet (90°)	KUCC90
Cabinet (24")	KUFC24
Fridge Cabinet (32")	KURC32
Corner Cabinet (45°)	KUCC45
Brick Oven	TUBRO
Corner Cabinet (45°)	KUCC45
Cabinet (24")	KUFC24
Right End Cabinet (72")	KUECR72

# 400 Series

## 405 Kitchen

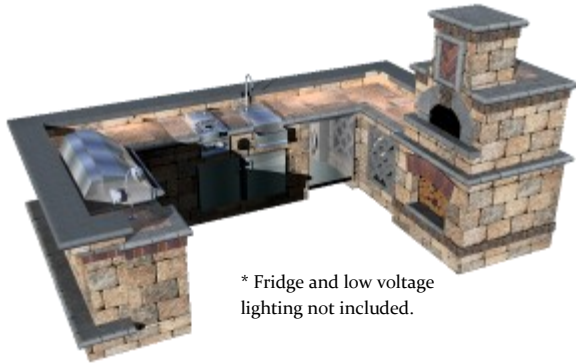

\* Fridge and low voltage lighting not included.

### Modules

Left End Cabinet (72")	KUECL72
Corner Cabinet (90°)	KUCC90
Cabinet (24")	KUFC24
Cabinet (60")	KUFC60
Fridge Cabinet (32")	KURC32
Corner Cabinet (90°)	KUCC90
Wine Cabinet (36")	KUWC36
Brick Oven	TUBRO

Approximate weight : Call for details.

Rough dimensions : 104" D x 192" W x 49.5" H

### OCS Stainless Grills & Accessories

5 Burner With Infra Red	S52B4SRB
Double Slide In Burner	SBS2SP
16" Cocktail Station	D14CS
42" Double Door (2)	D4221DS
Oklite	
TikiCap	

### Upgrade Costs

Bar Ledge : Fullnose  
 Foot Rail : Fullnose  
 Counter Coping : Fullnose  
 4" Banding : Copthorne

### Additional Cutout Fees

Grills  
 Beverage Center / Side Burner / Ice Chest  
 Doors / Drawers  
 Outlet Cutout (outlet not included)

## 410 Kitchen

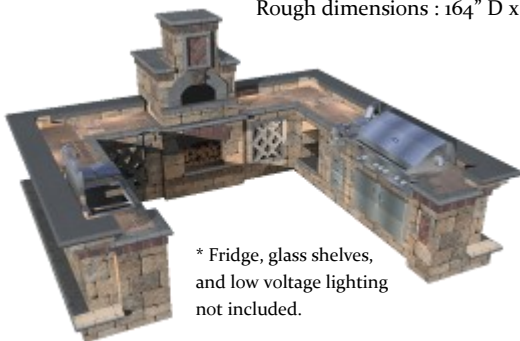

\* Fridge, glass shelves, and low voltage lighting not included.

### Modules

Left End Cabinet (72")	KUECL72
Fridge Cabinet (32")	KURC32
Corner Cabinet (90°)	KUCC90
Wine Cabinet (36")	KUWC36
Brick Oven	TUBRO
Wine Cabinet (36")	KUWC36
Corner Cabinet (90°)	KUCC90
Niche/Display Cabinet (36")	KUNC36
Cabinet (24")	KUFC24
Right End Cabinet (72")	KUECR72

Approximate weight : Call for details.

Rough dimensions : 164" D x 184" W x 49.5" H

### OCS Stainless Grills & Accessories

5 Burner With Infra Red	S52B4SRB
Double Slide In Burner	SBS2SP
16" Cocktail Station	D14CS
Ice Chest	MDIG27SS
Double Drawer	DR21S
Triple Drawer	DR31S
Single Deluxe Door	D1521DS
42" Double Door	D4221DS
Oklite	
TikiCap	

### Upgrade Costs

Bar Ledge : Fullnose  
 Foot Rail : Fullnose  
 Counter Coping : Fullnose  
 4" Banding : Copthorne

### Additional Cutout Fees

Grills  
 Beverage Center / Side Burner / Ice Chest  
 Doors / Drawers  
 Outlet Cutout (outlet not included)  
 Display Shelving Tabs (specify shelf location)

**415 Kitchen**

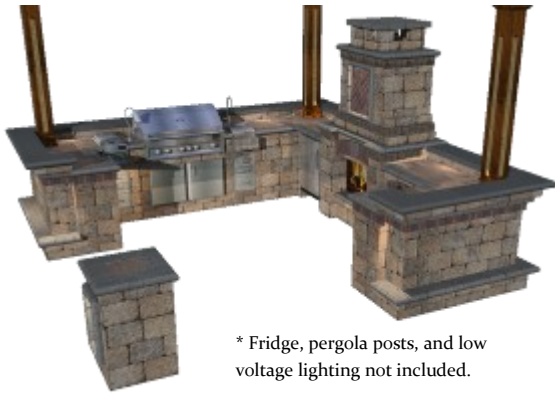

\* Fridge, pergola posts, and low voltage lighting not included.

Approximate weight : Call for details.

Rough dimensions : 192" D x 184" W x 49.5" H

OCS Stainless Grills & Accessories

5 Burner With Infra Red	S52B4SRB
Double Slide In Burner	SBS2SP
16" Cocktail Station	D14CS
Triple Drawer (3)	DR31S
42" Double Door	D4221DS
Oklite	
TikiCap	

Modules

Left End Cabinet (36")	KUECL36
Corner Cabinet (90°)	KUCC90
Cabinet (24")	KUFC24
Cabinet (72")	KUFC72
Cabinet (24")	KUFC24
Corner Cabinet (90°)	KUCC90
Fridge Cabinet (32")	KURC32
Fireplace (36" - wood)	TUFRPW
Wood Box Cabinet (36")	KUWB36
Corner Cabinet (90°)	KUCC90
Right End Cabinet (36")	KUECR36
Pillar w/ 3 Insets (24")	TUPL324

Upgrade Costs

Bar Ledge : Fullnose
Foot Rail : Fullnose
Counter Coping : Fullnose
4" Banding : Copthorne

Additional Cutout Fees

Grills
Beverage Center / Side Burner / Ice Chest
Doors / Drawers
Outlet Cutout (outlet not included)

**420 Kitchen**

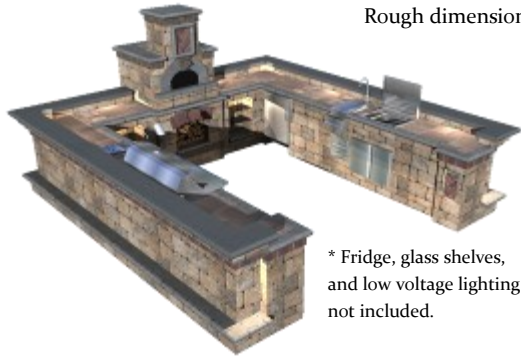

\* Fridge, glass shelves, and low voltage lighting not included.

Approximate weight : Call for details.

Rough dimensions : 184" D x 196" W x 49.5" H

OCS Stainless Grills & Accessories

5 Burner With Infra Red	S52B4SRB
Double Slide In Burner	SBS2SP
16" Cocktail Station	D14CS
Ice Chest	MDIG27SS
Double Drawer	DR21S
Triple Drawer	DR31S
30" Double Door	D3021DS
42" Double Door	D4221DS
Oklite	
TikiCap	

Upgrade Costs

Bar Ledge : Fullnose
Foot Rail : Fullnose
Counter Coping : Fullnose
4" Banding : Copthorne

Additional Cutout Fees

Grills
Beverage Center / Side Burner / Ice Chest
Doors / Drawers
Outlet Cutout (outlet not included)
Display Shelving Tabs (specify shelf location)

Modules

Left End Cabinet (36")	KUECL36
Cabinet (72")	KUFC72
Cabinet (24")	KUFC24
Cabinet (32")	KUFC32
Corner Cabinet (90°)	KUCC90
Niche/Display Cabinet (36")	KUNC36
Corner Cabinet (90°)	KUCC90
Brick Oven	TUBRO
Niche/Display Cabinet (36")	KUNC36
Fridge Cabinet (32")	KURC32
Cabinet (24")	KUFC24
Cabinet (72")	KUFC72
Right End Cabinet (36")	KUECR36



**425 Kitchen**

\* Fridge, glass shelves, and low voltage lighting not included.

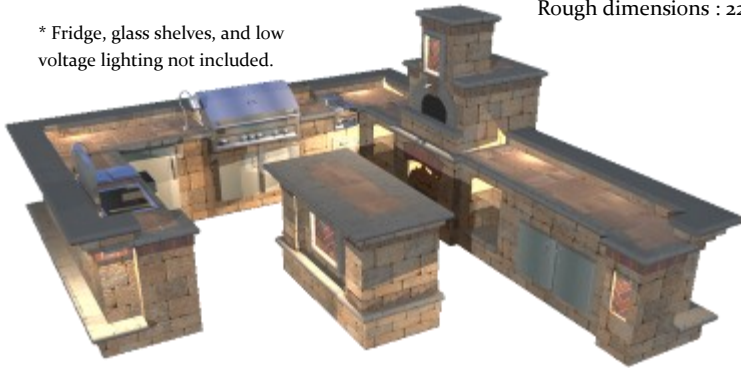

Approximate weight : Call for details.

Rough dimensions : 224" D x 192" W x 49.5" H

OCS Stainless Grills & Accessories

5 Burner With Infra Red	S52B4SRB
Double Slide In Burner	SBS2SP
16" Cocktail Station	D14CS
Ice Chest	MDIG27SS
Double Drawer	DR21S
Triple Drawer	DR31S
Single Deluxe Door	D1521DS
30" Double Door (2)	D3021DS
42" Double Door	D4221DS
Oklite	
TikiCap	

Modules

Left End Cabinet (72")	KUECL72
Cabinet (24")	KUFC24
Corner Cabinet (90°)	KUCC90
Fridge Cabinet (32")	KURC32
Cabinet (72")	KUFC72
Cabinet (24")	KUFC24
Corner Cabinet (90°)	KUCC90
Niche/Display Cabinet (36")	KUNC36
Brick Oven	TUBRO
Niche/Display Cabinet (36")	KUNC36
Right End Cabinet (72")	KUECR72
Bar Island	TUBAR

Upgrade Costs

- Bar Ledge : Fullnose
- Foot Rail : Fullnose
- Counter Coping : Fullnose
- 4" Banding : Copthorne

Additional Cutout Fees

- Grills
- Beverage Center / Side Burner / Ice Chest
- Doors / Drawers
- Outlet Cutout (outlet not included)
- Display Shelving Tabs (specify shelf location)

**End Cabinet (72")**

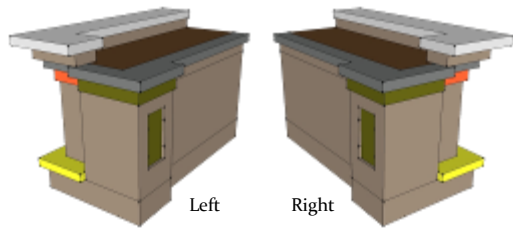

Approximate weight : Call for details.  
 Rough dimensions : 40" D x 72" W x 49.5" H

Product ID—KUECL72(Left)  
 Product ID—KUECR72 (Right)

Available Upgrades

- Bar Ledge : Fullnose
- Bar Ledge : Ledgestone
- Foot Rail : Fullnose or Ledgestone
- Counter Coping : Fullnose or Ledgestone
- 4" Banding : Copthorne or Richcliff
- 4" Banding : Series 3000, Unigranite, Hollandstone  
 Umbriano, Il Campo, Holland Premier

**End Cabinet (36")**

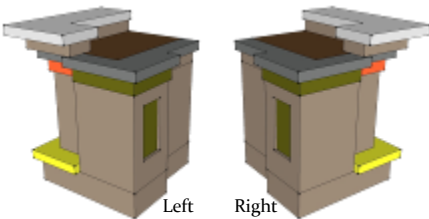

Approximate weight : Call for details.  
 Rough dimensions : 40" D x 36" W x 49.5" H

Product ID—KUECL36(Left)  
 Product ID—KUECR36 (Right)

Available Upgrades

- Bar Ledge : Fullnose
- Bar Ledge : Ledgestone
- Foot Rail : Fullnose or Ledgestone
- Counter Coping : Fullnose or Ledgestone
- 4" Banding : Copthorne or Richcliff
- 4" Banding : Series 3000, Unigranite, Hollandstone  
 Umbriano, Il Campo, Holland Premier

**Corner Cabinet (45°)**



Approximate weight :  
 Call for details.  
 Rough dimensions :  
 36" D x 22" W x 49.5" H

Product ID—KUCC45

Available Upgrades

- Bar Ledge : Fullnose
- Bar Ledge : Ledgestone
- Foot Rail : Fullnose or Ledgestone
- Counter Coping : Fullnose or Ledgestone
- 4" Banding : Copthorne or Richcliff
- 4" Banding : Series 3000, Unigranite, Hollandstone  
 Umbriano, Il Campo, Holland Premier

**Corner Cabinet (90°)**

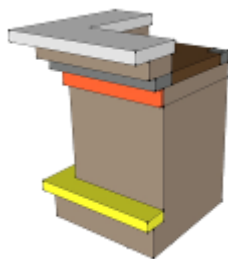

Approximate weight :  
 Call for details.  
 Rough dimensions :  
 36" D x 36" W x 49.5" H

Product ID—KUCC90

Available Upgrades

- Bar Ledge : Fullnose
- Bar Ledge : Ledgestone
- Foot Rail : Fullnose or Ledgestone
- Counter Coping : Fullnose or Ledgestone
- 4" Banding : Copthorne or Richcliff
- 4" Banding : Series 3000, Unigranite, Hollandstone  
 Umbriano, Il Campo, Holland Premier

**Cabinet (24")**



Approximate weight :  
 Call for details.  
 Rough dimensions :  
 36" D x 24" W x 49.5" H

Product ID—KUFC24

Available Upgrades

- Bar Ledge : Fullnose
- Bar Ledge : Ledgestone
- Foot Rail : Fullnose or Ledgestone
- Counter Coping : Fullnose or Ledgestone
- 4" Banding : Copthorne or Richcliff
- 4" Banding : Series 3000, Unigranite, Hollandstone  
 Umbriano, Il Campo, Holland Premier

**Cabinet (32")**

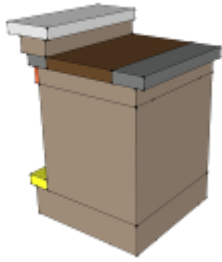

Approximate weight :  
Call for details.  
Rough dimensions :  
36" D x 32" W x 49.5" H

Product ID—KUFC32

Available Upgrades

- Bar Ledge : Fullnose
- Bar Ledge : Ledgestone
- Foot Rail : Fullnose or Ledgestone
- Counter Coping : Fullnose or Ledgestone
- 4" Banding : Copthorne or Richcliff
- 4" Banding : Series 3000, Unigranite, Hollandstone  
Umbriano, Il Campo, Holland Premier

**Cabinet (36")**

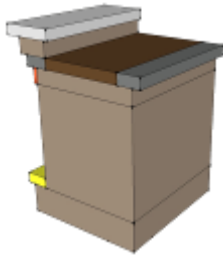

Approximate weight :  
Call for details.  
Rough dimensions :  
36" D x 36" W x 49.5" H

Product ID—KUFC36

Available Upgrades

- Bar Ledge : Fullnose
- Bar Ledge : Ledgestone
- Foot Rail : Fullnose or Ledgestone
- Counter Coping : Fullnose or Ledgestone
- 4" Banding : Copthorne or Richcliff
- 4" Banding : Series 3000, Unigranite, Hollandstone  
Umbriano, Il Campo, Holland Premier

**Cabinet (48")**

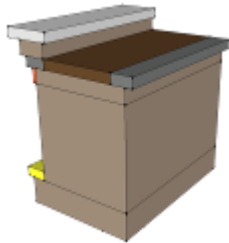

Approximate weight :  
Call for details.  
Rough dimensions :  
36" D x 48" W x 49.5" H

Product ID—KUFC48

Available Upgrades

- Bar Ledge : Fullnose
- Bar Ledge : Ledgestone
- Foot Rail : Fullnose or Ledgestone
- Counter Coping : Fullnose or Ledgestone
- 4" Banding : Copthorne or Richcliff
- 4" Banding : Series 3000, Unigranite, Hollandstone  
Umbriano, Il Campo, Holland Premier

**Cabinet (60")**

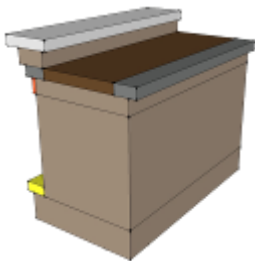

Approximate weight :  
Call for details.  
Rough dimensions :  
36" D x 60" W x 49.5" H

Product ID—KUFC60

Available Upgrades

- Bar Ledge : Fullnose
- Bar Ledge : Ledgestone
- Foot Rail : Fullnose or Ledgestone
- Counter Coping : Fullnose or Ledgestone
- 4" Banding : Copthorne or Richcliff
- 4" Banding : Series 3000, Unigranite, Hollandstone  
Umbriano, Il Campo, Holland Premier

**Cabinet (72")**

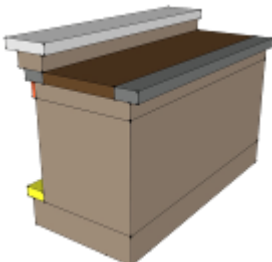

Approximate weight :  
Call for details.  
Rough dimensions :  
36" D x 72" W x 49.5" H

Product ID—KUFC72

Available Upgrades

- Bar Ledge : Fullnose
- Bar Ledge : Ledgestone
- Foot Rail : Fullnose or Ledgestone
- Counter Coping : Fullnose or Ledgestone
- 4" Banding : Copthorne or Richcliff
- 4" Banding : Series 3000, Unigranite, Hollandstone  
Umbriano, Il Campo, Holland Premier

**Wine Cabinet (36")**

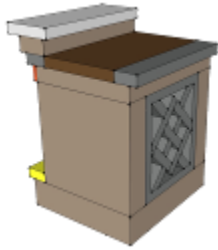

Approximate weight :  
Call for details.  
Rough dimensions :  
36" D x 36" W x 49.5" H

Product ID—KUWC36

Available Upgrades

- Bar Ledge : Fullnose
- Bar Ledge : Ledgestone
- Foot Rail : Fullnose or Ledgestone
- Counter Coping : Fullnose or Ledgestone
- 4" Banding : Copthorne or Richcliff
- 4" Banding : Series 3000, Unigranite, Hollandstone  
Umbriano, Il Campo, Holland Premier

**Niche/Display Cabinet (36")**

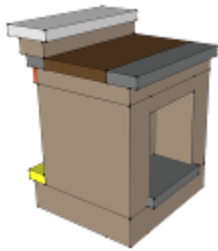

Approximate weight :  
Call for details.  
Rough dimensions :  
36" D x 36" W x 49.5" H  
  
\* Shown w/ optional shelving  
tabs - shelves not included.

Product ID—KUNC36

Available Upgrades

- Bar Ledge : Fullnose
- Bar Ledge : Ledgestone
- Foot Rail : Fullnose or Ledgestone
- Counter Coping : Fullnose or Ledgestone
- 4" Banding : Copthorne or Richcliff
- 4" Banding : Series 3000, Unigranite, Hollandstone  
Umbriano, Il Campo, Holland Premier

**Wood Box Cabinet (36")**

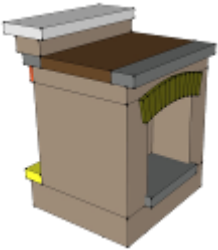

Approximate weight :  
Call for details.  
Rough dimensions :  
36" D x 36" W x 49.5" H

Product ID—KUWB36

Available Upgrades

- Bar Ledge : Fullnose
- Bar Ledge : Ledgestone
- Foot Rail : Fullnose or Ledgestone
- Counter Coping : Fullnose or Ledgestone
- 4" Banding : Copthorne or Richcliff
- 4" Banding : Series 3000, Unigranite, Hollandstone  
Umbriano, Il Campo, Holland Premier

**Fridge Cabinet (32")**

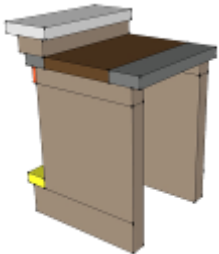

Approximate weight :  
Call for details.  
Rough dimensions :  
36" D x 32" W x 49.5" H

Product ID—KURC32

Available Upgrades

- Bar Ledge : Fullnose
- Bar Ledge : Ledgestone
- Foot Rail : Fullnose or Ledgestone
- Counter Coping : Fullnose or Ledgestone
- 4" Banding : Copthorne or Richcliff
- 4" Banding : Series 3000, Unigranite, Hollandstone  
Umbriano, Il Campo, Holland Premier

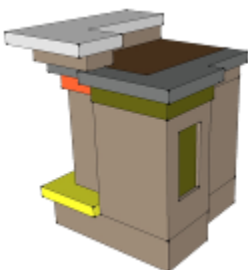

- Color Legend :**
- ◆ Main Body
  - ◇ Bar Ledge
  - ◆ Foot Rail
  - ◆ Counter Coping
  - ◆ 4" Banding
  - ◆ Insets

Cutout Fees

- Grills
- Beverage Center / Side Burner / Ice Chest
- Doors / Drawers
- Outlet Cutout (outlet not included)
- Display Shelving Tabs (specify shelf location)

## Stainless Grills & Accessories



Grills and accessories add the convenience that is essential in an outdoor kitchen. Having a variety of options and sizes makes designing any outdoor kitchen. All OCS products are made of stainless steel ensuring a product that will be durable for years to come.



**3 Burner No Infra Red**

Approximate weight : 135 lbs.

Cutout Dimensions :  
21.75" D x 25" W x 10.88" H

Btu's : 45,000

Product ID—S32B4SoB



**5 Burner With Infra Red**

Approximate weight : 175 lbs.

Cutout Dimensions :  
21.75" D x 39" W x 10.88" H

Btu's : 90,000

Product ID—S52B4SRB



**3 Burner With Infra Red**

Approximate weight : 135 lbs.

Cutout Dimensions :  
21.75" D x 25" W x 10.88" H

Btu's : 60,000

Product ID—S32B4SRB



**Drop In Side Burner**

Approximate weight : 15 lbs.

Cutout Dimensions :  
15.5" D x 10" W x 1" H

Btu's : 17,500

Product ID—SBD1SC



**4 Burner No Infra Red**

Approximate weight : 155 lbs.

Cutout Dimensions :  
21.75" D x 30.75" W x 10.88" H

Btu's : 60,000

Product ID—S42B4SoB



**Single Slide In Burner**

Approximate weight : 20 lbs.

Cutout Dimensions :  
12" D x 13.25" W x 10.5" H

Btu's : 17,500

Product ID—SBSIS



**4 Burner With Infra Red**

Approximate weight : 160 lbs.

Cutout Dimensions :  
21.75" D x 30.75" W x 10.88" H

Btu's : 75,000

Product ID—S42B4SRB



**Double Slide In Burner**

Approximate weight : 24 lbs.

Cutout Dimensions :  
22.75" D x 13.25" W x 10.5" H

Btu's : 35,000

Product ID—SBS2SP



17 x 24 Flush Mount Door  
Horizontal

Approximate weight : 15 lbs.  
Cutout Dimensions :  
Flush D x 24.25" W x 17.25" H

Product ID—D1724HS



Single Deluxe Door

Approximate weight : 20 lbs.  
Cutout Dimensions :  
2" D x 12.25" W x 18.5" H

Product ID—D1521DS



14 x 20 Flush Mount Door  
Horizontal

Approximate weight : 15 lbs.  
Cutout Dimensions :  
Flush D x 20.25" W x 14.25" H

Product ID—D1420HS



30" Double Door

Approximate weight : 25 lbs.  
Cutout Dimensions :  
2" D x 27.5" W x 18.88" H

Product ID—D3021DS



17 x 24 Flush Mount Door  
Vertical

Approximate weight : Call for details.  
Cutout Dimensions :  
Call for details

Product ID—D1724VS



42" Double Door

Approximate weight : 35 lbs.  
Cutout Dimensions :  
2" D x 39.5" W x 18.88" H

Product ID—D4221DS



14 x 20 Flush Mount Door  
Vertical

Approximate weight : Call for details.  
Cutout Dimensions :  
Call for details

Product ID—D1420VS



Single Drawer

Approximate weight : 10 lbs.  
Cutout Dimensions :  
23.5" D x 12.25" W x 6.5" H

Product ID—DR15S



**Double Drawer**

Approximate weight : 35 lbs.  
 Cutout Dimensions :  
 21.75" D x 12.25" W x 12.5" H

Product ID—DR21S



**Ice Storage Unit**

Approximate weight : 65 lbs.  
 Cutout Dimensions :  
 19.25" D x 26.38" W x 10.5" H

Product ID—MDIG27SS



**Triple Drawer**

Approximate weight : 45 lbs.  
 Cutout Dimensions :  
 23.5" D x 12.25" W x 18.75" H

Product ID—DR31S

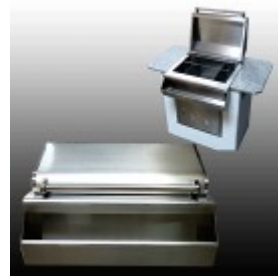

**Gourmet Ice Chest**

Approximate weight : 15 lbs.  
 Cutout Dimensions :  
 19.5" D x 26.5" W x 10.5" H

Product ID—DIG27SS



**Combo Drawer**

Approximate weight : Call for details.  
 Cutout Dimensions :  
 Call for details

Product ID—3oCBoDR

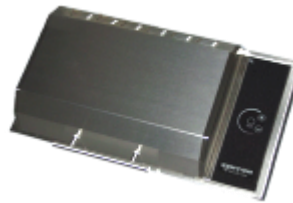

**Frontier Built In**

Approximate weight : Call for details  
 Overall Dimensions :  
 12" D x 21." W x 4.5" H (7.75" w/ lid)  
 Cutout Dimensions : 11.625" D x 19.75" W

Product ID—B7005



**Combo Drawer**

Approximate weight : 95 lbs.  
 Cutout Dimensions :  
 20.5" D x 29.5" W x 20.75" H

Product ID—O3oDRE3o



**Rio Built In**

Approximate weight : Call for details  
 Overall Dimensions :  
 14.375" D x 21.125" W x 4.5" H (8" w/ lid)  
 Cutout Dimensions : 11.625" D x 19.75" W

Product ID—B70o8



**16" Cocktail Station**

Approximate weight : 40 lbs.  
 Cutout Dimensions :  
 23.75" D x 13.25" W x 10.5" H

Product ID—D14CS

**Oklite**



Product ID—OKLITE

**Umbrella & Tiki Caps**



Product ID—TIKICAP







Creation Begins With The Elements. <sup>TM</sup>

