

NEW PRODUCT

UNISTRUT[®] DEFENDER[™]

CORROSION-RESISTANT PRODUCT LINE

A PART OF





UNISTRUT® DEFENDER™

Unistrut International is proud to introduce a new, corrosion-resistant product line called Unistrut Defender. Unistrut Defender is designed for harsh environments, providing a service life between Hot-Dip Galvanized and stainless steel systems. Independent testing shows that Unistrut Defender is **THREE** times more corrosion-resistant than Hot-Dip Galvanized products. In addition, Unistrut Defender avoids the use of costly stainless steel hardware. Unistrut Defender is a great choice for harsh and corrosive environments.

Get better performance with Unistrut Defender.

This brochure lists the Unistrut Defender parts, dimensions and applications currently in stock. Many other Unistrut parts can be made by request.

For more information about Unistrut Defender, contact your Unistrut Regional Manager, Agent or call 800-468-9510.

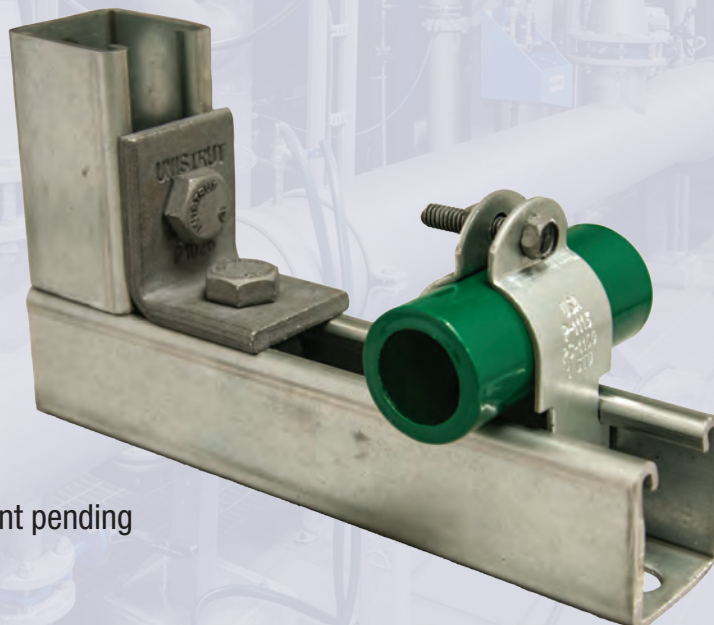

*Patent pending

CORROSION PROTECTION

Unistrut Defender was tested against Hot-Dip Galvanized products by an independent, accredited 3rd party lab for 3,000 hours of continuous salt spray exposure per ASTM B117. At the conclusion of the test, 5 of the 6 Unistrut Defender samples still had not reached the 5% red rust failure criteria! The results are outlined below, showing that Unistrut Defender survived over 3 times as long as Hot-Dip Galvanized.









ASTM B117 TEST TO 5% RED RUST (RESULTS ARE IN HOURS):

	1	2	3	4	5	6	Average
Hot-Dip Galvanized per ASTM A123 and A153	744	744	1,207	-	-	-	898
Unistrut Defender	2,856	3,000*	3,000*	3,000*	3,000*	3,000*	2,976 <i>3X Improvement!</i>

*Test stopped at 3,000 hours with samples still not reaching failure.

PHOTOS FROM ASTM B117 SALT SPRAY TEST:

Hot-Dip Galvanized reached 5% red rust at an average of 898 hours.

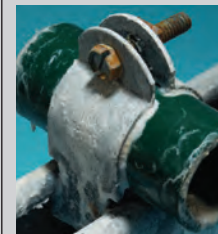
	0 hrs	100 hrs	1,000 hrs	2,000 hrs	3,000 hrs
Hot-Dip Galvanized per ASTM A123 and A153					
Unistrut Defender					

5 of 6 samples still active at 3,000 hours!



ANTICIPATED SERVICE LIFE

With over 3 times the corrosion protection of Hot-Dip Galvanized products, the anticipated service life for Unistrut Defender vastly outperforms traditional carbon steel framing systems. Unistrut Defender will meet the design life of most new applications, eliminating the need to replace parts over time. See the difference below!

ANTICIPATED SERVICE LIFE

(Time to 5% Red Rusting of the Steel Surface)

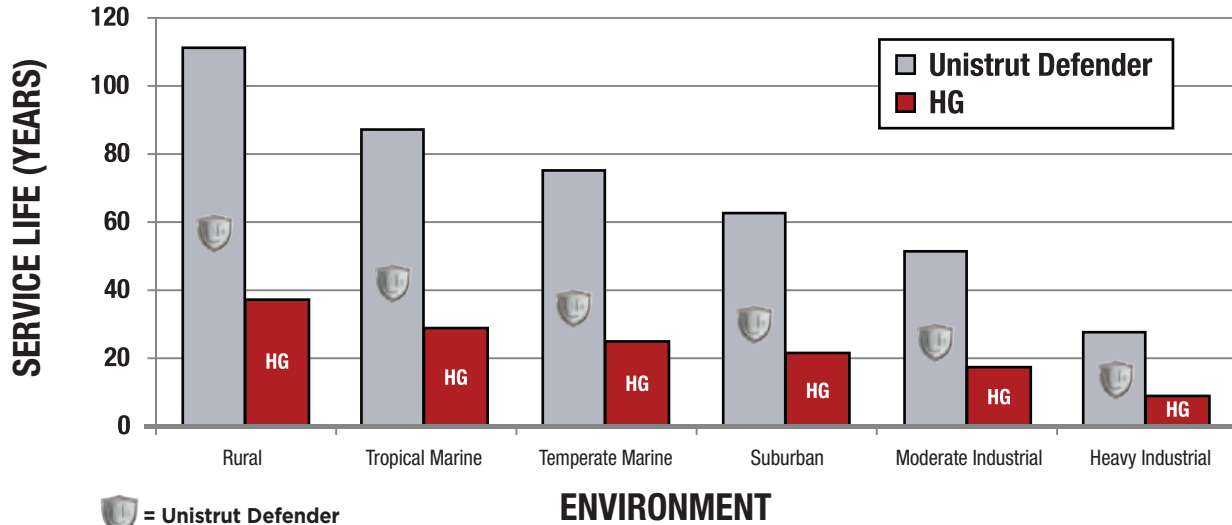

= Unistrut Defender

ENVIRONMENT

*HG = Hot-Dip Galvanized per ASTM A123 and A153 coating service life as specified within the Metal Framing Industry

TYPICAL APPLICATION DESIGN LIFE VS. ANTICIPATED SERVICE LIFE

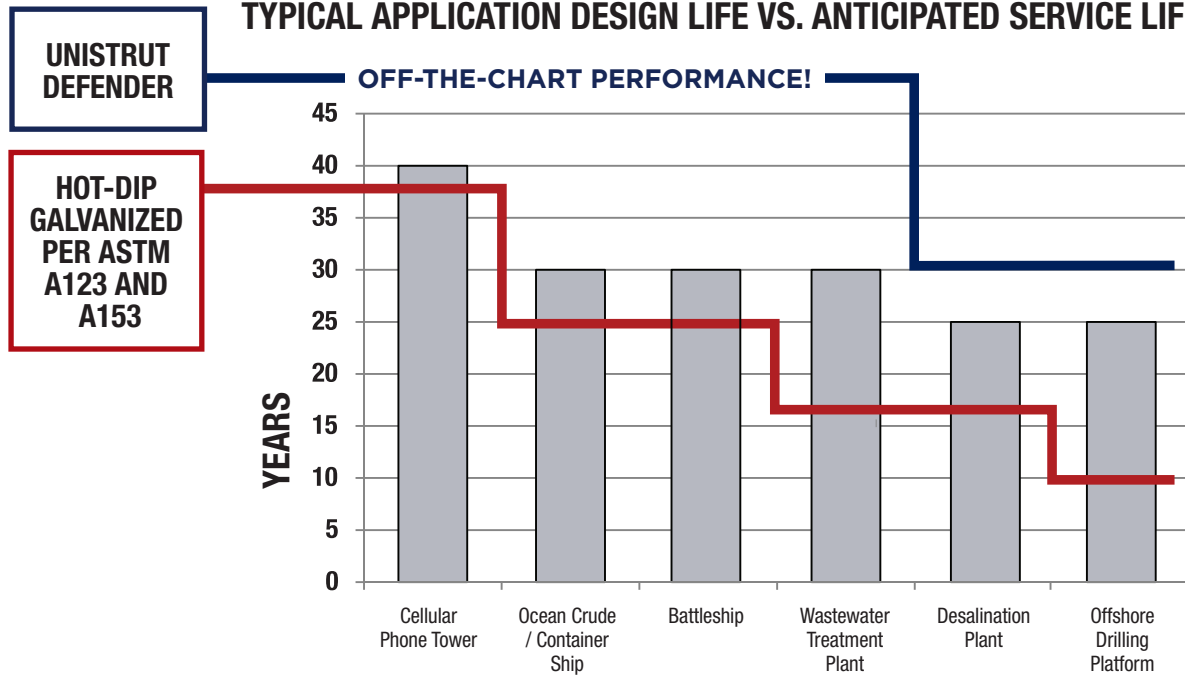

UNISTRUT DEFENDER

HOT-DIP GALVANIZED PER ASTM A123 AND A153

OFF-THE-CHART PERFORMANCE!

YEARS

*Typical application design life is sourced from a number of different publications and is not true for all applications. Reference your project-specific requirements and environment for a true performance estimate.

TECHNICAL INFORMATION

FINISHES:

Unistrut Defender is a combination of two proprietary material coatings conforming to ASTM standards A1046 and A1059.

MATERIALS:

Channel, Fittings and Pipe Clamps meet the physical requirements of ASTM A1011 SS GR 33.

TECHNICAL NOTES:

1. Structural performance, including Slip and Pull-Out Loads, meets all Allowable Loads as specified in the Unistrut General Engineering catalog for carbon steels. Please reference the Unistrut General Engineering catalog for this information.
2. To achieve full performance and cost benefits, Unistrut Defender must be used as a complete metal framing system. In addition, Unistrut Defender should not be put in contact with stainless steel materials due to a dissimilar metals condition that will create galvanic corrosion.
3. Some red staining may be observed over time on Unistrut Defender parts in corrosive environments. Red staining is superficial oxidation of the zinc/iron ions at the surface, and not corrosion of the substrate steel. This is noted in ASTM A1059 section 6.3.
4. One of the unique characteristics of Unistrut Defender is that it contains self-healing properties. If the product is cut or scratched in the field, the finish will propagate into those areas eliminating the need for secondary touch-ups.



TABLE OF CONTENTS

1 5/8" Channel

DIMENSIONS

Imperial dimensions are illustrated in inches. Metric dimensions are shown in millimeters and rounded to one decimal place.

STANDARD LENGTHS

Standard lengths are 10 feet (3.05m) and 20 feet (6.10m). Tolerances are $\pm 1/8"$ (3 mm). Special lengths are available for a small cutting charge with a tolerance of $\pm 1/8"$ (3 mm).

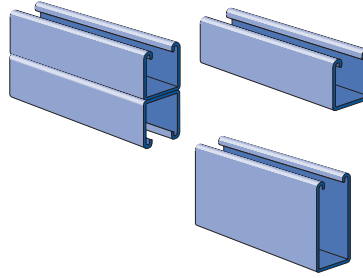

P1000 DF (12 Gauge).....	6
P3300 DF (12 Gauge).....	7
P4100 DF (14 Gauge).....	8
P5000 DF (12 Gauge).....	9

Nuts & Hardware

THREADS

All threads on the nuts and bolts are Unified and American coarse screw threads.

DIMENSIONS

Imperial dimensions are illustrated in inches. Metric dimensions are shown in parentheses or as noted.

Unless noted, all metric dimensions are in millimeters and rounded to one decimal place.

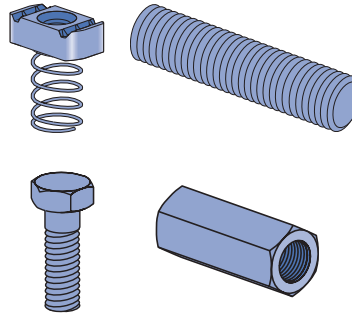

Channel Nuts With Springs.....	10
Channel Nuts Without Springs.....	10
Hardware.....	10

General Fittings & Beam Clamps

APPLICATION

All parts drawings illustrate only one application of each fitting. In most cases many other applications are possible. The channels shown in the illustrations are P1000, 1 5/8" square, except where noted otherwise.

All 9/16" diameter holes use 1/2" x 15/16" hex head cap screws and 1/2" nuts – P1010, P4010 or P5510 – depending on the channel used. Nuts and bolts are not included with the fitting and must be ordered separately.

DIMENSIONS

Imperial dimensions are illustrated in inches. Metric dimensions are shown in parenthesis or as noted. Unless noted, all metric dimensions are in millimeters and rounded to one decimal place.

BEAM CLAMPS

Clamps are designed to be used with W, M, S and HP Shape beams, Standard C and Miscellaneous MC Channels, Angles and Structural Tees. Clamps must be used in pairs where indicated.

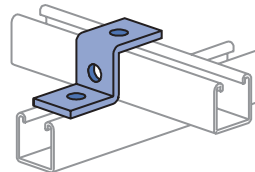
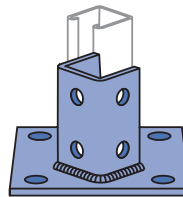

General Fittings	12
Beam Clamps	15

Pipe/Conduit Supports

APPLICATION

Unistrut pipe clamps are designed for the support of electrical and mechanical services. Supports to meet nearly every requirement can be attained using Unistrut Metal Framing components.

DIMENSIONS

Imperial dimensions are illustrated in inches. Metric dimensions are shown in parenthesis or as noted. Unless noted, all metric dimensions are in millimeters and rounded to one decimal place.

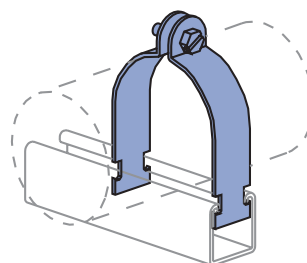

Pipe/Conduit Clamps.....	16
--------------------------	----

P1000® DF & P1001 DF Channels

P1000® DF

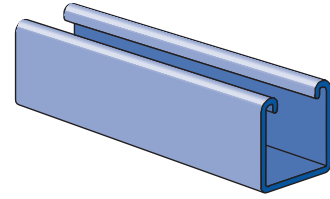
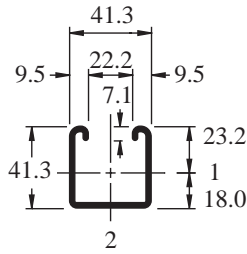
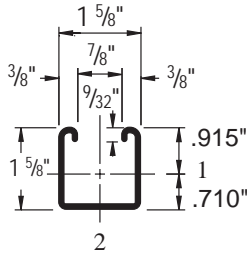

Wt/100 ft: 189 lbs (281 kg/100 m)
 Allowable Moment 5,070 in-lbs (570 N•m)
 12 Gauge Nominal Thickness .105" (2.7mm)

P1001 DF

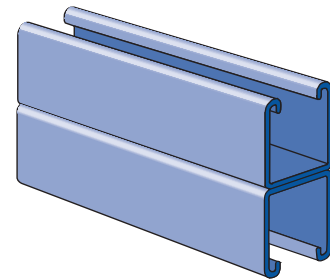
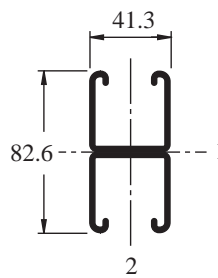
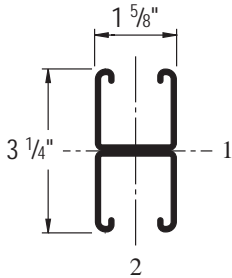

Wt/100 ft: 378 lbs (562 kg/100 m)
 Allowable Moment 14,360 in-lbs (1,620 N•m)
 12 Gauge Nominal Thickness .105" (2.7mm)

P1000T DF

Slots are
 1 1/8" (28.6) x 9/16" (14.3)
 2" (50.8) on Center

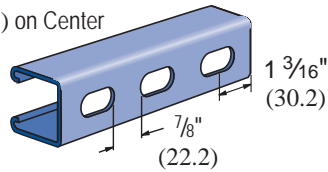

Wt/100 ft: 185 lbs (275 kg/100 m)

P1001T DF

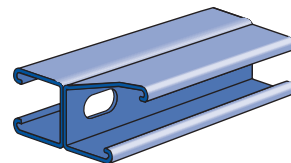

Wt/100 ft: 321 lbs (478 kg/100 m)
 Allowable Moment 12,200 in-lbs (1,378 N•m)
 12 Gauge Nominal Thickness .105" (2.7mm)

CHANNEL NUTS (Refer to Hardware Section for Details)

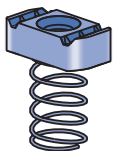

P1006-1420 DF
 P1008 DF
 P1010 DF

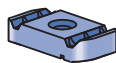

P3006-1420 DF
 P3008 DF
 P3010 DF

Standard Channel Lengths: 10' & 20'



1 5/8" CHANNEL

P3300® DF & P3301 DF Channels

P3300 DF

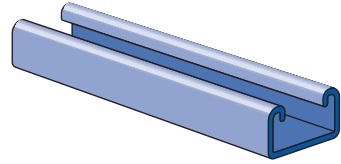
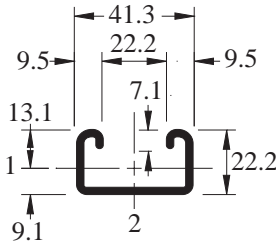
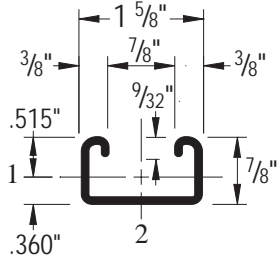

Wt/100 ft: 134 lbs (200 kg/100 m)
 Allowable Moment 1,800 in-lbs (200 N•m)
 12 Gauge Nominal Thickness .105" (2.7mm)

P3301 DF

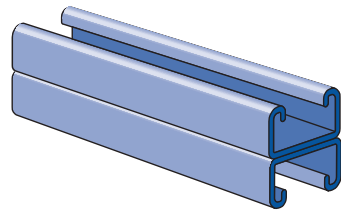
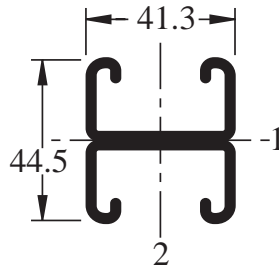
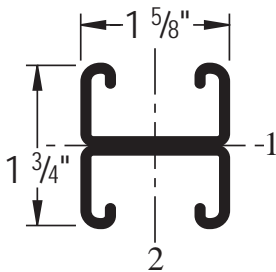

Wt/100 ft: 269 lbs (400 kg/100 m)
 Allowable Moment 5,060 in-lbs (570 N•m)
 12 Gauge Nominal Thickness .105" (2.7mm)

P3300T DF

Slots are
 1 1/8" (28.6) x 9/16" (14.3)
 2" (50.8) on Center

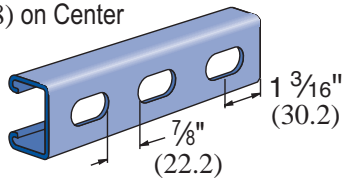

Wt/100 ft: 130 lbs (193 kg/100 m)

P3301T DF

Wt/100 ft: 260 lbs (386 kg/100 m)

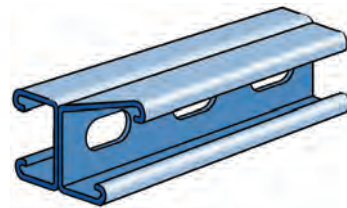

CHANNEL NUTS (Refer to Hardware Section for Details)

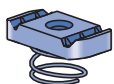

P4006-1420 DF
 P4008 DF
 P4010 DF

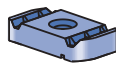

P3006-1420 DF
 P3008 DF
 P3013 DF

Standard Channel Lengths: 10' & 20'

P4100 DF & P4101 DF Channels

P4100 DF

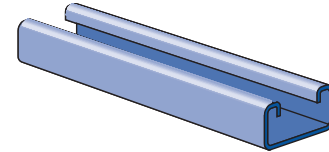
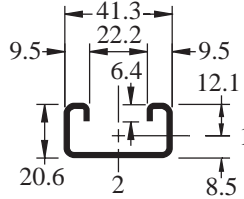
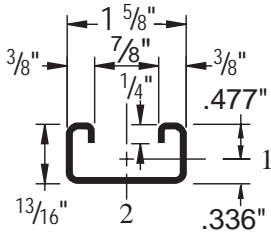

Wt/100 ft: 98 lbs (147 kg/100 m)
 Allowable Moment 1,360 in-lbs (150 N•m)
 14 Gauge Nominal Thickness .075" (1.9mm)

P4101 DF

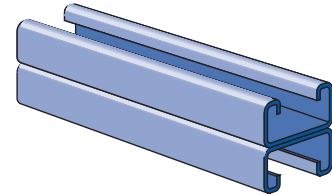
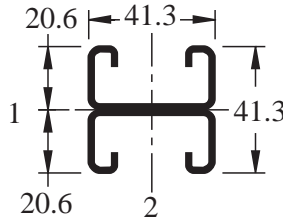
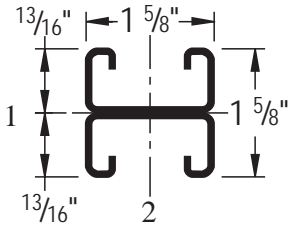

Wt/100 ft: 197 lbs (293 kg/100 m)
 Allowable Moment 3,610 in-lbs (410 N•m)
 14 Gauge Nominal Thickness .075" (1.9mm)

P4100T DF

Wt/100 ft: 87 lbs (129 kg/100 m)

Slots are
 1 1/8" (28.6) x 9/16" (14.3)
 2" (50.8) on Center

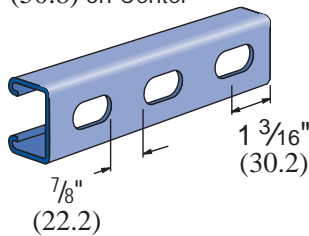

P4101T DF

Wt/100 ft: 174 lbs (259 kg/100 m)

Slots are
 1 1/8" (28.6) x 9/16" (14.3)
 2" (50.8) on Center

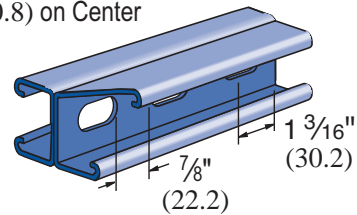

CHANNEL NUTS (Refer to Hardware Section for Details)

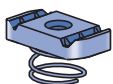

P4006-1420 DF
 P4008 DF
 P4010 DF



P3006-1420 DF
 P3008 DF
 P3013 DF

Standard Channel Lengths: 10' & 20'



1 5/8" CHANNEL

P5000 DF & P5001 DF Channels

P5000 DF

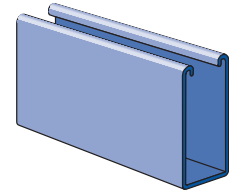
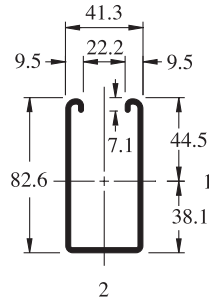
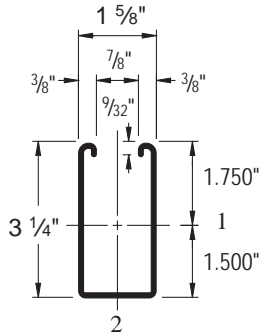

Wt/100 ft: 305 lbs (454 kg/100 m)
 Allowable Moment 15,770 in-lbs (1,780 N•m)
 12 Gauge Nominal Thickness .105" (2.7mm)

P5001 DF

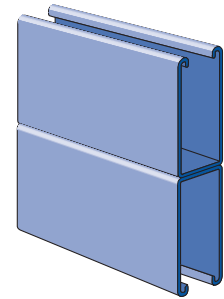
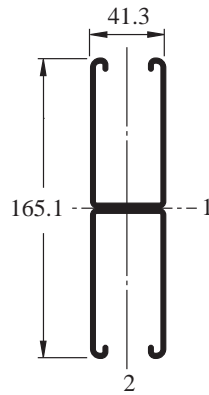
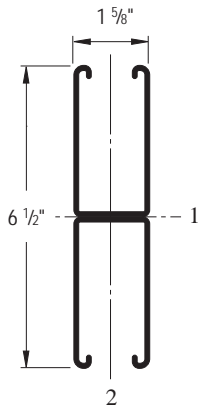

Wt/100 ft: 610 lbs (907 kg/100 m)
 Allowable Moment 48,180 in-lbs (5,440 N•m)
 12 Gauge Nominal Thickness .105" (2.7mm)

P5000T DF

P5001T DF

Wt/100 ft: 600 lbs (892 kg/100 m)

Slots are
 1 1/8" (28.6) x 9/16" (14.3)
 2" (50.8) on Center

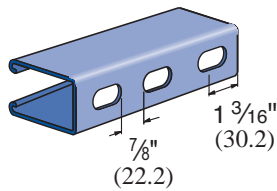

Wt/100 ft: 300 lbs (446 kg/100 m)

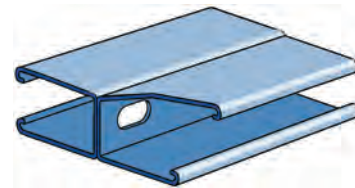

CHANNEL NUTS (Refer to Hardware Section for Details)

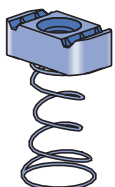

P5508 DF
 P5510 DF

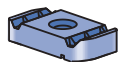

P3006-1420 DF
 P3008 DF
 P3010 DF

Standard Channel Lengths: 10' & 20'

Channel Nuts With and Without Spring

CHANNEL NUT WITH SPRING

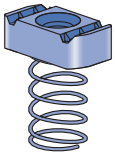
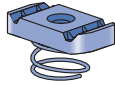
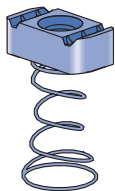
	Part Number	Nut Size Thread	Wt/100 pcs lbs (kg)	Use With
	P1006-1420 DF	¼" -20	7 (3.2)	<i>P1000 DF</i>
P1008 DF	⅜" -16	10 (4.5)		
P1010 DF	½" -13	12 (5.4)		
	Part Number	Nut Size Thread	Wt/100 pcs lbs (kg)	Use With
	P4008 DF	⅜" -16	9 (4.1)	<i>P3300 DF, P4100 DF</i>
P4010 DF	½" -13	8 (3.6)		
	Part Number	Nut Size Thread	Wt/100 pcs lbs (kg)	Use With
	P5508 DF	⅜" -16	10 (4.5)	<i>P5000 DF</i>
P5510 DF	½" -13	12 (5.4)		

CHANNEL NUT WITHOUT SPRING

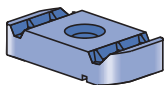
	Part Number	Nut Size Thread	Wt/100 pcs lbs (kg)	Use With
	P3006-1420 DF	¼" -20	6 (2.7)	Any Channel
P3008 DF	⅜" -16	9 (4.1)		
P3010 DF	½" -13	11 (5.0)	P1000 DF, P5000 DF	
P3013 DF	½" -13	8 (3.6)	P3300 DF, P4100 DF	

Hardware

HEX HEAD CAP SCREWS

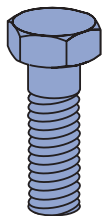

Part No.	Size	Wt/100 pcs lbs (kg)
HHCS025075DF	¼" x ¾"	1.3 (0.6)
HHCS025150DF	¼" x 1½"	2.6 (1.2)
HHCS037100DF	⅜" x 1"	4.5 (2.0)
HHCS037150DF	⅜" x 1½"	6.0 (2.7)
HHCS050094DF	½" x ⅜"	9.1 (4.1)
HHCS050119DF	½" x ⅜"	10.2 (4.6)
HHCS050150DF	½" x 1½"	11.6 (5.3)

HEXAGON NUTS



Part No.	Size	Wt/100 pcs lbs (kg)
HHXN025DF	¼"	0.6 (0.3)
HHXN037DF	⅜"	1.6 (0.7)
HHXN050DF	½"	4.8 (2.2)

FLAT WASHERS



Part No.	Size	Wt/100 pcs lbs (kg)
HFLW025DF	¼"	0.8 (0.4)
HFLW037DF	⅜"	1.5 (0.7)
HFLW050DF	½"	3.5 (1.6)



NUTS & HARDWARE

Hardware

STEEL COUPLER NUTS

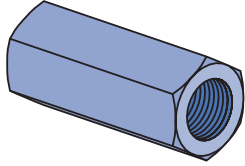

Part Number	Size	Length in (mm)	Wt/100 pcs lbs (kg)
HRCN037DF	3/8" - 16	1 3/4" (44.5)	9.0 (4.1)
HRCN050DF	1/2" - 13	1 3/4" (44.5)	10.0 (4.5)

STEEL THREADED ROD

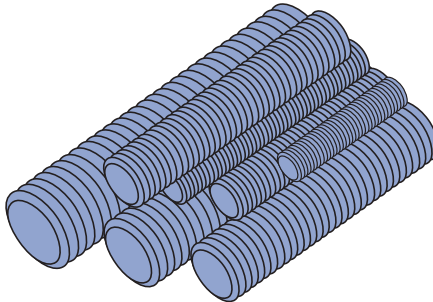

Low Carbon Steel Grade 1006 - 1010
 $F_y = 36,000$ psi minimum
 $F_t = 58,000$ psi minimum

Part No.	Size	Wt/100 ft. lbs (kg)
HTHR037DF	3/8" x 16	30 (13.6)
HTHR050DF	1/2" x 13	53 (24.0)

Standard Length 6' (1.83m)

LOCK WASHERS



Part No.	Size	Wt/100 pcs lbs (kg)
HLKW025DF	1/4"	0.25 (0.1)
HLKW037DF	3/8"	0.63 (0.3)
HLKW050DF	1/2"	1.32 (0.60)

General Fittings

P1063 DF, P1064 DF

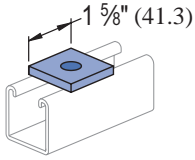

Part No.	Bolt Size	Hole Size	Wt/100 pcs lbs (kg)
P1063 DF	3/8"	7/16"	18 (8.2)
P1064 DF	1/2"	9/16"	17 (7.7)

P2863 DF, P2864 DF

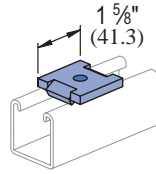

Part Number	Bolt Size	Hole Size	Wt/100 pcs lbs (kg)
P2863 DF	3/8"	7/16"	18 (8.2)
P2864 DF	1/2"	9/16"	17 (7.7)

P1065 DF

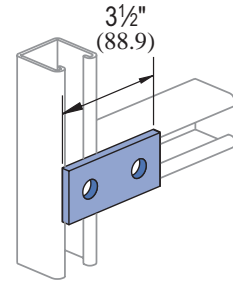

Wt/100 pcs: 38 lbs (17.2 kg)

P2324 DF

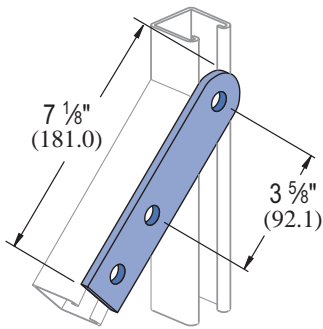

Wt/100 pcs: 75 lbs (34.0 kg)

P1066 DF

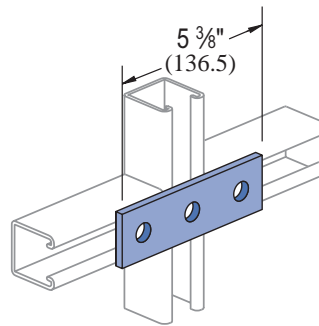

Wt/100 pcs: 56 lbs (25.4 kg)

P1067 DF

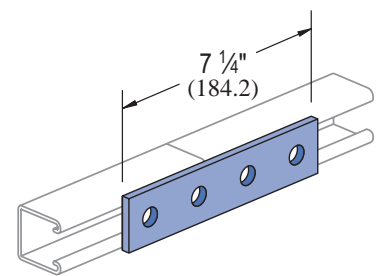

Wt/100 pcs: 78 lbs (35.4 kg)

P1036 DF

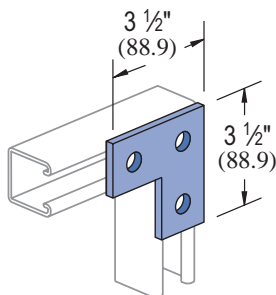

Wt/100 pcs: 58 lbs (26.3 kg)

P1380A DF

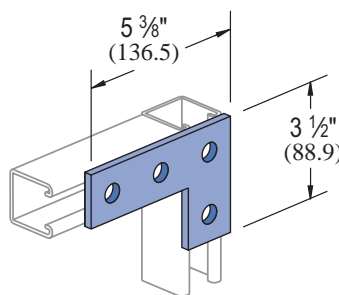

Wt/100 pcs: 105 lbs (47.6 kg)

Standard Dimensions for 1 5/8" (41.3mm) width series channel fittings (Unless Otherwise Shown on Drawing)
 Hole Diameter: 9/16" (14.3mm); Hole Spacing - From End: 1 3/16" (20.6mm); Hole Spacing - On Center: 1 7/8" (47.6mm); Width: 1 5/8" (41.3mm); Thickness: 1/4" (6.4mm)



GENERAL FITTINGS

General Fittings

P1031 DF

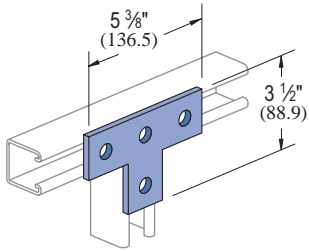

Wt/100 pcs: 80 lbs (36.3 kg)

P1028 DF

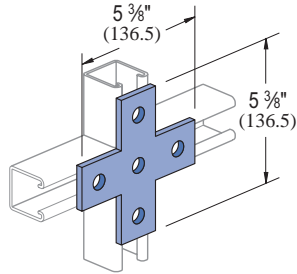

Wt/100 pcs: 105 lbs (47.6 kg)

P1026 DF

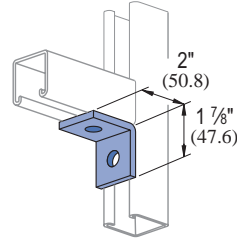

Wt/100 pcs: 38 lbs (17.2 kg)

P1068 DF

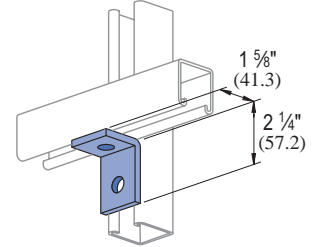

Wt/100 pcs: 38 lbs (17.2 kg)

P1498 DF

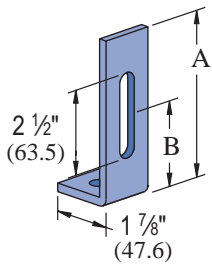

Part Number	"A" in (mm)	"B" in (mm)	Wt/100 pcs lbs (kg)
P1498 DF	4 ⁷ / ₈ 123.8	2 ¹ / ₂ 63.5	65 29.5

P1346 DF

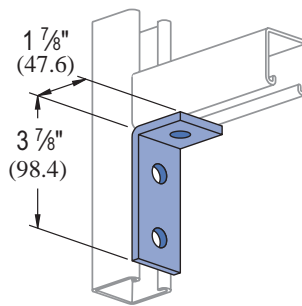

Wt/100 pcs: 58 lbs (26.3 kg)

P1325 DF

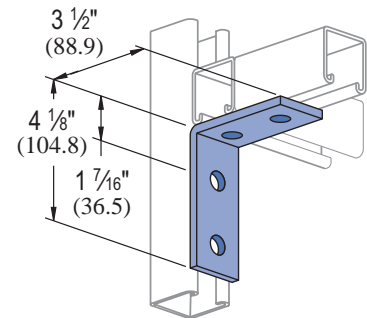

Wt/100 pcs: 78 lbs (35.4 kg)

P2484 DF

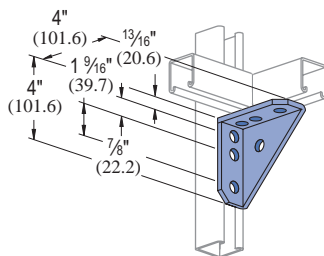

Wt/100 pcs: 134 lbs (60.8 kg)

P1546 DF

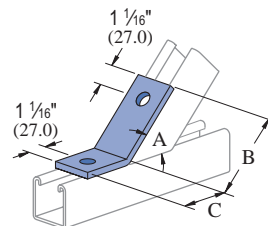

Wt/100 pcs: 58 lbs (26.3 kg)

Part No.	"A" Degree (rad)	"B" in (mm)	"C" in (mm)
P1546 DF	45° 0.79	3 76.2	2 ⁵ / ₁₆ 58.7

Standard Dimensions for 1⁵/₈" (41.3mm) width series channel fittings (Unless Otherwise Shown on Drawing)
 Hole Diameter: 9¹/₁₆" (14.3mm); Hole Spacing - From End: 1³/₁₆" (20.6mm); Hole Spacing - On Center: 1⁷/₈" (47.6mm); Width: 1⁵/₈" (41.3mm); Thickness: 1¹/₄" (6.4mm)

General Fittings

P1186 DF

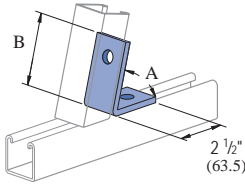

Part Number	"A" Degree (rad)	"B" in (mm)
P1186 DF	45° 0.79	3 1/8 79.4

P2265 DF

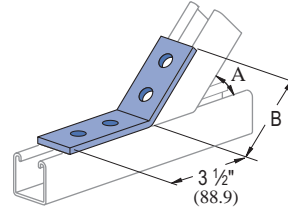

Part Number	"A" Degree (rad)	"B" in (mm)
P2265 DF	45° 0.79	3 11/16 93.7

P1045 DF

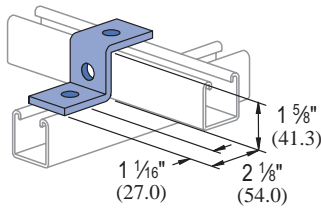

Wt/100 pcs: 55 lbs (24.9 kg)

P1047 DF

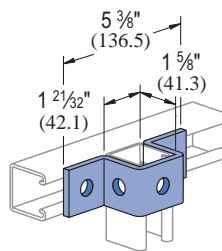

Wt/100 pcs: 88 lbs (39.9 kg)

P1048 DF

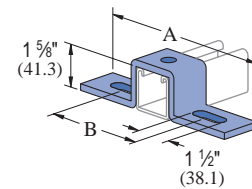

Part Number	"A" in (mm)	"B" in (mm)	Wt/100 pcs lbs (kg)
P1048 DF	7 1/4 184.2	4 7/8 104.8	105 47.6

P2072A DF, P2072A SQ DF

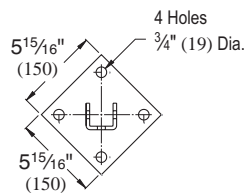
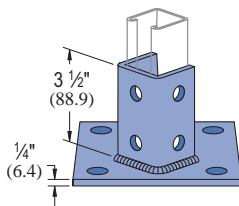

P2072 A DF

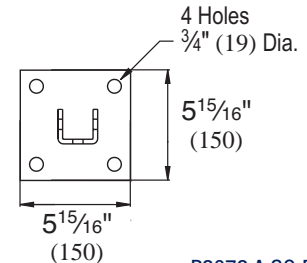

P2072 A SQ DF

Wt/100 pcs: 373 lbs (169.2 kg)

Standard Dimensions for 1 5/8" (41.3mm) width series channel fittings (Unless Otherwise Shown on Drawing)
 Hole Diameter: 9/16" (14.3mm); Hole Spacing - From End: 1 3/16" (20.6mm); Hole Spacing - On Center: 1 7/8" (47.6mm); Width: 1 5/8" (41.3mm); Thickness: 1/4" (6.4mm)



GENERAL FITTINGS

General Fittings

P1271S DF

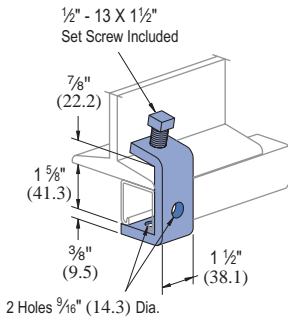

Design Load Each
500 lbs (2.22 kN)
Use in Pairs Only

Note: Requires
P1010 Channel
Nut and bolt.

Wt/100 pcs: 95 lbs (43.1 kg)

P2785 DF

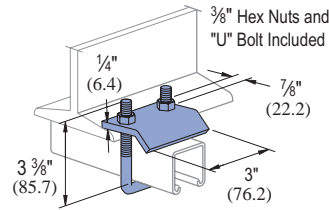

• For use with Beams up to $\frac{3}{4}$ " (19.1) Flanges and with Channels P1000, P3300, P3301, P4100, and P4101.

Design Load Each
1000 lbs (4.45 kN)
Use in Pairs Only

Wt/100 pcs: 83 lbs (37.6 kg)

P2786 DF

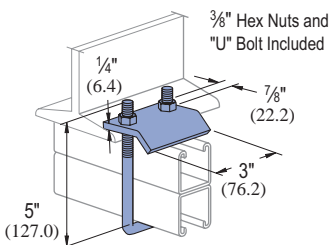

• For use with Beams up to $\frac{3}{4}$ " (19.1) Flanges and with Channels P1001, P5000.

Design Load Each
1000 lbs (4.45 kN)
Use in Pairs Only

Wt/100 pcs: 92 lbs (41.7 kg)

P2787 DF

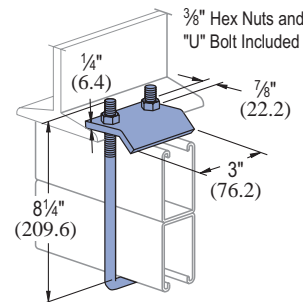

• For use with Beams up to $\frac{3}{4}$ " (19.1) Flanges and with Channels P5001.

Design Load Each
1000 lbs (4.45 kN)
Use in Pairs Only

Wt/100 pcs: 112 lbs (50.8 kg)

Beam Clamps

P1386 DF

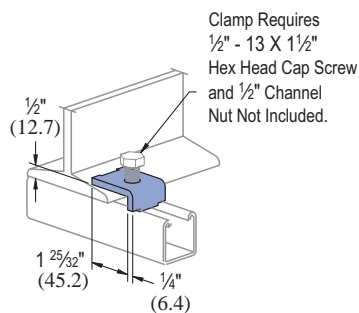

Clamp Requires
 $\frac{1}{2}$ " - 13 X $\frac{1}{2}$ "
Hex Head Cap Screw
and $\frac{1}{2}$ " Channel
Nut Not Included.

Channel Style	Design Load Each (Use in Pairs Only) lbs (kN)
P1000 DF	600 2.67

Wt/100 pcs: 27 lbs (12.2 kg)

Standard Dimensions for $\frac{1}{8}$ " (41.3mm) width series channel fittings (Unless Otherwise Shown on Drawing)

Hole Diameter: $\frac{9}{16}$ " (14.3mm); Hole Spacing - From End: $\frac{1}{16}$ " (20.6mm); Hole Spacing - On Center: $\frac{1}{8}$ " (47.6mm); Width: $\frac{1}{8}$ " (41.3mm); Thickness: $\frac{1}{4}$ " (6.4mm)

Note : When used for mechanical supports, load capacities of brackets and fittings should be in compliance with the American Standard Code for Pressure Piping.

Pipe & Conduit Clamps

P1428 DF THRU P1431 DF PIPE CLAMPS FOR THIN WALL CONDUIT (E.M.T.)

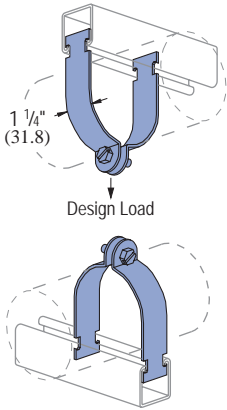

Part No.	Conduit Size in (mm)	O.D. Size in (mm)	Thickness Gauge (mm)	Wt/100 pcs lbs (kg)	Design Load lbs (kN)
P1428 DF	1	1.163	14	15	600
	25.4	29.5	1.9	6.8	2.67
P1429 DF	1¼	1.510	14	18	600
	31.8	38.4	1.9	8.2	2.67
P1430 DF	1½	1.740	12	29	800
	38.1	44.2	2.7	13.2	3.56
P1431 DF	2	2.197	12	33	800
	50.8	55.8	2.7	15.0	3.56
P1118 DF	2½	2.875	12	40	800
	63.5	73.0	2.7	18.1	3.56
P1119 DF	3	3.500	12	47	800
	76.2	88.9	2.7	21.3	3.56

Slotted hex head screw and nut included.

P1112 DF THRU P1119 DF PIPE CLAMPS FOR RIGID STEEL CONDUIT

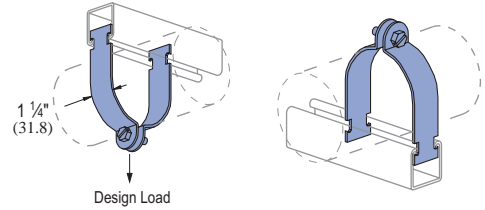

Part No.	Conduit Size in	O.D. Size in (mm)	Thickness Gauge (mm)	Wt/100 pcs lbs (kg)	Design Load lbs (kN)
P1112 DF	¾	1.050	14	15	600
		26.7	1.9	6.8	2.67
P1113 DF	1	1.315	14	17	600
		33.4	1.9	7.7	2.67
P1114 DF	1¼	1.660	14	19	600
		42.2	1.9	8.6	2.67
P1115 DF	1½	1.900	12	29	800
		48.3	2.7	13.2	3.56
P1117 DF	2	2.375	12	34	800
		60.3	2.7	15.4	3.56
P1118 DF	2½	2.875	12	40	800
		73.0	2.7	18.1	3.56
P1119 DF	3	3.500	12	47	800
		88.9	2.7	21.3	3.56

Slotted hex head screw and nut included.

P1214 DF THRU P1217 DF UNIVERSAL CLAMPS FOR RIGID OR THINWALL CONDUIT

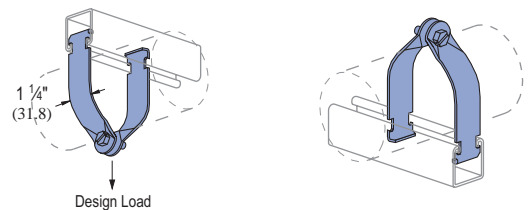

Part No.	Conduit Size in (mm)	Thickness Gauge (mm)	Wt/100 pcs lbs (kg)	Design Load lbs (kN)
P1214 DF	1¼	14	18	600
	31.8	1.9	8.2	2.67
P1215 DF	1½	14	20	600
	38.1	1.9	9.1	2.67
P1217 DF	2	14	22	600
	50.8	1.9	10.0	2.67

Slotted hex head screw and nut included.



PRODUCT INDEX

HFLW025 DF10	P1031 DF 13	P1430 DF 16
HFLW037 DF10	P1036 DF 12	P1431 DF..... 16
HFLW050 DF10	P1045 DF 14	P1498 DF 13
HHCS025075DF10	P1047 DF 14	P1546 DF 13
HHCS025150DF10	P1048 DF 14	P2072A DF 14
HHCS037100DF10	P1063 DF 12	P2072ASQ DF 14
HHCS037150DF10	P1064 DF 12	P2265 DF..... 14
HHCS050094DF10	P1065 DF 12	P2324 DF..... 14
HHCS050119DF10	P1066 DF 12	P2484 DF 13
HHCS050150DF.....10	P1067 DF 12	P2785 DF 15
HHXN025 DF10	P1068 DF 13	P2786 DF..... 15
HHXN037 DF10	P1112 DF 16	P2787 DF 15
HHXN050 DF.....10	P1113 DF 16	P2863 DF..... 12
HLKW025 DF.....10	P1114 DF.....16	P2864 DF 12
HLKW037 DF10	P1115 DF 16	P3006-1420DF6
HLKW050 DF10	P1117 DF 16	P3008 DF.....6
HRCN037 DF10	P1118 DF.....16	P3010 DF6
HRCN050 DF 11	P1119 DF 16	P3013 DF 7
HTHRO37 06DF 11	P1186 DF.....14	P3300 DF..... 7
HTHRO50 06DF..... 11	P1214 DF.....16	P3300T DF 7
P1000 DF.....6	P1215 DF 16	P4008 DF..... 7
P1001 DF6	P1217 DF 16	P4010 DF..... 7
P1000T DF6	P1271S DF 15	P4100 DF..... 8
P1001T DF 6	P1325 DF 13	P4100T DF 8
P1006-1420 DF.....6	P1346 DF 13	P5000 DF 10
P1008 DF.....6	P1380A DF 12	P5000T DF 10
P1010 DF 6	P1386 DF 15	P5508 DF 9
P1026 DF 13	P1428 DF..... 16	P5510 DF 9
P1028 DF 13	P1429 DF 16	

NEW

UNISTRUT® DEFENDER™



PROTECTION FROM
THE HARSHTEST ENVIRONMENTS

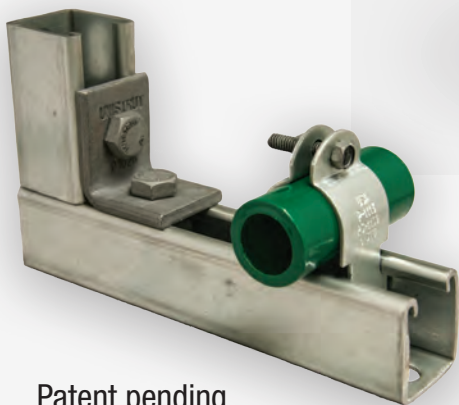

Patent pending



UNISTRUT®
DEFENDER™

unistrut.us

A PART OF **atkore**
INTERNATIONAL

16100 South Lathrop Ave
Harvey, IL 60426
TOLL-FREE / 800-468-9510

www.unistrut.us



UNISTRUT®



Columbia-MBF™



UNISTRUT®
Construction

