

TBI Installation Instructions



*Today's Fuel Injection Technology
For Yesterday's Classic*



1775 N. Lapeer Rd.

Unit B

Oxford, MI 48371

248-393-1621

www.affordable-fuel-injection.com

TBI INSTALLATION INSTRUCTIONS

Congratulations on the purchase of your “Affordable Fuel Injection” TBI system. We are confident that this purchase will give you the performance and driveability that you deserve from your vehicle. The following instructions are intended to give you the most information possible to install your TBI system. If you do not understand any part of the instructions, need clarification, or simply need more information, please e-mail us at: techinfo@affordable-fuel-injection.com. Please read through the instructions completely before beginning your installation. Many questions that you may have are covered within the following pages.

Verify that all of the components are included in your shipment.

1. Wiring Harness
2. ECM with AFI calibrated chip (the chip is already installed in the ECM).
3. Fuel Pump
4. Throttle Body
5. ECT sensor (Engine Coolant Temp)
6. MAT sensor (Manifold Air Temperature, some systems)
7. MAP Sensor (Manifold Absolute Pressure)
8. O2 Sensor with exhaust ring for installation
9. Fuse Link
10. VSS (Vehicle Speed Sensor) (optional)
11. EGR solenoid (Exhaust Gas Re-circulation)(optional)
12. Knock Sensor (optional)
13. Fuel Pump Relay
14. Power Relay
15. Check Engine Light
16. Adapter plate (optional)
17. Distributor (optional)

If you are purchasing just a harness these instructions are also included as a reference.

NOTE: THIS IS A CUSTOM FUEL INJECTION SYSTEM BUILT FOR YOUR VEHICLE. AS WITH ALL CUSTOM PROJECTS SOME FABRICATION MAY BE REQUIRED. THERE MAY ALSO BE SOMED SMALL PARTS REQUIRED THAT ARE NOT INCLUDED WITH YOUR SYSTEM.

NOTE: THE PINK WIRE (IGNITION WIRE) MUST BE HOOKED UP CORRECTLY FOR THE SYSTEM TO OPERATE PROPERLY. PLEASE READ THE INSTRUCTIONS CAREFULLY AND THOROUGHLY.

ECM

The ECM is the central unit of the fuel injection system. This unit provides the signals that trigger the injectors and on complete EFI systems delivers the proper spark for the

ignition. The ECM is to be mounted inside of the vehicle preferably behind the dash. In many cases this is mounted in the glove box area either in spare space, or even mounted to the glove box itself. The ECM should be mounted so that it does not move around in the vehicle. It can be mounted with brackets, bolts, Velcro etc.

WIRING HARNESS

The wiring harness included with this kit has been specially built for your specific application. This harness only includes the connectors and leads that are required to run your particular engine based upon what you have ordered. Therefore if something is left over, the system may not have been put together correctly. Each connector will be marked with a label to the correct sensor that it is to be connected too. We will also describe in the text to follow, each sensor and the connector that attaches to it. The wiring harness is fabricated to only allow the proper sensor to be hooked up to the proper connector. The “keying” of the connector will not allow for an improper connection.

A wire labeled “A/C” may be included on your wire harness. If your vehicle is equipped with Air Conditioning this wire is spliced into the power side of the A/C clutch. This enables an RPM increase to compensate for the load of the A/C unit. If requested this same line can be used for an onboard compressor or winch. If so equipped, this wire can be connected directly to the power side of the winch or compressor to serve the same function as the A/C line. This must be requested in advance so that the calibration chip can be set up accordingly for this purpose. A dash mounted switched 12 v source can also be used with this wire. The switch would provide 12v to this wire providing the same condition. Make sure that the switch is turned off before normal driving operation.

Fuse Protection- An orange fuse holder is included with your kit. This fuse is for protection to your vehicle and components in case of a wire grounding out or some sort of malfunction. This holder can be installed at the termination end of the Red battery wire if you are not attaching this wire to an already fused or circuit breaker voltage source.

The PINK wire needs to be attached to an Ignition 1 (battery power only with key on or in the crank position) power source. Ensure that this is an ignition 1 source. An ignition 1 source is 12volts available any time that the key is not in the off position. Also this PINK wire must have 12V while the vehicle is in the cranking mode (starting). This means the wire will have power when the key is on, or start, or back to on. Usually this wire can be taken from the power side of the coil (+) or the power from the old distributor or the fuse box. The system will not work if power is not provided to the (PINK) ignition wire while cranking.

The red wire is to be connected to a direct battery lead which has 12v always feeding it; a direct connection to the battery is the most desirable. It is important that these wires are connected to the indicated source or your fuel injection system will not operate properly. The supplied fuse link or equivalent is required for proper circuit protection.

It is very important that the ECM and components be supplied with proper voltage all the time.

IMPORTANT NOTE: Older style single wire Delco alternators do not work well with fuel injection systems. *We do not recommend or provide support for vehicles equipped with single wire alternators such as described above.* Many people like to use single wire GM Delco alternators. These alternators need to see elevated engine RPMs before they begin to charge. If you are using this type of single wire alternator, beware that you may not have the proper voltage provided to your system on initial start-up. Simply blipping the throttle will bring you up to proper voltage. We do not recommend these types of single wire alternators for fuel injection applications.

A hole needs to be drilled into your firewall to allow the harness to pass from the dash area to engine area. In some cases there may already be a hole that can be used to pass the harness through. If this is the case then use and seal up the hole appropriately. If you need to drill a hole this hole needs to be approx. 1 1/2", or whatever size you need to fill with a grommet when sealing up.

Pass the engine connector ends of the harness through the hole in the firewall or through the glove box first if mounting there.

The fuel pump wire can also go through the firewall or be run inside of the vehicle to the rear of the vehicle area for hook up. This would require a small hole in the floor pan someplace. Ensure that you have insulated it so that it cannot be grounded out to the body. It is advisable to hold off permanently placing your harness until all of the sensors and ECM have been connected.

The fuel pump relay (oval) is part of the harness on the inside of the vehicle. This relay should be mounted in a location that will keep it from moving around in the vehicle.

Included also is a power relay. This relay is used to ensure proper voltage is supplied to your system on any vehicle. Some vehicles have insufficient wiring to operate a fuel injection system. This relay connects to Ign. 1 feed to power up the relay (pink wire you connected above), and the input to the relay is battery powered. This battery lead is labeled and can be attached directly to the battery, the starter solenoid, or any other appropriate full time 12-volt supply. We have included a length of wire long enough to choose your own connection option.

An ALDL connector is another extension of the harness mounted inside of the vehicle. This connector is a two-row rectangular connector with mounting tabs on it. This is usually mounted under the dash, and available for diagnostics and scan tool hook up. This can be hooked up to a GM scan tool to monitor the sensors and retrieve trouble codes. You can use a late 80's or early 90's GM TBI definition for proper operation. For some scan tools enter VIN 10th "L" 3rd "C" 8th "K".

A wire is also provided which is connected to a check engine light. This light can be mounted in the dash, use an empty "idiot light" socket in the instrument panel, or mounted in a small bracket under the dash. It should be mounted in an area noticeable in case of any malfunctions. The wire from the ECM is the ground for the light. When a fault exists, or the system is in diagnostic mode, or the engine is not running with the key on, the light is illuminated. The other side of the light requires a 12v ignition feed that you need to supply from the fuse box, or other source.

FUEL PUMP

An external fuel pump may have been included with your TBI system. This pump delivers a constant pressure to the throttle body where it is then regulated down to 10 - 13 psi and returned to the fuel tank. This pump should be mounted to the frame or body of your vehicle in an area that will be protected from the elements as best as possible. The fuel pump should be mounted below the fuel tank fuel level for the pump to work properly. If necessary put a cover over it to keep the environment away from the pump. A fuel filter is to be installed in the fuel line **PRIOR** to the fuel pump. Premature failure of the pump can be the result of improper fuel filter installation. Some aftermarket high density fuel filters can cause a large drop in fuel pressure under load and are not recommended for use with your system. If you are using one of these types of filters insure that you have proper fuel pressure during all modes of operation.

Recent fuel pump installations have kept the vehicle's mechanical fuel pump intact and used it as scavenger pump for the electric fuel pump. With this type of installation the electric fuel pump can be mounted in any location that you would choose, as a constant fuel flow is available for the electric pump. Ensure that the fuel filter is still installed between the mechanical and the electric pump if you choose this type of fuel pump installation.

A 12 Ga. pink wire labeled "Fuel Pump", with sufficient length has been included with the wiring harness for the pump power feed. This wire comes from the fuel pump relay, which is mounted on the inside of the vehicle. ***Very important*** for proper operation of the fuel pump is the mounting and the ground. A ground wire is to be attached to a good clean body ground or run back to a battery ground. An improper ground will result in insufficient fuel flow and or premature pump failure. Mount the fuel pump in the rubber brackets supplied or similar, to keep the pump noise from radiating into the vehicle. You can use the mounting screws supplied with the pump, or supply your own to ensure proper mounting. You may want to "prime" the fuel feed line with gasoline to aid in the priming of the pump for proper operation.

FUEL LINES

A TBI fuel injection system requires two fuel lines for proper operation, a feed line and a return line. Some vehicles are built with two lines for this purpose, even with carburetors. If you are starting from scratch, you will need to install both of these lines from the fuel tank to the Throttle body. Usually a 5/16" or 3/8" line is used for the feed, and a 5/16" or 1/4" line for the return. If you do not have a place to return the fuel to the

tank within the fuel-sending unit, parts are available to return the fuel into the filler neck tube. Use only fuel line and fittings approved for fuel injection.

ADAPTER PLATE

Many of our TBI systems are installed using an adapter plate on the intake manifold to adapt a carburetor intake manifold to the TBI unit. Installation of these plates is pretty straightforward but there are some things to be aware of when installing the plate and the TBI unit. Vacuum leaks are the largest problem facing fuel injection systems and the addition of the adapter plate has the potential of providing more sources for leaks.

Before installing the adapter plate on the engine loosely bolt the TBI unit to the adapter plate with the gasket between the TBI unit and plate. Ensure that the washers are under the bolts that hold down the TBI and turn the plate over to make sure the Bolts do not extend past the bottom of the plate. If the bolts are too long there is the potential of creating a leak between the plate and the intake manifold.

When installing the adapter plate to the intake manifold be careful to not drop anything in the opening when cleaning gasket surfaces.

Lay the adapter on the manifold to get an idea how it fits. Apply a small amount of gasket sealer to both sides of the gasket one at a time. Spread it very thin with your finger to make the gasket appear wet. With the gasket on the adapter slip the adapter bolts supplied through the adapter and gasket to hold them together. Then apply a couple drops of blue locktite to the threads of all bolts. Line up to the intake manifold and start bolts by hand then tighten.

The TBI gasket in many cases should be sufficient to seal but many people have found the gasket sealer treatment as described above to eliminate any problems here as well. Ensure that all is OK with the TBI and that it has the proper clearances to the intake and other accessories before sealing it down. A small amount of blue locktite should be applied to the bolts attaching the TBI to the adapter plate. This interface is also a source of vacuum leaks and the use of blue locktite will not allow the bolts to loosen up and will prevent leaks in that location.

THROTTLE BODY

Install the throttle body on the intake manifold or adapter plate as described above. Install the throttle cable and transmission cable if so equipped. The throttle lever is universal and may require additional brackets to hold the cables and return spring or using your existing connection from your carburetor. Fabrication may need to be done on the throttle cable or throttle body to make the throttle work properly. Ensure that smooth unrestricted movement can be obtained from the accelerator pedal from idle to WOT (Wide Open Throttle). Connect the wires to the injector (s), TPS (Throttle Position Sensor), and IAC (Idle Air Control) valve. Connect a vacuum line to a full vacuum source for the MAP sensor. Usually the vacuum port on the rear of the throttle body is a

good full vacuum source to use for your MAP sensor (listed below). Plug all vacuum ports not being used; it is critical that there are no vacuum leaks.

Connect fuel lines to the rear of the throttle body. There are two different size fittings for the fuel feed. The largest is the feed, and the smaller one being the fuel return to the fuel tank. These fittings are not flare or inverted flare fittings. We have included the proper fuel line adaptors in the kit that hook up directly to the throttle body. A high-pressure fuel line can be hooked up to this and run to the fuel source (gas tank).

ENGINE SENSORS

MAP SENSOR

The MAP sensor is a very important part of the fuel injection system. This sensor sends a voltage to the ECM in relation to the amount of vacuum (pressure) the engine is creating. This signal is used in conjunction with the engine speed to infer the amount of air that is being used by the engine. This is what is called a speed/density system. Because fuel control is very dependent upon this signal it is very important to install correctly. This sensor is to be installed as close to the manifold vacuum source as possible. The port on the sensor is to face down, with the vacuum line attached. This vacuum line is to have no sags or dips and be as short of a length as possible. Some people install this sensor in the center of the firewall towards the cowl, or even under the air cleaner at times. Attention needs to be given to the connection of the vacuum line ensuring no leaks.

COOLANT SENSOR

The coolant sensor is just like it sounds; it sends an electrical signal to the ECM in proportion to the engine coolant temperature. This sensor is to be installed before the thermostat preferably in the intake manifold coolant crossover. In many instances there is an NPT fitting that is plugged that can be used to install the sensor. Connect the two-wire connector when installed. Ensure that there are no coolant leaks from the threads of the sensor. It is also important that a continuous flow of coolant is present at the tip of the sensor or a false reading and engine damage can occur.

INTAKE AIR TEMPERATURE SENSOR, (if equipped) an IAT sensor may be part of your system if your system is from a vehicle that was originally equipped with one. This sensor is to be placed to measure the temperature of the air in the intake manifold or the air tube feeding the air cleaner. This sensor monitors the temp. of the air coming into the engine and adjusts spark and air calculations accordingly.

OXYGEN SENSOR

The oxygen sensor is installed in the exhaust pipe and samples the exhaust to determine if the engine is running rich or lean of 14.7:1 air/fuel ratio. The O2 sensor should be installed as close to the engine as possible. If you are installing headers, the sensor should be installed in the collector. A threaded boss has been included with your kit that needs to be welded into the exhaust pipe to hold the O2 sensor. Placement of this boss should always be in a position that is somewhere between horizontal to vertical. In no

instance should the sensor wire be pointed in a position that would be considered facing down. Many muffler shops are equipped to install these sensors if you are looking for someone to install it.

CRANK INPUT

A wire labeled “CRANK SIGNAL” is to be installed on the crank terminal of the starter solenoid or off the ignition switch. A signal is provided to the ECM from this wire only when the engine is cranking. The ECM, to determine when the engine is cranking, uses this signal to allow the fuel pulse width to be expanded for cold start up fuel enrichment.

ENGINE GROUND

An eye terminal with 1-3 black wires and labeled “engine ground” needs to be properly attached to the engine block. It is very critical that a proper ground is used for this input to the ECM and that it is mounted to the engine itself. Many people attach this to one of the bolts on the back of the intake manifold; this works fine. ***It is most critical that this is a connection going to a bare grounding surface and not a painted surface. It is a good idea to run an extra ground wire from the negative (-) on the battery to the ground wire coming from the ECM (from the wire harness Engine ground). Make sure that the ground from the engine to the body of the vehicle is intact. An improper ground will not allow the system to operate properly.***

DISTRIBUTOR

Your fuel injection system requires one of several different ways to trigger the ECM and control spark. If you are installing a complete EFI system it will include a distributor. If this is the case simply install your distributor and plug in the 4-pin connector to the distributor from the wiring harness.

If you are using the small distributor cap system an external coil is required that is not included with your system. A high energy coil rated for electronic ignition needs to be used. A coil that was for an engine with points is not sufficient for a fuel injection system. There will be two more wires required to operate the coil. These two wires are provided and marked “coil – and 12 volts”. The wires will be pink and white; the white wire connects to the negative terminal of the coil and the pink wire attaches to 12 volts which can also be taken from the positive side of the coil. Your original engine had a “hot” or “12 volt” wire that was used for the distributor or coil. This wire should be used to power the coil for your fuel injection system.

If you are using an MSD or other after market ignition system without an ECM controlled distributor you will only have control of the fuel for your engine; however your ignition module will provide the trigger to the ECM. Simply hook the tach output from the module to the wire labeled “tach input“ on the wiring harness.

If this installation is using an electronic ignition system that is part of your vehicle already, a tach filter will be used. A wire marked “tach input“ will be part of your wiring harness and connects to the “-“ terminal of the ignition coil or the tach lead of your MSD or Jacobs ignition module as mentioned in the previous paragraph.

FINAL CHECKS AND START UP

After you have finished the above installations you are ready to check the system for operation. Turn the ignition key to the "ON" position, but do not start the vehicle. The fuel pump should turn on for about 2 seconds and then turn off. If this does not happen see #7 below in troubleshooting. Leave the ignition in the "ON" position until the fuel pump has turned off. Turn the ignition off for at least 10 seconds and repeat the ignition cycle. Perform this operation 2 or 3 times to allow fuel to fill the system preparing to start. Inspect all fuel lines and connections to ensure there are no fuel leaks.

Assuming no fuel leaks, you are ready to start the engine. Do not press on the accelerator pedal to start the engine. The IAC valve will provide the proper amount of air for the vehicle to start and run. Start the engine and let it idle; it may take a bit to run smoothly. At this point your timing has not been set, the control system has not "learned" the engine and the IAC valve has not learned its proper position. These are all functions of the fuel injection system that happen after the engine has been running.

If you have access to a scan tool use a hook up for a 1990 350 cu. in. 5.7L Chevrolet truck. For some scan tools enter VIN 10th "L" 3rd "C" 8th "K"

If you have installed a new distributor or manifold, you will need to set the timing. This is accomplished by disconnecting the single lead wire electrical connector breaking out of the harness near the distributor. With this wire disconnected, set your timing to "0" deg. for most applications. Big Block installations should have the initial timing set to "6" deg. BTDC. The ECM does all of the timing for you and uses the reference of "0" or "6" degrees to properly deliver the correct spark angle. With the set timing wire disconnected, your check engine light will illuminate and set a code "42" EST malfunction. After the timing has been properly set, reconnect the single lead wire and turn the vehicle ignition off. Wait for at least 10 seconds and restart the vehicle. The ECM will not control the timing until the vehicle has been turned off and restarted with the connector in proper position. If you choose you can clear the code "42" by disconnecting the battery lead to the ECM for at least 10 seconds.

If your system is equipped with a tach filter and not using the ECM controlled distributor set ignition timing to the factory specifications for your engine.

Restart the engine and let it idle for a while. Insure that there are no fuel or vacuum leaks while running and that the idle appears to be controlled by the ECM. The engine speed will be higher while cold and first started and will come down to a base idle on its own. Do not turn the idle adjustment screw on the Throttle Body, this screw is pre-adjusted and does not need to be tampered with for most standard engines. If the engine will not idle properly check for vacuum leaks, proper timing setting, or a check engine light illuminated. If all of these checks have been made and you are experiencing a problem

go to troubleshooting guide #10 to further diagnose the issue. When you are confident that all is running properly, you may shut it down and complete the remainder of the installation.

Secure any wires that you may choose, ensuring they are routed away from exhaust manifolds, cables, etc. You can seal the wiring harness to the firewall at this time when you are confident of the amount of wire required running into the engine compartment. You may want to fit the plastic loom around the main portion of the wiring harness to seal the grommet to the wires. Depending on how many wires are included with your harness, it may be necessary to tape up the wires in the main portion of the harness to seal to the grommet provided or one that you have provided.

Install an air cleaner and you should be ready for operation. A standard air cleaner in some instances will not clear the injectors and the throttle linkage. This will require a spacer to be used between the throttle body and the air cleaner assembly. If you will be operating the vehicle in below freezing temperatures, you may want to install a heat riser from the exhaust manifold to prevent throttle body freeze up. Ensure that the heat riser is attached so that it allows for warm air only during start-up and extremely cold operation and allows unheated air during all other operations.

Once you have installed your Affordable Fuel Injection system you will enjoy the modern technology of fuel injection system for years to come. You will enjoy a low maintenance system that provides good drivability and adjusts for towing, altitude, severe angles, off roading and other normal drive situations. The biggest advantage of EFI is dependability and drivability. EFI for the most part is relatively maintenance free once installed and working properly. The sensors are robust and provide for many miles of maintenance free operation. EFI also provides seamless drivability. The system takes care of all of your engine functions whether it is -20 deg. Or 100 deg, at sea level or climbing Pikes Peak There is no stalling and waiting for the choke to come off for most stock and slightly modified engines. Drivability is in most cases a given and allows for good response and power in all driving conditions.

Thanks from Affordable Fuel Injection!

Troubleshooting your TBI Fuel Injection System

Most of the problems encountered while installing your fuel injection system or after a time of operation are very simple. If your check engine light is on you more than likely have a hard fault meaning something is grounded out, unplugged, operating out of range or has gone bad. See below for how to determine what your fault may be and what the codes mean.

With the addition of Fuel Injection to your engine it is important to remember that the basics are still there, necessary and have not changed. Batteries must be fully charged, charging systems fully operational, the ignition system is fully operational and the integrity of the engine is intact. All of these items are common to an engine and need to be in full operational condition regardless of the fuel system that has been added to your engine.

The ALDL connector allows for full diagnostics of your unit. A scan tool can be used and set up for a GM TBI application to read the data, or to check for stored codes. Consult a service manual or see below for any check engine light code definitions. You can use a late 80's or early 90's GM TBI definition. If you have access to a scan tool use a hook up for a 1990 350 cu. in. 5.7L Chevrolet truck. For some scan tools enter VIN 10th "L" 3rd "C" 8th "K".

If you have installed a Fuel Injection system in your vehicle and are having some initial issues here is a quick checklist to work from to get you started.

Pink Ignition wire MUST be connected to 12 volt switched ignition that receives power during crank and key on.

1. Check to make sure your check engine light is not on, or that it is on with the key on but the engine is not running.
2. Make sure that the red battery wire is connected to a battery source (It is highly recommended that this wire is connected directly to the battery) and the pink wire is connected to an ignition 1 source. If your ignition wire is not connected to an ignition 1 source your ECM will not be powered while cranking the engine.
3. Check that the ground wire is securely fastened to the block and that the interface between the block and the terminal are clean.
4. Ensure that there are **NO** vacuum leaks.
5. Ensure that your MAP sensor is connected to a full manifold vacuum source and not a ported source.
6. Set the ignition timing correctly making sure that you disconnect the set timing connector to set it. In some cases you cannot set the timing with the connector disconnected and keep the engine running. If this happens set timing to 15 degrees, allow the engine to fully warm up, then disconnect the set timing connector to set the base timing to the correct specification.
7. Ensure that you have full manifold vacuum routed to your fuel pressure regulator (if equipped on MPFI systems) and there are no vacuum leaks with this connection.
8. Check your fuel pressure to ensure that you are providing the proper pressure to the system.

Fuel Pressure is critical for proper operation. Fuel tank must be free from debris and fuel pressure needs to be constant and consistent.

Some aftermarket high density fuel filters can cause a large drop in fuel pressure under load and are not recommended for use with your system. If you are using one of these types of filters insure that you have proper fuel pressure during all modes of operation.

99% of all issues are usually taken care of with one or more of these 8 steps of diagnosis.

First and foremost the engine and fuel injection system must be free from vacuum leaks. Vacuum leaks are the leading cause of installation issues with your fuel injection system. Check all sources of potential vacuum leaks including components not related to the fuel injection system.

There are instances where the vacuum leak is coming from the adapter plate used to attach the throttle body to the manifold. If this is the case make sure that the seal is positive between the manifold and the adapter plate; also between the adapter plate and the throttle body. In some instances it is necessary to seal these with silicone to provide a positive seal.

Another common issue is a lack of good grounding. Many issues have been resolved simply by making sure that the ground path is secure and clean.

Fuel System Checks

Fuel Pressure is critical to the operation of a fuel injection system. Always check to insure that you have the proper fuel pressure. Fuel pressure should be a constant 10 – 15 PSI on a TBI fuel injection system and is typically around 12 – 13 psi. Higher pressure than 15 psi can indicate that there is an issue with the installation. Many times this is due to kinked fuel lines, improper routing of the return line and/or fuel line restrictions. (See Part 3 of Troubleshooting guide #3) With some higher performance and large displacement engines the fuel pressure could be as high as 20 psi, this is not the norm however but an exception. Many fuel tanks have fittings on them which are used for a fuel tank vent. These fittings are not suitable to use as a return line because they have an orifice in them and restrict the flow of fuel back to the tank. If you have installed your return line to a "vent" line you will need to route the return line in a different fashion.

Fuel pressure on a TBI unit should stay constant under all throttle conditions. There should be less than 1 psi of pressure difference from idle to WOT operation of the TBI unit. A pressure drop of more than 1 psi under these conditions indicates an issue with the fuel delivery system.

With retrofit fuel injection systems many times we are drawing fuel from gas tanks that are many years old; hence many years have passed where contamination can settle into the fuel tank. The electric fuel pump installed for a fuel injection system will draw considerable more volume of fuel from your tank than your old system did. If there are any contaminants in the tank this many times will plug up or greatly restrict the flow of fuel to the system causing many issues.

Step by Step Troubleshooting guide.

Your fuel injection system has been pre calibrated to your particular vehicle. As long as the information about your engine was correctly stated, the system as received will provide many years of trouble free use. However from time to time problems are encountered with your fuel injection system. Here are a few commonly asked questions about fuel injection problems. Match the issue # with the chart below for an explanation of the issue and use the troubleshooting fault tree.

Use of this section may require a digital voltmeter, test light, fuel pressure gauge, timing light, tachometer and/or a diagnostic scan tool. If you are familiar with vehicles and how they are serviced you should be able to work through this section with no issues. In many instances you

may want to have a professional automotive technician familiar with fuel injection repair to help you.

1. **My engine cranks but will not start.**
2. **My engine is running to lean, or is backfiring on acceleration.**
3. **My engine is running rich.**
4. **I do not seem to have as much power as I should.**
5. **I am getting a sag when I accelerate.**
6. **My engine takes longer to start than I think it should.**
7. **The fuel pump is not coming on when I first turn the key on.**
8. **The RPM on my engine does not come down when I come to an idle.**
9. **I am not getting as good of fuel economy as I think I should.**
10. **The engine is revving up and down when I come down to an idle. There is a large "sucking" sound coming from the throttle body when it is warmed up. My engine stalls or almost stalls when I come down to an idle.**
11. **My fuel pump is real noisy.**
12. **My check engine light does not come on when I turn the key on.**
13. **My check engine light is flashing fast all the time.**
14. **My check engine light is on when the engine is running.**

1. Engine cranks but will not start.

There is an assumption that the battery is at a full state of charge, the fuel tank has fuel in it and that all sensors are correctly connected and there are no trouble codes in the ECM.

1. Does the injector spray fuel when cranking the engine?

Yes – Go to step 2.

No - Remove one of the injector connectors from an injector. With a voltmeter or test light measure the voltage or validate power to the pink wire of the connector with the key on.

Yes – Pink wire has voltage, go to step 1a.

No – There is no power getting to the system. Check for proper connection to the battery, fuses are good, relays have been connected and seated properly. Correct the power issue; if there is still no fuel spray when cranking the engine after this has been corrected go to step 1a.

1a. With the voltmeter or test light still connected crank the engine and verify voltage to the pink wire on the injector connector.

Results: "0" volts or the light goes out when cranking the engine.

The primary (pink) ignition wire is incorrectly connected to the vehicle. This is to be an ignition 1 (ING1) source which is power in both the key run and crank position. Correct the connection of this wire and verify voltage to the pink wire on the injector connector. Test again for fuel spray during crank. If the engine still cranks, is spraying fuel, but will not start go to step 2.

"Low volts, < 8" This is an indication of either a battery in a state of very low charge, a bad battery or too much resistance in the system.

-record the battery voltage while cranking at the battery.

-record the voltage at the pink wire of the injector connector while cranking the engine.

-compare these two voltages, they should be within .2 (2/10) volts of each other. If these voltages are greater than .2 there is a bad

connection or too much resistance in the wire feeding the ECM.
-Correct the issue with low voltage. If cranking voltage is above 9 volts while cranking and there is still no fuel spraying the issue is in the fuel delivery system.

"9 volts or higher" this is normal cranking voltage. If there is no fuel spraying while cranking the issue is in the fuel delivery system or ignition system. Troubleshoot the fuel system for improper operation (See Fuel System checks at the beginning of this guide). Troubleshoot ignition system, go to 1b.

1b. Your TBI fuel injection system fueling is "triggered" from the ignition system. It is assumed that the coil is operational, a 12 volt ignition 1 (IGN1) source is connected to the positive terminal of the coil for external coil applications or to the positive slot for coil in cap applications.

Remove plug wire and check for spark while cranking.

No Spark – Repair ignition system.

Has spark – Insure wire continuity between the ECM and the distributor or tach Filter. If fuel is still not spraying go to fuel system troubleshooting before replacing any components. If all wires are in tact and routed correctly and all fuel system checks are correct, replace distributor module or tach filter.

2. Perform the fuel system checks found at the beginning of this troubleshooting Guide. If the fuel pressure and fuel system are operating as required Insure that the check engine light is on with the key on but the engine not running and there are no stored codes (except for code 42 if you have just set the ignition timing or code 12). If you have installed a new distributor, removed the distributor for any reason your ignition timing may be off too much to operate the engine properly. Disconnect the connector(s) from the injectors and set the ignition timing to its proper setting while cranking the engine. Assumption here also is that the timing mark on the balancer is lined up with TDC of #1 cylinder and that the distributor is seated properly and not 180 degrees off. If all of this checks OK go to step 3.

3. Measure the voltage on the throttle position sensor. If using a scan tool you can read TPS, if not measure the voltage. To measure the throttle position voltage check between the brown wire and the black/white striped wire on the TPS with the TPS still connected and the key on. DO NOT PUNCTURE THE WIRES to measure this voltage and only use a digital voltmeter. Voltage can be measured by back probing the TPS connector between these wires either with a thin paper clip or appropriate tool used for this type of measurement.

If you have gone through all of the above procedures and the engine still will not start you will need to call tech support. In many cases the specifications of the engine are different than what was originally discussed or assumed. When you call tech support you will need to have the following information available.

Fuel pressure at the inlet of the TBI unit_____

Return line fuel pressure_____

Voltage measured at the battery while cranking_____

Voltage measured at the pink wire on the injector while cranking_____

Voltage measured at the TPS sensor key on engine off_____

Codes stored in the ECM

Any information that you feel is important for diagnosing the issue at hand.

2. My engine is running to lean, or is backfiring on acceleration.

Assumption here is that all plug wires are installed properly, the secondary ignition system (plug wires, coil, cap and rotor) is in good operating order and the engine is in good order.

Perform fuel system checks found at the beginning of this guide.

Check initial ignition timing again.

If the timing is OK check to insure that the timing is advancing as it should with throttle lever actuation.

If the fuel system checks performed are OK and the initial ignition timing is OK we may not have been given the proper information to build your system and you will need to call tech support.

If you have gone through all of the above procedures and the engine is still running lean or is backfiring on acceleration you will need to call tech support. In many cases the specifications of the engine are different than what was originally discussed or assumed. When you call tech support you will need to have the following information available.

Fuel pressure at idle _____
Fuel pressure while briefly accelerating the engine to WOT _____
Return line fuel pressure _____
Voltage measured at the battery while running _____
Engine operational temperature _____
Initial ignition timing _____
Timing at 2000 RPM _____

Any information that you feel is important for diagnosing the issue at hand.

3. Engine runs too rich.

Check for vacuum leaks and insure that all vacuum leaks are corrected and sealed. If the engine is also running at a higher than expected idle this is a good indication of a vacuum leak as well.

1. Is the vacuum line to the MAP sensor securely fastened to both the MAP sensor port and the port on the throttle body?

Yes, If engine is still running rich go to step 2.

No – Repair leak, kink or routing, is engine still running rich? If yes go to step 2.

2. Is the MAP sensor connected to a full manifold vacuum port? For 2 bbl. units this will be the port on the back of the throttle body between the two fuel lines or the far left port on the front side of the throttle body as you are looking at the front of the throttle body. (see picture) On a 1 bbl. unit this is ????????????????????

Yes – If engine is still running rich go to step 3.

No – Correct the vacuum source issue, if the engine is still running rich go to step 3.

3. Is the fuel pressure measured at 12 psi "+" or "-" 1 psi while running?

Yes – If the engine is still running rich go to step 4.

No – Is the return line connected to an unrestricted return port on the fuel tank?

Many fuel tanks have a port on the fuel tank that is for a fuel vent. These ports are not adequate for a fuel return. There is an orifice in these ports that will restrict the flow of fuel. Check that you have not used a vent port for the fuel return line.

No – Go to step 3a.

Yes – Fuel is being returned to a vent line. Re-route fuel return line to a non orificed port or fabricate a free flowing return line port to the fuel tank or fuel return. If still running rich go to step 3a.

3a. Measure return line fuel pressure. This pressure should be less than 3 psi, if not there is a restriction in the return fuel line. If return fuel line pressure is less than 3 psi and the engine is still running rich go to step 4.

If return line pressure is not less than 3 psi there is a restriction in the fuel line. Find and repair the restriction until the fuel pressure on the return line is less than 3psi. In some cases this requires a larger diameter fuel return line. Go to step 3b to help determine root cause of increased return line pressure.

3b. Remove the fuel return line and attach a length of rubber hose of sufficient length to run into an approved gasoline container. Run engine and recheck fuel pressure on both the feed side and the return side. If both sides are within the above ranges there is a restriction in the fuel delivery system that needs to be repaired.

4. Does the engine have a fully operational thermostat?

Yes – insure that the engine will reach 180 deg. in a reasonable time, go to step 5.

No – Install new thermostat, proper size thermostat will be 180 or higher. 160 degree in many cases is OK but the preference is 180 or higher. If still running rich go to step 5.

5. Is the coolant sensor installed in a portion of the engine or the cylinder block which provides a constant flow of coolant over the tip of the sensor?

Yes –Go to step 6.

No – Reinstall the coolant sensor in a different location to insure constant flow of coolant over the sensor. If still running rich go to step 6.

6. Is the charging system operating properly and is the voltage measured at the battery and the injector 13 volts or higher with the engine running?

Yes – Go to step 7.

No – Repair charging system. Note the discussion about older style AC Delco single wire alternators. If still running rich after repairing go to step 7.

7. If you have gone through all of the above procedures and the engine is still running rich you will need to call tech support. In many cases the specifications of the engine are different than what was originally

discussed or assumed. When you call tech support you will need to have the following information available.

Fuel pressure at idle _____
Return line fuel pressure _____
Voltage measured at the battery while running _____
Voltage measured at the pink wire on the injector while cranking.
Engine RPM at start up idle on a cold start _____
Engine RPM at idle with stabilized temperature _____
Engine operational temperature _____
Initial ignition timing _____
Any information that you feel is important for diagnosing the issue at hand.

4. I do not seem to have as much power as I should.

Verify that you have set your timing properly by disconnecting the set timing connector, setting the timing to the specified value, reconnecting the connector and shutting the engine off and starting it back up before proceeding. For tach filter applications insure that the timing is set to factory specifications and that both the mechanical and vacuum advance units are operating properly. In some instances you can advance your timing an additional 4 – 5 degrees and evaluate. If you do not have any spark knock this setting may be OK for your application. Evaluate for spark knock and return the ignition timing back to its base at any time you may encounter spark knock.

Ensure that your plug wires are properly connected with the correct firing order.

Your fuel pressure may be insufficient; see fuel system checks at the beginning of this guide.

Verify that there are no vacuum leaks and that the MAP sensor is properly connected.

5. I am getting a sag when I accelerate.

Timing is a critical issue with sags. Verify that your timing is correctly set by disconnecting the set timing connector and properly setting the timing; see #4 also.

Fuel pressure is not adequate for proper operation, make sure that there is no contamination in the tank or your fuel filter is plugged. (See Fuel System check above). A plugged fuel filter may be an indication of a contaminated tank.

Bad ground to the block, insure that the surface that you are making the connection to on the block is clean and making a positive connection.

Your O2 sensor may be contaminated, bad or not properly installed in the exhaust.

You may have left out some of the important specifications for the proper calibration chip to be made.

If you have gone through all of the above procedures and the engine is still sagging on acceleration you will need to call tech support. In many cases the specifications of the engine are different than what was originally discussed or assumed. When you call tech support you will need to have the following information available.

Fuel pressure at idle _____
Fuel pressure when throttle is blipped to WOT _____
Return line fuel pressure _____
Voltage measured at the battery while running _____
Voltage measured at the pink wire on the injector while cranking. _____
Engine RPM at start up idle on a cold start _____
Engine RPM at idle with stabilized temperature _____
Engine operational temperature _____
Initial ignition timing _____
Any information that you feel is important for diagnosing the issue at hand.

6. My engine takes longer to start than I think it should.

Check for vacuum leaks, this is the most common cause.

Make sure that your timing is set correctly; see Troubleshooting point #4.
Fuel pressure is not adequate for proper operation. See Fuel System Checks at the beginning of this guide.

Fuel pump relay is not coming on or is faulty.

On a TBI system verify that the crank wire is connected to the crank side of the ignition switch or the crank side of the starter solenoid.

Check that the MAP sensor is properly connected to a full manifold vacuum source. Ensure that the vacuum source to your MAP sensor is free from restrictions and has a secure connection.

Throttle plates are not adjusted properly not allowing an adequate amount of air for starting the engine. Go to Troubleshooting guide #10 and verify the adjustment.

Throttle position sensor is out of adjustment or faulty. Throttle position voltage with throttle fully closed with the key on should be .5 volts +/- .2 volts.

If you have gone through all of the above procedures and the engine is still sagging on acceleration you will need to call tech support. In many cases the specifications of the engine are different than what was originally discussed or assumed. When you call tech support you will need to have the following information available.

Fuel pressure at idle _____
Voltage measured at the battery while running _____
Voltage measured at the pink wire on the injector while cranking _____
Voltage measured between the black wire and brown wire on the TPS with the key on engine not running _____
Engine RPM at start up idle on a cold start _____
Engine RPM at idle with stabilized temperature _____
Engine RPM at idle with IAC fully seated or blocked off. _____
IAC counts at stabilized idle in drive if using a scan tool _____
Engine operational temperature _____
Initial ignition timing _____
Any information that you feel is important for diagnosing the issue at hand.

7. The fuel pump is not coming on when I first turn the key on.

Is the check engine light on with the key on engine off? (Assumes check engine light is connected properly, see installation instructions to verify check engine light installation)

Yes - Go to step 1.

No – Check for proper installation of check engine light.

- a. Check fuses to insure that they are not blown. If fuses are OK go to b.
 - b. Check voltage at check engine light, if 12 volt are not present the check engine light is not connected properly. If 12 volts are present either the ECM is not powered properly or is defective.
1. Insure that the IGN1 wire is not connected to a battery feed.
 - a. Check pink wire to the power relay and/or the pink wire powering up the injector(s) to insure there is no voltage with the key off. If voltage is present with the key off the pink wire is not properly connected or the power relay is bad.
 - a. Check fuel pump relay for proper operation.
 - Turn ignition off for at least 15 seconds.
 - Connect voltmeter or test light to the blue wire at the fuel pump relay.
 - Turn ignition on, voltage should be present at this wire for the first 2 or 3 seconds after turning on the ignition switch.
 - If voltage is not present either the ECM is not powered or grounded properly or the ECM is faulty.
 - If voltage is present check for voltage at the fuel pump with the same type of operation.
 - If voltage is not present at the fuel pump check the wiring, if wires appear to be OK replace the fuel pump relay.
 - If voltage is present verify the ground for the fuel pump is sufficient and securely fastened. If fuel pump ground is OK the fuel pump is defective.

If you have gone through all of the above procedures and the fuel pump is still not coming on when you turn the key on you will need to call tech support. When you call tech support you will need to have the following information available.

Voltage measured at the check engine light with key on engine off _____

Voltage measured at the pink wire on the injector while cranking _____

Voltage measured at the pink wire on the injector with the key off _____

Voltage measured at the blue wire at the fuel pump relay at first 3 seconds of the key on _____

Voltage measured at the pink wire to the fuel pump at the first 3 seconds of the key on _____

Voltage measured with voltmeter between the black wire and pink wire on the fuel pump for the first 3 seconds of the key on _____

Any information that you feel is important for diagnosing the issue at hand.

8. The RPM on my engine does not come down when I come to an idle.

- More than likely you have a large vacuum leak, verify that your system is free from vacuum leaks.
- Check that all non used vacuum ports are plugged.

- Verify that the bolts holding down your throttle body are not protruding through the bottom of the adapter plate causing the plate to lift off its base.
- Your ignition wire is connected to a battery source and not an ignition 1 source.
- The engine has not come to full operating temperature as of yet.
- Your thermostat is inoperable or opens at too low of a temperature. You should be using at least a 180° stat.
- Throttle cable or throttle on the throttle body is not coming to a complete close. Throttle plate is binding in the throttle bores.
- The throttle plates are adjusted too far out, see procedure #10 for proper adjustment sequence.
- IAC is not working, either faulty or there is a wiring issue.

If you have gone through all of the above procedures and the engine is still idling too high you will need to call tech support. When you call tech support you will need to have the following information available.

Voltage measured between the black wire and brown wire on the TPS with the key on engine not running_____

Engine RPM at start up idle on a cold start_____

Engine RPM at idle with stabilized temperature_____

Engine RPM at idle with IAC fully seated or blocked off._____

IAC counts at stabilized idle in drive if using a scan tool_____

Engine operational temperature_____

Initial ignition timing_____

Any information that you feel is important for diagnosing the issue at hand.

9. I am not getting as good of fuel economy as I think I should.

If all is set up properly with the installation of your fuel injection system you are probably getting as good of fuel economy as you are going to get.

1. Insure that your timing is set properly
2. Your thermostat is in good working order
3. Your fuel pressure is at the specified pressure (see fuel system check at the beginning of this guide.
4. You may have other factors such as tires, brake drag or other external issue from the fuel injection system that is not working properly.
5. Re-evaluate your driving habits and insure that you are driving in a fashion that will provide you optimum fuel economy. If you are trying to race everyone from the light chances are you will not get the fuel economy that you expect.

If you have gone through all of the above procedures and you still feel that you should be getting better fuel economy you will need to call tech support. In many cases the specifications of the engine are different than what was originally discussed or assumed. When you call tech support you will need to have the following information available.

What is the Fuel Economy that you are getting_____

What is the Fuel Economy that you are expecting_____

Voltage measured at the battery while running_____

Voltage measured between the black wire and brown wire on the TPS with the key on engine not running_____

Engine RPM at idle with stabilized temperature_____

Engine operational temperature_____

Initial ignition timing_____

Trouble Codes from the ECM (see #14)_____

Any information that you feel is important for diagnosing the issue at hand.

10. The engine is revving up and down when I come down to an idle. There is a large “sucking” sound coming from the throttle body when it is warmed up. My engine stalls or almost stalls when I come down to an idle.

This is usually an indication of a vacuum leak; again make sure that you have no vacuum leaks.

This could also be an indication of the wrong base ignition timing. Verify that you have set your ignition timing correctly (see #4).

Your engine may also require more air going through the throttle plates at idle than it is currently set for. Here is a procedure to check this setting.

- a. Make sure your engine temperature is at full operating temperature.
- b. Jumper Pins A & B of the ALDL connector (A paper clip works) with the key on but the engine off. This is the same thing you do when checking for engine codes and your check engine light will flash off and on.

ALDL CONNECTOR

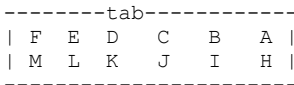

- c. Wait about 45 seconds or until any trouble codes present have flashed through; code 12 is normal. After this then unplug your IAC valve which is on the throttle body but do not turn off the key.
- d. Remove the jumper from the ALDL, turn the key off, wait 15 seconds and start the engine still with the IAC unplugged. It may start hard and you may have to depress the throttle pedal a little bit to start the engine.
- e. If you have a fast idle this did not work or you have a vacuum leak that is not repaired, or the throttle plates are already too far open. You may have to tape over the fresh air hole that the IAC receives its air from.
- f. If you do not have a fast idle then it is OK and you can proceed to adjust the throttle plates. Let the engine idle for a little bit and then check your idle speed. The speed should be about 575 – 600 at idle in drive or about 750 rpm in neutral. If it is lower than this you can raise the idle up or if it is above this determine if you should bring the speed down. More than likely it will always be lower.
- h. Using the screw on the front of the throttle body, adjust your base idle speed without the IAC operational. Base idle for your setup should be:

_____ **Drive** _____ **Neutral**

- i. If you have done all of this and you still have an issue we may not have received all of the proper information to build your chip and you will need to call tech support.

If you have gone through all of the above procedures and the engine is still idling too high you will need to call tech support. When you call tech support you will need to have the following information available.

Voltage measured between the black wire and brown wire on the TPS with the key on engine not running_____

Engine RPM at start up idle on a cold start_____

Engine RPM at idle with stabilized temperature _____
Engine RPM at idle with IAC fully seated or blocked off. _____
IAC counts at stabilized idle in drive if using a scan tool _____
Engine operational temperature _____
Initial ignition timing _____
Any information that you feel is important for diagnosing the issue at hand.

11. My fuel pump is real noisy.

If your fuel pump is real noisy you may not have isolated it from the body or the frame real well. Isolation brackets were provided with your fuel pump. If these are properly installed it should isolate any radiated noise from the pump. If this is insufficient you may need to isolate it more with some rubber grommets.

We have also diagnosed noisy fuel pumps with fuel return lines being too small. By stepping up the size of the return line you may eliminate fuel pump noise after the other items have been addressed. Fuel pump noise also can radiate through the fuel lines to the frame or body of the vehicle. Insure that the fuel lines are isolated as well if need be to eliminate the noise.

A noisy fuel pump can also be an indication that it is starving for fuel. Insure that all filters are in good order and that the fuel tank sock is clean. Prolonged fuel starvation will damage the fuel pump and not allow proper flow; it may also radiate a lot of noise.

12. My check engine light does not come on when I turn the key on.

Your check engine light should illuminate when you turn the key to the on position for a bulb check.

Check for proper installation of check engine light.

- a. Check fuses to insure that they are not blown. If fuses are OK go to b.
- b. Check voltage at check engine light, if 12 volt are not present the check engine light is not connected properly. If 12 volts are present either the ECM is not powered properly or is defective.
- c. If the fuse is OK insure that you are receiving 12 volts to the ECM where indicated (see wiring diagram provided) If you are not receiving 12 volts to the ECM something in the vehicle's power circuit is not connected properly.
- d. If 12 volts is available at the proper cavities of the ECM please check that you have a proper ground circuit to the engine block.

If you have gone through all of the above procedures and the fuel pump is still not coming on when you turn the key on you will need to call tech support. When you call tech support you will need to have the following information available.

Voltage measured at the check engine light with key on engine off _____
Voltage measured at the pink wire on the injector while cranking _____
Voltage measured at the pink wire on the injector with the key off _____
Any information that you feel is important for diagnosing the issue at hand.

13. My check engine light is flashing fast all the time.

A constant rapid flashing check engine light indicates that you have a fault in the ECM and it is operating in back up or limp home mode. Make sure that the calibration chip is in the ECM and there are no bent pins on the chip. If the chip is properly installed and there are no bent pins the ECM or the chip is faulty and needs to be replaced or repaired.

14. My check engine light is on when the engine is running.

A check engine light indicates a hard fault with your fuel injection system.

Insure that all of your sensors are connected, you have a good ground and that no wires are pinched.

Also insure no vacuum leaks and that your MAP sensor is connected to a full manifold vacuum source.

If all of these steps indicate a proper installation and no issues you will need to read the codes from the memory area of the ECM and follow the diagnostic procedures for that particular code.

If you have a scan tool this is very easy. If you do not have a scan tool you can use your check engine light to output the fault codes. Below you will find this procedure along with a definition of all the different fault codes that can be output.

THE CONNECTOR

```
-----tab-----  
| F E D C B A |  
| M L K J I H |  
-----
```

To Display Trouble Codes

Run a wire (I use a paper clip that is in a "U") from Pin A to Pin B with the ignition on but the engine not running. The "Check Engine " light will flash in the following sequence: flash, pause, flash-flash, long pause flash, pause, flash-flash, long pause flash, pause, flash-flash, long pause. This is a code "12" which will always be there. After this series of flashes and pauses any stored trouble codes will now flash. If you do not see the "12" flash three times, your diagnostic circuit is defective.

Vehicles will display stored trouble codes, then "12" again, followed by energizing "most system controlled relays." The fuel pump relay will not energize. The idle air control valve will fully extend to enable checking minimum idle speed.

CLEARING THE TROUBLE CODES

Turn the keyswitch to the off position. To clear any trouble codes, disconnect the battery for 30 seconds or unplug the connectors to the ECM. If this is done at the battery, and your car stereo is equipped and programmed with a four digit pin code, you may have to re-enter that as well to use your stereo again. A better place to remove power is at the fuse.

TROUBLE CODES

12. No reference pulses to Electronic Control Module (ECM). The code is always flashed when checking codes and only indicates that the engine is not running.

13. Oxygen sensor signal stays lean during warm engine cruise, your O2 sensor could be unplugged.

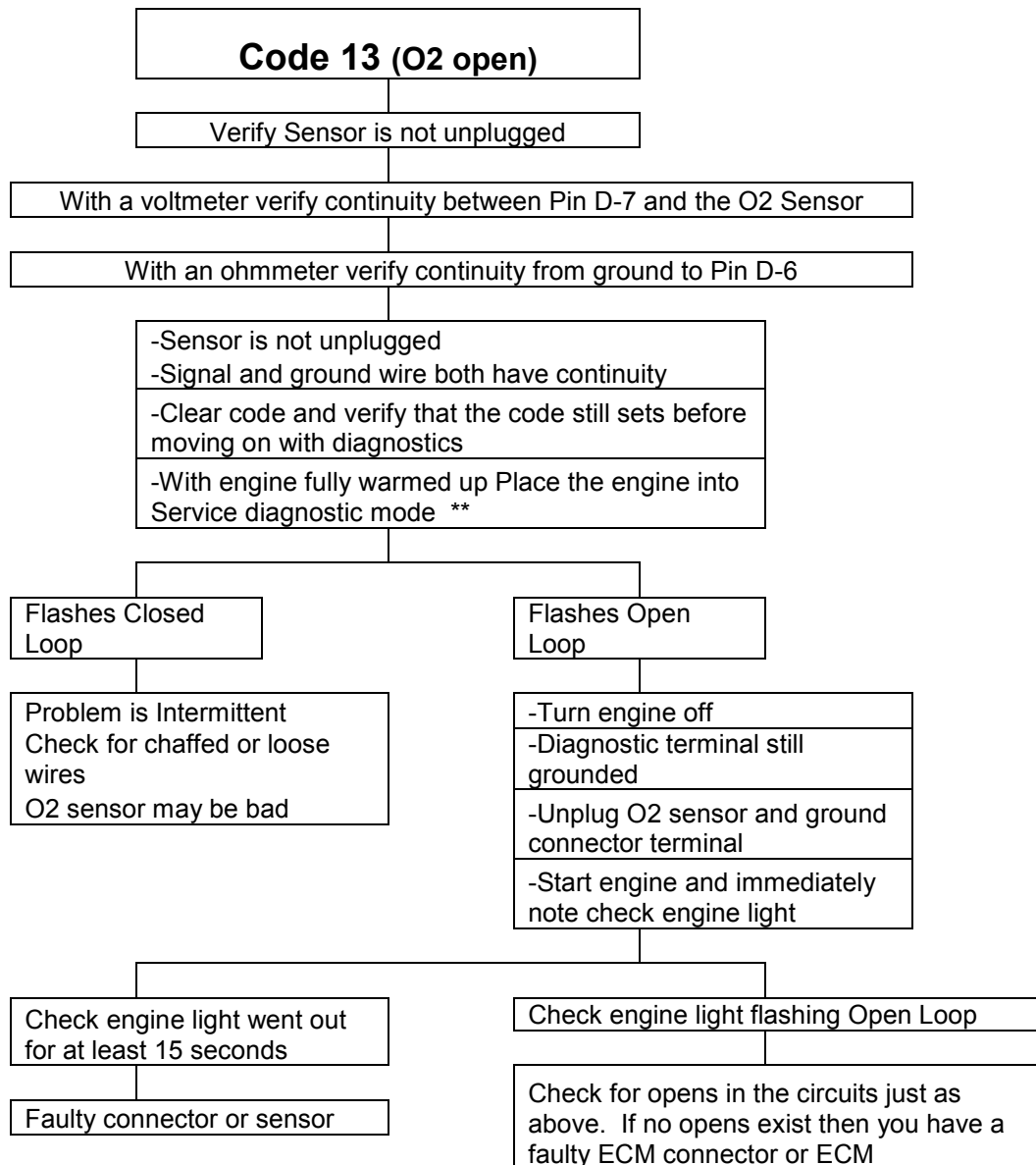

** Service diagnostic mode is entered the same as Engine Off Self Test. Ground out Pin A and B on the ALDL connector with the engine running. Rapid flashing (approx 1/2 - 1 sec interval) is open loop. Flashing at a slower rate indicates closed loop.

14. High temperature indicated at engine coolant temp. sensor. Sensor could be unplugged

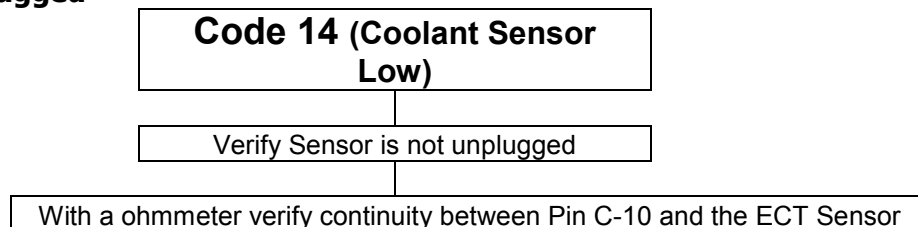

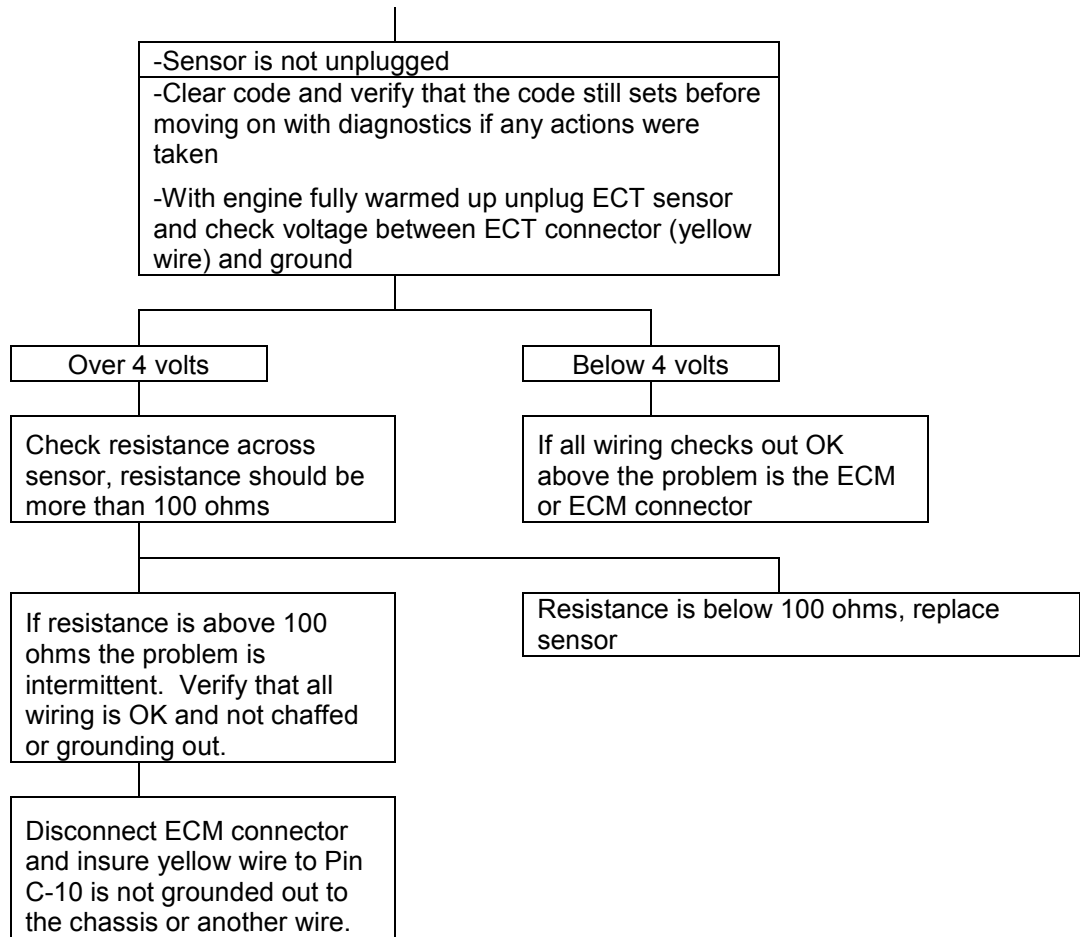

15. Low temperature indicated at engine coolant temp. sensor

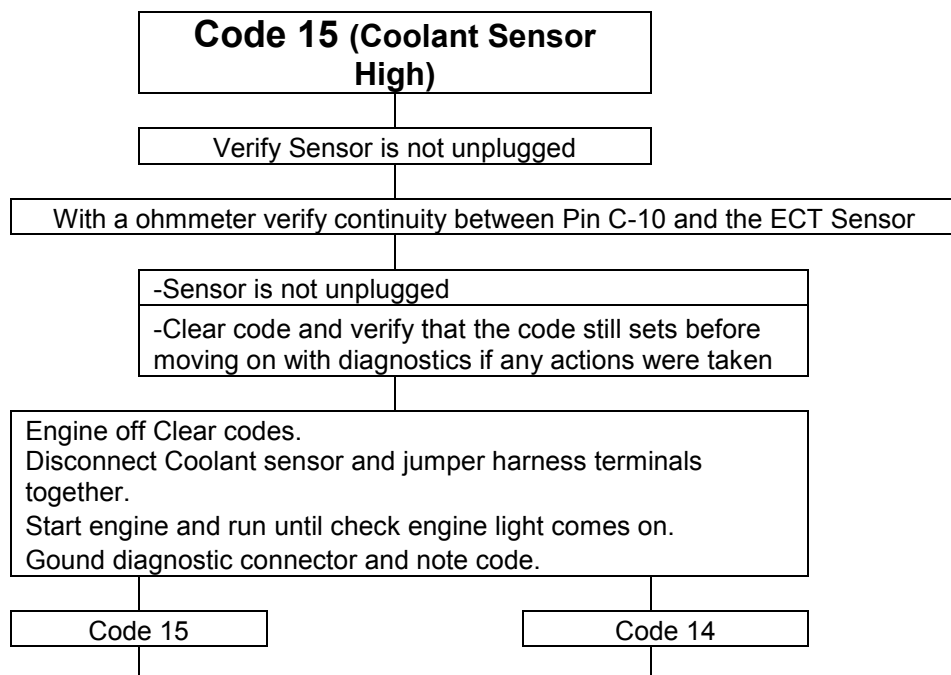

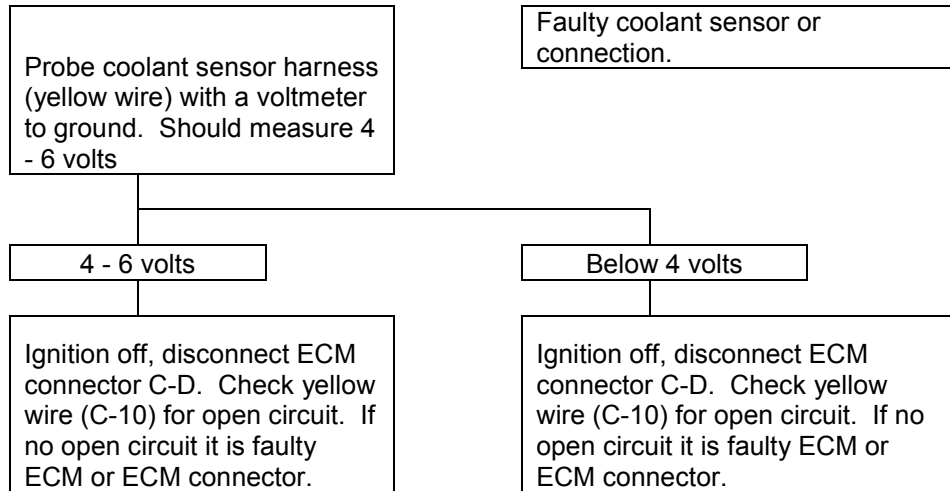

21. High voltage at throttle position sensor. Sensor could be unplugged.

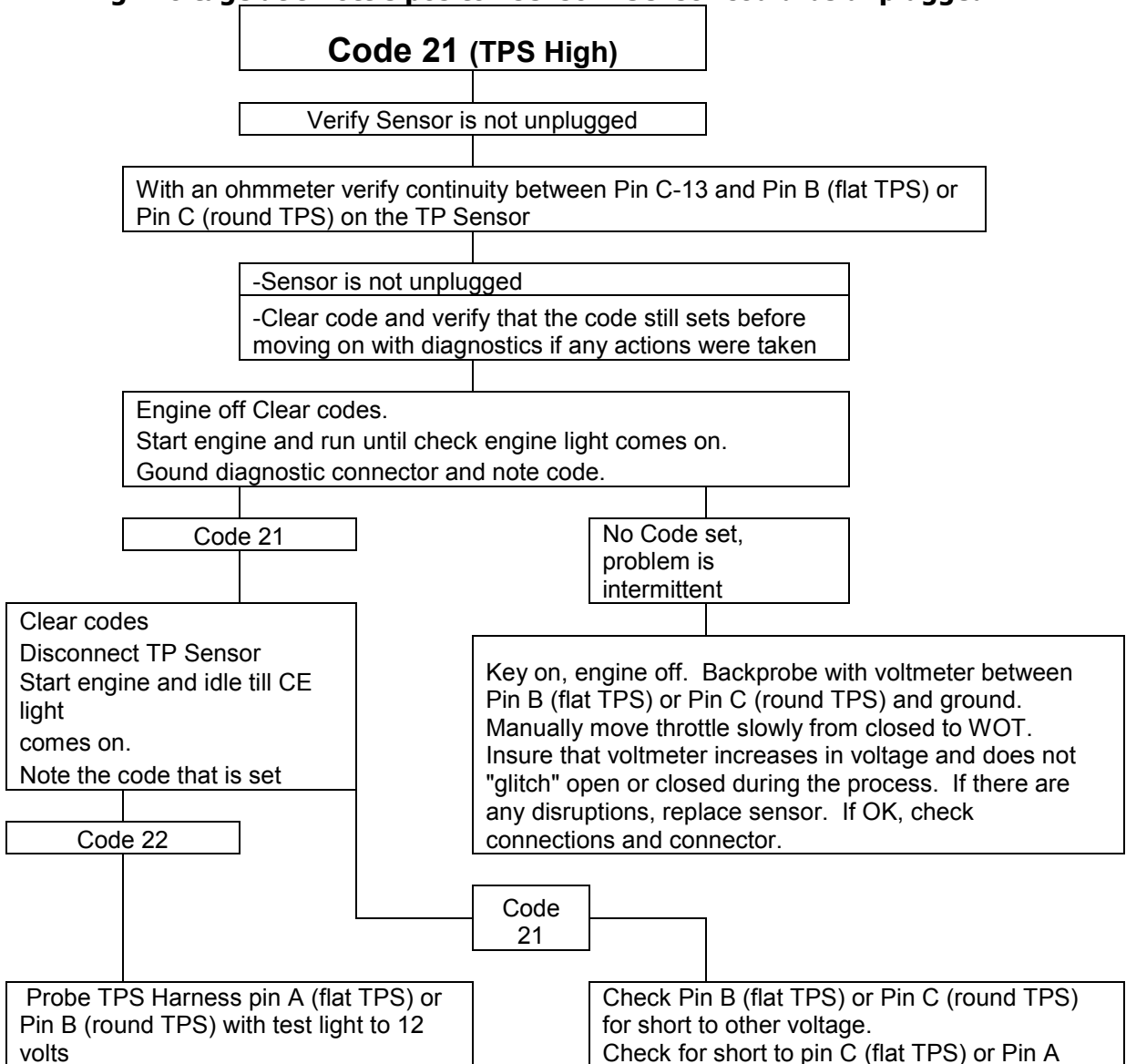

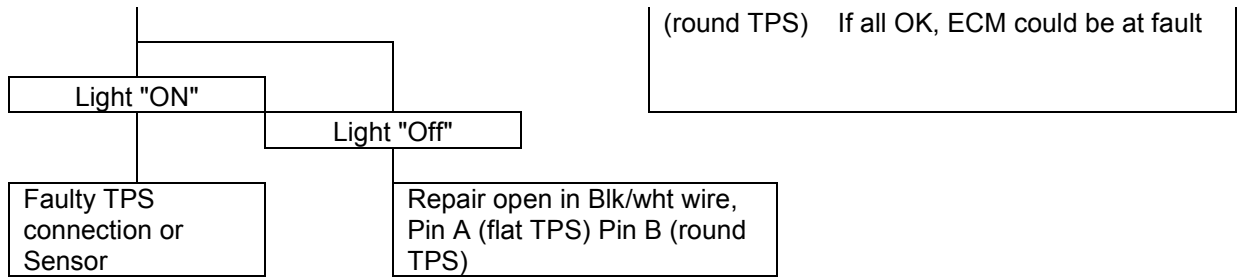

22. Low voltage at throttle position sensor

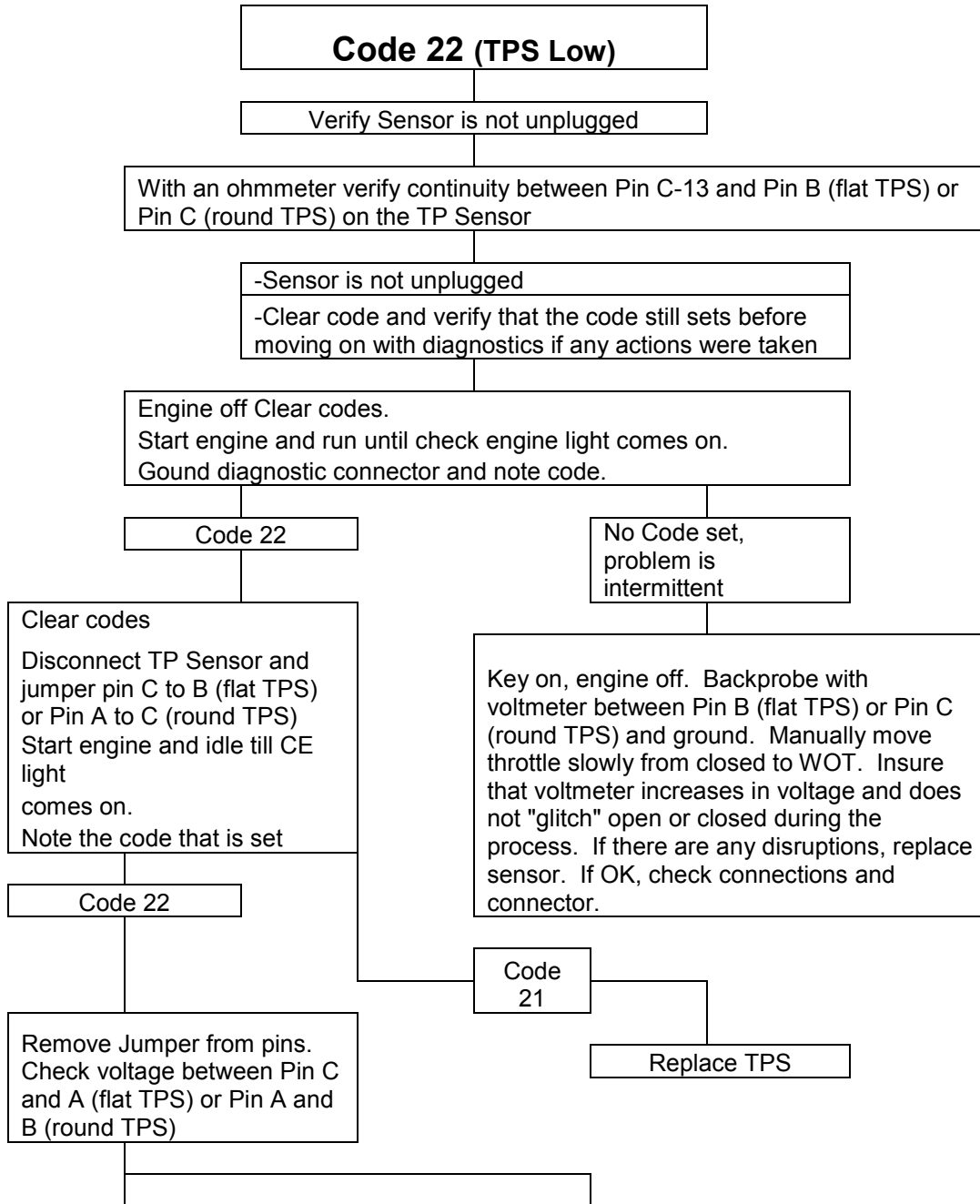

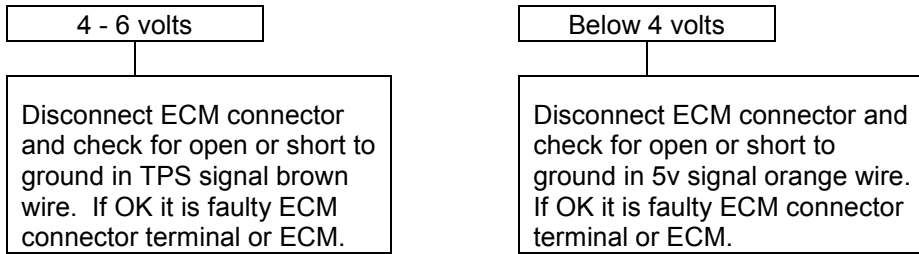

33. High voltage (low vacuum) at MAP sensor, sensor could be unplugged.

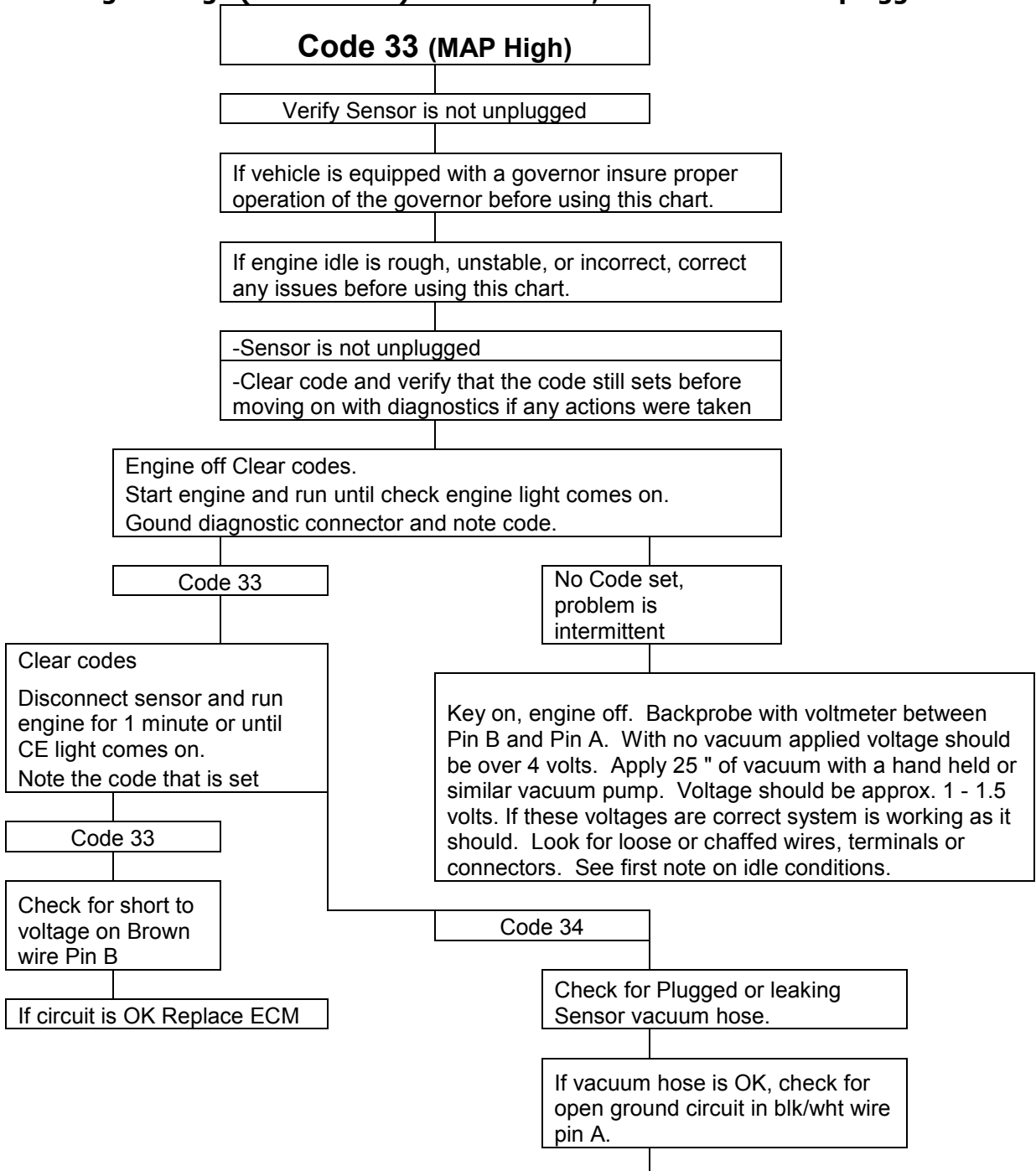

If ground circuit is OK, Replace sensor

34. Low voltage (high vacuum) at MAP sensor.

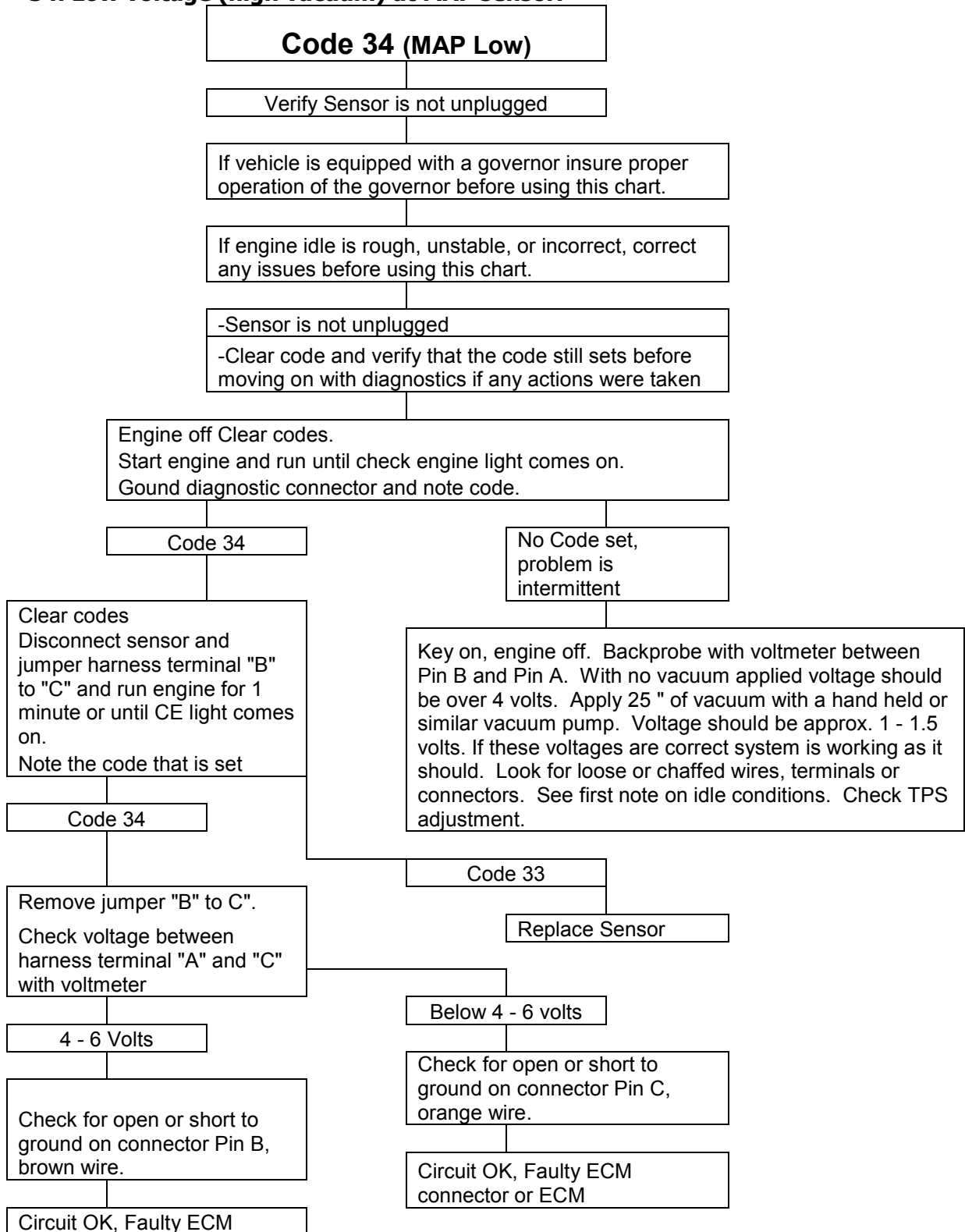

connector or ECM

44. Oxygen sensor lean

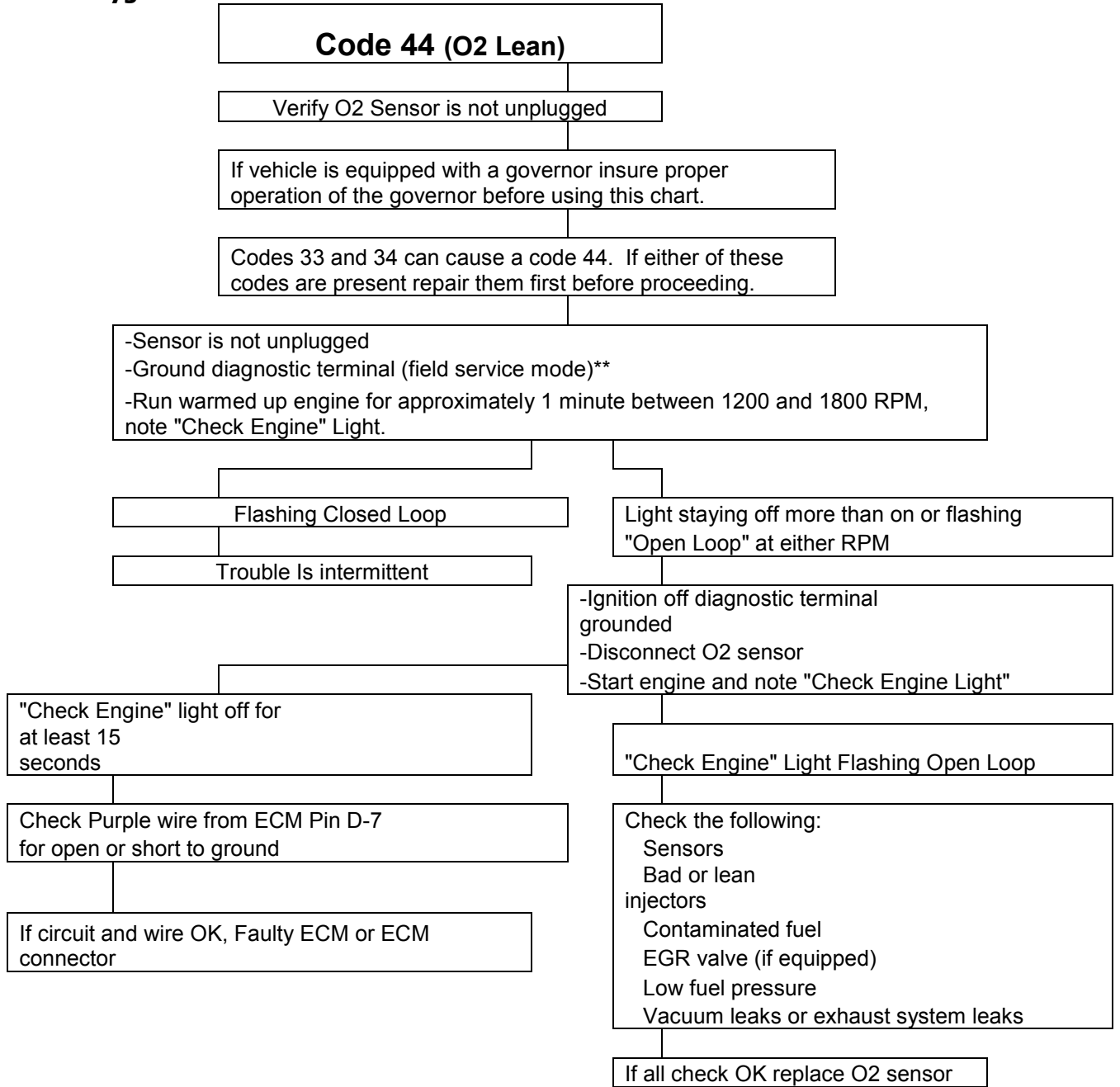

** Service diagnostic mode is entered the same as Engine Off Self Test. Ground out Pin A and B on the ALDL connector with the engine running. Rapid flashing (approx 1/2 - 1 sec interval) is open loop. Flashing at a slower rate indicates closed loop.

45. Oxygen sensor rich

Code 45 (O2 Rich)

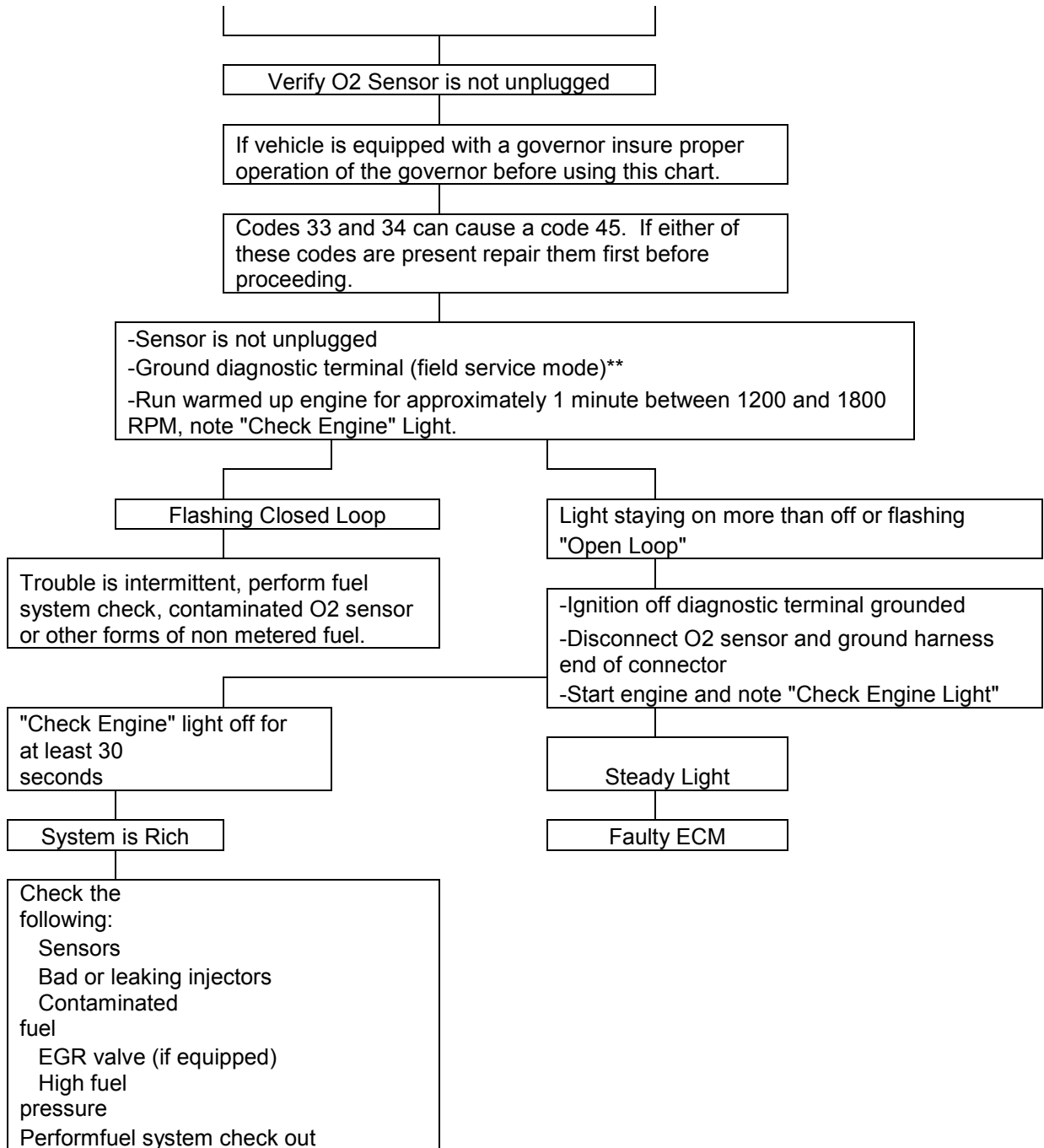

** Service diagnostic mode is entered the same as Engine Off Self Test. Ground out Pin A and B on the ALDL connector with the engine running. Rapid flashing (approx 1/2 - 1 sec interval) is open loop. Flashing at a slower rate indicates closed loop.

51. PROM error

52. Calpak Missing

54. Low voltage at fuel pump OR Low voltage at Fuel pump relay

55. Problem at Electronic Control Module (ECM) - ECM failure OR Serial bus error

Code 51 (Eprom Problem)

Check that all pins are fully inserted in the socket. If OK, replace PROM, clear memory and recheck. If code 51 reappears replace ECM

Code 52 (Fuel CALPAK missing)

Install missing or faulty CALPAK

Code 54

Fuel Pump Relay or relay wiring

Code 55

Replace ECM

WIRE PINOUT

- A-1 BLUE FUEL PUMP RELAY "F"
- A-4 WHITE EGR (if equipped)
- A-5 ORANGE CHECK ENGINE LITE
- A-6 PINK IGN 1 RUN TO PIN A ON INJECTORS
- A-7 PURPLE TOURQUE CONVERTER (if equipped)
- A-8 BLUE ALDL CON. PIN "E"
- A-9 BROWN ALDL CON. PIN "B"
- A-10 BROWN VEHICLE SPEED SENSOR
- A-11 BLACK/WHITE MAP RETURN GREEN CON. A
- A-12 BLACK TO BLOCK GROUND TOTAL CONNECT WD-1, D-6

- B-1 BAT RED FUSED CONNECTS WITH C-16
- B-2 ORANGE FUEL PUMP RELAY PIN"A"
- B-3 BLACK/WHITE PIN D DIST GROUND W/SMALL DIST. PIN A
- B-5 TAN PIN B DIST REF W/SMALL DIST PIN C
- B-7 WHITE 60" ESC PIN C PIN D (GND) PIN B ING. PIN E KNOCK SEN. (if equipped)
- B-8 GREEN A/C or Compressor/Winch idle increase
- B-10 P.N.

454

- C-3 GREEN IAC W/MALE W/P PIN D D
- C-4 BLUE IAC W/MALE W/P PIN C C
- C-5 GREEN IAC W/MALE W/P PIN A B
- C-6 BLUE IAC W/MALE W/P PINB A
- C-7 GREEN HIGH GEAR
- C-9 TAN CRANK INPUT TO STARTER STUD or IGNITION SWITCH
- C-10 YELLOW ECT
- C-11 BROWN MAP INPUT PIN B ON GREEN CON.
- C-12 TAN MAT (if equipped)
- C-13 BROWN TPS PIN B ROUND TPS PIN C
- C-14 ORANGE (5V REF) GOES TO MAP & TPS PIN C ROUND TPS PIN A
- C-16 RED 12 VOLT CONNECTS IN WITH B-1

- D-1 BLACK BLOCK GROUND CONNECT W/ D-6, A-12
 - D-2 BLACK/WHITE ECT & TPS RETURN ON TPS PIN A ROUND TPS PIN B
 - D-4 TAN DIST SIGNAL PIN A W/SMALL DIST PIN D
 - D-5 BLUE IGN BYPASS (FOR TIMMING) PIN C W/SMALL DIST PIN B
 - D-6 BLACK/WHITE O/2 GROUND GOES TO BLOCK GROUND CONNECT W/D-1,A-12
 - D-7 PURPLE O/2
 - D-14 GREEN INJECTOR'S PIN B
 - D-16 PURPLE INJECTOR'S PIN B
- PINK WIRE TO IGN. 1 PIN A FROM INJECTORS FROM A 6
 PIN D ON FUEL PUMP RELAY TO BLOCK GROUND 28" BLACK
 PIN E ON FUEL PUMP RELAY TO IGN.

PIN A ON ALDL TO BLOCK GROUND

- RELAY
- | | | | |
|--|----|-----|----|
| 85 FROM ING. SWITCH | | 30 | |
| 86 GROUND | 85 | 87A | 86 |
| 30 12V. ALSO CONNECT W/12V TO ECM, B1, C16 | | 87 | |
| 87 ING. OUT | | | |
- PIN A FOR SMALL DIST 2 PIN CONN IS IGN. PIN B IS COIL WIRE (WHITE)

Affordable Fuel Injection

Throttle Body Injection

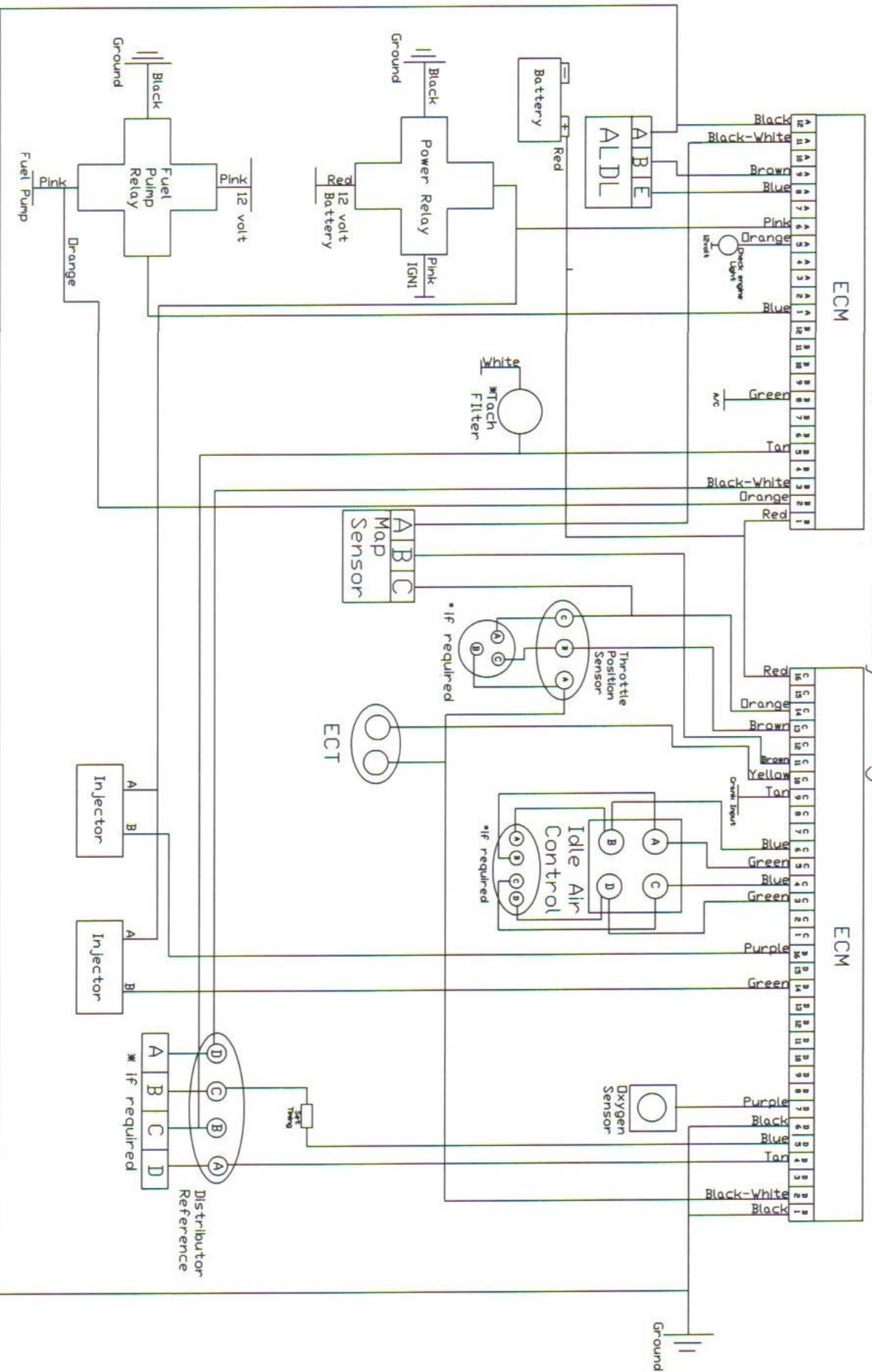

* If required means, certain systems require the different plug type. the wires are shown according to the new plug from the original pins.