

United States | August 2015

# PRICELIST



**INTRODUCTION**

Terms & Conditions ..... 3  
 Shipping Program ..... 4  
 Cleaning & Maintenance ..... 5

**SEATING**

Bean ..... 7  
 Bud ..... 9  
 Calvin ..... 11  
 Companion ..... 21  
 Cooper Collection  
     Bala ..... 32  
     Bracebridge ..... 47  
     Dwight ..... 58  
     Huntsville ..... 72  
     Midland ..... 83  
     Mission ..... 93  
     Cooper Rocks ..... 104  
 Crayon ..... 108  
 Dignity ..... 111  
 Dignity2 ..... 118  
 Eighteen5 & Twenty2  
     Eighteen5 ..... 132  
     Twenty2 ..... 136  
 EndZone Benches ..... 140  
 Gravity ..... 145  
 Heavy Duty Seating ..... 154  
 Midway ..... 163  
 Phlebotomy Chair ..... 174  
 Snowball  
     Snowball 1 ..... 178  
     Snowball 2 ..... 189  
     Snowball 3 ..... 200  
 Snowflake ..... 212  
 Traffic ..... 216  
 Urban  
     DuraSpec Poly Seat & Plastic Back ..... 222  
     DuraSpec Poly Seat & Upholstered Back ..... 228  
     Upholstered Seat & Plastic Back ..... 233  
     Fully Upholstered ..... 238  
 2000 Series ..... 246

**TABLES**

Acute ..... 259  
 Annex ..... 267  
 Ark ..... 269  
 Boardgames ..... 279  
 Cast ..... 296  
 Castaway ..... 300  
 Conductor ..... 309  
 Cooper Tables ..... 317  
 Dani ..... 320  
 Drum & Cube Tables ..... 324  
 Drum Bases ..... 326  
 EndZone ..... 338  
 Fitt ..... 352  
 Half Round ..... 355  
 Heavy Duty Tables ..... 363  
 Manhattan  
     Round Column ..... 367  
     Rectangle Column ..... 377  
     With Footring ..... 384  
     Accessories ..... 386  
 Midway & Companion Tables ..... 387  
 Post Legs ..... 389  
 Sidekick ..... 406  
 Tailgate  
     Overview ..... 408  
     With Media Wall ..... 415  
     Freestanding ..... 422  
     Power ..... 436  
 Trius ..... 438  
 Trumpet & Disc ..... 444  
 Tubular ..... 447  
 Varsity ..... 455  
 Vespa ..... 460  
 Table Accessories  
     Modesty Panels ..... 467  
     Wire Manager Troughs ..... 468  
     Grommets, Seam Connectors & Table Carts ..... 470  
     Wire Management ..... 471  
     Power ..... 672

**OVERBED TABLES & BEDSIDE CABINETS**

Bedside Cabinets & Casegoods ..... 487  
 Overbed Tables ..... 494

**CREDENZAS, CARTS & LECTERNS**

Credenzas ..... 497  
 Buffet Height Credenzas ..... 500  
 Hospitality Carts ..... 502  
 Lecterns ..... 503

**QUICKSHIP ..... 505**

**REVISIONS ..... 512**

**This price list is interactive** - clicking on the Series in the Content page will take you to the beginning of that Series. The Back to Content button on the top left of each page will return you to the Content page.

## TERMS & CONDITIONS

### PRICES

U.S. shipments are FOB Buffalo, New York (refer to Spec's U.S. prepaid shipping program). Prices include all carton and crating charges and do not include any taxes, storage, shipping or installation charges. Prices are subject to change without notice.

### WARRANTY

We are pleased to provide the initial purchaser with a Lifetime Structural Warranty against defects in design, construction and materials. Finishes and cover materials are warranted for two years subject to normal wear and tear. Our warranty will not apply where there is evidence of alteration, misuse, negligence or abuse. No warranty shall apply to COM fabrics. During the warranty period, we will repair, or at our option, replace any product where we are satisfied the product is defective. Decisions on warranty rest solely with Spec. All freight charges for items being returned for service must be prepaid by the customer. If a claim is accepted, we will gladly refund the charges incurred.

### CREDIT

All purchase orders are subject to credit approval. For our established dealers, terms are net 30 days from date of invoice. In some instances a deposit may be required to accompany an order. We will advise you if a deposit is required when we acknowledge your order.

### DAMAGE AND CLAIMS

All products are carefully examined before packaging for shipment. Ownership of your product passes to you upon pick-up by the carrier at our factory. Upon receipt of your order, check for any physical damage to the product (even if the carton is unmarked) that may have occurred during transit. Note any physical damage on all copies of the bill of lading and enter a freight claim with the carrier immediately. If you discover damage while unpacking, arrange for a carrier inspection immediately. Any damage, visible or concealed, must be reported to the carrier within 15 days from delivery. Our customer service department would be pleased to help you in any way during the process.

### CANCELLATIONS, RETURNS AND CHANGES

Orders are in process once acknowledged and may not be cancelled without our consent. You may be responsible for work in process and administration costs including labor and raw materials. Merchandise may be returned only with our clear written authorization. Freight costs for returns are your responsibility. Our product designs, processes, and materials are always under review ensuring the best quality and value to you. We will do our best to notify you as improvements occur.

### ORDERING PROCEDURES

Please submit all orders in writing and fax, e-mail or forward

directly to the factory. Orders sent by fax do not require confirmation. Please use our model numbers and finish codes with a brief description of the product(s) being ordered. Your order will be acknowledged promptly and in writing to you (usually by fax or e-mail) once clarified. We request your assistance in checking our acknowledgement's accuracy to your order to ensure discrepancies do not occur. It is your responsibility to let us know of any discrepancies within 5 business days from the acknowledgement date.

### CUSTOM ORDERS

Custom orders are encouraged. Our constant design innovation and adaption to new ideas is fueled by our customers. If you can't find what you require, or have a unique application, simply call us.

### COM SHIPPING INSTRUCTIONS

All COM fabrics should be ordered and shipped directly to our factory at 165 City View Drive, Toronto, Ontario, Canada, M9W 5B1. For fabric originating in the United States, most suppliers are aware of the required documentation for entry into Canada. Please have your COM supplier mark on the customs documentation that UPS is our customs broker. If there are any questions, please feel free to contact us. All COM fabric shipments should be shipped freight prepaid.

### 10 DAY QUICKSHIP

The 10 Day Quickship features products from the Snowball Chair Series, the Fitt Table System and a selection of General Purpose Tables. Spec ships your confirmed order within 10 business days – or it's free. Refer to our 10 Day Quickship for more details.



# SHIPPING PROGRAM

Shipping costs will be added to your invoice. For those orders outside continental US, contact us for a freight quote.

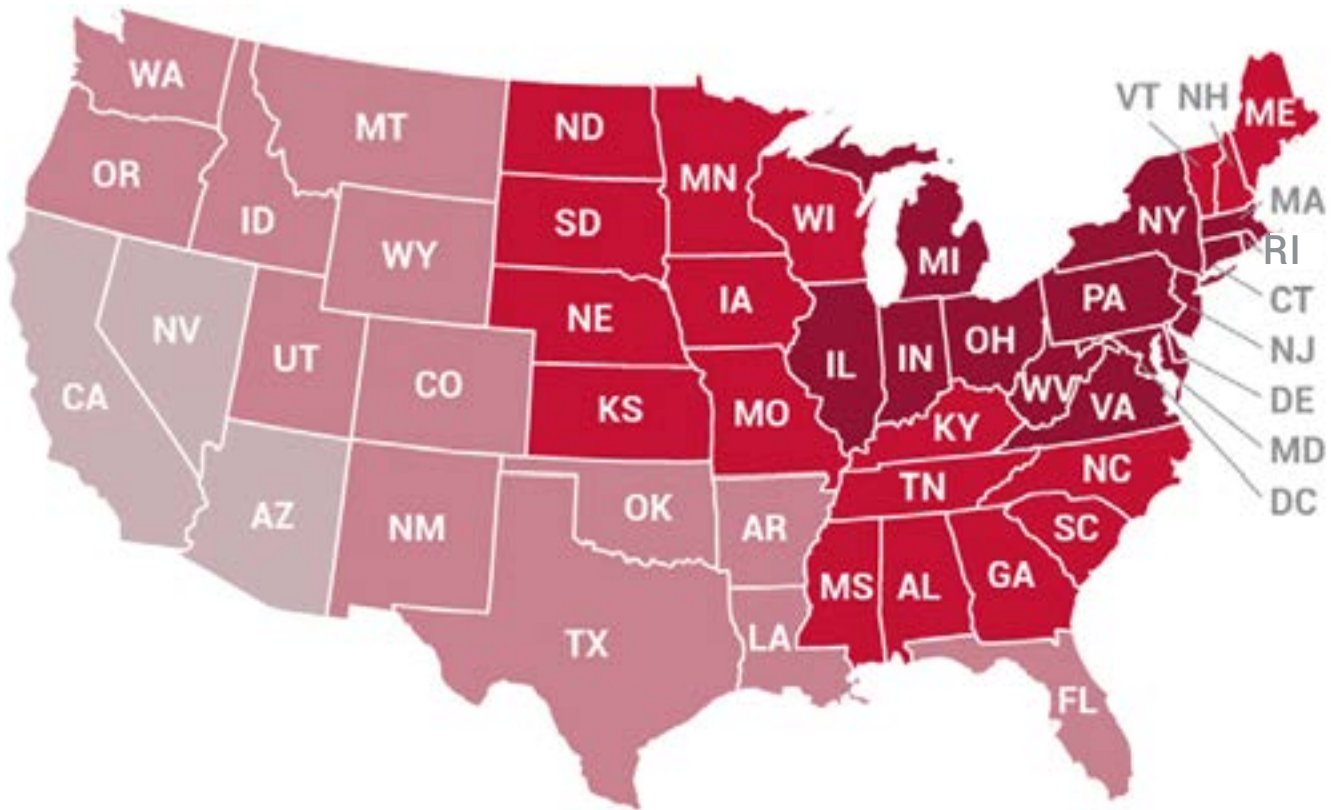

**ZONE 5**

Orders exceeding \$5,000 List, are shipped at 1% of List.  
Orders less than \$5,000 List, are shipped at a flat rate of \$90 Net.

- CONNECTICUT
- DELAWARE
- ILLINOIS
- INDIANA
- MARYLAND
- MASSACHUSETTS
- MICHIGAN
- NEW JERSEY
- NEW YORK
- OHIO
- PENNSYLVANIA
- RHODE ISLAND
- VIRGINIA
- WASHINGTON D.C.
- WEST VIRGINIA

**ZONE 6**

Orders exceeding \$5,000 List, are shipped at 2% of List.  
Orders less than \$5,000 List, are shipped at a flat rate of \$125 Net.

- ALABAMA
- GEORGIA
- IOWA
- KANSAS
- KENTUCKY
- MAINE
- MINNESOTA
- MISSISSIPPI
- MISSOURI
- NEBRASKA
- NEW HAMPSHIRE
- NORTH CAROLINA
- NORTH DAKOTA
- SOUTH CAROLINA
- SOUTH DAKOTA
- TENNESSEE
- VERMONT
- WISCONSIN

**ZONE 7**

Orders exceeding \$5,000 List, are shipped at 3% of List.  
Orders less than \$5,000 List, are shipped at a flat rate of \$125 Net.

- ARKANSAS
- COLORADO
- FLORIDA
- IDAHO
- LOUISIANA
- MONTANA
- NEW MEXICO
- OKLAHOMA
- OREGON
- TEXAS
- UTAH
- WASHINGTON
- WYOMING

**ZONE 8**

Orders exceeding \$5,000 List, are shipped at 4% of List.  
Orders less than \$5,000 List, are shipped at a flat rate of \$125 Net.

- ARIZONA
- CALIFORNIA
- NEVADA

## CLEANING & MAINTENANCE

### SPECTONE EPOXY FINISH

Light soiling may be removed with a damp cloth or household glass cleaners. Heel marks, heavy soiling and surface marring may be removed with automotive grade polishing compounds or car wax. Do not apply abrasive cleaners, polish or lubricants to table bases or moving parts. Damaged paint may be repaired with touch-up paint which is available from the factory. Touch-up paint is supplied in powder form to provide an exact match with the existing color. To use the powder, add a small quantity of commercially available lacquer thinner to a small quantity of the powder, stirring with a metal stirrer until the desired consistency is achieved. The paint solution may then be applied using a brush. Avoid using too thick a consistency resulting in brush marks. Allow at least one hour to dry.

### LAMINATE TABLE TOPS

Clean with mild soap and water. Do not use abrasive cleaners or wax. Avoid flooding laminate surfaces as water can seep between laminate joints, loosening the finish from the wooden substrate and damaging the substrate.

### VENEER TABLE TOPS

Clean with mild soap and water. Always wipe the surface in the direction of the wood grain and ensure there is no pooling of liquid at the seams. Do not use abrasive cleaners or wax.

### FOLDING BASES

Remove plastic caps & add 2 drops of WD-40. Move column back and forth to lubricate. Let sit for one hour. Replace plastic caps. To maintain ease of movement, repeat every 6 months.

### CHROME

Minor marks may be removed with a household cleaning solvent such as Windex. Chrome polish may be used to restore luster on chrome products.

### FABRICS

Care of fabrics varies with the type of fabric. To prevent damage, Spec recommends using only mild water based solutions. For stubborn stains, we recommend that you check the website of the fabric manufacturer or call them for specific cleaning instructions for the fabric. For healthcare applications, stronger cleaning solutions are used for infection control. These solutions must be cleaned off with clean water following their use.

### WOOD FRAMES

For light cleaning/dusting, use soft cloth or duster. For stubborn stains, use non-abrasive, water-based cleaners only.



# SEATING



# BEAN

BACK TO CONTENTS



PLACING AN ORDER IS EASY

## PRODUCT CODE

### CHAIR

**40 20**

**Series**  
40 : Bean

**Chair Type**  
20 : Stool

### TABLE

**3030SQ BEAN**

**Top Shape**  
3030SQ : Square  
3232BN : Bean

**Series**  
Bean



## FINISHES

### LAMINATE



Select laminate from our virtually unlimited laminate options

### BASE



Select from one of our 76 standard Spectone colors

### EDGE



2MM

PVC

Check out our website for a complete list of edge profiles.



## BEAN – Children’s Series

### Standard Features

- Laminate seat and table in any standard Arborite, Formica, Nevamar, Pionite or Wilsonart matte finish
- PVC edges in flat or bullnose and 2mm Bio edge available in 38 colors
- Frame in any Spectone color
- 1” NU-Green earth friendly core
- Ships KD

### Options

- Non-standard laminates, contact Spec for pricing
- Custom table heights or shapes, contact Spec for pricing



### Children’s Stool

MODEL PRICE  
**4020 220**

Dimensions (inches)  
 seat H 12.0 total W 18.0 depth 18.0



**4020**  
14 lbs

### Children’s Tables

MODEL PRICE  
**30x30 SQ BEAN 552**

*Square Shape*

Dimensions (inches)  
 table H 21.0 total W 30.0 depth 30.0



**30 x 30 SQ BEAN**  
38 lbs

MODEL PRICE  
**32x32 BN BEAN 552**

*Bean Shape*

Dimensions (inches)  
 table H 21.0 total W 32.0 depth 32.0



**32 x 32 BN BEAN**  
35 lbs





# BUD



PLACING AN ORDER IS EASY

## PRODUCT CODE

**2501**

**Series**

- 2501 : Round
- 2502 : Square
- 2503 : Crescent

## FINISHES

### FABRIC



Select fabrics from one of our textile partners



# BUD Collaborative Stools

BACK TO CONTENTS

## Standard Features

- Glides
- Ships 1/carton 8 cu ft
- Weight load tested to 250 lbs

Contact Spec Customer Service to railroad fabrics (specify repeat info and yardage requirement will be provided) and for repeats greater than 5" x 5"

## Options

- Antibacterial and antimicrobial fabrics available
- CAL 133
- Different fabrics on seat and sides are available. If two fabrics are the same grade, add \$60 List per stool. For different grades of fabric, average the two grades and add \$60 List per stool.

## Collaborative Stools - Round

COM 1.3 yd  
0.5 yd COM per seat  
0.8 yd COM for side

MODEL	COM	GR1	GR2	GR3	GR4	GR5	GR6
<b>2501</b>	<b>390</b>	<b>444</b>	<b>462</b>	<b>499</b>	<b>554</b>	<b>596</b>	<b>652</b>

Dimensions (inches)

seat H 18 DIA 15

CAL 133, add \$145 List per stool



**2501**  
13 lbs

## Collaborative Stools - Square

COM 1.9 yd  
0.5 yd COM per seat  
1.4 yd COM for sides

MODEL	COM	GR1	GR2	GR3	GR4	GR5	GR6
<b>2502</b>	<b>425</b>	<b>520</b>	<b>551</b>	<b>616</b>	<b>712</b>	<b>786</b>	<b>884</b>

Dimensions (inches)

seat H 18 total W 18 depth 18

CAL 133, add \$145 List per stool



**2502**  
24 lbs

## Collaborative Stools - Crescent

COM 1.3 yd  
0.5 yd COM per seat  
0.8 yd COM for sides

MODEL	COM	GR1	GR2	GR3	GR4	GR5	GR6
<b>2503</b>	<b>455</b>	<b>509</b>	<b>527</b>	<b>564</b>	<b>619</b>	<b>661</b>	<b>717</b>

Dimensions (inches)

seat H 18 DIA 15

CAL 133, add \$145 List per stool



**2503**  
12 lbs

## CALVIN PUBLIC SEATING – Layouts



### Description

- Spec's Calvin offers an oval steel frame with either wood or aluminum side rails.
  - Your layout possibilities are unlimited with spacer, radius and corner tables – for both standard and bariatric seating in virtually any combination.
  - Bariatric seating is a 30" wide seat and is load tested to 750 lbs. Cannot be connected to other bariatric seats.
  - 21" seat width is standard.
  - Choice of wood or polyurethane arms.
  - Wood and polyurethane arms are replaceable in the field.
  - Two and three seat models offer a choice of no center arms or half arms between seats.
  - Glides and separate seat and back are standard.
  - Foam formulated to meet California Bulletin 133 standards is available.
  - Please send a drawing of the configuration you require with your order.
- Ships assembled as one, two and three seater units.
- For fabrics you wish railroded or repeats larger than 5" x 5", please contact the factory with repeat information and yardage requirement will be provided.

### LAYOUTS AND DIMENSIONS

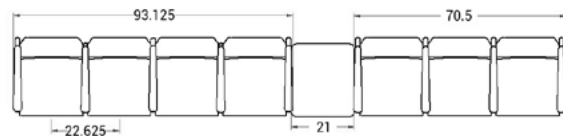
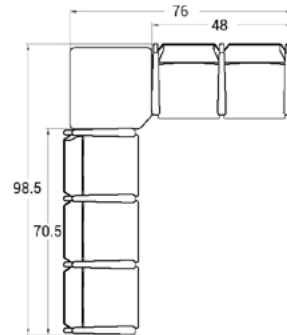
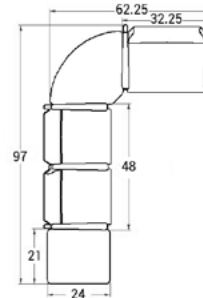

# CALVIN

BACK TO CONTENTS



PLACING AN ORDER IS EASY

**PRODUCT CODE**

**8101M**

**Series**

81 : Calvin

**Center Arm**

0 : No center arm  
1 : Half arms

**# Seats**

1 : Single Seat  
2 : Two-Seat  
3 : Three-Seat

**Chair Type**

M : Mid Back  
H : Highback  
G : Bariatric  
L : Loveseat  
ME : Hip Chair



**OPTIONS**

**SIDE RAIL**



Wood



Aluminium

**ARMS**



Wood



Polyurethane

**FINISHES**

**FRAME**



Select from one of our 76 standard Spectone colors

**FABRIC**



Select fabrics from one of our textile partners

**ARM**

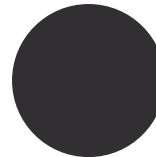

Black

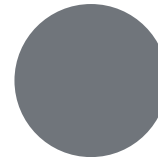

Sterling Grey

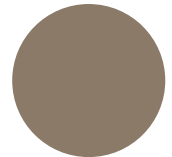

Taupe

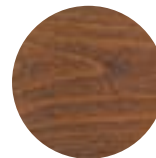

Wood\*

\*Wood arms are available in 7 standard stains and stain-to-match at no upcharge.



# CALVIN PUBLIC SEATING

Single Seater with arms

## Standard Features

- Separate seat and back
- Polyurethane arms or wood arms
- Arms are field replaceable
- Wall-saving, 11 gauge oval tube frame
- Frame in any Spectone color
- Velcro removable back covers, replaceable seat
- Used in connected layouts at no upcharge
- Glides
- Ships assembled as 1, 2 or 3 seaters
- Ships 1/carton 15 cu ft

## Options

- Choose aluminum (A) or wood (W) side frame. Aluminum side frame available in any Spectone color.
- For wood (W) side frame, specify and add \$110 list. Available in any of 7 standard stains or stain-to-match at no upcharge
- Polyurethane arms available in Black, Sterling Grey or Taupe (RAL 7006)
- Wood arms in Beech are available in any of 7 standard stains or stain-to-match at no upcharge
- Connected and freestanding tables
- Antibacterial and antimicrobial fabrics available
- Different fabric on seat and back at no upcharge
- CAL 133

**Contact Spec Customer Service to railroad fabrics (specify repeat info and yardage requirement will be provided) and for repeats greater than 5" x 5"**



## Single Seater with arms

COM 1.75 yds  
 0.75 yd COM per single seat  
 1.0 yd COM per single back

MODEL	COM	GR 1	GR 2	GR 3	GR 4	GR 5	GR 6
<b>8101M</b>	<b>901</b>	<b>998</b>	<b>1027</b>	<b>1095</b>	<b>1188</b>	<b>1263</b>	<b>1362</b>

Dimensions (inches)

seat H	18.0	seat W	21.0	arm H	25.0
total H	33.75	total W	25.0	depth	26.0

Exceeds BIFMA Seating Durability Test to 500 lbs per chair  
 CAL 133, add \$110 List per chair



**8101M**  
27 lbs



# CALVIN PUBLIC SEATING

Two and Three Seaters with outside arms

## Standard Features

- Separate seat and back
- Polyurethane arms or wood arms
- Arms are field replaceable
- Wall-saving, 11 gauge oval tube frame
- Frame in any Spectone color
- Velcro removable back covers, replaceable seat
- Used in connected layouts at no upcharge
- Glides
- Ships assembled as 1, 2 or 3 seaters
- Ships 1/carton 15 cu ft

**Contact Spec Customer Service to railroad fabrics (specify repeat info and yardage requirement will be provided) and for repeats greater than 5" x 5"**

## Options

- Choose aluminum (A) or wood (W) side frame. Aluminum side frame available in any Spectone color.
- For wood (W) side frame, specify and add \$110 list. Available in any of 7 standard stains or stain-to-match at no upcharge
- Polyurethane arms available in Black, Sterling Grey or Taupe (RAL 7006)
- Wood arms in Beech are available in any of 7 standard stains or stain-to-match at no upcharge
- Connected and freestanding tables
- Antibacterial and antimicrobial fabrics available
- Different fabric on seat and back at no upcharge
- CAL 133

---

### Two Seater with outside arms

COM 3.5 yds  
0.75 yd COM per single seat  
1.0 yd COM per single back

MODEL	COM	GR 1	GR 2	GR 3	GR 4	GR 5	GR 6
<b>8102M</b>	<b>1442</b>	<b>1635</b>	<b>1696</b>	<b>1832</b>	<b>2018</b>	<b>2168</b>	<b>2363</b>

Dimensions (inches)

seat H	18.0	seat W	21.0	arm H	25.0
total H	33.75	total W	44.75	depth	26.0

Exceeds BIFMA Seating Durability Test to 750 lbs per two seater  
CAL 133, add \$220 List per two seater



**8102M**  
51 lbs

---

### Three Seater with outside arms

COM 5.25 yds  
0.75 yd COM per single seat  
1.0 yd COM per single back

MODEL	COM	GR 1	GR 2	GR 3	GR 4	GR 5	GR 6
<b>8103M</b>	<b>1926</b>	<b>2215</b>	<b>2306</b>	<b>2509</b>	<b>2788</b>	<b>3013</b>	<b>3308</b>

Dimensions (inches)

seat H	18.0	seat W	21.0	arm H	25.0
total H	33.75	total W	67.5	depth	26.0

Exceeds BIFMA Seating Durability Test to 1000 lbs per three seater  
CAL 133, add \$330 List per three seater



**8103M**  
75 lbs



# CALVIN PUBLIC SEATING

Two and Three Seaters with half arms

## Standard Features

- Separate seat and back
- Polyurethane arms or wood arms
- Arms are field replaceable
- Wall-saving, 11 gauge oval tube frame
- Frame in any Spectone color
- Velcro removable back covers, replaceable seat
- Used in connected layouts at no upcharge
- Glides
- Ships assembled as 1, 2 or 3 seaters
- Ships 1/carton 15 cu ft

**Contact Spec Customer Service to railroad fabrics (specify repeat info and yardage requirement will be provided) and for repeats greater than 5" x 5"**

## Options

- Choose aluminum (A) or wood (W) side frame. Aluminum side frame available in any Spectone color.
- For wood (W) side frame, specify and add \$110 list. Available in any of 7 standard stains or stain-to-match at no upcharge
- Polyurethane arms available in Black, Sterling Grey or Taupe (RAL 7006)
- Wood arms in Beech are available in any of 7 standard stains or stain-to-match at no upcharge
- Connected and freestanding tables
- Antibacterial and antimicrobial fabrics available
- Different fabric on seat and back at no upcharge
- CAL 133



### Two Seater with half arms

COM 3.5 yds  
0.75 yd COM per single seat  
1.0 yd COM per single back

MODEL	COM	GR 1	GR 2	GR 3	GR 4	GR 5	GR 6
<b>8112M</b>	<b>1618</b>	<b>1811</b>	<b>1872</b>	<b>2007</b>	<b>2193</b>	<b>2343</b>	<b>2539</b>

Dimensions (inches)

seat H	18.0	seat W	21.0	arm H	25.0
total H	35.0	total W	48.0	depth	26.0

Exceeds BIFMA Seating Durability Test to 750 lbs per two seater  
CAL 133, add \$220 List per two seater



**8112M**  
51 lbs

### Three Seater with half arms

COM 5.25 yds  
0.75 yd COM per single seat  
1.0 yd COM per single back

MODEL	COM	GR 1	GR 2	GR 3	GR 4	GR 5	GR 6
<b>8113M</b>	<b>2248</b>	<b>2538</b>	<b>2629</b>	<b>2832</b>	<b>3110</b>	<b>3335</b>	<b>3630</b>

Dimensions (inches)

seat H	18.0	seat W	21.0	arm H	25.0
total H	33.75	total W	70.5	depth	26.0

Exceeds BIFMA Seating Durability Test to 1000 lbs per two seater  
CAL 133, add \$330 List per three seater



**8113M**  
75 lbs



# CALVIN PUBLIC SEATING

Loveseat with arms

## Standard Features

- Separate seat and back
- Polyurethane arms or wood arms
- Arms are field replaceable
- Wall-saving, 11 gauge oval tube frame
- Frame in any Spectone color
- Velcro removable back covers, replaceable seat
- Used in connected layouts at no upcharge
- Glides
- Ships assembled as 1, 2 or 3 seaters
- Ships 1/carton 15 cu ft

**Contact Spec Customer Service to railroad fabrics (specify repeat info and yardage requirement will be provided) and for repeats greater than 5" x 5"**

## Options

- Choose aluminum (A) or wood (W) side frame. Aluminum side frame available in any Spectone color.
- For wood (W) side frame, specify and add \$110 list. Available in any of 7 standard stains or stain-to-match at no upcharge
- Polyurethane arms available in Black, Sterling Grey or Taupe (RAL 7006)
- Wood arms in Beech are available in any of 7 standard stains or stain-to-match at no upcharge
- Connected and freestanding tables
- Antibacterial and antimicrobial fabrics available
- Different fabric on seat and back at no upcharge
- CAL 133



## Loveseat with arms

COM 3.5 yds  
 1.75 yd COM per single seat  
 1.75 yd COM per single back

MODEL	COM	GR 1	GR 2	GR 3	GR 4	GR 5	GR 6
<b>8101L</b>	<b>1360</b>	<b>1552</b>	<b>1614</b>	<b>1749</b>	<b>1935</b>	<b>2085</b>	<b>2281</b>

Dimensions (inches)

seat H	18.0	seat W	42.0	arm H	25.0
total H	33.75	total W	46.0	depth	26.0

Exceeds BIFMA Seating Durability Test to 750 lbs per chair  
 CAL 133, add \$169 List per chair



**8101L**  
51 lbs





# CALVIN PUBLIC SEATING

## Bariatric Single Seater with arms

### Standard Features

- Separate seat and back
- Polyurethane arms or wood arms
- Arms are field replaceable
- Wall-saving, 11 gauge oval tube frame
- Frame in any Spectone color
- Velcro removable back covers, replaceable seat
- Used in connected layouts at no upcharge
- Glides
- Ships assembled as 1, 2 or 3 seaters
- Ships 1/carton 15 cu ft

**Contact Spec Customer Service to railroad fabrics (specify repeat info and yardage requirement will be provided) and for repeats greater than 5" x 5"**

### Options

- Choose aluminum (A) or wood (W) side frame. Aluminum side frame available in any Spectone color.
- For wood (W) side frame, specify and add \$110 list. Available in any of 7 standard stains or stain-to-match at no upcharge
- Polyurethane arms available in Black, Sterling Grey or Taupe (RAL 7006)
- Wood arms in Beech are available in any of 7 standard stains or stain-to-match at no upcharge
- Connected and freestanding tables
- Antibacterial and antimicrobial fabrics available
- Different fabric on seat and back at no upcharge
- CAL 133



## Bariatric Single Seater with arms

COM 3.0 yds  
 1.5 yd COM per single seat  
 1.5 yd COM per single back

MODEL	COM	GR 1	GR 2	GR 3	GR 4	GR 5	GR 6
<b>8101G</b>	<b>1095</b>	<b>1261</b>	<b>1313</b>	<b>1429</b>	<b>1588</b>	<b>1717</b>	<b>1885</b>

Dimensions (inches)

seat H	18.0	seat W	30.0	arm H	25.0
total H	33.75	total W	34.0	depth	26.0

Exceeds BIFMA Seating Durability Test to 750 lbs per chair  
 CAL 133, add \$137 List per chair



**8101G**  
34 lbs



# CALVIN PUBLIC SEATING

## Highback Single Seater with arms

### Standard Features

- Separate seat and back
- Polyurethane arms or wood arms
- Arms are field replaceable
- Wall-saving, 11 gauge oval tube frame
- Frame in any Spectone color
- Velcro removable back covers, replaceable seat
- Used in connected layouts at no upcharge
- Glides
- Ships assembled as 1, 2 or 3 seaters
- Ships 1/carton 15 cu ft

**Contact Spec Customer Service to railroad fabrics (specify repeat info and yardage requirement will be provided) and for repeats greater than 5" x 5"**

### Options

- Choose aluminum (A) or wood (W) side frame. Aluminum side frame available in any Spectone color.
- For wood (W) side frame, specify and add \$110 list. Available in any of 7 standard stains or stain-to-match at no upcharge
- Polyurethane arms available in Black, Sterling Grey or Taupe (RAL 7006)
- Wood arms in Beech are available in any of 7 standard stains or stain-to-match at no upcharge
- Connected and freestanding tables
- Antibacterial and antimicrobial fabrics available
- Different fabric on seat and back at no upcharge
- CAL 133



### Highback Single Seater with arms

COM 2.5 yds  
 0.75 yd COM per single seat  
 1.75 yd COM per single back

MODEL	COM	GR 1	GR 2	GR 3	GR 4	GR 5	GR 6
<b>8101H</b>	<b>972</b>	<b>1110</b>	<b>1154</b>	<b>1251</b>	<b>1383</b>	<b>1490</b>	<b>1630</b>

Dimensions (inches)

seat H	18.0	seat W	21.0	arm H	25.0
total H	47.50	total W	25.0	depth	26.0

Exceeds BIFMA Seating Durability Test to 500 lbs per chair  
 CAL 133, add \$123 List per chair



**8101H**  
35 lbs



# CALVIN PUBLIC SEATING

Easy Access Hip Single Seater with arms

## Standard Features

- Separate seat and back
- Polyurethane arms or wood arms
- Arms are field replaceable
- Wall-saving, 11 gauge oval tube frame
- Frame in any Spectone color
- Velcro removable back covers, replaceable seat
- Used in connected layouts at no upcharge
- Glides
- Ships assembled as 1, 2 or 3 seaters
- Ships 1/carton 15 cu ft

## Options

- Choose aluminum (A) or wood (W) side frame. Aluminum side frame available in any Spectone color.
- For wood (W) side frame, specify and add \$110 list. Available in any of 7 standard stains or stain-to-match at no upcharge
- Polyurethane arms available in Black, Sterling Grey or Taupe (RAL 7006)
- Wood arms in Beech are available in any of 7 standard stains or stain-to-match at no upcharge
- Connected and freestanding tables
- Antibacterial and antimicrobial fabrics available
- Different fabric on seat and back at no upcharge
- CAL 133

**Contact Spec Customer Service to railroad fabrics (specify repeat info and yardage requirement will be provided) and for repeats greater than 5" x 5"**



## Easy Access Hip Single Seater with arms

COM 1.75 yds  
 0.75 yd COM per single seat  
 1.0 yd COM per single back

MODEL	COM	GR 1	GR 2	GR 3	GR 4	GR 5	GR 6
<b>8101ME</b>	<b>998</b>	<b>1094</b>	<b>1124</b>	<b>1192</b>	<b>1285</b>	<b>1360</b>	<b>1459</b>

Dimensions (inches)

seat H	24.0	seat W	21.0	arm H	31.5
total H	46.0	total W	25.0	depth	26.0

Exceeds BIFMA Seating Durability Test to 500 lbs per chair  
 CAL 133, add \$110 List per chair



**8101ME**  
35 lbs

## CALVIN PUBLIC SEATING

### Freestanding Lounge Tables – Corner and Spacer Connecting Tables

#### Standard Features

- Tops in laminate or veneer
- Laminate tops in any standard Arborite, Formica, Nevamar, Pionite or Wilsonart matte finish
- Freestanding lounge tables available with PVC, 2mm Bio, Self Edge or hardwood (HB) edge
- Connecting table tops available with PVC Flat edge, Self edge or hardwood (HB) edge
- Veneers in Cherry, Mahogany, Maple, Oak, Chocolate, Pecan and Walnut
- Select from 7 standard stains or stain-to-match at no upcharge
- Oval steel table legs available in any Spectone color
- Tops utilize Nu Green earth friendly core
- Threaded replaceable glides
- 18" height

#### Options

- Non-standard laminates, contact Spec for pricing
- Custom size spacer tables for restricted spaces
- Other sizes may be available

*Radius Corner Tables are recommended for open areas*

#### Freestanding Lounge Tables

Model	Laminate PVC/Self/2MM	Laminate HB Edge	Veneer HB Edge	Weight	Cu.Ft.
81 - 24 x 24 SQ	<b>584</b>	<b>763</b>	<b>904</b>	47	7.2
81 - 24 x 48 RE	<b>732</b>	<b>928</b>	<b>1127</b>	64	18
81 - 30 x 30 SQ	<b>682</b>	<b>812</b>	<b>964</b>	57	13.5
81 - 22 DIA	<b>732</b>	<b>1061</b>	<b>1248</b>	47	7.2



#### Corner and Spacer Connecting Tables

Model	Laminate PVC/Self Edge	Laminate HB Edge	Veneer HB Edge	Weight	Cu.Ft.
81RC - 28 x 28 <i>Radius Corner Table</i>	<b>762</b>	<b>1022</b>	<b>1197</b>	26	2
81SC - 28 x 28 <i>Square Corner Table</i>	<b>832</b>	<b>1011</b>	<b>1115</b>	26	2
81TC - 45 degree <i>Corner Table</i>	<b>762</b>	<b>1022</b>	<b>1197</b>	19	2
81ST - 21 x 24 <i>Spacer Table</i>	<b>517</b>	<b>729</b>	<b>835</b>	19	2
81ET - 21 x 24 <i>End Table</i>	<b>690</b>	<b>902</b>	<b>1010</b>	19	2

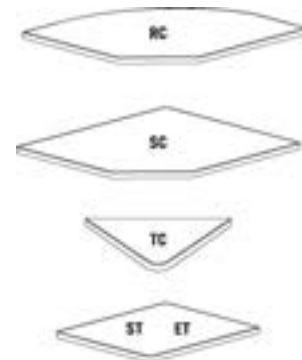

## COMPANION LOUNGE SEATING – Layouts



### Description

- Spec presents the high performance Companion Series, offering warmth, durability, value and an unbeatable array of options and features.
- Your layout possibilities are unlimited with spacer, radius and corner tables – for both standard and bariatric seating in virtually any combination.
- Bariatric seating is a 30" wide seat and is load tested to 750 lbs. Cannot be connected to other bariatric seats.
- Velcro removable seats and backs are standard.
- 21" seat width is standard.
- Choice of wood or polyurethane arms which are replaceable in the field.
- High and medium back contours fit perfectly and provide exceptional comfort.
- All models offer a choice of no center arms, half arms or full arms to the floor.
- A 5° seat pitch is standard. An optional 7° pitch can be specified at no upcharge. A 3° pitch may be specified at an upcharge of \$22 List per seat.
- 1.75" diameter wall-saving frame is standard to protect both wall and fabric.
- Rear glides and separate seat and back are standard.
- Foam formulated to meet California Bulletin 133 standards is available.
- Please send a drawing of the configuration you require with your order.
- Optional floor mounting glides available.
- For fabrics you wish railroaded or repeats larger than 5" x 5", please contact the factory with repeat information and yardage requirement will be provided.

### LAYOUTS AND DIMENSIONS

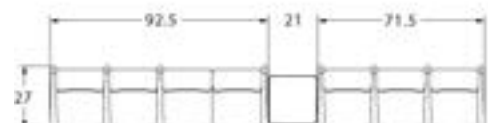
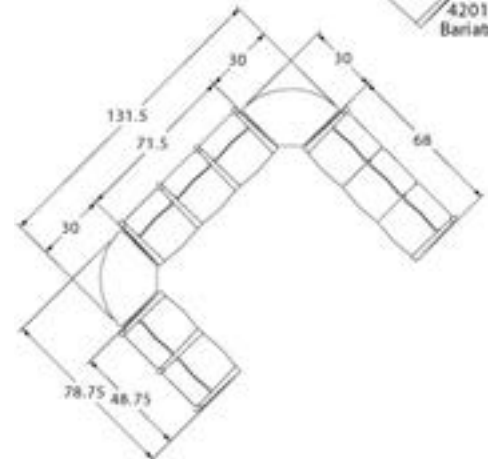
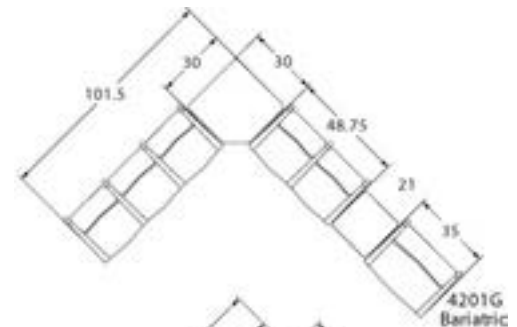



# COMPANION



PLACING AN ORDER IS EASY

## PRODUCT CODE

**4201M**

**Series**

42 : Companion

**Arm/Other**

- 0 : Outside Arms
- 1 : Half Arms
- 2 : Full Arms
- 3 : Easy Access Hip Chair

**Number of Seats**

- 1 : Single Seater
- 2 : Two Seater
- 3 : Three Seater

**Chair Type**

- M : Mid Back
- H : Highback
- G : Bariatric
- ME : Hip Chair



## OPTIONS

**SEAT PITCH**



3°, 5° or 7° Seat Pitch

**ARM TYPE**



Polyurethane



Wood

**HALF ARM PANEL**



## FINISHES

**FRAME**



Select from one of our 76 standard Spectone colors

**FABRIC**



Select fabrics from one of our textile partners

**ARMS**

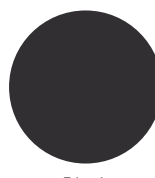

Black

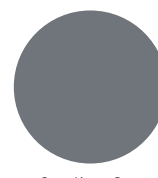

Sterling Grey

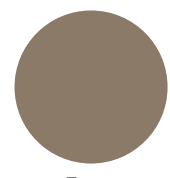

Taupe

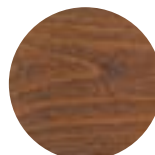

Wood\*

\*Wood arms are available in 7 standard stains and stain-to-match at no upcharge.



# COMPANION Lounge Seating

Medium Back Single Seater with arms

## Standard Features

- Separate seat and back
- Polyurethane arms or wood arms
- Fully welded 1.75" frame
- Frame in any Spectone color
- Velcro removable seat and back covers
- 5° seat pitch
- Use in connected layouts at no upcharge
- Glides
- Arms replaceable in the field
- Ships assembled as 1, 2 or 3 seaters
- Ships 1/carton 15 cu ft

## Options

- Polyurethane arms are available in Black, Sterling Grey and Taupe (RAL 7006)
- Wood arms are available in 7 standard stains and stain-to-match at no upcharge
- 7° seat pitch at no upcharge; 3° seat pitch, add \$22 List/seat
- Connected and freestanding tables
- Antibacterial and antimicrobial fabrics available
- Different fabric on seat and back at no upcharge
- CAL 133

Contact Spec Customer Service to railroad fabrics (specify repeat info and yardage requirement will be provided) and for repeats greater than 5" x 5"



## Medium Back Single Seater with arms

COM 2.0 yds  
1.0 yd COM per single seat  
1.0 yd COM per single back

MODEL	COM	GR 1	GR 2	GR 3	GR 4	GR 5	GR 6
<b>4201M</b>	<b>1072</b>	<b>1177</b>	<b>1211</b>	<b>1283</b>	<b>1385</b>	<b>1466</b>	<b>1572</b>

Dimensions (inches)

seat H	18.0	seat W	21.0	arm H	27.0
total H	32.5	total W	26.0	depth	27.0

Exceeds BIFMA Seating Durability Test to 500 lbs per chair  
CAL 133, add \$99 List per chair



**4201M**  
44 lbs



# COMPANION Lounge Seating

Medium Back Two and Three Seaters with outside arms

## Standard Features

- Separate seat and back
- Polyurethane arms or wood arms
- Fully welded 1.75" frame
- Frame in any Spectone color
- Velcro removable seat and back covers
- 5° seat pitch
- Use in connected layouts at no upcharge
- Glides
- Arms replaceable in the field
- Ships assembled as 1, 2 or 3 seaters
- Ships 1/carton 26 cu ft (2 seater),  
1/carton 39 cu ft (3 seater)

## Options

- Polyurethane arms are available in Black, Sterling Grey and Taupe (RAL 7006)
- Wood arms are available in 7 standard stains and stain-to-match at no upcharge
- 7° seat pitch at no upcharge; 3° seat pitch, add \$22 List/seat
- Connected and freestanding tables
- Antibacterial and antimicrobial fabrics available
- Different fabric on seat and back at no upcharge
- CAL 133

Contact Spec Customer Service to railroad fabrics (specify repeat info and yardage requirement will be provided) and for repeats greater than 5" x 5"

---

### Medium Back Two Seater with outside arms

COM 4.0 yds  
1.0 yd COM per single seat  
1.0 yd COM per single back

MODEL	COM	GR 1	GR 2	GR 3	GR 4	GR 5	GR 6
<b>4202M</b>	<b>1640</b>	<b>1851</b>	<b>1922</b>	<b>2060</b>	<b>2272</b>	<b>2430</b>	<b>2639</b>

Dimensions (inches)

seat H	18.0	seat W	21.0	arm H	27.0
total H	32.5	total W	47.0	depth	27.0

Exceeds BIFMA Seating Durability Test to 750 lbs per two seater  
CAL 133, add \$198 List per two seater



**4202M**  
74 lbs

---

### Medium Back Three Seater with outside arms

COM 6.0 yds  
1.0 yd COM per single seat  
1.0 yd COM per single back

MODEL	COM	GR 1	GR 2	GR 3	GR 4	GR 5	GR 6
<b>4203M</b>	<b>2225</b>	<b>2539</b>	<b>2645</b>	<b>2855</b>	<b>3168</b>	<b>3409</b>	<b>3723</b>

Dimensions (inches)

seat H	18.0	seat W	21.0	arm H	27.0
total H	32.5	total W	68.0	depth	27.0

Exceeds BIFMA Seating Durability Test to 1000 lbs per three seater  
CAL 133, add \$297 List per three seater



**4203M**  
104 lbs





# COMPANION Lounge Seating

Medium Back Two and Three Seaters with half arms

## Standard Features

- Separate seat and back
- Polyurethane arms or wood arms
- Fully welded 1.75" frame
- Frame in any Spectone color
- Velcro removable seat and back covers
- 5° seat pitch
- Use in connected layouts at no upcharge
- Glides
- Arms replaceable in the field
- Ships assembled as 1, 2 or 3 seaters
- Ships 1/carton 26 cu ft (2 seater),  
1/carton 39 cu ft (3 seater)

## Options

- Polyurethane arms are available in Black, Sterling Grey and Taupe (RAL 7006)
- Wood arms are available in 7 standard stains and stain-to-match at no upcharge
- 7° seat pitch at no upcharge; 3° seat pitch, add \$22 List/seat
- Connected and freestanding tables
- Antibacterial and antimicrobial fabrics available
- Different fabric on seat and back at no upcharge
- CAL 133

Contact Spec Customer Service to railroad fabrics (specify repeat info and yardage requirement will be provided) and for repeats greater than 5" x 5"



### Medium Back Two Seater with half arms

COM 4.0 yds  
1.0 yd COM per single seat  
1.0 yd COM per single back

MODEL	COM	GR 1	GR 2	GR 3	GR 4	GR 5	GR 6
<b>4212M</b>	<b>1836</b>	<b>2046</b>	<b>2117</b>	<b>2255</b>	<b>2465</b>	<b>2624</b>	<b>2836</b>

Dimensions (inches)

seat H	18.0	seat W	21.0	arm H	27.0
total H	32.5	total W	48.75	depth	27.0

Exceeds BIFMA Seating Durability Test to 750 lbs per two seater  
CAL 133, add \$198 List per two seater



**4212M**  
79 lbs

### Medium Back Three Seater with half arms

COM 6.0 yds  
1.0 yd COM per single seat  
1.0 yd COM per single back

MODEL	COM	GR 1	GR 2	GR 3	GR 4	GR 5	GR 6
<b>4213M</b>	<b>2539</b>	<b>2852</b>	<b>2958</b>	<b>3168</b>	<b>3482</b>	<b>3723</b>	<b>4037</b>

Dimensions (inches)

seat H	18.0	seat W	21.0	arm H	27.0
total H	32.5	total W	71.5	depth	27.0

Exceeds BIFMA Seating Durability Test to 1000 lbs per three seater  
CAL 133, add \$297 List per three seater



**4213M**  
114 lbs



# COMPANION Lounge Seating

Medium Back Two and Three Seaters with full arms

## Standard Features

- Separate seat and back
- Polyurethane arms or wood arms
- Fully welded 1.75" frame
- Frame in any Spectone color
- Velcro removable seat and back covers
- 5° seat pitch
- Use in connected layouts at no upcharge
- Glides
- Arms replaceable in the field
- Ships assembled as 1, 2 or 3 seaters
- Ships 1/carton 26 cu ft (2 seater),  
1/carton 39 cu ft (3 seater)

## Options

- Polyurethane arms are available in Black, Sterling Grey and Taupe (RAL 7006)
- Wood arms are available in 7 standard stains and stain-to-match at no upcharge
- 7° seat pitch at no upcharge; 3° seat pitch, add \$22 List/seat
- Connected and freestanding tables
- Antibacterial and antimicrobial fabrics available
- Different fabric on seat and back at no upcharge
- CAL 133

Contact Spec Customer Service to railroad fabrics (specify repeat info and yardage requirement will be provided) and for repeats greater than 5" x 5"



### Medium Back Two Seater with full arms

COM 4.0 yds  
1.0 yd COM per single seat  
1.0 yd COM per single back

MODEL	COM	GR 1	GR 2	GR 3	GR 4	GR 5	GR 6
<b>4222M</b>	<b>1864</b>	<b>2074</b>	<b>2144</b>	<b>2283</b>	<b>2494</b>	<b>2652</b>	<b>2862</b>

Dimensions (inches)  
seat H 18.0 seat W 21.0 arm H 27.0  
total H 32.5 total W 48.75 depth 27.0

Exceeds BIFMA Seating Durability Test to 750 lbs per two seater  
CAL 133, add \$198 List per two seater



**4222M**  
82 lbs

### Medium Back Three Seater with full arms

COM 6.0 yds  
1.0 yd COM per single seat  
1.0 yd COM per single back

MODEL	COM	GR 1	GR 2	GR 3	GR 4	GR 5	GR 6
<b>4223M</b>	<b>2670</b>	<b>2985</b>	<b>3091</b>	<b>3301</b>	<b>3616</b>	<b>3856</b>	<b>4169</b>

Dimensions (inches)  
seat H 18.0 seat W 21.0 arm H 27.0  
total H 32.5 total W 71.5 depth 27.0

Exceeds BIFMA Seating Durability Test to 1000 lbs per three seater  
CAL 133, add \$297 List per three seater



**4223M**  
120 lbs



## COMPANION Lounge Seating

Medium Back Bariatric Single Seater with arms

### Standard Features

- Separate seat and back
- Polyurethane arms or wood arms
- Fully welded 1.75" frame
- Frame in any Spectone color
- Velcro removable seat and back covers
- 5° seat pitch
- Use in connected layouts at no upcharge
- Glides
- Arms replaceable in the field
- Cannot connect bariatric seating to bariatric seating
- Ships assembled as 1, 2 or 3 seaters
- Ships 1/carton 20 cu ft

### Options

- Polyurethane arms are available in Black, Sterling Grey and Taupe (RAL 7006)
- Wood arms are available in 7 standard stains and stain-to-match at no upcharge
- Connected and freestanding tables
- Antibacterial and antimicrobial fabrics available
- Different fabric on seat and back at no upcharge
- CAL 133

Contact Spec Customer Service to railroad fabrics (specify repeat info and yardage requirement will be provided) and for repeats greater than 5" x 5"



### Medium Back Bariatric Single Seater with arms

COM 3.25 yds  
 1.5 yd COM per single seat  
 1.75 yd COM per single back

MODEL	COM	GR 1	GR 2	GR 3	GR 4	GR 5	GR 6
<b>4201G</b>	<b>1270</b>	<b>1449</b>	<b>1509</b>	<b>1629</b>	<b>1808</b>	<b>1945</b>	<b>2126</b>

Dimensions (inches)

seat H	18.0	seat W	30.0	arm H	27.0
total H	32.5	total W	35.0	depth	27.0

Exceeds BIFMA Seating Durability Test to 750 lbs per chair  
 CAL 133, add \$149 List per chair



**4201G**  
54 lbs



# COMPANION Lounge Seating

Highback Single Seater with arms  
Ottoman and Headrest

## Standard Features

- Separate seat and back
- Polyurethane arms or wood arms
- Fully welded 1.75" frame
- Frame in any Spectone color
- Velcro removable seat and back covers
- 5° seat pitch
- Use in connected layouts at no upcharge
- Glides
- Arms replaceable in the field
- Ships assembled as 1, 2 or 3 seaters
- Ships 1/carton 19 cu ft
- Ottoman ships 1/carton 5 cu ft

## Options

- Polyurethane arms are available in Black, Sterling Grey and Taupe (RAL 7006)
- Wood arms are available in 7 standard stains and stain-to-match at no upcharge
- 7° seat pitch at no upcharge; 3° seat pitch, add \$22 List/seat
- Vinyl insert, add \$40 List/seat back
- Connected and freestanding tables
- Antibacterial and antimicrobial fabrics available
- Different fabric on seat and back at no upcharge
- CAL 133

Contact Spec Customer Service to railroad fabrics (specify repeat info and yardage requirement will be provided) and for repeats greater than 5" x 5"



## Highback Single Seater with arms

COM 2.25 yds  
1.0 yd COM per single seat  
1.25 yd COM per single back

MODEL	COM	GR 1	GR 2	GR 3	GR 4	GR 5	GR 6
<b>4201H</b>	<b>1127</b>	<b>1243</b>	<b>1283</b>	<b>1359</b>	<b>1475</b>	<b>1563</b>	<b>1678</b>

Dimensions (inches)

seat H	18.0	seat W	21.0	arm H	27.0
total H	45.0	total W	26.0	depth	27.0

Exceeds BIFMA Seating Durability Test to 500 lbs per chair  
CAL 133, add \$123 List per chair



**4201H**  
47 lbs

## Ottoman and Headrest

0.5 yd COM per ottoman  
0.5 yd COM per headrest

MODEL	COM	GR 1	GR 2	GR 3	GR 4	GR 5	GR 6
<b>4230F</b>	<b>386</b>	<b>417</b>	<b>428</b>	<b>450</b>	<b>482</b>	<b>508</b>	<b>551</b>
<b>42HR</b>	<b>65</b>	<b>80</b>	<b>85</b>	<b>93</b>	<b>106</b>	<b>116</b>	<b>135</b>

Ottoman Dimensions (inches)

H	11.5	W	19.25	depth	12.25
---	------	---	-------	-------	-------

CAL 133, add \$50 List per ottoman/\$50 per Headrest



**4230F**  
16 lbs



**42HR**  
1 lbs



# COMPANION Lounge Seating

## Half Panel Arm

To order half panel arms, add Z to model number, e.g. 4201HZ

**Pricing is for one half panel arm, e.g. for a single seater chair with half panel arms, add two half panel arms to cost of chair**

Contact Spec Customer Service to railroad fabrics (specify repeat info and yardage requirement will be provided) and for repeats greater than 5" x 5"

### Options

- Antibacterial and antimicrobial fabrics available
- CAL 133



---

### Half Panel Arm

---

COM 0.5 yds per half panel arm

COM	GR 1	GR 2	GR 3	GR 4	GR 5	GR 6
<b>85</b>	<b>116</b>	<b>125</b>	<b>151</b>	<b>189</b>	<b>213</b>	<b>239</b>

CAL 133, add \$47 List per half panel arm



1.5 lbs per half panel arm



# COMPANION Lounge Seating

Medium Back Easy Access Hip Single Seater with arms

## Standard Features

- Separate seat and back
- Polyurethane arms or wood arms
- Fully welded 1.75" frame
- Frame in any Spectone color
- Velcro removable seat and back covers
- 24" seat height, 3° seat pitch
- Footrest which assists entering/exiting chair
- Glides
- Arms replaceable in the field
- Ships assembled as 1, 2 or 3 seaters
- Ships 1/carton 19 cu ft

## Options

- Polyurethane arms are available in Black, Sterling Grey and Taupe (RAL 7006)
- Wood arms are available in 7 standard stains and stain-to-match at no upcharge
- Antibacterial and antimicrobial fabrics available
- Different fabric on seat and back at no upcharge
- CAL 133

Contact Spec Customer Service to railroad fabrics (specify repeat info and yardage requirement will be provided) and for repeats greater than 5" x 5"



---

## Medium Back Easy Access Hip Single Seater with arms

---

COM 2.0 yds  
 1.0 yd COM per single seat  
 1.0 yd COM per single back

MODEL	COM	GR 1	GR 2	GR 3	GR 4	GR 5	GR 6
<b>4231ME</b>	<b>1172</b>	<b>1276</b>	<b>1310</b>	<b>1382</b>	<b>1485</b>	<b>1565</b>	<b>1671</b>

Dimensions (inches)

seat H	24.0	seat W	21.0	arm H	33.75
total H	39.75	total W	26.0	depth	27.0

Exceeds BIFMA Seating Durability Test to 500 lbs per chair  
 CAL 133, add \$99 List per chair



**4231ME**  
47 lbs

## COMPANION Lounge Seating

### Freestanding Lounge Tables

### Corner and Spacer Connecting Tables

#### Standard Features

- Tops in laminate or veneer
- Laminate tops in any standard Arborite, Formica, Nevamar, Pionite or Wilsonart matte finish
- Freestanding lounge tables available with PVC Flat, 2mm Bio or hardwood (HB) edge
- Connecting table tops available with PVC Flat edge, Self edge or hardwood (HB) edge
- Veneers and hardwood edges stains are standard in Cherry, Mahogany, Maple, Oak, Chocolate, Pecan and Walnut or stain-to-match at no upcharge
- Select from 7 standard stains or stain-to-match at no upcharge
- Fully welded frame with 1.75" steel legs
- Frame in any Spectone color
- Tops utilize Nu Green earth friendly core
- Glides
- 18" height

*Radius Corner Tables are recommended for open areas*

#### Options

- Non-standard laminates, contact Spec for pricing
- Custom size spacer tables for restricted spaces
- Other sizes may be available

#### Freestanding Lounge Tables

Model	Laminate PVC/Self/2MM	Laminate HB Edge	Veneer HB Edge	Weight	Cu.Ft.
42 - 24 DIA	<b>728</b>	<b>1057</b>	<b>1244</b>	27	7.2
42 - 24x24 SQ	<b>756</b>	<b>935</b>	<b>1076</b>	30	7.2
42 - 24x48 RE	<b>904</b>	<b>1100</b>	<b>1299</b>	44	18
42 - 30 DIA	<b>823</b>	<b>1147</b>	<b>1339</b>	37	13.5
42 - 30x30 SQ	<b>854</b>	<b>984</b>	<b>1136</b>	40	13.5



#### Corner and Spacer Connecting Tables

Model	Laminate PVC/Self Edge	Weight	Cu.Ft.
42RC - 30x30 <i>Radius Corner Table</i>	<b>644</b>	31	2
42SC - 30x30 <i>Square Corner Table</i>	<b>644</b>	32	2
42TC45 - 19x23 <i>45 Degree Corner Table</i>	<b>644</b>	26	2
42ST - 21x24 <i>Spacer or End Table</i>	<b>496</b>	23	2

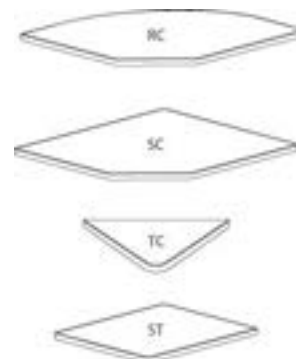

# COOPER COLLECTION LOUNGE SEATING – Layouts

Bala 6200



## Description

- Spec's Bala offers the softer look and feel of wood, without sacrificing high durability.
- Your layout possibilities are unlimited with spacer, radius and corner tables – for both standard and bariatric seating in virtually any combination.
- Bariatric seating is a 30" wide seat and is load tested to 750 lbs. Cannot be connected to other bariatric seats.
- 21" seat width is standard.
- Standard in European Beech in any of 7 standard stains or stain-to-match at no upcharge.
- Choice of wood or polyurethane arms which are replaceable in the field.
- All models offer a choice of no center arms, half arms or full arms to the floor.
- Glides and separate seat and back are standard.
- Foam formulated to meet California Bulletin 133 standards is available.
- Please send a drawing of the configuration you require with your order.
- Ships assembled as one, two and three seater units.
- For fabrics you wish railroaded or repeats larger than 5" x 5", please contact the factory with repeat information and yardage requirement will be provided.

## LAYOUTS AND DIMENSIONS

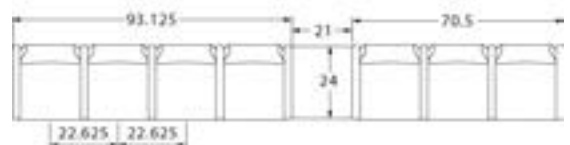
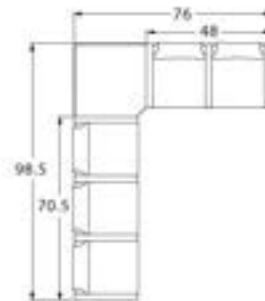
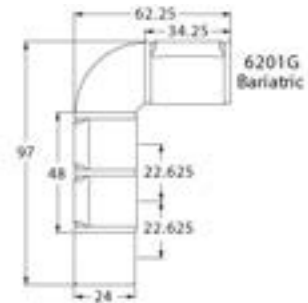





# COOPER BALA

BACK TO CONTENTS



PLACING AN ORDER IS EASY

## PRODUCT CODE

**6201M-WF**

**Collection**  
6 : Cooper

**Series**  
2 : Bala

**Center Arm**  
0 : Outside Arms  
1 : Half Arms  
2 : Full Arms

**Number of Seats**  
1 : Single Seater  
2 : Two Seater  
3 : Three Seater

**Chair Type**  
M : Mid Back  
H : Highback  
G : Bariatric  
ME : Hip Chair  
B : Bench  
BG : Bariatric Bench  
L : Loveseat

**Arm Type**  
WF : Wood Flat Profile  
WR : Wood Round Profile  
PF : Poly Flat Profile  
PR : Poly Round Profile



## OPTIONS

### ARM TYPE



Polyurethane



Wood

### PANEL ARMS



Half Arm Panel



Full Arm Panel

## FINISHES

### FRAME

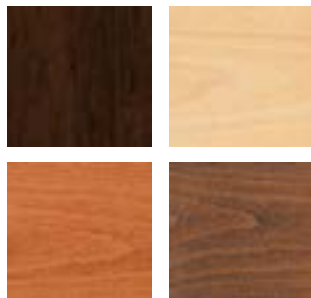

Select from one of our 7 standard wood stains or stain-to-match at no upcharge.

### FABRIC

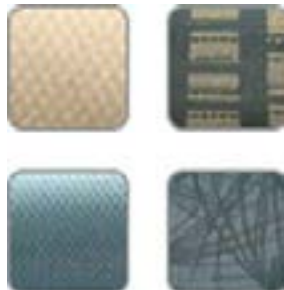

Select fabrics from one of our textile partners

### ARMS

Note: flat poly arm available in Black only.

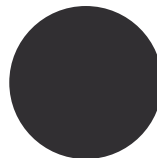

Black

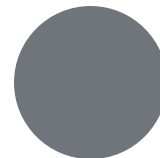

Sterling Grey

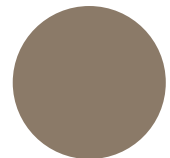

Taupe



Wood\*

\*Wood arms are available in 7 standard stains and stain-to-match at no upcharge.



## COOPER COLLECTION – 6200 Bala

Designed for today's healthcare facilities  
Single Seater with arms

### Standard Features

- Separate seat and back
- Wood components in Beech, in any of 7 standard stains or stain-to-match at no upcharge
- Threaded replaceable glides
- Use in connected layouts at no upcharge
- Velcro removable back covers
- Replaceable seats
- Arms replaceable in the field
- Ships assembled as 1, 2 or 3 seaters
- Ships 1/carton 15 cu ft

Contact Spec Customer Service to railroad fabrics (specify repeat info and yardage requirement will be provided) and for repeats greater than 5" x 5"

### Options

- Wood or polyurethane arms available in flat (WF or PF) or rounded (WR or PR) profile
- Round polyurethane arms available in Black, Sterling Grey and Taupe (RAL 7006)
- Flat polyurethane arms available in Black only
- Add 2.5" to back for overall height of 36.5", add \$44 List/single seat
- Connected and freestanding tables
- 3" clear Cooper Leg Guard, add \$11 List/leg
- Antibacterial and antimicrobial fabrics available
- Different fabric on seat and back at no upcharge
- CAL 133



### Single Seater with arms

COM 1.75 yds  
0.75 yd COM per single seat  
1.0 yd COM per single back

MODEL	COM	GR 1	GR 2	GR 3	GR 4	GR 5	GR 6
<b>6201M</b>	<b>997</b>	<b>1080</b>	<b>1108</b>	<b>1162</b>	<b>1246</b>	<b>1308</b>	<b>1391</b>

Dimensions (inches)

seat H	18.0	seat W	21.0	arm H	25.0
total H	33.75	total W	25.25	depth	25.0

Exceeds BIFMA Seating Durability Test to 500 lbs per chair  
CAL 133, add \$110 List per chair



**6201M**  
27 lbs



# COOPER COLLECTION – 6200 Bala

Designed for today's healthcare facilities  
Two and Three Seaters with outside arms

## Standard Features

- Separate seat and back
- Wood components in Beech, in any of 7 standard stains or stain-to-match at no upcharge
- Threaded replaceable glides
- Use in connected layouts at no upcharge
- Velcro removable back covers
- Replaceable seats
- Arms replaceable in the field
- Ships assembled as 1, 2 or 3 seaters
- Ships 1/carton 26 cu ft (2 seater), 1/carton 39 cu ft (3 seater)

## Options

- Wood or polyurethane arms available in flat (WF or PF) or rounded (WR or PR) profile
- Round polyurethane arms available in Black, Sterling Grey and Taupe (RAL 7006)
- Flat polyurethane arms available in Black only
- Add 2.5" to back for overall height of 36.5", add \$44 List/single seat
- Connected and freestanding tables
- 3" clear Cooper Leg Guard, add \$11 List/leg
- Antibacterial and antimicrobial fabrics available
- Different fabric on seat and back at no upcharge
- CAL 133

Contact Spec Customer Service to railroad fabrics (specify repeat info and yardage requirement will be provided) and for repeats greater than 5" x 5"



### Two Seater with outside arms

COM 3.5 yds  
0.75 yd COM per single seat  
1.0 yd COM per single back

MODEL	COM	GR 1	GR 2	GR 3	GR 4	GR 5	GR 6
<b>6202M</b>	<b>1437</b>	<b>1602</b>	<b>1658</b>	<b>1768</b>	<b>1933</b>	<b>2060</b>	<b>2225</b>

Dimensions (inches)  
seat H 18.0 seat W 21.0 arm H 25.0  
total H 33.75 total W 46.5 depth 25.0

Exceeds BIFMA Seating Durability Test to 750 lbs per two seater  
CAL 133, add \$220 List per two seater



**6202M**  
51 lbs

### Three Seater with outside arms

COM 5.25 yds  
0.75 yd COM per single seat  
1.0 yd COM per single back

MODEL	COM	GR 1	GR 2	GR 3	GR 4	GR 5	GR 6
<b>6203M</b>	<b>1878</b>	<b>2128</b>	<b>2209</b>	<b>2376</b>	<b>2622</b>	<b>2812</b>	<b>3062</b>

Dimensions (inches)  
seat H 18.0 seat W 21.0 arm H 25.0  
total H 33.75 total W 67.5 depth 25.0

Exceeds BIFMA Seating Durability Test to 1000 lbs three seater  
CAL 133, add \$330 List per three seater



**6203M**  
75 lbs



# COOPER COLLECTION – 6200 Bala

Designed for today's healthcare facilities  
Two and Three Seaters with half arms

## Standard Features

- Separate seat and back
- Wood components in Beech, in any of 7 standard stains or stain-to-match at no upcharge
- Threaded replaceable glides
- Use in connected layouts at no upcharge
- Velcro removable back covers
- Replaceable seats
- Arms replaceable in the field
- Ships assembled as 1, 2 or 3 seaters
- Ships 1/carton 26 cu ft (2 seater), 1/carton 39 cu ft (3 seater)

## Options

- Wood or polyurethane arms available in flat (WF or PF) or rounded (WR or PR) profile
- Round polyurethane arms available in Black, Sterling Grey and Taupe (RAL 7006)
- Flat polyurethane arms available in Black only
- Add 2.5" to back for overall height of 36.5", add \$44 List/single seat
- Connected and freestanding tables
- 3" clear Cooper Leg Guard, add \$11 List/leg
- Antibacterial and antimicrobial fabrics available
- Different fabric on seat and back at no upcharge
- CAL 133

Contact Spec Customer Service to railroad fabrics (specify repeat info and yardage requirement will be provided) and for repeats greater than 5" x 5"



### Two Seater with half arms

COM 3.5 yds  
0.75 yd COM per single seat  
1.0 yd COM per single back

MODEL	COM	GR 1	GR 2	GR 3	GR 4	GR 5	GR 6
<b>6212M</b>	<b>1843</b>	<b>2009</b>	<b>2066</b>	<b>2175</b>	<b>2341</b>	<b>2465</b>	<b>2633</b>

Dimensions (inches)  
seat H 18.0 seat W 21.0 arm H 25.0  
total H 33.75 total W 48.0 depth 25.0

Exceeds BIFMA Seating Durability Test to 750 lbs per two seater  
CAL 133, add \$220 List per two seater



**6212M**  
51 lbs

### Three Seater with half arms

COM 5.25 yds  
0.75 yd COM per single seat  
1.0 yd COM per single back

MODEL	COM	GR 1	GR 2	GR 3	GR 4	GR 5	GR 6
<b>6213M</b>	<b>2691</b>	<b>2941</b>	<b>3024</b>	<b>3188</b>	<b>3437</b>	<b>3625</b>	<b>3874</b>

Dimensions (inches)  
seat H 18.0 seat W 21.0 arm H 25.0  
total H 33.75 total W 70.5 depth 25.0

Exceeds BIFMA Seating Durability Test to 1000 lbs per three seater  
CAL 133, add \$330 List per three seater



**6213M**  
75 lbs



# COOPER COLLECTION – 6200 Bala

Designed for today's healthcare facilities  
Two and Three Seaters with full arms

## Standard Features

- Separate seat and back
- Wood components in Beech, in any of 7 standard stains or stain-to-match at no upcharge
- Threaded replaceable glides
- Use in connected layouts at no upcharge
- Velcro removable back covers
- Replaceable seats
- Arms replaceable in the field
- Ships assembled as 1, 2 or 3 seaters
- Ships 1/carton 26 cu ft (2 seater), 1/carton 39 cu ft (3 seater)

## Options

- Wood or polyurethane arms available in flat (WF or PF) or rounded (WR or PR) profile
- Round polyurethane arms available in Black, Sterling Grey and Taupe (RAL 7006)
- Flat polyurethane arms available in Black only
- Add 2.5" to back for overall height of 36.5", add \$44 List/single seat
- Connected and freestanding tables
- 3" clear Cooper Leg Guard, add \$11 List/leg
- Antibacterial and antimicrobial fabrics available
- Different fabric on seat and back at no upcharge
- CAL 133

Contact Spec Customer Service to railroad fabrics (specify repeat info and yardage requirement will be provided) and for repeats greater than 5" x 5"



## Two Seater with full arms

COM 3.5 yds  
0.75 yd COM per single seat  
1.0 yd COM per single back

MODEL	COM	GR 1	GR 2	GR 3	GR 4	GR 5	GR 6
<b>6222M</b>	<b>1843</b>	<b>2009</b>	<b>2066</b>	<b>2175</b>	<b>2341</b>	<b>2465</b>	<b>2633</b>

Dimensions (inches)

seat H	18.0	seat W	21.0	arm H	25.0
total H	33.75	total W	48.0	depth	25.0

Exceeds BIFMA Seating Durability Test to 750 lbs per two seater  
CAL 133, add \$220 List per two seater



**6222M**  
51 lbs

## Three Seater with full arms

COM 5.25 yds  
0.75 yd COM per single seat  
1.0 yd COM per single back

MODEL	COM	GR 1	GR 2	GR 3	GR 4	GR 5	GR 6
<b>6223M</b>	<b>2691</b>	<b>2941</b>	<b>3024</b>	<b>3188</b>	<b>3437</b>	<b>3625</b>	<b>3874</b>

Dimensions (inches)

seat H	18.0	seat W	21.0	arm H	25.0
total H	33.75	total W	70.5	depth	25.0

Exceeds BIFMA Seating Durability Test to 1000 lbs per three seater  
CAL 133, add \$330 List per three seater



**6223M**  
75 lbs



## COOPER COLLECTION – 6200 Bala

Designed for today's healthcare facilities  
 Loveseat with arms

### Standard Features

- Separate seat and back
- Wood components in Beech, in any of 7 standard stains or stain-to-match at no upcharge
- Threaded replaceable glides
- Use in connected layouts at no upcharge
- Velcro removable back covers
- Replaceable seats
- Arms replaceable in the field
- Ships assembled as 1, 2 or 3 seaters
- Ships 1/carton 20 cu ft

### Options

- Wood or polyurethane arms available in flat (WF or PF) or rounded (WR or PR) profile
- Round polyurethane arms available in Black, Sterling Grey and Taupe (RAL 7006)
- Flat polyurethane arms available in Black only
- Connected and freestanding tables
- 3" clear Cooper Leg Guard, add \$11 List/leg
- Antibacterial and antimicrobial fabrics available
- Different fabric on seat and back at no upcharge
- CAL 133

Contact Spec Customer Service to railroad fabrics (specify repeat info and yardage requirement will be provided) and for repeats greater than 5" x 5"



### Loveseat with arms

COM 4.0 yds  
 2.0 yd COM per single seat  
 2.0 yd COM per single back

MODEL	COM	GR 1	GR 2	GR 3	GR 4	GR 5	GR 6
<b>6201L</b>	<b>1556</b>	<b>1748</b>	<b>1812</b>	<b>1943</b>	<b>2132</b>	<b>2281</b>	<b>2476</b>

Dimensions (inches)

seat H	18.0	seat W	42.0	arm H	25.0
total H	33.75	total W	44.75	depth	25.0

Exceeds BIFMA Seating Durability Test to 750 lbs per chair  
 CAL 133, add \$169 List per chair



**6201L**  
 51 lbs



## COOPER COLLECTION – 6200 Bala

Designed for today's healthcare facilities  
Bariatric Single Seater with arms

### Standard Features

- Separate seat and back
- Wood components in Beech, in any of 7 standard stains or stain-to-match at no upcharge
- Threaded replaceable glides
- Use in connected layouts at no upcharge
- Bariatric seating cannot connect to bariatric seating
- Velcro removable back covers
- Replaceable seats
- Arms replaceable in the field
- Ships assembled as 1, 2 or 3 seaters
- Ships 1/carton 20 cu ft

### Options

- Wood or polyurethane arms available in flat (WF or PF) or rounded (WR or PR) profile
- Round polyurethane arms available in Black, Sterling Grey and Taupe (RAL 7006)
- Flat polyurethane arms available in Black only
- Connected and freestanding tables
- 3" clear Cooper Leg Guard, add \$11 List/leg
- Antibacterial and antimicrobial fabrics available
- Different fabric on seat and back at no upcharge
- CAL 133

Contact Spec Customer Service to railroad fabrics (specify repeat info and yardage requirement will be provided) and for repeats greater than 5" x 5"



### Bariatric Single Seater with arms

COM 3.0 yds  
1.5 yd COM per single seat  
1.5 yd COM per single back

MODEL	COM	GR 1	GR 2	GR 3	GR 4	GR 5	GR 6
<b>6201G</b>	<b>1186</b>	<b>1352</b>	<b>1407</b>	<b>1517</b>	<b>1682</b>	<b>1808</b>	<b>1973</b>

Dimensions (inches)

seat H	18.0	seat W	30.0	arm H	25.0
total H	33.75	total W	34.25	depth	25.0

Exceeds BIFMA Seating Durability Test to 750 lbs per chair  
CAL 133, add \$137 List per chair



**6201G**  
34 lbs



# COOPER COLLECTION – 6200 Bala

Designed for today's healthcare facilities  
 Highback Single Seater with arms – Ottoman and Headrest

## Standard Features

- Separate seat and back
- Wood components in Beech, in any of 7 standard stains or stain-to-match at no upcharge
- Threaded replaceable glides
- Use in connected layouts at no upcharge
- Velcro removable back covers
- Replaceable seats
- Arms replaceable in the field
- Ships assembled as 1, 2 or 3 seaters
- Ships 1/carton 19 cu ft
- Ottoman ships 1/carton 5 cu ft

## Options

- Wood or polyurethane arms available in flat (WF or PF) or rounded (WR or PR) profile
- Round polyurethane arms available in Black, Sterling Grey and Taupe (RAL 7006)
- Flat polyurethane arms available in Black only
- Built-in headrest or removeable headrest with velcro strap
- Connected and freestanding tables
- 3" clear Cooper Leg Guard, add \$11 List/leg
- Antibacterial and antimicrobial fabrics available
- Different fabric on seat and back at no upcharge
- CAL 133

Contact Spec Customer Service to railroad fabrics (specify repeat info and yardage requirement will be provided) and for repeats greater than 5" x 5"



## Highback Single Seater with arms

COM 2.5 yds  
 0.75 yd COM per single seat  
 1.75 yds COM per single back

MODEL	COM	GR 1	GR 2	GR 3	GR 4	GR 5	GR 6
<b>6201H</b>	<b>1067</b>	<b>1195</b>	<b>1239</b>	<b>1327</b>	<b>1456</b>	<b>1556</b>	<b>1720</b>

Dimensions (inches)

seat H	18.0	seat W	21.0	arm H	25.0
total H	47.5	total W	25.25	depth	25.0

Exceeds BIFMA Seating Durability Test to 500 lbs per chair  
 CAL 133, add \$123 List per chair



**6201H**  
35 lbs

## Ottoman and Headrest

0.5 yd COM per ottoman  
 0.5 yd COM per headrest

MODEL	COM	GR 1	GR 2	GR 3	GR 4	GR 5	GR 6
<b>6230F</b>	<b>452</b>	<b>482</b>	<b>495</b>	<b>515</b>	<b>550</b>	<b>573</b>	<b>618</b>
<b>60HR</b>	<b>63</b>	<b>73</b>	<b>84</b>	<b>92</b>	<b>106</b>	<b>116</b>	<b>132</b>

Ottoman Dimensions (inches)

H	11.5	W	19.25	depth	12.25
---	------	---	-------	-------	-------

CAL 133, add \$50 List per ottoman/ \$50 per Headrest



**6230F**  
16 lbs



**60HR**  
1 lbs





## COOPER COLLECTION – 6200 Bala

Designed for today's healthcare facilities  
Half and Full Panel Arms

To order half panel arms, add Z to model number, e.g. 6201**Z**

To order full panel arms, add ZC to model number, e.g. 6201**ZC**

**Pricing is for one half panel arm, e.g. for a single seater chair with half panel arms, add two half panel arms to cost of chair**

Contact Spec Customer Service to railroad fabrics (specify repeat info and yardage requirement will be provided) and for repeats greater than 5" x 5"

### Options

- Antibacterial and antimicrobial fabrics available
- CAL 133



### Half and Full Panel Arms

COM 0.5 yds per half panel arm

COM	GR 1	GR 2	GR 3	GR 4	GR 5	GR 6
<b>71</b>	<b>93</b>	<b>99</b>	<b>114</b>	<b>136</b>	<b>152</b>	<b>177</b>

COM 0.75 yds per full panel arm

COM	GR 1	GR 2	GR 3	GR 4	GR 5	GR 6
<b>134</b>	<b>175</b>	<b>189</b>	<b>216</b>	<b>258</b>	<b>291</b>	<b>319</b>

CAL 133, add \$38 List per half panel arm / \$74 List per full panel arm



1.5 lbs per half panel arm



3 lbs per full panel arm



## COOPER COLLECTION – 6200 Bala

Designed for today's healthcare facilities  
Easy Access Hip Single Seater with arms

### Standard Features

- Separate seat and back
- Wood components in Beech, in any of 7 standard stains or stain-to-match at no upcharge
- Threaded replaceable glides
- 24" seat height, no seat pitch (level)
- Footrest which assists entering/exiting chair
- Velcro replaceable back covers
- Replaceable seats
- Arms replaceable in the field
- Ships assembled
- Ships 1/carton 19 cu ft

### Options

- Wood or polyurethane arms available in flat (WF or PF) or rounded (WR or PR) profile
- Round polyurethane arms available in Black, Sterling Grey and Taupe (RAL 7006)
- Flat polyurethane arms available in Black only
- 3" clear Cooper Leg Guard, add \$11 List/leg
- Antibacterial and antimicrobial fabrics available
- Different fabric on seat and back at no upcharge
- CAL 133

Contact Spec Customer Service to railroad fabrics (specify repeat info and yardage requirement will be provided) and for repeats greater than 5" x 5"



### Easy Access Hip Single Seater with arms

COM 1.75 yds  
0.75 yd COM per single seat  
1.0 yd COM per single back

MODEL	COM	GR 1	GR 2	GR 3	GR 4	GR 5	GR 6
<b>6201ME</b>	<b>1202</b>	<b>1285</b>	<b>1312</b>	<b>1367</b>	<b>1450</b>	<b>1512</b>	<b>1596</b>

Dimensions (inches)

seat H	24.0	seat W	21.0	arm H	32.0
total H	46.0	total W	25.25	depth	25.0

Exceeds BIFMA Seating Durability Test to 500 lbs per chair  
CAL 133, add \$110 List per chair



**6201ME**  
35 lbs



# COOPER COLLECTION – 6200 Bala

Designed for today's healthcare facilities  
Single and Two Seater Benches

## Standard Features

- Wood components in Beech, in any of 7 standard stains or stain-to-match at no upcharge
- Threaded replaceable glides
- Use in connected layouts at no upcharge
- Velcro removable back covers
- Replaceable seats
- Arms replaceable in the field
- Ships assembled as 1, 2 or 3 seaters
- Ships 1/carton 9 cu ft (single seater), 14 cu ft (2 seater), 21 cu ft (3 seater)

## Options

- Wood or polyurethane arms, in flat (WF or PF) or rounded (WR or PR) profile, 6" in height, at ends of bench and between seats
- Round polyurethane arms available in Black, Sterling Grey and Taupe (RAL 7006)
- Flat polyurethane arms available in Black only
- Bariatric benches available in Cooper Bala and Cooper Mission
- 3" clear Cooper Leg Guard, add \$11 List/leg
- Antibacterial and antimicrobial fabrics available
- CAL 133

Contact Spec Customer Service to railroad fabrics (specify repeat info and yardage requirement will be provided) and for repeats greater than 5" x 5"



## Single Seater Bench

COM 1.0 yds  
1.0 yd COM per single seat

MODEL	COM	GR 1	GR 2	GR 3	GR 4	GR 5	GR 6
<b>6201B</b>	<b>782</b>	<b>834</b>	<b>853</b>	<b>889</b>	<b>944</b>	<b>985</b>	<b>1061</b>

No arms

<b>6201B</b>	<b>1000</b>	<b>1055</b>	<b>1073</b>	<b>1109</b>	<b>1162</b>	<b>1206</b>	<b>1285</b>
--------------	-------------	-------------	-------------	-------------	-------------	-------------	-------------

End arms (WF/WR or PF/PR)

Dimensions (inches)

seat H	18.0	seat W	21.0	arm H	24.0	depth	26.25
total H	N/A	total W	24.25	total W	25.25		
		w/o arms		w/end arms			

Exceeds BIFMA Seating Durability Test to 500 lbs per bench  
CAL 133, add \$50 List per bench



**6201B**  
22 lbs

## Two Seater Bench

COM 2.0 yds  
1.0 yd COM per single seat

MODEL	COM	GR 1	GR 2	GR 3	GR 4	GR 5	GR 6
<b>6202B</b>	<b>1017</b>	<b>1125</b>	<b>1160</b>	<b>1233</b>	<b>1342</b>	<b>1423</b>	<b>1564</b>

No arms

<b>6202B</b>	<b>1236</b>	<b>1344</b>	<b>1381</b>	<b>1452</b>	<b>1561</b>	<b>1643</b>	<b>1787</b>
--------------	-------------	-------------	-------------	-------------	-------------	-------------	-------------

End arms (WF/WR or PF/PR)

<b>6212B</b>	<b>1552</b>	<b>1661</b>	<b>1697</b>	<b>1769</b>	<b>1877</b>	<b>1959</b>	<b>2111</b>
--------------	-------------	-------------	-------------	-------------	-------------	-------------	-------------

Arms between and at ends (WF/WR or PF/PR)

Dimensions (inches)

seat H	18.0	seat W	21.0	arm H	24.0	depth	26.25
total H	N/A	total W	45.25	total W	46.25	total W	47.75
		w/o arms		w/end arms		w/arms between and at ends	

Exceeds BIFMA Seating Durability Test to 750 lbs per two seat bench  
CAL 133, add \$100 List per two seat bench



**6212B**  
41 lbs



# COOPER COLLECTION – 6200 Bala

Designed for today's healthcare facilities  
Three Seater Bench

### Standard Features

- Wood components in Beech, in any of 7 standard stains or stain-to-match at no upcharge
- Use in connected layouts at no upcharge
- Threaded replaceable glides
- Velcro removable back covers
- Replaceable seats
- Arms replaceable in the field
- Ships assembled as 1, 2 or 3 seaters
- Ships 1/carton 9 cu ft (single seater), 14 cu ft (2 seater), 21 cu ft (3 seater)

### Options

- Wood or polyurethane arms, in flat (WF or PF) or rounded (WR or PR) profile, 6" in height, at ends of bench and between seats
- Round polyurethane arms available in Black, Sterling Grey and Taupe (RAL 7006)
- Flat polyurethane arms available in Black only
- Bariatric benches available in Cooper Bala and Cooper Mission
- 3" clear Cooper Leg Guard, add \$11 List/leg
- Antibacterial and antimicrobial fabrics available
- CAL 133

Contact Spec Customer Service to railroad fabrics (specify repeat info and yardage requirement will be provided) and for repeats greater than 5" x 5"



### Three Seater Bench

COM 3.0 yds  
1.0 yd COM per single seat

MODEL	COM	GR 1	GR 2	GR 3	GR 4	GR 5	GR 6
<b>6203B</b>	<b>1311</b>	<b>1473</b>	<b>1527</b>	<b>1635</b>	<b>1798</b>	<b>1922</b>	<b>2128</b>

No arms

<b>6203B</b>	<b>1527</b>	<b>1689</b>	<b>1744</b>	<b>1853</b>	<b>2016</b>	<b>2137</b>	<b>2348</b>
--------------	-------------	-------------	-------------	-------------	-------------	-------------	-------------

End arms (WF/WR or PF/PR)

<b>6213B</b>	<b>2217</b>	<b>2380</b>	<b>2434</b>	<b>2541</b>	<b>2703</b>	<b>2827</b>	<b>3052</b>
--------------	-------------	-------------	-------------	-------------	-------------	-------------	-------------

Arms between and at ends (WF/WR or PF/PR)

Dimensions (inches)

seat H	18.0	seat W	21.0	arm H	24.0	depth	26.25
total H	N/A	total W	66.25	total W	67.25	total W	70.50
		w/o arms		w/end arms		w/arms between and at ends	



**6203B**  
60 lbs

Exceeds BIFMA Seating Durability Test to 1000 lbs per three seat bench  
CAL 133, add \$150 List per three seat bench





# COOPER COLLECTION – 6200 Bala

Designed for today's healthcare facilities  
Bariatric Single and Two Seater Benches

## Standard Features

- Wood components in Beech, in any of 7 standard stains or stain-to-match at no upcharge
- Bariatric seating cannot connect to bariatric seating
- Threaded replaceable glides
- Use in connected layouts at no upcharge
- Velcro removable back covers
- Replaceable seats
- Arms replaceable in the field
- Ships assembled as 1, 2 or 3 seaters
- Ships 1/carton 15 cu ft (single seater), 20 cu ft (2 seater)

## Options

- Wood or polyurethane arms, in flat (WF or PF) or rounded (WR or PR) profile, 6" in height, at ends of bench and between seats
- Round polyurethane arms available in Black, Sterling Grey and Taupe (RAL 7006)
- Flat polyurethane arms available in Black only
- 3" clear Cooper Leg Guard, add \$11 List/leg
- Antibacterial and antimicrobial fabrics available
- CAL 133

Contact Spec Customer Service to railroad fabrics (specify repeat info and yardage requirement will be provided) and for repeats greater than 5" x 5"



## Bariatric Single Seater Bench

COM 1.5 yds  
1.5 yd COM per single seat

MODEL	COM	GR 1	GR 2	GR 3	GR 4	GR 5	GR 6
<b>6201BG</b>	<b>1153</b>	<b>1213</b>	<b>1234</b>	<b>1275</b>	<b>1338</b>	<b>1386</b>	<b>1477</b>

End arms (WF/WR or PF/PR)

Dimensions (inches)

	seat H	18.0	seat W	30.0	arm H	24.0	depth	26.25
total H	24.0	total W	34.25					

Exceeds BIFMA Seating Durability Test to 750 lbs per bench  
CAL 133, add \$70 List per bench



**6201BG**  
30 lbs

## Bariatric Two Seater Bench

COM 3.0 yds  
1.5 yd COM per single seat

MODEL	COM	GR 1	GR 2	GR 3	GR 4	GR 5	GR 6
<b>6222BG</b>	<b>1786</b>	<b>1910</b>	<b>1951</b>	<b>2035</b>	<b>2159</b>	<b>2254</b>	<b>2429</b>

Arms between and at ends (WF/WR or PF/PR)

Dimensions (inches)

	seat H	18.0	seat W	30.0	arm H	24.0	depth	26.25
total H	24.0	total W	66.0					

Exceeds BIFMA Seating Durability Test to 1000 lbs per two seat bench  
CAL 133, add \$140 List per two seat bench



**6222BG**  
50 lbs



# COOPER COLLECTION – 6200 Bala

Designed for today's healthcare facilities

Freestanding Lounge Tables – Corner and Spacer Connecting Tables

## Standard Features

- Tops in laminate or veneer
- Laminate tops in any standard Arborite, Formica, Nevamar, Pionite or Wilsonart matte finish
- Freestanding lounge tables available with PVC, 2mm Bio or hardwood (HB) edge
- Connecting table tops available with PVC Flat edge, Self edge or hardwood (HB) edge
- Veneers in Cherry, Mahogany, Maple, Oak, Chocolate, Pecan and Walnut
- Select from 7 standard stains or stain-to-match at no upcharge
- Beech legs and Beech table skirts stained the same
- Tops utilize Nu Green earth friendly core
- Threaded replaceable glides
- 18" height

## Options

- Non-standard laminates, contact Spec for pricing
- 3" clear Cooper Leg Guard, add \$11 List/leg
- Custom size spacer tables for restricted spaces
- Other sizes may be available

*Radius Corner Tables are recommended for open areas*

## Freestanding Lounge Tables

Model	Laminate PVC/Self/2MM	Laminate HB Edge	Veneer HB Edge	Weight	Cu.Ft.
62 - 24 x 24 SQ	<b>744</b>	<b>923</b>	<b>1064</b>	47	7.2
62 - 24 x 48 RE	<b>892</b>	<b>1088</b>	<b>1287</b>	64	18
62 - 30 x 30 SQ	<b>842</b>	<b>972</b>	<b>1124</b>	57	13.5
62 - 22 DIA	<b>887</b>	<b>1216</b>	<b>1403</b>	47	7.2



## Corner and Spacer Connecting Tables

Model	Laminate PVC/Self Edge	Laminate HB Edge	Veneer HB Edge	Weight	Cu.Ft.
62RC - 28 x 28 <i>Radius Corner Table</i>	<b>762</b>	<b>1022</b>	<b>1197</b>	42	2
62SC - 28 x 28 <i>Square Corner Table</i>	<b>832</b>	<b>1011</b>	<b>1115</b>	46	2
62TC - 45 degree <i>Corner Table</i>	<b>762</b>	<b>1022</b>	<b>1197</b>	40	2
62ST - 21 x 24 <i>Spacer Table</i>	<b>517</b>	<b>729</b>	<b>835</b>	27	2
62ET - 21 x 24 <i>End Table</i>	<b>690</b>	<b>902</b>	<b>1010</b>	37	2

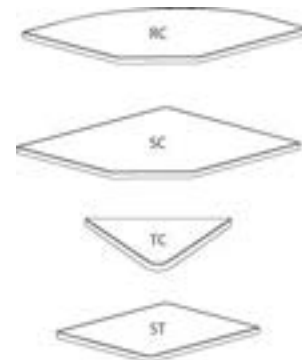

# COOPER COLLECTION LOUNGE SEATING – Layouts

Bracebridge 6500



## Description

- Spec's Bracebridge offers the softer look and feel of wood, without sacrificing high durability.
- Your layout possibilities are unlimited with spacer, radius and corner tables – for both standard and bariatric seating in virtually any combination.
- Bariatric seating is a 30" wide seat and is load tested to 750 lbs. Cannot be connected to other bariatric seats.
- 21" seat width is standard.
- Standard in European Beech in any of 7 standard stains or stain-to-match at no upcharge.
- Choice of wood or polyurethane arms which are replaceable in the field.
- All models offer a choice of no center arms, half arms or full arms to the floor.
- Wall-saving frame is standard to protect both wall and fabric.
- Glides and separate seat and back are standard.
- Foam formulated to meet California Bulletin 133 standards is available.
- Please send a drawing of the configuration you require with your order.
- Ships assembled as one, two and three seater units.
- For fabrics you wish railroaded or repeats larger than 5" x 5", please contact the factory with repeat information and yardage requirement will be provided.

## LAYOUTS AND DIMENSIONS

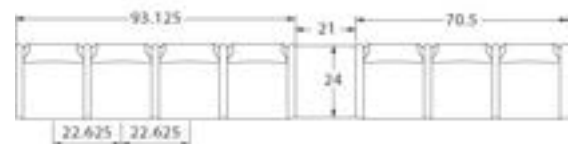
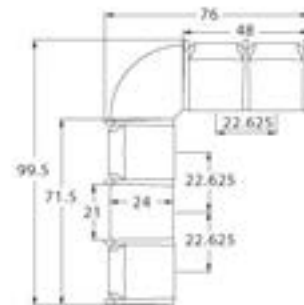
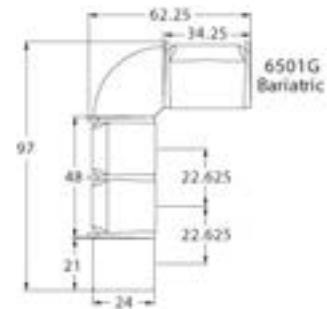



# COOPER BRACEBRIDGE



PLACING AN ORDER IS EASY

## PRODUCT CODE

**6 5 0 1 M**

**Collection**

6 : Cooper

**Series**

5 : Bracebridge

**Center Arm**

0 : Outside Arms

1 : Half Arms

2 : Full Arms

**Number of Seats**

1 : Single Seater

2 : Two Seater

3 : Three Seater

**Chair Type**

M : Mid Back

H : Highback

L : Loveseat

G : Bariatric



## OPTIONS

### ARM CAP



*\*This image does not represent actual product arm cap.*

### SIDE PANEL



Half Panel Arms



Full Panel Arms

## FINISHES

### FRAME

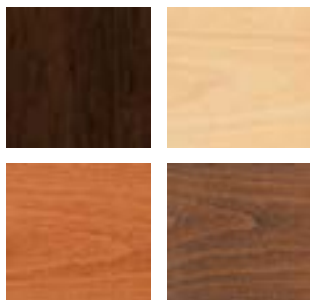

Select from one of our 7 standard wood stains or stain-to-match at no upcharge.

### FABRIC



Select fabrics from one of our textile partners

### ARM CAP



Black

Sterling Grey

Taupe





# COOPER COLLECTION – 6500 Bracebridge

Designed for today's healthcare facilities  
Single Seater with arms

## Standard Features

- Separate seat and back
- Wood arms
- Wood components in Beech, in any of 7 standard stains or stain-to-match at no upcharge
- Wall-saving frame
- Threaded replaceable glides
- Velcro removable back covers
- Replaceable seats
- Use in connected layouts at no upcharge
- Ships assembled as 1, 2 or 3 seaters
- Ships 1/carton 15 cu ft

## Options

- Rounded polyurethane arms, field-replaceable, available in Black, Sterling Grey and Taupe (RAL 7006)
- Add 2.5" to back for overall height of 36.25", add \$44 List/single seat
- Connected and freestanding tables
- 3" clear Cooper Leg Guard, add \$11 List/leg
- Antibacterial and antimicrobial fabrics available
- Different fabric on seat and back at no upcharge
- CAL 133

Contact Spec Customer Service to railroad fabrics (specify repeat info and yardage requirement will be provided) and for repeats greater than 5" x 5"



## Single Seater with arms

COM 1.75 yds  
0.75 yd COM per single seat  
1.0 yd COM per single back

MODEL	COM	GR 1	GR 2	GR 3	GR 4	GR 5	GR 6
<b>6501M</b>	<b>1081</b>	<b>1163</b>	<b>1190</b>	<b>1246</b>	<b>1328</b>	<b>1392</b>	<b>1474</b>

For polyurethane arms add suffix P and \$122

Dimensions (inches)

seat H	18.0	seat W	21.0	arm H	25.0
total H	33.75	total W	25.25	depth	27.5

Exceeds BIFMA Seating Durability Test to 500 lbs per chair  
CAL 133, add \$110 List per chair



**6501M**  
27 lbs



# COOPER COLLECTION – 6500 Bracebridge

Designed for today's healthcare facilities  
Two and Three Seaters with outside arms

## Standard Features

- Separate seat and back
- Wood arms
- Wood components in Beech, in any of 7 standard stains or stain-to-match at no upcharge
- Wall-saving frame
- Threaded replaceable glides
- Velcro removable back covers
- Replaceable seats
- Use in connected layouts at no upcharge
- Ships assembled as 1, 2 or 3 seaters
- Ships 1/carton 26 cu ft (2 seater), 1/carton 39 cu ft (3 seater)

## Options

- Rounded polyurethane arms, field-replaceable, available in Black, Sterling Grey and Taupe (RAL 7006)
- Add 2.5" to back for overall height of 36.25", add \$44 List/single seat
- Connected and freestanding tables
- 3" clear Cooper Leg Guard, add \$11 List/leg
- Antibacterial and antimicrobial fabrics available
- Different fabric on seat and back at no upcharge
- CAL 133

Contact Spec Customer Service to railroad fabrics (specify repeat info and yardage requirement will be provided) and for repeats greater than 5" x 5"

---

## Two Seater with outside arms

COM 3.5 yds  
0.75 yd COM per single seat  
1.0 yd COM per single back

MODEL	COM	GR 1	GR 2	GR 3	GR 4	GR 5	GR 6
<b>6502M</b>	<b>1522</b>	<b>1687</b>	<b>1743</b>	<b>1853</b>	<b>2019</b>	<b>2145</b>	<b>2309</b>

For polyurethane arms add suffix P and \$122

Dimensions (inches)

seat H	18.0	seat W	21.0	arm H	25.0
total H	33.75	total W	46.5	depth	27.5

Exceeds BIFMA Seating Durability Test to 750 lbs per two seater  
CAL 133, add \$220 List per two seater



**6502M**  
51 lbs

---

## Three Seater with outside arms

COM 5.25 yds  
0.75 yd COM per single seat  
1.0 yd COM per single back

MODEL	COM	GR 1	GR 2	GR 3	GR 4	GR 5	GR 6
<b>6503M</b>	<b>1961</b>	<b>2208</b>	<b>2292</b>	<b>2457</b>	<b>2705</b>	<b>2896</b>	<b>3143</b>

For polyurethane arms add suffix P and \$122

Dimensions (inches)

seat H	18.0	seat W	21.0	arm H	25.0
total H	33.75	total W	67.5	depth	27.5

Exceeds BIFMA Seating Durability Test to 1000 lbs per three seater  
CAL 133, add \$330 List per three seater



**6503M**  
75 lbs



# COOPER COLLECTION – 6500 Bracebridge

Designed for today's healthcare facilities  
Two and Three Seaters with half arms

## Standard Features

- Separate seat and back
- Wood arms
- Wood components in Beech, in any of 7 standard stains or stain-to-match at no upcharge
- Wall-saving frame
- Threaded replaceable glides
- Velcro removable back covers
- Replaceable seats
- Use in connected layouts at no upcharge
- Ships assembled as 1, 2 or 3 seaters
- Ships 1/carton 26 cu ft (2 seater), 1/carton 39 cu ft (3 seater)

## Options

- Rounded polyurethane arms, field-replaceable, available in Black, Sterling Grey and Taupe (RAL 7006)
- Add 2.5" to back for overall height of 36.25", add \$44 List/single seat
- Connected and freestanding tables
- 3" clear Cooper Leg Guard, add \$11 List/leg
- Antibacterial and antimicrobial fabrics available
- Different fabric on seat and back at no upcharge
- CAL 133

Contact Spec Customer Service to railroad fabrics (specify repeat info and yardage requirement will be provided) and for repeats greater than 5" x 5"



### Two Seater with half arms

COM 3.5 yds  
0.75 yd COM per single seat  
1.0 yd COM per single back

MODEL	COM	GR 1	GR 2	GR 3	GR 4	GR 5	GR 6
<b>6512M</b>	<b>1998</b>	<b>2163</b>	<b>2220</b>	<b>2330</b>	<b>2495</b>	<b>2620</b>	<b>2787</b>

For polyurethane arms add suffix P and \$183

Dimensions (inches)

seat H	18.0	seat W	21.0	arm H	25.0
total H	33.75	total W	48.0	depth	27.5

Exceeds BIFMA Seating Durability Test to 750 lbs per two seater  
CAL 133, add \$220 List per two seater



**6512M**  
51 lbs

### Three Seater with half arms

COM 5.25 yds  
0.75 yd COM per single seat  
1.0 yd COM per single back

MODEL	COM	GR 1	GR 2	GR 3	GR 4	GR 5	GR 6
<b>6513M</b>	<b>2916</b>	<b>3164</b>	<b>3247</b>	<b>3414</b>	<b>3661</b>	<b>3849</b>	<b>4098</b>

For black polyurethane arms add suffix P and \$244

Dimensions (inches)

seat H	18.0	seat W	21.0	arm H	25.0
total H	33.75	total W	70.5	depth	27.5

Exceeds BIFMA Seating Durability Test to 1000 lbs per three seater  
CAL 133, add \$330 List per three seater



**6513M**  
75 lbs



# COOPER COLLECTION – 6500 Bracebridge

Designed for today's healthcare facilities  
Two and Three Seaters with full arms

## Standard Features

- Separate seat and back
- Wood arms
- Wood components in Beech, in any of 7 standard stains or stain-to-match at no upcharge
- Wall-saving frame
- Threaded replaceable glides
- Velcro removable back covers
- Replaceable seats
- Use in connected layouts at no upcharge
- Ships assembled as 1, 2 or 3 seaters
- Ships 1/carton 26 cu ft (2 seater), 1/carton 39 cu ft (3 seater)

## Options

- Rounded polyurethane arms, field-replaceable, available in Black, Sterling Grey and Taupe (RAL 7006)
- Add 2.5" to back for overall height of 36.25", add \$44 List/single seat
- Connected and freestanding tables
- 3" clear Cooper Leg Guard, add \$11 List/leg
- Antibacterial and antimicrobial fabrics available
- Different fabric on seat and back at no upcharge
- CAL 133

Contact Spec Customer Service to railroad fabrics (specify repeat info and yardage requirement will be provided) and for repeats greater than 5" x 5"



## Two Seater with full arms

COM 3.5 yds  
0.75 yd COM per single seat  
1.0 yd COM per single back

MODEL	COM	GR 1	GR 2	GR 3	GR 4	GR 5	GR 6
<b>6522M</b>	<b>1998</b>	<b>2163</b>	<b>2220</b>	<b>2330</b>	<b>2495</b>	<b>2620</b>	<b>2787</b>

For polyurethane arms add suffix P and \$183

Dimensions (inches)

seat H	18.0	seat W	21.0	arm H	25.0
total H	33.75	total W	48.0	depth	27.5

Exceeds BIFMA Seating Durability Test to 750 lbs per two seater  
CAL 133, add \$220 List per two seater



**6522M**  
51 lbs

## Three Seater with full arms

COM 5.25 yds  
0.75 yd COM per single seat  
1.0 yd COM per single back

MODEL	COM	GR 1	GR 2	GR 3	GR 4	GR 5	GR 6
<b>6523M</b>	<b>2916</b>	<b>3164</b>	<b>3247</b>	<b>3414</b>	<b>3661</b>	<b>3849</b>	<b>4098</b>

For polyurethane arms add suffix P and \$244

Dimensions (inches)

seat H	18.0	seat W	21.0	arm H	25.0
total H	33.75	total W	70.5	depth	27.5

Exceeds BIFMA Seating Durability Test to 1000 lbs per three seater  
CAL 133, add \$330 List per three seater



**6523M**  
75 lbs



# COOPER COLLECTION – 6500 Bracebridge

Designed for today's healthcare facilities  
 Loveseat with arms

## Standard Features

- Separate seat and back
- Wood arms
- Wood components in Beech, in any of 7 standard stains or stain-to-match at no upcharge
- Wall-saving frame
- Threaded replaceable glides
- Velcro removable back covers
- Replaceable seats
- Use in connected layouts at no upcharge
- Ships assembled as 1, 2 or 3 seaters
- Ships 1/carton 20 cu ft

## Options

- Rounded polyurethane arms, field-replaceable, available in Black, Sterling Grey and Taupe (RAL 7006)
- Connected and freestanding tables
- 3" clear Cooper Leg Guard, add \$11 List/leg
- Antibacterial and antimicrobial fabrics available
- Different fabric on seat and back at no upcharge
- CAL 133

Contact Spec Customer Service to railroad fabrics (specify repeat info and yardage requirement will be provided) and for repeats greater than 5" x 5"



## Loveseat with arms

COM 4.0 yds  
 2.0 yd COM per single seat  
 2.0 yd COM per single back

MODEL	COM	GR 1	GR 2	GR 3	GR 4	GR 5	GR 6
<b>6501L</b>	<b>1648</b>	<b>1840</b>	<b>1904</b>	<b>2036</b>	<b>2225</b>	<b>2374</b>	<b>2567</b>

For polyurethane arms add suffix P and \$122

Dimensions (inches)

seat H	18.0	seat W	42.0	arm H	25.0
total H	33.75	total W	44.75	depth	27.5

Exceeds BIFMA Seating Durability Test to 750 lbs per chair  
 CAL 133, add \$169 List per chair



**6501L**  
51 lbs



## COOPER COLLECTION – 6500 Bracebridge

Designed for today's healthcare facilities  
Bariatric Single Seater with arms

### Standard Features

- Separate seat and back
- Wood arms
- Wood components in Beech, in any of 7 standard stains or stain-to-match at no upcharge
- Wall-saving frame
- Threaded replaceable glides
- Velcro removable back covers
- Replaceable seats
- Use in connected layouts at no upcharge
- Bariatric seating cannot connect to bariatric seating
- Ships assembled as 1, 2 or 3 seaters
- Ships 1/carton 20 cu ft

### Options

- Rounded polyurethane arms, field-replaceable, available in Black, Sterling Grey and Taupe (RAL 7006)
- Connected and freestanding tables
- 3" clear Cooper Leg Guard, add \$11 List/leg
- Antibacterial and antimicrobial fabrics available
- Different fabric on seat and back at no upcharge
- CAL 133

Contact Spec Customer Service to railroad fabrics (specify repeat info and yardage requirement will be provided) and for repeats greater than 5" x 5"



### Bariatric Single Seater with arms

COM 3.0 yds  
1.5 yd COM per single seat  
1.5 yd COM per single back

MODEL	COM	GR 1	GR 2	GR 3	GR 4	GR 5	GR 6
<b>6501G</b>	<b>1269</b>	<b>1435</b>	<b>1491</b>	<b>1600</b>	<b>1766</b>	<b>1891</b>	<b>2058</b>

For polyurethane arms add suffix P and \$122

Dimensions (inches)

seat H	18.0	seat W	30.0	arm H	25.0
total H	33.75	total W	34.25	depth	27.5

Exceeds BIFMA Seating Durability Test to 750 lbs per chair  
CAL 133, add \$137 List per chair



**6501G**  
34 lbs



# COOPER COLLECTION – 6500 Bracebridge

Designed for today's healthcare facilities  
 Highback Single Seater with arms – Ottoman and Headrest

## Standard Features

- Separate seat and back
- Wood arms
- Wood components in Beech, in any of 7 standard stains or stain-to-match at no upcharge
- Wall-saving frame
- Threaded replaceable glides
- Velcro removable back covers
- Replaceable seats
- Use in connected layouts at no upcharge
- Ships assembled as 1, 2 or 3 seaters
- Ships 1/carton 20 cu ft
- Ottoman ships 1/carton 5 cu ft

## Options

- Rounded polyurethane arms, field-replaceable, available in Black, Sterling Grey and Taupe (RAL 7006)
- Built-in headrest or removeable headrest with velcro strap
- Connected and freestanding tables
- 3" clear Cooper Leg Guard, add \$11 List/leg
- Antibacterial and antimicrobial fabrics available
- Different fabric on seat and back at no upcharge
- CAL 133

Contact Spec Customer Service to railroad fabrics (specify repeat info and yardage requirement will be provided) and for repeats greater than 5" x 5"



## Highback Single Seater with arms

COM 2.5 yds  
 0.75 yd COM per single seat  
 1.75 yds COM per single back

MODEL	COM	GR 1	GR 2	GR 3	GR 4	GR 5	GR 6
<b>6501H</b>	<b>1152</b>	<b>1281</b>	<b>1322</b>	<b>1411</b>	<b>1541</b>	<b>1639</b>	<b>1805</b>

For polyurethane arms add suffix P and \$122

Dimensions (inches)

seat H	18.0	seat W	21.0	arm H	25.0
total H	47.5	total W	25.25	depth	27.5

Exceeds BIFMA Seating Durability Test to 500 lbs per chair  
 CAL 133, add \$123 List per chair



**6501H**  
35 lbs

## Ottoman and Headrest

0.5 yd COM per ottoman  
 0.5 yd COM per headrest

MODEL	COM	GR 1	GR 2	GR 3	GR 4	GR 5	GR 6
<b>6530F</b>	<b>517</b>	<b>550</b>	<b>562</b>	<b>581</b>	<b>615</b>	<b>640</b>	<b>683</b>
<b>60HR</b>	<b>63</b>	<b>73</b>	<b>84</b>	<b>92</b>	<b>106</b>	<b>116</b>	<b>132</b>

Ottoman Dimensions (inches)

H	11.5	W	19.25	depth	12.25
---	------	---	-------	-------	-------

CAL 133, add \$50 List per ottoman / \$50 per headrest



**6530F**  
16 lbs



**60HR**  
1 lbs



## COOPER COLLECTION – 6500 Bracebridge

Designed for today's healthcare facilities  
Half and Full Panel Arms

### Options

- Antibacterial and antimicrobial fabrics available
- CAL 133

To order half panel arms, add Z to model number,  
e.g. 6501Z

To order full panel arms, add ZC to model number,  
e.g. 6501ZC

**Pricing is for one half panel arm, e.g. for a single seater chair with half panel arms, add two half panel arms to cost of chair**

Contact Spec Customer Service to railroad fabrics (specify repeat info and yardage requirement will be provided) and for repeats greater than 5" x 5"



### Half & Full Panel Arms

COM 0.5 yds per half panel arm

COM	GR 1	GR 2	GR 3	GR 4	GR 5	GR 6
<b>71</b>	<b>93</b>	<b>99</b>	<b>114</b>	<b>136</b>	<b>152</b>	<b>177</b>

COM 0.75 yds per full panel arm

COM	GR 1	GR 2	GR 3	GR 4	GR 5	GR 6
<b>134</b>	<b>175</b>	<b>189</b>	<b>216</b>	<b>258</b>	<b>291</b>	<b>319</b>



1.5 lbs per half panel arm



3 lbs per full panel arm

CAL 133, add \$39 List per half panel arm / \$78 List per full panel arm



## COOPER COLLECTION – 6500 Bracebridge

Designed for today's healthcare facilities

Freestanding Lounge Tables – Corner and Spacer Connecting Tables

### Standard Features

- Tops in laminate or veneer
- Laminate tops in any standard Arborite, Formica, Nevamar, Pionite or Wilsonart matte finish
- Freestanding lounge tables available with PVC, 2mm Bio or hardwood (HB) edge
- Connecting table tops available with PVC Flat edge, Self edge or hardwood (HB) edge
- Veneers in Cherry, Mahogany, Maple, Oak, Chocolate, Pecan and Walnut
- Select from 7 standard stains or stain-to-match at no upcharge
- Beech legs and Beech table skirts stained the same
- Tops utilize Nu Green earth friendly core
- Threaded replaceable glides
- 18" height

### Options

- Non-standard laminates, contact Spec for pricing
- 3" clear Cooper Leg Guard, add \$11 List/leg
- Custom size spacer tables for restricted spaces
- Other sizes may be available

*Radius Corner Tables are recommended for open areas*

### Freestanding Lounge Tables

Model	Laminate PVC/Self/2MM	Laminate HB Edge	Veneer HB Edge	Weight	Cu.Ft.
65 - 24 x 24 SQ	<b>824</b>	<b>1003</b>	<b>1144</b>	47	7.2
65 - 24 x 48 RE	<b>972</b>	<b>1168</b>	<b>1367</b>	64	18
65 - 30 x 30 SQ	<b>922</b>	<b>1052</b>	<b>1204</b>	57	13.5
65 - 22 DIA	<b>966</b>	<b>1295</b>	<b>1482</b>	47	7.2



### Corner and Spacer Connecting Tables

Model	Laminate PVC/Self Edge	Laminate HB Edge	Veneer HB Edge	Weight	Cu.Ft.
65RC - 28 x 28 <i>Radius Corner Table</i>	<b>762</b>	<b>1022</b>	<b>1197</b>	42	2
65SC - 28 x 28 <i>Square Corner Table</i>	<b>832</b>	<b>1011</b>	<b>1115</b>	46	2
65TC - 45 degree <i>Corner Table</i>	<b>762</b>	<b>1022</b>	<b>1197</b>	40	2
65ST - 21 x 24 <i>Spacer Table</i>	<b>517</b>	<b>729</b>	<b>835</b>	27	2
65ET - 21 x 24 <i>End Table</i>	<b>690</b>	<b>902</b>	<b>1010</b>	37	2

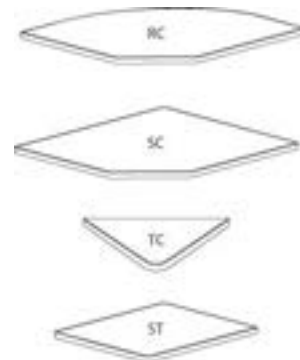

# COOPER COLLECTION LOUNGE SEATING – Layouts

Dwight 6100



## Description

- Spec's Dwight offers a steel leg frame with elements of wood giving it a softer look and feel of wood, without sacrificing high durability.
- Your layout possibilities are unlimited with spacer, radius and corner tables – for both standard and bariatric seating in virtually any combination.
- Bariatric seating is a 30" wide seat and is load tested to 750 lbs. Cannot be connected to other bariatric seats.
- 21" seat width is standard.
- Standard in European Beech in any of 7 standard stains or stain-to-match at no upcharge.
- Choice of wood or polyurethane arms in flat (WF or PF) or rounded (WR or PR) profile.
- Arms are replaceable in the field.
- All models offer a choice of no center arms, half arms or full arms to the floor.
- Glides and separate seat and back are standard.
- Foam formulated to meet California Bulletin 133 standards is available.
- Please send a drawing of the configuration you require with your order.
- Ships assembled as one, two and three seater units.
- For fabrics you wish railroaded or repeats larger than 5" x 5", please contact the factory with repeat information and yardage requirement will be provided.

## LAYOUTS AND DIMENSIONS

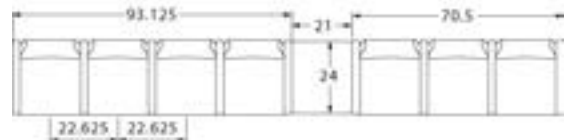
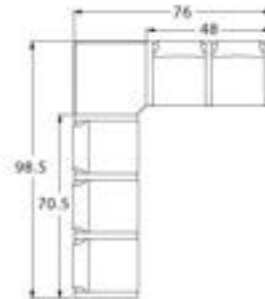
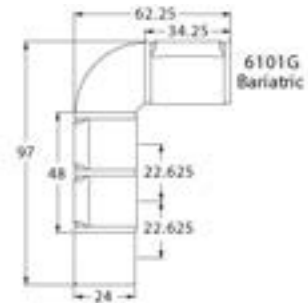



# COOPER DWIGHT



PLACING AN ORDER IS EASY

## PRODUCT CODE

**6101M - WF**

**Collection**

6 : Cooper

**Series**

1 : Dwight

**Center Arm**

0 : Outside Arms  
1 : Half Arms  
2 : Full Arms

**Number of Seats**

1 : Single Seater  
2 : Two Seater  
3 : Three Seater

**Chair Type**

M : Mid Back  
H : Highback  
L : Loveseat  
G : Bariatric  
ME : Hip Chair  
B : Bench

**Arm Type**

WF : Wood Flat Profile  
WR : Wood Round Profile  
PF : Poly Flat Profile  
PR : Poly Round Profile



## OPTIONS

### ARM CAP



Wood Arm



Poly Arm

### SIDE PANEL



Half Panel Arms

## FINISHES

### FRAME



Select from one of our 76 standard Spectone colors

### FABRIC



Select fabrics from one of our textile partners

### ARMS

Note: flat poly arm available in Black only.

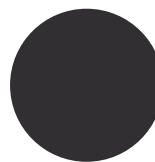

Black

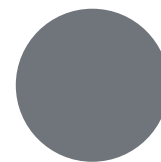

Sterling Grey

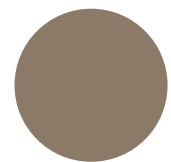

Taupe



Wood\*

\*Wood arms are available in 7 standard stains and stain-to-match at no upcharge.



# COOPER COLLECTION – 6100 Dwight

Designed for today's healthcare facilities  
Single Seater with arms

## Standard Features

- Separate seat and back
- Wood components in Beech, in any of 7 standard stains or stain-to-match at no upcharge
- Fully welded frame with 1.625" steel legs
- Frame in any Spectone color
- Glides
- Velcro removable back covers
- Replaceable seats
- Arms replaceable in the field
- Use in connected layouts at no upcharge
- Ships assembled as 1, 2 or 3 seaters
- Ships 1/carton 15 cu ft

Contact Spec Customer Service to railroad fabrics (specify repeat info and yardage requirement will be provided) and for repeats greater than 5" x 5"

## Options

- Wood or polyurethane arms available in flat (WF or PF) or rounded (WR or PR) profile
- Round polyurethane arms available in Black, Sterling Grey and Taupe (RAL 7006)
- Flat polyurethane arms available in Black only
- Add 2.5" to back for overall height of 36.25", add \$44 List/single seat
- Connected and freestanding tables
- 3" clear Cooper Leg Guard, add \$11 List/leg (not available with Textured paint)
- Antibacterial and antimicrobial fabrics available
- Different fabric on seat and back at no upcharge
- CAL 133



## Single Seater with arms

COM 1.75 yds  
0.75 yd COM per single seat  
1.0 yd COM per single back

MODEL	COM	GR 1	GR 2	GR 3	GR 4	GR 5	GR 6
<b>6101M</b>	<b>976</b>	<b>1059</b>	<b>1085</b>	<b>1141</b>	<b>1224</b>	<b>1287</b>	<b>1370</b>

Dimensions (inches)

seat H	18.0	seat W	21.0	arm H	25.0
total H	33.75	total W	25.25	depth	25.0

Exceeds BIFMA Seating Durability Test to 500 lbs per chair  
CAL 133, add \$110 List per chair



**6101M**  
27 lbs



# COOPER COLLECTION – 6100 Dwight

Designed for today's healthcare facilities  
Two and Three Seaters with outside arms

## Standard Features

- Separate seat and back
- Wood components in Beech, in any of 7 standard stains or stain-to-match at no upcharge
- Fully welded frame with 1.625" steel legs
- Frame in any Spectone color
- Glides
- Velcro removable back covers
- Replaceable seats
- Arms removable in the field
- Use in connected layouts at no upcharge
- Ships assembled as 1, 2 or 3 seaters
- Ships 1/carton 26 cu ft (2 seater), 1/carton 39 cu ft (3 seater)

## Options

- Wood or polyurethane arms available in flat (WF or PF) or rounded (WR or PR) profile
- Round polyurethane arms available in Black, Sterling Grey and Taupe (RAL 7006)
- Flat polyurethane arms available in Black only
- Add 2.5" to back for overall height of 36.25", add \$44 List/single seat
- Connected and freestanding tables
- 3" clear Cooper Leg Guard, add \$11 List/leg (not available with Textured paint)
- Antibacterial and antimicrobial fabrics available
- Different fabric on seat and back at no upcharge
- CAL 133

Contact Spec Customer Service to railroad fabrics (specify repeat info and yardage requirement will be provided) and for repeats greater than 5" x 5"



### Two Seater with outside arms

COM 3.5 yds  
0.75 yd COM per single seat  
1.0 yd COM per single back

MODEL	COM	GR 1	GR 2	GR 3	GR 4	GR 5	GR 6
<b>6102M</b>	<b>1416</b>	<b>1581</b>	<b>1636</b>	<b>1747</b>	<b>1913</b>	<b>2039</b>	<b>2203</b>

Dimensions (inches)

	seat H	18.0	seat W	21.0	arm H	25.0
total H	33.75	total W	46.5	depth	25.0	

Exceeds BIFMA Seating Durability Test to 750 lbs per two seater  
CAL 133, add \$220 List per two seater



**6102M**  
51 lbs

### Three Seater with outside arms

COM 5.25 yds  
0.75 yd COM per single seat  
1.0 yd COM per single back

MODEL	COM	GR 1	GR 2	GR 3	GR 4	GR 5	GR 6
<b>6103M</b>	<b>1857</b>	<b>2107</b>	<b>2188</b>	<b>2353</b>	<b>2602</b>	<b>2792</b>	<b>3039</b>

Dimensions (inches)

	seat H	18.0	seat W	21.0	arm H	25.0
total H	33.75	total W	67.5	depth	25.0	

Exceeds BIFMA Seating Durability Test to 1000 lbs per three seater  
CAL 133, add \$330 List per three seater



**6103M**  
75 lbs



# COOPER COLLECTION – 6100 Dwight

Designed for today's healthcare facilities  
Two and Three Seaters with half arms

## Standard Features

- Separate seat and back
- Wood components in Beech, in any of 7 standard stains or stain-to-match at no upcharge
- Fully welded frame with 1.625" steel legs
- Frame in any Spectone color
- Glides
- Velcro removable back covers
- Replaceable seats
- Arms replaceable in the field
- Use in connected layouts at no upcharge
- Ships assembled as 1, 2 or 3 seaters
- Ships 1/carton 26 cu ft (2 seater), 1/carton 39 cu ft (3 seater)

## Options

- Wood or polyurethane arms available in flat (WF or PF) or rounded (WR or PR) profile
- Round polyurethane arms available in Black, Sterling Grey and Taupe (RAL 7006)
- Flat polyurethane arms available in Black only
- Add 2.5" to back for overall height of 36.25", add \$44 List/single seat
- Connected and freestanding tables
- 3" clear Cooper Leg Guard, add \$11 List/leg (not available with Textured paint)
- Antibacterial and antimicrobial fabrics available
- Different fabric on seat and back at no upcharge
- CAL 133

Contact Spec Customer Service to railroad fabrics (specify repeat info and yardage requirement will be provided) and for repeats greater than 5" x 5"



### Two Seater with half arms

COM 3.5 yds  
0.75 yd COM per single seat  
1.0 yd COM per single back

MODEL	COM	GR 1	GR 2	GR 3	GR 4	GR 5	GR 6
<b>6112M</b>	<b>1805</b>	<b>1970</b>	<b>2026</b>	<b>2136</b>	<b>2300</b>	<b>2428</b>	<b>2593</b>

Dimensions (inches)

seat H	18.0	seat W	21.0	arm H	25.0
total H	33.75	total W	48.0	depth	25.0

Exceeds BIFMA Seating Durability Test to 750 lbs per two seater  
CAL 133, add \$220 List per two seater



**6112M**  
51 lbs

### Three Seater with half arms

COM 5.25 yds  
0.75 yd COM per single seat  
1.0 yd COM per single back

MODEL	COM	GR 1	GR 2	GR 3	GR 4	GR 5	GR 6
<b>6113M</b>	<b>2635</b>	<b>2883</b>	<b>2965</b>	<b>3130</b>	<b>3380</b>	<b>3568</b>	<b>3817</b>

Dimensions (inches)

seat H	18.0	seat W	21.0	arm H	25.0
total H	33.75	total W	70.5	depth	25.0

Exceeds BIFMA Seating Durability Test to 1000 lbs per three seater  
CAL 133, add \$330 List per three seater



**6113M**  
75 lbs



# COOPER COLLECTION – 6100 Dwight

Designed for today's healthcare facilities  
Two and Three Seaters with full arms

## Standard Features

- Separate seat and back
- Wood components in Beech, in any of 7 standard stains or stain-to-match at no upcharge
- Fully welded frame with 1.625" steel legs
- Frame in any Spectone color
- Glides
- Velcro removable back covers
- Replaceable seats
- Arms replaceable in the field
- Use in connected layouts at no upcharge
- Ships assembled as 1, 2 or 3 seaters
- Ships 1/carton 26 cu ft (2 seater), 1/carton 39 cu ft (3 seater)

## Options

- Wood or polyurethane arms available in flat (WF or PF) or rounded (WR or PR) profile
- Round polyurethane arms available in Black, Sterling Grey and Taupe (RAL 7006)
- Flat polyurethane arms available in Black only
- Add 2.5" to back for overall height of 36.25", add \$44 List/single seat
- Connected and freestanding tables
- 3" clear Cooper Leg Guard, add \$11 List/leg (not available with Textured paint)
- Antibacterial and antimicrobial fabrics available
- Different fabric on seat and back at no upcharge
- CAL 133

Contact Spec Customer Service to railroad fabrics (specify repeat info and yardage requirement will be provided) and for repeats greater than 5" x 5"



## Two Seater with full arms

COM 3.5 yds  
0.75 yd COM per single seat  
1.0 yd COM per single back

MODEL	COM	GR 1	GR 2	GR 3	GR 4	GR 5	GR 6
<b>6122M</b>	<b>1805</b>	<b>1970</b>	<b>2026</b>	<b>2136</b>	<b>2300</b>	<b>2428</b>	<b>2593</b>

Dimensions (inches)

seat H	18.0	seat W	21.0	arm H	25.0
total H	33.75	total W	48.5	depth	25.0

Exceeds BIFMA Seating Durability Test to 750 lbs per two seater  
CAL 133, add \$220 List per two seater



**6122M**  
51 lbs

## Three Seater with full arms

COM 5.25 yds  
0.75 yd COM per single seat  
1.0 yd COM per single back

MODEL	COM	GR 1	GR 2	GR 3	GR 4	GR 5	GR 6
<b>6123M</b>	<b>2635</b>	<b>2883</b>	<b>2965</b>	<b>3130</b>	<b>3380</b>	<b>3568</b>	<b>3817</b>

Dimensions (inches)

seat H	18.0	seat W	21.0	arm H	25.0
total H	33.75	total W	70.5	depth	25.0

Exceeds BIFMA Seating Durability Test to 1000 lbs per three seater  
CAL 133, add \$330 List per three seater



**6123M**  
75 lbs



# COOPER COLLECTION – 6100 Dwight

Designed for today's healthcare facilities  
 Loveseat with arms

## Standard Features

- Separate seat and back
- Wood components in Beech, in any of 7 standard stains or stain-to-match at no upcharge
- Fully welded frame with 1.625" steel legs
- Frame in any Spectone color
- Glides
- Velcro removable back covers
- Replaceable seats
- Arms replaceable in the field
- Use in connected layouts at no upcharge
- Ships assembled as 1, 2 or 3 seaters
- Ships 1/carton 20 cu ft

## Options

- Wood or polyurethane arms available in flat (WF or PF) or rounded (WR or PR) profile
- Round polyurethane arms available in Black, Sterling Grey and Taupe (RAL 7006)
- Flat polyurethane arms available in Black only
- Connected and freestanding tables
- 3" clear Cooper Leg Guard, add \$11 List/leg (not available with Textured paint)
- Antibacterial and antimicrobial fabrics available
- Different fabric on seat and back at no upcharge
- CAL 133

Contact Spec Customer Service to railroad fabrics (specify repeat info and yardage requirement will be provided) and for repeats greater than 5" x 5"



## Loveseat with arms

COM 4.0 yds  
 2.0 yd COM per single seat  
 2.0 yd COM per single back

MODEL	COM	GR 1	GR 2	GR 3	GR 4	GR 5	GR 6
<b>6101L</b>	<b>1530</b>	<b>1724</b>	<b>1786</b>	<b>1919</b>	<b>2108</b>	<b>2256</b>	<b>2450</b>

Dimensions (inches)

seat H	18.0	seat W	42.0	arm H	25.0
total H	33.75	total W	44.75	depth	25.0

Exceeds BIFMA Seating Durability Test to 750 lbs per chair  
 CAL 133, add \$169 List per chair



**6101L**  
 51 lbs





# COOPER COLLECTION – 6100 Dwight

Designed for today's healthcare facilities  
Bariatric Single Seater with arms

## Standard Features

- Separate seat and back
- Wood components in Beech, in any of 7 standard stains or stain-to-match at no upcharge
- Fully welded frame with 1.625" steel legs
- Frame in any Spectone color
- Glides
- Velcro removable back covers
- Replaceable seats
- Arms replaceable in the field
- Use in connected layouts at no upcharge
- Bariatric seating cannot connect to bariatric seating
- Ships assembled as 1, 2 or 3 seaters
- Ships 1/carton 20 cu ft

## Options

- Wood or polyurethane arms available in flat (WF or PF) or rounded (WR or PR) profile
- Round polyurethane arms available in Black, Sterling Grey and Taupe (RAL 7006)
- Flat polyurethane arms available in Black only
- Connected and freestanding tables
- 3" clear Cooper Leg Guard, add \$11 List/leg (not available with Textured paint)
- Antibacterial and antimicrobial fabrics available
- Different fabric on seat and back at no upcharge
- CAL 133

Contact Spec Customer Service to railroad fabrics (specify repeat info and yardage requirement will be provided) and for repeats greater than 5" x 5"



## Bariatric Single Seater with arms

COM 3.0 yds  
1.5 yd COM per single seat  
1.5 yd COM per single back

MODEL	COM	GR 1	GR 2	GR 3	GR 4	GR 5	GR 6
<b>6101G</b>	<b>1164</b>	<b>1330</b>	<b>1386</b>	<b>1495</b>	<b>1661</b>	<b>1786</b>	<b>1953</b>

Dimensions (inches)

seat H	18.0	seat W	30.0	arm H	25.0
total H	33.75	total W	34.25	depth	25.0

Exceeds BIFMA Seating Durability Test to 750 lbs per chair  
CAL 133, add \$137 List per chair



**6101G**  
34 lbs



# COOPER COLLECTION – 6100 Dwight

Designed for today's healthcare facilities  
 Highback Single Seater with arms – Ottoman and Headrest

## Standard Features

- Separate seat and back
- Wood components in Beech, in any of 7 standard stains or stain-to-match at no upcharge
- Fully welded frame with 1.625" steel legs
- Frame in any Spectone color
- Glides
- Velcro removable back covers
- Replaceable seats
- Arms replaceable in the field
- Use in connected layouts at no upcharge
- Ships assembled as 1, 2 or 3 seaters
- Ships 1/carton 19 cu ft
- Ottoman ships 1/carton 5 cu ft

## Options

- Wood or polyurethane arms available in flat (WF or PF) or rounded (WR or PR) profile
- Round polyurethane arms available in Black, Sterling Grey and Taupe (RAL 7006)
- Flat polyurethane arms available in Black only
- Built-in headrest or removeable headrest with velcro strap
- Connected and freestanding tables
- 3" clear Cooper Leg Guard, add \$11 List/leg (not available with Textured paint)
- Antibacterial and antimicrobial fabrics available
- Different fabric on seat and back at no upcharge
- CAL 133

Contact Spec Customer Service to railroad fabrics (specify repeat info and yardage requirement will be provided) and for repeats greater than 5" x 5"



## Highback Single Seater with arms

COM 2.5 yds  
 0.75 yd COM per single seat  
 1.75 yds COM per single back

MODEL	COM	GR 1	GR 2	GR 3	GR 4	GR 5	GR 6
<b>6101H</b>	<b>1044</b>	<b>1175</b>	<b>1216</b>	<b>1305</b>	<b>1434</b>	<b>1532</b>	<b>1697</b>

Dimensions (inches)

seat H	18.0	seat W	21.0	arm H	25.0
total H	47.5	total W	25.25	depth	25.0

Exceeds BIFMA Seating Durability Test to 500 lbs per chair  
 CAL 133, add \$123 List per chair



**6101H**  
35 lbs

## Ottoman and Headrest

0.5 yd COM per ottoman  
 0.5 yd COM per headrest

MODEL	COM	GR 1	GR 2	GR 3	GR 4	GR 5	GR 6
<b>6130F</b>	<b>425</b>	<b>457</b>	<b>469</b>	<b>490</b>	<b>524</b>	<b>549</b>	<b>591</b>
<b>60HR</b>	<b>63</b>	<b>73</b>	<b>84</b>	<b>92</b>	<b>106</b>	<b>116</b>	<b>132</b>

Ottoman Dimensions (inches)

H	11.5	W	19.25	depth	12.25
---	------	---	-------	-------	-------

CAL 133, add \$50 List per ottoman / \$50 per headrest



**6130F**  
16 lbs



**60HR**  
1 lbs



## COOPER COLLECTION – 6100 Dwight

Designed for today's healthcare facilities  
Half Panel Arm

To order half panel arms, add Z to model number, e.g. 6101Z

***Pricing is for one half panel arm, e.g. for a single seater chair with half panel arms, add two half panel arms to cost of chair***

*Contact Spec Customer Service to railroad fabrics (specify repeat info and yardage requirement will be provided) and for repeats greater than 5" x 5"*

### Options

- Antibacterial and antimicrobial fabrics available
- CAL 133



---

### Half Panel Arm

---

COM 0.5 yds per half panel arm

COM	GR 1	GR 2	GR 3	GR 4	GR 5	GR 6
<b>71</b>	<b>93</b>	<b>99</b>	<b>114</b>	<b>136</b>	<b>152</b>	<b>177</b>

CAL 133, add \$38 List per half panel arm



1.5 lbs per half panel arm

---



# COOPER COLLECTION – 6100 Dwight

Designed for today's healthcare facilities  
Easy Access Hip Single Seater with arms

## Standard Features

- Separate seat and back
- Wood components in Beech, in any of 7 standard stains or stain-to-match at no upcharge
- Fully welded frame with 1.625" steel legs
- Frame in any Spectone color
- Glides
- Velcro removable back covers
- Replaceable seats
- Arms replaceable in the field
- 24" seat height, no seat pitch (level)
- Footrest which assists entering/exiting chair
- Ships assembled
- Ships 1/carton 19 cu ft

## Options

- Wood or polyurethane arms available in flat (WF or PF) or rounded (WR or PR) profile
- Round polyurethane arms available in Black, Sterling Grey and Taupe (RAL 7006)
- Flat polyurethane arms available in Black only
- 3" clear Cooper Leg Guard, add \$11 List/leg (not available with Textured paint)
- Antibacterial and antimicrobial fabrics available
- Different fabric on seat and back at no upcharge
- CAL 133

Contact Spec Customer Service to railroad fabrics (specify repeat info and yardage requirement will be provided) and for repeats greater than 5" x 5"



## Easy Access Hip Single Seater with arms

COM 1.75 yds  
0.75 yd COM per single seat  
1.0 yd COM per single back

MODEL	COM	GR 1	GR 2	GR 3	GR 4	GR 5	GR 6
<b>6101ME</b>	<b>1180</b>	<b>1264</b>	<b>1290</b>	<b>1346</b>	<b>1428</b>	<b>1491</b>	<b>1575</b>

Dimensions (inches)

seat H	24.0	seat W	21.0	arm H	32.0
total H	46.0	total W	25.25	depth	25.0

Exceeds BIFMA Seating Durability Test to 500 lbs per chair  
CAL 133, add \$110 List per chair



**6101ME**  
35 lbs



# COOPER COLLECTION – 6100 Dwight

Designed for today's healthcare facilities  
Single and Two Seater Benches

## Standard Features

- Wood components in Beech, in any of 7 standard stains or stain-to-match at no upcharge
- Fully welded frame with 1.625" steel legs
- Frame in any Spectone color
- Glides
- Use in connected layouts at no upcharge
- Arms replaceable in the field
- Replaceable seats
- Ships assembled as 1, 2 or 3 seaters
- Ships 1/carton 9 cu ft (single seater), 14 cu ft (2 seater), 21 cu ft (3 seater)

## Options

- Wood or polyurethane arms, in flat (WF or PF) or rounded (WR or PR) profile, 6" in height, at ends of bench and between seats
- Round polyurethane arms available in Black, Sterling Grey and Taupe (RAL 7006)
- Flat polyurethane arms available in Black only
- Bariatric benches available in Cooper Bala and Cooper Mission
- 3" clear Cooper Leg Guard, add \$11 List/leg (not available with Textured paint)
- Antibacterial and antimicrobial fabrics available
- CAL 133

Contact Spec Customer Service to railroad fabrics (specify repeat info and yardage requirement will be provided) and for repeats greater than 5" x 5"



## Single Seater Bench

COM 1.0 yds  
1.0 yd COM per single seat

MODEL	COM	GR 1	GR 2	GR 3	GR 4	GR 5	GR 6
<b>6101B</b>	<b>601</b>	<b>655</b>	<b>673</b>	<b>710</b>	<b>764</b>	<b>804</b>	<b>876</b>
<i>No arms</i>							
<b>6101B</b>	<b>819</b>	<b>874</b>	<b>889</b>	<b>926</b>	<b>980</b>	<b>1022</b>	<b>1099</b>
<i>End arms (WF/WR or PF/PR)</i>							
Dimensions (inches)							
seat H	18.0	seat W	21.0	arm H	24.0	depth	26.25
total H	N/A	total W	24.25	total W	25.25		
		w/o arms		w/end arms			



**6101B**  
22 lbs

Exceeds BIFMA Seating Durability Test to 500 lbs per bench  
CAL 133, add \$50 List per bench

## Two Seater Bench

COM 2.0 yds  
1.0 yd COM per single seat

MODEL	COM	GR 1	GR 2	GR 3	GR 4	GR 5	GR 6
<b>6102B</b>	<b>837</b>	<b>944</b>	<b>980</b>	<b>1053</b>	<b>1161</b>	<b>1244</b>	<b>1381</b>
<i>No arms</i>							
<b>6102B</b>	<b>1054</b>	<b>1163</b>	<b>1200</b>	<b>1270</b>	<b>1380</b>	<b>1462</b>	<b>1602</b>
<i>End arms (WF/WR or PF/PR)</i>							
<b>6112B</b>	<b>1258</b>	<b>1366</b>	<b>1403</b>	<b>1474</b>	<b>1582</b>	<b>1666</b>	<b>1812</b>
<i>Arms between and at ends (WF/WR or PF/PR)</i>							
Dimensions (inches)							
seat H	18.0	seat W	21.0	arm H	24.0	depth	26.25
total H	N/A	total W	45.25	total W	46.25	total W	47.75
		w/o arms		w/end arms		w/arms between and at ends	



**6102B**  
41 lbs

Exceeds BIFMA Seating Durability Test to 750 lbs per two seat bench  
CAL 133, add \$100 List per two seat bench



# COOPER COLLECTION – 6100 Dwight

Designed for today's healthcare facilities  
Three Seater Bench

## Standard Features

- Wood components in Beech, in any of 7 standard stains or stain-to-match at no upcharge
- Fully welded frame with 1.625" steel legs
- Frame in any Spectone color
- Glides
- Use in connected layouts at no upcharge
- Arms replaceable in the field
- Replaceable seats
- Ships assembled as 1, 2 or 3 seaters
- Ships 1/carton 9 cu ft (single seater), 14 cu ft (2 seater), 21 cu ft (3 seater)

## Options

- Wood or polyurethane arms, in flat (WF or PF) or rounded (WR or PR) profile, 6" in height, at ends of bench and between seats
- Round polyurethane arms available in Black, Sterling Grey and Taupe (RAL 7006)
- Flat polyurethane arms available in Black only
- Bariatric benches available in Cooper Bala and Cooper Mission
- 3" clear Cooper Leg Guard, add \$11 List/leg (not available with Textured paint)
- Antibacterial and antimicrobial fabrics available
- CAL 133

Contact Spec Customer Service to railroad fabrics (specify repeat info and yardage requirement will be provided) and for repeats greater than 5" x 5"



## Three Seater Bench

COM 3.0 yds  
1.0 yd COM per single seat

MODEL	COM	GR 1	GR 2	GR 3	GR 4	GR 5	GR 6
<b>6103B</b>	<b>1127</b>	<b>1289</b>	<b>1343</b>	<b>1451</b>	<b>1614</b>	<b>1738</b>	<b>1938</b>
<i>No arms</i>							
<b>6103B</b>	<b>1346</b>	<b>1509</b>	<b>1563</b>	<b>1671</b>	<b>1834</b>	<b>1956</b>	<b>2164</b>
<i>End arms (WF/WR or PF/PR)</i>							
<b>6113B</b>	<b>1812</b>	<b>1974</b>	<b>2027</b>	<b>2136</b>	<b>2298</b>	<b>2423</b>	<b>2639</b>
<i>Arms between and at ends (WF/WR or PF/PR)</i>							

Dimensions (inches)

seat H	18.0	seat W	21.0	arm H	24.0	depth	26.25
total H	N/A	total W	66.25	total W	67.25	total W	70.50
		w/o arms		w/end arms		w/arms between and at ends	

Exceeds BIFMA Seating Durability Test to 1000 lbs per three seat bench  
CAL 133, add \$150 List per three seat bench



**6103B**  
60 lbs





# COOPER COLLECTION – 6100 Dwight

Designed for today's healthcare facilities

Freestanding Lounge Tables – Corner and Spacer Connecting Tables

## Standard Features

- Tops in laminate or veneer
- Laminate tops in any standard Arborite, Formica, Nevamar, Pionite or Wilsonart matte finish
- Freestanding lounge tables available with PVC, 2mm Bio or hardwood (HB) edge
- Connecting table tops available with PVC Flat edge, Self edge or hardwood (HB) edge
- Veneers in Cherry, Mahogany, Maple, Oak, Chocolate, Pecan and Walnut
- Select from 7 standard stains or stain-to-match at no upcharge
- Steel legs and Beech table skirts
- Fully welded frame with 1.625" steel legs
- Frame in any Spectone color
- Tops utilize Nu Green earth friendly core
- Threaded replaceable glides
- 18" height

## Options

- Non-standard laminates, contact Spec for pricing
- 3" clear Cooper Leg Guard, add \$11 List/leg (not available with Textured paint)
- Custom size spacer tables for restricted spaces
- Self edge available at same cost as PVC edge
- Other sizes may be available

*Radius Corner Tables are recommended for open areas*

## Freestanding Lounge Tables

Model	Laminate PVC/Self/2MM	Laminate HB Edge	Veneer HB Edge	Weight	Cu.Ft.
61 - 24 x 24 SQ	<b>584</b>	<b>763</b>	<b>904</b>	47	7.2
61 - 24 x 48 RE	<b>732</b>	<b>928</b>	<b>1127</b>	64	18
61 - 30 x 30 SQ	<b>682</b>	<b>812</b>	<b>964</b>	57	13.5
61 - 22 DIA	<b>732</b>	<b>1061</b>	<b>1248</b>	47	7.2



## Corner and Spacer Connecting Tables

Model	Laminate PVC/Self Edge	Laminate HB Edge	Veneer HB Edge	Weight	Cu.Ft.
61RC - 28 x 28 <i>Radius Corner Tablet</i>	<b>762</b>	<b>1022</b>	<b>1197</b>	42	2
61SC - 28 x 28 <i>Square Corner Table</i>	<b>832</b>	<b>1011</b>	<b>1115</b>	46	2
61TC - 45 degree <i>Corner Table</i>	<b>762</b>	<b>1022</b>	<b>1197</b>	40	2
61ST - 21 x 24 <i>Spacer Table</i>	<b>517</b>	<b>729</b>	<b>835</b>	27	2
61ET - 21 x 24 <i>End Table</i>	<b>690</b>	<b>902</b>	<b>1010</b>	37	2

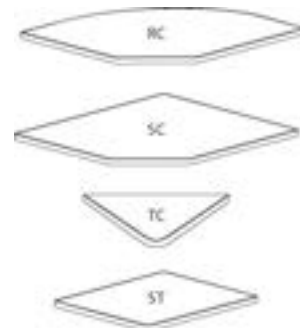

# COOPER COLLECTION LOUNGE SEATING – Layouts

Huntsville 6400



## Description

- Spec's Huntsville offers the softer look and feel of wood, without sacrificing high durability.
- Your layout possibilities are unlimited with spacer, radius and corner tables – for both standard and bariatric seating in virtually any combination.
- Bariatric seating is a 30" wide seat and is load tested to 750 lbs. Cannot be connected to other bariatric seats.
- 21" seat width is standard.
- Standard in European Beech in any of 7 standard stains or stain-to-match at no upcharge.
- Choice of wood or polyurethane arms which are replaceable in the field.
- All models offer a choice of no center arms, half arms or full arms to the floor.
- Wall-saving frame is standard to protect both wall and fabric.
- Glides and separate seat and back are standard.
- Foam formulated to meet California Bulletin 133 standards is available.
- Please send a drawing of the configuration you require with your order.
- Ships assembled as one, two and three seater units.
- For fabrics you wish railroaded or repeats larger than 5" x 5", please contact the factory with repeat information and yardage requirement will be provided.

## LAYOUTS AND DIMENSIONS

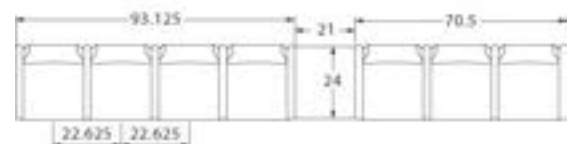
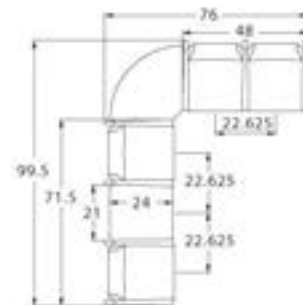
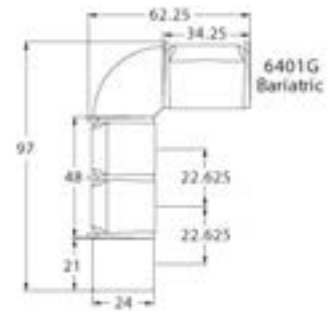



# COOPER HUNTSVILLE



PLACING AN ORDER IS EASY

## PRODUCT CODE

**6 4 0 1 M**

**Collection**  
6 : Cooper

**Series**  
4 : Huntsville

**Center Arm**  
0 : Outside Arms  
1 : Half Arms  
2 : Full Arms

**Number of Seats**  
1 : Single Seater  
2 : Two Seater  
3 : Three Seater

**Chair Type**  
M : Mid Back  
H : Highback  
L : Loveseat  
G : Bariatric



## OPTIONS

### Poly Arm



*\*This image does not represent actual product arm cap.*

### SIDE PANEL



Half Panel Arms



Full Panel Arms

## FINISHES

### FRAME

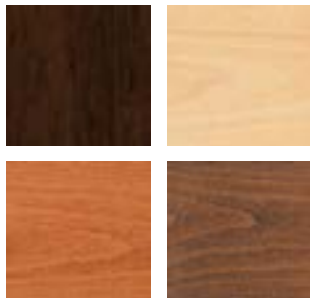

Select from one of our 7 standard wood stains or stain-to-match at no upcharge.

### FABRIC



Select fabrics from one of our textile partners

### ARMS

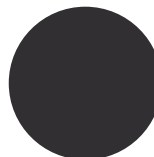

Black



Wood\*

\*Wood arms are available in 7 standard stains and stain-to-match at no upcharge.



# COOPER COLLECTION – 6400 Huntsville

Designed for today's healthcare facilities  
Single Seater with arms

## Standard Features

- Separate seat and back
- Wood arms
- Wood components in Beech, in any of 7 standard stains or stain-to-match at no upcharge
- Wall-saving frame
- Velcro removable back covers
- Replaceable seats
- Threaded replaceable glides
- Use in connected layouts at no upcharge
- Ships assembled as 1, 2 or 3 seaters
- Ships 1/carton 15 cu ft

## Options

- Rounded polyurethane arms, field-replaceable
- Add 2.5" to back for overall height of 36.25", add \$44 List/single seat
- Connected and freestanding tables
- 3" clear Cooper Leg Guard, add \$11 List/leg
- Antibacterial and antimicrobial fabrics available
- Different fabric on seat and back at no upcharge
- CAL 133

Contact Spec Customer Service to railroad fabrics (specify repeat info and yardage requirement will be provided) and for repeats greater than 5" x 5"



## Single Seater with arms

COM 1.75 yds  
0.75 yd COM per single seat  
1.0 yd COM per single back

MODEL	COM	GR 1	GR 2	GR 3	GR 4	GR 5	GR 6
<b>6401M</b>	<b>1013</b>	<b>1097</b>	<b>1123</b>	<b>1178</b>	<b>1262</b>	<b>1324</b>	<b>1408</b>

For polyurethane arms add suffix P and \$122

Dimensions (inches)

seat H	18.0	seat W	21.0	arm H	25.0
total H	33.75	total W	25.25	depth	27.5

Exceeds BIFMA Seating Durability Test to 500 lbs per chair  
CAL 133, add \$110 List per seat



**6401M**  
27 lbs



# COOPER COLLECTION – 6400 Huntsville

Designed for today's healthcare facilities  
Two and Three Seaters with outside arms

## Standard Features

- Separate seat and back
- Wood arms
- Wood components in Beech, in any of 7 standard stains or stain-to-match at no upcharge
- Wall-saving frame
- Velcro removable back covers
- Replaceable seats
- Threaded replaceable glides
- Use in connected layouts at no upcharge
- Ships assembled as 1, 2 or 3 seaters
- Ships 1/carton 26 cu ft (2 seater), 1/carton 39 cu ft (3 seater)

## Options

- Rounded polyurethane arms, field-replaceable
- Add 2.5" to back for overall height of 36.25", add \$44 List/single seat
- Connected and freestanding tables
- 3" clear Cooper Leg Guard, add \$11 List/leg
- Antibacterial and antimicrobial fabrics available
- Different fabric on seat and back at no upcharge
- CAL 133

Contact Spec Customer Service to railroad fabrics (specify repeat info and yardage requirement will be provided) and for repeats greater than 5" x 5"

---

## Two Seater with outside arms

COM 3.5 yds  
0.75 yd COM per single seat  
1.0 yd COM per single back

MODEL	COM	GR 1	GR 2	GR 3	GR 4	GR 5	GR 6
<b>6402M</b>	<b>1454</b>	<b>1619</b>	<b>1674</b>	<b>1784</b>	<b>1949</b>	<b>2077</b>	<b>2241</b>

For polyurethane arms add suffix P and \$122

Dimensions (inches)

	seat H	18.0	seat W	21.0	arm H	25.0
total H	33.75	total W	46.5	depth	27.5	

Exceeds BIFMA Seating Durability Test to 750 lbs per two seater  
CAL 133, add \$220 List per two seater



**6402M**  
51 lbs

---

## Three Seater with outside arms

COM 5.25 yds  
0.75 yd COM per single seat  
1.0 yd COM per single back

MODEL	COM	GR 1	GR 2	GR 3	GR 4	GR 5	GR 6
<b>6403M</b>	<b>1894</b>	<b>2143</b>	<b>2226</b>	<b>2392</b>	<b>2640</b>	<b>2828</b>	<b>3076</b>

For polyurethane arms add suffix P and \$122

Dimensions (inches)

	seat H	18.0	seat W	21.0	arm H	25.0
total H	33.75	total W	67.5	depth	27.5	

Exceeds BIFMA Seating Durability Test to 1000 lbs per three seater  
CAL 133, add \$330 List per three seater



**6403M**  
75 lbs



# COOPER COLLECTION – 6400 Huntsville

Designed for today's healthcare facilities  
Two and Three Seaters with half arms

## Standard Features

- Separate seat and back
- Wood arms
- Wood components in Beech, in any of 7 standard stains or stain-to-match at no upcharge
- Wall-saving frame
- Velcro removable back covers
- Replaceable seats
- Threaded replaceable glides
- Use in connected layouts at no upcharge
- Ships assembled as 1, 2 or 3 seaters
- Ships 1/carton 26 cu ft (2 seater), 1/carton 39 cu ft (3 seater)

## Options

- Rounded polyurethane arms, field-replaceable
- Add 2.5" to back for overall height of 36.25", add \$44 List/single seat
- Connected and freestanding tables
- 3" clear Cooper Leg Guard, add \$11 List/leg
- Antibacterial and antimicrobial fabrics available
- Different fabric on seat and back at no upcharge
- CAL 133

Contact Spec Customer Service to railroad fabrics (specify repeat info and yardage requirement will be provided) and for repeats greater than 5" x 5"



### Two Seater with half arms

COM 3.5 yds  
0.75 yd COM per single seat  
1.0 yd COM per single back

MODEL	COM	GR 1	GR 2	GR 3	GR 4	GR 5	GR 6
<b>6412M</b>	<b>1875</b>	<b>2040</b>	<b>2095</b>	<b>2205</b>	<b>2372</b>	<b>2498</b>	<b>2662</b>

For polyurethane arms add suffix P and \$183

Dimensions (inches)

seat H	18.0	seat W	21.0	arm H	25.0
total H	33.75	total W	48.0	depth	27.5

Exceeds BIFMA Seating Durability Test to 750 lbs per two seater  
CAL 133, add \$220 List per two seater



**6412M**  
51 lbs

### Three Seater with half arms

COM 5.25 yds  
0.75 yd COM per single seat  
1.0 yd COM per single back

MODEL	COM	GR 1	GR 2	GR 3	GR 4	GR 5	GR 6
<b>6413M</b>	<b>2737</b>	<b>2984</b>	<b>3067</b>	<b>3233</b>	<b>3480</b>	<b>3671</b>	<b>3918</b>

For polyurethane arms add suffix P and \$244

Dimensions (inches)

seat H	18.0	seat W	21.0	arm H	25.0
total H	33.75	total W	70.5	depth	27.5

Exceeds BIFMA Seating Durability Test to 1000 lbs per three seater  
CAL 133, add \$330 List per three seater



**6413M**  
75 lbs



# COOPER COLLECTION – 6400 Huntsville

Designed for today's healthcare facilities  
Two and Three Seaters with full arms

## Standard Features

- Separate seat and back
- Wood arms
- Wood components in Beech, in any of 7 standard stains or stain-to-match at no upcharge
- Wall-saving frame
- Velcro removable back covers
- Replaceable seats
- Threaded replaceable glides
- Use in connected layouts at no upcharge
- Ships assembled as 1, 2 or 3 seaters
- Ships 1/carton 26 cu ft (2 seater), 1/carton 39 cu ft (3 seater)

## Options

- Rounded polyurethane arms, field-replaceable
- Add 2.5" to back for overall height of 36.25", add \$44 List/single seat
- Connected and freestanding tables
- 3" clear Cooper Leg Guard, add \$11 List/leg
- Antibacterial and antimicrobial fabrics available
- Different fabric on seat and back at no upcharge
- CAL 133

Contact Spec Customer Service to railroad fabrics (specify repeat info and yardage requirement will be provided) and for repeats greater than 5" x 5"



## Two Seater with full arms

COM 3.5 yds  
0.75 yd COM per single seat  
1.0 yd COM per single back

MODEL	COM	GR 1	GR 2	GR 3	GR 4	GR 5	GR 6
<b>6422M</b>	<b>1875</b>	<b>2040</b>	<b>2095</b>	<b>2205</b>	<b>2372</b>	<b>2498</b>	<b>2662</b>

For polyurethane arms add suffix P and \$183

Dimensions (inches)

seat H	18.0	seat W	21.0	arm H	25.0
total H	33.75	total W	48.0	depth	27.5

Exceeds BIFMA Seating Durability Test to 750 lbs per two seater  
CAL 133, add \$220 List per two seater



**6422M**  
51 lbs

## Three Seater with full arms

COM 5.25 yds  
0.75 yd COM per single seat  
1.0 yd COM per single back

MODEL	COM	GR 1	GR 2	GR 3	GR 4	GR 5	GR 6
<b>6423M</b>	<b>2737</b>	<b>2984</b>	<b>3067</b>	<b>3233</b>	<b>3480</b>	<b>3671</b>	<b>3918</b>

For polyurethane arms add suffix P and \$244

Dimensions (inches)

seat H	18.0	seat W	21.0	arm H	25.0
total H	33.75	total W	70.5	depth	27.5

Exceeds BIFMA Seating Durability Test to 1000 lbs per three seater  
CAL 133, add \$330 List per three seater



**6423M**  
75 lbs



## COOPER COLLECTION – 6400 Huntsville

Designed for today's healthcare facilities  
 Loveseat with arms

### Standard Features

- Separate seat and back
- Wood arms
- Wood components in Beech, in any of 7 standard stains or stain-to-match at no upcharge
- Wall-saving frame
- Velcro removable back covers
- Replaceable seats
- Threaded replaceable glides
- Use in connected layouts at no upcharge
- Ships assembled as 1, 2 or 3 seaters
- Ships 1/carton 20 cu ft

### Options

- Rounded polyurethane arms, field-replaceable
- Connected and freestanding tables
- 3" clear Cooper Leg Guard, add \$11 List/leg
- Antibacterial and antimicrobial fabrics available
- Different fabric on seat and back at no upcharge
- CAL 133

Contact Spec Customer Service to railroad fabrics (specify repeat info and yardage requirement will be provided) and for repeats greater than 5" x 5"



### Loveseat with arms

COM 4.0 yds  
 2.0 yd COM per single seat  
 2.0 yd COM per single back

MODEL	COM	GR 1	GR 2	GR 3	GR 4	GR 5	GR 6
<b>6401L</b>	<b>1574</b>	<b>1767</b>	<b>1830</b>	<b>1962</b>	<b>2150</b>	<b>2299</b>	<b>2494</b>

For polyurethane arms add suffix P and \$122

Dimensions (inches)

seat H	18.0	seat W	42.0	arm H	25.0
total H	33.75	total W	44.75	depth	27.5

Exceeds BIFMA Seating Durability Test to 750 lbs per chair  
 CAL 133, add \$169 List per chair



**6401L**  
 51 lbs



# COOPER COLLECTION – 6400 Huntsville

Designed for today's healthcare facilities  
Bariatric Single Seater with arms

## Standard Features

- Separate seat and back
- Wood arms
- Wood components in Beech, in any of 7 standard stains or stain-to-match at no upcharge
- Wall-saving frame
- Velcro removable back covers
- Replaceable seats
- Threaded replaceable glides
- Use in connected layouts at no upcharge
- Bariatric seating cannot connect to bariatric seating
- Ships assembled as 1, 2 or 3 seaters
- Ships 1/carton 20 cu ft

## Options

- Rounded polyurethane arms, field-replaceable
- Connected and freestanding tables
- 3" clear Cooper Leg Guard, add \$11 List/leg
- Antibacterial and antimicrobial fabrics available
- Different fabric on seat and back at no upcharge
- CAL 133

Contact Spec Customer Service to railroad fabrics (specify repeat info and yardage requirement will be provided) and for repeats greater than 5" x 5"



## Bariatric Single Seater with arms

COM 3.0 yds  
1.5 yd COM per single seat  
1.5 yd COM per single back

MODEL	COM	GR 1	GR 2	GR 3	GR 4	GR 5	GR 6
<b>6401G</b>	<b>1203</b>	<b>1367</b>	<b>1422</b>	<b>1533</b>	<b>1698</b>	<b>1825</b>	<b>1990</b>

For polyurethane arms add suffix P and \$122

Dimensions (inches)

seat H	18.0	seat W	30.0	arm H	25.0
total H	33.75	total W	34.25	depth	27.5

Exceeds BIFMA Seating Durability Test to 750 lbs per chair  
CAL 133, add \$137 List per chair



**6401G**  
34 lbs



## COOPER COLLECTION – 6400 Huntsville

Designed for today's healthcare facilities  
 Highback Single Seater with arms – Ottoman and Headrest

### Standard Features

- Separate seat and back
- Wood arms
- Wood components in Beech, in any of 7 standard stains or stain-to-match at no upcharge
- Use in connected layouts at no upcharge
- Velcro removable back covers
- Replaceable seats
- Arms replaceable in the field
- Ships assembled as 1, 2 or 3 seaters
- Ships 1/carton 19 cu ft
- Ottoman ships 1/carton 5 cu ft

### Options

- Rounded polyurethane arms, field-replaceable
- Built-in headrest or removeable headrest with velcro strap
- Connected and freestanding tables
- 3" clear Cooper Leg Guard, add \$11 List/leg
- Antibacterial and antimicrobial fabrics available
- Different fabric on seat and back at no upcharge
- CAL 133

Contact Spec Customer Service to railroad fabrics (specify repeat info and yardage requirement will be provided) and for repeats greater than 5" x 5"



### Highback Single Seater with arms

COM 2.5 yds  
 0.75 yd COM per single seat  
 1.75 yds COM per single back

MODEL	COM	GR 1	GR 2	GR 3	GR 4	GR 5	GR 6
<b>6401H</b>	<b>1083</b>	<b>1212</b>	<b>1255</b>	<b>1342</b>	<b>1471</b>	<b>1570</b>	<b>1735</b>

For polyurethane arms add suffix P and \$122

Dimensions (inches)

seat H	18.0	seat W	21.0	arm H	25.0
total H	47.5	total W	25.5	depth	27.5

Exceeds BIFMA Seating Durability Test to 500 lbs per chair  
 CAL 133, add \$123 List per chair



**6401H**  
35 lbs

### Ottoman and Headrest

0.5 yd COM per ottoman  
 0.5 yd COM per headrest

MODEL	COM	GR 1	GR 2	GR 3	GR 4	GR 5	GR 6
<b>6430F</b>	<b>491</b>	<b>524</b>	<b>533</b>	<b>556</b>	<b>589</b>	<b>614</b>	<b>659</b>
<b>60HR</b>	<b>63</b>	<b>73</b>	<b>84</b>	<b>92</b>	<b>106</b>	<b>116</b>	<b>132</b>

Ottoman Dimensions (inches)

H	11.5	W	19.25	depth	12.25
---	------	---	-------	-------	-------

CAL 133, add \$50 List per ottoman / \$50 per headrest



**6430F**  
16 lbs



**60HR**  
1 lbs





## COOPER COLLECTION – 6400 Huntsville

Designed for today's healthcare facilities  
Half and Full Panel Arms

To order half panel arms, add Z to model number, e.g. 6401**Z**

To order full panel arms, add ZC to model number, e.g. 6401**ZC**

**Pricing is for one half panel arm, e.g. for a single seater chair with half panel arms, add two half panel arms to cost of chair**

Contact Spec Customer Service to railroad fabrics (specify repeat info and yardage requirement will be provided) and for repeats greater than 5" x 5"

### Options

- Antibacterial and antimicrobial fabrics available
- CAL 133

---

### Half & Full Panel Arms

---

COM 0.5 yds per half panel arm:

COM	GR 1	GR 2	GR 3	GR 4	GR 5	GR 6
<b>71</b>	<b>93</b>	<b>99</b>	<b>114</b>	<b>136</b>	<b>152</b>	<b>177</b>

---

COM 0.75 yds per full panel arm:

COM	GR 1	GR 2	GR 3	GR 4	GR 5	GR 6
<b>134</b>	<b>175</b>	<b>189</b>	<b>216</b>	<b>258</b>	<b>291</b>	<b>319</b>

---

CAL 133, add \$39 List per half panel arm / \$78 List per full panel arm



1.5 lbs per half panel arm



3 lbs per full panel arm

---

## COOPER COLLECTION – 6400 Huntsville

Designed for today's healthcare facilities

Freestanding Lounge Tables – Corner and Spacer Connecting Tables

### Standard Features

- Tops in laminate or veneer
- Laminate tops in any standard Arborite, Formica, Nevamar, Pionite or Wilsonart matte finish
- Freestanding lounge tables available with PVC, 2mm Bio or hardwood (HB) edge
- Connecting table tops available with PVC Flat edge, Self edge or hardwood (HB) edge
- Veneers in Cherry, Mahogany, Maple, Oak, Chocolate, Pecan and Walnut
- Select from 7 standard stains or stain-to-match at no upcharge
- Beech legs and Beech table skirts stained the same
- Threaded replaceable glides
- Tops utilize Nu Green earth friendly core
- 18" height

### Options

- Non-standard laminates, contact Spec for pricing
- 3" clear Cooper Leg Guard, add \$11 List/leg
- Custom size spacer tables for restricted spaces
- Other sizes may be available

*Radius Corner Tables are recommended for open areas*

### Freestanding Lounge Tables

Model	Laminate PVC/Selfé2MM	Laminate HB Edge	Veneer HB Edge	Weight	Cu.Ft.
64 - 24 x 24 SQ	<b>824</b>	<b>1003</b>	<b>1144</b>	47	7.2
64 - 24 x 48 RE	<b>972</b>	<b>1168</b>	<b>1367</b>	64	18
64 - 30 x 30 SQ	<b>922</b>	<b>1052</b>	<b>1204</b>	57	13.5
64 - 22 DIA	<b>966</b>	<b>1295</b>	<b>1482</b>	47	7.2



### Corner and Spacer Connecting Tables

Model	Laminate PVC/Self Edge	Laminate HB Edge	Veneer HB Edge	Weight	Cu.Ft.
64RC - 28 x 28 <i>Radius Corner Table</i>	<b>762</b>	<b>1022</b>	<b>1197</b>	42	2
64SC - 28 x 28 <i>Square Corner Table</i>	<b>832</b>	<b>1011</b>	<b>1115</b>	46	2
64TC - 45 degree <i>Corner Table</i>	<b>762</b>	<b>1022</b>	<b>1197</b>	40	2
64ST - 21 x 24 <i>Spacer Table</i>	<b>517</b>	<b>729</b>	<b>835</b>	27	2
64ET - 21 x 24 <i>End Table</i>	<b>690</b>	<b>902</b>	<b>1010</b>	37	2

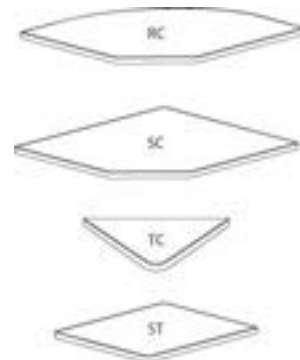

# COOPER COLLECTION LOUNGE SEATING – Layouts

Midland 6700



## Description

- Spec's Midland offers a lighter, residential feel at a value price with extensive environmental considerations.
- Your layout possibilities are unlimited with spacer, radius and corner tables – for both standard and bariatric seating in virtually any combination.
- Bariatric seating is a 30" wide seat and is load tested to 750 lbs. Cannot be connected to other bariatric seats.
- 21" seat width is standard.
- Standard in European Beech in any of 7 standard stains or stain-to-match at no upcharge.
- Choice of wood or black polyurethane arms which are replaceable in the field.
- All models offer a choice of no center arms, half arms or full arms to the floor.
- Wall-saving frame is standard to protect both wall and fabric.
- Glides and separate seat and back are standard.
- Foam formulated to meet California Bulletin 133 standards is available.
- Please send a drawing of the configuration you require with your order.
- Ships assembled as one, two and three seater units.
- For fabrics you wish railroaded or repeats larger than 5" x 5", please contact the factory with repeat information and yardage requirement will be provided.

## LAYOUTS AND DIMENSIONS

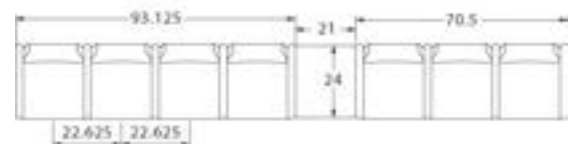
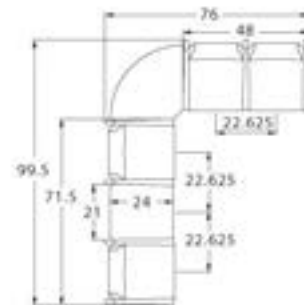
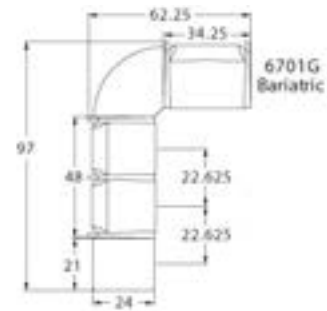

# COOPER MIDLAND



PLACING AN ORDER IS EASY

## PRODUCT CODE

**6 7 0 1 M**

**Collection**  
6 : Cooper

**Series**  
7 : Midland

**Center Arm**  
0 : Outside Arms  
1 : Half Arms  
2 : Full Arms

**Number of Seats**  
1 : Single Seater  
2 : Two Seater  
3 : Three Seater

**Chair Type**  
M : Mid Back  
H : Highback  
L : Loveseat  
G : Bariatric



## OPTIONS

### ARM CAP



Polyurethane

## FINISHES

### FRAME



Select from one of our 7 standard wood stains or stain-to-match at no upcharge.

### FABRIC



Select fabrics from one of our textile partners

### ARM CAP

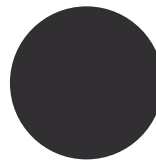

Black



## COOPER COLLECTION – 6700 Midland

Designed for today's healthcare facilities  
Single Seater with arms

### Standard Features

- Separate seat and back
- Wood components in Beech, in any of 7 standard stains or stain-to-match at no upcharge
- Wall-saving frame
- Velcro removable back covers
- Replaceable seats
- Threaded replaceable glides
- Use in connected layouts at no upcharge
- Ships assembled as 1, 2 or 3 seaters
- Ships 1/carton 15 cu ft

### Options

- Replaceable black polyurethane arm cap
- Add 2.5" to back for overall height of 36.5", add \$44 List/single seat
- Connected and freestanding tables
- 3" clear Cooper Leg Guard, add \$11 List/leg
- Antibacterial and antimicrobial fabrics available
- Different fabric on seat and back at no upcharge
- CAL 133

Contact Spec Customer Service to railroad fabrics (specify repeat info and yardage requirement will be provided) and for repeats greater than 5" x 5"

---

### Single Seater with arms

COM 1.75 yds  
0.75 yd COM per single seat  
1.0 yd COM per single back

MODEL	COM	GR 1	GR 2	GR 3	GR 4	GR 5	GR 6
<b>6701M</b>	<b>827</b>	<b>911</b>	<b>936</b>	<b>993</b>	<b>1074</b>	<b>1138</b>	<b>1221</b>

For black polyurethane arm caps add suffix P and \$88

Dimensions (inches)

seat H	18.0	seat W	21.0	arm H	25.0
total H	33.75	total W	25.25	depth	26.25

Exceeds BIFMA Seating Durability Test to 500 lbs per chair  
CAL 133, add \$110 List per seat



**6701M**  
22 lbs





## COOPER COLLECTION – 6700 Midland

Designed for today's healthcare facilities  
Two and Three Seaters with outside arms

### Standard Features

- Separate seat and back
- Wood components in Beech, in any of 7 standard stains or stain-to-match at no upcharge
- Wall-saving frame
- Velcro removable back covers
- Replaceable seats
- Threaded replaceable glides
- Use in connected layouts at no upcharge
- Ships assembled as 1, 2 or 3 seaters
- Ships 1/carton 26 cu ft (2 seater),  
1/carton 39 cu ft (3 seater)

### Options

- Replaceable black polyurethane arm cap
- Add 2.5" to back for overall height of 36.5", add \$44 List/single seat (regular width only)
- Connected and freestanding tables
- 3" clear Cooper Leg Guard, add \$11 List/leg
- Antibacterial and antimicrobial fabrics available
- Different fabric on seat and back at no upcharge
- CAL 133

Contact Spec Customer Service to railroad fabrics (specify repeat info and yardage requirement will be provided) and for repeats greater than 5" x 5"

### Two Seater with outside arms

COM 3.5 yds  
0.75 yd COM per single seat  
1.0 yd COM per single back

MODEL	COM	GR 1	GR 2	GR 3	GR 4	GR 5	GR 6
<b>6702M</b>	<b>1289</b>	<b>1455</b>	<b>1509</b>	<b>1622</b>	<b>1783</b>	<b>1911</b>	<b>2078</b>

For black polyurethane arm caps add suffix P and \$88

Dimensions (inches)

seat H	18.0	seat W	21.0	arm H	25.0
total H	33.75	total W	44.75	depth	26.25

Exceeds BIFMA Seating Durability Test to 750 lbs per two seater  
CAL 133, add \$220 per two seater



**6702M**  
49 lbs

### Three Seater with outside arms

COM 5.25 yds  
0.75 yd COM per single seat  
1.0 yd COM per single back

MODEL	COM	GR 1	GR 2	GR 3	GR 4	GR 5	GR 6
<b>6703M</b>	<b>1776</b>	<b>2024</b>	<b>2103</b>	<b>2275</b>	<b>2517</b>	<b>2708</b>	<b>2959</b>

For black polyurethane arm caps add suffix P and \$88

Dimensions (inches)

seat H	18.0	seat W	21.0	arm H	25.0
total H	33.75	total W	67.5	depth	26.25

Exceeds BIFMA Seating Durability Test to 1000 lbs per three seater  
CAL 133, add \$330 List per three seater



**6703M**  
73 lbs



# COOPER COLLECTION – 6700 Midland

Designed for today's healthcare facilities  
Two and Three Seaters with half arms

## Standard Features

- Separate seat and back
- Wood components in Beech, in any of 7 standard stains or stain-to-match at no upcharge
- Wall-saving frame
- Velcro removable back covers
- Replaceable seats
- Threaded replaceable glides
- Use in connected layouts at no upcharge
- Ships assembled as 1, 2 or 3 seaters
- Ships 1/carton 26 cu ft (2 seater), 1/carton 39 cu ft (3 seater)

## Options

- Replaceable black polyurethane arm cap
- Add 2.5" to back for overall height of 36.5", add \$44 List/single seat (regular width only)
- Connected and freestanding tables
- 3" clear Cooper Leg Guard, add \$11 List/leg
- Antibacterial and antimicrobial fabrics available
- Different fabric on seat and back at no upcharge
- CAL 133

Contact Spec Customer Service to railroad fabrics (specify repeat info and yardage requirement will be provided) and for repeats greater than 5" x 5"

## Two Seater with half arms

COM 3.5 yds  
0.75 yd COM per single seat  
1.0 yd COM per single back

MODEL	COM	GR 1	GR 2	GR 3	GR 4	GR 5	GR 6
<b>6712M</b>	<b>1455</b>	<b>1620</b>	<b>1674</b>	<b>1787</b>	<b>1948</b>	<b>2077</b>	<b>2243</b>

For black polyurethane arm caps add suffix P and \$132

Dimensions (inches)

seat H	18.0	seat W	21.0	arm H	25.0
total H	33.75	total W	48.0	depth	26.25

Exceeds BIFMA Seating Durability Test to 750 lbs per two seater  
CAL 133, add \$220 List per two seater



**6712M**  
49 lbs

## Three Seater with half arms

COM 5.25 yds  
0.75 yd COM per single seat  
1.0 yd COM per single back

MODEL	COM	GR 1	GR 2	GR 3	GR 4	GR 5	GR 6
<b>6713M</b>	<b>2129</b>	<b>2377</b>	<b>2457</b>	<b>2628</b>	<b>2870</b>	<b>3062</b>	<b>3312</b>

For black polyurethane arm caps add suffix P and \$176

Dimensions (inches)

seat H	18.0	seat W	21.0	arm H	25.0
total H	33.75	total W	70.5	depth	26.25

Exceeds BIFMA Seating Durability Test to 1000 lbs per three seater  
CAL 133, add \$330 List per three seater



**6713M**  
73 lbs



# COOPER COLLECTION – 6700 Midland

Designed for today's healthcare facilities  
Two and Three Seaters with full arms

## Standard Features

- Separate seat and back
- Wood components in Beech, in any of 7 standard stains or stain-to-match at no upcharge
- Wall-saving frame
- Velcro removable back covers
- Replaceable seats
- Threaded replaceable glides
- Use in connected layouts at no upcharge
- Ships assembled as 1, 2 or 3 seaters
- Ships 1/carton 26 cu ft (2 seater), 1/carton 39 cu ft (3 seater)

## Options

- Replaceable black polyurethane arm cap
- Add 2.5" to back for overall height of 36.5", add \$44 List/single seat (regular width only)
- Connected and freestanding tables
- 3" clear Cooper Leg Guard, add \$11 List/leg
- Antibacterial and antimicrobial fabrics available
- Different fabric on seat and back at no upcharge
- CAL 133

Contact Spec Customer Service to railroad fabrics (specify repeat info and yardage requirement will be provided) and for repeats greater than 5" x 5"

## Two Seater with full arms

COM 3.5 yds  
0.75 yd COM per single seat  
1.0 yd COM per single back

MODEL	COM	GR 1	GR 2	GR 3	GR 4	GR 5	GR 6
<b>6722M</b>	<b>1455</b>	<b>1620</b>	<b>1674</b>	<b>1787</b>	<b>1948</b>	<b>2077</b>	<b>2243</b>

For black polyurethane arm caps add suffix P and \$132

Dimensions (inches)

seat H	18.0	seat W	21.0	arm H	25.0
total H	33.75	total W	48.0	depth	26.25

Exceeds BIFMA Seating Durability Test to 750 lbs per two seater  
CAL 133, add \$220 List per two seater



**6722M**  
49 lbs

## Three Seater with full arms

COM 5.25 yds  
0.75 yd COM per single seat  
1.0 yd COM per single back

MODEL	COM	GR 1	GR 2	GR 3	GR 4	GR 5	GR 6
<b>6723M</b>	<b>2129</b>	<b>2377</b>	<b>2457</b>	<b>2628</b>	<b>2870</b>	<b>3062</b>	<b>3312</b>

For black polyurethane arm caps add suffix P and \$176

Dimensions (inches)

seat H	18.0	seat W	21.0	arm H	25.0
total H	33.75	total W	70.5	depth	26.25

Exceeds BIFMA Seating Durability Test to 1000 lbs per three seater  
CAL 133, add \$330 List per three seater



**6723M**  
73 lbs





## COOPER COLLECTION – 6700 Midland

Designed for today's healthcare facilities  
 Loveseat with arms

### Standard Features

- Separate seat and back
- Wood components in Beech, in any of 7 standard stains or stain-to-match at no upcharge
- Wall-saving frame
- Velcro removable back covers
- Replaceable seats
- Threaded replaceable glides
- Use in connected layouts at no upcharge
- Ships assembled as 1, 2 or 3 seaters
- Ships 1/carton 20 cu ft

### Options

- Replaceable black polyurethane arm cap
- Connected and freestanding tables
- 3" clear Cooper Leg Guard, add \$11 List/leg
- Antibacterial and antimicrobial fabrics available
- Different fabric on seat and back at no upcharge
- CAL 133

Contact Spec Customer Service to railroad fabrics (specify repeat info and yardage requirement will be provided) and for repeats greater than 5" x 5"

---

### Loveseat with arms

COM 4.0 yds  
 2.0 yd COM per single seat  
 2.0 yd COM per single back

MODEL	COM	GR 1	GR 2	GR 3	GR 4	GR 5	GR 6
<b>6701L</b>	<b>1268</b>	<b>1462</b>	<b>1524</b>	<b>1656</b>	<b>1844</b>	<b>1993</b>	<b>2188</b>

For black polyurethane arm caps add suffix P and \$88

Dimensions (inches)

seat H	18.0	seat W	42.0	arm H	25.0
total H	33.75	total W	46.25	depth	26.25

Exceeds BIFMA Seating Durability Test to 750 lbs per chair  
 CAL 133, add \$169 List per chair



**6701L**  
 49 lbs



## COOPER COLLECTION – 6700 Midland

Designed for today's healthcare facilities  
Bariatric Single Seater with arms

### Standard Features

- Separate seat and back
- Wood components in Beech, in any of 7 standard stains or stain-to-match at no upcharge
- Wall-saving frame
- Velcro removable back covers
- Replaceable seats
- Threaded replaceable glides
- Use in connected layouts at no upcharge
- Ships assembled as 1, 2 or 3 seaters
- Ships 1/carton 20 cu ft

### Options

- Replaceable black polyurethane arm cap
- Connected and freestanding tables
- 3" clear Cooper Leg Guard, add \$11 List/leg
- Antibacterial and antimicrobial fabrics available
- Different fabric on seat and back at no upcharge
- CAL 133

Contact Spec Customer Service to railroad fabrics (specify repeat info and yardage requirement will be provided) and for repeats greater than 5" x 5"

---

### Bariatric Single Seater with arms

COM 3.0 yds  
1.5 yd COM per single seat  
1.5 yd COM per single back

MODEL	COM	GR 1	GR 2	GR 3	GR 4	GR 5	GR 6
<b>6701G</b>	<b>1076</b>	<b>1241</b>	<b>1294</b>	<b>1409</b>	<b>1569</b>	<b>1697</b>	<b>1864</b>

For black polyurethane arm caps add suffix P and \$88

Dimensions (inches)

seat H	18.0	seat W	30.0	arm H	25.0
total H	33.75	total W	34.25	depth	26.25

Exceeds BIFMA Seating Durability Test to 750 lbs per chair  
CAL 133, add \$137 List per chair



**6701G**  
32 lbs



## COOPER COLLECTION – 6700 Midland

Designed for today's healthcare facilities  
Highback Single Seater with arms – Ottoman

### Standard Features

- Separate seat and back
- Wood components in Beech, in any of 7 standard stains or stain-to-match at no upcharge
- Wall-saving frame
- Threaded replaceable glides
- Use in connected layouts at no upcharge
- Ships assembled as 1, 2 or 3 seaters
- Ships 1/carton 20 cu ft
- Ottoman ships 1/carton 5 cu ft

### Options

- Replaceable black polyurethane arm cap
- Connected and freestanding tables
- 3" clear Cooper Leg Guard, add \$11 List/leg
- Antibacterial and antimicrobial fabrics available
- Different fabric on seat and back at no upcharge
- CAL 133

Contact Spec Customer Service to railroad fabrics (specify repeat info and yardage requirement will be provided) and for repeats greater than 5" x 5"

---

### Highback Single Seater with arms



COM 2.5 yds  
0.75 yd COM per single seat  
1.75 yds COM per single back

MODEL	COM	GR 1	GR 2	GR 3	GR 4	GR 5	GR 6
<b>6701H</b>	<b>959</b>	<b>1098</b>	<b>1142</b>	<b>1236</b>	<b>1372</b>	<b>1477</b>	<b>1617</b>

For black polyurethane arm caps add suffix P and \$88

Dimensions (inches)

	seat H	18.0	seat W	21.0	arm H	25.0
total H	47.5	total W	25.25	depth	26.25	

Exceeds BIFMA Seating Durability Test to 500 lbs per chair  
CAL 133, add \$123 List per chair



**6701H**  
33 lbs

---

### Ottoman

COM 0.5 yd

MODEL	COM	GR 1	GR 2	GR 3	GR 4	GR 5	GR 6
<b>6730F</b>	<b>517</b>	<b>550</b>	<b>562</b>	<b>581</b>	<b>615</b>	<b>640</b>	<b>683</b>

Dimensions (inches)

H	11.5	W	19.25	depth	12.25
---	------	---	-------	-------	-------

CAL 133, add \$50 List per Ottoman



**6730F**  
16 lbs



# COOPER COLLECTION – 6700 Midland

Designed for today's healthcare facilities

Freestanding Lounge Tables – Corner and Spacer Connecting Tables

## Standard Features

- Tops in laminate or veneer
- Laminate tops in any standard Arborite, Formica, Nevamar, Pionite or Wilsonart matte finish
- Freestanding lounge tables available with PVC, 2mm Bio or hardwood (HB) edge
- Connecting table tops available with PVC Flat edge, Self edge or hardwood (HB) edge
- Veneers in Cherry, Mahogany, Maple, Oak, Chocolate, Pecan and Walnut
- Select from 7 standard stains or stain-to-match at no upcharge
- Beech legs and Beech table skirts stained the same
- Tops utilize Nu Green earth friendly core
- Threaded replaceable glides
- 18" height

*Radius Corner Tables are recommended for open areas*

## Options

- Non-standard laminates, contact Spec for pricing
- 3" clear Cooper Leg Guard, add \$11 List/leg
- Custom size spacer tables for restricted spaces
- Self edge available at same cost as PVC edge
- Other sizes may be available

## Freestanding Lounge Tables

Model	Laminate PVC/Self/2MM	Laminate HB Edge	Veneer HB Edge	Weight	Cu.Ft.
67 - 24 x 24 SQ	<b>824</b>	<b>1003</b>	<b>1144</b>	47	7.2
67 - 24 x 48 RE	<b>972</b>	<b>1168</b>	<b>1367</b>	64	18
67 - 30 x 30 SQ	<b>922</b>	<b>1052</b>	<b>1204</b>	57	13.5
67 - 22 DIA	<b>966</b>	<b>1295</b>	<b>1482</b>	47	7.2



## Corner and Spacer Connecting Tables

Model	Laminate PVC/Self Edge	Laminate HB Edge	Veneer HB Edge	Weight	Cu.Ft.
67RC - 28 x 28 <i>Radius Corner Table</i>	<b>762</b>	<b>1022</b>	<b>1197</b>	42	2
67SC - 28 x 28 <i>Square Corner Table</i>	<b>832</b>	<b>1011</b>	<b>1115</b>	46	2
67TC - 45 degree <i>Corner Table</i>	<b>762</b>	<b>1022</b>	<b>1197</b>	40	2
67ST - 21 x 24 <i>Spacer Table</i>	<b>517</b>	<b>729</b>	<b>835</b>	27	2
67ET - 21 x 24 <i>End Table</i>	<b>690</b>	<b>902</b>	<b>1010</b>	37	2

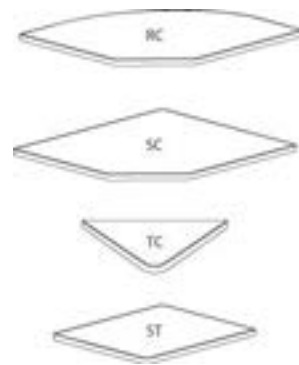

# COOPER COLLECTION LOUNGE SEATING – Layouts

Mission 6300



## Description

- Spec’s Mission offers the softer look and feel of wood, without sacrificing high durability.
- Your layout possibilities are unlimited with spacer, radius and corner tables – for both standard and bariatric seating in virtually any combination.
- Bariatric seating is a 30” wide seat and is load tested to 750 lbs. Cannot be connected to other bariatric seats.
- 21” seat width is standard.
- Standard in European Beech in any of 7 standard stains or stain-to-match at no upcharge.
- Choice of wood or polyurethane arms which are replaceable in the field.
- All models offer a choice of no center arms, half arms or full arms to the floor.
- Glides and separate seat and back are standard.
- Foam formulated to meet California Bulletin 133 standards is available.
- Please send a drawing of the configuration you require with your order.
- Ships assembled as one, two and three seater units.
- For fabrics you wish railroaded or repeats larger than 5” x 5”, please contact the factory with repeat information and yardage requirement will be provided.

## LAYOUTS AND DIMENSIONS

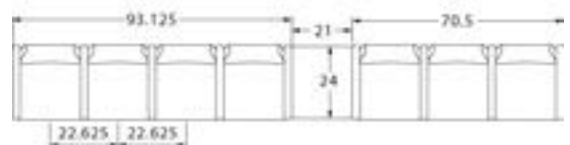
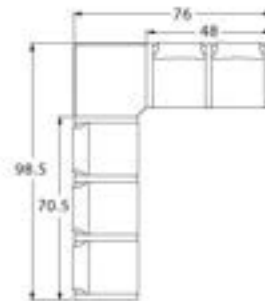
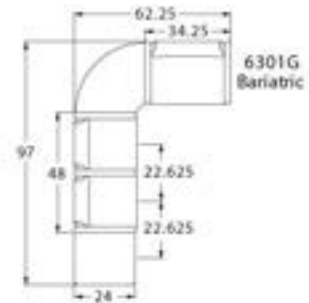



# COOPER MISSION



PLACING AN ORDER IS EASY

## PRODUCT CODE

**6301M-WF**

Collection	Series	Center Arm	Number of Seats	Chair Type	Arm Type
6 : Cooper	3 : Mission	0 : Outside Arms 1 : Half Arms 2 : Full Arms	1 : Single Seater 2 : Two Seater 3 : Three Seater	M : Mid Back H : Highback G : Bariatric ME : Hip Chair L : Loveseat	WF : Wood Flat Profile WR : Wood Round Profile PF : Poly Flat Profile PR : Poly Round Profile

## OPTIONS

### ARM CAP



Wood Arm



Poly Arm

## FINISHES

### FRAME

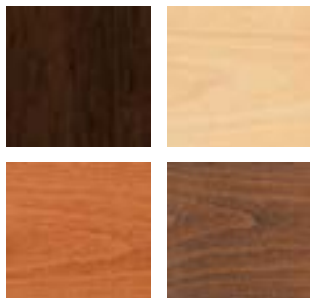

Select from one of our 7 standard wood stains or stain-to-match at no upcharge.

### FABRIC



Select fabrics from one of our textile partners

### ARMS

Note: flat poly arm available in Black only.



\*Wood arms are available in 7 standard stains and stain-to-match at no upcharge.





# COOPER COLLECTION – 6300 Mission

Designed for today's healthcare facilities  
Single Seater with arms

## Standard Features

- Separate seat and back
- Wood components in Beech, in any of 7 standard stains or stain-to-match at no upcharge
- Velcro removable back covers
- Replaceable seats
- Threaded replaceable glides
- Use in connected layouts at no upcharge
- Arms replaceable in the field
- Ships assembled as 1, 2 or 3 seaters
- Ships 1/carton 15 cu ft

## Options

- Wood or polyurethane arms, in flat (WF or PF) or rounded (WR or PR) profile
- Add 2.5" to back for overall height of 36.5", add \$44 List/single seat
- Connected and freestanding tables
- 3" clear Cooper Leg Guard, add \$11 List/leg
- Antibacterial and antimicrobial fabrics available
- Different fabric on seat and back at no upcharge
- CAL 133

Contact Spec Customer Service to railroad fabrics (specify repeat info and yardage requirement will be provided) and for repeats greater than 5" x 5"



## Single Seater with arms

COM 1.75 yds  
0.75 yd COM per single seat  
1.0 yd COM per single back

MODEL	COM	GR 1	GR 2	GR 3	GR 4	GR 5	GR 6
<b>6301M</b>	<b>1103</b>	<b>1186</b>	<b>1214</b>	<b>1268</b>	<b>1353</b>	<b>1415</b>	<b>1496</b>

Dimensions (inches)

seat H	18.0	seat W	21.0	arm H	25.0
total H	33.75	total W	25.25	depth	25.0

Exceeds BIFMA Seating Durability Test to 500 lbs per chair  
CAL 133, add \$110 List per seat



**6301M**  
27 lbs



# COOPER COLLECTION – 6300 Mission

Designed for today's healthcare facilities  
Two and Three Seaters with outside arms

## Standard Features

- Separate seat and back
- Wood components in Beech, in any of 7 standard stains or stain-to-match at no upcharge
- Velcro removable back covers
- Replaceable seats
- Threaded replaceable glides
- Use in connected layouts at no upcharge
- Arms replaceable in the field
- Ships assembled as 1, 2 or 3 seaters
- Ships 1/carton 26 cu ft (2 seater),  
1/carton 39 cu ft (3 seater)

## Options

- Wood or polyurethane arms, in flat (WF or PF) or rounded (WR or PR) profile
- Add 2.5" to back for overall height of 36.5", add \$44 List/single seat
- Connected and freestanding tables
- 3" clear Cooper Leg Guard, add \$11 List/leg
- Antibacterial and antimicrobial fabrics available
- Different fabric on seat and back at no upcharge
- CAL 133

Contact Spec Customer Service to railroad fabrics (specify repeat info and yardage requirement will be provided) and for repeats greater than 5" x 5"



### Two Seater with outside arms

COM 3.5 yds  
0.75 yd COM per single seat  
1.0 yd COM per single back

MODEL	COM	GR 1	GR 2	GR 3	GR 4	GR 5	GR 6
<b>6302M</b>	<b>1543</b>	<b>1710</b>	<b>1764</b>	<b>1875</b>	<b>2040</b>	<b>2166</b>	<b>2333</b>

Dimensions (inches)

seat H	18.0	seat W	21.0	arm H	25.0
total H	33.75	total W	46.5	depth	25.0

Exceeds BIFMA Seating Durability Test to 750 lbs per two seater  
CAL 133, add \$220 List per two seater



**6302M**  
51 lbs

### Three Seater with outside arms

COM 5.25 yds  
0.75 yd COM per single seat  
1.0 yd COM per single back

MODEL	COM	GR 1	GR 2	GR 3	GR 4	GR 5	GR 6
<b>6303M</b>	<b>1983</b>	<b>2232</b>	<b>2315</b>	<b>2481</b>	<b>2726</b>	<b>2917</b>	<b>3166</b>

Dimensions (inches)

seat H	18.0	seat W	21.0	arm H	25.0
total H	33.75	total W	67.5	depth	25.0

Exceeds BIFMA Seating Durability Test to 1000 lbs per three seater  
CAL 133, add \$330 List per three seater



**6303M**  
75 lbs





# COOPER COLLECTION – 6300 Mission

Designed for today's healthcare facilities  
Two and Three Seaters with half arms

## Standard Features

- Separate seat and back
- Wood components in Beech, in any of 7 standard stains or stain-to-match at no upcharge
- Velcro removable back covers
- Replaceable seats
- Threaded replaceable glides
- Use in connected layouts at no upcharge
- Arms replaceable in the field
- Ships assembled as 1, 2 or 3 seaters
- Ships 1/carton 26 cu ft (2 seater),  
1/carton 39 cu ft (3 seater)

## Options

- Wood or polyurethane arms, in flat (WF or PF) or rounded (WR or PR) profile
- Add 2.5" to back for overall height of 36.5", add \$44 List/single seat
- Connected and freestanding tables
- 3" clear Cooper Leg Guard, add \$11 List/leg
- Antibacterial and antimicrobial fabrics available
- Different fabric on seat and back at no upcharge
- CAL 133

Contact Spec Customer Service to railroad fabrics (specify repeat info and yardage requirement will be provided) and for repeats greater than 5" x 5"



## Two Seater with half arms

COM 3.5 yds  
0.75 yd COM per single seat  
1.0 yd COM per single back

MODEL	COM	GR 1	GR 2	GR 3	GR 4	GR 5	GR 6
<b>6312M</b>	<b>2039</b>	<b>2205</b>	<b>2260</b>	<b>2370</b>	<b>2537</b>	<b>2662</b>	<b>2827</b>

Dimensions (inches)  
seat H 18.0 seat W 21.0 arm H 25.0  
total H 33.75 total W 48.0 depth 25.0

Exceeds BIFMA Seating Durability Test to 750 lbs per two seater  
CAL 133, add \$220 List per two seater



**6312M**  
51 lbs

## Three Seater with half arms

COM 5.25 yds  
0.75 yd COM per single seat  
1.0 yd COM per single back

MODEL	COM	GR 1	GR 2	GR 3	GR 4	GR 5	GR 6
<b>6313M</b>	<b>2977</b>	<b>3227</b>	<b>3309</b>	<b>3474</b>	<b>3723</b>	<b>3912</b>	<b>4161</b>

Dimensions (inches)  
seat H 18.0 seat W 21.0 arm H 25.0  
total H 33.75 total W 70.5 depth 25.0

Exceeds BIFMA Seating Durability Test to 1000 lbs per three seater  
CAL 133, add \$330 List per three seater



**6313M**  
75 lbs



# COOPER COLLECTION – 6300 Mission

Designed for today's healthcare facilities  
Two and Three Seaters with full arms

## Standard Features

- Separate seat and back
- Wood components in Beech, in any of 7 standard stains or stain-to-match at no upcharge
- Velcro removable back covers
- Replaceable seats
- Threaded replaceable glides
- Use in connected layouts at no upcharge
- Arms replaceable in the field
- Ships assembled as 1, 2 or 3 seaters
- Ships 1/carton 26 cu ft (2 seater),  
1/carton 39 cu ft (3 seater)

## Options

- Wood or polyurethane arms, in flat (WF or PF) or rounded (WR or PR) profile
- Add 2.5" to back for overall height of 36.5", add \$44 List/single seat
- Connected and freestanding tables
- 3" clear Cooper Leg Guard, add \$11 List/leg
- Antibacterial and antimicrobial fabrics available
- Different fabric on seat and back at no upcharge
- CAL 133

Contact Spec Customer Service to railroad fabrics (specify repeat info and yardage requirement will be provided) and for repeats greater than 5" x 5"



## Two Seater with full arms

COM 3.5 yds  
0.75 yd COM per single seat  
1.0 yd COM per single back

MODEL	COM	GR 1	GR 2	GR 3	GR 4	GR 5	GR 6
<b>6322M</b>	<b>2039</b>	<b>2205</b>	<b>2260</b>	<b>2370</b>	<b>2537</b>	<b>2662</b>	<b>2827</b>

Dimensions (inches)

seat H	18.0	seat W	21.0	arm H	25.0
total H	33.75	total W	48.0	depth	25.0

Exceeds BIFMA Seating Durability Test to 750 lbs per two seater  
CAL 133, add \$220 List per two seater



**6322M**  
51 lbs

## Three Seater with full arms

COM 5.25 yds  
0.75 yd COM per single seat  
1.0 yd COM per single back

MODEL	COM	GR 1	GR 2	GR 3	GR 4	GR 5	GR 6
<b>6323M</b>	<b>2977</b>	<b>3227</b>	<b>3309</b>	<b>3474</b>	<b>3723</b>	<b>3912</b>	<b>4161</b>

Dimensions (inches)

seat H	18.0	seat W	21.0	arm H	25.0
total H	33.75	total W	70.5	depth	25.0

Exceeds BIFMA Seating Durability Test to 1000 lbs per three seater  
CAL 133, add \$330 List per three seater



**6323M**  
75 lbs



## COOPER COLLECTION – 6300 Mission

Designed for today's healthcare facilities  
 Loveseat with arms

### Standard Features

- Separate seat and back
- Wood components in Beech, in any of 7 standard stains or stain-to-match at no upcharge
- Velcro removable back covers
- Replaceable seats
- Threaded replaceable glides
- Use in connected layouts at no upcharge
- Arms replaceable in the field
- Ships assembled as 1, 2 or 3 seaters
- Ships 1/carton 20 cu ft

### Options

- Wood or polyurethane arms, in flat (WF or PF) or rounded (WR or PR) profile
- Connected and freestanding tables
- 3" clear Cooper Leg Guard, add \$11 List/leg
- Antibacterial and antimicrobial fabrics available
- Different fabric on seat and back at no upcharge
- CAL 133

Contact Spec Customer Service to railroad fabrics (specify repeat info and yardage requirement will be provided) and for repeats greater than 5" x 5"



### Loveseat with arms

COM 4.0 yds  
 2.0 yd COM per single seat  
 2.0 yd COM per single back

MODEL	COM	GR 1	GR 2	GR 3	GR 4	GR 5	GR 6
<b>6301L</b>	<b>1673</b>	<b>1867</b>	<b>1929</b>	<b>2061</b>	<b>2249</b>	<b>2399</b>	<b>2593</b>

Dimensions (inches)

seat H	18.0	seat W	42.0	arm H	25.0
total H	33.75	total W	44.75	depth	25.0

Exceeds BIFMA Seating Durability Test to 750 lbs per chair  
 CAL 133, add \$169 List per chair



**6301L**  
 51 lbs



## COOPER COLLECTION – 6300 Mission

Designed for today's healthcare facilities  
Bariatric Single Seater with arms

### Standard Features

- Separate seat and back
- Wood components in Beech, in any of 7 standard stains or stain-to-match at no upcharge
- Velcro removable back covers
- Replaceable seats
- Threaded replaceable glides
- Use in connected layouts at no upcharge
- Arms replaceable in the field
- Bariatric seating cannot connect to bariatric seating
- Ships assembled as 1, 2 or 3 seaters
- Ships 1/carton 20 cu ft

### Options

- Wood or polyurethane arms, in flat (WF or PF) or rounded (WR or PR) profile
- Connected and freestanding tables
- 3" clear Cooper Leg Guard, add \$11 List/leg
- Antibacterial and antimicrobial fabrics available
- Different fabric on seat and back at no upcharge
- CAL 133

Contact Spec Customer Service to railroad fabrics (specify repeat info and yardage requirement will be provided) and for repeats greater than 5" x 5"



### Bariatric Single Seater with arms

COM 3.0 yds  
1.5 yd COM per single seat  
1.5 yd COM per single back

MODEL	COM	GR 1	GR 2	GR 3	GR 4	GR 5	GR 6
<b>6301G</b>	<b>1292</b>	<b>1458</b>	<b>1513</b>	<b>1623</b>	<b>1788</b>	<b>1916</b>	<b>2080</b>

Dimensions (inches)

seat H	18.0	seat W	30.0	arm H	25.0
total H	33.75	total W	34.25	depth	25.0

Exceeds BIFMA Seating Durability Test to 750 lbs per chair  
CAL 133, add \$137 List per chair



**6301G**  
34 lbs



## COOPER COLLECTION – 6300 Mission

Designed for today's healthcare facilities  
 Highback Single Seater with arms – Ottoman and Headrest

### Standard Features

- Separate seat and back
- Wood components in Beech, in any of 7 standard stains or stain-to-match at no upcharge
- Velcro removable back covers
- Replaceable seats
- Threaded replaceable glides
- Use in connected layouts at no upcharge
- Arms replaceable in the field
- Ships assembled as 1, 2 or 3 seaters
- Ships 1/carton 20 cu ft
- Ottoman ships 1/carton 5 cu ft

### Options

- Wood or polyurethane arms, in flat (WF or PF) or rounded (WR or PR) profile
- Built-in headrest or removeable headrest with Velcro strap
- Connected and freestanding tables
- 3" clear Cooper Leg Guard, add \$11 List/leg
- Antibacterial and antimicrobial fabrics available
- Different fabric on seat and back at no upcharge
- CAL 133

Contact Spec Customer Service to railroad fabrics (specify repeat info and yardage requirement will be provided) and for repeats greater than 5" x 5"



### Highback Single Seater with arms

COM 2.5 yds  
 0.75 yd COM per single seat  
 1.75 yds COM per single back

MODEL	COM	GR 1	GR 2	GR 3	GR 4	GR 5	GR 6
<b>6301H</b>	<b>1174</b>	<b>1304</b>	<b>1345</b>	<b>1433</b>	<b>1562</b>	<b>1661</b>	<b>1828</b>

Dimensions (inches)

	seat H	18.0	seat W	21.0	arm H	25.0
total H	47.5	total W	25.25	depth	25.0	

Exceeds BIFMA Seating Durability Test to 500 lbs per chair  
 CAL 133, add \$123 List per chair



**6301H**  
35 lbs

### Ottoman and Headrest

0.5 yd COM per ottoman  
 0.5 yd COM per headrest

MODEL	COM	GR 1	GR 2	GR 3	GR 4	GR 5	GR 6
<b>6330F</b>	<b>452</b>	<b>482</b>	<b>495</b>	<b>515</b>	<b>550</b>	<b>573</b>	<b>618</b>
<b>60HR</b>	<b>63</b>	<b>73</b>	<b>84</b>	<b>92</b>	<b>106</b>	<b>116</b>	<b>132</b>

Ottoman Dimensions (inches)

H	11.5	W	19.25	depth	12.25
---	------	---	-------	-------	-------

CAL 133, add \$50 List per ottoman / \$50 per headrest



**6230F**  
16 lbs



**60HR**  
1 lbs



## COOPER COLLECTION – 6300 Mission

Designed for today's healthcare facilities  
Easy Access Hip Single Seater with arms

### Standard Features

- Separate seat and back
- Wood components in Beech, in any of 7 standard stains or stain-to-match at no upcharge
- Velcro removable back covers
- Replaceable seats
- 24" seat height, no seat pitch (level)
- Footrest which assists entering/exiting chair
- Arms replaceable in the field
- Ships assembled
- Ships 1/carton 19 cu ft

### Options

- Wood or polyurethane arms, in flat (WF or PF) or rounded (WR or PR) profile
- Freestanding tables
- 3" clear Cooper Leg Guard, add \$11 List/leg
- Antibacterial and antimicrobial fabrics available
- Different fabric on seat and back at no upcharge
- CAL 133

Contact Spec Customer Service to railroad fabrics (specify repeat info and yardage requirement will be provided) and for repeats greater than 5" x 5"



### Easy Access Hip Single Seater with arms

COM 1.75 yds  
0.75 yd COM per single seat  
1.0 yd COM per single back

MODEL	COM	GR 1	GR 2	GR 3	GR 4	GR 5	GR 6
<b>6301ME</b>	<b>1749</b>	<b>1915</b>	<b>1970</b>	<b>2081</b>	<b>2245</b>	<b>2373</b>	<b>2538</b>

Dimensions (inches)

seat H	24.0	seat W	21.0	arm H	32.0
total H	46.0	total W	25.25	depth	25.0

Exceeds BIFMA Seating Durability Test to 500 lbs per chair  
CAL 133, add \$110 List per chair



**6301ME**  
35 lbs

## COOPER COLLECTION – 6300 Mission

Designed for today's healthcare facilities  
Corner and Spacer Connecting Tables

### Standard Features

- Tops in laminate or veneer
- Laminate tops in any standard Arborite, Formica, Nevamar, Pionite or Wilsonart matte finish
- PVC Flat edge, hardwood edge (HB) and self edge
- Veneers in Cherry, Mahogany, Maple, Oak, Chocolate, Pecan and Walnut
- Select from 7 standard stains or stain-to-match at no upcharge
- Beech table skirts stained the same
- Tops utilize Nu Green earth friendly core
- 18" height

### Options

- Non-standard laminates, contact Spec for pricing
- Custom size spacer tables for restricted spaces
- Other sizes may be available

*Radius Corner Tables are recommended for open areas*

### Corner and Spacer Connecting Tables

Model	Laminate PVC/Self Edge	Laminate HB Edge	Veneer HB Edge	Weight	Cu.Ft.
63RC - 28 x 28 <i>Radius Corner Table</i>	<b>762</b>	<b>1022</b>	<b>1197</b>	42	2
63SC - 28 x 28 <i>Square Corner Table</i>	<b>832</b>	<b>1011</b>	<b>1115</b>	46	2
63TC - 45 degree <i>Corner Table</i>	<b>762</b>	<b>1022</b>	<b>1197</b>	40	2
63ST - 21 x 24 <i>Spacer Table</i>	<b>517</b>	<b>729</b>	<b>835</b>	27	2
63ET - 21 x 24 <i>End Table</i>	<b>690</b>	<b>902</b>	<b>1010</b>	37	2

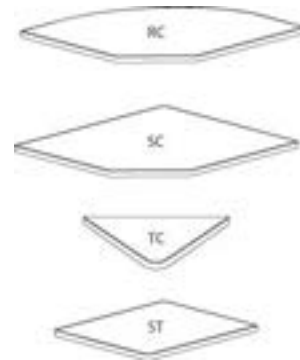



# COOPER ROCKS



PLACING AN ORDER IS EASY

## PRODUCT CODE

**6 4 01 HR**

**Collection**  
6 : Cooper

**Series**  
4 : Huntsville  
5 : Bracebridge  
7 : Midland

**Number of Seats**  
01 : Single Seater

**Chair Type**  
MR : Mid Back  
HR : Highback



## OPTIONS

### SERIES



Bracebridge



Huntsville



Midland

### BACK OPTIONS



Highback



Mid Back

## FINISHES

### FRAME

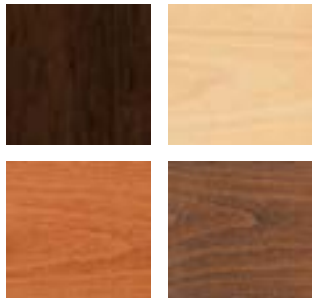

Select from one of our 7 standard wood stains or stain-to-match at no upcharge.

### FABRIC



Select fabrics from one of our textile partners

### ARM OPTIONS

*Arm options will vary depending on the Series. Please refer to the price list for more information on the Series you would like to specify.*





# COOPER COLLECTION – Cooper Rocks

Designed for today's healthcare facilities  
Huntsville Medium and Highback with arms

## Standard Features

- Separate seat and back
- Built in headrest on highback
- Total range of motion is 2" down and 6" back
- Wood arms
- Wood components in Beech, in any of 7 standard stains or stain-to-match at no upcharge
- Wall-saving frame
- Velcro removable back covers
- Replaceable seats
- Threaded replaceable glides
- Ships assembled
- Ships 1/carton 15 cu ft (medium back), 1/carton 19 cu ft (highback)

## Options

- Rounded polyurethane arms, field-replaceable
- Add 2.5" to medium back for overall height of 36.25", add \$44 List/single seat
- Matching ottoman
- Removable headrest
- No headrest
- 3" clear Cooper Leg Guard, add \$11 List/leg
- Antibacterial and antimicrobial fabrics available
- Different fabric on seat and back at no upcharge
- CAL 133

Contact Spec Customer Service to railroad fabrics (specify repeat info and yardage requirement will be provided) and for repeats greater than 5" x 5"

---

## Huntsville Medium back with arms

COM 1.75 yds  
0.75 yd COM per single seat  
1.0 yd COM per single back

MODEL	COM	GR 1	GR 2	GR 3	GR 4	GR 5	GR 6
<b>6401MR</b>	<b>1457</b>	<b>1541</b>	<b>1567</b>	<b>1623</b>	<b>1707</b>	<b>1770</b>	<b>1852</b>

For polyurethane arms add suffix P and \$122

Dimensions (inches)

seat H	18.0	seat W	21.0	arm H	25.0
total H	33.75	total W	25.25	depth	27.5

Exceeds BIFMA Seating Durability Test to 350 lbs per seat  
CAL 133, add \$113



**6401MR**  
30 lbs

---

## Huntsville Highback with arms

COM 2.5 yds  
0.75 yd COM per single seat  
1.75 yd COM per single back

MODEL	COM	GR 1	GR 2	GR 3	GR 4	GR 5	GR 6
<b>6401HR</b>	<b>1680</b>	<b>1813</b>	<b>1855</b>	<b>1942</b>	<b>2071</b>	<b>2170</b>	<b>2336</b>

For polyurethane arms add suffix P and \$122

Dimensions (inches)

seat H	18.0	seat W	21.0	arm H	25.0
total H	47.5	total W	25.5	depth	27.5

Exceeds BIFMA Seating Durability Test to 350 lbs per seat  
CAL 133, add \$123 List per seat



**6401HR**  
35 lbs



# COOPER COLLECTION – Cooper Rocks

Designed for today's healthcare facilities  
Bracebridge Medium and Highback with arms

## Standard Features

- Separate seat and back
- Built in headrest on highback
- Total range of motion is 2" down and 6" back
- Wood arms
- Wood components in Beech, in any of 7 standard stains or stain-to-match at no upcharge
- Wall-saving frame
- Velcro removable back covers
- Replaceable seats
- Threaded replaceable glides
- Ships assembled
- Ships 1/carton 15 cu ft (medium back), 1/carton 19 cu ft (highback)

## Options

- Rounded polyurethane arms, field-replaceable, available in Black, Sterling Grey and Taupe (RAL 7006)
- Add 2.5" to medium back for overall height of 36.25", add \$44 List/single seat
- Matching ottoman
- Removable headrest
- No headrest
- 3" clear Cooper Leg Guard, add \$11 List/leg
- Antibacterial and antimicrobial fabrics available
- Different fabric on seat and back at no upcharge
- CAL 133

Contact Spec Customer Service to railroad fabrics (specify repeat info and yardage requirement will be provided) and for repeats greater than 5" x 5"

---

## Bracebridge Medium back with arms

COM 1.75 yds  
0.75 yd COM per single seat  
1.0 yd COM per single back

MODEL	COM	GR 1	GR 2	GR 3	GR 4	GR 5	GR 6
<b>6501MR</b>	<b>1532</b>	<b>1616</b>	<b>1642</b>	<b>1697</b>	<b>1780</b>	<b>1843</b>	<b>1927</b>

For polyurethane arms add suffix P and \$122

Dimensions (inches)

seat H	18.0	seat W	21.0	arm H	25.0
total H	33.75	total W	25.25	depth	27.5

Exceeds BIFMA Seating Durability Test to 350 lbs per seat  
CAL 133, add \$113 List per seat



**6501MR**  
30 lbs

---

## Bracebridge Highback with arms

COM 2.5 yds  
0.75 yd COM per single seat  
1.75 yd COM per single back

MODEL	COM	GR 1	GR 2	GR 3	GR 4	GR 5	GR 6
<b>6501HR</b>	<b>1758</b>	<b>1888</b>	<b>1930</b>	<b>2018</b>	<b>2147</b>	<b>2246</b>	<b>2412</b>

For polyurethane arms add suffix P and \$122

Dimensions (inches)

seat H	18.0	seat W	21.0	arm H	25.0
total H	47.5	total W	25.5	depth	27.5

Exceeds BIFMA Seating Durability Test to 350 lbs per seat  
CAL 133, add \$123 List per seat



**6501HR**  
35 lbs



# COOPER COLLECTION – Cooper Rocks

Designed for today's healthcare facilities  
Midland Medium and Highback with arms

## Standard Features

- Separate seat and back
- Built in headrest on highback
- Total range of motion is 2" down and 6" back
- Wood arms
- Wood components in Beech, in any of 7 standard stains or stain-to-match at no upcharge
- Wall-saving frame
- Velcro removable back covers
- Replaceable seats
- Threaded replaceable glides
- Ships assembled
- Ships 1/carton 15 cu ft (medium back), 1/carton 19 cu ft (highback)

## Options

- Replaceable polyurethane arm caps
- Add 2.5" to medium back for overall height of 36.25", add \$44 List/single seat
- Matching ottoman
- Removable headrest
- No headrest
- 3" clear Cooper Leg Guard, add \$11 List/leg
- Antibacterial and antimicrobial fabrics available
- Different fabric on seat and back at no upcharge
- CAL 133

Contact Spec Customer Service to railroad fabrics (specify repeat info and yardage requirement will be provided) and for repeats greater than 5" x 5"



### Midland Medium back with arms

COM 1.75 yds  
0.75 yd COM per single seat  
1.0 yd COM per single back

MODEL	COM	GR 1	GR 2	GR 3	GR 4	GR 5	GR 6
<b>6701MR</b>	<b>1283</b>	<b>1366</b>	<b>1392</b>	<b>1449</b>	<b>1529</b>	<b>1594</b>	<b>1677</b>

For polyurethane arms caps add suffix P and \$88

Dimensions (inches)

seat H	18.0	seat W	21.0	arm H	25.0
total H	33.75	total W	25.5	depth	27.5

Exceeds BIFMA Seating Durability Test to 350 lbs per seat  
CAL 133, add \$113 List per seat



**6701MR**  
30 lbs

### Midland Highback with arms

COM 2.5 yds  
0.75 yd COM per single seat  
1.75 yd COM per single back

MODEL	COM	GR 1	GR 2	GR 3	GR 4	GR 5	GR 6
<b>6701HR</b>	<b>1562</b>	<b>1700</b>	<b>1745</b>	<b>1838</b>	<b>1975</b>	<b>2080</b>	<b>2220</b>

For polyurethane arms caps add suffix P and \$88

Dimensions (inches)

seat H	18.0	seat W	21.0	arm H	25.0
total H	47.5	total W	25.5	depth	27.5

Exceeds BIFMA Seating Durability Test to 350 lbs per seat  
CAL 133, add \$123 List per seat



**6701HR**  
35 lbs

# CRAYON



PLACING AN ORDER IS EASY

## PRODUCT CODE

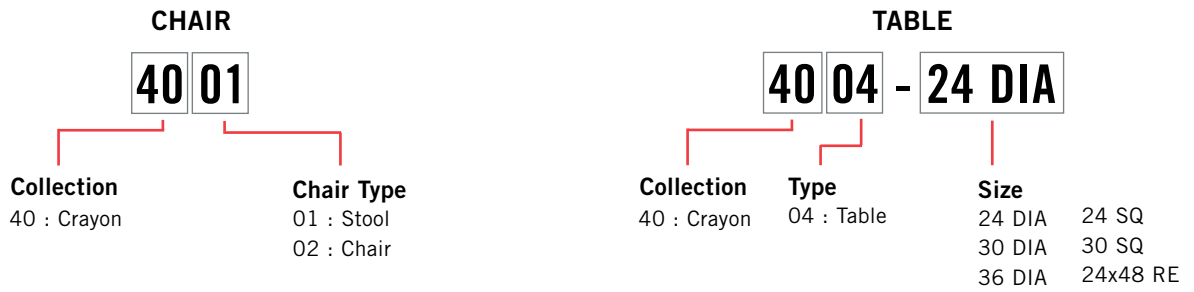

## FINISHES

### LAMINATE



Select laminate from our virtually unlimited laminate options

### BASE



Select from one of our 76 standard Spectone colors

### EDGE



2MM

PVC

Check out our website for a complete list of edge profiles.



# CRAYON – Children’s Series

Stool and Chair without arms

## Standard Features

- Seat is an 12” laminate disk
- Back is an 11” laminate disk
- Laminate in any standard Arborite, Formica, Nevamar, Pionite or Wilsonart matte finish
- 1.25” fully welded frame in any Spectone color
- PVC edge and 2mm Bio edge in 38 colors to match frame finishes
- Seat height 14”
- Glides
- Ships 2/carton 2 cu ft

## Options

- Custom seat heights for different age levels, contact Spec for pricing
- Non-standard laminates, contact Spec for pricing



## Stool

MODEL	PRICE
<b>4001</b>	<b>217</b>

Dimensions (inches)

seat H	14.0	seat W	12.0	arm H	N/A
total H	14.0	total W	14.0	depth	14.0



**4001**  
10 lbs

## Chair without arms

MODEL	PRICE
<b>4002</b>	<b>313</b>

Dimensions (inches)

seat H	14.0	seat W	12.0	back W	11.0
total H	26.0	total W	14.0	depth	16.0



**4002**  
16 lbs

Note: Products above pictured in non-standard laminate



# CRAYON – Children’s Series

## Freestanding Table

### Standard Features

- Laminate in any standard Arborite, Formica, Nevamar, Pionite or Wilsonart matte finish
- 1.50” post legs in any Spectone color
- PVC edge and 2mm Bio edge in 38 colors to match frame finishes
- Height 22”
- Glides
- Ships 1/carton

### Options

- Custom seat heights for different age levels, contact Spec for pricing
- Non-standard laminates, contact Spec for pricing



### Freestanding Tables

Model	Top Size (inches)	Laminate PVC/2MM Edge	Weight	Cu.Ft.
4004	24 DIA	466	31	11
	30 DIA	558	41	16
	36 DIA	667	52	22
	24 SQ	472	31	11
	30 SQ	564	41	16
	24 x 48	645	48	20



*Note: Product above pictured in non-standard laminate*



# DIGNITY

BACK TO CONTENTS



PLACING AN ORDER IS EASY

### PRODUCT CODE

**45 0 1 M - LL**

**Series**  
45 : Dignity

**Center Arm**  
0 : Outside Arms

**Number of Seats**  
1 : Single Seater  
2 : Two Seater  
3 : Three Seater

**Chair Type**  
M : Mid Back  
G : Bariatric

**Arm Panel Finish**

LL : Laminate Outside and Inside  
LU : Laminate Outside/Upholstered Inside  
UL : Upholstered Outside/Laminated Inside  
UU : Upholstered Outside and Inside



### OPTIONS

#### ARM PANEL LAMINATE

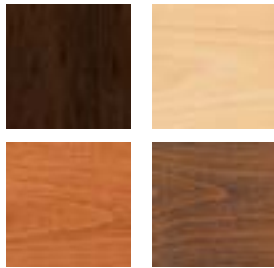

Select laminate from our virtually unlimited laminate options

#### ARM PANEL FABRIC

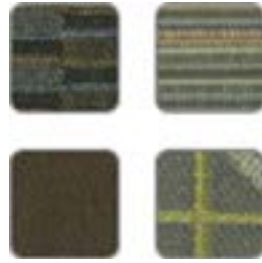

Select laminate from our virtually unlimited laminate options

### FINISHES

#### FRAME/ARMS

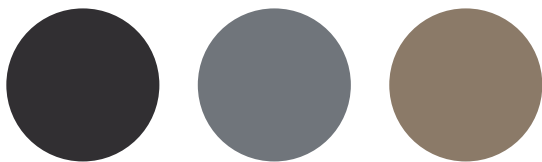

Black

Sterling Grey

Taupe

#### FABRIC

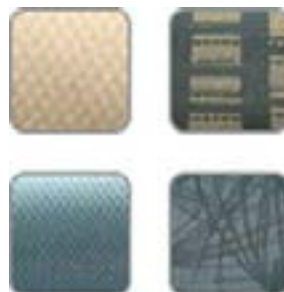

Select fabrics from one of our textile partners



# DIGNITY – Behavioral Health Series

For warmth, strength and sustainability  
Single Seater with arms

## Standard Features

- Separate seat and back
- Self-skinned polyurethane perimeter arms
- Upholstered side panels can match or contrast seat/back
- Laminate or upholstered side panels on inside and outside of arm
- Laminate side panels in any standard Arborite, Formica, Nevamar, Pionite or Wilsonart matte finish
- No protruding legs or hardware
- Tamper proof fastenings
- Heavy duty, steel inner frame is 25% recycled steel
- Ships assembled as 1, 2 or 3 seaters
- Ships 1/carton 39 cu ft

## Options

- Specify frame finish, Black (B), Sterling Grey (G) or Taupe RAL 7006 (T)
- Add up to 20 lbs of additional weight, add \$148 List
- Non-standard laminates, contact Spec for pricing
- Environmentally responsible fabrics available
- Antibacterial and antimicrobial fabrics available
- Freestanding tables
- CAL 133

Contact Spec Customer Service to railroad fabrics (specify repeat info and yardage requirement will be provided) and for repeats greater than 5" x 5"

---

## Single Seater with arms

COM 1.75 yds

0.75 yd COM per single seat / 1.0 yd COM per single back

MODEL	COM	GR 1	GR 2	GR 3	GR 4	GR 5	GR 6
<b>4501M-LL</b>	<b>1349</b>	<b>1434</b>	<b>1462</b>	<b>1518</b>	<b>1601</b>	<b>1665</b>	<b>1748</b>

Arm panel – laminated, outside and inside

CAL 133, add \$110 List per chair

COM 2.75 yds

0.75 yd COM per single seat / 1.0 yd COM per single back / .5 yd COM per panel

MODEL	COM	GR 1	GR 2	GR 3	GR 4	GR 5	GR 6
<b>4501M-LU</b>	<b>1456</b>	<b>1588</b>	<b>1631</b>	<b>1720</b>	<b>1851</b>	<b>1948</b>	<b>2081</b>

Arm panel – laminated, outside, upholstered inside

CAL 133, add \$186 List per chair

COM 2.75 yds

0.75 yd COM per single seat / 1.0 yd COM per single back / .5 yd COM per panel

MODEL	COM	GR 1	GR 2	GR 3	GR 4	GR 5	GR 6
<b>4501M-UL</b>	<b>1456</b>	<b>1588</b>	<b>1631</b>	<b>1720</b>	<b>1851</b>	<b>1948</b>	<b>2081</b>

Arm panel – upholstered outside, laminated inside

CAL 133, add \$186 List per chair

COM 3.75 yds

0.75 yd COM per single seat / 1.0 yd COM per single back / 1.0 yd COM per panel

MODEL	COM	GR 1	GR 2	GR 3	GR 4	GR 5	GR 6
<b>4501M-UU</b>	<b>1562</b>	<b>1743</b>	<b>1801</b>	<b>1922</b>	<b>2099</b>	<b>2235</b>	<b>2414</b>

Arm panel – upholstered, outside and inside

CAL 133, add \$260 List per chair

Dimensions (inches)

seat H	18.0	seat W	23.0	arm H	25.25
total H	32.75	total W	29.0	depth	29.75

Exceeds BIFMA Seating Durability Test to 500 lbs per chair



**4501M**  
95 lbs





# DIGNITY – Behavioral Health Series

For warmth, strength and sustainability  
Two Seater with outside arms

## Standard Features

- Separate seat and back
- Self-skinned polyurethane perimeter arms
- Upholstered side panels can match or contrast seat/back
- Laminate or upholstered side panels on inside and outside of arm
- Laminate side panels in any standard Arborite, Formica, Nevamar, Pionite or Wilsonart matte finish
- No protruding legs or hardware
- Tamper proof fastenings
- Heavy duty, steel inner frame is 25% recycled steel
- Ships assembled as 1, 2 or 3 seaters
- Ships 1/carton 39 cu ft

## Options

- Specify frame finish, Black (B), Sterling Grey (G) or Taupe RAL 7006 (T)
- Add up to 20 lbs of additional weight, add \$148 List
- Non-standard laminates, contact Spec for pricing
- Environmentally responsible fabrics available
- Antibacterial and antimicrobial fabrics available
- Freestanding tables
- CAL 133

Contact Spec Customer Service to railroad fabrics (specify repeat info and yardage requirement will be provided) and for repeats greater than 5" x 5"

---

## Two Seater with outside arms

COM 3.5 yds

0.75 yd COM per single seat / 1.0 yd COM per single back

MODEL	COM	GR 1	GR 2	GR 3	GR 4	GR 5	GR 6
<b>4502M-LL</b>	<b>1982</b>	<b>2150</b>	<b>2205</b>	<b>2317</b>	<b>2484</b>	<b>2609</b>	<b>2777</b>

Arm panel – laminated, outside and inside

CAL 133, add \$220 List per two seater

COM 4.5 yds

0.75 yd COM per single seat / 1.0 yd COM per single back / .5 yd COM per panel

MODEL	COM	GR 1	GR 2	GR 3	GR 4	GR 5	GR 6
<b>4502M-LU</b>	<b>2088</b>	<b>2304</b>	<b>2376</b>	<b>2518</b>	<b>2734</b>	<b>2896</b>	<b>3111</b>

Arm panel – laminated, outside, upholstered inside

CAL 133, add \$296 List per two seater

COM 4.5 yds

0.75 yd COM per single seat / 1.0 yd COM per single back / .5 yd COM per panel

MODEL	COM	GR 1	GR 2	GR 3	GR 4	GR 5	GR 6
<b>4502M-UL</b>	<b>2088</b>	<b>2304</b>	<b>2376</b>	<b>2518</b>	<b>2734</b>	<b>2896</b>	<b>3111</b>

Arm panel – upholstered outside, laminated inside

CAL 133, add \$296 List per two seater

COM 5.5 yds

0.75 yd COM per single seat / 1.0 yd COM per single back / 1.0 yd COM per panel

MODEL	COM	GR 1	GR 2	GR 3	GR 4	GR 5	GR 6
<b>4502M-UU</b>	<b>2194</b>	<b>2459</b>	<b>2545</b>	<b>2721</b>	<b>2982</b>	<b>3180</b>	<b>3447</b>

Arm panel – upholstered, outside and inside

CAL 133, add \$370 List per two seater

Dimensions (inches)

seat H	18.0	seat W	46.0	arm H	25.25
total H	32.75	total W	52.0	depth	29.75

Exceeds BIFMA Seating Durability Test to 750 lbs per two seater



**4502M**  
150 lbs



# DIGNITY – Behavioral Health Series

For warmth, strength and sustainability  
 Three Seater with outside arms

## Standard Features

- Separate seat and back
- Self-skinned polyurethane perimeter arms
- Upholstered side panels can match or contrast seat/back
- Laminate or upholstered side panels on inside and outside of arm
- Laminate side panels in any standard Arborite, Formica, Nevamar, Pionite or Wilsonart matte finish
- No protruding legs or hardware
- Tamper proof fastenings
- Heavy duty, steel inner frame is 25% recycled steel
- Ships assembled as 1, 2 or 3 seaters
- Ships 1/carton 39 cu ft

## Options

- Specify frame finish, Black (B), Sterling Grey (G) or Taupe RAL 7006 (T)
- Add up to 20 lbs of additional weight, add \$148 List
- Non-standard laminates, contact Spec for pricing
- Environmentally responsible fabrics available
- Antibacterial and antimicrobial fabrics available
- Freestanding tables
- CAL 133

Contact Spec Customer Service to railroad fabrics (specify repeat info and yardage requirement will be provided) and for repeats greater than 5" x 5"

---

### Three Seater with outside arms

COM 5.25 yds  
 0.75 yd COM per single seat / 1.0 yd COM per single back

MODEL	COM	GR 1	GR 2	GR 3	GR 4	GR 5	GR 6
<b>4503M-LL</b>	<b>2614</b>	<b>2867</b>	<b>2951</b>	<b>3118</b>	<b>3368</b>	<b>3557</b>	<b>3809</b>

Arm panel – laminated, outside and inside  
 CAL 133, add \$330 List per three seater

COM 6.25 yds  
 0.75 yd COM per single seat / 1.0 yd COM per single back / .5 yd COM per panel

MODEL	COM	GR 1	GR 2	GR 3	GR 4	GR 5	GR 6
<b>4503M-LU</b>	<b>2720</b>	<b>3021</b>	<b>3120</b>	<b>3320</b>	<b>3618</b>	<b>3841</b>	<b>4142</b>

Arm panel – laminated, outside, upholstered inside  
 CAL 133, add \$406 List per three seater

COM 6.25 yds  
 0.75 yd COM per single seat / 1.0 yd COM per single back / .5 yd COM per panel

MODEL	COM	GR 1	GR 2	GR 3	GR 4	GR 5	GR 6
<b>4503M-UL</b>	<b>2720</b>	<b>3021</b>	<b>3120</b>	<b>3320</b>	<b>3618</b>	<b>3841</b>	<b>4142</b>

Arm panel – upholstered outside, laminated inside  
 CAL 133, add \$406 List per three seater

COM 7.25 yds  
 0.75 yd COM per single seat / 1.0 yd COM per single back / 1.0 yd COM per panel

MODEL	COM	GR 1	GR 2	GR 3	GR 4	GR 5	GR 6
<b>4503M-UU</b>	<b>2826</b>	<b>3176</b>	<b>3290</b>	<b>3522</b>	<b>3866</b>	<b>4127</b>	<b>4477</b>

Arm panel – upholstered, outside and inside  
 CAL 133, add \$480 List per three seater

#### Dimensions (inches)

seat H	18.0	seat W	69.0	arm H	25.25
total H	32.75	total W	75.0	depth	29.75

Exceeds BIFMA Seating Durability Test to 1000 lbs per three seater



**4503M**  
205 lbs



# DIGNITY – Behavioral Health Series

For warmth, strength and sustainability  
**Bariatric Single Seater with arms**

### Standard Features

- Separate seat and back
- Self-skinned polyurethane perimeter arms
- Upholstered side panels can match or contrast seat/back
- Laminate or upholstered side panels on inside and outside of arm
- Laminate side panels in any standard Arborite, Formica, Nevamar, Pionite or Wilsonart matte finish
- No protruding legs or hardware
- Tamper proof fastenings
- Heavy duty, steel inner frame is 25% recycled steel
- Ships assembled as 1, 2 or 3 seaters
- Ships 1/carton 39 cu ft

### Options

- Specify frame finish, Black (B), Sterling Grey (G) or Taupe RAL 7006 (T)
- Add up to 20 lbs of additional weight, add \$148 List
- Non-standard laminates, contact Spec for pricing
- Environmentally responsible fabrics available
- Antibacterial and antimicrobial fabrics available
- Freestanding tables
- CAL 133

Contact Spec Customer Service to railroad fabrics (specify repeat info and yardage requirement will be provided) and for repeats greater than 5" x 5"

---

### Bariatric Single Seater with arms

COM 3.25 yds

1.5 yd COM per single seat / 1.75 yd COM per single back

MODEL	COM	GR 1	GR 2	GR 3	GR 4	GR 5	GR 6
<b>4501G-LL</b>	<b>1746</b>	<b>1903</b>	<b>1953</b>	<b>2057</b>	<b>2212</b>	<b>2330</b>	<b>2486</b>

Arm panel – laminated, outside and inside

CAL 133, add \$137 List per chair

COM 4.25 yds

1.5 yd COM per single seat / 1.75 yd COM per single back / .5 yd COM per panel

MODEL	COM	GR 1	GR 2	GR 3	GR 4	GR 5	GR 6
<b>4501G-LU</b>	<b>1852</b>	<b>2057</b>	<b>2124</b>	<b>2258</b>	<b>2461</b>	<b>2613</b>	<b>2818</b>

Arm panel – laminated, outside, upholstered inside

CAL 133, add \$212 List per chair

COM 4.25 yds

1.5 yd COM per single seat / 1.75 yd COM per single back / .5 yd COM per panel

MODEL	COM	GR 1	GR 2	GR 3	GR 4	GR 5	GR 6
<b>4501G-UL</b>	<b>1852</b>	<b>2057</b>	<b>2124</b>	<b>2258</b>	<b>2461</b>	<b>2613</b>	<b>2818</b>

Arm panel – upholstered outside, laminated inside

CAL 133, add \$212 List per chair

COM 5.25 yds

1.5 yd COM per single seat / 1.75 yd COM per single back / 1.0 yd COM per panel

MODEL	COM	GR 1	GR 2	GR 3	GR 4	GR 5	GR 6
<b>4501G-UU</b>	<b>1959</b>	<b>2211</b>	<b>2294</b>	<b>2461</b>	<b>2712</b>	<b>2901</b>	<b>3154</b>

Arm panel – upholstered, outside and inside

CAL 133, add \$288 List per chair

Dimensions (inches)

seat H	18.0	seat W	30.25	arm H	25.25
total H	32.75	total W	36.25	depth	29.75

Exceeds BIFMA Seating Durability Test to 750 lbs per chair



**4501G**  
113 lbs

## DIGNITY – Behavioral Health Series

For warmth, strength and sustainability  
Freestanding Lounge Tables

### Standard Features

- Tops in laminate or veneer
- Laminate tops in any standard Arborite, Formica, Nevamar, Pionite or Wilsonart matte finish
- Laminate tops with PVC or hardwood (HB) edge
- Veneers in Cherry, Mahogany, Maple, Oak, Chocolate, Pecan and Walnut
- Select from 7 standard stains or stain-to-match at no upcharge
- Heavy duty, fully welded frame is 25% recycled steel
- Tops utilize Nu Green earth friendly core
- 18" height

*Radius Corner Tables are recommended for open areas*

### Options

- Specify frame finish, Black (B), Sterling Grey (G) or Taupe RAL 7006 (T)
- Additional weight can be added, contact factory
- Non-standard laminates, contact Spec for pricing
- Self edge available at same cost as PVC edge

### Freestanding Lounge Tables

Model	Laminate PVC Edge	Laminate HB Edge	Veneer HB Edge	Weight	Cu.Ft.
DIGN - 24 x 24 SQ	<b>1118</b>	<b>1297</b>	<b>1331</b>	57	7.2
DIGN - 30 x 30 SQ	<b>1259</b>	<b>1389</b>	<b>1436</b>	74	13.5
DIGN - 36 x 36 SQ	<b>1375</b>	<b>1579</b>	<b>1635</b>	94	18
DIGN - 42 x 42 SQ	<b>1672</b>	<b>1967</b>	<b>2057</b>	116	24.5
DIGN - 48 x 48 SQ	<b>1851</b>	<b>2110</b>	<b>2206</b>	141	32
DIGN - 24 DIA	<b>1090</b>	<b>1419</b>	<b>1454</b>	45	7.2
DIGN - 30 DIA	<b>1228</b>	<b>1552</b>	<b>1596</b>	57	13.5
DIGN - 36 DIA	<b>1357</b>	<b>1828</b>	<b>1909</b>	71	18
DIGN - 42 DIA	<b>1661</b>	<b>2185</b>	<b>2298</b>	87	24.5
DIGN - 48 DIA	<b>1718</b>	<b>2426</b>	<b>2549</b>	104	32



### Corner and Spacer Connecting Tables

Model	Laminate PVC/Self Edge	Laminate HB Edge	Veneer HB Edge	Weight	Cu.Ft.
DIGNRC - 28 x 28 <i>Radius Corner Table</i>	<b>644</b>	<b>807</b>	<b>998</b>	31	2
DIGNSC - 28 x 28 <i>Square Corner Table</i>	<b>644</b>	<b>807</b>	<b>998</b>	32	2
DIGNTC - 45 degree <i>Corner Table</i>	<b>644</b>	<b>807</b>	<b>998</b>	26	2
DIGNST - 21 x 24 <i>Spacer Table</i>	<b>496</b>	<b>675</b>	<b>815</b>	27	2

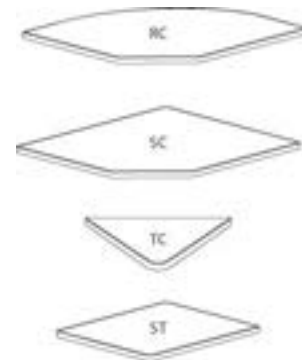



## DIGNITY – Behavioral Health Series

For warmth, strength and sustainability

### Dolly

#### Standard Features

- Black finish only
- 6" soft wheel casters
- Standard Dolly holds 1 single seat chair
- Ships 1/carton, 17 cu. ft.
- Ships fully assembled



### Dignity - Dolly

Description	Model	Price	Weight
Single Seat Dolly	<b>DIGN-99</b>	<b>510</b>	12lb

#### Dimensions (inches)

height	39.0
width	23.0
depth	30.0



\*Dolly accommodates Dignity and Dignity2  
Image above shows Dignity2



# DIGNITY2



PLACING AN ORDER IS EASY

## PRODUCT CODE

46 0 1 M - N - LL

Series	Center Arm	Number of Seats	Chair Type	Arm Type	Arm Panel Finish
46 : Dignity2	0 : Outside Arms	1 : Single Seater 2 : Two Seater 3 : Three Seater	M : Mid Back G : Bariatric	N/A : Regular Arm N : No Arm	LL : Laminate Outside and Inside LU : Laminate Outside/Upholstered Inside UL : Upholstered Outside/Laminated Inside UU : Upholstered Outside and Inside



## OPTIONS

### ARM PANEL LAMINATE

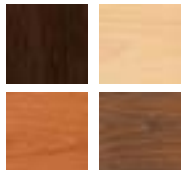

Select laminate from our virtually unlimited laminate options

### ARM PANEL FABRIC

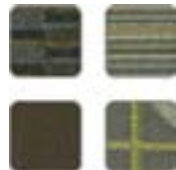

Select fabric from our virtually unlimited fabric options

### ARM PANEL THERMOFOIL



Call Customer Service

### ARM TYPE



Polyurethane      Wood      KYDEX®

Corian arms available at an upcharge. Call for pricing.

### WALL SAVING



### EXTENDED SIDE PANEL



## FINISHES

### FRAME



Select from one of our 76 standard Spectone colors

### FABRIC



Select fabrics from one of our textile partners

### ARMS



Black

Sterling Grey

Taupe



Wood\*

\*Wood arms are available in 7 standard stains and stain-to-match at no upcharge.



# DIGNITY2 – Behavioral Health Series

For warmth, strength and sustainability  
Single Seater with Arms

### Standard Features

- Separate seat and back
- Arm caps available in wood, or polyurethane
- Laminate or upholstered side panels on inside and outside of arm in various combinations
- Upholstered side panels can match or contrast seat/back
- Laminate side panels in any standard Arborite, Formica, Nevamar, Pionite or Wilsonart matte finish
- Sculpted steel leg in any Spectone finish
- No protruding legs or hardware
- Tamper proof fastenings
- Ships assembled as 1, 2 or 3 seaters
- Ships 1/carton 15 cu ft

Contact Spec Customer Service to railroad fabrics (specify repeat info and yardage requirement will be provided) and for repeats greater than 5" x 5"

### Options

- Polyurethane arm caps available in Black (B) or Taupe RAL 7006 (T) or Sterling Grey (G)
- For wood arm caps, select from 7 standard stains, or stain-to-match at no upcharge
- KYDEX® arm caps available in Black (B) or Taupe RAL 7006 (T) or Sterling Grey (G)
- Thermofoil side panels on inside and outside of arm, call Customer Service for pricing and finishes
- Steel leg finish available in any Spectone color
- Add up to 20 lbs of additional weight, add \$148 List
- Non-standard laminates, contact Spec for pricing
- Antibacterial and antimicrobial fabrics available
- Freestanding tables available
- CAL 133
- Elimination of separated seat and back available. Contact factory

### Single Seater with arms

COM 1.75 yds  
0.75 yd COM per single seat / 1.0 yd COM per single back

MODEL	COM	GR 1	GR 2	GR 3	GR 4	GR 5	GR 6
<b>4601M-LL</b>	<b>1349</b>	<b>1434</b>	<b>1462</b>	<b>1518</b>	<b>1601</b>	<b>1665</b>	<b>1748</b>

Side panel – laminated, outside and inside  
CAL 133, add \$110 List per chair

COM 2.75 yds  
0.75 yd COM per single seat / 1.0 yd COM per single back / .5 yd COM per panel

MODEL	COM	GR 1	GR 2	GR 3	GR 4	GR 5	GR 6
<b>4601M-LU</b>	<b>1456</b>	<b>1588</b>	<b>1631</b>	<b>1720</b>	<b>1851</b>	<b>1948</b>	<b>2081</b>

Side panel – laminated outside, upholstered inside  
CAL 133, add \$186 List per chair

COM 2.75 yds  
0.75 yd COM per single seat / 1.0 yd COM per single back / .5 yd COM per panel

MODEL	COM	GR 1	GR 2	GR 3	GR 4	GR 5	GR 6
<b>4601M-UL</b>	<b>1456</b>	<b>1588</b>	<b>1631</b>	<b>1720</b>	<b>1851</b>	<b>1948</b>	<b>2081</b>

Side panel – upholstered outside, laminated inside  
CAL 133, add \$186 List per chair

COM 3.75 yds  
0.75 yd COM per single seat / 1.0 yd COM per single back / 1.0 yd COM per panel

MODEL	COM	GR 1	GR 2	GR 3	GR 4	GR 5	GR 6
<b>4601M-UU</b>	<b>1562</b>	<b>1743</b>	<b>1801</b>	<b>1922</b>	<b>2099</b>	<b>2235</b>	<b>2414</b>

Side panel – upholstered, outside and inside  
CAL 133, add \$260 List per chair

Dimensions (inches)

seat H	18.0	seat W	23.0	arm H	26.0
total H	31.75	total W	28.5	depth	30.0

For KYDEX® arms add suffix K and \$240  
Dynamic load tested to 500 lbs per chair



**4601M**  
95 lbs



# DIGNITY2 – Behavioral Health Series

For warmth, strength and sustainability  
Two Seater with Outside Arms

## Standard Features

- Separate seat and back
- Arm caps available in wood, or polyurethane
- Laminate or upholstered side panels on inside and outside of arm in various combinations
- Upholstered side panels can match or contrast seat/back
- Laminate side panels in any standard Arborite, Formica, Nevamar, Pionite or Wilsonart matte finish
- Sculpted steel leg in any Spectone finish
- No protruding legs or hardware
- Tamper proof fastenings
- Ships assembled as 1, 2 or 3 seaters
- Ships 1/carton 15 cu ft

Contact Spec Customer Service to railroad fabrics (specify repeat info and yardage requirement will be provided) and for repeats greater than 5" x 5"

## Options

- Polyurethane arm caps available in Black (B) or Taupe RAL 7006 (T) or Sterling Grey (G)
- For wood arm caps, select from 7 standard stains, or stain-to-match at no upcharge
- KYDEX® arm caps available in Black (B) or Taupe RAL 7006 (T) or Sterling Grey (G)
- Thermofoil side panels on inside and outside of arm, call Customer Service for pricing and finishes
- Steel leg finish available in any Spectone color
- Add up to 20 lbs of additional weight, add \$148 List
- Non-standard laminates, contact Spec for pricing
- Antibacterial and antimicrobial fabrics available
- Freestanding tables available
- CAL 133
- Elimination of separated seat and back available. Contact factory

### Two Seater with outside arms

COM 3.5 yds

0.75 yd COM per single seat / 1.0 yd COM per single back

MODEL	COM	GR 1	GR 2	GR 3	GR 4	GR 5	GR 6
<b>4602M-LL</b>	<b>1982</b>	<b>2150</b>	<b>2205</b>	<b>2317</b>	<b>2484</b>	<b>2609</b>	<b>2777</b>

Side panel – laminated, outside and inside  
CAL 133, add \$220 List per two seater



**4602M**  
150 lbs

COM 4.5 yds

0.75 yd COM per single seat / 1.0 yd COM per single back / .5 yd COM per panel

MODEL	COM	GR 1	GR 2	GR 3	GR 4	GR 5	GR 6
<b>4602M-UL</b>	<b>2088</b>	<b>2304</b>	<b>2376</b>	<b>2518</b>	<b>2734</b>	<b>2896</b>	<b>3111</b>

Side panel – laminated, outside, upholstered inside  
CAL 133, add \$296 List per two seater

COM 4.5 yds

0.75 yd COM per single seat / 1.0 yd COM per single back / .5 yd COM per panel

MODEL	COM	GR 1	GR 2	GR 3	GR 4	GR 5	GR 6
<b>4602M-UL</b>	<b>2088</b>	<b>2304</b>	<b>2376</b>	<b>2518</b>	<b>2734</b>	<b>2896</b>	<b>3111</b>

Side panel – upholstered outside, laminated inside  
CAL 133, add \$296 List per two seater

COM 5.5 yds

0.75 yd COM per single seat / 1.0 yd COM per single back / 1.0 yd COM per panel

MODEL	COM	GR 1	GR 2	GR 3	GR 4	GR 5	GR 6
<b>4602M-UU</b>	<b>2194</b>	<b>2459</b>	<b>2545</b>	<b>2721</b>	<b>2982</b>	<b>3180</b>	<b>3447</b>

Side panel – upholstered, outside and inside  
CAL 133, add \$370 List per two seater

Dimensions (inches)

seat H	18.0	seat W	45.5	arm H	26.0
total H	31.75	total W	51.0	depth	30.0

For KYDEX® arms add suffix K and \$240  
Dynamic load tested to 750 lbs per two seater





# DIGNITY2 – Behavioral Health Series

For warmth, strength and sustainability  
**Three Seater with Outside Arms**

## Standard Features

- Separate seat and back
- Arm caps available in wood, or polyurethane
- Laminate or upholstered side panels on inside and outside of arm in various combinations
- Upholstered side panels can match or contrast seat/back
- Laminate side panels in any standard Arborite, Formica, Nevamar, Pionite or Wilsonart matte finish
- Sculpted steel leg in any Spectone finish
- No protruding legs or hardware
- Tamper proof fastenings
- Ships assembled as 1, 2 or 3 seaters
- Ships 1/carton 15 cu ft

Contact Spec Customer Service to railroad fabrics (specify repeat info and yardage requirement will be provided) and for repeats greater than 5" x 5"

## Options

- Polyurethane arm caps available in Black (B) or Taupe RAL 7006 (T) or Sterling Grey (G)
- For wood arm caps, select from 7 standard stains, or stain-to-match at no upcharge
- KYDEX® arm caps available in Black (B) or Taupe RAL 7006 (T) or Sterling Grey (G)
- Thermofoil side panels on inside and outside of arm, call Customer Service for pricing and finishes
- Steel leg finish available in any Spectone color
- Add up to 20 lbs of additional weight, add \$148 List
- Non-standard laminates, contact Spec for pricing
- Antibacterial and antimicrobial fabrics available
- Freestanding tables available
- CAL 133
- Elimination of separated seat and back available. Contact factory

---

### Three Seater with outside arms

COM 5.25 yds  
 0.75 yd COM per single seat / 1.0 yd COM per single back

MODEL	COM	GR 1	GR 2	GR 3	GR 4	GR 5	GR 6
<b>4603M-LL</b>	<b>2614</b>	<b>2867</b>	<b>2951</b>	<b>3118</b>	<b>3368</b>	<b>3557</b>	<b>3809</b>

Side panel – laminated, outside and inside  
 CAL 133, add \$330 List per three seater



**4603M**  
205 lbs

COM 6.25 yds  
 0.75 yd COM per single seat / 1.0 yd COM per single back / .5 yd COM per panel

MODEL	COM	GR 1	GR 2	GR 3	GR 4	GR 5	GR 6
<b>4603M-LU</b>	<b>2720</b>	<b>3021</b>	<b>3120</b>	<b>3320</b>	<b>3618</b>	<b>3841</b>	<b>4142</b>

Side panel – laminated, outside, upholstered inside  
 CAL 133, add \$406 List per three seater

COM 6.25 yds  
 0.75 yd COM per single seat / 1.0 yd COM per single back / .5 yd COM per panel

MODEL	COM	GR 1	GR 2	GR 3	GR 4	GR 5	GR 6
<b>4603M-UL</b>	<b>2720</b>	<b>3021</b>	<b>3120</b>	<b>3320</b>	<b>3618</b>	<b>3841</b>	<b>4142</b>

Side panel – upholstered outside, laminated inside  
 CAL 133, add \$406 List per three seater

COM 7.25 yds  
 0.75 yd COM per single seat / 1.0 yd COM per single back / 1.0 yd COM per panel

MODEL	COM	GR 1	GR 2	GR 3	GR 4	GR 5	GR 6
<b>4603M-UU</b>	<b>2826</b>	<b>3176</b>	<b>3290</b>	<b>3522</b>	<b>3866</b>	<b>4127</b>	<b>4477</b>

Side panel – upholstered, outside and inside  
 CAL 133, add \$480 List per three seater

Dimensions (inches)

seat H	18.0	seat W	68.0	arm H	26.0
total H	31.75	total W	74.0	depth	30.0

**For KYDEX® arms add suffix K and \$240**  
**Dynamic load tested to 1000 lbs per three seater**



## DIGNITY2 – Behavioral Health Series

For warmth, strength and sustainability  
**Bariatric Single Seater with Arms**

### Standard Features

- Separate seat and back
- Arm caps available in wood, or polyurethane
- Laminate or upholstered side panels on inside and outside of arm in various combinations
- Upholstered side panels can match or contrast seat/back
- Laminate side panels in any standard Arborite, Formica, Nevamar, Pionite or Wilsonart matte finish
- Sculpted steel leg in any Spectone finish
- No protruding legs or hardware
- Tamper proof fastenings
- Ships assembled as 1, 2 or 3 seaters
- Ships 1/carton 15 cu ft

Contact Spec Customer Service to railroad fabrics (specify repeat info and yardage requirement will be provided) and for repeats greater than 5" x 5"

### Options

- Polyurethane arm caps available in Black (B) or Taupe RAL 7006 (T) or Sterling Grey (G)
- For wood arm caps, select from 7 standard stains, or stain-to-match at no upcharge
- KYDEX® arm caps available in Black (B) or Taupe RAL 7006 (T) or Sterling Grey (G)
- Thermofoil side panels on inside and outside of arm, call Customer Service for pricing and finishes
- Steel leg finish available in any Spectone color
- Add up to 20 lbs of additional weight, add \$148 List
- Non-standard laminates, contact Spec for pricing
- Antibacterial and antimicrobial fabrics available
- Freestanding tables available
- CAL 133
- Elimination of separated seat and back available. Contact factory

---

### Bariatric Single Seater with arms

COM 3.25 yds

1.5 yd COM per single seat / 1.75 yd COM per single back

MODEL	COM	GR 1	GR 2	GR 3	GR 4	GR 5	GR 6
<b>4601G-LL</b>	<b>1746</b>	<b>1903</b>	<b>1953</b>	<b>2057</b>	<b>2212</b>	<b>2330</b>	<b>2486</b>

Side panel – laminated, outside and inside  
 CAL 133, add \$137 List per chair

COM 4.25 yds

1.5 yd COM per single seat / 1.75 yd COM per single back / .5 yd COM per panel

MODEL	COM	GR 1	GR 2	GR 3	GR 4	GR 5	GR 6
<b>4601G-LU</b>	<b>1852</b>	<b>2057</b>	<b>2124</b>	<b>2258</b>	<b>2461</b>	<b>2613</b>	<b>2818</b>

Side panel – laminated, outside, upholstered inside  
 CAL 133, add \$212 List per chair

COM 4.25 yds

1.5 yd COM per single seat / 1.75 yd COM per single back / .5 yd COM per panel

MODEL	COM	GR 1	GR 2	GR 3	GR 4	GR 5	GR 6
<b>4601G-UL</b>	<b>1852</b>	<b>2057</b>	<b>2124</b>	<b>2258</b>	<b>2461</b>	<b>2613</b>	<b>2818</b>

Side panel – upholstered outside, laminated inside  
 CAL 133, add \$212 List per chair

COM 5.25 yds

1.5 yd COM per single seat / 1.75 yd COM per single back / 1.0 yd COM per panel

MODEL	COM	GR 1	GR 2	GR 3	GR 4	GR 5	GR 6
<b>4601G-UU</b>	<b>1959</b>	<b>2211</b>	<b>2294</b>	<b>2461</b>	<b>2712</b>	<b>2901</b>	<b>3154</b>

Side panel – upholstered, outside and inside  
 CAL 133, add \$288 List per chair

Dimensions (inches)

seat H	18.0	seat W	31.0	arm H	26.0
total H	31.75	total W	36.5	depth	30.0

**For KYDEX® arms add suffix K and \$240**  
**Dynamic load tested to 750 lbs per chair**



**4601G**  
113 lbs



# DIGNITY2 – Behavioral Health Series

For warmth, strength and sustainability  
Single Seater with No Arms

## Standard Features

- Separate seat and back
- Arm caps available in wood, or polyurethane
- Laminate or upholstered side panels on inside and outside of arm in various combinations
- Upholstered side panels can match or contrast seat/back
- Laminate side panels in any standard Arborite, Formica, Nevamar, Pionite or Wilsonart matte finish
- Sculpted steel leg in any Spectone finish
- No protruding legs or hardware
- Tamper proof fastenings
- Ships assembled as 1, 2 or 3 seaters
- Ships 1/carton 15 cu ft

Contact Spec Customer Service to railroad fabrics (specify repeat info and yardage requirement will be provided) and for repeats greater than 5" x 5"

## Options

- Polyurethane arm caps available in Black (B) or Taupe RAL 7006 (T) or Sterling Grey (G)
- For wood arm caps, select from 7 standard stains, or stain-to-match at no upcharge
- KYDEX® arm caps available in Black (B) or Taupe RAL 7006 (T) or Sterling Grey (G)
- Thermofoil side panels on inside and outside of arm, call Customer Service for pricing and finishes
- Steel leg finish available in any Spectone color
- Add up to 20 lbs of additional weight, add \$148 List
- Non-standard laminates, contact Spec for pricing
- Antibacterial and antimicrobial fabrics available
- Freestanding tables available
- CAL 133
- Elimination of separated seat and back available. Contact factory

## Single Seater with no arms

COM 1.75 yds

0.75 yd COM per single seat / 1.0 yd COM per single back

MODEL	COM	GR 1	GR 2	GR 3	GR 4	GR 5	GR 6
<b>4601M-LL-N</b>	<b>1329</b>	<b>1414</b>	<b>1441</b>	<b>1497</b>	<b>1581</b>	<b>1644</b>	<b>1728</b>

Side panel – laminated, outside and inside  
CAL 133, add \$110 List per chair

COM 2.75 yds

0.75 yd COM per single seat / 1.0 yd COM per single back / .5 yd COM per panel

MODEL	COM	GR 1	GR 2	GR 3	GR 4	GR 5	GR 6
<b>4601M-LU-N</b>	<b>1435</b>	<b>1568</b>	<b>1611</b>	<b>1699</b>	<b>1831</b>	<b>1928</b>	<b>2060</b>

Side panel – laminated, outside, upholstered inside  
CAL 133, add \$186 List per chair

COM 2.75 yds

0.75 yd COM per single seat / 1.0 yd COM per single back / .5 yd COM per panel

MODEL	COM	GR 1	GR 2	GR 3	GR 4	GR 5	GR 6
<b>4601M-UL-N</b>	<b>1435</b>	<b>1568</b>	<b>1611</b>	<b>1699</b>	<b>1831</b>	<b>1928</b>	<b>2060</b>

Side panel – upholstered outside, laminated inside  
CAL 133, add \$186 List per chair

COM 3.75 yds

0.75 yd COM per single seat / 1.0 yd COM per single back / 1.0 yd COM per panel

MODEL	COM	GR 1	GR 2	GR 3	GR 4	GR 5	GR 6
<b>4601M-UU-N</b>	<b>1541</b>	<b>1723</b>	<b>1781</b>	<b>1901</b>	<b>2079</b>	<b>2214</b>	<b>2394</b>

Side panel – upholstered, outside and inside  
CAL 133, add \$260 List per chair

Dimensions (inches)

seat H	18.0	seat W	23.0	arm H	17.5
total H	31.75	total W	28.5	depth	30.0

For KYDEX® arms add suffix K and \$240  
Dynamic load tested to 500 lbs per chair



**4601M-N**  
95 lbs



# DIGNITY2 – Behavioral Health Series

For warmth, strength and sustainability  
Two Seater with No Arms

## Standard Features

- Separate seat and back
- Arm caps available in wood, or polyurethane
- Laminate or upholstered side panels on inside and outside of arm in various combinations
- Upholstered side panels can match or contrast seat/back
- Laminate side panels in any standard Arborite, Formica, Nevamar, Pionite or Wilsonart matte finish
- Sculpted steel leg in any Spectone finish
- No protruding legs or hardware
- Tamper proof fastenings
- Ships assembled as 1, 2 or 3 seaters
- Ships 1/carton 15 cu ft

Contact Spec Customer Service to railroad fabrics (specify repeat info and yardage requirement will be provided) and for repeats greater than 5" x 5"

## Options

- Polyurethane arm caps available in Black (B) or Taupe RAL 7006 (T) or Sterling Grey (G)
- For wood arm caps, select from 7 standard stains, or stain-to-match at no upcharge
- KYDEX® arm caps available in Black (B) or Taupe RAL 7006 (T) or Sterling Grey (G)
- Thermofoil side panels on inside and outside of arm, call Customer Service for pricing and finishes
- Steel leg finish available in any Spectone color
- Add up to 20 lbs of additional weight, add \$148 List
- Non-standard laminates, contact Spec for pricing
- Antibacterial and antimicrobial fabrics available
- Freestanding tables available
- CAL 133
- Elimination of separated seat and back available. Contact factory

---

### Two Seater with no arms

COM 3.5 yds  
0.75 yd COM per single seat / 1.0 yd COM per single back

MODEL	COM	GR 1	GR 2	GR 3	GR 4	GR 5	GR 6
<b>4602M-LL-N</b>	<b>1961</b>	<b>2130</b>	<b>2185</b>	<b>2297</b>	<b>2463</b>	<b>2589</b>	<b>2757</b>

Side panel – laminated, outside and inside  
CAL 133, add \$220 List per two seater

COM 4.5 yds  
0.75 yd COM per single seat / 1.0 yd COM per single back / .5 yd COM per panel

MODEL	COM	GR 1	GR 2	GR 3	GR 4	GR 5	GR 6
<b>4602M-LU-N</b>	<b>2068</b>	<b>2284</b>	<b>2355</b>	<b>2498</b>	<b>2713</b>	<b>2875</b>	<b>3091</b>

Side panel – laminated, outside, upholstered inside  
CAL 133, add \$296 List per two seater

COM 4.5 yds  
0.75 yd COM per single seat / 1.0 yd COM per single back / .5 yd COM per panel

MODEL	COM	GR 1	GR 2	GR 3	GR 4	GR 5	GR 6
<b>4602M-UL-N</b>	<b>2068</b>	<b>2284</b>	<b>2355</b>	<b>2498</b>	<b>2713</b>	<b>2875</b>	<b>3091</b>

Side panel – upholstered outside, laminated inside  
CAL 133, add \$296 List per two seater

COM 5.5 yds  
0.75 yd COM per single seat / 1.0 yd COM per single back / 1.0 yd COM per panel

MODEL	COM	GR 1	GR 2	GR 3	GR 4	GR 5	GR 6
<b>4602M-UU-N</b>	<b>2174</b>	<b>2439</b>	<b>2525</b>	<b>2701</b>	<b>2962</b>	<b>3160</b>	<b>3426</b>

Side panel – upholstered, outside and inside  
CAL 133, add \$370 List per two seater

Dimensions (inches)

seat H	18.0	seat W	45.0	arm H	17.5
total H	31.75	total W	51.0	depth	30.0

For KYDEX® arms add suffix K and \$240  
Dynamic load tested to 750 lbs per two seater



**4602M-N**  
150 lbs



# DIGNITY2 – Behavioral Health Series

For warmth, strength and sustainability  
**Three Seater with No Arms**

## Standard Features

- Separate seat and back
- Arm caps available in wood, or polyurethane
- Laminate or upholstered side panels on inside and outside of arm in various combinations
- Upholstered side panels can match or contrast seat/back
- Laminate side panels in any standard Arborite, Formica, Nevamar, Pionite or Wilsonart matte finish
- Sculpted steel leg in any Spectone finish
- No protruding legs or hardware
- Tamper proof fastenings
- Ships assembled as 1, 2 or 3 seaters
- Ships 1/carton 15 cu ft

Contact Spec Customer Service to railroad fabrics (specify repeat info and yardage requirement will be provided) and for repeats greater than 5" x 5"

## Options

- Polyurethane arm caps available in Black (B) or Taupe RAL 7006 (T) or Sterling Grey (G)
- For wood arm caps, select from 7 standard stains, or stain-to-match at no upcharge
- KYDEX® arm caps available in Black (B) or Taupe RAL 7006 (T) or Sterling Grey (G)
- Thermofoil side panels on inside and outside of arm, call Customer Service for pricing and finishes
- Steel leg finish available in any Spectone color
- Add up to 20 lbs of additional weight, add \$148 List
- Non-standard laminates, contact Spec for pricing
- Antibacterial and antimicrobial fabrics available
- Freestanding tables available
- CAL 133
- Elimination of separated seat and back available. Contact factory

---

### Three Seater with no arms

COM 5.25 yds  
 0.75 yd COM per single seat / 1.0 yd COM per single back

MODEL	COM	GR 1	GR 2	GR 3	GR 4	GR 5	GR 6
<b>4603M-LL-N</b>	<b>2594</b>	<b>2847</b>	<b>2930</b>	<b>3098</b>	<b>3348</b>	<b>3536</b>	<b>3788</b>

Side panel – laminated, outside and inside  
 CAL 133, add \$330 List per three seater



**4603M-N**  
205 lbs

COM 6.25 yds  
 0.75 yd COM per single seat / 1.0 yd COM per single back / .5 yd COM per panel

MODEL	COM	GR 1	GR 2	GR 3	GR 4	GR 5	GR 6
<b>4603M-LU-N</b>	<b>2700</b>	<b>3001</b>	<b>3100</b>	<b>3300</b>	<b>3598</b>	<b>3821</b>	<b>4122</b>

Side panel – laminated, outside, upholstered inside  
 CAL 133, add \$406 List per three seater

COM 6.25 yds  
 0.75 yd COM per single seat / 1.0 yd COM per single back / .5 yd COM per panel

MODEL	COM	GR 1	GR 2	GR 3	GR 4	GR 5	GR 6
<b>4603M-UL-N</b>	<b>2700</b>	<b>3001</b>	<b>3100</b>	<b>3300</b>	<b>3598</b>	<b>3821</b>	<b>4122</b>

Side panel – upholstered outside, laminated inside  
 CAL 133, add \$406 List per three seater

COM 7.25 yds  
 0.75 yd COM per single seat / 1.0 yd COM per single back / 1.0 yd COM per panel

MODEL	COM	GR 1	GR 2	GR 3	GR 4	GR 5	GR 6
<b>4603M-UU-N</b>	<b>2806</b>	<b>3156</b>	<b>3269</b>	<b>3502</b>	<b>3845</b>	<b>4107</b>	<b>4456</b>

Side panel – upholstered, outside and inside  
 CAL 133, add \$480 List per three seater

Dimensions (inches)

seat H	18.0	seat W	68.0	arm H	17.5
total H	31.75	total W	74.0	depth	30.0

**For KYDEX® arms add suffix K and \$240**  
**Dynamic load tested to 1000 lbs per three seater**



# DIGNITY2 – Behavioral Health Series

For warmth, strength and sustainability  
**Bariatric Single Seater with No Arms**

### Standard Features

- Separate seat and back
- Arm caps available in wood, or polyurethane
- Laminate or upholstered side panels on inside and outside of arm in various combinations
- Upholstered side panels can match or contrast seat/back
- Laminate side panels in any standard Arborite, Formica, Nevamar, Pionite or Wilsonart matte finish
- Sculpted steel leg in any Spectone finish
- No protruding legs or hardware
- Tamper proof fastenings
- Ships assembled as 1, 2 or 3 seaters
- Ships 1/carton 15 cu ft

Contact Spec Customer Service to railroad fabrics (specify repeat info and yardage requirement will be provided) and for repeats greater than 5" x 5"

### Options

- Polyurethane arm caps available in Black (B) or Taupe RAL 7006 (T) or Sterling Grey (G)
- For wood arm caps, select from 7 standard stains, or stain-to-match at no upcharge
- KYDEX® arm caps available in Black (B) or Taupe RAL 7006 (T) or Sterling Grey (G)
- Thermofoil side panels on inside and outside of arm, call Customer Service for pricing and finishes
- Steel leg finish available in any Spectone color
- Add up to 20 lbs of additional weight, add \$148 List
- Non-standard laminates, contact Spec for pricing
- Antibacterial and antimicrobial fabrics available
- Freestanding tables available
- CAL 133
- Elimination of separated seat and back available. Contact factory

---

### Bariatric Single Seater with no arms

COM 3.25 yds  
 1.5 yd COM per single seat / 1.75 yd COM per single back

MODEL	COM	GR 1	GR 2	GR 3	GR 4	GR 5	GR 6
<b>4601G-LL-N</b>	<b>1726</b>	<b>1883</b>	<b>1933</b>	<b>2037</b>	<b>2192</b>	<b>2309</b>	<b>2465</b>

Side panel – laminated, outside and inside  
 CAL 133, add \$137 List per chair

COM 4.25 yds  
 1.5 yd COM per single seat / 1.75 yd COM per single back / .5 yd COM per panel

MODEL	COM	GR 1	GR 2	GR 3	GR 4	GR 5	GR 6
<b>4601G-LU-N</b>	<b>1832</b>	<b>2037</b>	<b>2103</b>	<b>2238</b>	<b>2441</b>	<b>2593</b>	<b>2798</b>

Side panel – laminated, outside, upholstered inside  
 CAL 133, add \$212 List per chair

COM 4.25 yds  
 1.5 yd COM per single seat / 1.75 yd COM per single back / .5 yd COM per panel

MODEL	COM	GR 1	GR 2	GR 3	GR 4	GR 5	GR 6
<b>4601G-UL-N</b>	<b>1832</b>	<b>2037</b>	<b>2103</b>	<b>2238</b>	<b>2441</b>	<b>2593</b>	<b>2798</b>

Side panel – upholstered outside, laminated inside  
 CAL 133, add \$212 List per chair

COM 5.25 yds  
 1.5 yd COM per single seat / 1.75 yd COM per single back / 1.0 yd COM per panel

MODEL	COM	GR 1	GR 2	GR 3	GR 4	GR 5	GR 6
<b>4601G-UU-N</b>	<b>1939</b>	<b>2191</b>	<b>2274</b>	<b>2441</b>	<b>2692</b>	<b>2880</b>	<b>3133</b>

Side panel – upholstered, outside and inside  
 CAL 133, add \$288 List per chair

Dimensions (inches)

seat H	18.0	seat W	31.0	arm H	17.5
total H	31.75	total W	36.5	depth	30.0

**For KYDEX® arms add suffix K and \$240**  
**Dynamic load tested to 750 lbs per chair**



**4601G-N**  
 113 lbs



# DIGNITY2 – Behavioral Health Series

For warmth, strength and sustainability  
Two Seater with Half Arms

## Standard Features

- Separate seat and back
- Arm caps available in wood, or polyurethane
- Laminate or upholstered side panels on inside and outside of arm in various combinations
- Upholstered side panels can match or contrast seat/back
- Laminate side panels in any standard Arborite, Formica, Nevamar, Pionite or Wilsonart matte finish
- Sculpted steel leg in any Spectone finish
- No protruding legs or hardware
- Tamper proof fastenings
- Ships assembled as 1, 2 or 3 seaters
- Ships 1/carton 15 cu ft

Contact Spec Customer Service to railroad fabrics (specify repeat info and yardage requirement will be provided) and for repeats greater than 5" x 5"

## Options

- Polyurethane arm caps available in Black (B) or Taupe RAL 7006 (T) or Sterling Grey (G)
- For wood arm caps, select from 7 standard stains, or stain-to-match at no upcharge
- KYDEX® arm caps available in Black (B) or Taupe RAL 7006 (T) or Sterling Grey (G)
- Thermofoil side panels on inside and outside of arm, call Customer Service for pricing and finishes
- Steel leg finish available in any Spectone color
- Add up to 20 lbs of additional weight, add \$148 List
- Non-standard laminates, contact Spec for pricing
- Antibacterial and antimicrobial fabrics available
- Freestanding tables available
- CAL 133
- Elimination of separated seat and back available. Contact factory

---

### Two Seater with half arms

COM 3.5 yds  
0.75 yd COM per single seat / 1.0 yd COM per single back

MODEL	COM	GR 1	GR 2	GR 3	GR 4	GR 5	GR 6
<b>4612M-LL</b>	<b>2364</b>	<b>2533</b>	<b>2590</b>	<b>2700</b>	<b>2868</b>	<b>2993</b>	<b>3161</b>

Side panel – laminated, outside and inside  
CAL 133, add \$220 List per two seater

COM 5.0 yds  
0.75 yd COM per single seat / 1.0 yd COM per single back / .5 yd COM per panel

MODEL	COM	GR 1	GR 2	GR 3	GR 4	GR 5	GR 6
<b>4612M-LU</b>	<b>2470</b>	<b>2710</b>	<b>2792</b>	<b>2950</b>	<b>3190</b>	<b>3368</b>	<b>3608</b>

Side panel – laminated outside, upholstered inside, half arms will be upholstered  
CAL 133, add \$334 List per two seater

COM 4.5 yds  
0.75 yd COM per single seat / 1.0 yd COM per single back / .5 yd COM per panel

MODEL	COM	GR 1	GR 2	GR 3	GR 4	GR 5	GR 6
<b>4612M-UL</b>	<b>2470</b>	<b>2710</b>	<b>2792</b>	<b>2950</b>	<b>3190</b>	<b>3368</b>	<b>3608</b>

Side panel – upholstered outside, laminated inside, half arms will be laminated  
CAL 133, add \$296 List per two seater

COM 6.0 yds  
0.75 yd COM per single seat / 1.0 yd COM per single back / 1.0 yd COM per panel

MODEL	COM	GR 1	GR 2	GR 3	GR 4	GR 5	GR 6
<b>4612M-UU</b>	<b>2577</b>	<b>2864</b>	<b>2962</b>	<b>3152</b>	<b>3439</b>	<b>3654</b>	<b>3941</b>

Side panel – upholstered, outside and inside  
CAL 133, add \$408 List per two seater

Dimensions (inches)

seat H	18.0	seat W	48.0	arm H	26.0
total H	31.75	total W	54.0	depth	30.0

For KYDEX® arms add suffix K and \$360  
Dynamic load tested to 750 lbs per two seater



**4612M**  
150 lbs



# DIGNITY2 – Behavioral Health Series

For warmth, strength and sustainability  
**Three Seater with Half Arms**

### Standard Features

- Separate seat and back
- Arm caps available in wood, or polyurethane
- Laminate or upholstered side panels on inside and outside of arm in various combinations
- Upholstered side panels can match or contrast seat/back
- Laminate side panels in any standard Arborite, Formica, Nevamar, Pionite or Wilsonart matte finish
- Sculpted steel leg in any Spectone finish
- No protruding legs or hardware
- Tamper proof fastenings
- Ships assembled as 1, 2 or 3 seaters
- Ships 1/carton 15 cu ft

Contact Spec Customer Service to railroad fabrics (specify repeat info and yardage requirement will be provided) and for repeats greater than 5" x 5"

### Options

- Polyurethane arm caps available in Black (B) or Taupe RAL 7006 (T) or Sterling Grey (G)
- For wood arm caps, select from 7 standard stains, or stain-to-match at no upcharge
- KYDEX® arm caps available in Black (B) or Taupe RAL 7006 (T) or Sterling Grey (G)
- Thermofoil side panels on inside and outside of arm, call Customer Service for pricing and finishes
- Steel leg finish available in any Spectone color
- Add up to 20 lbs of additional weight, add \$148 List
- Non-standard laminates, contact Spec for pricing
- Antibacterial and antimicrobial fabrics available
- Freestanding tables available
- CAL 133
- Elimination of separated seat and back available. Contact factory

---

### Three Seater with half arms

COM 5.25 yds

0.75 yd COM per single seat / 1.0 yd COM per single back

MODEL	COM	GR 1	GR 2	GR 3	GR 4	GR 5	GR 6
<b>4613M-LL</b>	<b>3379</b>	<b>3631</b>	<b>3717</b>	<b>3883</b>	<b>4134</b>	<b>4322</b>	<b>4574</b>

Side panel – laminated, outside and inside  
 CAL 133, add \$330 List per three seater

COM 7.25 yds

0.75 yd COM per single seat / 1.0 yd COM per single back / .5 yd COM per panel

MODEL	COM	GR 1	GR 2	GR 3	GR 4	GR 5	GR 6
<b>4613M-LU</b>	<b>3485</b>	<b>3833</b>	<b>3951</b>	<b>4181</b>	<b>4528</b>	<b>4787</b>	<b>5135</b>

Side panel – laminated outside, upholstered inside, half arms will be upholstered  
 CAL 133, add \$481 List per three seater

COM 6.25 yds

0.75 yd COM per single seat / 1.0 yd COM per single back / .5 yd COM per panel

MODEL	COM	GR 1	GR 2	GR 3	GR 4	GR 5	GR 6
<b>4613M-UL</b>	<b>3485</b>	<b>3833</b>	<b>3951</b>	<b>4181</b>	<b>4528</b>	<b>4787</b>	<b>5135</b>

Side panel – upholstered outside, laminated inside, half arms will be laminated  
 CAL 133, add \$406 List per three seater

COM 8.25 yds

0.75 yd COM per single seat / 1.0 yd COM per single back / 1.0 yd COM per panel

MODEL	COM	GR 1	GR 2	GR 3	GR 4	GR 5	GR 6
<b>4613M-UU</b>	<b>3591</b>	<b>3987</b>	<b>4122</b>	<b>4383</b>	<b>4778</b>	<b>5072</b>	<b>5468</b>

Side panel – upholstered, outside and inside  
 CAL 133, add \$556 List per three seater

Dimensions (inches)

seat H	18.0	seat W	75.0	arm H	26.0
total H	31.75	total W	80.5	depth	30.0

**For KYDEX® arms add suffix K and \$480**  
**Dynamic load tested to 1000 lbs per three seater**



**4613M**  
205 lbs





# DIGNITY2 – Behavioral Health Series

For warmth, strength and sustainability  
Side Panel Options

### Standard Features

- Tamper proof fastenings

To order full panel side panels, add ZC-LL, or ZC-U to model number, e.g. 4601M-ZC-LL

To order wall-saving side panels, add WS-LL or WS-U to the model number, e.g. 4601M-WS-U

Pricing is for entire chair (2 end side panels).

Contact Spec Customer Service to railroad fabrics (specify repeat info and yardage requirement will be provided) and for repeats greater than 5" x 5"

### Options

- CAL 133
- Thermofoil side panels on inside and outside of arm, call Customer Service for pricing and finishes

## Extended Side Panels

### Laminate Panels Inside & Outside

MODEL	LIST
ZC-LL	76

### Laminate & Upholstered Combination Panels

COM 0.5 yd per panel

MODEL	COM	GR 1	GR 2	GR 3	GR 4	GR 5	GR 6
ZC-U	78	87	90	96	105	112	121

### Fully Upholstered Panels

COM 1.0 yd per panel

MODEL	COM	GR 1	GR 2	GR 3	GR 4	GR 5	GR 6
ZC-U	78	87	90	96	105	112	121



Side panel extended to floor

## Wall-Saving Side Panels

### Laminate Panels Inside & Outside

MODEL	LIST
WS-LL	126

### Laminate & Upholstered Combination Panels

COM 1.0 yd per panel

MODEL	COM	GR 1	GR 2	GR 3	GR 4	GR 5	GR 6
WS-U	126	246	278	336	436	508	580

### Fully Upholstered Panels

COM 2.0 yd per panel

MODEL	COM	GR 1	GR 2	GR 3	GR 4	GR 5	GR 6
WS-U	126	246	278	336	436	508	580



Wall-saving side panels

## DIGNITY2 – Behavioral Health Series

For warmth, strength and sustainability  
Freestanding Lounge Tables

### Standard Features

- Tops in laminate or veneer
- Laminate tops in any standard Arborite, Formica, Nevamar, Pionite or Wilsonart matte finish
- Laminate tops with PVC, 2mm Bio or hardwood (HB) edge
- Veneers in Beech, Cherry, Mahogany, Maple, Oak, Ash and Walnut
- Select from 7 standard stains or stain-to-match at no upcharge
- Tops utilize Nu Green earth friendly core
- 18" height

*Radius Corner Tables are recommended for open areas*

### Options

- Specify leg frame finish in any Spectone color
- Additional weight can be added, contact factory
- Non-standard laminates, contact Spec for pricing
- Self edge available at same cost as PVC edge

### Freestanding Lounge Tables

Model	PVC/2M Edge	Laminate HB Edge	Veneer HB Edge	Weight	Cu.Ft.
DIGN2 - 24 x 24 SQ	<b>1118</b>	<b>1297</b>	<b>1331</b>	62	7.2
DIGN2 - 30 x 30 SQ	<b>1259</b>	<b>1389</b>	<b>1436</b>	80	13.5
DIGN2 - 36 x 36 SQ	<b>1375</b>	<b>1579</b>	<b>1635</b>	101	18
DIGN2 - 42 x 42 SQ	<b>1672</b>	<b>1967</b>	<b>2057</b>	124	24.5
DIGN2 - 48 x 48 SQ	<b>1851</b>	<b>2110</b>	<b>2206</b>	151	32
DIGN2 - 24 DIA	<b>1090</b>	<b>1419</b>	<b>1454</b>	49	7.2
DIGN2 - 30 DIA	<b>1228</b>	<b>1552</b>	<b>1596</b>	61	13.5
DIGN2 - 36 DIA	<b>1357</b>	<b>1828</b>	<b>1909</b>	76	18
DIGN2 - 42 DIA	<b>1661</b>	<b>2185</b>	<b>2298</b>	93	24.5
DIGN2 - 48 DIA	<b>1718</b>	<b>2426</b>	<b>2549</b>	111	32



### Corner and Spacer Connecting Tables

Model	Laminate PVC/Self Edge	Laminate HB Edge	Veneer HB Edge	Weight	Cu.Ft.
DIGN2RC - 28 x 28 <i>Radius Corner Table</i>	<b>644</b>	<b>807</b>	<b>998</b>	31	2
DIGN2SC - 28 x 28 <i>Square Corner Table</i>	<b>644</b>	<b>807</b>	<b>998</b>	32	2
DIGN2TC - 45 degree <i>Corner Table</i>	<b>644</b>	<b>807</b>	<b>998</b>	26	2
DIGN2ST - 21 x 24 <i>Spacer Table</i>	<b>496</b>	<b>675</b>	<b>815</b>	27	2

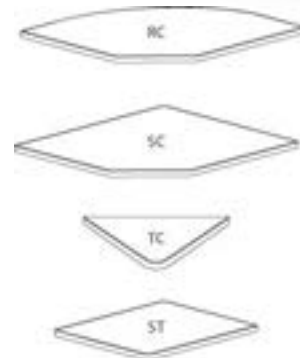

**Dignity2 seating is available connected as 1, 2 and 3 seaters, with or without arms between, with corner or spacer tables. Above pricing includes connector bars.**



## DIGNITY2 – Behavioral Health Series

For warmth, strength and sustainability

### Dolly

#### Standard Features

- Black finish only
- 6" soft wheel casters
- Standard Dolly holds 1 single seat chair
- Ships 1/carton, 17 cu. ft.
- Ships fully assembled



#### Dignity2 - Dolly

Description	Model	Price	Weight
Single Seat Dolly	<b>DIGN-99</b>	<b>510</b>	12lb
Dimensions (inches)			
height	39.0		
width	23.0		
depth	30.0		





# EIGHTEEN5



PLACING AN ORDER IS EASY

### PRODUCT CODE

**17 2 5 - US**

**Series**

17 : Eighteen5

**Arm**

2 : Arms  
3 : Armless

**Casters**

4 : Glides  
5 : Casters

**Upholstery**

N/A : Plastic  
US : Upholstered Seat / Plastic Back  
UP : Fully Upholstered



### OPTIONS

#### UPHOLSTERY



Plastic



Upholstered Seat



Fully Upholstered

#### FOOT



Glide



Casters

### FINISHES

#### PLASTIC

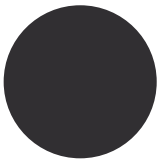

Black

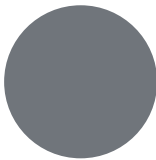

Sterling Grey

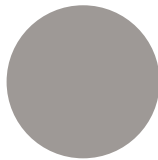

Light Grey

#### FABRIC



Select fabrics from one of our textile partners

#### FRAME



Select from one of our 76 standard Spectone colors



# Eighteen5 Nesting

Plastic Seat and Back

## Standard Features

- Plastic seat and back
- 0.875" diameter, 11 gauge frame
- Black nylon arms
- Frame in any Spectone color
- Black glass-filled nylon arms with inner steel support
- Ships 4/carton

## Options

- For Soft Wheel casters, specify suffix SC and add \$19 List
- Specify frame finish
- Specify shell finish. Choose from Black RAL 9005, Light Grey RAL 7037 or Slate Grey RAL 7043
- CAL 133

---

## Eighteen5 – With Glides

MODEL	PRICE
<b>1724</b>	<b>489</b>
<b>1734</b>	<b>448</b>

Dimensions (inches)

seat H	18	seat W	18.5	seat D	18	arm H	25.5
total H	32	total W	25.25	total D	21.5		

Exceeds BIFMA Seating Durability Test to 500 lbs  
CAL 133, add \$94 List



**1724**  
With arms  
19 lbs



**1734**  
Without arms  
16 lbs

---

## Eighteen5 – With Casters

MODEL	PRICE
<b>1725</b>	<b>489</b>
<b>1735</b>	<b>448</b>

Dimensions (inches)

seat H	18	seat W	18.5	seat D	18	arm H	25.5
total H	32	total W	25.25	total D	21.5		

Exceeds BIFMA Seating Durability Test to 500 lbs  
CAL 133, add \$94 List



**1725**  
With arms  
19 lbs



**1735**  
Without arms  
16 lbs



# Eighteen5 Nesting

Upholstered Seat and Plastic Back

## Standard Features

- Upholstered seat and plastic back
- 0.875" diameter, 11 gauge frame
- Black nylon arms
- Frame in any Spectone color
- Black glass-filled nylon arms with inner steel support
- Ships 4/carton

## Options

- For Soft Wheel casters, specify suffix SC and add \$19 List
- Specify frame finish
- Specify back finish. Choose from Black RAL 9005, Light Grey RAL 7037 or Slate Grey RAL 7043
- Antibacterial and antimicrobial fabrics available
- CAL 133

## Eighteen5 – With Glides

COM 0.35 yd  
0.35 yd COM per single seat

MODEL	COM	GR1	GR2	GR3	GR4	GR5	GR6
1724-US	561	577	582	594	610	623	640
1734-US	520	537	542	553	569	582	599

Dimensions (inches)

seat H	18	seat W	18.5	seat D	18	arm H	25.5
total H	32	total W	25.25	total D	21.5		

Exceeds BIFMA Seating Durability Test to 500 lbs  
CAL 133, add \$104 List  
1/2" extra foam, specify and add \$14 List



**1724-US**  
With arms  
19 lbs



**1734-US**  
Without arms  
16 lbs

## Eighteen5 – With Casters

COM 0.35 yd  
0.35 yd COM per single seat

MODEL	COM	GR1	GR2	GR3	GR4	GR5	GR6
1725-US	561	577	582	594	610	623	640
1735-US	520	537	542	553	569	582	599

Dimensions (inches)

seat H	18	seat W	18.5	seat D	18	arm H	25.5
total H	32	total W	25.25	total D	21.5		

Exceeds BIFMA Seating Durability Test to 500 lbs  
CAL 133, add \$104 List  
1/2" extra foam, specify and add \$14 List



**1725-US**  
With arms  
19 lbs



**1735-US**  
Without arms  
16 lbs



# Eighteen5 Nesting

Upholstered Seat and Back

## Standard Features

- Upholstered seat and back
- 0.875" diameter, 11 gauge frame
- Black nylon arms
- Frame in any Spectone color
- Black glass-filled nylon arms with inner steel support
- Ships 4/carton

## Options

- For Soft Wheel casters, specify suffix SC and add \$19 List
- Specify frame finish
- Antibacterial and antimicrobial fabrics available
- Different fabric on seat and back at no upcharge
- CAL 133

## Eighteen5 – With Glides

COM 0.7 yd  
0.35 yd COM per single seat  
0.35 yd COM per single back

MODEL	COM	GR1	GR2	GR3	GR4	GR5	GR6
<b>1724-UP</b>	<b>571</b>	<b>606</b>	<b>618</b>	<b>643</b>	<b>678</b>	<b>705</b>	<b>742</b>
<b>1734-UP</b>	<b>530</b>	<b>565</b>	<b>577</b>	<b>602</b>	<b>638</b>	<b>664</b>	<b>701</b>

Dimensions (inches)

seat H	18	seat W	18.5	seat D	18	arm H	25.5
total H	32	total W	25.25	total D	21.5		

Exceeds BIFMA Seating Durability Test to 500 lbs  
CAL 133, add \$114 List  
1/2" extra foam, specify and add \$14 List



**1724-UP**  
With arms  
19 lbs



**1734-UP**  
Without arms  
16 lbs

## Eighteen5 – With Casters

COM 0.7 yd  
0.35 yd COM per single seat  
0.35 yd COM per single back

MODEL	COM	GR1	GR2	GR3	GR4	GR5	GR6
<b>1725-UP</b>	<b>571</b>	<b>606</b>	<b>618</b>	<b>643</b>	<b>678</b>	<b>705</b>	<b>742</b>
<b>1735-UP</b>	<b>530</b>	<b>565</b>	<b>577</b>	<b>602</b>	<b>638</b>	<b>664</b>	<b>701</b>

Dimensions (inches)

seat H	18	seat W	18.5	seat D	18	arm H	25.5
total H	32	total W	25.25	total D	21.5		

Exceeds BIFMA Seating Durability Test to 500 lbs  
CAL 133, add \$114 List  
1/2" extra foam, specify and add \$14 List



**1725-UP**  
With arms  
19 lbs



**1735-UP**  
Without arms  
16 lbs

# TWENTY2



PLACING AN ORDER IS EASY

### PRODUCT CODE

**1705 - US**

**Series**

17 : Twenty2

**Arm**

0 : Arms

1 : Armless

**Casters**

4 : Glides

5 : Casters

**Upholstery**

N/A : Plastic

US : Upholstered Seat / Plastic Back

UP : Fully Upholstered



### OPTIONS

#### UPHOLSTERY



Plastic



Upholstered Seat



Fully Upholstered

#### FOOT



Glide



Casters

### FINISHES

#### PLASTIC

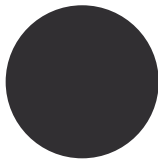

Black

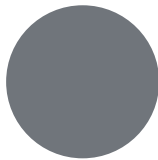

Sterling Grey

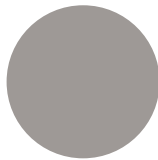

Light Grey

#### FABRIC



Select fabrics from one of our textile partners

#### FRAME



Select from one of our 76 standard Spectone colors



# Twenty2 Nesting

Plastic Seat and Back

## Standard Features

- Plastic seat and back
- 0.875" diameter, 11 gauge frame
- Black nylon arms
- Frame in any Spectone color
- Black glass-filled nylon arms with inner steel support
- Ships 4/carton

## Options

- For Soft Wheel casters, specify suffix SC and add \$19 List
- Specify frame finish
- Specify shell finish. Choose from Black RAL 9005, Light Grey RAL 7037 or Slate Grey RAL 7043
- CAL 133

---

## Twenty2 – With Glides

---

MODEL	PRICE
<b>1704</b>	<b>523</b>
<b>1714</b>	<b>479</b>

Dimensions (inches)

seat H	18	seat W	22	seat D	18	arm H	25.5
total H	32	total W	27.25	total D	21.5		

Exceeds BIFMA Seating Durability Test to 500 lbs  
 CAL 133, add \$94 List



**1704**  
**With arms**  
 22 lbs



**1714**  
**Without arms**  
 20.5 lbs

---

## Twenty2 – With Casters

---

MODEL	PRICE
<b>1705</b>	<b>523</b>
<b>1715</b>	<b>479</b>

Dimensions (inches)

seat H	18	seat W	22	seat D	18	arm H	25.5
total H	32	total W	27.25	total D	21.5		

Exceeds BIFMA Seating Durability Test to 500 lbs  
 CAL 133, add \$94 List



**1705**  
**With arms**  
 22 lbs



**1715**  
**Without arms**  
 20.5 lbs

# Twenty2 Nesting

Upholstered Seat and Plastic Back

## Standard Features

- Upholstered seat and plastic back
- 0.875" diameter, 11 gauge frame
- Black nylon arms
- Frame in any Spectone color
- Black glass-filled nylon arms with inner steel support
- Ships 4/carton

## Options

- For Soft Wheel casters, specify suffix SC and add \$19 List
- Specify frame finish
- Specify back finish. Choose from Black RAL 9005, Light Grey RAL 7037 or Slate Grey RAL 7043
- Antibacterial and antimicrobial fabrics available
- CAL 133

## Twenty2 – With Glides

COM 0.35 yd  
0.35 yd COM per single seat

MODEL	COM	GR1	GR2	GR3	GR4	GR5	GR6
<b>1704-US</b>	<b>601</b>	<b>620</b>	<b>626</b>	<b>639</b>	<b>658</b>	<b>673</b>	<b>693</b>
<b>1714-US</b>	<b>557</b>	<b>576</b>	<b>582</b>	<b>595</b>	<b>614</b>	<b>629</b>	<b>649</b>

Dimensions (inches)

seat H	18	seat W	22	seat D	18	arm H	25.5
total H	32	total W	27.25	total D	21.5		

Exceeds BIFMA Seating Durability Test to 500 lbs  
CAL 133, add \$104 List  
1/2" extra foam, specify and add \$21 List



**1704-US**  
With arms  
22 lbs



**1714-US**  
Without arms  
20.5 lbs

## Twenty2 – With Casters

COM 0.35 yd  
0.35 yd COM per single seat

MODEL	COM	GR1	GR2	GR3	GR4	GR5	GR6
<b>1705-US</b>	<b>601</b>	<b>620</b>	<b>626</b>	<b>639</b>	<b>658</b>	<b>673</b>	<b>693</b>
<b>1715-US</b>	<b>557</b>	<b>576</b>	<b>582</b>	<b>595</b>	<b>614</b>	<b>629</b>	<b>649</b>

Dimensions (inches)

seat H	18	seat W	22	seat D	18	arm H	25.5
total H	32	total W	27.25	total D	21.5		

Exceeds BIFMA Seating Durability Test to 500 lbs  
CAL 133, add \$104 List  
1/2" extra foam, specify and add \$21 List



**1705-US**  
With arms  
22 lbs



**1715-US**  
Without arms  
20.5 lbs

# Twenty2 Nesting

Upholstered Seat and Back

## Standard Features

- Upholstered seat and back
- 0.875" diameter, 11 gauge frame
- Black nylon arms
- Frame in any Spectone color
- Black glass-filled nylon arms with inner steel support
- Ships 4/carton

## Options

- For Soft Wheel casters, specify suffix SC and add \$19 List
- Specify frame finish
- Antibacterial and antimicrobial fabrics available
- Different fabric on seat and back at no upcharge
- CAL 133

## Twenty2 – With Glides

COM 0.7 yd  
0.35 yd COM per single seat  
0.35 yd COM per single back

MODEL	COM	GR1	GR2	GR3	GR4	GR5	GR6
<b>1704-UP</b>	<b>612</b>	<b>650</b>	<b>663</b>	<b>689</b>	<b>727</b>	<b>756</b>	<b>796</b>
<b>1714-UP</b>	<b>568</b>	<b>606</b>	<b>619</b>	<b>645</b>	<b>683</b>	<b>712</b>	<b>752</b>

Dimensions (inches)

seat H	18	seat W	22	seat D	18	arm H	25.5
total H	32	total W	27.25	total D	21.5		

Exceeds BIFMA Seating Durability Test to 500 lbs  
CAL 133, add \$114 List  
1/2" extra foam, specify and add \$21 List



**1704-UP**  
With arms  
22 lbs



**1714-UP**  
Without arms  
20.5 lbs

## Twenty2 – With Casters

COM 0.7 yd  
0.35 yd COM per single seat  
0.35 yd COM per single back

MODEL	COM	GR1	GR2	GR3	GR4	GR5	GR6
<b>1705-UP</b>	<b>612</b>	<b>650</b>	<b>663</b>	<b>689</b>	<b>727</b>	<b>756</b>	<b>796</b>
<b>1715-UP</b>	<b>568</b>	<b>606</b>	<b>619</b>	<b>645</b>	<b>683</b>	<b>712</b>	<b>752</b>

Dimensions (inches)

seat H	18	seat W	22	seat D	18	arm H	25.5
total H	32	total W	27.25	total D	21.5		

Exceeds BIFMA Seating Durability Test to 500 lbs  
CAL 133, add \$114 List  
1/2" extra foam, specify and add \$21 List



**1705-UP**  
With arms  
22 lbs



**1715-UP**  
Without arms  
20.5 lbs

# ENDZONE BENCHES

BACK TO CONTENTS



## PLACING AN ORDER IS EASY

### PRODUCT CODE

**END B2 - CC - 20**

Series	Base	Seat-Table Specification	Depth
EndZone Benches	B2: Two Seats	<i>Two Seat Bench:</i> N/A: No Cushion Seats CC: Two Cushion Seats	16: 16"
	B3: Three Seats B4: Four Seats	<i>Three Seat Bench:</i> N/A: No Cushion Seats CCC: 3 Cushion Seats TCCT: 2 Cushion Seats Centered CCT: 2 Cushion Seats Left Aligned TCC: 2 Cushion Seats Right Aligned CTC: 1 Cushion Seat On Each End	20: 20"
		<i>Four Seat Bench:</i> N/A: No Cushion Seats CCCC: 4 Cushion Seats TCCCT: 3 Cushion Seats Centered CCCT: 3 Cushion Seats Left Aligned TCCC: 3 Cushion Seats Right Aligned CTCC: 1 Cushion Seat Left Aligned, 2 Cushion Seats Right Aligned CCTC: 2 Cushion Seats Left Aligned, 1 Cushion Seat Right Aligned	



### OPTIONS

#### RECTANGULAR VERTICAL WIRE MANAGER



#### POWER OPTION



### FINISHES

#### LAMINATE



Select laminate from our virtually unlimited laminate options

#### EDGE



2MM

#### FABRIC



Select fabrics from one of our textile partners

#### VERTICAL WIRE MANAGER

Select from one of our 76 standard Spectone colors.



# ENDZONE BENCHES DIMENSION OVERVIEW

## WHEN TABLE IS AT THE END OF THE BENCH

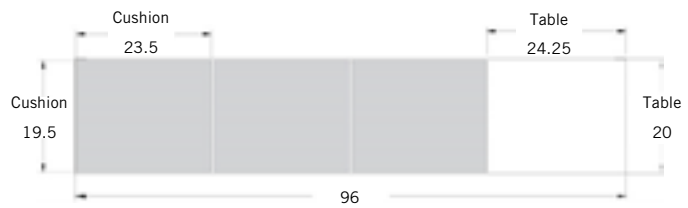
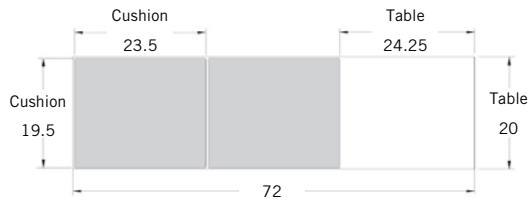

Cushion is recessed 0.25" from the outer edges of the bench. A gap between two adjacent cushions is 0.5". Same table dimensions apply on all benches.

## WHEN TABLE IS IN THE MIDDLE OF THE BENCH

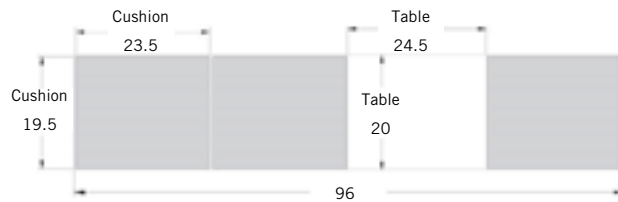
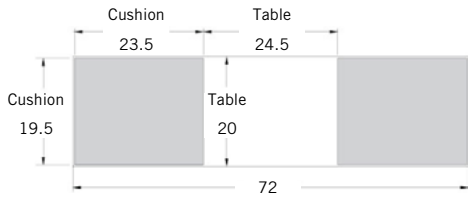

Cushion is recessed 0.25" from the outer edges of the bench. A gap between two adjacent cushions is 0.5". Same table dimensions apply on all benches.

## WHEN TABLE IS ON EACH END OF THE BENCH

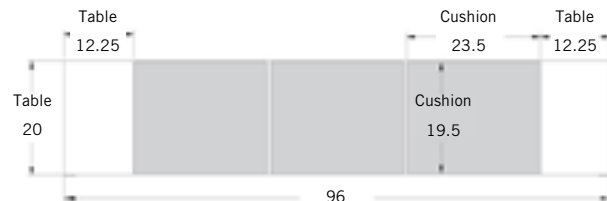
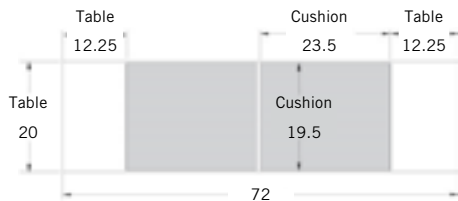

Cushion is recessed 0.25" from the outer edges of the bench. A gap between two adjacent cushions is 0.5". Same table dimensions apply on all benches.



# ENDZONE BENCHES

BACK TO CONTENTS

## Standard Features

- 2" built up edge
- 2mm Edge (2MM)
- Laminate Top, End Panels, and Support Beam
- Laminate Top, End Panels, and Support Beam are available in any standard Wilsonart, Nevamar, Formica, Arborite or Pionite matte Finish.
- Adjustable Glides
- Weight load tested to 250 lbs per seat
- 20" deep

## Options

- 2mm Bio edge available in 38 solid colors
- 2mm PVC edge available in wood grain to match 7 standard stains
- For 16" depth add suffix "-16" to product code
- Cove Power Modules can only be specified on the outside of the end panels - see accessories at the end of this section
- Vertical Wire Manager can only be specified on the inside of the end panels - see accessories at the end of this section
- For two different laminate colors, call factory for pricing
- Antibacterial and antimicrobial fabrics available
- If different grades of fabric specified on different cushions, use higher graded fabric price
- COM 0.5 yd per cushion
- CAL 133, add \$60 List per cushion

Contact Spec Customer Service to railroad fabrics and for repeats greater than 5" x 5"



MODEL	DESCRIPTION	TOP SPECIFICATIONS						DIMENSIONS			LBS	
		COM	GR1	GR2	GR3	GR4	GR5	GR6	H (in)	W (in)		D (in)
<i>Two Seat</i>												
ENDB2	No Cushions	2171							17	48	20	74
ENDB2-CC	2 Cushions	2481	2535	2553	2590	2645	2687	2743	18	48	20	80
<i>Three Seat</i>												
ENDB3	No Cushions	2551							17	72	20	96
ENDB3-CCC	3 Cushions	3016	3097	3124	3180	3262	3325	3409	18	72	20	105
ENDB3-TCCT	2 Cushions Centered	2861	2915	2933	2970	3025	3067	3123	18	72	20	102
ENDB3-CCT	2 Cushions Left Aligned	2861	2915	2933	2970	3025	3067	3123	18	72	20	102
ENDB3-TCC	2 Cushions Right Aligned	2861	2915	2933	2970	3025	3067	3123	18	72	20	102
ENDB3-CTC	Cushion Seat on Each End	2861	2915	2933	2970	3025	3067	3123	18	72	20	102



# ENDZONE BENCHES

BACK TO CONTENTS

## Standard Features

- 2" built up edge
- 2mm Edge (2MM)
- Laminate Top, End Panels, and Support Beam
- Laminate Top, End Panels, and Support Beam are available in any standard Wilsonart, Nevamar, Formica, Arborite or Pionite matte Finish.
- Adjustable Glides
- Weight load tested to 250 lbs per seat
- 20" deep

## Options

- 2mm Bio edge available in 38 solid colors
- 2mm PVC edge available in wood grain to match 7 standard stains
- For 16" depth add suffix "-16" to product code
- Cove Power Modules can be specified on the outside of the end panel - see accessories at the end of this section
- Vertical Wire Manager can be specified on the inside of the end panels - see accessories at the end of this section
- For two different laminate colors, call factory for pricing
- Antibacterial and antimicrobial fabrics available
- If different grades of fabric specified on different cushions, use higher graded fabric price
- COM 0.5 yd per cushion
- CAL 133, add \$60 List per cushion

Contact Spec Customer Service to railroad fabrics and for repeats greater than 5" x 5"



MODEL	DESCRIPTION	TOP SPECIFICATIONS						DIMENSIONS			LBS	
		COM	GR1	GR2	GR3	GR4	GR5	GR6	H (in)	W (in)		D (in)
<i>Four Seat</i>												
ENDB4	No Cushions	2992						17	96	20	118	
ENDB4-CCCC	4 Cushions	3612	3720	3756	3830	3940	4024	4136	18	96	20	130
ENDB4-TCCCT	3 Cushions Centered	3457	3538	3565	3621	3703	3766	3850	18	96	20	127
ENDB4-CCCT	3 Cushions Left Aligned	3457	3538	3565	3621	3703	3766	3850	18	96	20	127
ENDB4-TCCC	3 Cushions Right Aligned	3457	3538	3565	3621	3703	3766	3850	18	96	20	127
ENDB4-CTCC	1 Cushion Left Aligned, 2 Cushions Right Aligned	3457	3538	3565	3621	3703	3766	3850	18	96	20	127
ENDB4-CCTC	2 Cushions Left Aligned, 1 Cushion Right Aligned	3457	3538	3565	3621	3703	3766	3850	18	96	20	127



# ENDZONE BENCHES

## POWER & COMMUNICATION

### Cove Power Modules

	MODEL	DESCRIPTION	LIST	
		<b>Cove, Clamp Mounted</b>		
	<b>COV-1U-B</b>	Cove, 1 power, 2USB, <b>Black</b>	386	
	<b>COV-1U-S</b>	Cove, 1 power, 2USB, <b>Silver Pearl</b>	386	
	<b>COV-1U-W</b>	Cove, 1 power, 2USB, <b>Gloss White</b>	386	
		<i>Cord is 108". USB is for charging only.</i>		
	<b>RVWM-L</b> <b>RVWM-R</b>	<b>Rectangular Vertical Wire Manager for EndZone Benches</b> Fixed sheet metal cover. Specify placement on the inside of the left (RVWM-L) and/or right (RVWM-R) end panel as viewed from the front.	151 151	





## GRAVITY PUBLIC SEATING – Layouts



### Description

- Spec's Gravity Public Seating offers specifiers outstanding value in an eco-friendly design.
- Your layout possibilities are unlimited with spacer, radius and corner tables – for both standard and bariatric seating in virtually any combination.
- Bariatric seating is a 30" wide seat and is load tested to 750 lbs. Cannot be connected to other bariatric seats.
- 21" seat width is standard.
- Standard with steel arms.
- Choice of wood or black polyurethane arms at an upcharge.
- Wood and polyurethane arms are replaceable in the field.
- All models offer a choice of no center arms, half arms or full arms to the floor.
- Glides and separate seat and Flex Back are standard.
- Foam formulated to meet California Bulletin 133 standards is available.
- Please send a drawing of the configuration you require with your order.
- For fabrics you wish railroaded or repeats larger than 5" x 5", please contact the factory with repeat information and yardage requirement will be provided.

### LAYOUTS AND DIMENSIONS

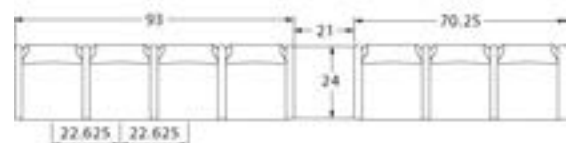
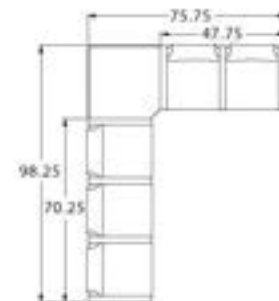
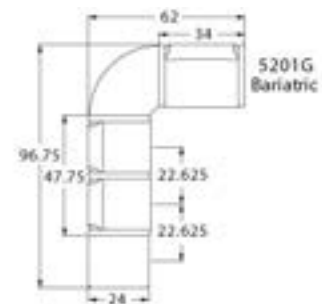



# GRAVITY

BACK TO CONTENTS



PLACING AN ORDER IS EASY

## PRODUCT CODE

**52 0 1 M**

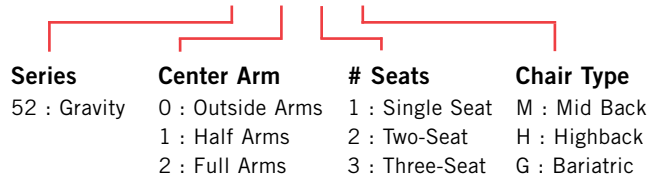

## OPTIONS

### ARM TYPE



Polyurethane



Wood



Steel

## FINISHES

### FRAME



Select from one of our 76 standard Spectone colors

### FABRIC



Select fabrics from one of our textile partners

### ARMS

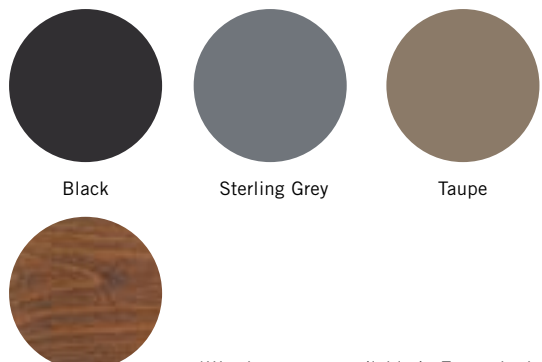

Wood\*

\*Wood arms are available in 7 standard stains and stain-to-match at no upcharge.



# GRAVITY PUBLIC SEATING

Single Seater with arms

## Standard Features

- Separate seat and Flex Back
- Steel arms
- Fully welded wall-saving frame
- Frame in any Spectone color
- Velcro removable back covers
- Replaceable seats
- Use in connected layouts at no upcharge
- Glides
- Ships assembled as 1, 2 or 3 seaters
- Ships 1/carton 15 cu ft

## Options

- Field-replaceable polyurethane arms, see upcharge
- Polyurethane arms available in Black, Sterling Grey and Taupe (RAL 7006)
- Field-replaceable wood arms in Natural Maple, see upcharge. Available in any of 7 standard stains or stain-to-match at no upcharge
- Connected and freestanding tables
- Antibacterial and antimicrobial fabrics available
- Different fabric on seat and back at no upcharge
- CAL 133

Contact Spec Customer Service to railroad fabrics (specify repeat info and yardage requirement will be provided) and for repeats greater than 5" x 5"



## Single Seater with arms

COM 1.75 yds  
 0.75 yd COM per single seat  
 1.0 yd COM per single back

MODEL	COM	GR 1	GR 2	GR 3	GR 4	GR 5	GR 6
<b>5201M</b>	<b>761</b>	<b>844</b>	<b>870</b>	<b>927</b>	<b>1008</b>	<b>1072</b>	<b>1156</b>

For polyurethane arms add suffix P and \$100  
 For wood arms add suffix W and \$144

Dimensions (inches)

seat H	18.0	seat W	21.0	arm H	26.5
total H	35.75	total W	25.0	depth	27.5

Exceeds BIFMA Seating Durability Test to 500 lbs per chair  
 CAL 133, add \$110 List per chair



**5201M**  
30 lbs



# GRAVITY PUBLIC SEATING

Two and Three Seaters with outside arms

## Standard Features

- Separate seat and Flex Back
- Steel arms
- Fully welded wall-saving frame
- Frame in any Spectone color
- Velcro removable back covers
- Replaceable seats
- Use in connected layouts at no upcharge
- Glides
- Ships assembled as 1, 2 or 3 seaters
- Ships 1/carton 26 cu ft (2 seater),  
1/carton 39 cu ft (3 seater)

## Options

- Field-replaceable polyurethane arms, see upcharge
- Polyurethane arms available in Black, Sterling Grey and Taupe (RAL 7006)
- Field-replaceable wood arms in Natural Maple, see upcharge. Available in any of 7 standard stains or stain-to-match at no upcharge
- Connected and freestanding tables
- Antibacterial and antimicrobial fabrics available
- Different fabric on seat and back at no upcharge
- CAL 133

Contact Spec Customer Service to railroad fabrics (specify repeat info and yardage requirement will be provided) and for repeats greater than 5" x 5"

### Two Seater with outside arms

COM 3.5 yds  
0.75 yd COM per single seat  
1.0 yd COM per single back

MODEL	COM	GR 1	GR 2	GR 3	GR 4	GR 5	GR 6
<b>5202M</b>	<b>1379</b>	<b>1544</b>	<b>1598</b>	<b>1712</b>	<b>1873</b>	<b>2000</b>	<b>2168</b>

For polyurethane arms add suffix P and \$100  
For wood arms add suffix W and \$144

Dimensions (inches)

seat H	18.0	seat W	21.0	arm H	26.5
total H	35.75	total W	46.0	depth	27.5

Exceeds BIFMA Seating Durability Test to 500 lbs per two seater  
CAL 133, add \$220 List per two seater



**5202M**  
54 lbs

### Three Seater with outside arms

COM 5.25 yds  
0.75 yd COM per single seat  
1.0 yd COM per single back

MODEL	COM	GR 1	GR 2	GR 3	GR 4	GR 5	GR 6
<b>5203M</b>	<b>2008</b>	<b>2256</b>	<b>2337</b>	<b>2506</b>	<b>2751</b>	<b>2942</b>	<b>3192</b>

For polyurethane arms add suffix P and \$100  
For wood arms add suffix W and \$144

Dimensions (inches)

seat H	18.0	seat W	21.0	arm H	26.5
total H	35.75	total W	67.0	depth	27.5

Exceeds BIFMA Seating Durability Test to 500 lbs per three seater  
CAL 133, add \$330 List per three seater



**5203M**  
78 lbs



# GRAVITY PUBLIC SEATING

Two and Three Seaters with half arms

## Standard Features

- Separate seat and Flex Back
- Steel arms
- Fully welded wall-saving frame
- Frame in any Spectone color
- Velcro removable back covers
- Replaceable seats
- Use in connected layouts at no upcharge
- Glides
- Ships assembled as 1, 2 or 3 seaters
- Ships 1/carton 26 cu ft (2 seater),  
1/carton 39 cu ft (3 seater)

## Options

- Field-replaceable polyurethane arms, see upcharge
- Polyurethane arms available in Black, Sterling Grey and Taupe (RAL 7006)
- Field-replaceable wood arms in Natural Maple, see upcharge. Available in any of 7 standard stains or stain-to-match at no upcharge
- Connected and freestanding tables
- Antibacterial and antimicrobial fabrics available
- Different fabric on seat and back at no upcharge
- CAL 133

Contact Spec Customer Service to railroad fabrics (specify repeat info and yardage requirement will be provided) and for repeats greater than 5" x 5"

---

## Two Seater with half arms

COM 3.5 yds  
0.75 yd COM per single seat  
1.0 yd COM per single back

MODEL	COM	GR 1	GR 2	GR 3	GR 4	GR 5	GR 6
<b>5212M</b>	<b>1480</b>	<b>1646</b>	<b>1699</b>	<b>1814</b>	<b>1974</b>	<b>2101</b>	<b>2268</b>

For polyurethane arms add suffix P and \$150  
For wood arms add suffix W and \$216

Dimensions (inches)

seat H	18.0	seat W	21.0	arm H	26.5
total H	35.75	total W	47.75	depth	27.5

Exceeds BIFMA Seating Durability Test to 500 lbs per two seater  
CAL 133, add \$220 List per two seater



**5212M**  
57 lbs

---

## Three Seater with half arms

COM 5.25 yds  
0.75 yd COM per single seat  
1.0 yd COM per single back

MODEL	COM	GR 1	GR 2	GR 3	GR 4	GR 5	GR 6
<b>5213M</b>	<b>2222</b>	<b>2468</b>	<b>2550</b>	<b>2719</b>	<b>2963</b>	<b>3155</b>	<b>3404</b>

For polyurethane arms add suffix P and \$200  
For wood arms add suffix W and \$288

Dimensions (inches)

seat H	18.0	seat W	21.0	arm H	26.5
total H	35.75	total W	70.25	depth	27.5

Exceeds BIFMA Seating Durability Test to 500 lbs per two seater  
CAL 133, add \$330 List per three seater



**5213M**  
81 lbs



# GRAVITY PUBLIC SEATING

Two and Three Seaters with full arms

## Standard Features

- Separate seat and Flex Back
- Steel arms
- Fully welded wall-saving frame
- Frame in any Spectone color
- Velcro removable back covers
- Replaceable seats
- Use in connected layouts at no upcharge
- Glides
- Ships assembled as 1, 2 or 3 seaters
- Ships 1/carton 26 cu ft (2 seater),  
1/carton 39 cu ft (3 seater)

## Options

- Field-replaceable polyurethane arms, see upcharge
- Polyurethane arms available in Black, Sterling Grey and Taupe (RAL 7006)
- Field-replaceable wood arms in Natural Maple, see upcharge. Available in any of 7 standard stains or stain-to-match at no upcharge
- Connected and freestanding tables
- Antibacterial and antimicrobial fabrics available
- Different fabric on seat and back at no upcharge
- CAL 133

Contact Spec Customer Service to railroad fabrics (specify repeat info and yardage requirement will be provided) and for repeats greater than 5" x 5"

---

## Two Seater with full arms

COM 3.5 yds  
0.75 yd COM per single seat  
1.0 yd COM per single back

MODEL	COM	GR 1	GR 2	GR 3	GR 4	GR 5	GR 6
<b>5222M</b>	<b>1480</b>	<b>1646</b>	<b>1699</b>	<b>1814</b>	<b>1974</b>	<b>2101</b>	<b>2268</b>

For polyurethane arms add suffix P and \$150  
For wood arms add suffix W and \$216

Dimensions (inches)

seat H	18.0	seat W	21.0	arm H	26.5
total H	35.75	total W	47.75	depth	27.5

Exceeds BIFMA Seating Durability Test to 500 lbs per two seater  
CAL 133, add \$220 List per two seater



**5222M**  
57 lbs

---

## Three Seater with full arms

COM 5.25 yds  
0.75 yd COM per single seat  
1.0 yd COM per single back

MODEL	COM	GR 1	GR 2	GR 3	GR 4	GR 5	GR 6
<b>5223M</b>	<b>2222</b>	<b>2468</b>	<b>2550</b>	<b>2719</b>	<b>2963</b>	<b>3155</b>	<b>3404</b>

For polyurethane arms add suffix P and \$200  
For wood arms add suffix W and \$288

Dimensions (inches)

seat H	18.0	seat W	21.0	arm H	26.5
total H	35.75	total W	70.25	depth	27.5

Exceeds BIFMA Seating Durability Test to 500 lbs per three seater  
CAL 133, add \$330 List per three seater



**5223M**  
81 lbs



# GRAVITY PUBLIC SEATING

## Bariatric Single Seater with arms

### Standard Features

- Separate seat and Flex Back
- Steel arms
- Fully welded wall-saving frame
- Frame in any Spectone color
- Velcro removable back covers
- Replaceable seats
- Use in connected layouts at no upcharge
- Glides
- Cannot connect bariatric seating to bariatric seating
- Ships assembled as 1, 2 or 3 seaters
- Ships 1/carton 20 cu ft

### Options

- Field-replaceable polyurethane arms, see upcharge
- Polyurethane arms available in Black, Sterling Grey and Taupe (RAL 7006)
- Field-replaceable wood arms in Natural Maple, see upcharge. Available in any of 7 standard stains or stain-to-match at no upcharge
- Connected and freestanding tables
- Antibacterial and antimicrobial fabrics available
- Different fabric on seat and back at no upcharge
- CAL 133

Contact Spec Customer Service to railroad fabrics (specify repeat info and yardage requirement will be provided) and for repeats greater than 5" x 5"



## Bariatric Single Seater with arms

COM 3.0 yds  
 1.5 yd COM per single seat  
 1.5 yd COM per single back

MODEL	COM	GR 1	GR 2	GR 3	GR 4	GR 5	GR 6
<b>5201G</b>	<b>946</b>	<b>1111</b>	<b>1165</b>	<b>1280</b>	<b>1440</b>	<b>1568</b>	<b>1734</b>

For polyurethane arms add suffix P and \$100  
 For wood arms add suffix W and \$144

Dimensions (inches)

seat H	18.0	seat W	30.0	arm H	26.5
total H	35.75	total W	34.0	depth	27.5

Exceeds BIFMA Seating Durability Test to 750 lbs per chair  
 CAL 133, add \$149 List per chair



**5201G**  
37 lbs



# GRAVITY PUBLIC SEATING

Highback Single Seater with arms – Ottoman and Headrest

## Standard Features

- Separate seat and Flex Back
- Steel arms
- Fully welded wall-saving frame
- Frame in any Spectone color
- Velcro removable back covers
- Replaceable seats
- Use in connected layouts at no upcharge
- Glides
- Ships assembled as 1, 2 or 3 seaters
- Ships 1/carton 18 cu ft

## Options

- Field-replaceable polyurethane arms, see upcharge
- Polyurethane arms available in Black, Sterling Grey and Taupe (RAL 7006)
- Field-replaceable wood arms in Natural Maple, see upcharge. Available in any of 7 standard stains or stain-to-match at no upcharge
- Connected and freestanding tables
- Antibacterial and antimicrobial fabrics available
- Different fabric on seat and back at no upcharge
- CAL 133

Contact Spec Customer Service to railroad fabrics (specify repeat info and yardage requirement will be provided) and for repeats greater than 5" x 5"



## Highback Single Seater with arms

COM 1.85 yds  
 0.75 yd COM per single seat  
 1.1 yds COM per single back

MODEL	COM	GR 1	GR 2	GR 3	GR 4	GR 5	GR 6
<b>5201H</b>	<b>816</b>	<b>916</b>	<b>948</b>	<b>1016</b>	<b>1114</b>	<b>1190</b>	<b>1290</b>

For polyurethane arms add suffix P and \$100  
 For wood arms add suffix W and \$144

### Dimensions (inches)

seat H	18.0	seat W	21.0	arm H	26.5
total H	44.5	total W	25.0	depth	27.5

Exceeds BIFMA Seating Durability Test to 500 lbs per chair  
 CAL 133, add \$123 List per chair



**5201H**  
35 lbs



# GRAVITY PUBLIC SEATING

## Freestanding Lounge Tables – Corner and Spacer Connecting Tables

### Standard Features

- Tops in laminate or veneer
- Laminate tops in any standard Arborite, Formica, Nevamar, Pionite or Wilsonart matte finish
- Freestanding lounge tables available with PVC, 2mm Bio or hardwood (HB) edge
- Connecting table tops available with PVC Flat edge, Self edge or hardwood (HB) edge
- Select from 7 standard stains or stain-to-match at no upcharge
- 1.75" post legs in any Spectone color
- Tops utilize Nu Green earth friendly core
- Glides
- 18" height

### Options

- Non-standard laminates, contact Spec for pricing
- Custom size spacer tables for restricted spaces
- Other sizes may be available

*Radius Corner Tables are recommended for open areas*

### Freestanding Lounge Tables

Model	Laminate PVC/Self/2MM	Laminate HB Edge	Veneer HB Edge	Weight	Cu.Ft.
52 - 24 x 24 SQ	<b>599</b>	<b>778</b>	<b>919</b>	28	7.2
52 - 24 x 48 RE	<b>747</b>	<b>943</b>	<b>1142</b>	48	18
52 - 30 x 30 SQ	<b>697</b>	<b>827</b>	<b>979</b>	43	13.5
52 - 24 DIA	<b>571</b>	<b>900</b>	<b>1087</b>	26	7.2
52 - 30 DIA	<b>666</b>	<b>990</b>	<b>1182</b>	40	7.2



### Corner and Spacer Connecting Tables

Model	Laminate PVC/Self Edge	Laminate HB Edge	Veneer HB Edge	Weight	Cu.Ft.
52RC - 28 x 28 <i>Radius Corner Table</i>	<b>644</b>	<b>807</b>	<b>998</b>	26	2
52SC - 28 x 28 <i>Square Corner Table</i>	<b>644</b>	<b>807</b>	<b>998</b>	26	2
52TC - 45 degree <i>Corner Table</i>	<b>644</b>	<b>807</b>	<b>998</b>	19	2
52ST - 21 x 24 <i>Spacer Table</i>	<b>496</b>	<b>675</b>	<b>815</b>	19	2
52ET - 21 x 24 <i>End Table</i>	<b>539</b>	<b>719</b>	<b>860</b>	19	2

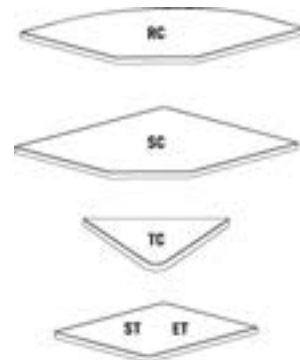

# HEAVY DUTY SEATING



PLACING AN ORDER IS EASY

## PRODUCT CODE



\*The code for our heavy duty seating options featured in the pages below is the same as a regular model of the chair you are specifying. By adding the letters "HD" at the end of the product code, it lets us know the product is intended for a behavioral health environment and the features below will automatically be specified.

## FEATURES

**Tamper-Proof**



**Weighted**



**Loctite Glides**



**Secured Zippers**



**Springless Seat Cushion**



## FINISHES

**FRAME**



Select from one of our 76 standard Spectone colors

**FABRIC**



Select fabrics from one of our textile partners

**ARMS**



Black

Sterling Grey

Taupe



# Heavy Duty Specialty Seating

2000 Series

## Standard Features

- Fully welded 1.5" frame
- Frame filled with added weight, closed at floor
- Frame in any Spectone color
- Steel glides secured with Loctite
- Tamperproof hardware
- Zippered covers glued shut, pulls removed
- Ships assembled
- Ships 1/carton 17 cu ft

## Options

- Floor mounting glides, add \$44 List/chair
- Cal 133

Contact Spec Customer Service to railroad fabrics (specify repeat info and yardage requirement will be provided) and for repeats greater than 5" x 5"

---

## 2000 Series One Piece Single Seater with arms – Sled Base

COM 1.75 yds  
1.75 yd COM per single seat and back

MODEL	COM	GR 1	GR 2	GR 3	GR 4	GR 5	GR 6
<b>2201CHD</b>	<b>1064</b>	<b>1145</b>	<b>1174</b>	<b>1229</b>	<b>1311</b>	<b>1374</b>	<b>1458</b>

Dimensions (inches)

seat H	18.0	seat W	22.0	arm H	26.0
total H	35.0	total W	25.0	depth	26.5

Exceeds BIFMA Seating Durability Test to 500 lbs per seat  
CAL 133, add \$99 List per seat



**2201CHD**  
67 lbs

---

## 2000 Series Separate Seat and Back with arms – Sled Base

COM 1.75 yds  
1.0 yd COM per single seat  
0.75 yd COM per single back

MODEL	COM	GR 1	GR 2	GR 3	GR 4	GR 5	GR 6
<b>2201CHDS</b>	<b>1250</b>	<b>1331</b>	<b>1359</b>	<b>1414</b>	<b>1496</b>	<b>1560</b>	<b>1643</b>

Dimensions (inches)

seat H	18.0	seat W	22.0	arm H	26.0
total H	35.0	total W	25.0	depth	26.5

Exceeds BIFMA Seating Durability Test to 500 lbs per seat  
CAL 133, add \$99 List per chair



**2201CHDS**  
67 lbs



# Heavy Duty Specialty Seating

## Companion Series

### Standard Features

- Separate seat and back
- Polyurethane arms
- Fully welded 1.75" frame
- Added weight, Sled base
- Frame in any Spectone color
- Steel glides secured with Loctite
- Tamperproof hardware
- Zippered covers glued shut, pulls removed
- Ships assembled
- Medium Back ships 1/carton 15 cu ft
- Highback ships 1/carton 19 cu ft

### Options

- Polyurethane arms are available in Black, Sterling Grey and Taupe (RAL 7006)
- Floor mounting glides, add \$44 List/chair
- Cal 133

Contact Spec Customer Service to railroad fabrics (specify repeat info and yardage requirement will be provided) and for repeats greater than 5" x 5"

---

### Companion Medium Back armless – Sled Base

COM 2.0 yds  
1.0 yd COM per single seat  
1.0 yd COM per single back

MODEL	COM	GR 1	GR 2	GR 3	GR 4	GR 5	GR 6
<b>4101MHD</b>	<b>1175</b>	<b>1280</b>	<b>1314</b>	<b>1386</b>	<b>1488</b>	<b>1569</b>	<b>1675</b>

Dimensions (inches)  
seat H 18.0 seat W 21.0  
total H 32.5 total W 25.0 depth 27.0

Exceeds BIFMA Seating Durability Test to 500 lbs per chair  
CAL 133, add \$99 List per chair



**4101MHD**  
65 lbs

---

### Companion Medium Back with arms – Sled Base

COM 2.0 yds  
1.0 yd COM per single seat  
1.0 yd COM per single back

MODEL	COM	GR 1	GR 2	GR 3	GR 4	GR 5	GR 6
<b>4201MHD</b>	<b>1379</b>	<b>1484</b>	<b>1518</b>	<b>1589</b>	<b>1692</b>	<b>1772</b>	<b>1878</b>

For steel arms add suffix S and \$64

Dimensions (inches)  
seat H 18.0 seat W 21.0 arm H 27.0  
total H 32.5 total W 26.0 depth 27.0

Exceeds BIFMA Seating Durability Test to 500 lbs per seat  
CAL 133, add \$99 List per chair



**4201MHD**  
65 lbs



# Heavy Duty Specialty Seating

## Companion Series

### Standard Features

- Separate seat and back
- Polyurethane arms
- Fully welded 1.75" frame
- Added weight, Sled base
- Frame in any Spectone color
- Steel glides secured with Loctite
- Tamperproof hardware
- Zippered covers glued shut, pulls removed
- Ships assembled
- Medium Back ships 1/carton 15 cu ft
- Highback ships 1/carton 19 cu ft

### Options

- Polyurethane arms are available in Black, Sterling Grey and Taupe (RAL 7006)
- Floor mounting glides, add \$44 List/chair
- Cal 133

Contact Spec Customer Service to railroad fabrics (specify repeat info and yardage requirement will be provided) and for repeats greater than 5" x 5"

---

### Companion Highback with arms – Sled Base

COM 2.25 yds  
 1.0 yd COM per single seat  
 1.25 yd COM per single back

MODEL	COM	GR 1	GR 2	GR 3	GR 4	GR 5	GR 6
<b>4201HHD</b>	<b>1434</b>	<b>1549</b>	<b>1589</b>	<b>1666</b>	<b>1782</b>	<b>1870</b>	<b>1985</b>

For steel arms add suffix S and \$64

Dimensions (inches)

seat H	18.0	seat W	21.0	arm H	27.0
total H	45.0	total W	26.0	depth	27.0

Exceeds BIFMA Seating Durability Test to 500 lbs per seat  
 CAL 133, add \$123 List per chair



**4201HHD**  
71 lbs

---

### Companion Bariatric with arms – Sled Base

COM 3.25 yds  
 1.5 yd COM per single seat  
 1.75 yd COM per single back

MODEL	COM	GR 1	GR 2	GR 3	GR 4	GR 5	GR 6
<b>4201GHD</b>	<b>1685</b>	<b>1843</b>	<b>1893</b>	<b>2002</b>	<b>2155</b>	<b>2276</b>	<b>2435</b>

For steel arms add suffix S and \$64

Dimensions (inches)

seat H	18.0	seat W	30.0	arm H	27.0
total H	32.5	total W	35.0	depth	27.0

Exceeds BIFMA Seating Durability Test to 750 lbs per seat  
 CAL 133, add \$149 List per chair



**4201GHD**  
78 lbs



# Heavy Duty Specialty Seating

## Midway Series

### Standard Features

- Separate seat and back
- Polyurethane arms or wood arms
- Fully welded 1.25" frame with glides
- Added weight, Sled base
- Frame in any Spectone color
- Steel glides secured with Loctite
- Tamperproof hardware
- Zippered covers glued shut, pulls removed
- Ships assembled as 1, 2 or 3 seaters
- Ships 1/carton 17 cu ft

### Options

- Polyurethane arms available in Black, Sterling Grey or Taupe (RAL 7006)
- Wood arms in Natural Maple are available in any of 7 standard stains or stain-to-match at no up charge
- Floor mounting glides, add \$44 List/chair
- Antibacterial and antimicrobial fabrics available
- Different fabric on seat and back at no upcharge
- CAL 133

Contact Spec Customer Service to railroad fabrics (specify repeat info and yardage requirement will be provided) and for repeats greater than 5" x 5"

---

### Midway Single Seater with arms – Sled Base

COM 1.5 yds  
 .5 yd COM per single seat  
 1.0 yd COM per single back

MODEL	COM	GR 1	GR 2	GR 3	GR 4	GR 5	GR 6
<b>3201UHD</b>	<b>1259</b>	<b>1361</b>	<b>1396</b>	<b>1463</b>	<b>1564</b>	<b>1642</b>	<b>1746</b>

Dimensions (inches)  
 seat H 18.0 seat W 20.5 arm H 26.0  
 total H 36.0 total W 23.75 depth 26.0

Exceeds BIFMA Seating Durability Test to 500 lbs per seat  
 CAL 133, add \$110 List per seat



**3201UHD**  
49 lbs

---

### Midway Highback with arms – Sled Base

COM 1.6 yds  
 .5 yd COM per single seat  
 1.1 yds COM per single back

MODEL	COM	GR 1	GR 2	GR 3	GR 4	GR 5	GR 6
<b>3201HHD</b>	<b>1368</b>	<b>1473</b>	<b>1510</b>	<b>1577</b>	<b>1682</b>	<b>1763</b>	<b>1869</b>

Dimensions (inches)  
 seat H 18.0 seat W 20.5 arm H 26.0  
 total H 46.0 total W 23.75 depth 26.0

Exceeds BIFMA Seating Durability Test to 500 lbs per seat  
 CAL 133, add \$137 List per chair



**3201HHD**  
51 lbs



# Heavy Duty Specialty Seating

## Midway Series

### Standard Features

- Separate seat and back
- Polyurethane arms or wood arms
- Fully welded 1.25" frame with glides
- Added weight, Sled base
- Frame in any Spectone color
- Steel glides secured with Loctite
- Tamperproof hardware
- Zippered covers glued shut, pulls removed
- Ships assembled as 1, 2 or 3 seaters
- Ships 1/carton 17 cu ft

### Options

- Polyurethane arms available in Black, Sterling Grey or Taupe (RAL 7006)
- Wood arms in Natural Maple are available in any of 7 standard stains or stain-to-match at no up charge
- Floor mounting glides, add \$44 List/chair
- Antibacterial and antimicrobial fabrics available
- Different fabric on seat and back at no upcharge
- CAL 133

Contact Spec Customer Service to railroad fabrics (specify repeat info and yardage requirement will be provided) and for repeats greater than 5" x 5"



### Midway Bariatric with arms – Sled Base

COM 2.55 yds  
 .8 yd COM per single seat  
 1.75 yd COM per single back

MODEL	COM	GR 1	GR 2	GR 3	GR 4	GR 5	GR 6
<b>3201GHD</b>	<b>1640</b>	<b>1788</b>	<b>1840</b>	<b>1937</b>	<b>2085</b>	<b>2199</b>	<b>2350</b>

Dimensions (inches)

seat H	18.0	seat W	30.0	arm H	26.0
total H	36.0	total W	32.0	depth	26.0

Exceeds BIFMA Seating Durability Test to 750 lbs per seat  
 CAL 133, add \$187 List per seat



**3201GHD**  
51 lbs



# Heavy Duty Specialty Seating

## 1000 Series

### Standard Features

- One piece seat and back
- Fully welded 1.25" frame
- Frame filled with added weight, closed at floor
- Frame in any Spectone color
- Steel glides secured with Loctite
- Tamperproof hardware
- Zippered covers glued shut, pulls removed
- Ships assembled
- Ships 1/carton 15 cu ft

### Options

- Floor mounting glides, add \$44 List/chair
- Cal 133

Contact Spec Customer Service to railroad fabrics (specify repeat info and yardage requirement will be provided) and for repeats greater than 5" x 5"



---

### 1000 Series Armless Medium Back – Sled Base

---

1.25 yds COM per single seat and back

MODEL	COM	GR 1	GR 2	GR 3	GR 4	GR 5	GR 6
<b>1014HD</b>	<b>1010</b>	<b>1080</b>	<b>1097</b>	<b>1140</b>	<b>1204</b>	<b>1254</b>	<b>1319</b>

Dimensions (inches)

seat H	18.0	seat W	18.5	depth	22.0
total H	33.0	total W	18.5		

Exceeds BIFMA Seating Durability Test to 500 lbs per chair  
 CAL 133, add \$74 List per chair



**1014HD**  
55 lbs





# Heavy Duty Specialty Seating

## Snowball 2

### Standard Features

- 0.875" frame
- Extra weight added to seat pan
- Frame in any Spectone color
- Steel glides secured with Loctite
- Tamperproof hardware
- Does not stack
- Ships 1/carton 11 cu ft
- Staples on the bottom of the seat are covered by a 100% recycled plastic seat pan

### Options

- Floor mounting glides, add \$44 List/chair
- Cal 133

Contact Spec Customer Service to railroad fabrics (specify repeat info and yardage requirement will be provided) and for repeats greater than 5" x 5"



### Snowball 2 Armless – Sled Base

COM 1.0 yd  
0.5 yd COM per single seat  
0.5 yd COM per single back

MODEL	COM	GR 1	GR 2	GR 3	GR 4	GR 5	GR 6
<b>1891HD</b>	<b>616</b>	<b>667</b>	<b>685</b>	<b>720</b>	<b>771</b>	<b>811</b>	<b>863</b>

Dimensions (inches)  
seat H 18.0 seat W 18.5 depth 21.5  
total H 33.0 total W 20.25

Exceeds BIFMA Seating Durability Test to 500 lbs per chair  
CAL 133, add \$58 List per chair



**1891HD**  
44 lbs

### Snowball 2 with Steel Arms – Sled Base

COM 1.0 yd  
0.5 yd COM per single seat  
0.5 yd COM per single back

MODEL	COM	GR 1	GR 2	GR 3	GR 4	GR 5	GR 6
<b>1881HD</b>	<b>658</b>	<b>709</b>	<b>727</b>	<b>762</b>	<b>813</b>	<b>853</b>	<b>905</b>

Dimensions (inches)  
seat H 18.0 seat W 18.5 depth 21.5  
total H 33.0 total W 23.5

Exceeds BIFMA Seating Durability Test to 500 lbs per chair  
CAL 133, add \$58 List per chair



**1881HD**  
46 lbs



# Heavy Duty Specialty Seating

## Traffic Public Seating

### Standard Features

- Tabletop standard in Laminate with PVC, 2MM Bio or Self Edge
- Laminate tops are available in any standard Wilsonart, Nevamar, Pionite, Formica or Arborite matte finish offerings.  
For other laminates please contact factory for pricing
- 2mm Bio edge or PVC edges in flat or bullnose are available in 38 colors.
- Floor Mounting plates
- Tamperproof fasteners
- Welded steel end caps

### Options

- 30" Bariatric seats are available. Contact factory for pricing
- Coated steel tabletop available. Contact factory for pricing
- CAL 133

Contact Spec Customer Service to railroad fabrics (specify repeat info and yardage requirement will be provided) and for repeats greater than 5" x 5"

---

### Perforated Beam without arms, without upholstered cushions

N/A COM per single seat

MODEL	PRICE
<b>7100NHD</b>	<b>4503</b>

Dimensions (inches)

seat H	18.0	seat W	22.0	table top	30x48	table H	29.0
total H	33.75	total W	48.0	seat depth	17.0	total depth	74

Exceeds BIFMA Seating Durability Test to 500 lbs per chair

---

### Perforated Beam without arms, with upholstered cushions

0.75 yd COM per single seat and back

MODEL	COM	GR 1	GR 2	GR 3	GR 4	GR 5	GR 6
<b>7100UHD</b>	<b>4575</b>	<b>4728</b>	<b>4780</b>	<b>4911</b>	<b>5066</b>	<b>5184</b>	<b>5338</b>

Dimensions (inches)

seat H	18.0	seat W	22.0	table top	30x48	table H	29.0
total H	33.75	total W	48.0	seat depth	17.0	total depth	74

Exceeds BIFMA Seating Durability Test to 500 lbs per chair

CAL 133, add \$220 List per unit



## MIDWAY PUBLIC SEATING – Layouts



### Description

- Spec's high durability public seating in a lighter scale allows specifiers to maximize space requirements.
- Your layout possibilities are unlimited with spacer, radius and corner tables – for both standard and bariatric seating in virtually any combination.
- Bariatric seating is a 30" wide seat and is load tested to 750 lbs. Cannot be connected to other bariatric seats.
- 20.5" seat width is standard.
- Choice of polyurethane or wood arms which are replaceable in the field.
- All models offer a choice of no center arms, half arms or full arms to the floor.
- 1.25" diameter wall-saving frame is standard to protect both wall and fabric.
- Separate seat and back provide exceptional comfort and ease of maintenance.
- Please send a drawing of the configuration you require with your order.
- Optional floor mounting glides available.
- For fabrics you wish railroaded or repeats larger than 5" x 5", please contact the factory with repeat information and yardage requirement will be provided.

### LAYOUTS AND DIMENSIONS

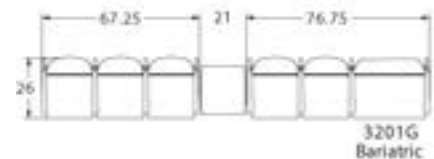
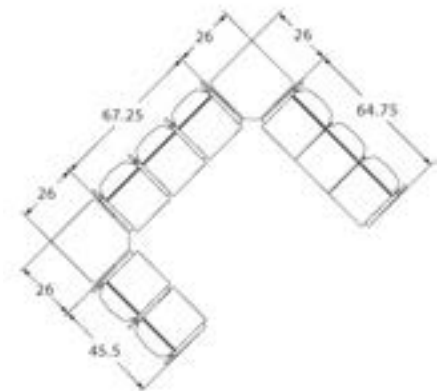
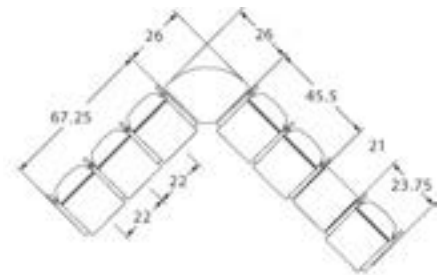

# MIDWAY



PLACING AN ORDER IS EASY

## PRODUCT CODE

**3201U**

Series	Arm/Other	# Seats	Chair Type
32 : Midway	0 : Outside Arms 1 : Half Arms 2 : Full Arms 3 : Easy Access Hip Chair	1 : Single Seat 2 : Two-Seat 3 : Three-Seat	U : Mid Back H : Highback G : Bariatric GH : Highback Bariatric



## OPTIONS

### ARM



Wood Arm



Poly Arm

## FINISHES

### FRAME



Select from one of our 76 standard Spectone colors

### FABRIC

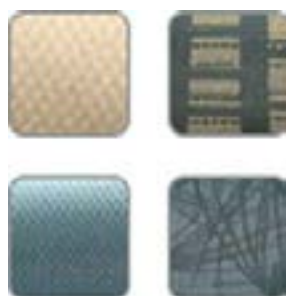

Select fabrics from one of our textile partners

### ARMS



\*Wood arms are available in 7 standard stains and stain-to-match at no upcharge.



# MIDWAY Public Seating

Single Seater with arms

## Standard Features

- Separate seat and back
- Polyurethane arms or wood arms
- Fully welded 1.25" frame with glides
- Frame in any Spectone color
- Velcro removable back covers
- Replaceable seats
- Use in connected layouts at no upcharge
- Arms replaceable in the field
- Ships assembled as 1, 2 or 3 seaters
- Ships 1/carton 17 cu ft

## Options

- Polyurethane arms available in Black, Sterling Grey or Taupe (RAL 7006)
- Wood arms in Natural Maple are available in any of 7 standard stains or stain-to-match at no upcharge
- For Flex back add suffix FB and \$166 List.  
*Note: Wall-saving frame is not available when Flex back is specified.*
- Connected and freestanding tables
- Antibacterial and antimicrobial fabrics available
- Different fabric on seat and back at no upcharge
- CAL 133

Contact Spec Customer Service to railroad fabrics (specify repeat info and yardage requirement will be provided) and for repeats greater than 5" x 5"



## Single Seater with arms

COM 1.5 yds  
0.5 yd COM per single seat  
1.0 yd COM per single back

MODEL	COM	GR 1	GR 2	GR 3	GR 4	GR 5	GR 6
<b>3201U</b>	<b>896</b>	<b>998</b>	<b>1032</b>	<b>1099</b>	<b>1202</b>	<b>1280</b>	<b>1382</b>

Dimensions (inches)

seat H	18.0	seat W	20.5	arm H	26.0
total H	36.0	total W	23.75	depth	26.0

Exceeds BIFMA Seating Durability Test to 500 lbs per chair  
CAL 133, add \$110 List per chair



**3201U**  
37 lbs



# MIDWAY Public Seating

Two and Three Seaters with outside arms

## Standard Features

- Separate seat and back
- Polyurethane arms or wood arms
- Fully welded 1.25" frame with glides
- Frame in any Spectone color
- Velcro removable back covers
- Replaceable seats
- Use in connected layouts at no upcharge
- Arms replaceable in the field
- Ships assembled as 1, 2 or 3 seaters
- Ships 1/carton 28 cu ft (2 seater),  
1/carton 42 cu ft (3 seater)

## Options

- Polyurethane arms available in Black, Sterling Grey or Taupe (RAL 7006)
- Wood arms in Natural Maple are available in any of 7 standard stains or stain-to-match at no up charge
- Connected and freestanding tables
- Antibacterial and antimicrobial fabrics available
- Different fabric on seat and back at no upcharge
- CAL 133

Contact Spec Customer Service to railroad fabrics (specify repeat info and yardage requirement will be provided) and for repeats greater than 5" x 5"



### Two Seater with outside arms

COM 3.0 yds  
0.5 yd COM per single seat  
1.0 yd COM per single back

MODEL	COM	GR 1	GR 2	GR 3	GR 4	GR 5	GR 6
<b>3202U</b>	<b>1433</b>	<b>1635</b>	<b>1703</b>	<b>1839</b>	<b>2043</b>	<b>2200</b>	<b>2403</b>

Dimensions (inches)

seat H	18.0	seat W	20.5	arm H	26.0
total H	36.0	total W	44.25	depth	26.0

Exceeds BIFMA Seating Durability Test to 750 lbs per two seater  
CAL 133, add \$220 List per two seater



**3202U**  
66 lbs

### Three Seater with outside arms

COM 4.5 yds  
0.5 yd COM per single seat  
1.0 yd COM per single back

MODEL	COM	GR 1	GR 2	GR 3	GR 4	GR 5	GR 6
<b>3203U</b>	<b>1914</b>	<b>2221</b>	<b>2323</b>	<b>2527</b>	<b>2831</b>	<b>3065</b>	<b>3371</b>

Dimensions (inches)

seat H	18.0	seat W	20.5	arm H	26.0
total H	36.0	total W	64.75	depth	26.0

Exceeds BIFMA Seating Durability Test to 1000 lbs per three seater  
CAL 133, add \$330 List per three seater



**3203U**  
94 lbs



# MIDWAY Public Seating

Two and Three Seaters with half arms

## Standard Features

- Separate seat and back
- Polyurethane arms or wood arms
- Fully welded 1.25" frame with glides
- Frame in any Spectone color
- Velcro removable back covers
- Replaceable seats
- Use in connected layouts at no upcharge
- Arms replaceable in the field
- Ships assembled as 1, 2 or 3 seaters
- Ships 1/carton 28 cu ft (2 seater),  
1/carton 42 cu ft (3 seater)

## Options

- Polyurethane arms available in Black, Sterling Grey or Taupe (RAL 7006)
- Wood arms in Natural Maple are available in any of 7 standard stains or stain-to-match at no up charge
- Connected and freestanding tables
- Antibacterial and antimicrobial fabrics available
- Different fabric on seat and back at no upcharge
- CAL 133

Contact Spec Customer Service to railroad fabrics (specify repeat info and yardage requirement will be provided) and for repeats greater than 5" x 5"



## Two Seater with half arms

COM 3.0 yds  
0.5 yd COM per single seat  
1.0 yd COM per single back

MODEL	COM	GR 1	GR 2	GR 3	GR 4	GR 5	GR 6
<b>3212U</b>	<b>1608</b>	<b>1812</b>	<b>1879</b>	<b>2018</b>	<b>2221</b>	<b>2377</b>	<b>2580</b>

Dimensions (inches)

seat H	18.0	seat W	20.5	arm H	26.0
total H	36.0	total W	45.5	depth	26.0

Exceeds BIFMA Seating Durability Test to 750 lbs per two seater  
CAL 133, add \$220 List per two seater



**3212U**  
68 lbs

## Three Seater with half arms

COM 4.5 yds  
0.5 yd COM per single seat  
1.0 yd COM per single back

MODEL	COM	GR 1	GR 2	GR 3	GR 4	GR 5	GR 6
<b>3213U</b>	<b>2235</b>	<b>2540</b>	<b>2644</b>	<b>2847</b>	<b>3154</b>	<b>3386</b>	<b>3691</b>

Dimensions (inches)

seat H	18.0	seat W	20.5	arm H	26.0
total H	36.0	total W	67.25	depth	26.0

Exceeds BIFMA Seating Durability Test to 1000 lbs per two seater  
CAL 133, add \$330 List per three seater



**3213U**  
94 lbs



# MIDWAY Public Seating

Two and Three Seaters with full arms

## Standard Features

- Separate seat and back
- Polyurethane arms or wood arms
- Fully welded 1.25" frame with glides
- Frame in any Spectone color
- Velcro removable back covers
- Replaceable seats
- Use in connected layouts at no upcharge
- Arms replaceable in the field
- Ships assembled as 1, 2 or 3 seaters
- Ships 1/carton 28 cu ft (2 seater),  
1/carton 42 cu ft (3 seater)

## Options

- Polyurethane arms available in Black, Sterling Grey or Taupe (RAL 7006)
- Wood arms in Natural Maple are available in any of 7 standard stains or stain-to-match at no up charge
- Connected and freestanding tables
- Antibacterial and antimicrobial fabrics available
- Different fabric on seat and back at no upcharge
- CAL 133

Contact Spec Customer Service to railroad fabrics (specify repeat info and yardage requirement will be provided) and for repeats greater than 5" x 5"



## Two Seater with full arms

COM 3.0 yds  
0.5 yd COM per single seat  
1.0 yd COM per single back

MODEL	COM	GR 1	GR 2	GR 3	GR 4	GR 5	GR 6
<b>3222U</b>	<b>1659</b>	<b>1863</b>	<b>1931</b>	<b>2069</b>	<b>2273</b>	<b>2428</b>	<b>2632</b>

Dimensions (inches)

seat H	18.0	seat W	20.5	arm H	26.0
total H	36.0	total W	45.5	depth	26.0

Exceeds BIFMA Seating Durability Test to 750 lbs per two seater  
CAL 133, add \$220 List per two seater



**3222U**  
70 lbs

## Three Seater with full arms

COM 4.5 yds  
0.5 yd COM per single seat  
1.0 yd COM per single back

MODEL	COM	GR 1	GR 2	GR 3	GR 4	GR 5	GR 6
<b>3223U</b>	<b>2344</b>	<b>2649</b>	<b>2752</b>	<b>2956</b>	<b>3261</b>	<b>3495</b>	<b>3802</b>

Dimensions (inches)

seat H	18.0	seat W	20.5	arm H	26.0
total H	36.0	total W	67.25	depth	26.0

Exceeds BIFMA Seating Durability Test to 1000 lbs per three seater  
CAL 133, add \$330 List per three seater



**3223U**  
96 lbs





# MIDWAY Public Seating

## Bariatric Single Seater with arms

### Standard Features

- Separate seat and back
- Polyurethane arms or wood arms
- Fully welded 1.25" frame with glides
- Frame in any Spectone color
- Velcro removable back covers
- Replaceable seats
- Use in connected layouts at no upcharge
- Arms replaceable in the field
- Bariatric seating cannot connect to bariatric seating
- Ships assembled as 1, 2 or 3 seaters
- Baratric ships 1/carton 22 cu ft

### Options

- Polyurethane arms available in Black, Sterling Grey or Taupe (RAL 7006)
- Wood arms in Natural Maple are available in any of 7 standard stains or stain-to-match at no up charge
- Connected and freestanding tables
- Antibacterial and antimicrobial fabrics available
- Different fabric on seat and back at no upcharge
- CAL 133

Contact Spec Customer Service to railroad fabrics (specify repeat info and yardage requirement will be provided) and for repeats greater than 5" x 5"



---

### Bariatric Single Seater with arms

---

COM 2.55 yds  
 0.8 yd COM per single seat  
 1.75 yd COM per single back

MODEL	COM	GR 1	GR 2	GR 3	GR 4	GR 5	GR 6
<b>3201G</b>	<b>1091</b>	<b>1232</b>	<b>1280</b>	<b>1372</b>	<b>1513</b>	<b>1621</b>	<b>1762</b>

Dimensions (inches)

seat H	18.0	seat W	30.0	arm H	26.0
total H	36.0	total W	32.0	depth	26.0

Exceeds BIFMA Seating Durability Test to 750 lbs per chair  
 CAL 133, add \$187 List per chair



**3201G**  
39 lbs



# MIDWAY Public Seating

Highback Single Seater with arms  
Ottoman and Headrest

## Standard Features

- Separate seat and back
  - Polyurethane arms or wood arms
  - Fully welded 1.25" frame with glides
  - Frame in any Spectone color
  - Velcro removable back covers
  - Replaceable seats
  - Velcro strap for Headrest is upholstered in the same fabric as the chair back
  - Use in connected layouts at no upcharge
  - Arms replaceable in the field
  - Ships assembled as 1, 2 or 3 seaters
  - Ships 1/carton 19 cu ft
- Ottoman ships 1/carton 5 cu ft

## Options

- Polyurethane arms available in Black, Sterling Grey or Taupe (RAL 7006)
- Wood arms in Natural Maple are available in any of 7 standard stains or stain-to-match at no up charge
- For Flex back add suffix FB and \$166 List.  
*Note: Wall-saving frame is not available when Flex back is specified.*
- Connected and freestanding tables
- Removable headrest with Velcro strap
- Antibacterial and antimicrobial fabrics available
- Different fabric on seat and back at no upcharge
- CAL 133

Contact Spec Customer Service to railroad fabrics (specify repeat info and yardage requirement will be provided) and for repeats greater than 5" x 5"



## Highback Single Seater with arms

COM 1.6 yds  
0.5 yd COM per single seat  
1.1 yds COM per single back

MODEL	COM	GR 1	GR 2	GR 3	GR 4	GR 5	GR 6
<b>3201H</b>	<b>1005</b>	<b>1103</b>	<b>1134</b>	<b>1199</b>	<b>1297</b>	<b>1370</b>	<b>1496</b>

Dimensions (inches)

seat H	18.0	seat W	20.5	arm H	26.0
total H	46.0	total W	23.75	depth	25.0

Exceeds BIFMA Seating Durability Test to 500 lbs per chair  
CAL 133, add \$137 List per chair



**3201H**  
39 lbs

## Ottoman and Headrest

0.5 yd COM per ottoman  
0.5 yd COM per headrest

MODEL	COM	GR 1	GR 2	GR 3	GR 4	GR 5	GR 6
<b>3230F</b>	<b>360</b>	<b>392</b>	<b>404</b>	<b>424</b>	<b>457</b>	<b>481</b>	<b>524</b>
<b>3200HR</b>	<b>77</b>	<b>104</b>	<b>113</b>	<b>132</b>	<b>159</b>	<b>179</b>	<b>210</b>

Ottoman Dimensions (inches)

H	11.5	W	19.25	depth	12.25
---	------	---	-------	-------	-------

CAL 133, add \$38 List per ottoman / \$38 per headrest



**3230F**  
12 lbs



**3200HR**  
1 lbs



# MIDWAY Public Seating

Highback Bariatric Single Seater with arms

## Standard Features

- Separate seat and back
- Polyurethane arms or wood arms
- Fully welded 1.25" frame with glides
- Frame in any Spectone color
- Velcro removable back covers
- Replaceable seats
- Use in connected layouts at no upcharge
- Arms replaceable in the field
- Bariatric seating cannot connect to bariatric seating
- Ships assembled as 1, 2 or 3 seaters
- Baratric Highback ships 1/carton 26 cu ft

## Options

- Polyurethane arms available in Black, Sterling Grey or Taupe (RAL 7006)
- Wood arms in Natural Maple are available in any of 7 standard stains or stain-to-match at no up charge
- Connected and freestanding tables
- Removable headrest with Velcro strap
- Antibacterial and antimicrobial fabrics available
- Different fabric on seat and back at no upcharge
- CAL 133

Contact Spec Customer Service to railroad fabrics (specify repeat info and yardage requirement will be provided) and for repeats greater than 5" x 5"



---

## Highback Bariatric Single Seater with arms

---

COM 3.0 yds  
 0.8 yd COM per single seat  
 2.2 yds COM per single back

MODEL	COM	GR 1	GR 2	GR 3	GR 4	GR 5	GR 6
<b>3201GH</b>	<b>1200</b>	<b>1362</b>	<b>1417</b>	<b>1524</b>	<b>1687</b>	<b>1812</b>	<b>2010</b>

Dimensions (inches)

seat H	18.0	seat W	30.0	arm H	26.0
total H	46.0	total W	32.0	depth	26.0

Exceeds BIFMA Seating Durability Test to 500 lbs per chair  
 CAL 133, add \$199 List per chair

---



**3201GH**  
41 lbs



# MIDWAY Public Seating

Easy Access Hip Single Seater with arms

### Standard Features

- Separate seat and back
- Polyurethane arms or wood arms
- Fully welded 1.25" frame with glides
- Frame in any Spectone color
- 24" seat height, no seat pitch (level)
- Footrest which assists entering/exiting chair
- Velcro removable back covers
- Replaceable seats
- Arms replaceable in the field
- Ships assembled
- Ships 1/carton 19 cu ft

### Options

- Polyurethane arms available in Black, Sterling Grey or Taupe (RAL 7006)
- Wood arms in Natural Maple are available in any of 7 standard stains or stain-to-match at no up charge
- Antibacterial and antimicrobial fabrics available
- Different fabric on seat and back at no upcharge
- CAL 133

Contact Spec Customer Service to railroad fabrics (specify repeat info and yardage requirement will be provided) and for repeats greater than 5" x 5"



### Easy Access Hip Single Seater with arms

COM 1.5 yds  
 0.5 yd COM per single seat  
 1.0 yd COM per single back

MODEL	COM	GR 1	GR 2	GR 3	GR 4	GR 5	GR 6
<b>3231</b>	<b>995</b>	<b>1098</b>	<b>1132</b>	<b>1197</b>	<b>1302</b>	<b>1379</b>	<b>1481</b>

Dimensions (inches)

seat H	24.0	seat W	20.5	arm H	32.0
total H	42.0	total W	23.75	depth	26.0

Exceeds BIFMA Seating Durability Test to 500 lbs per chair  
 CAL 133, add \$110 List per chair



**3231**  
40 lbs

## MIDWAY Public Seating

### Freestanding Lounge Tables

### Corner and Spacer Connecting Tables

#### Standard Features

- Tops in laminate or veneer
- Laminate tops in any standard Arborite, Formica, Nevamar, Pionite or Wilsonart matte finish
- Freestanding lounge tables available with PVC, 2mm Bio or Hardwood(HB) Edge
- Connecting table tops with PVC or hardwood(HB) edge
- Veneers in Cherry, Mahogany, Maple, Oak, Chocolate, Pecan and Walnut
- Select from 7 standard stains or stain-to-match at no upcharge
- Fully welded frame with 1.25" steel legs
- Frame in any Spectone color
- Tops utilize Nu Green earth friendly core
- Glides
- 18" height

#### Options

- Non-standard laminates, contact Spec for pricing
- Custom size spacer tables for restricted spaces
- Other sizes may be available

*Radius Corner Tables are recommended for open areas*

#### Freestanding Lounge Tables

Model	Laminate PVC/Self/2mm	Laminate HB Edge	Veneer HB Edge	Weight	Cu.Ft.
32 - 24 x 24 SQ	<b>624</b>	<b>803</b>	<b>944</b>	28	7.2
32 - 24 x 48 RE	<b>772</b>	<b>968</b>	<b>1167</b>	48	18
32 - 30 x 30 SQ	<b>722</b>	<b>852</b>	<b>1004</b>	43	13.5
32 - 24 DIA	<b>596</b>	<b>925</b>	<b>1112</b>	26	7.2
32 - 30 DIA	<b>691</b>	<b>1015</b>	<b>1207</b>	40	13.5



#### Corner and Spacer Connecting Tables

Model	Laminate PVC/Self Edge	Weight	Cu.Ft.
32RC - 26 x 26 <i>Radius Corner Table</i>	<b>644</b>	26	2
32SC - 26 x 26 <i>Square Corner Table</i>	<b>644</b>	26	2
32TC45 - 19 x 23 <i>45 degree Corner Table</i>	<b>644</b>	19	2
32ST - 19 x 21 <i>Spacer or End Table</i>	<b>496</b>	19	2

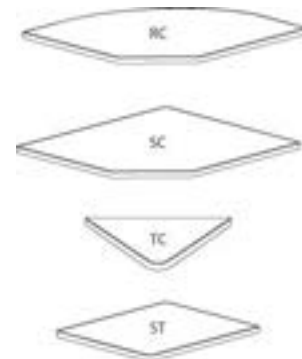



# PHLEBOTOMY



PLACING AN ORDER IS EASY

## PRODUCT CODE

**18 04 - PH-W20**

**Series**

- 180 : Snowball 1
- 185 : Snowball 2
- 190 : Snowball 3

**Seat Size**

- 4 : Midsize
- 3 : Bariatric

**Phlebotomy**



## OPTIONS

### SERIES OPTIONS (Back Style)



Snowball 1



Snowball 2



Snowball 3

## FINISHES

### FRAME



Select from one of our 76 standard Spectone colors

### FABRIC



Select fabrics from one of our textile partners

### ARMS

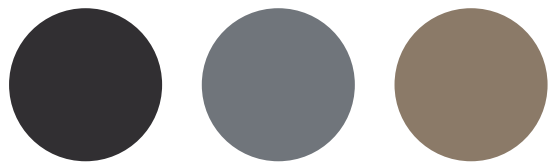

Black

Sterling Grey

Taupe



# SPECIALTY HEALTHCARE SEATING – Phlebotomy

Designed for today's healthcare facilities

## Standard Features

- 20" seat height
- 4-point wall-saving frame
- Separate seat and back
- Includes fixed arms for patient safety
- Height adjustable arms can be individually adjusted with a quick release mechanism
- Arm pads are field-replaceable

## Options

- Specify different fabric on seats and backs at no upcharge
- Frame can be finished in any one of our 76 Spectone Colors
- CAL 133 available

Contact Spec Customer Service to railroad fabrics (specify repeat info and yardage requirement will be provided) and for repeats greater than 5" x 5"

## Snowball 1 Phlebotomy - Midsize

COM 2 yds  
1.0 yd COM per single seat  
1.0 yd COM per single back

### 1804-PH-W20

COM	GR 1	GR 2	GR 3	GR 4	GR 5	GR 6
<b>1031</b>	<b>1142</b>	<b>1180</b>	<b>1254</b>	<b>1367</b>	<b>1454</b>	<b>1565</b>

Dimensions (inches)

seat H	20.0	seat W	22.0	arm H	26-35
total H	33.0	total W	36.5	depth	26.75

Exceeds BIFMA Seating Durability Test to 500 lbs per seat  
CAL 133, add \$82 List per seat



**1804-PH-W20**  
28 Lbs.  
16 Cu. Ft.

## Snowball 1 Phlebotomy - Bariatric

COM 2.5 yds  
1.25 yd COM per single seat  
1.25 yd COM per single back

### 1803-PH-W20

COM	GR 1	GR 2	GR 3	GR 4	GR 5	GR 6
<b>1113</b>	<b>1225</b>	<b>1262</b>	<b>1336</b>	<b>1449</b>	<b>1536</b>	<b>1647</b>

Dimensions (inches)

seat H	20.0	seat W	26.0	arm H	26-35
total H	33.0	total W	40.5	depth	26.75

Exceeds BIFMA Seating Durability Test to 500 lbs per seat  
CAL 133, add \$82 List per seat



**1803-PH-W20**  
33 Lbs.  
21 Cu. Ft.



# SPECIALTY HEALTHCARE SEATING – Phlebotomy

Designed for today's healthcare facilities

## Standard Features

- 20" seat height
- 4-point wall-saving frame
- Separate seat and back
- Includes fixed arms for patient safety
- Height adjustable arms can be individually adjusted with a quick release mechanism
- Arm pads are field-replaceable

## Options

- Specify different fabric on seats and backs at no upcharge
- Frame can be finished in any one of our 76 Spectone Colors
- CAL 133 available

Contact Spec Customer Service to railroad fabrics (specify repeat info and yardage requirement will be provided) and for repeats greater than 5" x 5"

## Snowball 2 Phlebotomy - Midsize

COM 2 yds  
1.0 yd COM per single seat  
1.0 yd COM per single back

### 1854-PH-W20

COM	GR 1	GR 2	GR 3	GR 4	GR 5	GR 6
1062	1176	1215	1290	1407	1494	1608

Dimensions (inches)

seat H	20.0	seat W	22.0	arm H	26-35
total H	33.0	total W	36.5	depth	26.75

Exceeds BIFMA Seating Durability Test to 500 lbs per seat  
CAL 133, add \$82 List per seat



**1854-PH-W20**  
28 Lbs.  
16 Cu. Ft.

## Snowball 2 Phlebotomy - Bariatric

COM 2.5 yds  
1.25 yd COM per single seat  
1.25 yd COM per single back

### 1853-PH-W20

COM	GR 1	GR 2	GR 3	GR 4	GR 5	GR 6
1143	1257	1297	1372	1488	1576	1689

Dimensions (inches)

seat H	20.0	seat W	26.0	arm H	26-35
total H	33.0	total W	40.5	depth	26.75

Exceeds BIFMA Seating Durability Test to 500 lbs per seat  
CAL 133, add \$82 List per seat



**1853-PH-W20**  
33 Lbs.  
21 Cu. Ft.





# SPECIALTY HEALTHCARE SEATING – Phlebotomy

Designed for today's healthcare facilities

## Standard Features

- 20" seat height
- 4-point wall-saving frame
- Separate seat and back
- Includes fixed arms for patient safety
- Height adjustable arms can be individually adjusted with a quick release mechanism
- Arm pads are field-replaceable

## Options

- Wood back available in 5 standard cut-outs
- Custom back cut-outs and engravings are available
- Wood back standard in maple with 7 standard stains or stain-to-match at no upcharge
- Specify different fabric on seats and backs at no upcharge
- Frame can be finished in any one of our 76 Spectone Colors
- CAL 133 available

Contact Spec Customer Service to railroad fabrics (specify repeat info and yardage requirement will be provided) and for repeats greater than 5" x 5"

## Snowball 3 Phlebotomy - Midsize

COM 2 yds  
1.0 yd COM per single seat  
1.0 yd COM per single back

### 1904-PH-W20

COM	GR 1	GR 2	GR 3	GR 4	GR 5	GR 6
<b>1108</b>	<b>1168</b>	<b>1188</b>	<b>1228</b>	<b>1288</b>	<b>1335</b>	<b>1394</b>

Dimensions (inches)

seat H	20.0	seat W	22.0	arm H	26-35
total H	33.0	total W	36.5	depth	26.75

Exceeds BIFMA Seating Durability Test to 500 lbs per seat  
CAL 133, add \$41 List per seat



**1904-PH-W20**  
28 Lbs.  
16 Cu. Ft.

## Snowball 3 Phlebotomy - Bariatric

COM 2.5 yds  
1.25 yd COM per single seat  
1.25 yd COM per single back

### 1903-PH-W20

COM	GR 1	GR 2	GR 3	GR 4	GR 5	GR 6
<b>1158</b>	<b>1217</b>	<b>1237</b>	<b>1277</b>	<b>1338</b>	<b>1384</b>	<b>1444</b>

Dimensions (inches)

seat H	20.0	seat W	26.0	arm H	26-35
total H	33.0	total W	40.5	depth	26.75

Exceeds BIFMA Seating Durability Test to 500 lbs per seat  
CAL 133, add \$41 List per seat



**1903-PH-W20**  
33 Lbs.  
21 Cu. Ft.



# SNOWBALL 1

BACK TO CONTENTS



PLACING AN ORDER IS EASY

## PRODUCT CODE

**18 01**

### Series

18 : Snowball 1

### Chair Type

- |                         |                          |                        |                     |
|-------------------------|--------------------------|------------------------|---------------------|
| 01 : Four Point/Arms    | 14 : 22"/4-Point/No Arms | 21 : Stool/Arms        | 24E : 22" Hip Chair |
| 11 : Four Point/No Arms | 03 : 26"/4-Point/Arms    | 25 : Stool/No Arms     |                     |
| 31 : Sled Base/Arms     | 44 : 22"/Sled/No Arms    | 24 : 22"/Stool/Arms    |                     |
| 41 : Sled Base/No Arms  | 43 : 26"/Sled/No Arms    | 26 : 22"/Stool/No Arms |                     |
| 04 : 22"/4-point/Arms   | 02 : Casters/Arms        | 21E : Hip Chair        |                     |



## OPTIONS

### WALL-SAVING



## FINISHES

### FRAME



Select from one of our 76 standard Spectone colors

### FABRIC



Select fabrics from one of our textile partners

### ARMS

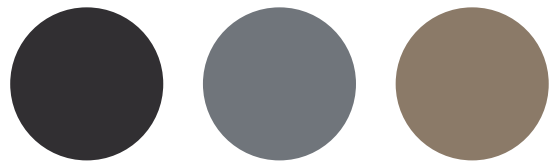

Black

Sterling Grey

Taupe

For exact specifications, see specification sheet.



# Snowball 1

## Four-point and Sled Base

### Standard Features

- 0.875" frame
- Seat and back upholstered
- Frame in any Spectone color
- Four-point stacks 10 high with dolly, 6 without dolly
- Sled Base does not stack and ships 1 per carton
- Ships 1/carton 11 cu ft, 2-4/carton 22 cu ft

Contact Spec Customer Service to railroad fabrics (specify repeat info and yardage requirement will be provided) and for repeats greater than 5" x 5"



Available on Spec 10 Day Program

### Options

- Wall-saving frame on Four-point only, add \$20 List, not available on 10 Day
- Polyurethane arms available in Black (B), Sterling Grey (G) or Taupe RAL 7006 (T)
- Connecting clips for ganging chairs, add \$8 List/set
- Connecting bars for a structured reconfigurable layout, add \$80 List
- Antibacterial and antimicrobial fabrics available
- Different fabric on seat and back at no upcharge
- Tablet Arm available on Snowballs without arms
- CAL 133
- Other glides may be available for an upcharge - call Customer Service to inquire

Optional wall-saving Frame



### Snowball 1 – Four-point

COM 1.0 yd  
0.5 yd COM per single seat  
0.5 yd COM per single back

MODEL	COM	GR 1	GR 2	GR 3	GR 4	GR 5	GR 6
1801	311	357	372	406	452	488	533
1811	311	357	372	406	452	488	533

Dimensions (inches)

seat H	18.0	seat W	18.0	arm H	26.0	total H	33.0
depth	21.5	total W	23.5	total W (no arms)	20.1		

Exceeds BIFMA Seating Durability Test to 500 lbs  
CAL 133, add \$58 List  
1" extra seat foam, specify and add \$14 List



1801  
With arms  
16 lbs



1811  
Without arms  
15 lbs

### Snowball 1 – Sled Base

COM 1.0 yd  
0.5 yd COM per single seat  
0.5 yd COM per single back

MODEL	COM	GR 1	GR 2	GR 3	GR 4	GR 5	GR 6
1831	325	371	387	418	465	501	549
1841	325	371	387	418	465	501	549

Dimensions (inches)

seat H	18.0	seat W	18.0	arm H	26.0	total H	33.0
depth	21.5	total W	23.5	total W (no arms)	20.1		

Exceeds BIFMA Seating Durability Test to 500 lbs  
CAL 133, add \$58 List  
1" extra seat foam, specify and add \$14 List



1831  
With arms  
18 lbs



1841  
Without arms  
17 lbs

For exact specifications, see specification sheet.



# Snowball 1

Midsize and Bariatric – Four-point

## Standard Features

- 0.875" frame
- Seat and back upholstered
- Frame in any Spectone color
- Four-point stacks 4 high on floor or with dolly
- Ships 1-3/carton 21.24 cu ft for Midsize and 1-3/carton 24.17 cu ft for Bariatric

Contact Spec Customer Service to railroad fabrics (specify repeat info and yardage requirement will be provided) and for repeats greater than 5" x 5"



Available on Spec 10 Day Program

## Options

- Wall-saving frame, add \$20 List, not available on 10 Day
- Polyurethane arms available in Black (B), Sterling Grey (G) or Taupe RAL 7006 (T)
- Connecting clips for ganging chairs, \$8 List/set
- Connecting bars for a structured reconfigurable layout, add \$80 List
- Antibacterial and antimicrobial fabrics available
- Different fabric on seat and back at no upcharge
- CAL 133
- Other glides may be available for an upcharge - call Customer Service to inquire

Optional wall-saving Frame



## Snowball 1 – Midsize – Four-point

COM 1.5 yd  
0.75 yd COM per single seat  
0.75 yd COM per single back

MODEL	COM	GR 1	GR 2	GR 3	GR 4	GR 5	GR 6
<b>1804</b>	<b>425</b>	<b>519</b>	<b>551</b>	<b>612</b>	<b>706</b>	<b>777</b>	<b>871</b>
<b>1814</b>	<b>425</b>	<b>519</b>	<b>551</b>	<b>612</b>	<b>706</b>	<b>777</b>	<b>871</b>

\*1814 Not Available on 10 Day Program

Dimensions (inches)

seat H	18.0	seat W	22.0	arm H	26.0	total H	33.0
depth	22.0	total W	26.9	total W (no arms)	24.0		

Exceeds BIFMA Seating Durability Test to 500 lbs  
CAL 133, add \$82 List  
1" extra seat foam, specify and add \$21 List



**1804**  
With arms  
18 lbs

**1814**  
Without arms  
17 lbs

\*Not Available on 10 Day Program

## Snowball 1 – Bariatric – Four-point

COM 2.0 yd  
1.0 yd COM per single seat  
1.0 yd COM per single back

MODEL	COM	GR 1	GR 2	GR 3	GR 4	GR 5	GR 6
<b>1803</b>	<b>499</b>	<b>592</b>	<b>623</b>	<b>684</b>	<b>779</b>	<b>850</b>	<b>944</b>

Dimensions (inches)

seat H	18.0	seat W	26.0	arm H	26.0
total H	33.0	total W	31.0	depth	22.0

Exceeds BIFMA Seating Durability Test to 500 lbs  
CAL 133, add \$82 List  
1" extra seat foam, specify and add \$30 List



**1803**  
With arms  
23 lbs

For exact specifications, see specification sheet.



# Snowball 1

Midsize and Bariatric – Sled Base

## Standard Features

- 0.875" frame
- Seat and back upholstered
- Frame in any Spectone color
- Does not stack
- Ships 1/carton 21 cu ft

Contact Spec Customer Service to railroad fabrics (specify repeat info and yardage requirement will be provided) and for repeats greater than 5" x 5"

## Options

- Connecting clips for ganging chairs, \$8 List/set
- Connecting bars for a structured reconfigurable layout, add \$80 List
- Antibacterial and antimicrobial fabrics available
- Different fabric on seat and back at no upcharge
- Tablet Arm available on Snowballs without arms
- CAL 133
- Other glides may be available for an upcharge - call Customer Service to inquire

---

## Snowball 1 – Midsize – Sled Base

COM 1.5 yd  
0.75 yd COM per single seat  
0.75 yd COM per single back

MODEL	COM	GR 1	GR 2	GR 3	GR 4	GR 5	GR 6
<b>1844</b>	<b>459</b>	<b>553</b>	<b>583</b>	<b>645</b>	<b>738</b>	<b>811</b>	<b>904</b>

Dimensions (inches)  
seat H 18.0    seat W 22.0    arm H N/A  
total H 33.0    total W 24.0    depth 22.0

Exceeds BIFMA Seating Durability Test to 500 lbs  
CAL 133, add \$82 List  
1" extra seat foam, specify and add \$21 List



**1844**  
Without arms  
20 lbs

---

## Snowball 1 – Bariatric – Sled Base

COM 2.0 yd  
1.0 yd COM per single seat  
1.0 yd COM per single back

MODEL	COM	GR 1	GR 2	GR 3	GR 4	GR 5	GR 6
<b>1843</b>	<b>531</b>	<b>625</b>	<b>657</b>	<b>718</b>	<b>813</b>	<b>883</b>	<b>977</b>

Dimensions (inches)  
seat H 18.0    seat W 26.0    arm H N/A  
total H 33.0    total W 28.0    depth 22.0

Exceeds BIFMA Seating Durability Test to 500 lbs  
CAL 133, add \$82 List  
1" extra seat foam, specify and add \$30 List



**1843**  
Without arms  
25 lbs

For exact specifications, see specification sheet.



# Snowball 1

## Casters

### Standard Features

- 0.875" frame
- Seat and back upholstered
- Frame in any Spectone color
- Black non-locking casters
- Four-point stacks 10 high with dolly, 6 without dolly
- Ships 1/carton 11 cu ft, 2-3/carton 22 cu ft

### Options

- Polyurethane arms available in Black (B), Sterling Grey (G) or Taupe RAL 7006 (T)
- Antibacterial and antimicrobial fabrics available
- Different fabric on seat and back at no upcharge
- Armless and sled base versions not available
- CAL 133

Contact Spec Customer Service to railroad fabrics (specify repeat info and yardage requirement will be provided) and for repeats greater than 5" x 5"

---

### Snowball 1 – Casters

COM 1.0 yd  
 0.5 yd COM per single seat  
 0.5 yd COM per single back

MODEL	COM	GR 1	GR 2	GR 3	GR 4	GR 5	GR 6
<b>1802</b>	<b>429</b>	<b>476</b>	<b>492</b>	<b>524</b>	<b>570</b>	<b>606</b>	<b>655</b>

Dimensions (inches)

seat H	18.0	seat W	18.0	arm H	26.0
total H	33.0	total W	23.5	depth	21.5

Exceeds BIFMA Seating Durability Test to 500 lbs  
 CAL 133, add \$58 List  
 1" extra seat foam, specify and add \$14 List



**1802**  
**With arms**  
 17 lbs

For exact specifications, see specification sheet.



# Snowball 1

## Stools

### Standard Features

- 0.875" frame
- Seat and back upholstered
- Frame in any Spectone color
- Does not stack
- Ships 1/carton 17 cu ft

Contact Spec Customer Service to railroad fabrics (specify repeat info and yardage requirement will be provided) and for repeats greater than 5" x 5"

### Options

- Polyurethane arms available in Black (B), Sterling Grey (G) or Taupe RAL 7006 (T)
- Connecting clips for ganging chairs, add \$8 List/set
- Antibacterial and antimicrobial fabrics available
- Different fabric on seat and back at no upcharge
- Casters, sled base not available
- CAL 133
- Other glides may be available for an upcharge - call Customer Service to inquire

### Snowball 1 – Stools

COM 1.0 yd  
0.5 yd COM per single seat  
0.5 yd COM per single back

MODEL	COM	GR 1	GR 2	GR 3	GR 4	GR 5	GR 6
<b>1821</b>	<b>417</b>	<b>465</b>	<b>479</b>	<b>512</b>	<b>558</b>	<b>593</b>	<b>641</b>
<b>1825</b>	<b>417</b>	<b>465</b>	<b>479</b>	<b>512</b>	<b>558</b>	<b>593</b>	<b>641</b>

Dimensions (inches)

	seat H	28.0	seat W	18.0	arm H	36.0	total H	43.5
depth	21.5	total W	23.5	total W (no arms)	20.1			

Exceeds BIFMA Seating Durability Test to 500 lbs  
CAL 133, add \$58 List  
1" extra seat foam, specify and add \$14 List



**1821**  
With arms  
21 lbs



**1825**  
Without arms  
20 lbs

### Snowball 1 – Midsize Stools

COM 1.5 yd  
0.75 yd COM per single seat  
0.75 yd COM per single back

MODEL	COM	GR 1	GR 2	GR 3	GR 4	GR 5	GR 6
<b>1824</b>	<b>567</b>	<b>661</b>	<b>693</b>	<b>754</b>	<b>848</b>	<b>919</b>	<b>1013</b>
<b>1826</b>	<b>567</b>	<b>661</b>	<b>693</b>	<b>754</b>	<b>848</b>	<b>919</b>	<b>1013</b>

Dimensions (inches)

	seat H	28.0	seat W	22.0	arm H	36.0	total H	43.5
depth	22.0	total W	26.9	total W (no arms)	24.0			

Exceeds BIFMA Seating Durability Test to 500 lbs  
CAL 133, add \$82 List  
1" extra seat foam, specify and add \$21 List



**1824**  
With arms  
23 lbs



**1826**  
Without arms  
22 lbs

For exact specifications, see specification sheet.



# Snowball 1

## Easy Access Hip Single Seater

### Standard Features

- 0.875" frame
- Seat and back upholstered
- Frame in any Spectone color
- Does not stack
- Ships 1/carton 19 cu ft

Contact Spec Customer Service to railroad fabrics (specify repeat info and yardage requirement will be provided) and for repeats greater than 5" x 5"

### Options

- Polyurethane arms available in Black (B), Sterling Grey (G) or Taupe RAL 7006 (T)
- Connecting clips for ganging chairs, add \$8 List/set
- Antibacterial and antimicrobial fabrics available
- Different fabric on seat and back at no upcharge
- Casters, sled base not available
- CAL 133
- Other glides may be available for an upcharge - call Customer Service to inquire

---

### Snowball 1 – Easy Access Hip Single Seater

COM 1.0 yd  
0.5 yd COM per single seat  
0.5 yd COM per single back

MODEL	COM	GR 1	GR 2	GR 3	GR 4	GR 5	GR 6
<b>1821E</b>	<b>459</b>	<b>507</b>	<b>521</b>	<b>554</b>	<b>600</b>	<b>634</b>	<b>682</b>

Dimensions (inches)  
seat H 24.0 seat W 18.0 arm H 32.0  
total H 38.5 total W 23.5 depth 31.0

Exceeds BIFMA Seating Durability Test to 500 lbs  
CAL 133, add \$58 List  
1" extra seat foam, specify and add \$14 List



**1821E**  
With arms  
21 lbs

---

### Snowball 1 – Midsize Easy Access Hip Single Seater

COM 1.5 yd  
0.75 yd COM per single seat  
0.75 yd COM per single back

MODEL	COM	GR 1	GR 2	GR 3	GR 4	GR 5	GR 6
<b>1824E</b>	<b>614</b>	<b>708</b>	<b>740</b>	<b>801</b>	<b>895</b>	<b>966</b>	<b>1060</b>

Dimensions (inches)  
seat H 24.0 seat W 22.0 arm H 32.0  
total H 38.5 total W 26.875 depth 31.0

Exceeds BIFMA Seating Durability Test to 500 lbs  
CAL 133, add \$82 List  
1" extra seat foam, specify and add \$21 List



**1824E**  
With arms  
23 lbs

For exact specifications, see specification sheet.





# Snowball

## Dolly

### Standard Features

- Black finish only
- 2" black swivel casters
- Standard Dolly stacks 10 chairs
- Midsize Dolly stacks 4 chairs
- Bariatric Dolly stacks 4 chairs
- Ships 1/carton 17 cu ft

### Options

- Please specify if dolly is for chairs with wall-saving frame



Available on Spec 10 Day Program

### Snowball 1 – Dolly



DESCRIPTION	MODEL	PRICE
<b>Standard</b>	<b>1899</b>	<b>343</b>
<b>22" Midsize</b>	<b>1899M</b>	<b>491</b>
<b>26" Bariatric</b>	<b>1899G</b>	<b>491</b>

#### Dimensions (inches)

Standard		Midsize / Bariatric	
height	36.5	height	36.5
width	21.0	width	23.0
depth	31.0	depth	42.0



**1899  
Standard**  
18 lbs



**1899 G&M  
Midsize & Bariatric**  
24 lbs

For exact specifications, see specification sheet.



# Snowball 1

## Connected and Tables

### To order connected Snowballs

- Select and price the Snowballs required for your configuration
- Select and price the corner, spacer and end tables required
- Add Snowball connecting bars (between chairs only)
- Do not add connecting bars for tables (they are part of the table)
- For quick takedown or reconfiguration, use connecting clips (\$8 List/set) on chairs rather than connecting bars
- Send a drawing with your order or call Spec for assistance

*Connecting bars and tables can be retrofitted, allowing you to change configurations later or create new configurations from your present Snowballs*

*Connecting bars can be added to any Snowball chair, including Bariatric and Midsize*

*Connecting bars and table frame bars are finished in the same color as the color of the chair frames*

*Connecting bars are fastened to the underside of the Snowball chair frame at the front and back*



### Snowball Tables

- Table top is 3/4" thick
- Self Edge, 2MM Bio or PVC (flat only). 2MM Bio and PVC edge have a choice of 38 colors to match frame color
- Laminate tops available in any Arborite, Formica, Nevamar, Pionite or Wilsonart standard finish



## Snowball 1 – Connected and Tables



DESCRIPTION	Corner Table	Spacer Table	Mini Spacer Table	End Table*	Connecting Bars
MODEL	18RC	18ST	18MT	18ET	18CON
DIMENSIONS (inches)	25 x 25	17 x 17	4.5 x 14.5	17 x 17	N/A
PRICE	<b>330</b>	<b>226</b>	<b>135</b>	<b>235</b>	<b>80</b>

\*End table is handed, provide layout

For exact specifications, see specification sheet.



# Snowball

## Tablet Arms and Wire Basket

### Tablet Arm

- Fits any Snowball, freestanding or within a configuration
- Standard or laptop size available
- Right and left handed versions (defined when sitting in chair), add TR for right handed or TL for left handed to model number
- Laminated on both sides, standard in Wilsonart Dove Grey D-92-60 with flat black PVC edge.  
For other laminate please contact the factory for pricing
- Tablet constructed of 3/4" Nu Green core
- Snowball with Tablet Arm is standard with no arm on opposite side
- Add price of Tablet Arm to your Snowball selection

### Wire Basket

- Add to any 18" wide Snowball
- Black
- Removable



**Note: We do not recommend stacking Snowballs that have tablet arms**

## Snowball 1 – Tablet Arms and Wire Basket



DESCRIPTION	Standard Tablet Arm	Laptop Tablet Arm	Wire Basket
MODEL	TR (right) or TL (left)	LTR (right) or LTL (left)	WB
PRICE	<b>231</b>	<b>260</b>	<b>57</b>
Dimensions (inches)	height 27.5 width 12.75 total W 24.5 length 24.0 tablet extends 6" from seat	height 27.5 width 16.0 total W 24.5 length 24.75 tablet extends 7" from seat	

For exact specifications, see specification sheet.



# Snowball 1

## 10 Day Program

### Standard Features

- Black polyurethane arms
- Nickel or black textured frame finish
- A selection of fabrics and vinyls can be seen on our website at Seating/10 Day Program/Snowball/10 Day Fabrics Available

### Options

- Connecting clips for ganging chairs, add \$8 List/set
- Snowball Dolly, stacks regular width four-point Snowballs up to 10 high, Midsize and Bariatric Snowballs up to 4 high

For information on the 10 Day Program guarantee and terms and conditions, visit our website and go to Seating/10 Day Program/Snowball/Terms & Conditions

### Snowball 1 – 10 Day Program

COM 1.0 yd  
0.5 yd COM per single seat  
0.5 yd COM per single back

MODEL	COM	GR 1	GR 2	GR 3	GR 4	GR 5	GR 6
1801	311	357	372	406	452	488	533
1811	311	357	372	406	452	488	533
1831	325	371	387	418	465	501	549
1841	325	371	387	418	465	501	549

COM 1.5 yd  
0.75 yd COM per single seat  
0.75 yd COM per single back

MODEL	COM	GR 1	GR 2	GR 3	GR 4	GR 5	GR 6
1804	425	519	551	612	706	777	871

COM 2.0 yd  
1.0 yd COM per single seat  
1.0 yd COM per single back

MODEL	COM	GR 1	GR 2	GR 3	GR 4	GR 5	GR 6
1803	499	592	623	684	779	850	944

Dolly

MODEL	COM
1899	343
1899M	491
1899G	491



1801  
With arms  
16 lbs



1811  
Without arms  
15 lbs



1831  
With arms  
18 lbs



1841  
Without arms  
17 lbs



1899  
Standard  
18 lbs



1899 G&M  
Midsize & Bariatric  
24 lbs



With arms  
18 lbs



With arms  
23 lbs

For exact specifications, see specification sheet.



# SNOWBALL 2



PLACING AN ORDER IS EASY

## PRODUCT CODE

18 51

### Series

18 : Snowball 2

### Chair Type

- 51 : Four Point/Arms
- 61 : Four Point/No Arms
- 81 : Sled Base/Arms
- 91 : Sled Base/No Arms
- 54 : 22"/4-point/Arms
- 64 : 22"/4-Point/No Arms
- 53 : 26"/4-Point/Arms
- 94 : 22"/Sled/No Arms
- 93 : 26"/Sled/No Arms
- 52 : Casters/Arms
- 71 : Stool/Arms
- 75 : Stool/No Arms
- 74 : 22"/Stool/Arms
- 76 : 22"/Stool/No Arms
- 71E : Hip Chair
- 74E : 22" Hip Chair



## OPTIONS

### WALL-SAVING



## FINISHES

### FRAME



Select from one of our 76 standard Spectone colors

### FABRIC



Select fabrics from one of our textile partners

### ARMS

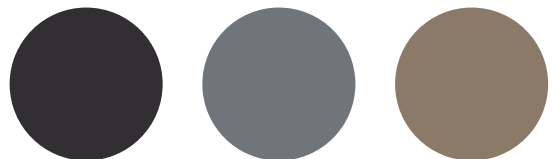

Black

Sterling Grey

Taupe

For exact specifications, see specification sheet.

Toll Free: 1-888-761-7732



# Snowball 2

## Four-point and Sled Base

### Standard Features

- 0.875" frame
- Seat and back upholstered
- Back has enhanced contours for superior comfort
- Frame in any Spectone color
- Four-point stacks 10 high with dolly, 6 without dolly
- Sled Base does not stack and ships 1 per carton
- Ships 1/carton 11 cu ft, 2-4/carton 22 cu ft

Contact Spec Customer Service to railroad fabrics (specify repeat info and yardage requirement will be provided) and for repeats greater than 5" x 5"



Available on Spec 10 Day Program

### Options

- Wall-saving frame on Four-point only, add \$20 List, not available on 10 Day
- Polyurethane arms available in Black (B), Sterling Grey (G) or Taupe RAL 7006 (T)
- Connecting clips for ganging chairs, add \$8 List/set
- Connecting bars for a structured reconfigurable layout, add \$80 List
- Antibacterial and antimicrobial fabrics available
- Different fabric on seat and back at no upcharge
- Tablet Arm available on Snowballs without arms
- CAL 133
- Other glides may be available for an upcharge - call Customer Service to inquire

Optional wall-saving Frame



### Snowball 2 – Four-point

COM 1.0 yd  
0.5 yd COM per single seat  
0.5 yd COM per single back

MODEL	COM	GR 1	GR 2	GR 3	GR 4	GR 5	GR 6
1851	330	384	401	435	488	527	579
1861	330	384	401	435	488	527	579

Dimensions (inches)  
seat H 18.0 seat W 18.0 arm H 26.0 total H 33.0  
depth 21.5 total W 23.5 total W (no arms) 20.1

Exceeds BIFMA Seating Durability Test to 500 lbs  
CAL 133, add \$58 List  
1" extra seat foam, specify and add \$14 List



1851  
With arms  
16 lbs



1861  
Without arms  
15 lbs

### Snowball 2 – Sled Base

COM 1.0 yd  
0.5 yd COM per single seat  
0.5 yd COM per single back

MODEL	COM	GR 1	GR 2	GR 3	GR 4	GR 5	GR 6
1881	346	397	414	449	501	540	592
1891	346	397	414	449	501	540	592

Dimensions (inches)  
seat H 18.0 seat W 18.0 arm H 26.0 total H 33.0  
depth 21.5 total W 23.5 total W (no arms) 20.1

Exceeds BIFMA Seating Durability Test to 500 lbs  
CAL 133, add \$58 List  
1" extra seat foam, specify and add \$14 List



1881  
With arms  
18 lbs



1891  
Without arms  
17 lbs

For exact specifications, see specification sheet.

Toll Free: 1-888-761-7732

# Snowball 2

Midsize and Bariatric – Four-point

### Standard Features

- 0.875" frame
- Seat and back upholstered
- Back has enhanced contours for superior comfort
- Frame in any Spectone color
- Four-point stacks 4 high on floor or with dolly
- Ships 1-3/carton 21.24 cu ft for Midsize and 1-3/carton 24.17 cu ft for Bariatric

Contact Spec Customer Service to railroad fabrics (specify repeat info and yardage requirement will be provided) and for repeats greater than 5" x 5"

### Options

- Wall-saving frame, add \$20 List, not available on 10 Day
- Polyurethane arms available in Black (B), Sterling Grey (G) or Taupe RAL 7006 (T)
- Connecting clips for ganging chairs, \$8 List/set
- Connecting bars for a structured reconfigurable layout, add \$80 List
- Antibacterial and antimicrobial fabrics available
- Different fabric on seat and back at no upcharge
- CAL 133
- Other glides may be available for an upcharge - call Customer Service to inquire



Available on Spec 10 Day Program

Optional wall-saving Frame



## Snowball 2 – Midsize – Four-point

COM 1.5 yd  
0.75 yd COM per single seat  
0.75 yd COM per single back

MODEL	COM	GR 1	GR 2	GR 3	GR 4	GR 5	GR 6
<b>1854</b>	<b>456</b>	<b>553</b>	<b>584</b>	<b>647</b>	<b>745</b>	<b>819</b>	<b>915</b>
<b>1864</b>	<b>456</b>	<b>553</b>	<b>584</b>	<b>647</b>	<b>745</b>	<b>819</b>	<b>915</b>

\*1864 Not Available on 10 Day Program

Dimensions (inches)

seat H	18.0	seat W	22.0	arm H	26.0	total H	33.0
depth	22.0	total W	26.9	total W (no arms)	24.0		

Exceeds BIFMA Seating Durability Test to 500 lbs  
CAL 133, add \$82 List  
1" extra seat foam, specify and add \$21 List



**1854**  
With arms  
18 lbs



**1864**  
Without arms  
17 lbs

\*Not Available on 10 Day Program

## Snowball 2 – Bariatric – Four-point

COM 2.0 yd  
1.0 yd COM per single seat  
1.0 yd COM per single back

MODEL	COM	GR 1	GR 2	GR 3	GR 4	GR 5	GR 6
<b>1853</b>	<b>529</b>	<b>625</b>	<b>659</b>	<b>721</b>	<b>819</b>	<b>890</b>	<b>988</b>

Dimensions (inches)

seat H	18.0	seat W	26.0	arm H	26.0
total H	33.0	total W	31.0	depth	22.0

Exceeds BIFMA Seating Durability Test to 500 lbs  
CAL 133, add \$82 List  
1" extra seat foam, specify and add \$30 List



**1853**  
With arms  
23 lbs



# Snowball 2

Midsize and Bariatric – Sled Base

## Standard Features

- 0.875" frame
- Seat and back upholstered
- Back has enhanced contours for superior comfort
- Frame in any Spectone color
- Does not stack
- Ships 1/carton 21 cu ft

Contact Spec Customer Service to railroad fabrics (specify repeat info and yardage requirement will be provided) and for repeats greater than 5" x 5"

## Options

- Connecting clips for ganging chairs, \$8 List/set
- Connecting bars for a structured reconfigurable layout, add \$80 List
- Antibacterial and antimicrobial fabrics available
- Different fabric on seat and back at no upcharge
- Tablet Arm available on Snowballs without arms
- CAL 133
- Other glides may be available for an upcharge - call Customer Service to inquire

---

## Snowball 2 – Midsize – Sled Base

COM 1.5 yd  
 0.75 yd COM per single seat  
 0.75 yd COM per single back

MODEL	COM	GR 1	GR 2	GR 3	GR 4	GR 5	GR 6
<b>1894</b>	<b>489</b>	<b>585</b>	<b>618</b>	<b>680</b>	<b>777</b>	<b>851</b>	<b>948</b>

Dimensions (inches)  
 seat H 18.0    seat W 22.0    arm H N/A  
 total H 33.0    total W 24.0    depth 22.0

Exceeds BIFMA Seating Durability Test to 500 lbs  
 CAL 133, add \$82 List  
 1" extra seat foam, specify and add \$21 List



**1894**  
**Without arms**  
 20 lbs

---

## Snowball 2 – Bariatric – Sled Base

COM 2.0 yd  
 1.0 yd COM per single seat  
 1.0 yd COM per single back

MODEL	COM	GR 1	GR 2	GR 3	GR 4	GR 5	GR 6
<b>1893</b>	<b>563</b>	<b>659</b>	<b>692</b>	<b>755</b>	<b>851</b>	<b>924</b>	<b>1022</b>

Dimensions (inches)  
 seat H 18.0    seat W 26.0    arm H N/A  
 total H 33.0    total W 28.0    depth 22.0

Exceeds BIFMA Seating Durability Test to 500 lbs  
 CAL 133, add \$82 List  
 1" extra seat foam, specify and add \$30 List



**1893**  
**Without arms**  
 25 lbs





# Snowball 2

## Casters

### Standard Features

- 0.875" frame
- Seat and back upholstered
- Back has enhanced contours for superior comfort
- Frame in any Spectone color
- Black non-locking casters
- Four-point stacks 10 high with dolly, 6 without dolly
- Ships 1/carton 11 cu ft, 2-3/carton 22 cu ft

### Options

- Polyurethane arms available in Black (B), Sterling Grey (G) or Taupe RAL 7006 (T)
- Antibacterial and antimicrobial fabrics available
- Different fabric on seat and back at no upcharge
- Armless and sled base versions not available
- CAL 133

Contact Spec Customer Service to railroad fabrics (specify repeat info and yardage requirement will be provided) and for repeats greater than 5" x 5"

---

### Snowball 2 – Casters

COM 1.0 yd  
 0.5 yd COM per single seat  
 0.5 yd COM per single back

MODEL	COM	GR 1	GR 2	GR 3	GR 4	GR 5	GR 6
<b>1852</b>	<b>450</b>	<b>502</b>	<b>519</b>	<b>554</b>	<b>606</b>	<b>645</b>	<b>698</b>

Dimensions (inches)

seat H	18.0	seat W	18.0	arm H	26.0
total H	33.0	total W	23.5	depth	21.5

Exceeds BIFMA Seating Durability Test to 500 lbs  
 CAL 133, add \$58 List  
 1" extra seat foam, specify and add \$14 List



**1852**  
**With arms**  
 17 lbs



# Snowball 2

## Stools

### Standard Features

- 0.875" frame
- Seat and back upholstered
- Back has enhanced contours for superior comfort
- Frame in any Spectone color
- Does not stack
- Ships 1/carton 17 cu ft

Contact Spec Customer Service to railroad fabrics (specify repeat info and yardage requirement will be provided) and for repeats greater than 5" x 5"

### Options

- Polyurethane arms available in Black (B), Sterling Grey (G) or Taupe RAL 7006 (T)
- Connecting clips for ganging chairs, add \$8 List/set
- Antibacterial and antimicrobial fabrics available
- Different fabric on seat and back at no upcharge
- Casters, sled base not available
- CAL 133
- Other glides may be available for an upcharge - call Customer Service to inquire

### Snowball 2 – Stools

COM 1.0 yd  
0.5 yd COM per single seat  
0.5 yd COM per single back

MODEL	COM	GR 1	GR 2	GR 3	GR 4	GR 5	GR 6
1871	440	492	510	544	596	636	686
1875	440	492	510	544	596	636	686

Dimensions (inches)

	seat H	28.0	seat W	18.0	arm H	36.0	total H	43.5
depth	21.5	total W	23.5	total W (no arms)	20.1			

Exceeds BIFMA Seating Durability Test to 500 lbs  
CAL 133, add \$58 List  
1" extra seat foam, specify and add \$14 List



**1871**  
With arms  
21 lbs



**1875**  
Without arms  
20 lbs

### Snowball 2 – Midsize Stools

COM 1.5 yd  
0.75 yd COM per single seat  
0.75 yd COM per single back

MODEL	COM	GR 1	GR 2	GR 3	GR 4	GR 5	GR 6
1874	598	695	726	788	886	961	1057
1876	598	695	726	788	886	961	1057

Dimensions (inches)

	seat H	28.0	seat W	22.0	arm H	36.0	total H	43.5
depth	22.0	total W	26.9	total W (no arms)	24.0			

Exceeds BIFMA Seating Durability Test to 500 lbs  
CAL 133, add \$82 List  
1" extra seat foam, specify and add \$21 List



**1874**  
With arms  
23 lbs



**1876**  
Without arms  
22 lbs



# Snowball 2

## Easy Access Hip Single Seater

### Standard Features

- 0.875" frame
- Seat and back upholstered
- Back has enhanced contours for superior comfort
- Frame in any Spectone color
- Does not stack
- Ships 1/carton 19 cu ft

Contact Spec Customer Service to railroad fabrics (specify repeat info and yardage requirement will be provided) and for repeats greater than 5" x 5"

### Options

- Polyurethane arms available in Black (B), Sterling Grey (G) or Taupe RAL 7006 (T)
- Connecting clips for ganging chairs, add \$8 List/set
- Antibacterial and antimicrobial fabrics available
- Different fabric on seat and back at no upcharge
- Casters, sled base not available
- CAL 133
- Other glides may be available for an upcharge - call Customer Service to inquire

---

### Snowball 2 – Easy Access Hip Single Seater

COM 1.0 yd  
0.5 yd COM per single seat  
0.5 yd COM per single back

MODEL	COM	GR 1	GR 2	GR 3	GR 4	GR 5	GR 6
<b>1871E</b>	<b>481</b>	<b>533</b>	<b>552</b>	<b>585</b>	<b>638</b>	<b>678</b>	<b>728</b>

Dimensions (inches)  
seat H 24.0    seat W 18.0    arm H 32.0  
total H 38.5    total W 23.5    depth 31.0

Exceeds BIFMA Seating Durability Test to 500 lbs  
CAL 133, add \$58 List  
1" extra seat foam, specify and add \$14 List



**1871E**  
With arms  
21 lbs

---

### Snowball 2 – Midsize Easy Access Hip Single Seater

COM 1.5 yd  
0.75 yd COM per single seat  
0.75 yd COM per single back

MODEL	COM	GR 1	GR 2	GR 3	GR 4	GR 5	GR 6
<b>1874E</b>	<b>645</b>	<b>742</b>	<b>773</b>	<b>835</b>	<b>933</b>	<b>1008</b>	<b>1104</b>

Dimensions (inches)  
seat H 24.0    seat W 22.0    arm H 32.0  
total H 38.5    total W 26.9    depth 31.0

Exceeds BIFMA Seating Durability Test to 500 lbs  
CAL 133, add \$82 List  
1" extra seat foam, specify and add \$21 List



**1874E**  
With arms  
23 lbs



# Snowball

## Dolly

### Standard Features

- Black finish only
- 2" black swivel casters
- Standard Dolly stacks 10 chairs
- Midsize Dolly stacks 4 chairs
- Bariatric Dolly stacks 4 chairs
- Ships 1/carton 17 cu ft

### Options

- Please specify if dolly is for chairs with wall-saving frame



Available on Spec 10 Day Program

---

## Snowball 2 – Dolly



DESCRIPTION	MODEL	PRICE
<b>Standard</b>	<b>1899</b>	<b>343</b>
<b>22" Midsize</b>	<b>1899M</b>	<b>491</b>
<b>26" Bariatric</b>	<b>1899G</b>	<b>491</b>

### Dimensions (inches)

<b>Standard</b>		<b>Midsize / Bariatric</b>	
height	36.5	height	36.5
width	21.0	width	23.0
depth	31.0	depth	42.0

---



**1899  
Standard**  
18 lbs



**1899 G&M  
Midsize & Bariatric**  
24 lbs



# Snowball 2

## Connected and Tables

### To order connected Snowballs

- Select and price the Snowballs required for your configuration
- Select and price the corner, spacer and end tables required
- Add Snowball connecting bars (between chairs only)
- Do not add connecting bars for tables (they are part of the table)
- For quick takedown or reconfiguration, use connecting clips (\$8 List/set) on chairs rather than connecting bars
- Send a drawing with your order or call Spec for assistance

*Connecting bars and tables can be retrofitted, allowing you to change configurations later or create new configurations from your present Snowballs*

*Connecting bars can be added to any Snowball chair, including Bariatric and Midsize*

*Connecting bars and table frame bars are finished in the same color as the color of the chair frames*

*Connecting bars are fastened to the underside of the Snowball chair frame at the front and back*



### Snowball Tables

- Table top is 3/4" thick
- Self Edge, 2MM Bio or PVC (flat only). 2MM Bio and PVC edge have a choice of 38 colors to match frame color
- Laminate tops available in any Arborite, Formica, Nevamar, Pionite or Wilsonart standard finish



## Snowball 2 – Connected and Tables



DESCRIPTION	Corner Table	Spacer Table	Mini Spacer Table	End Table*	Connecting Bars
MODEL	18RC	18ST	18MT	18ET	18CON
DIMENSIONS (inches)	25 x 25	17 x 17	4.5 x 14.5	17 x 17	N/A
PRICE	<b>330</b>	<b>226</b>	<b>135</b>	<b>235</b>	<b>80</b>

\*End table is handed, provide layout

For exact specifications, see specification sheet.

Toll Free: 1-888-761-7732



# Snowball

## Tablet Arms and Wire Basket

### Tablet Arm

- Fits any Snowball, freestanding or within a configuration
- Standard or laptop size available
- Right and left handed versions (defined when sitting in chair), add TR for right handed or TL for left handed to model number
- Laminated on both sides, standard in Wilsonart Dove Grey D-92-60 with flat black PVC edge.  
For other laminate please contact the factory for pricing
- Tablet constructed of 3/4" Nu Green core
- Snowball with Tablet Arm is standard with no arm on opposite side
- Add price of Tablet Arm to your Snowball selection

### Wire Basket

- Add to any 18" wide Snowball
- Black
- Removable



**Note: We do not recommend stacking Snowballs that have tablet arms**

## Snowball 2 – Tablet Arms and Wire Basket



DESCRIPTION	<b>Standard Tablet Arm</b>	<b>Laptop Tablet Arm</b>	<b>Wire Basket</b>
MODEL	TR (right) or TL (left)	LTR (right) or LTL (left)	WB
PRICE	<b>231</b>	<b>260</b>	<b>57</b>
Dimensions (inches)	height 27.5 width 12.75 total W 24.5 length 24.0 tablet extends 6" from seat	height 27.5 width 16.0 total W 24.5 length 24.75 tablet extends 7" from seat	



# Snowball 2

## 10 Day Program

### Standard Features

- Black polyurethane arms
- Back with enhanced contours for superior comfort
- Nickel or black textured frame finish
- A selection of fabrics and vinyls can be seen on our website under 10 Day Quickship

### Options

- Connecting clips for ganging chairs, add \$8 List/set
- Snowball Dolly, stacks regular width four-point Snowballs up to 10 high, Midsize and Bariatric Snowballs up to 4 high

For information on the 10 Day Program guarantee and terms and conditions, visit our website and go to Seating/10 Day Program/Snowball/Terms & Conditions

### Snowball 2 – 10 Day Program

COM 1.0 yd  
0.5 yd COM per single seat  
0.5 yd COM per single back

MODEL	COM	GR 1	GR 2	GR 3	GR 4	GR 5	GR 6
1851	330	384	401	435	488	527	579
1861	330	384	401	435	488	527	579
1881	346	397	414	449	501	540	592
1891	346	397	414	449	501	540	592

COM 1.5 yd  
0.75 yd COM per single seat  
0.75 yd COM per single back

MODEL	COM	GR 1	GR 2	GR 3	GR 4	GR 5	GR 6
1854	456	553	584	647	745	819	915

COM 2.0 yd  
1.0 yd COM per single seat  
1.0 yd COM per single back

MODEL	COM	GR 1	GR 2	GR 3	GR 4	GR 5	GR 6
1853	529	625	659	721	819	890	988

Dolly

MODEL	COM
1899	343
1899M	491
1899G	491



1851  
With arms  
16 lbs



1861  
Without arms  
15 lbs



1881  
With arms  
18 lbs



1891  
Without arms  
17 lbs



1899  
Standard  
18 lbs



1899 G&M  
Midsize & Bariatric  
24 lbs



1854  
With arms  
18 lbs



1853  
With arms  
23 lbs

For exact specifications, see specification sheet.

Toll Free: 1-888-761-7732



# SNOWBALL 3



PLACING AN ORDER IS EASY

## PRODUCT CODE

**19 01**

### Series

19 : Snowball 3

### Chair Type

01 : Four Point/Arms	14 : 22"/4-Point/No Arms	21 : Stool/Arms	24E : 22" Hip Chair
11 : Four Point/No Arms	03 : 26"/4-Point/Arms	51 : Stool/No Arms	
31 : Sled Base/Arms	44 : 22"/Sled/No Arms	24 : 22"/Stool/Arms	
41 : Sled Base/No Arms	43 : 26"/Sled/No Arms	26 : 22"/Stool/No Arms	
04 : 22"/4-point/Arms	02 : Casters/Arms	21E : Hip Chair	

## OPTIONS

### WALL-SAVING



### CUTOUTS



Cutout A



Cutout B



Cutout C



Cutout D



Cutout E



Custom Engraving\*



Custom Cutout\*



Custom Decal\*

*\*Custom engravings, cutouts and decals are available. Please call for pricing.*

## FINISHES

### FRAME



Select from one of our 76 standard Spectone colors

### ARMS



Black

Sterling Grey

Taupe

### FABRIC



Select fabrics from one of our textile partners

### BACK STAIN

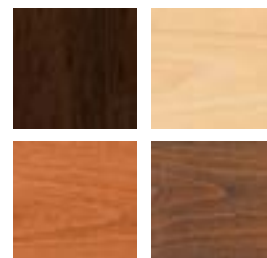

Select from one of our 7 standard wood stains or stain-to-match at no upcharge

For exact specifications, see specification sheet.

Toll Free: 1-888-761-7732





# Snowball 3

## Four-point and Sled Base

### Standard Features

- 0.875" frame
- Upholstered seat and wood back
- Seat and/or back in Natural Maple in any of 7 standard stains or stain-to-match at no upcharge
- Choice of 5 back cut-outs
- Frame in any Spectone color
- Four-point stacks 10 high with dolly, 6 without dolly
- Sled Base does not stack and ships 1 per carton
- Ships 1/carton 11 cu ft, 2-4/carton 22 cu ft

Contact Spec Customer Service to railroad fabrics (specify repeat info and yardage requirement will be provided) and for repeats greater than 5" x 5"

### Options

- Wood seat, add \$55 List to COM price
- Custom back cut-outs and engravings
- Wall-saving frame on Four-point only, add \$20 List, not available on 10 Day
- Polyurethane arms available in Black (B), Sterling Grey (G) or Taupe RAL 7006 (T)
- Connecting clips for ganging chairs, add \$8 List/set
- Connecting bars for a structured reconfigurable layout, add \$80 List
- Antibacterial and antimicrobial fabrics available
- Different fabric on seat and back at no upcharge
- Tablet Arm available on Snowballs without arms
- CAL 133
- Other glides may be available for an upcharge call Customer Service to inquire



Available on Spec 10 Day Program

Optional wall-saving Frame



### Snowball 3 – Four-point

COM 0.5 yd  
0.5 yd COM per single seat

MODEL	COM	GR 1	GR 2	GR 3	GR 4	GR 5	GR 6
1901	402	427	436	454	479	500	525
1911	402	427	436	454	479	500	525

Dimensions (inches)

seat H	18.0	seat W	18.0	arm H	26.0	total H	33.0
depth	21.5	total W	23.5	total W (no arms)	20.1		

Exceeds BIFMA Seating Durability Test to 500 lbs  
CAL 133, add \$30 List  
1" extra seat foam, specify and add \$14 List



1901  
With arms  
16 lbs



1911  
Without arms  
15 lbs

### Snowball 3 – Sled Base

COM 0.5 yd  
0.5 yd COM per single seat

MODEL	COM	GR 1	GR 2	GR 3	GR 4	GR 5	GR 6
1931	415	441	450	467	493	513	539
1941	415	441	450	467	493	513	539

Dimensions (inches)

seat H	18.0	seat W	18.0	arm H	26.0	total H	33.0
depth	21.5	total W	23.5	total W (no arms)	20.1		

Exceeds BIFMA Seating Durability Test to 500 lbs  
CAL 133, add \$30 List  
1" extra seat foam, specify and add \$14 List



1931  
With arms  
18 lbs



1941  
Without arms  
17 lbs

For exact specifications, see specification sheet.



# Snowball 3

Midsize and Bariatric – Four-point

## Standard Features

- 0.875" frame
- Upholstered seat and wood back
- Seat and/or back in Natural Maple in any of 7 standard stains or stain-to-match at no upcharge
- Choice of 5 back cut-outs
- Frame in any Spectone color
- Four-point stacks 4 high on floor or with dolly
- Ships 1-3/carton 21.24 cu ft for Midsize and 1-3/carton 24.17 cu ft for Bariatric

Contact Spec Customer Service to railroad fabrics (specify repeat info and yardage requirement will be provided) and for repeats greater than 5" x 5"



Available on Spec 10 Day Program

## Options

- Custom back cut-outs and engravings
- Wall-saving frame, add \$20 List, not available on 10 Day
- Polyurethane arms available in Black (B), Sterling Grey (G) or Taupe RAL 7006 (T)
- Connecting clips for ganging chairs, \$8 List/set
- Connecting bars for a structured reconfigurable layout, add \$80 List
- Antibacterial and antimicrobial fabrics available
- Different fabric on seat and back at no upcharge
- CAL 133
- Other glides may be available for an upcharge - call Customer Service to inquire

Optional wall-saving Frame



## Snowball 3 – Midsize – Four-point

COM 0.75 yd  
0.75 yd COM per single seat

MODEL	COM	GR 1	GR 2	GR 3	GR 4	GR 5	GR 6
1904	503	545	559	585	627	660	701
1914	503	545	559	585	627	660	701

\*1914 Not Available on 10 Day Program

Dimensions (inches)

	seat H	18.0	seat W	22.0	arm H	26.0	total H	33.0
depth	22.0	total W	26.9	total W (no arms)	24.0			

Exceeds BIFMA Seating Durability Test to 500 lbs  
CAL 133, add \$41 List  
1" extra seat foam, specify and add \$21 List



1904  
With arms  
18 lbs



1914  
Without arms  
17 lbs

\*Not Available on 10 Day Program

## Snowball 3 – Bariatric – Four-point

COM 1.0 yd  
1.0 yd COM per single seat

MODEL	COM	GR 1	GR 2	GR 3	GR 4	GR 5	GR 6
1903	544	585	601	626	668	700	742

Dimensions (inches)

	seat H	18.0	seat W	26.0	arm H	26.0
total H	33.0	total W	31.0	depth	22.0	

Exceeds BIFMA Seating Durability Test to 500 lbs  
CAL 133, add \$41 List  
1" extra seat foam, specify and add \$30 List



1903  
With arms  
23 lbs



# Snowball 3

Midsize and Bariatric – Sled Base

## Standard Features

- 0.875" frame
- Upholstered seat and wood back
- Seat and/or back in Natural Maple in any of 7 standard stains or stain-to-match at no upcharge
- Choice of 5 back cut-outs
- Seat and back upholstered
- Frame in any Spectone color
- Does not stack
- Ships 1/carton 21 cu ft

## Options

- Custom back cut-outs and engravings
- Connecting clips for ganging chairs, \$8 List/set
- Connecting bars for a structured reconfigurable layout, add \$80 List
- Antibacterial and antimicrobial fabrics available
- Different fabric on seat and back at no upcharge
- Tablet Arm available on Snowballs without arms
- CAL 133
- Other glides may be available for an upcharge - call Customer Service to inquire

Contact Spec Customer Service to railroad fabrics (specify repeat info and yardage requirement will be provided) and for repeats greater than 5" x 5"

---

## Snowball 3 – Midsize – Sled Base

COM 0.75 yd  
0.75 yd COM per single seat

MODEL	COM	GR 1	GR 2	GR 3	GR 4	GR 5	GR 6
<b>1944</b>	<b>536</b>	<b>577</b>	<b>592</b>	<b>619</b>	<b>661</b>	<b>693</b>	<b>735</b>

Dimensions (inches)

seat H	18.0	seat W	22.0	arm H	N/A
total H	33.0	total W	24.0	depth	22.0

Exceeds BIFMA Seating Durability Test to 500 lbs  
CAL 133, add \$41 List  
1" extra seat foam, specify and add \$21 List



**1944**  
Without arms  
20 lbs

---

## Snowball 3 – Bariatric – Sled Base

COM 1.0 yd  
1.0 yd COM per single seat

MODEL	COM	GR 1	GR 2	GR 3	GR 4	GR 5	GR 6
<b>1943</b>	<b>576</b>	<b>619</b>	<b>632</b>	<b>660</b>	<b>701</b>	<b>733</b>	<b>775</b>

Dimensions (inches)

seat H	18.0	seat W	26.0	arm H	N/A
total H	33.0	total W	28.0	depth	22.0

Exceeds BIFMA Seating Durability Test to 500 lbs  
CAL 133, add \$41 List  
1" extra seat foam, specify and add \$30 List



**1943**  
Without arms  
25 lbs



# Snowball 3

## Casters

### Standard Features

- 0.875" frame
- Upholstered seat and wood back
- Seat and/or back in Natural Maple in any of 7 standard stains or stain-to-match at no upcharge
- Choice of 5 back cut-outs
- Seat and back upholstered
- Frame in any Spectone color
- Black non-locking casters
- Four-point stacks 10 high with dolly, 6 without dolly
- Ships 1/carton 11 cu ft, 2-3/carton 22 cu ft

### Options

- Wood seat, add \$55 List to COM price
- Custom back cut-outs and engravings
- Polyurethane arms available in Black (B), Sterling Grey (G) or Taupe RAL 7006 (T)
- Antibacterial and antimicrobial fabrics available
- Different fabric on seat and back at no upcharge
- Armless and sled base versions not available
- CAL 133

Contact Spec Customer Service to railroad fabrics (specify repeat info and yardage requirement will be provided) and for repeats greater than 5" x 5"

---

### Snowball 3 – Casters

COM 0.5 yd  
0.5 yd COM per single seat

MODEL	COM	GR 1	GR 2	GR 3	GR 4	GR 5	GR 6
<b>1902</b>	<b>521</b>	<b>549</b>	<b>557</b>	<b>573</b>	<b>601</b>	<b>620</b>	<b>645</b>

Dimensions (inches)

seat H	18.0	seat W	18.0	arm H	26.0
total H	33.0	total W	23.5	depth	21.5

Exceeds BIFMA Seating Durability Test to 500 lbs  
CAL 133, add \$30 List  
1" extra seat foam, specify and add \$14 List



**1902**  
With arms  
17 lbs



# Snowball 3

## Stools

### Standard Features

- 0.875" frame
- Upholstered seat and wood back
- Seat and/or back in Natural Maple in any of 7 standard stains or stain-to-match at no upcharge
- Choice of 5 back cut-outs
- Seat and back upholstered
- Frame in any Spectone color
- Does not stack
- Ships 1/carton 17 cu ft

### Options

- Wood seat, add \$55 List to COM price
- Custom back cut-outs and engravings
- Polyurethane arms available in Black (B), Sterling Grey (G) or Taupe RAL 7006 (T)
- Connecting clips for ganging chairs, add \$8 List/set
- Antibacterial and antimicrobial fabrics available
- Different fabric on seat and back at no upcharge
- Casters, sled base not available
- CAL 133
- Other glides may be available for an upcharge - call Customer Service to inquire

Contact Spec Customer Service to railroad fabrics (specify repeat info and yardage requirement will be provided) and for repeats greater than 5" x 5"

### Snowball 3 – Stool

COM 0.5 yd  
0.5 yd COM per single seat

MODEL	COM	GR 1	GR 2	GR 3	GR 4	GR 5	GR 6
1921	509	533	543	560	585	606	631
1951	509	533	543	560	585	606	631

Dimensions (inches)  
 seat H 28.0 seat W 18.0 arm H 36.0 total H 43.5  
 depth 21.5 total W 23.5 total W (no arms) 20.1  
 Exceeds BIFMA Seating Durability Test to 500 lbs  
 CAL 133, add \$30 List  
 1" extra seat foam, specify and add \$14 List



**1921**  
With arms  
21 lbs



**1951**  
Without arms  
20 lbs

### Snowball 3 – Midsize Stools

COM 0.75 yd  
0.75 yd COM per single seat

MODEL	COM	GR 1	GR 2	GR 3	GR 4	GR 5	GR 6
1924	645	686	701	727	769	802	843
1926	645	686	701	727	769	802	843

Dimensions (inches)  
 seat H 28.0 seat W 22.0 arm H 36.0 total H 43.5  
 depth 22.0 total W 26.9 total W (no arms) 24.0  
 Exceeds BIFMA Seating Durability Test to 500 lbs  
 CAL 133, add \$41 List  
 1" extra seat foam, specify and add \$21 List



**1924**  
With arms  
23 lbs



**1926**  
Without arms  
22 lbs

For exact specifications, see specification sheet.

Toll Free: 1-888-761-7732

## Snowball 3

### Easy Access Hip Single Seater

#### Standard Features

- 0.875" frame
- Seat and back upholstered
- Frame in any Spectone color
- Does not stack
- Ships 1/carton 19 cu ft

Contact Spec Customer Service to railroad fabrics (specify repeat info and yardage requirement will be provided) and for repeats greater than 5" x 5"

#### Options

- Wood seat, add \$55 List to COM price
- Polyurethane arms available in Black (B), Sterling Grey (G) or Taupe RAL 7006 (T)
- Connecting clips for ganging chairs, add \$8 List/set
- Antibacterial and antimicrobial fabrics available
- Different fabric on seat and back at no upcharge
- Casters, sled base not available
- CAL 133
- Other glides may be available for an upcharge - call Customer Service to inquire

#### Snowball 3 – Easy Access Hip Chair

COM 0.5 yd  
0.5 yd COM per single seat

MODEL	COM	GR 1	GR 2	GR 3	GR 4	GR 5	GR 6
<b>1921E</b>	<b>551</b>	<b>575</b>	<b>584</b>	<b>602</b>	<b>627</b>	<b>647</b>	<b>673</b>

Dimensions (inches)

seat H	24.0	seat W	18.0	arm H	32.0
total H	38.5	total W	23.5	depth	31.0

Exceeds BIFMA Seating Durability Test to 500 lbs

CAL 133, add \$30 List

1" extra seat foam, specify and add \$14 List



**1921E**  
With arms  
21 lbs

#### Snowball 3 – Midsize Easy Access Hip Single Seater

COM 0.75 yd  
0.75 yd COM per single seat

MODEL	COM	GR 1	GR 2	GR 3	GR 4	GR 5	GR 6
<b>1924E</b>	<b>692</b>	<b>733</b>	<b>748</b>	<b>774</b>	<b>816</b>	<b>849</b>	<b>889</b>

Dimensions (inches)

seat H	24.0	seat W	22.0	arm H	32.0
total H	38.5	total W	26.9	depth	31.0

Exceeds BIFMA Seating Durability Test to 500 lbs

CAL 133, add \$41 List

1" extra seat foam, specify and add \$21 List



**1924E**  
With arms  
23 lbs



# Snowball

Dolly

## Standard Features

- Black finish only
- 2" black swivel casters
- Standard Dolly stacks 10 chairs
- Midsize Dolly stacks 4 chairs
- Bariatric Dolly stacks 4 chairs
- Ships 1/carton 17 cu ft

## Options

- Please specify if dolly is for chairs with wall-saving frame



Available on Spec 10 Day Program

---

## Snowball 3 – Dolly



DESCRIPTION	MODEL	PRICE
<b>Standard</b>	<b>1899</b>	<b>343</b>
<b>22" Midsize</b>	<b>1899M</b>	<b>491</b>
<b>26" Bariatric</b>	<b>1899G</b>	<b>491</b>

Dimensions (inches)

<b>Standard</b>		<b>Midsize / Bariatric</b>	
height	36.5	height	36.5
width	21.0	width	23.0
depth	31.0	depth	42.0

---



**1899  
Standard**  
18 lbs



**1899 G&M  
Midsize & Bariatric**  
24 lbs



# Snowball 3

## Connected and Tables

### To order connected Snowballs

- Select and price the Snowballs required for your configuration
- Select and price the corner, spacer and end tables required
- Add Snowball connecting bars (between chairs only)
- Do not add connecting bars for tables (they are part of the table)
- For quick takedown or reconfiguration, use connecting clips (\$8 List/set) on chairs rather than connecting bars
- Send a drawing with your order or call Spec for assistance

*Connecting bars and tables can be retrofitted, allowing you to change configurations later or create new configurations from your present Snowballs*

*Connecting bars can be added to any Snowball chair, including Bariatric and Midsize*

*Connecting bars and table frame bars are finished in the same color as the color of the chair frames*

*Connecting bars are fastened to the underside of the Snowball chair frame at the front and back*



### Snowball Tables

- Table top is 3/4" thick
- Self Edge, 2MM Bio or PVC (flat only). 2MM Bio and PVC edge have a choice of 38 colors to match frame color
- Laminate tops available in any Arborite, Formica, Nevamar, Pionite or Wilsonart standard finish



### Snowball 3 – Connected and Tables



DESCRIPTION	Corner Table	Spacer Table	Mini Spacer Table	End Table*	Connecting Bars
MODEL	18RC	18ST	18MT	18ET	18CON
DIMENSIONS (inches)	25 x 25	17 x 17	4.5 x 14.5	17 x 17	N/A
PRICE	<b>330</b>	<b>226</b>	<b>135</b>	<b>235</b>	<b>80</b>

\*End table is handed, provide layout

For exact specifications, see specification sheet.

Toll Free: 1-888-761-7732





# Snowball

## Tablet Arms and Wire Basket

### Tablet Arm

- Fits any Snowball, freestanding or within a configuration
- Standard or laptop size available
- Right and left handed versions (defined when sitting in chair), add TR for right handed or TL for left handed to model number
- Laminated on both sides, standard in Wilsonart Dove Grey D-92-60 with flat black PVC edge.  
For other laminate please contact the factory for pricing
- Tablet constructed of 3/4" Nu Green core
- Snowball with Tablet Arm is standard with no arm on opposite side
- Add price of Tablet Arm to your Snowball selection

### Wire Basket

- Add to any 18" wide Snowball
- Black
- Removable



**Note: We do not recommend stacking Snowballs that have tablet arms**

## Snowball 3 – Tablet Arm and Wire Basket



DESCRIPTION  
MODEL  
PRICE

**Standard Tablet Arm**  
TR (right) or TL (left)  
**231**

**Laptop Tablet Arm**  
LTR (right) or LTL (left)  
**260**

**Wire Basket**  
WB  
**57**

Dimensions (inches)

height 27.5  
width 12.75  
total W 24.5  
length 24.0  
tablet extends 6" from seat

height 27.5  
width 16.0  
total W 24.5  
length 24.75  
tablet extends 7" from seat



# Snowball 3

## 10 Day Program

### Standard Features

- Black polyurethane arms
- Upholstered seat and wood back
- Back in Cherry stain or Natural Maple stain
- Back cut-out A
- Nickel or black textured frame finish
- A selection of fabrics and vinyls can be seen on our website at Seating/10 Day Program/Snowball/10 Day Fabrics Available

For information on the 10 Day Program guarantee and terms and conditions, visit our website and go to Seating/10 Day Program/Snowball/Terms & Conditions

### Options

- Connecting clips for ganging chairs, add \$8 List/set
- Snowball Dolly, stacks regular width four-point Snowballs up to 10 high, Midsize and Bariatric Snowballs up to 4 high

### Snowball 3 – 10 Day Program

COM 0.5 yd  
0.5 yd COM per single seat

MODEL	COM	GR 1	GR 2	GR 3	GR 4	GR 5	GR 6
1901	402	427	436	454	479	500	525
1911	402	427	436	454	479	500	525
1931	415	441	450	467	493	513	539
1941	415	441	450	467	493	513	539

COM 0.75 yd  
0.75 yd COM per single seat

MODEL	COM	GR 1	GR 2	GR 3	GR 4	GR 5	GR 6
1904	503	545	559	585	627	660	701

COM 1.0 yd  
1.0 yd COM per single seat

MODEL	COM	GR 1	GR 2	GR 3	GR 4	GR 5	GR 6
1903	544	585	601	626	668	700	742

Dolly

MODEL	
1899	343
1899M	491
1899G	491



1901  
With arms  
16 lbs



1911  
Without arms  
15 lbs



1931  
With arms  
18 lbs



1941  
Without arms  
17 lbs



1899  
Standard  
18 lbs



1899 G&M  
Midsize & Bariatric  
24 lbs



1904  
With arms  
18 lbs



1903  
With arms  
23 lbs

For exact specifications, see specification sheet.



# Snowball 3

## Seat Back Options

### Seat Back Designs

- Backs standard in Natural maple in any of 7 standard stains or stain-to-match at no upcharge
- On the 10 Day Program; only back design A is available in Cherry stain or Natural Maple stain

### Custom Seat Back Cut-out

- A one time set up charge of \$260 list applies
- Design should fit within a 5" x 5" space (due to contour of back)
- Shape will be mirrored from the front of the chair

*Pick a back design and add suffix A-E following the model number, e.g. 1901BA (Snowball 3 with black arms and back design A)*

### Custom Seat Back Engravings and Vinyl Decals

- For quantities over 25, add an upcharge of \$53 List/chair
- For quantities under 25, add an upcharge of \$53 List/chair, plus a \$260 List set up fee **per order**

**Engravings:** *Please note that inconsistencies in the wood may show after the engraving is completed. When choosing the raw wood, we take extra care to select backs that are similar in graining and color, however, no guarantee can be made. We recommend that an engraved image be stained a darker color to hide possible inconsistencies.*

### Snowball 3 – Seat Back Designs



Seat Back Design "A"



Seat Back Design "B"



Seat Back Design "C"



Seat Back Design "D"



Seat Back Design "E"

### Snowball 3 – Custom Seat Back Cut-out



### Snowball 3 – Custom Seat Back Engraving



### Snowball 3 – Custom Seat Back Vinyl Decals



*Available up to 4"x4"  
Maximum of 4 colors per decal  
Vector based files required*



# SNOWFLAKE

BACK TO CONTENTS



PLACING AN ORDER IS EASY

## PRODUCT CODE

### CHAIR

**1805**

#### Series

- 1805 : Snowflake 1
- 1855 : Snowflake 2
- 1905 : Snowflake 3

### TABLE

**24 SF**

#### Size

- 24 : 24"
- 30 : 30"
- 36 : 36"

#### Collection

SF : Snowflake



## OPTIONS

### SERIES OPTIONS



Snowflake 1

Snowflake 2

Snowflake 3

### SNOWFLAKE 3 BACK



Snowflake



Moon



Star



Sun



\*Custom Cutout



\*Custom Engraving

*\*Custom engravings and cutouts are available. Please call for pricing.*

## FINISHES

### FRAME



Select from one of our 76 standard Spectone colors

### FABRIC

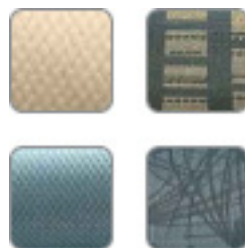

Select fabrics from one of our textile partners

### BACK STAIN

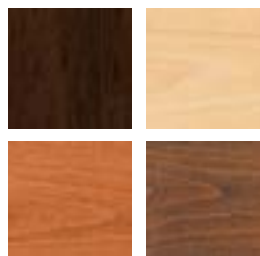

Select from one of our 7 standard wood stains or stain-to-match at no upcharge



# SNOWFLAKE – Children’s Series

## Snowflake 1 and 2

### Standard Features

- Snowflake 1; seat and back upholstered
- Snowflake 2; seat and back upholstered, back has enhanced contours for superior comfort
- Frame in any Spectone color
- Stack 4 high
- Ships 2/carton 6 cu ft

### Options

- Antibacterial and antimicrobial fabrics available
- Different fabric on seat and back at no upcharge
- CAL 133

Contact Spec Customer Service to railroad fabrics (specify repeat info and yardage requirement will be provided) and for repeats greater than 5" x 5"



### Snowflake 1

COM 0.83 yds  
0.33 yd COM per single seat / 0.5 yd COM per single back

MODEL	COM	GR 1	GR 2	GR 3	GR 4	GR 5	GR 6
<b>1805</b>	<b>297</b>	<b>328</b>	<b>340</b>	<b>362</b>	<b>394</b>	<b>418</b>	<b>460</b>

Dimensions (inches)

	seat H	14.0	seat W	13.0	arm H	N/A
total H	24.0	total W	15.25	depth	15.0	

CAL 133, add \$58 List per seat



**1805**  
9 lbs

### Snowflake 2

COM 0.83 yds  
0.33 yd COM per single seat / 0.5 yd COM per single back

MODEL	COM	GR 1	GR 2	GR 3	GR 4	GR 5	GR 6
<b>1855</b>	<b>310</b>	<b>343</b>	<b>353</b>	<b>373</b>	<b>407</b>	<b>430</b>	<b>472</b>

Dimensions (inches)

	seat H	14.0	seat W	13.0	arm H	N/A
total H	24.0	total W	15.25	depth	15.0	

CAL 133, add \$58 List per seat



**1855**  
9 lbs



# SNOWFLAKE – Children’s Series

## Snowflake 3

### Standard Features

- Seat upholstered with wood back
- Natural maple back in any of 7 standard stains or stain-to-match at no upcharge
- Frame in any Spectone color
- Stack 4 high
- Ships 2/carton 6 cu ft

Contact Spec Customer Service to railroad fabrics (specify repeat info and yardage requirement will be provided) and for repeats greater than 5" x 5"

### Options

- Snowflake, Star, Sun and Moon cut-outs at no upcharge
- Custom cut-outs and engravings
- Wood seat, add \$55 List to COM price
- Antibacterial and antimicrobial fabrics available
- Different fabric on seat and back at no upcharge
- CAL 133

### Custom Seat Back Cut-out

- A one time set up charge of \$260 list applies
- Design should fit within a 5" x 5" space (due to contour of back)
- Shape will be mirrored from the front of the chair

### Custom Seat Back Engraving

- For quantities over 25, add an upcharge of \$53 List/chair
- For quantities under 25, add an upcharge of \$53 List/chair, plus a \$260 List set up fee **per order**

Please note that inconsistencies in the wood may show after the engraving is completed. When choosing the raw wood, we take extra care to select backs that are similar in graining and color, however, no guarantee can be made. We recommend that an engraved image be stained a darker color to hide possible inconsistencies.



### Snowflake 3

COM 0.33 yds  
0.33 yd COM per single seat

MODEL	COM	GR 1	GR 2	GR 3	GR 4	GR 5	GR 6
1905	323	339	345	354	370	383	407

Dimensions (inches)

seat H	14.0	seat W	13.0	arm H	N/A
total H	24.0	total W	15.25	depth	15.0

CAL 133, add \$31 List per seat



1905  
9 lbs

### Snowflake – Seat Back Designs



Snowflake



Star



Sun



Moon



# SNOWFLAKE – Children’s Series

## Freestanding Table

### Standard Features

- Tops constructed from 0.75” particle board core with laminate surface and backer
- Laminate tops in any standard Arborite, Formica, Nevamar, Pionite or Wilsonart matte finish
- Edge is flat PVC with 38 colors available to match base finishes
- Frame in any Spectone color
- Tops utilize Nu Green earth friendly core
- 22” height
- Ships 1/carton

### Options

- Non-standard laminates, contact Spec for pricing
- Other shapes such as round or square are available in non-stacking designs
- Other sizes may be available



### Freestanding Table

Model	Top Size (inches)	Laminate PVC Edge	Weight	Cu.Ft.
24SF	24	<b>564</b>	27	11
30SF	30	<b>665</b>	37	16
36SF	36	<b>728</b>	48	22



## TRAFFIC PUBLIC SEATING – Layouts



### Description

- Today's high traffic public areas demand high durability and low maintenance without sacrificing design.
- Perforated steel seats, with optional field replaceable cushions, can be connected with perforated steel or laminate spacer tables to fit virtually any layout.
- Standard seat width is 22". Bariatric seating is a 30" wide seat and is load tested to 750 lbs.
- Seat, leg column and foot can be specified in different finishes.
- Arms or armless can be specified in any standard width combination.
- Arms only for Bariatric.
- Please send a drawing of the configuration you require with your order.
- Optional floor mounting brackets available.
- Seat mounting option location offers wall-saving if desired.
- For fabrics you wish railroaded or repeats larger than 5" x 5", please contact the factory with repeat information and yardage requirement will be provided.

### LAYOUTS AND DIMENSIONS

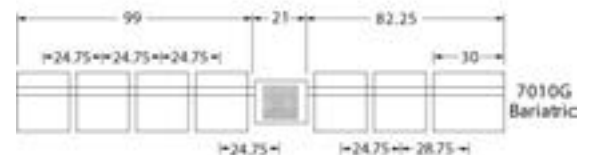
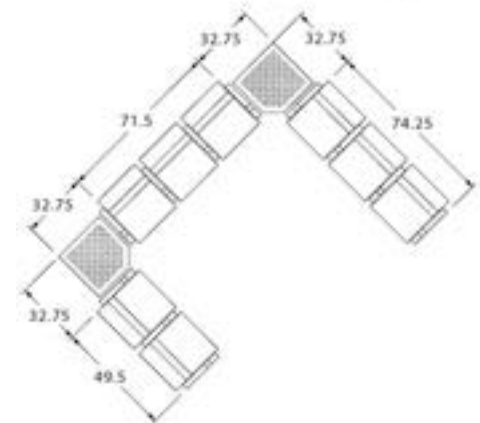
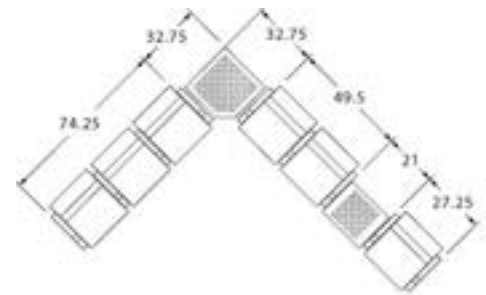



# TRAFFIC



PLACING AN ORDER IS EASY

## PRODUCT CODE

**70 00 N**

**Series**

70 : Traffic

**Arm**

00 : No Arms  
10 : Arms

**Chair Type**

N : Without Cushions  
U : With Cushions  
NG : Bariatric without Cushion  
UG : Bariatric with Cushion



## OPTIONS

### UPHOLSTERY



Without Cushion



With Cushion

### ARMS



With Arms



Without Arms

## FINISHES

### FRAME



Select from one of our 76 standard Spectone colors

### FABRIC

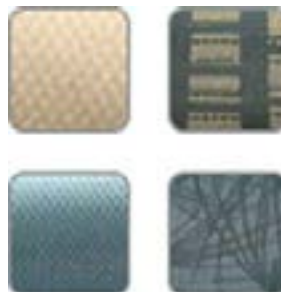

Select fabrics from one of our textile partners



# TRAFFIC Public Seating

Perforated Beam without arms

## Standard Features

- Available with or without replaceable upholstered cushions
- Available with or without black polyurethane arms
- Frame in any Spectone color
- Levelers
- Can be mounted standard or wall-saving
- Ships KD
- Ships 1/carton 11.5 cu ft/seat

## Options

- Corner and spacer tables
- Use in connected layouts at no upcharge
- Floor mounting brackets, add \$47 List/leg. Includes 2 brackets per leg.
- Antibacterial and antimicrobial fabrics available
- CAL 133



**Prices are per seat and include beam and base**

Contact Spec Customer Service to railroad fabrics (specify repeat info and yardage requirement will be provided) and for repeats greater than 5" x 5"

---

## Traffic without arms, without upholstered cushions

---

N/A COM per single seat

MODEL	LIST
<b>7000N</b>	<b>767</b>

Dimensions (inches)

seat H	18.75	seat W	22.0	depth	25.5
total H	31.75	total W	24.75	depth wall-saving	27.5

Exceeds BIFMA Seating Durability Test to 500 lbs per seat



**7000N**  
43 lbs/seat

---

## Traffic without arms, with upholstered cushions

---

0.5 yd COM per single seat and back

MODEL	COM	GR 1	GR 2	GR 3	GR 4	GR 5	GR 6
<b>7000U</b>	<b>785</b>	<b>823</b>	<b>837</b>	<b>863</b>	<b>901</b>	<b>932</b>	<b>970</b>

Dimensions (inches)

seat H	19.25	seat W	22.0	depth	25.5
total H	32.0	total W	24.75	depth	27.5

Exceeds BIFMA Seating Durability Test to 500 lbs per seat  
CAL 133, add \$55 List per seat



**7000U**  
44 lbs/seat



# TRAFFIC Public Seating

Perforated Beam with arms

## Standard Features

- Available with or without replaceable upholstered cushions
- Available with or without black polyurethane arms
- Frame in any Spectone color
- Levelers
- Can be mounted standard or wall-saving
- Ships KD
- Ships 1/carton 11.5 cu ft/seat

## Options

- Corner and spacer tables
- Use in connected layouts at no upcharge
- Floor mounting brackets, add \$47 List/leg. Includes 2 brackets per leg.
- Antibacterial and antimicrobial fabrics available
- CAL 133



**Prices are per seat and include beam and base**

Contact Spec Customer Service to railroad fabrics (specify repeat info and yardage requirement will be provided) and for repeats greater than 5" x 5"

## Traffic with arms, without upholstered cushions

N/A COM per single seat

MODEL	LIST
<b>7010N</b>	<b>767</b>

Dimensions (inches)

seat H	18.75	seat W	22.0	depth	25.5
total H	31.75	total W	24.75	depth wall-saving	27.5

Exceeds BIFMA Seating Durability Test to 500 lbs per seat



**7010N**  
47 lbs/seat

## Traffic with arms and upholstered cushions

0.5 yd COM per single seat and back

MODEL	COM	GR 1	GR 2	GR 3	GR 4	GR 5	GR 6
<b>7010U</b>	<b>785</b>	<b>823</b>	<b>837</b>	<b>863</b>	<b>901</b>	<b>932</b>	<b>970</b>

Dimensions (inches)

seat H	19.25	seat W	22.0	arm H	27.25		
total H	32.0	total W	24.75	depth	25.5	depth wall-saving	27.5

Exceeds BIFMA Seating Durability Test to 500 lbs per seat  
CAL 133, add \$55 List per seat



**7010U**  
48 lbs/seat



# TRAFFIC Public Seating

Bariatric Perforated Beam with arms

## Standard Features

- Available with or without replaceable upholstered cushions
- Black polyurethane arms
- Frame in any Spectone color
- Levelers
- Not available as freestanding unit
- Can be mounted standard or wall-saving
- Cannot connect bariatric seats to bariatric seats
- Ships KD
- Ships 1/carton 11.5 cu ft/seat

## Options

- Corner and spacer tables
- Use in connected layouts at no upcharge
- Floor mounting brackets, add \$47 List/leg. Includes 2 brackets per leg.
- Antibacterial and antimicrobial fabrics available
- CAL 133



**Prices are per seat and include beam and base**

Contact Spec Customer Service to railroad fabrics (specify repeat info and yardage requirement will be provided) and for repeats greater than 5" x 5"

## Traffic with arms, without upholstered cushions

N/A COM per single seat

MODEL	LIST
<b>7010NG</b>	<b>998</b>

Dimensions (inches)

seat H	18.75	seat W	30.0	arm H	27.25		
total H	31.75	total W	32.75	depth	25.5	depth wall-saving	27.5

Exceeds BIFMA Seating Durability Test to 750 lbs per seat



**7010NG**  
47 lbs/seat

## Traffic with arms and upholstered cushions

0.75 yd COM per single seat and back

MODEL	COM	GR 1	GR 2	GR 3	GR 4	GR 5	GR 6
<b>7010UG</b>	<b>1009</b>	<b>1064</b>	<b>1083</b>	<b>1119</b>	<b>1174</b>	<b>1215</b>	<b>1271</b>

Dimensions (inches)

seat H	19.25	seat W	30.0	arm H	27.25		
total H	32.0	total W	32.75	depth	25.5	depth wall-saving	27.5

Exceeds BIFMA Seating Durability Test to 750 lbs per seat  
CAL 133, add \$66 List per seat



**7010UG**  
48 lbs/seat



# TRAFFIC Public Seating

## Corner and Spacer Connecting Tables

### Standard Features

- Laminate tops in any standard Arborite, Formica, Nevamar, Pionite or Wilsonart matte finish
- Self edge or PVC edge
- Use in connected layouts at no upcharge
- Tops utilize Nu Green earth friendly core
- Radius table only available in laminate
- 18" height
- Ships KD

### Options

- Non-standard laminates, contact Spec for pricing
- Tops in perforated metal
- Veneer and hardwood edges

*Radius Corner Tables are recommended for open areas*



### Corner and Spacer Connecting Tables

Model	Laminate PVC/Self Edge	Perforated Metal	Weight	Cu.Ft.
70RC 30 x 30 <i>Radius Corner Table</i>	<b>642</b>	-	31	3
70SC 30 x 30 <i>Square Corner Table</i>	<b>642</b>	<b>823</b>	32	3
70ST 21 x 21 <i>Spacer or End Table</i>	<b>619</b>	<b>697</b>	21	3

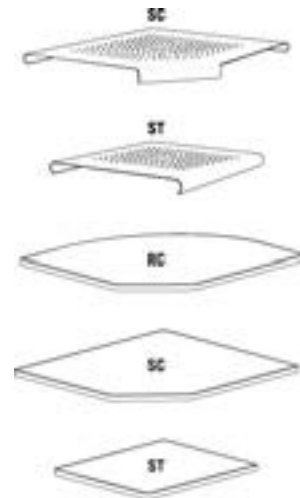



# URBAN

BACK TO CONTENTS



PLACING AN ORDER IS EASY

## PRODUCT CODE

**14 01 US**

**Series**

14 : Urban

**Chair Type**

- 01 : Four Point/Arms
- 11 : Four Point/No Arms
- 31 : Sled Base/Arms
- 41 : Sled Base/No Arms
- 02 : Casters/Arms
- 21 : Stool/Arms
- 25 : Stool/No Arms
- 21E : Hip Chair

**Upholstery**

- N/A : DuraSpec Seat/ Plastic Back
- US : Upholstered Seat/ Plastic back
- UB : DuraSpec Seat/ Upholstered Back
- UP : Fully Upholstered



## OPTIONS

**SEAT**



DuraSpec

Upholstered

**BACK**



Plastic

Upholstered

**W** Wood  
7 standard stains  
or stain to match

**WALL-SAVING**



## FINISHES

**BACK**



Black Plastic

Light Grey Plastic

White Plastic

**BACK COVER**



Black

Light Grey

White

**DURASPEC SEAT**



Black

Sterling Grey

**ARMS**



Black

Sterling Grey

**FRAME**



Select from one of our 76 standard Spectone colors

**FABRIC**



Select fabrics from one of our textile partners

For exact specifications, see specification sheet.



# Urban

DuraSpec Poly Seat and Plastic Back  
Four-point and Sled Base

## Standard Features

- 0.875" frame
- DuraSpec Poly seat and Plastic back
- DuraSpec Poly seat available in Black and Sterling Grey
- Frame in any Spectone color
- Four-point stacks up to 8 high with dolly.
- Sled Base does not stack and ships 1 per carton
- Ships 1/carton 11 cu ft, 2-4/carton 22 cu ft

## Options

- Wall-saving frame on Four-point only, add \$20 List.
- Specify back in Black RAL 9005, Light Grey RAL 7037 or White RAL 9016
- Specify back panel in Black RAL 9005, Light Grey RAL 7037 or White RAL 9016
- Polyurethane arms available in Black (B) or Sterling Grey (G)
- For Wood Back, specify and add \$87 List
- Connecting clips for ganging chairs, add \$8 List/set
- Connecting bars for a structured reconfigurable layout, add \$80 List
- Other glides may be available for an upcharge - call Customer Service to inquire



Plastic Back & Plastic Back Panel



Optional Wood Back & Plastic Back Panel



Optional Wall-saving Frame

## Urban, DuraSpec Poly Seat & Plastic Back – Four-point

MODEL	Price
1401	355
1411	355

Dimensions (inches)

seat H	18.0	seat W	18.0	arm H	27.0	total H	32.5
depth	22.0	total W	24.0	total W (no arms)	20.1		

Exceeds BIFMA Seating Durability Test to 500 lbs



1401  
With arms  
16 lbs



1411  
Without arms  
15 lbs

## Urban, DuraSpec Poly Seat & Plastic Back – Sled Base

MODEL	Price
1431	451
1441	451

Dimensions (inches)

seat H	18.0	seat W	18.0	arm H	27.0	total H	32.5
depth	22.0	total W	24.0	total W (no arms)	20.1		

Exceeds BIFMA Seating Durability Test to 500 lbs



1431  
With arms  
18 lbs



1441  
Without arms  
17 lbs

For exact specifications, see specification sheet.



# Urban

DuraSpec Poly Seat and Plastic Back  
Midsize – Four-point

## Standard Features

- 0.875" frame
- DuraSpec Poly seat and Plastic back
- DuraSpec Poly seat available in Black and Sterling Grey
- Frame in any Spectone color
- Four-point stacks up to 4 high with dolly.
- Sled base does not stack
- Ships 1-3/carton 21.24 cu ft

## Options

- Wall-saving frame on Four-point only, add \$20 List.
- Specify back in Black RAL 9005, Light Grey RAL 7037 or White RAL 9016
- Specify back panel in Black RAL 9005, Light Grey RAL 7037 or White RAL 9016
- Polyurethane arms available in Black (B) or Sterling Grey (G)
- For Wood Back, specify and add \$87 List
- Connecting clips for ganging chairs, add \$8 List/set
- Connecting bars for a structured reconfigurable layout, add \$80 List
- Other glides may be available for an upcharge - call Customer Service to inquire



## Urban, DuraSpec Poly Seat & Plastic Back – Midsize – Four-point

MODEL	Price						
<b>1404</b>	<b>568</b>						
<b>1414</b>	<b>568</b>						
Dimensions (inches)							
seat H	18.0	seat W	22.0	arm H	27.0	total H	32.5
depth	22.0	total W	27.8	total W (no arms)	24.0		

Exceeds BIFMA Seating Durability Test to 500 lbs



**1404**  
With arms  
18 lbs

**1414**  
Without arms  
17 lbs

## Urban, DuraSpec Poly Seat & Plastic Back – Midsize – Sled Base

MODEL	Price						
<b>1434</b>	<b>664</b>						
<b>1444</b>	<b>664</b>						
Dimensions (inches)							
seat H	18.0	seat W	22.0	arm H	27.0	total H	32.5
depth	22.0	total W	27.8	total W (no arms)	24.0		

Exceeds BIFMA Seating Durability Test to 500 lbs



**1434**  
With arms  
20 lbs

**1444**  
Without arms  
19 lbs

For exact specifications, see specification sheet.





# Urban

## DuraSpec Poly Seat and Plastic Back Casters

### Standard Features

- 0.875" frame
- DuraSpec Poly seat and Plastic back
- DuraSpec Poly seat available in Black and Sterling Grey
- Frame in any Spectone color
- Four-point stacks up to 8 high with dolly.
- Ships 1/carton 11 cu ft, 2-4/carton 22 cu ft

### Options

- Specify back in Black RAL 9005, Light Grey RAL 7037 or White RAL 9016
- Specify back panel in Black RAL 9005, Light Grey RAL 7037 or White RAL 9016
- Polyurethane arms available in Black (B) or Sterling Grey (G)
- For Wood Back, specify and add \$87 List
- Armless and sled base versions not available



Plastic Back  
& Plastic Back Panel



Optional Wood Back  
& Plastic Back Panel

---

## Urban, DuraSpec Poly Seat & Plastic Back – Casters



MODEL Price  
**1402 488**

#### Dimensions (inches)

seat H	18.0	seat W	18.0	arm H	27.0
total H	32.5	total W	24.0	depth	22.0

Exceeds BIFMA Seating Durability Test to 500 lbs



**1402**  
With arms  
17 lbs

For exact specifications, see specification sheet.



# Urban

## DuraSpec Poly Seat and Plastic Back Stools

### Standard Features

- 0.875" frame
- DuraSpec Poly seat and Plastic back
- DuraSpec Poly seat available in Black and Sterling Grey
- Frame in any Spectone color
- Ships 1/carton 17 cu ft

### Options

- Specify back in Black RAL 9005, Light Grey RAL 7037 or White RAL 9016
- Specify back panel in Black RAL 9005, Light Grey RAL 7037 or White RAL 9016
- Polyurethane arms available in Black (B) or Sterling Grey (G)
- For Wood Back, specify and add \$87 List
- Connecting clips for ganging chairs, add \$8 List/set
- Casters, sled base not available
- Other glides may be available for an upcharge - call Customer Service to inquire



Plastic Back  
& Plastic Back Panel



Optional Wood Back  
& Plastic Back Panel

### Urban, DuraSpec Poly Seat & Plastic Back – Stools

MODEL	Price
<b>1421</b>	<b>477</b>
<b>1425</b>	<b>477</b>

Dimensions (inches)

seat H	28.0	seat W	18.0	arm H	37.0	total H	43.5
depth	22.0	total W	24.0	total W (no arms)	20.1		

Exceeds BIFMA Seating Durability Test to 500 lbs



**1421**  
With arms  
21 lbs



**1425**  
Without arms  
20 lbs

### Urban, Midsize DuraSpec Poly Seat & Plastic Back – Stools

MODEL	Price
<b>1424</b>	<b>690</b>
<b>1426</b>	<b>690</b>

Dimensions (inches)

seat H	28.0	seat W	22.0	arm H	36.0	total H	43.5
depth	22.0	total W	27.8	total W (no arms)	24.0		

Exceeds BIFMA Seating Durability Test to 500 lbs



**1424**  
With arms  
23 lbs



**1426**  
Without arms  
22 lbs

For exact specifications, see specification sheet.



# Urban

## DuraSpec Poly Seat and Plastic Back Easy Access Hip Single Seater

### Standard Features

- 0.875" frame
- DuraSpec Poly seat and Plastic back
- DuraSpec Poly seat available in Black and Sterling Grey
- Frame in any Spectone color
- Ships 1/carton 19 cu ft

### Options

- Specify back in Black RAL 9005, Light Grey RAL 7037 or White RAL 9016
- Specify back panel in Black RAL 9005, Light Grey RAL 7037 or White RAL 9016
- Polyurethane arms available in Black (B) or Sterling Grey (G)
- For Wood Back, specify and add \$87 List
- Connecting clips for ganging chairs, add \$8 List/set
- Casters, sled base not available
- Other glides may be available for an upcharge - call Customer Service to inquire



Plastic Back  
& Plastic Back Panel



Optional Wood Back  
& Plastic Back Panel

### Urban, DuraSpec Poly Seat & Plastic Back – Easy Access Hip Single Seater



MODEL	LIST
<b>1421E</b>	<b>519</b>

Dimensions (inches)

seat H	24.0	seat W	18.0	arm H	33.0
total H	38.5	total W	24.0	depth	32.0

Exceeds BIFMA Seating Durability Test to 500 lbs



**1421E**  
With arms  
21 lbs

### Urban, DuraSpec Poly Seat & Plastic Back – Midsize Easy Access Hip Single Seater

COM 1.0 yd  
1.0 yd COM per single back

MODEL	LIST
<b>1424E</b>	<b>732</b>

Dimensions (inches)

seat H	24.0	seat W	22.0	arm H	33.0
total H	38.5	total W	27.8	depth	32.0

Exceeds BIFMA Seating Durability Test to 500 lbs



**1424E**  
With arms  
23 lbs

For exact specifications, see specification sheet.



# Urban

DuraSpec Poly Seat and Upholstered Back  
Four-point and Sled Base

## Standard Features

- 0.875" frame
- DuraSpec Poly seat and Upholstered back
- DuraSpec Poly seat available in Black and Sterling Grey
- Frame in any Spectone color
- Four-point stacks up to 8 high with dolly.
- Sled Base does not stack and ships 1 per carton
- Ships 1/carton 11 cu ft, 2-4/carton 22 cu ft

Contact Spec Customer Service to railroad fabrics (specify repeat info and yardage requirement will be provided) and for repeats greater than 5" x 5"

## Options

- Wall-saving frame on Four-point only, add \$20 List,
- Specify back panel in Black RAL 9005, Light Grey RAL 7037 or White RAL 9016
- Polyurethane arms available in Black (B) or Sterling Grey (G)
- Connecting clips for ganging chairs, add \$8 List/set
- Connecting bars for a structured reconfigurable layout, add \$80 List
- Antibacterial and antimicrobial fabrics available
- Other glides may be available for an upcharge - call Customer Service to inquire



Optional Wall-saving Frame

## Urban, DuraSpec Poly Seat & Upholstered Back – Four-point

COM 0.5 yd  
0.5 yd COM per single back

MODEL	COM	GR1	GR2	GR3	GR4	GR5	GR6
1401-UB	368	396	405	423	451	471	500
1411-UB	368	396	405	423	451	471	500

Dimensions (inches)

	seat H	18.0	seat W	18.0	arm H	27.0	total H	32.5
depth	22.0		total W	24.0	total W (no arms)	20.1		

Exceeds BIFMA Seating Durability Test to 500 lbs



1401-UB  
With arms  
16 lbs



1411-UB  
Without arms  
15 lbs

## Urban, DuraSpec Poly Seat & Upholstered Back – Sled Base

COM 0.5 yd  
0.5 yd COM per single back

MODEL	COM	GR1	GR2	GR3	GR4	GR5	GR6
1431-UB	464	492	501	519	547	567	596
1441-UB	464	492	501	519	547	567	596

Dimensions (inches)

	seat H	18.0	seat W	18.0	arm H	27.0	total H	32.5
depth	22.0		total W	24.0	total W (no arms)	20.1		

Exceeds BIFMA Seating Durability Test to 500 lb



1431-UB  
With arms  
18 lbs



1441-UB  
Without arms  
17 lbs

For exact specifications, see specification sheet.



# Urban

DuraSpec Poly Seat and Upholstered Back  
Midsize – Four-point and Sled Base

## Standard Features

- 0.875" frame
- DuraSpec Poly seat and Upholstered back
- DuraSpec Poly seat available in Black and Sterling Grey
- Frame in any Spectone color
- Four-point stacks up to 4 high with dolly
- Sled Base does not stack and ships 1 per carton
- Ships 1-3/carton 21.24 cu ft

Contact Spec Customer Service to railroad fabrics (specify repeat info and yardage requirement will be provided) and for repeats greater than 5" x 5"

## Options

- Wall-saving frame on Four-point only, add \$20 List.
- Specify back panel in Black RAL 9005, Light Grey RAL 7037 or White RAL 9016
- Polyurethane arms available in Black (B) or Sterling Grey (G)
- Connecting clips for ganging chairs, add \$8 List/set
- Connecting bars for a structured reconfigurable layout, add \$80 List
- Antibacterial and antimicrobial fabrics available
- Other glides may be available for an upcharge - call Customer Service to inquire



Optional Wall-saving Frame

## Urban, DuraSpec Poly Seat & Upholstered Back – Midsize – Four-point

COM 0.75 yd  
0.75 yd COM per single back

MODEL	COM	GR 1	GR 2	GR 3	GR 4	GR 5	GR 6
<b>1404-UB</b>	<b>589</b>	<b>643</b>	<b>661</b>	<b>698</b>	<b>753</b>	<b>795</b>	<b>851</b>
<b>1414-UB</b>	<b>589</b>	<b>643</b>	<b>661</b>	<b>698</b>	<b>753</b>	<b>795</b>	<b>851</b>

Dimensions (inches)

seat H	18.0	seat W	22.0	arm H	27.0	total H	32.5
depth	22.0	total W	27.8	total W (no arms)	24.0		

Exceeds BIFMA Seating Durability Test to 500 lbs



**1404-UB**  
With arms  
18 lbs



**1414-UB**  
Without arms  
17 lbs

## Urban, DuraSpec Poly Seat & Upholstered Back – Midsize – Sled Base

COM 0.75 yd  
0.75 yd COM per single back

MODEL	COM	GR 1	GR 2	GR 3	GR 4	GR 5	GR 6
<b>1434-UB</b>	<b>685</b>	<b>739</b>	<b>757</b>	<b>794</b>	<b>849</b>	<b>891</b>	<b>947</b>
<b>1444-UB</b>	<b>685</b>	<b>739</b>	<b>757</b>	<b>794</b>	<b>849</b>	<b>891</b>	<b>947</b>

Dimensions (inches)

seat H	18.0	seat W	22.0	arm H	27.0	total H	32.5
depth	22.0	total W	27.8	total W (no arms)	24.0		

Exceeds BIFMA Seating Durability Test to 500 lbs



**1434-UB**  
With arms  
21 lbs



**1444-UB**  
Without arms  
20 lbs

For exact specifications, see specification sheet.



# Urban

## DuraSpec Poly Seat and Upholstered Back Casters

### Standard Features

- 0.875" frame
- DuraSpec Poly seat and Upholstered back
- DuraSpec Poly seat available in Black and Sterling Grey
- Frame in any Spectone color
- Four-point stacks up to 8 high with dolly.
- Ships 1/carton 11 cu ft, 2-4/carton 22 cu ft

### Options

- Specify back panel in Black RAL 9005, Light Grey RAL 7037 or White RAL 9016
- Polyurethane arms available in Black (B) or Sterling Grey (G)
- Antibacterial and antimicrobial fabrics available
- Armless and sled base versions not available

Contact Spec Customer Service to railroad fabrics (specify repeat info and yardage requirement will be provided) and for repeats greater than 5" x 5"

---

### Urban, DuraSpec Poly Seat & Upholstered Back – Casters

COM 0.5 yd  
0.5 yd COM per single back

MODEL	COM	GR1	GR2	GR3	GR4	GR5	GR6
<b>1402-UB</b>	<b>501</b>	<b>528</b>	<b>538</b>	<b>556</b>	<b>583</b>	<b>604</b>	<b>632</b>

#### Dimensions (inches)

seat H	18.0	seat W	18.0	arm H	27.0
total H	32.5	total W	24.0	depth	22.0

Exceeds BIFMA Seating Durability Test to 500 lbs



**1402-UB**  
With arms  
17 lbs

For exact specifications, see specification sheet.



# Urban

## DuraSpec Poly Seat and Upholstered Back Stools

### Standard Features

- 0.875" frame
- DuraSpec Poly seat and Upholstered back
- DuraSpec Poly seat available in Black and Sterling Grey
- Frame in any Spectone color
- Ships 1/carton 17 cu ft

Contact Spec Customer Service to railroad fabrics (specify repeat info and yardage requirement will be provided) and for repeats greater than 5" x 5"

### Options

- Specify back panel in Black RAL 9005, Light Grey RAL 7037 or White RAL 9016
- Polyurethane arms available in Black (B) or Sterling Grey (G)
- Connecting clips for ganging chairs, add \$8 List/set
- Antibacterial and antimicrobial fabrics available
- Casters, sled base not available
- Other glides may be available for an upcharge - call Customer Service to inquire

### Urban, DuraSpec Poly Seat & Upholstered Back – Stools

COM 0.5 yd  
0.5 yd COM per single back

MODEL	COM	GR1	GR2	GR3	GR4	GR5	GR6
<b>1421-UB</b>	<b>491</b>	<b>518</b>	<b>527</b>	<b>546</b>	<b>573</b>	<b>594</b>	<b>622</b>
<b>1425-UB</b>	<b>491</b>	<b>518</b>	<b>527</b>	<b>546</b>	<b>573</b>	<b>594</b>	<b>622</b>

Dimensions (inches)

	seat H	28.0	seat W	18.0	arm H	37.0	total H	43.5
depth	22.0	total W	24.0	total W (no arms)	20.1			

Exceeds BIFMA Seating Durability Test to 500 lbs



**1421-UB**  
With arms  
21 lbs



**1425-UB**  
Without arms  
20 lbs

### Urban, DuraSpec Poly Seat & Upholstered Back – Midsize Stools

COM 0.75 yd  
0.75 yd COM per single back

MODEL	COM	GR1	GR2	GR3	GR4	GR5	GR6
<b>1424-UB</b>	<b>711</b>	<b>765</b>	<b>783</b>	<b>820</b>	<b>875</b>	<b>917</b>	<b>973</b>
<b>1426-UB</b>	<b>711</b>	<b>765</b>	<b>783</b>	<b>820</b>	<b>875</b>	<b>917</b>	<b>973</b>

Dimensions (inches)

	seat H	28.0	seat W	22.0	arm H	37.0	total H	43.5
depth	22.0	total W	27.8	total W (no arms)	24.0			

Exceeds BIFMA Seating Durability Test to 500 lbs



**1424-UB**  
With arms  
21 lbs



**1426-UB**  
Without arms  
20 lbs

For exact specifications, see specification sheet.



# Urban

DuraSpec Poly Seat and Upholstered Back  
Easy Access Hip Single Seater

## Standard Features

- 0.875" frame
- DuraSpec Poly seat and Upholstered back
- DuraSpec Poly seat available in Black and Sterling Grey
- Frame in any Spectone color
- Ships 1/carton 19 cu ft

Contact Spec Customer Service to railroad fabrics (specify repeat info and yardage requirement will be provided) and for repeats greater than 5" x 5"

## Options

- Specify back panel in Black RAL 9005, Light Grey RAL 7037 or White RAL 9016
- Polyurethane arms available in Black (B) or Sterling Grey (G)
- Connecting clips for ganging chairs, add \$8 List/set
- Antibacterial and antimicrobial fabrics available
- Casters, sled base not available
- Other glides may be available for an upcharge - call Customer Service to inquire

### Urban, DuraSpec Poly Seat & Upholstered Back – Easy Access Hip Single Seater

COM 0.5 yd  
0.5 yd COM per single back

MODEL	COM	GR1	GR2	GR3	GR4	GR5	GR6
<b>1421E-UB</b>	<b>532</b>	<b>560</b>	<b>569</b>	<b>588</b>	<b>615</b>	<b>635</b>	<b>664</b>

Dimensions (inches)

seat H	24.0	seat W	18.0	arm H	33.0
total H	38.5	total W	24.0	depth	32.0

Exceeds BIFMA Seating Durability Test to 500 lbs



**1421E-UB**  
With arms  
21 lbs

### Urban, DuraSpec Poly Seat & Upholstered Back – Midsize Easy Access Hip Single Seater

COM 0.75 yd  
0.75 yd COM per single back

MODEL	COM	GR1	GR2	GR3	GR4	GR5	GR6
<b>1424E-UB</b>	<b>753</b>	<b>807</b>	<b>825</b>	<b>862</b>	<b>917</b>	<b>959</b>	<b>1015</b>

Dimensions (inches)

seat H	24.0	seat W	22.0	arm H	33.0
total H	38.5	total W	27.8	depth	32.0

Exceeds BIFMA Seating Durability Test to 500 lbs



**1424E-UB**  
With arms  
23 lbs

For exact specifications, see specification sheet.





# Urban

**Upholstered Seat and Plastic Back**  
**Four-point and Sled Base**

## Standard Features

- 0.875" frame
- Upholstered seat and plastic back
- Frame in any Spectone color
- Four-point stacks up to 8 high with dolly
- Sled Base does not stack and ships 1 per carton
- Ships 1/carton 11 cu ft, 2-4/carton 22 cu ft

Contact Spec Customer Service to railroad fabrics (specify repeat info and yardage requirement will be provided) and for repeats greater than 5" x 5"

## Options

- Wall-saving frame on Four-point only, add \$20 List
- Specify back in Black RAL 9005, Light Grey RAL 7037 or White RAL 9016
- Specify back panel in Black RAL 9005, Light Grey RAL 7037 or White RAL 9016
- Polyurethane arms available in Black (B) or Sterling Grey (G)
- For Wood Back, specify and add \$87 List
- Connecting clips for ganging chairs, add \$8 List/set
- Connecting bars for a structured reconfigurable layout, add \$80 List
- Antibacterial and antimicrobial fabrics available
- Other glides may be available for an upcharge - call Customer Service to inquire



Plastic Back & Plastic Back Panel



Optional Wood Back & Plastic Back Panel



Optional Wall-saving Frame

## Urban, Upholstered Seat & Plastic Back – Four-point

COM 0.5 yd  
 0.5 yd COM per single seat

MODEL	COM	GR1	GR2	GR3	GR4	GR5	GR6
1401-US	380	408	417	436	463	483	512
1411-US	380	408	417	436	463	483	512

Dimensions (inches)

	seat H	18.0	seat W	18.0	arm H	27.0	total H	32.5
depth	22.0	total W	24.0	total W (no arms)	20.1			

Exceeds BIFMA Seating Durability Test to 500 lbs  
 1" extra seat foam, specify and add \$14 List



1401-US  
 With arms  
 16 lbs



1411-US  
 Without arms  
 15 lbs

## Urban, Upholstered Seat & Plastic Back – Sled Base

COM 0.5 yd  
 0.5 yd COM per single seat

MODEL	COM	GR1	GR2	GR3	GR4	GR5	GR6
1431-US	476	504	513	531	559	579	608
1441-US	476	504	513	531	559	579	608

Dimensions (inches)

	seat H	18.0	seat W	18.0	arm H	27.0	total H	32.5
depth	22.0	total W	24.0	total W (no arms)	20.1			

Exceeds BIFMA Seating Durability Test to 500 lb  
 1" extra seat foam, specify and add \$14 List



1431-US  
 With arms  
 18 lbs



1441-US  
 Without arms  
 17 lbs

For exact specifications, see specification sheet.

# Urban

**Upholstered Seat and Plastic Back**  
**Midsize – Four-point and Sled Base**

## Standard Features

- 0.875" frame
- Upholstered seat and plastic back
- Frame in any Spectone color
- Four-point stacks up to 4 high with dolly
- Sled Base does not stack and ships 1 per carton
- Ships 1-3/carton 21.24 cu ft

Contact Spec Customer Service to railroad fabrics (specify repeat info and yardage requirement will be provided) and for repeats greater than 5" x 5"

## Options

- Wall-saving frame on Four-point only, add \$20 List
- Specify back in Black RAL 9005, Light Grey RAL 7037 or White RAL 9016
- Specify back panel in Black RAL 9005, Light Grey RAL 7037 or White RAL 9016
- Polyurethane arms available in Black (B) or Sterling Grey (G)
- For Wood Back, specify and add \$87 List
- Connecting clips for ganging chairs, add \$8 List/set
- Connecting bars for a structured reconfigurable layout, add \$80 List
- Antibacterial and antimicrobial fabrics available
- Other glides may be available for an upcharge - call Customer Service to inquire



## Urban, Upholstered Seat & Plastic Back – Midsize – Four-point

COM 0.75 yd  
 0.75 yd COM per single seat

MODEL	COM	GR 1	GR 2	GR 3	GR 4	GR 5	GR 6
1404-US	552	595	610	639	683	717	762
1414-US	552	595	610	639	683	717	762

Dimensions (inches)

seat H	18.0	seat W	22.0	arm H	27.0	total H	32.5
depth	22.0	total W	27.8	total W (no arms)	24.0		

Exceeds BIFMA Seating Durability Test to 500 lbs  
 1" extra seat foam, specify and add \$21 List



## Urban, Upholstered Seat & Plastic Back – Midsize – Sled Base

COM 0.75 yd  
 0.75 yd COM per single seat

MODEL	COM	GR 1	GR 2	GR 3	GR 4	GR 5	GR 6
1434-US	648	691	706	735	779	813	858
1444-US	648	691	706	735	779	813	858

Dimensions (inches)

seat H	18.0	seat W	22.0	arm H	27.0	total H	32.5
depth	22.0	total W	27.8	total W (no arms)	24.0		

Exceeds BIFMA Seating Durability Test to 500 lbs  
 1" extra seat foam, specify and add \$21 List



For exact specifications, see specification sheet.



# Urban

**Upholstered Seat and Plastic Back  
Casters**

## Standard Features

- 0.875" frame
- Upholstered seat and plastic back
- Frame in any Spectone color
- Four-point stacks up to 8 high with dolly
- Ships 1/carton 11 cu ft, 2-4/carton 22 cu ft

*Contact Spec Customer Service to railroad fabrics (specify repeat info and yardage requirement will be provided) and for repeats greater than 5" x 5"*

## Options

- Specify back in Black RAL 9005, Light Grey RAL 7037 or White RAL 9016
- Specify back panel in Black RAL 9005, Light Grey RAL 7037 or White RAL 9016
- Polyurethane arms available in Black (B) or Sterling Grey (G)
- For Wood Back, specify and add \$87 List
- Antibacterial and antimicrobial fabrics available
- Armless and sled base versions not available



Plastic Back & Plastic Back Panel



Optional Wood Back & Plastic Back Panel

## Urban, Upholstered Seat & Plastic Back – Casters

COM 0.5 yd  
0.5 yd COM per single seat

MODEL	COM	GR1	GR2	GR3	GR4	GR5	GR6
<b>1402-US</b>	<b>513</b>	<b>541</b>	<b>550</b>	<b>568</b>	<b>596</b>	<b>616</b>	<b>645</b>

Dimensions (inches)

seat H	18.0	seat W	18.0	arm H	27.0
total H	32.5	total W	24.0	depth	22.0

Exceeds BIFMA Seating Durability Test to 500 lbs  
1" extra seat foam, specify and add \$14 List



**1402-US  
With arms  
17 lbs**

For exact specifications, see specification sheet.



# Urban

## Upholstered Seat and Plastic Back Stools

### Standard Features

- 0.875" frame
- Upholstered seat and plastic back
- Frame in any Spectone color
- Ships 1/carton 17 cu ft

Contact Spec Customer Service to railroad fabrics (specify repeat info and yardage requirement will be provided) and for repeats greater than 5" x 5"

### Options

- Specify back in Black RAL 9005, Light Grey RAL 7037 or White RAL 9016
- Specify back panel in Black RAL 9005, Light Grey RAL 7037 or White RAL 9016
- Polyurethane arms available in Black (B) or Sterling Grey (G)
- For Wood Back, specify and add \$87 List
- Connecting clips for ganging chairs, add \$8 List/set
- Antibacterial and antimicrobial fabrics available
- Casters, sled base not available
- Other glides may be available for an upcharge - call Customer Service to inquire



Plastic Back & Plastic Back Panel



Optional Wood Back & Plastic Back Panel

### Urban, Upholstered Seat & Plastic Back – Stools

COM 0.5 yd  
0.5 yd COM per single seat

MODEL	COM	GR1	GR2	GR3	GR4	GR5	GR6
<b>1421-US</b>	<b>503</b>	<b>530</b>	<b>540</b>	<b>558</b>	<b>585</b>	<b>606</b>	<b>634</b>
<b>1425-US</b>	<b>503</b>	<b>530</b>	<b>540</b>	<b>558</b>	<b>585</b>	<b>606</b>	<b>634</b>

Dimensions (inches)

seat H	28.0	seat W	18.0	arm H	37.0	total H	43.5
depth	22.0	total W	24.0	total W (no arms)	20.1		

Exceeds BIFMA Seating Durability Test to 500 lbs  
1" extra seat foam, specify and add \$14 List



**1421-US**  
With arms  
21 lbs



**1425-US**  
Without arms  
20 lbs

### Urban, Upholstered Seat & Plastic Back – Midsize Stools

COM 0.75 yd  
0.75 yd COM per single seat

MODEL	COM	GR1	GR2	GR3	GR4	GR5	GR6
<b>1424-US</b>	<b>674</b>	<b>717</b>	<b>732</b>	<b>761</b>	<b>805</b>	<b>839</b>	<b>884</b>
<b>1426-US</b>	<b>674</b>	<b>717</b>	<b>732</b>	<b>761</b>	<b>805</b>	<b>839</b>	<b>884</b>

Dimensions (inches)

seat H	28.0	seat W	22.0	arm H	37.0	total H	43.5
depth	22.0	total W	27.8	total W (no arms)	24.0		

Exceeds BIFMA Seating Durability Test to 500 lbs  
1" extra seat foam, specify and add \$21 List



**1424-US**  
With arms  
23 lbs



**1426-US**  
Without arms  
22 lbs

For exact specifications, see specification sheet.



# Urban

**Upholstered Seat and Plastic Back**  
**Easy Access Hip Single Seater**

### Standard Features

- 0.875" frame
- Upholstered seat and plastic back
- Frame in any Spectone color
- Ships 1/carton 19 cu ft

*Contact Spec Customer Service to railroad fabrics (specify repeat info and yardage requirement will be provided) and for repeats greater than 5" x 5"*

### Options

- Specify back in Black RAL 9005, Light Grey RAL 7037 or White RAL 9016
- Specify back panel in Black RAL 9005, Light Grey RAL 7037 or White RAL 9016
- Polyurethane arms available in Black (B) or Sterling Grey (G)
- For Wood Back, specify and add \$87 List
- Connecting clips for ganging chairs, add \$8 List/set
- Antibacterial and antimicrobial fabrics available
- Casters, sled base not available
- Other glides may be available for an upcharge - call Customer Service to inquire



Plastic Back & Plastic Back Panel



Optional Wood Back & Plastic Back Panel

## Urban, Upholstered Seat & Plastic Back – Easy Access Hip Single Seater

COM 0.5 yd  
 0.5 yd COM per single seat

MODEL	COM	GR1	GR2	GR3	GR4	GR5	GR6
<b>1421E-US</b>	<b>545</b>	<b>572</b>	<b>581</b>	<b>600</b>	<b>627</b>	<b>648</b>	<b>676</b>

Dimensions (inches)

seat H	24.0	seat W	18.0	arm H	33.0
total H	38.5	total W	24.0	depth	32.0

Exceeds BIFMA Seating Durability Test to 500 lbs  
 1" extra seat foam, specify and add \$14 List



**1421E-US**  
 With arms  
 21 lbs

## Urban, Upholstered Seat & Plastic Back – Midsize Easy Access Hip Single Seater

COM 0.75 yd  
 0.75 yd COM per single seat

MODEL	COM	GR1	GR2	GR3	GR4	GR5	GR6
<b>1424E-US</b>	<b>716</b>	<b>759</b>	<b>774</b>	<b>803</b>	<b>847</b>	<b>881</b>	<b>926</b>

Dimensions (inches)

seat H	24.0	seat W	22.0	arm H	33.0
total H	38.5	total W	27.8	depth	32.0

Exceeds BIFMA Seating Durability Test to 500 lbs  
 1" extra seat foam, specify and add \$21 List



**1424E-US**  
 With arms  
 23 lbs

For exact specifications, see specification sheet.

# Urban

## Upholstered Seat and Back Four-point and Sled Base

### Standard Features

- 0.875" frame
- Seat and back upholstered
- Frame in any Spectone color
- Four-point stacks up to 8 high with dolly
- Sled Base does not stack and ships 1 per carton
- Ships 1/carton 11 cu ft, 2-4/carton 22 cu ft

Contact Spec Customer Service to railroad fabrics (specify repeat info and yardage requirement will be provided) and for repeats greater than 5" x 5"

### Options

- Wall-saving frame on Four-point only, add \$20 List,
- Specify back panel in Black RAL 9005, Light Grey RAL 7037 or White RAL 9016
- Polyurethane arms available in Black (B) or Sterling Grey (G)
- Connecting clips for ganging chairs, add \$8 List/set
- Connecting bars for a structured reconfigurable layout, add \$80 List
- Antibacterial and antimicrobial fabrics available
- Different fabric on seat and back at no upcharge
- CAL 133
- Other glides may be available for an upcharge - call Customer Service to inquire



Upholstered Back & Plastic Back Panel



Optional Wall-saving Frame

### Urban, Upholstered Seat & Back – Four-point

COM 1.0 yd  
0.5 yd COM per single seat  
0.5 yd COM per single back

MODEL	COM	GR 1	GR 2	GR 3	GR 4	GR 5	GR 6
1401-UP	394	448	466	503	558	600	656
1411-UP	394	448	466	503	558	600	656

Dimensions (inches)

	seat H	18.0	seat W	18.0	arm H	27.0	total H	32.5
depth	22.0	total W	24.0	total W (no arms)	20.1			

Exceeds BIFMA Seating Durability Test to 500 lbs  
CAL 133, add \$58 List  
1" extra seat foam, specify and add \$14 List



1401-UP  
With arms  
16 lbs



1411-UP  
Without arms  
15 lbs

### Urban, Upholstered Seat & Back – Sled Base

COM 1.0 yd  
0.5 yd COM per single seat  
0.5 yd COM per single back

MODEL	COM	GR 1	GR 2	GR 3	GR 4	GR 5	GR 6
1431-UP	490	544	562	599	654	696	752
1441-UP	490	544	562	599	654	696	752

Dimensions (inches)

	seat H	18.0	seat W	18.0	arm H	27.0	total H	32.5
depth	22.0	total W	24.0	total W (no arms)	20.1			

Exceeds BIFMA Seating Durability Test to 500 lbs  
CAL 133, add \$58 List  
1" extra seat foam, specify and add \$14 List



1431-UP  
With arms  
18 lbs



1441-UP  
Without arms  
17 lbs

For exact specifications, see specification sheet.



# Urban

**Upholstered Seat and Back**  
**MidSize – Four-point and Sled Base**

## Standard Features

- 0.875" frame
- Seat and back upholstered
- Frame in any Spectone color
- Four-point stacks up to 4 high with dolly
- Sled Base does not stack and ships 1 per carton
- Ships 1-3/carton 21.24 cu ft

Contact Spec Customer Service to railroad fabrics (specify repeat info and yardage requirement will be provided) and for repeats greater than 5" x 5"

## Options

- Wall-saving frame on Four-point only, add \$20 List.
- Specify back panel in Black RAL 9005, Light Grey RAL 7037 or White RAL 9016
- Polyurethane arms available in Black (B) or Sterling Grey (G)
- Connecting clips for ganging chairs, add \$8 List/set
- Connecting bars for a structured reconfigurable layout, add \$80 List
- Antibacterial and antimicrobial fabrics available
- Different fabric on seat and back at no upcharge
- CAL 133
- Other glides may be available for an upcharge - call Customer Service to inquire



Optional Wood Back & Plastic Back Panel

Optional Wall-saving Frame

## Urban, Upholstered Seat & Back – Midsize – Four-point

COM 1.5 yd  
 0.75 yd COM per single seat  
 0.75 yd COM per single back

MODEL	COM	GR 1	GR 2	GR 3	GR 4	GR 5	GR 6
<b>1404-UP</b>	<b>571</b>	<b>668</b>	<b>701</b>	<b>767</b>	<b>866</b>	<b>942</b>	<b>1043</b>
<b>1414-UP</b>	<b>571</b>	<b>668</b>	<b>701</b>	<b>767</b>	<b>866</b>	<b>942</b>	<b>1043</b>

Dimensions (inches)

	seat H	18.0	seat W	22.0	arm H	27.0	total H	32.5
depth	22.0	total W	27.8	total W (no arms)	24.0			

Exceeds BIFMA Seating Durability Test to 500 lbs  
 CAL 133, add \$82 List  
 1" extra seat foam, specify and add \$21 List



**1404-UP**  
**With arms**  
 18 lbs



**1414-UP**  
**Without arms**  
 17 lbs

## Urban, Upholstered Seat & Back – Midsize – Sled Base

COM 1.5 yd  
 0.75 yd COM per single seat  
 0.75 yd COM per single back

MODEL	COM	GR 1	GR 2	GR 3	GR 4	GR 5	GR 6
<b>1434-UP</b>	<b>667</b>	<b>764</b>	<b>797</b>	<b>863</b>	<b>962</b>	<b>1038</b>	<b>1139</b>
<b>1444-UP</b>	<b>667</b>	<b>764</b>	<b>797</b>	<b>863</b>	<b>962</b>	<b>1038</b>	<b>1139</b>

Dimensions (inches)

	seat H	18.0	seat W	22.0	arm H	27.0	total H	32.5
depth	22.0	total W	27.8	total W (no arms)	24.0			

Exceeds BIFMA Seating Durability Test to 500 lbs  
 CAL 133, add \$82 List  
 1" extra seat foam, specify and add \$21 List



**1434-UP**  
**With arms**  
 20 lbs



**1444-UP**  
**Without arms**  
 19 lbs

For exact specifications, see specification sheet.



# Urban

## Upholstered Seat and Back Casters

### Standard Features

- 0.875" frame
- Upholstered seat and back
- Frame in any Spectone color
- Four-point stacks up to 8 high with dolly
- Ships 1/carton 11 cu ft, 2-4/carton 22 cu ft

Contact Spec Customer Service to railroad fabrics (specify repeat info and yardage requirement will be provided) and for repeats greater than 5" x 5"

### Options

- Specify back panel in Black RAL 9005, Light Grey RAL 7037 or White RAL 9016
- Polyurethane arms available in Black (B) or Sterling Grey (G)
- Antibacterial and antimicrobial fabrics available
- Different fabric on seat and back at no upcharge
- Armless and sled base versions not available
- CAL 133



Upholstered Back  
& Plastic Back Panel

---

### Urban, Upholstered Seat & Back – Casters

COM 1.0 yd  
0.5 yd COM per single seat  
0.5 yd COM per single back

MODEL	COM	GR1	GR2	GR3	GR4	GR5	GR6
<b>1402-UP</b>	<b>526</b>	<b>580</b>	<b>599</b>	<b>635</b>	<b>691</b>	<b>732</b>	<b>788</b>

Dimensions (inches)

seat H	18.0	seat W	18.0	arm H	27.0
total H	32.5	total W	24.0	depth	22.0

Exceeds BIFMA Seating Durability Test to 500 lbs  
CAL 133, add \$58 List  
1" extra seat foam, specify and add \$14 List



**1402-UP**  
With arms  
17 lbs

For exact specifications, see specification sheet.





# Urban

## Upholstered Seat and Back Stools

### Standard Features

- 0.875" frame
- Upholstered seat and back
- Frame in any Spectone color
- Ships 1/carton 17 cu ft

Contact Spec Customer Service to railroad fabrics (specify repeat info and yardage requirement will be provided) and for repeats greater than 5" x 5"

### Options

- Specify back panel in Black RAL 9005, Light Grey RAL 7037 or White RAL 9016
- Polyurethane arms available in Black (B) or Sterling Grey (G)
- Antibacterial and antimicrobial fabrics available
- Different fabric on seat and back at no upcharge
- Connecting clips for ganging chairs, add \$8 List/set
- Casters, sled base not available
- CAL 133
- Other glides may be available for an upcharge - call Customer Service to inquire



Upholstered Back & Plastic Back Panel



1421-UP  
With arms  
21 lbs



1425-UP  
Without arms  
20 lbs

### Urban, Upholstered Seat & Back – Stools

COM 1.0 yd  
0.5 yd COM per single seat  
0.5 yd COM per single back

MODEL	COM	GR1	GR2	GR3	GR4	GR5	GR6
1421-UP	516	570	589	625	680	722	778
1425-UP	516	570	589	625	680	722	778

Dimensions (inches)

seat H	28.0	seat W	18.0	arm H	37.0	total H	43.5
depth	22.0	total W	24.0	total W (no arms)	20.1		

Exceeds BIFMA Seating Durability Test to 500 lbs  
CAL 133, add \$58 List  
1" extra seat foam, specify and add \$14 List

### Urban, Upholstered Seat & Back – Midsize Stools

COM 1.5 yd  
0.75 yd COM per single seat  
0.75 yd COM per single back

MODEL	COM	GR1	GR2	GR3	GR4	GR5	GR6
1424-UP	693	790	823	889	988	1064	1165
1426-UP	693	790	823	889	988	1064	1165

Dimensions (inches)

seat H	28.0	seat W	22.0	arm H	37.0	total H	43.5
depth	22.0	total W	27.8	total W (no arms)	24.0		

Exceeds BIFMA Seating Durability Test to 500 lbs  
CAL 133, add \$82 List  
1" extra seat foam, specify and add \$21 List



1424-UP  
With arms  
23 lbs



1426-UP  
Without arms  
22 lbs

For exact specifications, see specification sheet.



# Urban

## Upholstered Seat and Back Easy Access Hip Single Seater

### Standard Features

- 0.875" frame
- Upholstered seat and back
- Frame in any Spectone color
- Ships 1/carton 19 cu ft

Contact Spec Customer Service to railroad fabrics (specify repeat info and yardage requirement will be provided) and for repeats greater than 5" x 5"

### Options

- Specify back panel in Black RAL 9005, Light Grey RAL 7037 or White RAL 9016
- Polyurethane arms available in Black (B) or Sterling Grey (G)
- Antibacterial and antimicrobial fabrics available
- Different fabric on seat and back at no upcharge
- Connecting clips for ganging chairs, add \$8 List/set
- Casters, sled base not available
- CAL 133
- Other glides may be available for an upcharge - call Customer Service to inquire



Upholstered Back & Plastic Back Panel

### Urban, Upholstered Seat & Back – Easy Access Hip Single Seater

COM 1.0 yd  
0.5 yd COM per single seat  
0.5 yd COM per single back

MODEL	COM	GR1	GR2	GR3	GR4	GR5	GR6
1421E-UP	558	612	630	667	722	764	820

Dimensions (inches)

seat H	24.0	seat W	18.0	arm H	33.0
total H	38.5	total W	24.0	depth	32.0

Exceeds BIFMA Seating Durability Test to 500 lbs  
CAL 133, add \$58 List  
1" extra seat foam, specify and add \$14 List



1421E-UP  
With arms  
21 lbs

### Urban, Upholstered Seat & Back – Midsize Easy Access Hip Single Seater

COM 1.5 yd  
0.75 yd COM per single seat  
0.75 yd COM per single back

MODEL	COM	GR1	GR2	GR3	GR4	GR5	GR6
1424E-UP	735	832	865	931	1030	1106	1207

Dimensions (inches)

seat H	24.0	seat W	18.0	arm H	33.0
total H	38.5	total W	24.0	depth	32.0

Exceeds BIFMA Seating Durability Test to 500 lbs  
CAL 133, add \$82 List  
1" extra seat foam, specify and add \$21 List



1424E-UP  
With arms  
23 lbs

For exact specifications, see specification sheet.



# Urban Wood Back

## Seat Back Options

### Seat Back Designs

- Backs standard in Natural maple in any of 7 standard stains or stain-to-match at no upcharge

### Custom Seat Back Cut-out

- A one time set up charge of \$260 list applies
- Design should fit within a 5" x 5" space (due to contour of back)
- Shape will be mirrored from the front of the chair

Pick a back design and add the name of the cutout following the model number, e.g. 1401Cityscape

### Custom Seat Back Engravings and Vinyl Decals

- For quantities over 25, add an upcharge of \$53 List/chair
- For quantities under 25, add an upcharge of \$53 List/chair, plus a \$260 List set up fee **per order**

**Engraving:** Please note that inconsistencies in the wood may show after the engraving is completed. When choosing the raw wood, we take extra care to select backs that are similar in graining and color, however, no guarantee can be made. We recommend that an engraved image be stained a darker color to hide possible inconsistencies.

## Urban – Wood Back Designs



Skyscraper



Cityscape



City Block

### Custom Seat Back Cut-out



### Custom Seat Back Engraving



### Custom Seat Back Vinyl Decals\*



\* Available up to 4"x4"  
Maximum of 4 colors per decal  
Vector based files required

For exact specifications, see specification sheet.



# Urban

## Dolly

### Standard Features

- Black finish only
- 2" black swivel casters
- Standard Dolly stacks 10 chairs
- Ships 1/carton 17 cu ft

### Options

- Please specify if dolly is for chairs with wall-saving frame

---

### Urban – Dolly



DESCRIPTION	MODEL	PRICE
<b>Standard</b>	<b>1499</b>	<b>343</b>
<b>Midsize</b>	<b>1499M</b>	<b>491</b>

#### Dimensions (inches)

<b>Standard</b>	
height	36.5
width	21.0
depth	31.0

---



**1899**  
**Standard**  
18 lbs

For exact specifications, see specification sheet.



# Urban

## Connected and Tables

### To order connected Urban Chairs

- Select and price the Urban chair required for your configuration
- Select and price the corner, spacer and end tables required
- Add Urban connecting bars (between chairs only)
- Do not add connecting bars for tables (they are part of the table)
- For quick takedown or reconfiguration, use connecting clips (\$8 List/set) on chairs rather than connecting bars
- Send a drawing with your order or call Spec for assistance

### Urban Tables

- Table top is 3/4" thick
- Self Edge, 2mm Bio or PVC (flat only). 2mm Bio and PVC edge have a choice of 38 colors to match frame color
- Laminate tops available in any Arborite, Formica, Nevamar, Pionite or Wilsonart standard finish

*Connecting bars and tables can be retrofitted, allowing you to change configurations later or create new configurations from your present Urban chairs.*

*Connecting bars can be added to any Urban chair.*

*Connecting bars and table frame bars are finished in the same color as the color of the chair frames*

*Connecting bars are fastened to the underside of the Urban chair frame at the front and back*



### Urban – Connected and Tables



DESCRIPTION	Corner Table	Spacer Table	Mini Spacer Table	End Table*	Connecting Bars
MODEL	14RC	14ST	14MT	14ET	14CON
DIMENSIONS (inches)	25 x 25	17 x 17	4.5 x 14.5	17 x 17	N/A
PRICE	<b>330</b>	<b>226</b>	<b>135</b>	<b>235</b>	<b>80</b>

\*End table is handed, provide layout

For exact specifications, see specification sheet.

## 2000 SERIES LOUNGE SEATING – Layouts



### Description

- A popular choice for healthcare and institutional applications, 2000 Series combines great looks and comfort, with durability to meet real life demands.
- Available in one, two or three seaters as freestanding or connected.
- Your layout possibilities are unlimited with spacer, radius and corner tables – for both standard and bariatric seating in virtually any combination.
- Standard seat width is 22". Bariatric separate seat and back is a 30" wide seat and is load tested to 750 lbs. Cannot be connected to other bariatric seats.
- Zipper removable seats and backs are standard on split back designs.
- All models offer a choice of no center arms or half arm.
- Option of one piece or separate seat and back.
- Standard in 1.5" tube.
- Foam formulated to meet California Bulletin 133 standards is available.
- Please send a drawing of the configuration you require with your order.
- Optional floor mounting is available.
- For fabrics you wish railroaded or repeats larger than 5" x 5", please contact the factory with repeat information and yardage requirement will be provided.

### LAYOUTS AND DIMENSIONS

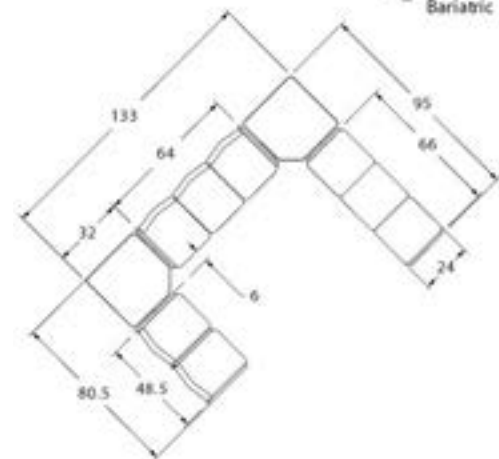
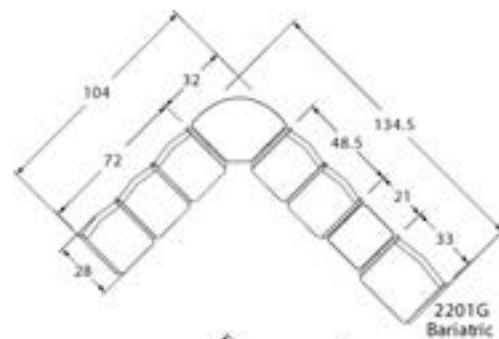



# 2000 SERIES



## PLACING AN ORDER IS EASY

### PRODUCT CODE

2201C

#### Series

22 : 2000 Series

#### Arm/Other

- 0 : Outside Arm
- 1 : Half Arm
- 3 : Easy Access Hip Chair

#### Number of Seats

- 1 : Single Seater
- 2 : Two Seater
- 3 : Three Seater

#### Chair Type

- C : One Piece Seat and Back
- CS : Seperate Seat and Back
- G : Bariatric



### OPTIONS

One-Piece Seat and Back

Separate Seat and Back



### FINISHES

#### FRAME



Select from one of our 76 standard Spectone colors

#### FABRIC



Select fabrics from one of our textile partners



## 2000 Series Lounge Seating – Four-point

One Piece Single Seater with arms

### Standard Features

- One piece seat and back
- Fully welded 1.5" frame
- Frame in any Spectone color
- Glides
- Use in connected layouts at no upcharge
- Ships assembled as 1, 2 or 3 seaters
- Ships 1/carton 17 cu ft

### Options

- Connected and freestanding tables
- Antibacterial and antimicrobial fabrics available
- CAL 133

Contact Spec Customer Service to railroad fabrics (specify repeat info and yardage requirement will be provided) and for repeats greater than 5" x 5"



### One Piece Single Seater with arms – Four-point

COM 1.75 yds  
1.75 yd COM per single seat and back

MODEL	COM	GR 1	GR 2	GR 3	GR 4	GR 5	GR 6
<b>2201C</b>	<b>634</b>	<b>716</b>	<b>743</b>	<b>798</b>	<b>881</b>	<b>944</b>	<b>1028</b>

#### Dimensions (inches)

seat H	18.0	seat W	22.0	arm H	26.0
total H	35.0	total W	25.0	depth	26.5

Exceeds BIFMA Seating Durability Test to 500 lbs per chair  
CAL 133, add \$99 List per chair



**2201C**  
38 lbs





## 2000 Series Lounge Seating – Four-point

One Piece Two and Three Seaters with outside arms

### Standard Features

- One piece seat and back
- Fully welded 1.5" frame
- Frame in any Spectone color
- Glides
- Use in connected layouts at no upcharge
- Ships assembled as 1, 2 or 3 seaters
- Ships 1/carton 28 cu ft (2 seater), 1/carton 42 cu ft (3 seater)

### Options

- Connected and freestanding tables
- Antibacterial and antimicrobial fabrics available
- CAL 133

Contact Spec Customer Service to railroad fabrics (specify repeat info and yardage requirement will be provided) and for repeats greater than 5" x 5"

---

### One Piece Two Seater with outside arms – Four-point

COM 3.5 yds  
1.75 yd COM per single seat and back

MODEL	COM	GR 1	GR 2	GR 3	GR 4	GR 5	GR 6
<b>2202C</b>	<b>1162</b>	<b>1328</b>	<b>1383</b>	<b>1494</b>	<b>1659</b>	<b>1785</b>	<b>1951</b>

Dimensions (inches)

seat H	18.0	seat W	22.0	arm H	26.0
total H	35.0	total W	47.0	depth	26.5

Exceeds BIFMA Seating Durability Test to 750 lbs per two seater  
CAL 133, add \$198 List per two seater



**2202C**  
68 lbs

---

### One Piece Three Seater with outside arms – Four-point

COM 5.25 yds  
1.75 yd COM per single seat and back

MODEL	COM	GR 1	GR 2	GR 3	GR 4	GR 5	GR 6
<b>2203C</b>	<b>1711</b>	<b>1959</b>	<b>2041</b>	<b>2206</b>	<b>2455</b>	<b>2645</b>	<b>2892</b>

Dimensions (inches)

seat H	18.0	seat W	22.0	arm H	26.0
total H	35.0	total W	69.0	depth	26.5

Exceeds BIFMA Seating Durability Test to 1000 lbs per three seater  
CAL 133, add \$297 List per three seater



**2203C**  
98 lbs



## 2000 Series Lounge Seating – Four-point

One Piece Two and Three Seaters with half arms

### Standard Features

- One piece seat and back
- Fully welded 1.5" frame
- Frame in any Spectone color
- Glides
- Use in connected layouts at no upcharge
- Ships assembled as 1, 2 or 3 seaters
- Ships 1/carton 28 cu ft (2 seater), 1/carton 42 cu ft (3 seater)

### Options

- Connected and freestanding tables
- Antibacterial and antimicrobial fabrics available
- CAL 133

Contact Spec Customer Service to railroad fabrics (specify repeat info and yardage requirement will be provided) and for repeats greater than 5" x 5"



### One Piece Two Seater with half arms – Four-point

COM 3.5 yds  
1.75 yd COM per single seat and back

MODEL	COM	GR 1	GR 2	GR 3	GR 4	GR 5	GR 6
<b>2212C</b>	<b>1266</b>	<b>1433</b>	<b>1487</b>	<b>1597</b>	<b>1763</b>	<b>1889</b>	<b>2053</b>

#### Dimensions (inches)

seat H	18.0	seat W	22.0	arm H	26.0
total H	35.0	total W	48.5	depth	26.5

Exceeds BIFMA Seating Durability Test to 750 lbs per two seater  
CAL 133, add \$198 List per two seater



**2212C**  
72 lbs

### One Piece Three Seater with half arms – Four-point

COM 5.25 yds  
1.75 yd COM per single seat and back

MODEL	COM	GR 1	GR 2	GR 3	GR 4	GR 5	GR 6
<b>2213C</b>	<b>1897</b>	<b>2147</b>	<b>2230</b>	<b>2395</b>	<b>2645</b>	<b>2833</b>	<b>3081</b>

#### Dimensions (inches)

seat H	18.0	seat W	22.0	arm H	26.0
total H	35.0	total W	72.0	depth	26.5

Exceeds BIFMA Seating Durability Test to 1000 lbs per three seater  
CAL 133, add \$297 List per three seater



**2213C**  
99 lbs



## 2000 Series Lounge Seating

One Piece Easy Access Hip Single Seater with arms

### Standard Features

- One piece seat and back
- Fully welded 1.5" frame
- Frame in any Spectone color
- Glides
- 24" seat height, no seat pitch (level)
- Footrest which assists entering/exiting chair
- Available only as four-point
- Ships assembled
- Ships 1/carton 19 cu ft

### Options

- Antibacterial and antimicrobial fabrics available
- CAL 133

Contact Spec Customer Service to railroad fabrics (specify repeat info and yardage requirement will be provided) and for repeats greater than 5" x 5"



---

### One Piece Easy Access Hip Single Seater with arms

---

COM 1.75 yds  
1.75 yd COM per single seat and back

MODEL	COM	GR 1	GR 2	GR 3	GR 4	GR 5	GR 6
<b>2231C</b>	<b>728</b>	<b>810</b>	<b>837</b>	<b>893</b>	<b>975</b>	<b>1037</b>	<b>1122</b>

Dimensions (inches)

seat H	24.0	seat W	22.0	arm H	30.5
total H	38.0	total W	25.0	depth	26.5

Exceeds BIFMA Seating Durability Test to 500 lbs per chair  
CAL 133, add \$99 List per chair



**2231C**  
45 lbs



## 2000 Series Lounge Seating

Separate Seat and Back Single Seater with arms – Four-point

### Standard Features

- Separate seat and back
- Fully welded 1.5" frame
- Frame in any Spectone color
- Glides
- Zippered removable covers
- Use in connected layouts at no upcharge
- Ships assembled as 1, 2 or 3 seaters
- Ships 1/carton 17 cu ft

### Options

- Connected and freestanding tables
- Antibacterial and antimicrobial fabrics available
- Different fabric on seat and back at no upcharge
- CAL 133

Contact Spec Customer Service to railroad fabrics (specify repeat info and yardage requirement will be provided) and for repeats greater than 5" x 5"



### Separate Seat and Back Single Seater with arms – Four-point

COM 1.75 yds  
 1.0 yd COM per single seat  
 0.75 yd COM per single back

MODEL	COM	GR 1	GR 2	GR 3	GR 4	GR 5	GR 6
<b>2201CS</b>	<b>820</b>	<b>902</b>	<b>931</b>	<b>986</b>	<b>1068</b>	<b>1131</b>	<b>1213</b>

Dimensions (inches)

seat H	18.0	seat W	22.0	arm H	26.0
total H	35.0	total W	25.0	depth	26.5

Exceeds BIFMA Seating Durability Test to 500 lbs per chair  
 CAL 133, add \$99 List per chair



**2201CS**  
38 lbs



## 2000 Series Lounge Seating

Separate Seat and Back Two and Three Seaters with outside arms – Four-point

### Standard Features

- Separate seat and back
- Fully welded 1.5" frame
- Frame in any Spectone color
- Glides
- Zippered removable covers
- Use in connected layouts at no upcharge
- Ships assembled as 1, 2 or 3 seaters
- Ships 1/carton 28 cu ft (2 seater),  
1/carton 42 cu ft (3 seater)

### Options

- Connected and freestanding tables
- Antibacterial and antimicrobial fabrics available
- Different fabric on seat and back at no upcharge
- CAL 133

Contact Spec Customer Service to railroad fabrics (specify repeat info and yardage requirement will be provided) and for repeats greater than 5" x 5"

---

### Separate Seat and Back Two Seater with outside arms – Four-point

COM 3.5 yds  
1.0 yd COM per single seat  
0.75 yd COM per single back

MODEL	COM	GR 1	GR 2	GR 3	GR 4	GR 5	GR 6
<b>2202CS</b>	<b>1468</b>	<b>1634</b>	<b>1689</b>	<b>1799</b>	<b>1966</b>	<b>2091</b>	<b>2256</b>

Dimensions (inches)

seat H	18.0	seat W	22.0	arm H	26.0
total H	35.0	total W	47.0	depth	26.5

Exceeds BIFMA Seating Durability Test to 750 lbs per two seater  
CAL 133, add \$198 List per two seater



**2202CS**  
68 lbs

---

### Separate Seat and Back Three Seater with outside arms – Four-point

COM 5.25 yds  
1.0 yd COM per single seat  
0.75 yd COM per single back

MODEL	COM	GR 1	GR 2	GR 3	GR 4	GR 5	GR 6
<b>2203CS</b>	<b>2176</b>	<b>2424</b>	<b>2506</b>	<b>2670</b>	<b>2920</b>	<b>3110</b>	<b>3358</b>

Dimensions (inches)

seat H	18.0	seat W	22.0	arm H	26.0
total H	35.0	total W	69.0	depth	26.5

Exceeds BIFMA Seating Durability Test to 1000 lbs per three seater  
CAL 133, add \$297 List per three seater



**2203CS**  
98 lbs



## 2000 Series Lounge Seating

Separate Seat and Back Two and Three Seaters with half arms – Four-point

### Standard Features

- Separate seat and back
- Fully welded 1.5" frame
- Frame in any Spectone color
- Glides
- Zippered removable covers
- Use in connected layouts at no upcharge
- Ships assembled as 1, 2 or 3 seaters
- Ships 1/carton 28 cu ft (2 seater),  
1/carton 42 cu ft (3 seater)

### Options

- Connected and freestanding tables
- Antibacterial and antimicrobial fabrics available
- Different fabric on seat and back at no upcharge
- CAL 133

Contact Spec Customer Service to railroad fabrics (specify repeat info and yardage requirement will be provided) and for repeats greater than 5" x 5"

---

### Separate Seat and Back Two Seater with half arms – Four-point

COM 3.5 yds  
1.0 yd COM per single seat  
0.75 yd COM per single back

MODEL	COM	GR 1	GR 2	GR 3	GR 4	GR 5	GR 6
<b>2212CS</b>	<b>1640</b>	<b>1805</b>	<b>1859</b>	<b>1970</b>	<b>2136</b>	<b>2261</b>	<b>2428</b>

Dimensions (inches)

seat H	18.0	seat W	22.0	arm H	26.0
total H	35.0	total W	48.5	depth	26.5

Exceeds BIFMA Seating Durability Test to 750 lbs per two seater  
CAL 133, add \$198 List per two seater



**2212CS**  
72 lbs

---

### Separate Seat and Back Three Seater with half arms – Four-point

COM 5.25 yds  
1.0 yd COM per single seat  
0.75 yd COM per single back

MODEL	COM	GR 1	GR 2	GR 3	GR 4	GR 5	GR 6
<b>2213CS</b>	<b>2460</b>	<b>2707</b>	<b>2791</b>	<b>2956</b>	<b>3203</b>	<b>3393</b>	<b>3641</b>

Dimensions (inches)

seat H	18.0	seat W	22.0	arm H	26.0
total H	35.0	total W	72.0	depth	26.5

Exceeds BIFMA Seating Durability Test to 1000 lbs per three seater  
CAL 133, add \$297 List per three seater



**2213CS**  
99 lbs



## 2000 Series Lounge Seating

Separate Seat and Back Bariatric Single Seater with arms

### Standard Features

- Separate seat and back
- Fully welded 1.5" frame
- Frame in any Spectone color
- Glides
- Zippered removable covers
- Use in connected layouts at no upcharge
- Available only as separate seat and back
- Available only as four-point
- Cannot connect bariatric seating to bariatric seating
- Ships assembled as 1, 2 or 3 seaters
- Ships 1/carton 22 cu ft

### Options

- Connected and freestanding tables
- Antibacterial and antimicrobial fabrics available
- Different fabric on seat and back at no upcharge
- CAL 133

Contact Spec Customer Service to railroad fabrics (specify repeat info and yardage requirement will be provided) and for repeats greater than 5" x 5"



### Separate Seat and Back Bariatric Single Seater with arms

COM 3.0 yds  
 1.5 yd COM per single seat  
 1.5 yd COM per single back

MODEL	COM	GR 1	GR 2	GR 3	GR 4	GR 5	GR 6
<b>2201G</b>	<b>1050</b>	<b>1202</b>	<b>1252</b>	<b>1353</b>	<b>1506</b>	<b>1621</b>	<b>1773</b>

Dimensions (inches)

seat H	18.0	seat W	30.0	arm H	26.0
total H	35.0	total W	33.0	depth	26.5

Exceeds BIFMA Seating Durability Test to 750 lbs per chair  
 CAL 133, add \$123 List per chair



**2201G**  
48 lbs



## 2000 Series Lounge Seating

Separate Seat and Back Easy Access Hip Single Seater with arms

### Standard Features

- Separate seat and back
- Fully welded 1.5" frame
- Frame in any Spectone color
- Glides
- Zippered removable covers
- 24" seat height, no seat pitch (level)
- Footrest which assists entering/exiting chair
- Available only as four-point
- Ships assembled
- Ships 1/carton 19 cu ft

### Options

- Antibacterial and antimicrobial fabrics available
- Different fabric on seat and back at no upcharge
- CAL 133

Contact Spec Customer Service to railroad fabrics (specify repeat info and yardage requirement will be provided) and for repeats greater than 5" x 5"



### Separate Seat and Back Easy Access Hip Single Seater with arms

COM 1.75 yds  
 1.0 yd COM per single seat  
 0.75 yd COM per single back

MODEL	COM	GR 1	GR 2	GR 3	GR 4	GR 5	GR 6
<b>2231CS</b>	<b>914</b>	<b>996</b>	<b>1025</b>	<b>1080</b>	<b>1161</b>	<b>1225</b>	<b>1307</b>

Dimensions (inches)

seat H	24.0	seat W	22.0	arm H	30.25
total H	38.0	total W	25.0	depth	26.5

Exceeds BIFMA Seating Durability Test to 500 lbs per chair  
 CAL 133, add \$99 List per chair



**2231CS**  
45 lbs





## 2000 Series Lounge Seating

### Freestanding Lounge Tables

### Corner and Spacer Connecting Tables

#### Standard Features

- Tops in laminate or veneer
- Laminate tops in any standard Arborite, Formica, Nevamar, Pionite or Wilsonart matte finish
- Connecting table tops available with PVC Flat edge, Self edge or hardwood (HB) edge
- Veneers and hardwood edges stains are standard in Cherry, Mahogany, Maple, Oak, Chocolate, Pecan and Walnut or stain-to-match at no upcharge
- Fully welded 1.5" frame
- Frame in any Spectone color
- Glides
- Tops utilize Nu Green earth friendly core
- 18" height

#### Options

- Non-standard laminates, contact Spec for pricing
- Custom size spacer tables for restricted spaces
- Other sizes may be available

*Radius Corner Tables are recommended for open areas*



### Corner and Spacer Connecting Tables

Model	Laminate PVC/Self Edge	Weight	Cu.Ft.
22RC/23RC 32 x 32 <i>Radius Corner Table</i>	<b>644</b>	31	2
22SC/23SC 32 x 32 <i>Square Corner Table</i>	<b>644</b>	32	2
22TC45/23TC45 19 x 23 <i>45 degree Corner Table</i>	<b>496</b>	26	2
22ST/23ST 21 x 24 <i>Spacer or End Table</i>	<b>496</b>	21	2

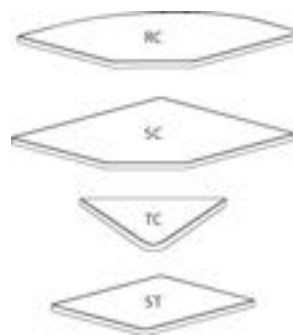



# TABLES



# ACUTE TABLES

BACK TO CONTENTS



PLACING AN ORDER IS EASY

## PRODUCT CODE

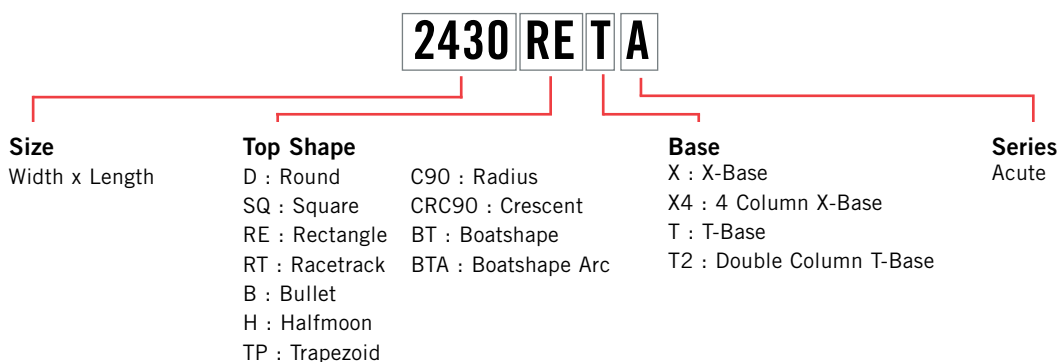

## OPTIONS

### FLIP TOP



### CASTERS



### FOLDING



## FINISHES

### LAMINATE



Select laminate from our virtually unlimited laminate options

### VENEER

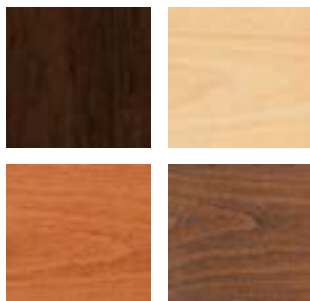

Select from one of our 7 standard wood stains or stain-to-match at no upcharge

### BASE



Select from one of our 76 standard Spectone colors

### EDGE



2MM

PVC

Hard Wood

Check out our website for a complete list of edge profiles.



# ACUTE GENERAL PURPOSE TABLES

BACK TO CONTENTS

MODEL	BASES		TOP SPECIFICATIONS						OPTIONS				LBS
	Code	Qty.	For Laminate Top			For Veneer Top			FLIP TOP (FT)	FOLD (FL)	CASTERS (LC)	WHEELS (WB)	
			SE PVF PVB 2MM	HF HB	HBV HBVR HBG	HF2 HB2 HKN4 HKNR4 HBG2	HF HB HBV HBVR HBG	HF2 HB2 HKN4 HKNR4 HBG2					
<i>Round</i>													
24D	XA	1	476	805	839	939	992	1095	141	-	84	-	37
30D	XA	1	571	895	939	1138	1087	1238	141	-	84	-	47
36D	XA	1	661	1132	1214	1377	1427	1636	141	-	84	-	58
42D	XA	1	922	1449	1563	1805	1830	2116	141	-	84	-	72
	X4A	1	1101	1628	1742	1984	2009	2295	-	-	84	-	87
48D	XA	1	943	1651	1775	1895	2329	2697	141	-	84	-	88
	X4A	1	1122	1830	1954	2074	2508	2876	-	-	84	-	103
54D	X4A	1	1388	2431	2623	2807	3023	3495	-	-	-	-	121
60D	X4A	1	1431	2616	2821	2976	3604	4191	-	-	-	-	140
<i>Square</i>													
24 x 24SQ	XA	1	504	683	717	779	824	978	141	-	84	-	37
30 x 30SQ	XA	1	602	732	779	943	884	1095	141	-	84	-	47
36 x 36SQ	XA	1	679	883	939	1132	1138	1322	141	-	84	-	58
42 x 42SQ	XA	1	1077	1372	1463	1554	1617	1868	282	-	-	-	92
	X4A	1	1115	1410	1501	1592	1655	1906	-	-	84	-	87
48 x 48SQ	X4A	1	1256	1515	1611	1653	2000	2322	-	-	84	-	103
54 x 54SQ	X4A	1	1390	1962	2112	2286	2381	2799	-	-	-	-	121
60 x 60SQ	X4A	1	1418	2059	2218	2394	2819	3325	-	-	-	-	140



30D-XA

42D-X4A

### STANDARD FEATURES

- Laminate tops available in any standard Wilsonart, Nevamar, Formica, Arborite or Pionite matte finish offerings. For other laminate please contact the factory for pricing.
- Veneers and hardwood edges are standard in Oak, Maple, Cherry, Pecan, Walnut, Mahogany and Chocolate.
- 7 veneer and hardwood edge stains are standard. Stain-to-match available at no upcharge.
- Standard table height 29".
- All bases are standard with floor leveling glides.

### OPTIONS

- Custom heights available.

### HOW TO ORDER

1. Select Model
2. Select Base
3. Select Edge Style
4. Select Options
5. Select Top Finish
6. Select Edge Finish
7. Select Base Finish

Example: 24D - XA - PVF -





# ACUTE GENERAL PURPOSE TABLES

BACK TO CONTENTS

MODEL	BASES		TOP SPECIFICATIONS						OPTIONS				LBS
	Code	Qty.	For Laminate Top			For Veneer Top			FLIP TOP (FT)	FOLD (FL)	CASTERS (LC)	WHEELS (WB)	
			SE PVF PVB 2MM	HF HB	HBV HBVR HBG	HF2 HB2 HKN4 HBG2	HF HB HBV HBG	HF2 HB2 HKN4 HBG2					
<i>Rectangle</i>													
24 x 30RE	XA	1	591	713	757	820	869	988	141	-	-	-	46
	TA	2	693	815	859	922	971	1090	282	-	84	-	54
24 x 36RE	XA	1	591	713	757	820	869	988	141	-	-	-	46
	TA	2	693	815	859	922	971	1090	282	-	84	-	54
24 x 42RE	TA	2	754	950	1001	1093	1149	1315	282	-	84	-	62
24 x 48RE	TA	2	754	950	1001	1093	1149	1315	282	-	84	-	62
24 x 54RE	TA	2	809	1095	1160	1266	1345	1548	282	-	84	-	70
24 x 60RE	TA	2	809	1095	1160	1266	1345	1548	282	273	84	-	70
24 x 66RE	TA	2	945	1289	1369	1498	1582	1831	282	273	84	-	79
24 x 72RE	TA	2	945	1289	1369	1498	1582	1831	282	273	84	-	79
30 x 36RE	XA	1	679	820	870	950	1008	1152	141	-	-	-	52
	TA	2	781	922	972	1052	1110	1254	282	-	84	-	60
30 x 42RE	XA	1	698	967	1029	1135	1213	1415	141	-	-	-	62
	TA	2	800	1069	1131	1237	1315	1517	282	-	84	-	70
30 x 48RE	XA	1	698	967	1029	1135	1213	1415	141	-	-	-	62
	TA	2	800	1069	1131	1237	1315	1517	282	-	84	-	70
30 x 54RE	TA	2	855	1222	1302	1453	1543	1796	282	273	84	-	81
30 x 60RE	TA	2	855	1222	1302	1453	1543	1796	282	273	84	-	81
30 x 66RE	TA	2	1018	1314	1411	1565	1652	1932	282	273	84	-	91
30 x 72RE	TA	2	1070	1457	1555	1753	1856	2163	282	273	84	-	91



30D-XA

2448RE-TA

### STANDARD FEATURES

- Laminate tops available in any standard Wilsonart, Nevamar, Formica, Arborite or Pionite matte finish offerings. For other laminate please contact the factory for pricing.
- Veneers and hardwood edges are standard in Oak, Maple, Cherry, Pecan, Walnut, Mahogany and Chocolate.
- 7 veneer and hardwood edge stains are standard. Stain-to-match available at no upcharge.
- Standard table height 29".
- All bases are standard with floor leveling glides.

### OPTIONS

- Custom heights available.

### HOW TO ORDER

1. Select Model
2. Select Base
3. Select Edge Style
4. Select Options
5. Select Top Finish
6. Select Edge Finish
7. Select Base Finish

**Example:** 2430RE - XA - PVF -





# ACUTE GENERAL PURPOSE TABLES

BACK TO CONTENTS

MODEL	BASES		TOP SPECIFICATIONS						OPTIONS				LBS
	Code	Qty.	For Laminate Top			For Veneer Top			FLIP TOP (FT)	FOLD (FL)	CASTERS (LC)	WHEELS (WB)	
			SE PVF PVB 2MM	HF HB	HBV HBVR HBG	HF2 HB2 HKN4 HKNR4 HBG2	HF HB HBV HBG	HF2 HB2 HKN4 HKNR4 HBG2					
<i>Rectangle</i>													
30 x 78RE	TA	2	1280	1622	1738	1968	2089	2442	282	273	84	-	102
30 x 84RE	TA	2	1280	1622	1738	1968	2089	2442	282	273	84	-	102
30 x 90RE	TA	2	1299	1829	1968	2181	2324	2726	-	273	84	-	112
30 x 96RE	TA	2	1299	1829	1968	2181	2324	2726	-	273	84	-	112
36 x 42RE	TA	2	893	1095	1173	1279	1360	1572	282	-	84	-	79
36 x 48RE	TA	2	917	1202	1285	1411	1495	1742	282	-	84	-	79
36 x 60RE	TA	2	1007	1404	1505	1666	1768	2077	282	273	84	-	91
36 x 66RE	TA	2	1089	1501	1617	1794	1905	2245	282	273	84	-	104
	T2A	2	1275	1687	1803	1980	2091	2431	-	547	84	-	124
36 x 72RE	TA	2	1125	1555	1666	1922	2045	2413	282	273	84	-	104
	T2A	2	1311	1741	1852	2108	2231	2599	-	547	84	-	124
36 x 78RE	TA	2	1438	1898	2042	2264	2409	2842	-	273	84	-	117
	T2A	2	1624	2084	2228	2450	2595	3028	-	547	84	-	137
36 x 84RE	TA	2	1438	1898	2042	2264	2409	2842	-	273	84	-	117
	T2A	2	1624	2084	2228	2450	2595	3028	-	547	84	-	137
36 x 90RE	TA	2	1443	2099	2264	2523	2689	3170	-	-	84	-	129
	T2A	2	1629	2285	2450	2709	2875	3356	-	547	84	-	149
36 x 96RE	TA	2	1443	2099	2264	2523	2689	3170	-	-	84	-	129
	T2A	2	1629	2285	2450	2709	2875	3356	-	547	84	-	149
42 x 78RE	T2A	2	1850	2246	2404	2786	2912	3414	-	547	84	-	151
42 x 84RE	T2A	2	1850	2246	2404	2786	2912	3414	-	547	84	-	151

\*Folding tables available with PVC Bullnose edge only.



2448RE-TA

### STANDARD FEATURES

- Laminate tops available in any standard Wilsonart, Nevamar, Formica, Arborite or Pionite matte finish offerings. For other laminate please contact the factory for pricing.
- Veneers and hardwood edges are standard in Oak, Maple, Cherry, Pecan, Walnut, Mahogany and Chocolate.
- 7 veneer and hardwood edge stains are standard. Stain-to-match available at no upcharge.
- Standard table height 29".
- All bases are standard with floor leveling glides.

### OPTIONS

- Custom heights available.

### HOW TO ORDER

1. Select Model
2. Select Base
3. Select Edge Style
4. Select Options
5. Select Top Finish
6. Select Edge Finish
7. Select Base Finish

Example: 3078RE - TA - PVF -





# ACUTE GENERAL PURPOSE TABLES

BACK TO CONTENTS

MODEL	BASES		TOP SPECIFICATIONS						OPTIONS				LBS
	Code	Qty.	For Laminate Top			For Veneer Top			FLIP TOP (FT)	FOLD (FL)	CASTERS (LC)	WHEELS (WB)	
			SE PVF PVB 2MM	HF HB	HBV HBVR HBG	HF2 HB2 HKN4 HBG2	HF HB HBV HBG	HF2 HB2 HKN4 HBG2					
<i>Racetrack</i>													
36 x 54RT	TA	2	1059	1582	1704	1922	2011	2330	282	-	84	-	91
	T2A	2	1245	1768	1890	2108	2197	2516	-	-	84	-	111
36 x 60RT	TA	2	1059	1582	1704	1922	2011	2330	282	-	84	-	91
	T2A	2	1245	1768	1890	2108	2197	2516	-	-	84	-	111
36 x 66RT	TA	2	1207	1753	1885	2118	2324	2722	282	-	84	-	104
	T2A	2	1393	1939	2071	2304	2510	2908	-	-	84	-	124
36 x 72RT	TA	2	1207	1753	1885	2118	2324	2722	282	-	84	-	104
	T2A	2	1393	1939	2071	2304	2510	2908	-	-	84	-	124
36 x 78RT	TA	2	1453	2147	2309	2662	2736	3201	-	-	84	-	117
	T2A	2	1639	2333	2495	2848	2922	3387	-	-	84	-	132
36 x 84RT	TA	2	1453	2147	2309	2662	2736	3201	-	-	84	-	117
	T2A	2	1639	2333	2495	2848	2922	3387	-	-	84	-	132
36 x 90RT	TA	2	1457	2383	2576	2971	3063	3592	-	-	84	-	129
	T2A	2	1643	2569	2762	3157	3249	3778	-	-	84	-	149
36 x 96RT	TA	2	1457	2383	2576	2971	3063	3592	-	-	84	-	129
	T2A	2	1643	2569	2762	3157	3249	3778	-	-	84	-	149
42 x 78RT	T2A	2	1864	2520	2719	3118	3214	3749	-	-	84	-	166
42 x 84RT	T2A	2	1864	2520	2719	3118	3214	3749	-	-	84	-	166
48 x 78RT	T2A	2	1867	2802	3027	3380	3601	4209	-	-	84	-	166
48 x 84RT	T2A	2	1867	2802	3027	3380	3601	4209	-	-	84	-	166



2448RE-TA

### STANDARD FEATURES

- Laminate tops available in any standard Wilsonart, Nevamar, Formica, Arborite or Pionite matte finish offerings. For other laminate please contact the factory for pricing.
- Veneers and hardwood edges are standard in Oak, Maple, Cherry, Pecan, Walnut, Mahogany and Chocolate.
- 7 veneer and hardwood edge stains are standard. Stain-to-match available at no upcharge.
- Standard table height 29".
- All bases are standard with floor leveling glides.

### OPTIONS

- Custom heights available.

### HOW TO ORDER

- Select Model
- Select Base
- Select Edge Style
- Select Options
- Select Top Finish
- Select Edge Finish
- Select Base Finish

Example: 3654RT - TA - PVF -





# ACUTE GENERAL PURPOSE TABLES

BACK TO CONTENTS

MODEL	BASES		TOP SPECIFICATIONS						OPTIONS				LBS
	Code	Qty.	For Laminate Top			For Veneer Top			FLIP TOP (FT)	FOLD (FL)	CASTERS (LC)	WHEELS (WB)	
			SE PVF PVB 2MM	HF HB	HBV HBVR HBG	HF2 HB2 HKNR4 HBG2	HF HB HBV HBG	HF2 HB2 HKNR4 HBG2					
<i>Bullet</i>													
<b>30 x 54B</b>	TA	2	967	1488	1596	1787	1843	2159	282	-	84	-	81
<b>30 x 60B</b>	TA	2	967	1488	1596	1787	1843	2159	282	-	84	-	81
<b>36 x 54B</b>	TA	2	1080	1955	2110	2389	2427	2824	282	-	84	-	91
<b>36 x 60B</b>	TA	2	1080	1955	2110	2389	2427	2824	282	-	84	-	91
<b>36 x 72B</b>	TA	2	1206	2174	2345	2643	2816	3314	282	-	84	-	104
<i>Halfmoon</i>													
<b>24 x 48H</b>	TA	2	770	1240	1358	1501	1617	1885	282	-	84	-	62
<b>30 x 60H</b>	TA	2	967	1667	1830	1990	2191	2573	282	-	84	-	81
<b>36 x 72H</b>	TA	2	1206	2162	2373	2570	2897	3413	282	-	84	-	104
<i>Trapezoid</i>													
<b>30 x 60TP</b>	TA	2	967	1398	1498	1672	1722	2014	282	-	84	-	81
<b>36 x 72TP</b>	TA	2	1206	1790	1923	2223	2297	2718	282	-	84	-	104
<i>Radius</i>													
<b>24 x 24</b>	<b>24RC90</b>	-	362	656	741	850	871	1043	-	-	-	-	17
<b>30 x 30</b>	<b>30RC90</b>	-	462	868	975	1094	1156	1387	-	-	-	-	27
<i>Crescent</i>													
<b>30 x 36</b>	<b>3036CRC90-TA</b>	1	737	1365	1444	1506	1706	1925	-	-	-	-	46
<b>36 x 42</b>	<b>3642CRC90-TA</b>	1	1070	1659	1767	1849	2123	2420	-	-	-	-	59



2448RE-TA

### STANDARD FEATURES

- Laminate tops available in any standard Wilsonart, Nevamar, Formica, Arborite or Pionite matte finish offerings. For other laminate please contact the factory for pricing.
- Veneers and hardwood edges are standard in Oak, Maple, Cherry, Pecan, Walnut, Mahogany and Chocolate.
- 7 veneer and hardwood edge stains are standard. Stain-to-match available at no upcharge.
- Standard table height 29".
- All bases are standard with floor leveling glides.

### OPTIONS

- Custom heights available.

### HOW TO ORDER

1. Select Model
2. Select Base
3. Select Edge Style
4. Select Options
5. Select Top Finish
6. Select Edge Finish
7. Select Base Finish

Example: 3054B - TA - PVF -







# ACUTE BOARDROOM TABLES

BACK TO CONTENTS

MODEL	BASES		TOP SPECIFICATIONS						OPTIONS	LBS
	Code	Qty.	For Laminate Top			For Veneer Top				
			SE	HF	HBV	HF2	HF	HF2		
			PVF	HB	HBVR	HB2	HB	HB2		
			PVB		HGG	HKN4	HBV	HKN4		
			2MM			HKNR4	HBVR	HKNR4		
						HGG2	HGG	HGG2		
<i>Rectangle</i>										
42 x 96RE	T2A	2	1898	2731	2957	3184	3522	4174		183
48 x 96RE	T2A	2	1898	2731	2957	3184	3522	4174		183
48 x 120RE	T2A	3	2508	3583	3838	4387	4469	5230		240
48 x 144RE	T2A	3	2871	4413	4748	5271	5147	6064		274
48 x 168RE	T2A	3	3332	4884	5267	5997	5828	6894		308
60 x 120RE	T2A	3	2951	4559	4910	5453	5324	6279		282
60 x 144RE	T2A	3	3362	5291	5712	6362	6209	7355		324
60 x 168RE	T2A	3	3773	6024	6512	7274	7093	8430		366
<i>Racetrack</i>										
42 x 96RT	T2A	2	1918	2859	3088	3640	4030	4725		183
48 x 96RT	T2A	2	1918	2859	3088	3640	4030	4725		183
48 x 120RT	T2A	3	2532	4026	4325	5086	5054	5866		240
48 x 144RT	T2A	3	2898	4759	5125	6069	5850	6834		274
48 x 168RT	T2A	3	3362	5385	5814	6861	6657	7798		308
60 x 120RT	T2A	3	2941	4808	5179	6135	6092	7111		282
60 x 144RT	T2A	3	3398	5723	6183	7364	7089	8319		324
60 x 168RT	T2A	3	3979	6509	7044	8349	8097	9523		366



2448RE-TA

### STANDARD FEATURES

- Laminate tops available in any standard Wilsonart, Nevamar, Formica, Arborite or Pionite matte finish offerings. For other laminate please contact the factory for pricing.
- Veneers and hardwood edges are standard in Oak, Maple, Cherry, Pecan, Walnut, Mahogany and Chocolate.
- 7 veneer and hardwood edge stains are standard. Stain-to-match available at no upcharge.
- Standard table height 29".
- All bases are standard with floor leveling glides.

### OPTIONS

- Custom heights available.

### HOW TO ORDER

1. Select Model
2. Select Base
3. Select Edge Style
4. Select Top Finish
5. Select Edge Finish
6. Select Base Finish

**Example:** 4296RE - T2A - PVF

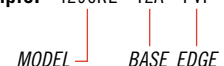



# ACUTE BOARDROOM TABLES

BACK TO CONTENTS

MODEL	BASES		TOP SPECIFICATIONS						OPTIONS	LBS
	Code	Qty.	For Laminate Top			For Veneer Top				
			SE	HF	HBV	HF2	HF	HF2		
			PVF	HB	HBVR	HB2	HB	HB2		
			PVB		HGG	HKN4	HBV	HKN4		
			2MM			HKNR4	HBVR	HKNR4		
						HGG2	HGG	HGG2		
<i>Boatshape</i>										
42 x 96BT	T2A	2	1918	3501	3796	4100	4531	4910		183
48 x 96BT	T2A	2	1918	3501	3796	4100	4531	4910		183
48 x 120BT	T2A	2	2532	4730	5096	5481	5646	6083		240
48 x 144BT	T2A	3	2898	5463	5899	6362	6946	7344		274
48 x 168BT	T2A	3	3362	6164	6671	7206	7479	8094		308
60 x 120BT	T2A	3	2941	5686	6146	6627	6834	7378		282
60 x 144BT	T2A	3	3398	6605	7150	7729	8457	8956		324
60 x 168BT	T2A	3	3979	7482	8115	8784	9122	9893		366
<i>Boatshape Arc Ends</i>										
42 x 96BTA	T2A	2	2078	4006	4302	4608	5036	5416		183
48 x 96BTA	T2A	2	2078	4006	4302	4608	5036	5416		183
48 x 120BTA	T2A	2	2693	5237	5603	5989	6153	6588		240
48 x 144BTA	T2A	3	3059	5968	6407	6870	7451	7851		274
48 x 168BTA	T2A	3	3524	6671	7179	7714	7984	8602		308
60 x 120BTA	T2A	3	3143	6322	6778	7261	7466	8010		282
60 x 144BTA	T2A	3	3598	7236	7784	8362	9090	9587		324
60 x 168BTA	T2A	3	4179	8115	8748	9415	9757	10528		366



2448RE-TA

### STANDARD FEATURES

- Laminate tops available in any standard Wilsonart, Nevamar, Formica, Arborite or Pionite matte finish offerings. For other laminate please contact the factory for pricing.
- Veneers and hardwood edges are standard in Oak, Maple, Cherry, Pecan, Walnut, Mahogany and Chocolate.
- 7 veneer and hardwood edge stains are standard. Stain-to-match available at no upcharge.
- Standard table height 29".
- All bases are standard with floor leveling glides.

### OPTIONS

- Custom heights available.

### HOW TO ORDER

1. Select Model
2. Select Base
3. Select Edge Style
4. Select Top Finish
5. Select Edge Finish
6. Select Base Finish

Example: 4296BT - T2A - PVF

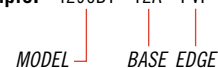

# ANNEX TABLES



## PLACING AN ORDER IS EASY

### PRODUCT CODE

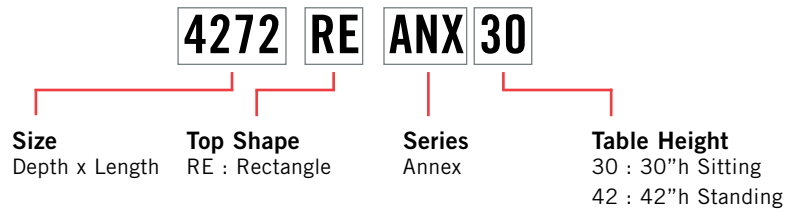

## FINISHES

### LAMINATE



Select laminate from our virtually unlimited laminate options

### BASE



Select from one of our 76 standard Spectone colors

### EDGE



2MM

SE



# ANNEX TABLES

## GENERAL PURPOSE TABLES

BACK TO CONTENTS



MODEL	BASES	TOP SPECIFICATIONS	OPTIONS	LBS
	<i>Code</i>	<i>For Laminate Top</i> <b>SE</b> <b>2MM</b>		
<i>30" high</i>				
<b>36 X 72RE</b>	<b>ANX30</b>	2776		115
<b>36 X 84RE</b>	<b>ANX30</b>	3001		129
<b>36 X 96RE</b>	<b>ANX30</b>	3226		143
<b>42 X 72RE</b>	<b>ANX30</b>	3001		129
<b>42 X 84RE</b>	<b>ANX30</b>	3264		145
<b>42 X 96RE</b>	<b>ANX30</b>	3526		161
<i>42" high</i>				
<b>36 X 72RE</b>	<b>ANX42</b>	2896		121
<b>36 X 84RE</b>	<b>ANX42</b>	3121		134
<b>36 X 96RE</b>	<b>ANX42</b>	3346		148
<b>42 X 72RE</b>	<b>ANX42</b>	3121		134
<b>42 X 84RE</b>	<b>ANX42</b>	3384		150
<b>42 X 96RE</b>	<b>ANX42</b>	3646		166



ANX30



ANX42

### STANDARD FEATURES

- Laminate Tops are available in any standard Wilsonart, Nevamar, Formica, Arborite or Pionite matte Finish.
- For other laminates please contact the factory.
- Standard with two bases and one stretcher.
- Standard with leveling glides.
- Bases are standard with cutouts at inside top and inside bottom to feed power through.
- Bases available in any Spectone color.
- Standard 30" or 42" table height, please specify.
- Ships Knocked Down.

### OPTIONS

- Cove and Villa power options available - refer to the table accessories price list.
- For veneer finishes, please contact the factory.

### HOW TO ORDER

1. Select Model
2. Select Base
3. Select Edge Style
4. Select Options
5. Select Top Finish
6. Select Edge Finish
7. Select Base Finish

**Example:** 3684RE - ANX30 - 2MM



# ARK TABLES

BACK TO CONTENTS



PLACING AN ORDER IS EASY

## PRODUCT CODE

**2430 REARK T**

**Size**  
Width x Length

**Top Shape**  
 DIA : Round    C90 : Crescent  
 SQ : Square    BT : Boatshape  
 RE : Rectangle    BTA : Boatshape Arc  
 RT : Racetrack  
 B : Bullet  
 H : Halfmoon  
 TP : Trapezoid

**Series**  
Ark

**Base**  
 X : X-Base  
 X4 : 4 Column X-Base  
 T : T-Base  
 T2 : Double Column T-Base  
 C : C-Base  
 T2D : T2 with Door  
 T2DB : T2 with Door and Bridge



## OPTIONS

**FLIP TOP**



**CASTERS**



**FOLDING**



## FINISHES

**LAMINATE**



Select laminate from our virtually unlimited laminate options

**VENEER**

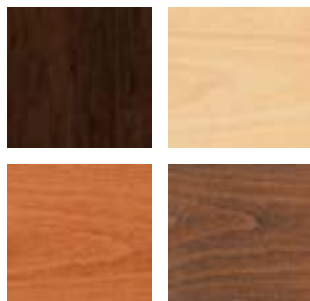

Select from one of our 7 standard wood stains or stain-to-match at no upcharge

**BASE**



Select from one of our 76 standard Spectone colors

**EDGE**



2MM      PVC      Hard Wood

Check out our website for a complete list of edge profiles.



# ARK TABLES



BACK TO CONTENTS

MODEL		BASES		TOP SPECIFICATIONS						OPTIONS			MOBILITY		LBS
Size / Shape		Code		For Laminate Top			For Veneer Top			FLIP TOP	FOLD	BAR HEIGHT	CASTERS		
		#of		SE	HF	HBV	HF2	HF	HF2				HARD	SOFT	
				PVF	HB	HBVR	HB2	HB	HB2	FLIP TOP	Add	Add	Add		
				PVB		HBG	HKN4	HBV	HKN4						
				2MM			HKNR4	HBVR	HKNR4						
							HBG2	HBG	HBG2						
<b>ROUND</b>															
24 DIA	ARKX	1	533	862	896	996	1049	1152	141	-	35	84	184		
30 DIA	ARKX	1	628	952	996	1195	1144	1295	141	-	35	84	184		
36 DIA	ARKX	1	718	1189	1271	1434	1484	1693	141	-	35	84	184		
42 DIA	ARKX	1	979	1506	1620	1862	1887	2173	141	-	-	84	184		
42 DIA	ARKX4	1	1144	1671	1785	2027	2052	2338	-	-	-	84	184		
48 DIA	ARKX4	1	1165	1873	1997	2117	2551	2919	-	-	-	84	184		
54 DIA	ARKX4	1	1431	2474	2666	2850	3066	3538	-	-	-	84	184		
<b>SQUARE</b>															
24x24 SQ	ARKX	1	561	740	774	836	881	1035	141	-	35	84	184		
30x30 SQ	ARKX	1	659	789	836	1000	941	1152	141	-	35	84	184		
36x36 SQ	ARKX	1	736	940	996	1189	1195	1379	141	-	35	84	184		
42x42 SQ	ARKX4	1	1158	1453	1544	1635	1698	1949	-	-	-	84	184		
48x48 SQ	ARKX4	1	1299	1558	1654	1696	2043	2365	-	-	-	84	184		
54x54 SQ	ARKX4	1	1433	2005	2155	2329	2424	2842	-	-	-	84	184		
<b>RECTANGLE</b>															
24x30 RE	ARKX	1	648	770	814	877	926	1045	141	-	-	84	184		
24x30 RE	ARKT, ARKC	2	743	865	909	972	1021	1140	282	-	-	84	184		
24x36 RE	ARKX	1	648	770	814	877	926	1045	141	-	-	84	184		
24x36 RE	ARKT, ARKC	2	743	865	909	972	1021	1140	282	-	-	84	184		
24x42 RE	ARKT, ARKC	2	804	1000	1051	1143	1199	1365	282	-	-	84	184		
24x48 RE	ARKT, ARKC	2	804	1000	1051	1143	1199	1365	282	-	-	84	184		



ARK X



ARK X4



ARK T



ARK C

**NOTES AND OPTIONS**

- Laminate Tops are available in any standard Wilsonart, Nevamar, Formica, Arborite or Pionite matte Finish.
- For other laminates please contact the factory.
- Veneers and hardwood edge stains are standard in Maple, Mahogany, Cherry, Oak, Walnut, Pecan and Chocolate or Stain-to-Match at no upcharge.
- Standard with leveling glides.
- Bases available in any Spectone color.
- C and T bases are available at the same price. Specify ARKT or ARKC when ordering.
- Standard 29" table height.
- Custom heights available.
- Locking Casters are not self-leveling.
- Table Carts are available for folding tables. Holds 6 tables.
- Base span increases with size of top.
- For table accessories, including grommets, seam connectors and modesty panels, go to table accessory price lists.



# ARK TABLES

BACK TO CONTENTS



MODEL <i>Size / Shape</i>	BASES		TOP SPECIFICATIONS						OPTIONS			MOBILITY		LBS
	<i>Code</i>	<i>#of</i>	<i>For Laminate Top</i>			<i>For Veneer Top</i>			<i>FLIP TOP</i>	<i>FOLD</i>	<i>BAR HEIGHT</i>	<i>CASTERS</i>	<i>HARD</i>	
			SE PVF PVB 2MM	HF HB	HBV HBVR HBG	HF2 HB2 HKN4 HKNR4 HBG2	HF HB HBV HBG	HF2 HB2 HKN4 HKNR4 HBG2	<i>Add</i>	<i>Add</i>	<i>Add</i>			
<b>RECTANGLE</b>														
24x54 RE	ARKT, ARKC	2	859	1145	1210	1316	1395	1598	282	-	-	84	184	
24x60 RE	ARKT, ARKC	2	859	1145	1210	1316	1395	1598	282	273	-	84	184	
24x66 RE	ARKT, ARKC	2	995	1339	1419	1548	1632	1881	282	273	-	84	184	
24x72 RE	ARKT, ARKC	2	995	1339	1419	1548	1632	1881	282	273	-	84	184	
30x36 RE	ARKX	2	736	877	927	1007	1065	1209	141	-	-	84	184	
30x36 RE	ARKT, ARKC	2	831	972	1022	1102	1160	1304	282	-	-	84	184	
30x42 RE	ARKT, ARKC	2	850	1119	1181	1287	1365	1567	282	-	-	84	184	
30x48 RE	ARKT, ARKC	2	850	1119	1181	1287	1365	1567	282	-	-	84	184	
30x54 RE	ARKT, ARKC	2	905	1272	1352	1503	1593	1846	282	-	-	84	184	
30x60 RE	ARKT, ARKC	2	905	1272	1352	1503	1593	1846	282	273	-	84	184	
30x66 RE	ARKT, ARKC	2	1068	1364	1461	1615	1702	1982	282	273	-	84	184	
30x72 RE	ARKT, ARKC	2	1120	1507	1605	1803	1906	2213	282	273	-	84	184	
30x78 RE	ARKT, ARKC	2	1330	1672	1788	2018	2139	2492	282	273	-	84	184	
30x84 RE	ARKT, ARKC	2	1330	1672	1788	2018	2139	2492	282	273	-	84	184	
30x90 RE	ARKT, ARKC	2	1349	1879	2018	2231	2374	2776	282	273	-	84	184	
30x96 RE	ARKT, ARKC	2	1349	1879	2018	2231	2374	2776	282	273	-	84	184	
36x42 RE	ARKT, ARKC	2	943	1145	1223	1329	1410	1622	282	-	-	84	184	
36x48 RE	ARKT, ARKC	2	967	1252	1335	1461	1545	1792	282	-	-	84	184	
36x54 RE	ARKT, ARKC	2	1039	1348	1443	1585	1689	1961	282	-	-	84	184	
36x60 RE	ARKT, ARKC	2	1057	1454	1555	1716	1818	2127	282	273	-	84	184	
36x66 RE	ARKT, ARKC	2	1139	1551	1667	1844	1955	2295	282	273	-	84	184	
36x66 RE	ARKT2	2	1381	1793	1909	2086	2197	2537	-	-	-	-	-	

\*Folding Tables are available with PVC Bullnose edge only.



ARK X



ARK T



ARK C

**NOTES AND OPTIONS**

- Laminate Tops are available in any standard Wilsonart, Nevamar, Formica, Arborite or Pionite matte Finish.
- For other laminates please contact the factory.
- Veneers and hardwood edge stains are standard in Maple, Mahogany, Cherry, Oak, Walnut, Pecan and Chocolate or Stain-to-Match at no upcharge.
- Standard with leveling glides.
- Bases available in any Spectone color.
- C and T bases are available at the same price. Specify ARKT or ARKC when ordering.

- Standard 29" table height.
- Custom heights available.
- Locking Casters are not self-leveling.
- Table Carts are available for folding tables. Holds 6 tables.
- Base span increases with size of top.
- For table accessories, including grommets, seam connectors and modesty panels, go to table accessory price lists.



# ARK TABLES

BACK TO CONTENTS

MODEL <i>Size / Shape</i>	BASES		TOP SPECIFICATIONS						OPTIONS			MOBILITY		LBS
	<i>Code</i>	<i>#of</i>	<i>For Laminate Top</i>			<i>For Veneer Top</i>			FLIP TOP	FOLD	BAR HEIGHT	CASTERS	HARD	
			SE PVF PVB 2MM	HF HB	HBV HBVR HBG	HF2 HB2 HKN4 HKNR4 HBG2	HF HB HBV HBVR HBG	HF2 HB2 HKN4 HKNR4 HBG2	Add	Add	Add			
<b>RECTANGLE</b>														
36x72 RE	ARKT, ARKC	2	1175	1605	1716	1972	2095	2463	282	273	-	84	184	
36x72 RE	ARKT2	2	1417	1847	1958	2214	2337	2705	-	-	-	-	-	
36x78 RE	ARKT, ARKC	2	1488	1948	2092	2314	2459	2892	282	273	-	84	184	
36x78 RE	ARKT2	2	1730	2190	2334	2556	2701	3134	-	-	-	-	-	
36x84 RE	ARKT, ARKC	2	1488	1948	2092	2314	2459	2892	282	273	-	84	184	
36x84 RE	ARKT2	2	1730	2190	2334	2556	2701	3134	-	-	-	-	-	
36x90 RE	ARKT, ARKC	2	1493	2149	2314	2573	2739	3220	282	273	-	84	184	
36x90 RE	ARKT2	2	1735	2391	2556	2815	2981	3462	-	-	-	-	-	
36x96 RE	ARKT, ARKC	2	1493	2149	2314	2573	2739	3220	282	273	-	84	184	
36x96 RE	ARKT2	2	1735	2391	2556	2815	2981	3462	-	-	-	-	-	
42x78 RE	ARKT2	2	1956	2352	2510	2892	3018	3520	-	-	-	-	-	
42x84 RE	ARKT2	2	1956	2352	2510	2892	3018	3520	-	-	-	-	-	

\*Folding Tables are available with PVC Bullnose edge only.



ARK T



ARK C



ARKT2

**NOTES AND OPTIONS**

- Laminate Tops are available in any standard Wilsonart, Nevamar, Formica, Arborite or Pionite matte Finish.
- For other laminates please contact the factory.
- Veneers and hardwood edge stains are standard in Maple, Mahogany, Cherry, Oak, Walnut, Pecan and Chocolate or Stain-to-Match at no upcharge.
- Standard with leveling glides.
- Bases available in any Spectone color.
- C and T bases are available at the same price. Specify ARKT or ARKC when ordering.

- Standard 29" table height.
- Custom heights available.
- Locking Casters are not self-leveling.
- Table Carts are available for folding tables. Holds 6 tables.
- Base span increases with size of top.
- For table accessories, including grommets, seam connectors and modesty panels, go to table accessory price lists.





# ARK TABLES

BACK TO CONTENTS

MODEL <i>Size / Shape</i>	BASES		TOP SPECIFICATIONS						OPTIONS			MOBILITY		LBS
	<i>Code</i>	<i>#of</i>	<i>For Laminate Top</i>			<i>For Veneer Top</i>			<i>FLIP TOP</i>	<i>FOLD</i>	<i>BAR HEIGHT</i>	<i>CASTERS</i>		
			<i>SE PVF PVB 2MM</i>	<i>HF HB</i>	<i>HBV HBVR HBG</i>	<i>HF2 HB2 HKN4 HKNR4 HBG2</i>	<i>HF HB HBV HBG</i>	<i>HF2 HB2 HKN4 HKNR4 HBG2</i>	<i>Add</i>	<i>Add</i>	<i>Add</i>	<i>HARD</i>	<i>SOFT</i>	
<b>RACETRACK</b>														
36x54 RT	ARKT, ARKC	2	1109	1632	1754	1972	2061	2380	282	-	-	84	184	
36x54 RT	ARKT2	2	1351	1874	1996	2214	2303	2622	-	-	-	-	-	
36x60 RT	ARKT, ARKC	2	1109	1632	1754	1972	2061	2380	282	-	-	84	184	
36x60 RT	ARKT2	2	1351	1874	1996	2214	2303	2622	-	-	-	-	-	
36x66 RT	ARKT, ARKC	2	1257	1803	1935	2168	2374	2772	282	-	-	84	184	
36x66 RT	ARKT2	2	1499	2045	2177	2410	2616	3014	-	-	-	-	-	
36x72 RT	ARKT, ARKC	2	1257	1803	1935	2168	2374	2772	282	-	-	84	184	
36x72 RT	ARKT2	2	1499	2045	2177	2410	2616	3014	-	-	-	-	-	
36x78 RT	ARKT, ARKC	2	1503	2197	2359	2712	2786	3251	282	-	-	84	184	
36x78 RT	ARKT2	2	1745	2439	2601	2954	3028	3493	-	-	-	-	-	
36x84 RT	ARKT, ARKC	2	1503	2197	2359	2712	2786	3251	282	-	-	84	184	
36x84 RT	ARKT2	2	1745	2439	2601	2954	3028	3493	-	-	-	-	-	
36x90 RT	ARKT, ARKC	2	1507	2433	2626	3021	3113	3642	282	-	-	84	184	
36x90 RT	ARKT2	2	1749	2675	2868	3263	3355	3884	-	-	-	-	-	
36x96 RT	ARKT, ARKC	2	1507	2433	2626	3021	3113	3642	282	-	-	84	184	
36x96 RT	ARKT2	2	1749	2675	2868	3263	3355	3884	-	-	-	-	-	
42x78 RT	ARKT2	2	1970	2626	2825	3224	3320	3855	-	-	-	-	-	
42x84 RT	ARKT2	2	1970	2626	2825	3224	3320	3855	-	-	-	-	-	
48x78 RT	ARKT2	2	1973	2908	3133	3486	3707	4315	-	-	-	-	-	
48x84 RT	ARKT2	2	1973	2908	3133	3486	3707	4315	-	-	-	-	-	



ARK T



ARK C



ARKT2

**NOTES AND OPTIONS**

- Laminate Tops are available in any standard Wilsonart, Nevamar, Formica, Arborite or Pionite matte Finish.
- For other laminates please contact the factory.
- Veneers and hardwood edge stains are standard in Maple, Mahogany, Cherry, Oak, Walnut, Pecan and Chocolate or Stain-to-Match at no upcharge.
- Standard with leveling glides.
- Bases available in any Spectone color.
- C and T bases are available at the same price. Specify ARKT or ARKC when ordering.

- Standard 29" table height.
- Custom heights available.
- Locking Casters are not self-leveling.
- Table Carts are available for folding tables. Holds 6 tables.
- Base span increases with size of top.
- For table accessories, including grommets, seam connectors and modesty panels, go to table accessory price lists.



# ARK TABLES



BACK TO CONTENTS

MODEL <i>Size / Shape</i>	BASES		TOP SPECIFICATIONS						OPTIONS			MOBILITY		LBS
	<i>Code</i>	<i>#of</i>	<i>For Laminate Top</i>			<i>For Veneer Top</i>			<i>FLIP TOP</i>	<i>FOLD</i>	<i>BAR HEIGHT</i>	<i>CASTERS</i>		
			<i>SE</i>	<i>HF</i>	<i>HBV</i>	<i>HF2</i>	<i>HF</i>	<i>HF2</i>	<i>FLIP TOP</i>	<i>FOLD</i>	<i>BAR HEIGHT</i>	<i>HARD</i>	<i>SOFT</i>	
			<i>PVF</i>	<i>HB</i>	<i>HBVR</i>	<i>HB2</i>	<i>HB</i>	<i>HB2</i>	<i>Add</i>	<i>Add</i>	<i>Add</i>			
			<i>PVB</i>		<i>HKG</i>	<i>HKN4</i>	<i>HBV</i>	<i>HKN4</i>						
			<i>2MM</i>		<i>HKG2</i>	<i>HKNR4</i>	<i>HBV</i>	<i>HKNR4</i>						
					<i>HKG2</i>		<i>HKG</i>	<i>HKG2</i>						
<b>BULLET</b>														
<b>30x54 B</b>	<b>ARKT, ARKC</b>	2	1017	1538	1646	1837	1893	2209	282	-	-	84	184	
<b>30x60 B</b>	<b>ARKT, ARKC</b>	2	1017	1538	1646	1837	1893	2209	282	-	-	84	184	
<b>36x54 B</b>	<b>ARKT, ARKC</b>	2	1130	2005	2160	2439	2477	2874	282	-	-	84	184	
<b>36x60 B</b>	<b>ARKT, ARKC</b>	2	1130	2005	2160	2439	2477	2874	282	-	-	84	184	
<b>36x66 B</b>	<b>ARKT, ARKC</b>	2	1256	2224	2395	2693	2866	3364	282	-	-	84	184	
<b>36x72 B</b>	<b>ARKT, ARKC</b>	2	1256	2224	2395	2693	2866	3364	282	-	-	84	184	
<b>HALFMOON</b>													0	
<b>24x48 H</b>	<b>ARKT, ARKC</b>	2	820	1290	1408	1551	1667	1935	282	-	-	84	184	
<b>30x60 H</b>	<b>ARKT, ARKC</b>	2	1017	1717	1880	2040	2241	2623	282	-	-	84	184	
<b>36x72 H</b>	<b>ARKT, ARKC</b>	2	1256	2212	2423	2620	2947	3463	282	-	-	84	184	
<b>TRAPEZOID</b>														
<b>30x60 TP</b>	<b>ARKT, ARKC</b>	2	1017	1448	1548	1722	1772	2064	282	-	-	84	184	
<b>36x72 TP</b>	<b>ARKT, ARKC</b>	2	1256	1840	1973	2273	2347	2768	282	-	-	84	184	
<b>CRESCENT</b>														
<b>30x36 CRC90</b>	<b>ARKT, ARKC</b>	2	994	1622	1701	1763	1963	2182	-	-	-	-	-	
<b>36x42 CRC90</b>	<b>ARKT, ARKC</b>	2	1327	1916	2024	2106	2380	2677	-	-	-	-	-	



ARK T



ARK C

**NOTES AND OPTIONS**

- Laminate Tops are available in any standard Wilsonart, Nevamar, Formica, Arborite or Pionite matte Finish.
- For other laminates please contact the factory.
- Veneers and hardwood edge stains are standard in Maple, Mahogany, Cherry, Oak, Walnut, Pecan and Chocolate or Stain-to-Match at no upcharge.
- Standard with leveling glides.
- Bases available in any Spectone color.
- C and T bases are available at the same price. Specify ARKT or ARKC when ordering.

- Standard 29" table height.
- Custom heights available.
- Locking Casters are not self-leveling.
- Table Carts are available for folding tables. Holds 6 tables.
- Base span increases with size of top.
- For table accessories, including grommets, seam connectors and modesty panels, go to table accessory price lists.



# ARK TABLES - BOARDROOM

BACK TO CONTENTS



MODEL <i>Size / Shape</i>	BASES		TOP SPECIFICATIONS						OPTIONS	MOBILITY	LBS
	<i>Code</i>	<i>#of</i>	<i>For Laminate Top</i>			<i>For Veneer Top</i>					
			SE PVF PVB 2MM	HF HB	HBV HBVR HBG	HF2 HB2 HKN4 HKNR4 HBG2	HF HB HBV HBG	HF2 HB2 HKN4 HKNR4 HBG2			
<b>RECTANGLE</b>											
42x96 RE	ARKT2	2	2004	2837	3063	3290	3628	4280			
42x96 RE	ARKT2D	2	3068	3901	4127	4354	4692	5344			
42x96 RE	ARKT2DB	2	3350	4183	4409	4636	4974	5626			
48x96 RE	ARKT2	2	2004	2837	3063	3290	3628	4280			
48x96 RE	ARKT2D	2	3068	3901	4127	4354	4692	5344			
48x96 RE	ARKT2DB	2	3350	4183	4409	4636	4974	5626			
48x120 RE	ARKT2	3	2667	3742	3997	4546	4628	5389			
48x120 RE	ARKT2D	3	4263	5338	5593	6142	6224	6985			
48x120 RE	ARKT2DB	2	3660	4735	4990	5539	5621	6382			
48x144 RE	ARKT2	3	3030	4572	4907	5430	5306	6223			
48x144 RE	ARKT2D	3	4626	6168	6503	7026	6902	7819			
48x144 RE	ARKT2DB	2	4023	5565	5900	6423	6299	7216			
48x168 RE	ARKT2	3	3491	5043	5426	6156	5987	7053			
48x168 RE	ARKT2D	3	5087	6639	7022	7752	7583	8649			
48x168 RE	ARKT2DB	2	5510	7062	7445	8175	8006	9072			
60x120 RE	ARKT2	3	3110	4718	5069	5612	5483	6438			
60x120 RE	ARKT2D	3	4706	6314	6665	7208	7079	8034			
60x120 RE	ARKT2DB	2	4103	5711	6062	6605	6476	7431			
60x144 RE	ARKT2	3	3521	5450	5871	6521	6368	7514			
60x144 RE	ARKT2D	3	5117	7046	7467	8117	7964	9110			
60x144 RE	ARKT2DB	2	4514	6443	6864	7514	7361	8507			
60x168 RE	ARKT2	3	3932	6183	6671	7433	7252	8589			
60x168 RE	ARKT2D	3	5528	7779	8267	9029	8848	10185			
60x168 RE	ARKT2DB	2	5951	8202	8690	9452	9271	10608			



ARK DOUBLE COLUMN



ARK DOUBLE COLUMN WITH PERFORATED DOOR FOR WIRE MANAGEMENT

**NOTES AND OPTIONS**

- Laminate Tops are available in any standard Wilsonart, Nevamar, Formica, Arborite or Pionite matte Finish.
- For other laminates please contact the factory.
- Veneers and hardwood edge stains are standard in Maple, Mahogany, Cherry, Oak, Walnut, Pecan and Chocolate or Stain-to-Match at no upcharge.

- Standard with leveling glides.
- Bases available in any Spectone color.
- Standard 29" table height.



# ARK TABLES - BOARDROOM

BACK TO CONTENTS

MODEL <i>Size / Shape</i>	BASES		TOP SPECIFICATIONS						OPTIONS	MOBILITY	LBS
	<i>Code</i>	<i>#of</i>	<i>For Laminate Top</i>			<i>For Veneer Top</i>					
			SE PVF PVB 2MM	HF HB	HBV HBVR HBG	HF2 HB2 HKN4 HKNR4 HBG2	HF HB HBV HBG	HF2 HB2 HKN4 HKNR4 HBG2			
<b>RACETRACK</b>											
42x96 RT	ARKT2	2	2024	2965	3194	3746	4136	4831			
42x96 RT	ARKT2D	2	3088	4029	4258	4810	5200	5895			
42x96 RT	ARKT2DB	2	3370	4311	4540	5092	5482	6177			
48x96 RT	ARKT2	2	2024	2965	3194	3746	4136	4831			
48x96 RT	ARKT2D	2	3088	4029	4258	4810	5200	5895			
48x96 RT	ARKT2DB	2	3370	4311	4540	5092	5482	6177			
48x120 RT	ARKT2	3	2691	4185	4484	5245	5213	6025			
48x120 RT	ARKT2D	3	4287	5781	6080	6841	6809	7621			
48x120 RT	ARKT2DB	2	3684	5178	5477	6238	6206	7018			
48x144 RT	ARKT2	3	3057	4918	5284	6228	6009	6993			
48x144 RT	ARKT2D	3	4653	6514	6880	7824	7605	8589			
48x144 RT	ARKT2DB	2	4050	5911	6277	7221	7002	7986			
48x168 RT	ARKT2	3	3521	5544	5973	7020	6816	7957			
48x168 RT	ARKT2D	3	5117	7140	7569	8616	8412	9553			
48x168 RT	ARKT2DB	2	5540	7563	7992	9039	8835	9976			
60x120 RT	ARKT2	3	3100	4967	5338	6294	6251	7270			
60x120 RT	ARKT2D	3	4696	6563	6934	7890	7847	8866			
60x120 RT	ARKT2DB	2	4093	5960	6331	7287	7244	8263			
60x144 RT	ARKT2	3	3557	5882	6342	7523	7248	8478			
60x144 RT	ARKT2D	3	5153	7478	7938	9119	8844	10074			
60x144 RT	ARKT2DB	2	4550	6875	7335	8516	8241	9471			
60x168 RT	ARKT2	3	4138	6668	7203	8508	8256	9682			
60x168 RT	ARKT2D	3	5734	8264	8799	10104	9852	11278			
60x168 RT	ARKT2DB	2	6157	8687	9222	10527	10275	11701			



ARK DOUBLE COLUMN



ARK DOUBLE COLUMN WITH PERFORATED DOOR FOR WIRE MANAGEMENT

**NOTES AND OPTIONS**

- Laminate Tops are available in any standard Wilsonart, Nevamar, Formica, Arborite or Pionite matte Finish.
- For other laminates please contact the factory.
- Veneers and hardwood edge stains are standard in Maple, Mahogany, Cherry, Oak, Walnut, Pecan and Chocolate or Stain-to-Match at no upcharge.

- Standard with leveling glides.
- Bases available in any Spectone color.
- Standard 29" table height.



# ARK TABLES - BOARDROOM

BACK TO CONTENTS

MODEL <i>Size / Shape</i>	BASES		TOP SPECIFICATIONS						OPTIONS	MOBILITY	LBS
	<i>Code</i>	<i>#of</i>	<i>For Laminate Top</i>			<i>For Veneer Top</i>					
			SE PVF PVB 2MM	HF HB	HBV HBVR HBG	HF2 HB2 HKN4 HKNR4 HBG2	HF HB HBV HBG	HF2 HB2 HKN4 HKNR4 HBG2			
<b>BOATSHAPE</b>											
42x96 BT	ARKT2	2	2024	3607	3902	4206	4637	5016			
42x96 BT	ARKT2D	2	3088	4671	4966	5270	5701	6080			
42x96 BT	ARKT2DB	2	3370	4953	5248	5552	5983	6362			
48x96 BT	ARKT2	2	2024	3607	3902	4206	4637	5016			
48x96 BT	ARKT2D	2	3088	4671	4966	5270	5701	6080			
48x96 BT	ARKT2DB	2	3370	4953	5248	5552	5983	6362			
48x120 BT	ARKT2	3	2691	4889	5255	5640	5805	6242			
48x120 BT	ARKT2D	3	4287	6485	6851	7236	7401	7838			
48x120 BT	ARKT2DB	2	3684	5882	6248	6633	6798	7235			
48x144 BT	ARKT2	3	3057	5622	6058	6521	7105	7503			
48x144 BT	ARKT2D	3	4653	7218	7654	8117	8701	9099			
48x144 BT	ARKT2DB	2	4050	6615	7051	7514	8098	8496			
48x168 BT	ARKT2	3	3521	6323	6830	7365	7638	8253			
48x168 BT	ARKT2D	3	5117	7919	8426	8961	9234	9849			
48x168 BT	ARKT2DB	2	5540	8342	8849	9384	9657	10272			
60x120 BT	ARKT2	3	3100	5845	6305	6786	6993	7537			
60x120 BT	ARKT2D	3	4696	7441	7901	8382	8589	9133			
60x120 BT	ARKT2DB	2	4093	6838	7298	7779	7986	8530			
60x144 BT	ARKT2	3	3557	6764	7309	7888	8616	9115			
60x144 BT	ARKT2D	3	5153	8360	8905	9484	10212	10711			
60x144 BT	ARKT2DB	2	4550	7757	8302	8881	9609	10108			
60x168 BT	ARKT2	3	4138	7641	8274	8943	9281	10052			
60x168 BT	ARKT2D	3	5734	9237	9870	10539	10877	11648			
60x168 BT	ARKT2DB	2	6157	9660	10293	10962	11300	12071			



ARK DOUBLE COLUMN



ARK DOUBLE COLUMN WITH PERFORATED DOOR FOR WIRE MANAGEMENT

**NOTES AND OPTIONS**

- Laminate Tops are available in any standard Wilsonart, Nevamar, Formica, Arborite or Pionite matte Finish.
- For other laminates please contact the factory.
- Veneers and hardwood edge stains are standard in Maple, Mahogany, Cherry, Oak, Walnut, Pecan and Chocolate or Stain-to-Match at no upcharge.

- Standard with leveling glides.
- Bases available in any Spectone color.
- Standard 29" table height.



# ARK TABLES - BOARDROOM

BACK TO CONTENTS



MODEL		BASES		TOP SPECIFICATIONS						OPTIONS	MOBILITY	LBS
Size / Shape	Code	#of	For Laminate Top			For Veneer Top						
			SE PVF PVB 2MM	HF HB	HBV HBVR HBG	HF2 HB2 HKN4 HKNR4 HBG2	HF HB HBV HBG	HF2 HB2 HKN4 HKNR4 HBG2				
<b>BOATSHAPE ARC ENDS</b>												
42x96 BTA	ARKT2	2	2184	4112	4408	4714	5142	5522				
42x96 BTA	ARKT2D	2	3248	5176	5472	5778	6206	6586				
42x96 BTA	ARKT2DB	2	3530	5458	5754	6060	6488	6868				
48x96 BTA	ARKT2	2	2184	4112	4408	4714	5142	5522				
48x96 BTA	ARKT2D	2	3248	5176	5472	5778	6206	6586				
48x96 BTA	ARKT2DB	2	3530	5458	5754	6060	6488	6868				
48x120 BTA	ARKT2	3	2852	5396	5762	6148	6312	6747				
48x120 BTA	ARKT2D	3	4448	6992	7358	7744	7908	8343				
48x120 BTA	ARKT2DB	2	3845	6389	6755	7141	7305	7740				
48x144 BTA	ARKT2	3	3218	6127	6566	7029	7610	8010				
48x144 BTA	ARKT2D	3	4814	7723	8162	8625	9206	9606				
48x144 BTA	ARKT2DB	2	4211	7120	7559	8022	8603	9003				
48x168 BTA	ARKT2	3	3683	6830	7338	7873	8143	8761				
48x168 BTA	ARKT2D	3	5279	8426	8934	9469	9739	10357				
48x168 BTA	ARKT2DB	2	5702	8849	9357	9892	10162	10780				
60x120 BTA	ARKT2	3	3302	6481	6937	7420	7625	8169				
60x120 BTA	ARKT2D	3	4898	8077	8533	9016	9221	9765				
60x120 BTA	ARKT2DB	2	4295	7474	7930	8413	8618	9162				
60x144 BTA	ARKT2	3	3757	7395	7943	8521	9249	9746				
60x144 BTA	ARKT2D	3	5353	8991	9539	10117	10845	11342				
60x144 BTA	ARKT2DB	2	4750	8388	8936	9514	10242	10739				
60x168 BTA	ARKT2	3	4338	8274	8907	9574	9916	10687				
60x168 BTA	ARKT2D	3	5934	9870	10503	11170	11512	12283				
60x168 BTA	ARKT2DB	2	6357	10293	10926	11593	11935	12706				



ARK DOUBLE COLUMN



ARK DOUBLE COLUMN WITH PERFORATED DOOR FOR WIRE MANAGEMENT

**NOTES AND OPTIONS**

- Laminate Tops are available in any standard Wilsonart, Nevamar, Formica, Arborite or Pionite matte Finish.
- For other laminates please contact the factory.
- Veneers and hardwood edge stains are standard in Maple, Mahogany, Cherry, Oak, Walnut, Pecan and Chocolate or Stain-to-Match at no upcharge.

- Standard with leveling glides.
- Bases available in any Spectone color.
- Standard 29" table height.

## BOARDGAMES BOARDROOM TABLES



### HOW TO ORDER

Boardgames is a series of tabletops and bases that allows complete flexibility when specifying boardrooms, meeting rooms, video conferencing and training areas.

For simplicity and ease of choice, tabletops and bases are priced separately. All bases are standard with a touch latch door for wire access and a cutout at the top for wire pass-through.



#### Step 1 - Select the tabletop

1. Choose the shape and size of the tabletop
  - see tabletop shapes
  - see tabletop dimensions and finishes
  - see tabletop sections and seating layouts
2. Choose laminate or veneer top finish
3. Choose an edge profile in hardwood, self edge, PVC or 2MM Bio Edge

---

#### Step 2 - Select the base

1. Choose a base design
  - be sure to select the correct number of bases required for the table
2. Choose a base finish
  - laminate or veneer
3. Choose a base trim profile
  - aluminum extrusion or wood
4. Choose the finish of the base trim profile
  - if aluminum extrusion, choose any Spectone color
  - if wood, choose from 7 standard stains or stain-to-match at no upcharge

---

#### Step 3 - Select power and communication modules (if required)

1. Determine the number and type of modules required on the table
2. For each module select the appropriate power and data configuration.



# BOARDGAMES TABLES

BACK TO CONTENTS



PLACING AN ORDER IS EASY

## PRODUCT CODE

**4896 RE BG DR - L**

<p><b>Size</b> Width x Length</p>	<p><b>Top Shape</b> D : Round SQ : Square RE : Rectangle REA: Rectangle Arc RT : Racetrack BT : Boatshape BTA : Boatshape Arc</p>	<p><b>EL : Ellipse</b> <b>VC : Video</b> <b>Conference</b> <b>VCA : Video</b> <b>Conference Arc</b></p>	<p><b>Series</b> BG : Boardgame PL : Plinth</p>	<p><b>Base Shape</b> DR : Drum RE : Rectangle SQ : Square EL : Ellipse DDR : D-Drum HDR : Half Drum</p>	<p><b>Finish</b> L : Laminate V : Veneer</p>
---------------------------------------	---	---	---	---	--



## OPTIONS

### BASE



### TRIM DETAIL



## FINISHES

### LAMINATE



Select laminate from our virtually unlimited laminate options

### VENEER

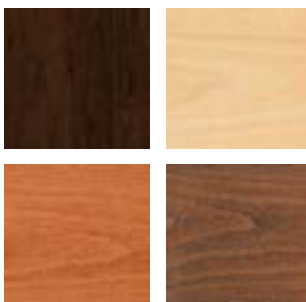

Select from one of our 7 standard wood stains or stain-to-match at no upcharge

### ALUMINUM BASE TRIM



Select from one of our 76 standard Spectone colors

### EDGE





# BOARDGAMES BOARDROOM TABLES

## TABLETOP SHAPES

On one piece tabletops, grain direction runs lengthwise.

On tabletops of two or more pieces, grain direction runs from side to side, as standard.

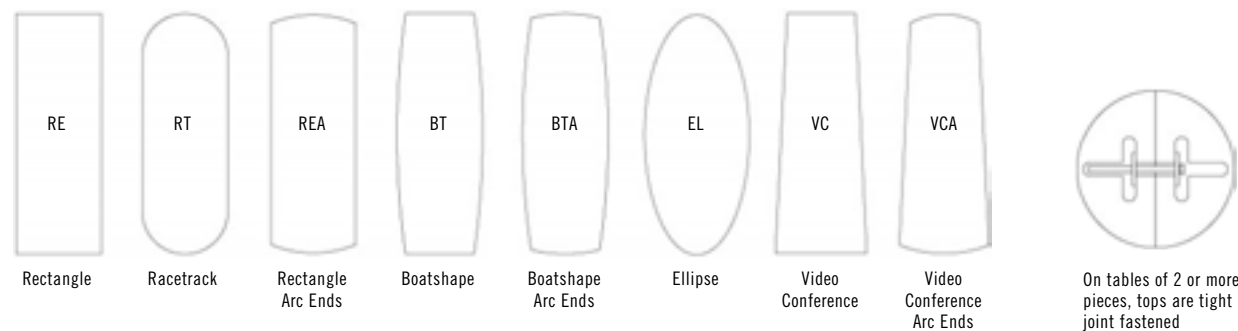

## EDGE PROFILES

Boardgames tabletops in veneer or laminate can be specified with any one of our standard hardwood edge profiles. Also available in self edge, PVC flat, PVC bullnose and 2mm Bio Edge.

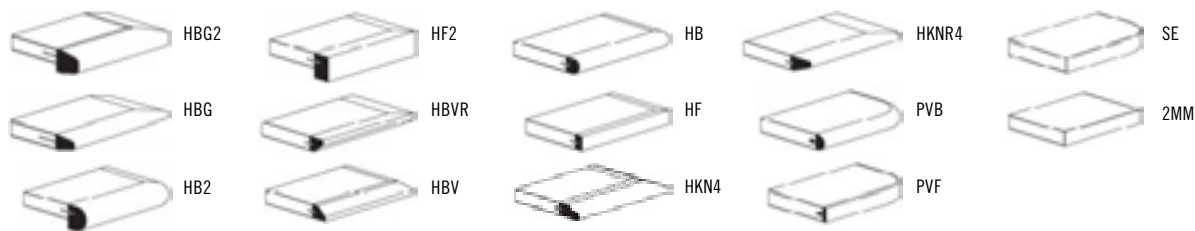

## BASE DESIGNS AND TRIM PROFILES

### Boardgames - Base Designs

Six different Boardgames bases are available, in laminate or veneer, standard at 22" width. For 30" width options, please contact Spec Customer Service. Each base features trim profiles in your choice of aluminum extrusion or wood. Aluminum extrusion is available in any Spectone color at no upcharge. Wood trim on base stained in any of Spec's standard stain colors or stain-to-match at no upcharge. The bases are standard with a touch latch removable door for wire access and a cutout at the top for wire pass-through.

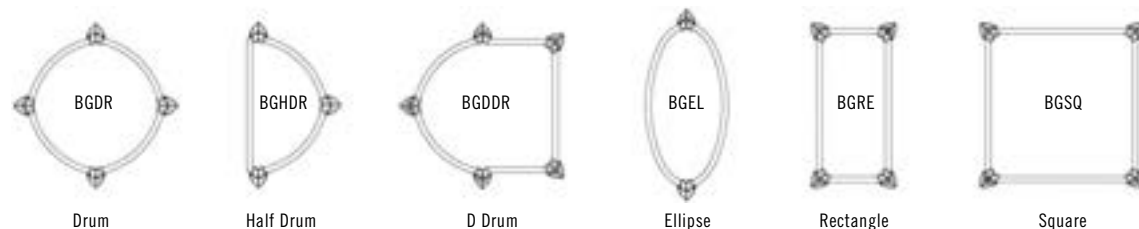

### Boardgames - Base Trim Profiles

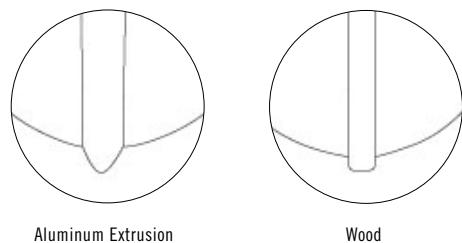



# BOARDGAMES BOARDROOM TABLES TABLETOPS

BACK TO CONTENTS



MODEL	TABLETOPS		TOP AND EDGE SPECIFICATIONS						BASES			LBS
	Code	Number of Sections	For Laminate Top			For Veneer Top			Number of Bases Required			
			SE	HF	HBV	HF2	HF	HF2	BGDR			
			PVF	HB	HBVR	HB2	HB	HB2	BGSQ			
			PVB		HGG	HKNR4	HBV	HKNR4	PLSQ			
			2MM			HKNR4	HBVR	HKNR4				
						HGG2	HGG	HGG2				
<i>Round</i>												
<b>42</b>	<b>42D</b>	1	610	1137	1251	1493	1518	1804	1			110
<b>48</b>	<b>48D</b>	1	631	1339	1463	1583	2017	2385	1			126
<b>54</b>	<b>54D</b>	1	897	1940	2132	2316	2532	3004	1			146
<b>60</b>	<b>60D</b>	1	940	2125	2330	2485	3113	3700	1			165

## BASES

MODEL	BASE SHAPES	FINISH	BASE PRICE	LBS	
		<i>Aluminum or Wood Trim</i>			
<b>BGDR-L</b>		<b>BOARDGAME DRUM</b>	Laminate	1354	75
<b>BGDR-V</b>			Veneer	1514	75
<b>BGSQ-L</b>		<b>BOARDGAME SQUARE</b>	Laminate	894	70
<b>BGSQ-V</b>			Veneer	1054	70
<b>PLSQ-L</b>		<b>PLINTH BASE SQUARE</b>	Laminate	894	70
<b>PLSQ-V</b>			Veneer	1054	70

\*Bases standard in 22" width. 30" width available, please contact factory for pricing.



BGDR-V



BGSQ-V



PLSQ-V





# BOARDGAMES BOARDROOM TABLES TABLETOPS

BACK TO CONTENTS



MODEL	TABLETOPS		TOP AND EDGE SPECIFICATIONS						BASES			LBS
	Code	Number of Sections	For Laminate Top			For Veneer Top			Number of Bases Required			
			SE	HF	HBV	HF2	HF	HF2	BGDR			
			PVF	HB	HBVR	HB2	HB	HB2	BGSQ			
			PVB		HGG	HKNR4	HBV	HKNR4	PLSQ			
			2MM			HKNR4	HBVR	HKNR4				
						HGG2	HGG	HGG2				
<i>Square</i>												
<b>36 x 36</b>	<b>36SQ</b>	1	367	571	627	820	826	1010	1			98
<b>42 x 42</b>	<b>42SQ</b>	1	624	919	1010	1101	1164	1415	1			112
<b>48 x 48</b>	<b>48SQ</b>	1	765	1024	1120	1162	1509	1831	1			128
<b>54 x 54</b>	<b>54SQ</b>	1	899	1471	1621	1795	1890	2308	1			146
<b>60 x 60</b>	<b>60SQ</b>	1	927	1568	1727	1903	2328	2834	1			165

## BASES

MODEL	BASE SHAPES	FINISH	BASE PRICE	LBS	
		<i>Aluminum or Wood Trim</i>			
BGDR-L		BOARDGAME DRUM	Laminate	1354	75
BGDR-V			Veneer	1514	75
BGSQ-L		BOARDGAME SQUARE	Laminate	894	70
BGSQ-V			Veneer	1054	70
PLSQ-L		PLINTH BASE SQUARE	Laminate	894	70
PLSQ-V			Veneer	1054	70

\*Bases standard in 22" width. 30" width available, please contact factory for pricing.



BGDR-V



BGSQ-V



PLSQ-V



# BOARDGAMES BOARDROOM TABLES TABLETOPS

BACK TO CONTENTS



MODEL	TABLETOPS		TOP AND EDGE SPECIFICATIONS						BASES		LBS
	Code	Number of Sections	For Laminate Top			For Veneer Top			Number of Bases Required		
			SE PVF PVB 2MM	HF HB	HBV HBVR HBG	HF2 HB2 HKN4 HKNR4 HBG2	HF HB HBV HBG	HF2 HB2 HKN4 HKNR4 HBG2	BGEL BGRE BGHDR*	BGDR BGSQ BGDDR* PLSQ	
<i>Rectangle</i>											
48 x 96	4896RE	1	1298	2131	2357	2584	2922	3574	2	2	135
48 x 120	48120RE	2	1608	2683	2938	3487	3569	4330	3	2	168
48 x 144	48144RE	2	1971	3513	3848	4371	4247	5164	3	2	202
48 x 168	48168RE	2	2432	3984	4367	5097	4928	5994	3	3	236
48 x 192	48192RE	2	2727	4749	5214	6255	5899	7174	3	3	269
48 x 216	48216RE	2	3292	5294	5806	6913	6576	8013	3	3	303
60 x 120	60120RE	2	2051	3659	4010	4553	4424	5379	3	2	210
60 x 144	60144RE	2	2462	4391	4812	5462	5309	6455	3	2	252
60 x 168	60168RE	2	2873	5124	5612	6374	6193	7530	3	3	294
60 x 192	60192RE	2	3450	6149	6733	7647	7432	9036	3	3	336
60 x 216	60216RE	2	3879	6917	7578	8603	8361	10164	3	3	378

When specifying Half Drum (BGHDR) or D-Drum (BGDDR) bases where 3 bases are required, the middle base should be specified as a Rectangle base (BGRE).



## BASES

MODEL	BASE SHAPES	FINISH	BASE PRICE	LBS	
		<i>Aluminum or Wood Trim</i>			
BGDR-L		BOARDGAME DRUM	Laminate	1354	75
BGDR-V			Veneer	1514	75
BGRE-L		BOARDGAME RECTANGLE	Laminate	894	70
BGRE-V			Veneer	1054	70
BGSQ-L		BOARDGAME SQUARE	Laminate	894	70
BGSQ-V			Veneer	1054	70
BGEL-L		BOARDGAME ELLIPSE	Laminate	958	65
BGEL-V			Veneer	1121	65
BGDDR-L		BOARDGAME D-DRUM	Laminate	1511	85
BGDDR-V			Veneer	1675	85
BGHDR-L		BOARDGAME HALF DRUM	Laminate	1090	65
BGHDR-V			Veneer	1252	65
PLSQ-L		PLINTH BASE SQUARE	Laminate	894	70
PLSQ-V			Veneer	1054	70
PLRE-L		PLINTH BASE RECTANGLE	Laminate	894	70
PLRE-V			Veneer	1054	70

\*Bases standard in 22" width. 30" width available, please contact factory for pricing.

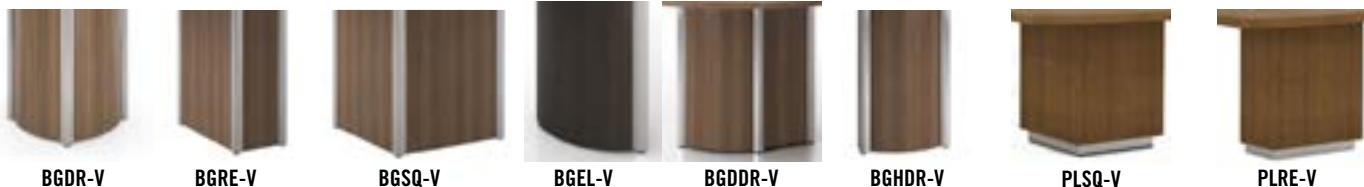



# BOARDGAMES BOARDROOM TABLES TABLETOPS

BACK TO CONTENTS



MODEL	TABLETOPS		TOP AND EDGE SPECIFICATIONS						BASES		LBS
	Code	Number of Sections	For Laminate Top			For Veneer Top			Number of Bases Required		
			SE PVF PVB 2MM	HF HB	HBV HBVR HBG	HF2 HB2 HKNR4 HBG2	HF HB HBV HBG	HF2 HB2 HKNR4 HBG2	BGEL BGRE BGHDR*	BGDR BGSQ BGDDR*	
<i>Rectangle Arc Ends</i>											
48 x 96	4896REA	1	1318	2259	2488	3040	3430	4125	2	2	135
48 x 120	48120REA	2	1632	3126	3425	4186	4154	4966	3	2	168
48 x 144	48144REA	2	1998	3859	4225	5169	4950	5934	3	2	202
48 x 168	48168REA	2	2462	4485	4914	5961	5757	6898	3	3	236
48 x 192	48192REA	2	2633	5275	5785	6794	7064	7864	3	3	269
48 x 216	48216REA	2	3292	5916	6490	7741	8050	8827	3	3	303
60 x 120	60120REA	2	2041	3908	4279	5235	5192	6211	3	2	210
60 x 144	60144REA	2	2498	4823	5283	6464	6189	7419	3	2	252
60 x 168	60168REA	2	3079	5609	6144	7449	7197	8623	3	3	294
60 x 192	60192REA	2	3693	6730	7374	8939	9298	10348	3	3	336
60 x 216	60216REA	2	4155	7571	8294	10057	10460	11641	3	3	378

When specifying Half Drum (BGHDR) or D-Drum (BGDDR) bases where 3 bases are required, the middle base should be specified as a Rectangle base (BGRE).

## BASES

MODEL	BASE SHAPES	FINISH	BASE PRICE	LBS	
		<i>Aluminum or Wood Trim</i>			
BGDR-L		BOARDGAME DRUM	Laminate	1354	75
BGDR-V			Veneer	1514	75
BGRE-L		BOARDGAME RECTANGLE	Laminate	894	70
BGRE-V			Veneer	1054	70
BGSQ-L		BOARDGAME SQUARE	Laminate	894	70
BGSQ-V			Veneer	1054	70
BGEL-L		BOARDGAME ELLIPSE	Laminate	958	65
BGEL-V			Veneer	1121	65
BGDDR-L		BOARDGAME D-DRUM	Laminate	1511	85
BGDDR-V			Veneer	1675	85
BGHDR-L		BOARDGAME HALF DRUM	Laminate	1090	65
BGHDR-V			Veneer	1252	65
PLSQ-L		PLINTH BASE SQUARE	Laminate	894	70
PLSQ-V			Veneer	1054	70
PLRE-L		PLINTH BASE RECTANGLE	Laminate	894	70
PLRE-V			Veneer	1054	70

\*Bases standard in 22" width. 30" width available, please contact factory for pricing.





# BOARDGAMES BOARDROOM TABLES TABLETOPS

BACK TO CONTENTS

MODEL	TABLETOPS		TOP AND EDGE SPECIFICATIONS						BASES		LBS
	Code	Number of Sections	For Laminate Top			For Veneer Top			Number of Bases Required		
			SE PVF PVB 2MM	HF HB	HBV HBVR HBG	HF2 HB2 HKN4 HKNR4 HBG2	HF HB HBV HBG	HF2 HB2 HKN4 HKNR4 HBG2	BGEL BGRE BGHDR*	BGDR BGSQ BGDDR*	
<i>Racetrack</i>											
48 x 96	4896RT	1	1318	2259	2488	3040	3430	4125	2	2	135
48 x 120	48120RT	2	1632	3126	3425	4186	4154	4966	3	2	168
48 x 144	48144RT	2	1998	3859	4225	5169	4950	5934	3	2	202
48 x 168	48168RT	2	2462	4485	4914	5961	5757	6898	3	3	236
48 x 192	48192RT	2	2633	5275	5785	6794	7064	7864	3	3	269
48 x 216	48216RT	2	3292	5916	6490	7741	8050	8827	3	3	303
60 x 120	60120RT	2	2041	3908	4279	5235	5192	6211	3	2	210
60 x 144	60144RT	2	2498	4823	5283	6464	6189	7419	3	2	252
60 x 168	60168RT	2	3079	5609	6144	7449	7197	8623	3	3	294
60 x 192	60192RT	2	3693	6730	7374	8939	9298	10348	3	3	336
60 x 216	60216RT	2	4155	7571	8294	10057	10460	11641	3	3	378

When specifying Half Drum (BGHDR) or D-Drum (BGDDR) bases where 3 bases are required, the middle base should be specified as a Rectangle base (BGRE).

## BASES

MODEL	BASE SHAPES	FINISH	BASE PRICE	LBS	
		<i>Aluminum or Wood Trim</i>			
BGDR-L		BOARDGAME DRUM	Laminate	1354	75
BGDR-V			Veneer	1514	75
BGRE-L		BOARDGAME RECTANGLE	Laminate	894	70
BGRE-V			Veneer	1054	70
BGSQ-L		BOARDGAME SQUARE	Laminate	894	70
BGSQ-V			Veneer	1054	70
BGEL-L		BOARDGAME ELLIPSE	Laminate	958	65
BGEL-V			Veneer	1121	65
BGDDR-L		BOARDGAME D-DRUM	Laminate	1511	85
BGDDR-V			Veneer	1675	85
BGHDR-L		BOARDGAME HALF DRUM	Laminate	1090	65
BGHDR-V			Veneer	1252	65
PLSQ-L		PLINTH BASE SQUARE	Laminate	894	70
PLSQ-V			Veneer	1054	70
PLRE-L		PLINTH BASE RECTANGLE	Laminate	894	70
PLRE-V			Veneer	1054	70

\*Bases standard in 22" width. 30" width available, please contact factory for pricing.

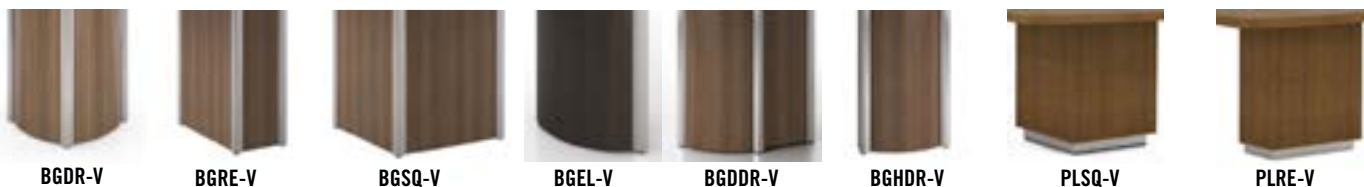



# BOARDGAMES BOARDROOM TABLES TABLETOPS

BACK TO CONTENTS



MODEL	TABLETOPS		TOP AND EDGE SPECIFICATIONS						BASES		LBS
	Code	Number of Sections	For Laminate Top			For Veneer Top			Number of Bases Required		
			SE PVF PVB 2MM	HF HB	HBV HBVR HBG	HF2 HB2 HKNR4 HBG2	HF HB HBV HBG	HF2 HB2 HKNR4 HBG2	BGEL BGRE BGHDR*	BGDR BGSQ BGDDR*	
<i>Boatshape</i>											
48 x 96	4896BT	1	1318	2901	3196	3500	3931	4310	2	2	135
48 x 120	48120BT	2	1632	3830	4196	4581	4746	5183	3	2	168
48 x 144	48144BT	2	1998	4563	4999	5462	6046	6444	3	2	202
48 x 168	48168BT	2	2462	5264	5771	6306	6579	7194	3	3	236
48 x 192	48192BT	2	2633	6070	6654	7812	8123	9043	3	3	269
48 x 216	48216BT	2	3292	6802	7462	8902	9258	10150	3	3	303
60 x 120	60120BT	2	2041	4786	5246	5727	5934	6478	3	2	210
60 x 144	60144BT	2	2498	5705	6250	6829	7557	8056	3	2	252
60 x 168	60168BT	2	3079	6582	7215	7884	8222	8993	3	3	294
60 x 192	60192BT	2	3693	7897	8657	9461	9867	10791	3	3	336
60 x 216	60216BT	2	4155	8884	9741	10644	11100	12141	3	3	378

When specifying Half Drum (BGHDR) or D-Drum (BGDDR) bases where 3 bases are required, the middle base should be specified as a Rectangle base (BGRE).

## BASES

MODEL	BASE SHAPES	FINISH	BASE PRICE	LBS	
		<i>Aluminum or Wood Trim</i>			
BGDR-L		BOARDGAME DRUM	Laminate	1354	75
BGDR-V			Veneer	1514	75
BGRE-L		BOARDGAME RECTANGLE	Laminate	894	70
BGRE-V			Veneer	1054	70
BGSQ-L		BOARDGAME SQUARE	Laminate	894	70
BGSQ-V			Veneer	1054	70
BGEL-L		BOARDGAME ELLIPSE	Laminate	958	65
BGEL-V			Veneer	1121	65
BGDDR-L		BOARDGAME D-DRUM	Laminate	1511	85
BGDDR-V			Veneer	1675	85
BGHDR-L		BOARDGAME HALF DRUM	Laminate	1090	65
BGHDR-V			Veneer	1252	65
PLSQ-L		PLINTH BASE SQUARE	Laminate	894	70
PLSQ-V			Veneer	1054	70
PLRE-L		PLINTH BASE RECTANGLE	Laminate	894	70
PLRE-V			Veneer	1054	70

\*Bases standard in 22" width. 30" width available, please contact factory for pricing.





# BOARDGAMES BOARDROOM TABLES TABLETOPS

BACK TO CONTENTS



MODEL	TABLETOPS		TOP AND EDGE SPECIFICATIONS						BASES		LBS
	Code	Number of Sections	For Laminate Top			For Veneer Top			Number of Bases Required		
			SE PVF PVB 2MM	HF HB	HBV HBVR HBG	HF2 HB2 HKNR4 HBG2	HF HB HBV HBG	HF2 HB2 HKNR4 HBG2	BGEL BGRE BGHDR*	BGDR BGSQ BGDDR*	
<i>Boatshape Arc Ends</i>											
48 x 96	4896BTA	1	1478	3406	3702	4008	4436	4816	2	2	135
48 x 120	48120BTA	2	1793	4337	4703	5089	5253	5688	3	2	168
48 x 144	48144BTA	2	2159	5068	5507	5970	6551	6951	3	2	202
48 x 168	48168BTA	2	2624	5771	6279	6814	7084	7702	3	3	236
48 x 192	48192BTA	2	2897	6676	7319	8594	8937	9948	3	3	269
48 x 216	48216BTA	2	3620	7484	8210	9791	10184	11167	3	3	303
60 x 120	60120BTA	2	2243	5422	5878	6361	6566	7110	3	2	210
60 x 144	60144BTA	2	2698	6336	6884	7462	8190	8687	3	2	252
60 x 168	60168BTA	2	3279	7215	7848	8515	8857	9628	3	3	294
60 x 192	60192BTA	2	3936	8657	9418	10217	10627	11554	3	3	336
60 x 216	60216BTA	2	4429	9741	10596	11495	11955	12997	3	3	378

When specifying Half Drum (BGHDR) or D-Drum (BGDDR) bases where 3 bases are required, the middle base should be specified as a Rectangle base (BGRE).

## BASES

MODEL	BASE SHAPES	FINISH	BASE PRICE	LBS	
		<i>Aluminum or Wood Trim</i>			
BGDR-L		BOARDGAME DRUM	Laminate	1354	75
BGDR-V			Veneer	1514	75
BGRE-L		BOARDGAME RECTANGLE	Laminate	894	70
BGRE-V			Veneer	1054	70
BGSQ-L		BOARDGAME SQUARE	Laminate	894	70
BGSQ-V			Veneer	1054	70
BGEL-L		BOARDGAME ELLIPSE	Laminate	958	65
BGEL-V			Veneer	1121	65
BGDDR-L		BOARDGAME D-DRUM	Laminate	1511	85
BGDDR-V			Veneer	1675	85
BGHDR-L		BOARDGAME HALF DRUM	Laminate	1090	65
BGHDR-V			Veneer	1252	65
PLSQ-L		PLINTH BASE SQUARE	Laminate	894	70
PLSQ-V			Veneer	1054	70
PLRE-L		PLINTH BASE RECTANGLE	Laminate	894	70
PLRE-V			Veneer	1054	70

\*Bases standard in 22" width. 30" width available, please contact factory for pricing.







# BOARDGAMES BOARDROOM TABLES TABLETOPS

BACK TO CONTENTS



MODEL	TABLETOPS		TOP AND EDGE SPECIFICATIONS						BASES		LBS
	Code	Number of Sections	For Laminate Top			For Veneer Top			Number of Bases Required		
			SE PVF PVB 2MM	HF HB	HBV HBVR HBG	HF2 HB2 HKN4 HKNR4 HBG2	HF HB HBV HBG	HF2 HB2 HKN4 HKNR4 HBG2	BGEL BGRE BGHDR*	BGDR BGSQ BGDDR*	
<i>Ellipse</i>											
48 x 96	4896EL	1	1581	3480	3835	4201	4716	5170	2	2	135
48 x 120	48120EL	2	1960	4596	5036	5498	5697	6218	3	2	168
48 x 144	48144EL	2	2397	5475	5999	6556	7255	7734	3	2	202
48 x 168	48168EL	2	2956	6317	6926	7567	7869	8634	3	3	236
48 x 192	48192EL	2	3185	7344	8051	9452	9831	10943	3	3	269
48 x 216	48216EL	2	3982	8232	9030	10770	11201	12283	3	3	303
60 x 120	60120EL	2	2580	6235	6760	7315	7551	8176	3	2	210
60 x 144	60144EL	2	3103	7286	7916	8582	9418	9991	3	2	252
60 x 168	60168EL	2	3772	8298	9026	9793	10186	11072	3	3	294
60 x 192	60192EL	2	4527	9955	10830	11750	12222	13287	3	3	336
60 x 216	60216EL	2	5094	11201	12185	13219	13749	14946	3	3	378

When specifying Half Drum (BGHDR) or D-Drum (BGDDR) bases where 3 bases are required, the middle base should be specified as a Rectangle base (BGRE).

## BASES

MODEL	BASE SHAPES	FINISH	BASE PRICE	LBS	
		<i>Aluminum or Wood Trim</i>			
BGDR-L		BOARDGAME DRUM	Laminate	1354	75
BGDR-V			Veneer	1514	75
BGRE-L		BOARDGAME RECTANGLE	Laminate	894	70
BGRE-V			Veneer	1054	70
BGSQ-L		BOARDGAME SQUARE	Laminate	894	70
BGSQ-V			Veneer	1054	70
BGEL-L		BOARDGAME ELLIPSE	Laminate	958	65
BGEL-V			Veneer	1121	65
BGDDR-L		BOARDGAME D-DRUM	Laminate	1511	85
BGDDR-V			Veneer	1675	85
BGHDR-L		BOARDGAME HALF DRUM	Laminate	1090	65
BGHDR-V			Veneer	1252	65
PLSQ-L		PLINTH BASE SQUARE	Laminate	894	70
PLSQ-V			Veneer	1054	70
PLRE-L		PLINTH BASE RECTANGLE	Laminate	894	70
PLRE-V			Veneer	1054	70

\*Bases standard in 22" width. 30" width available, please contact factory for pricing.

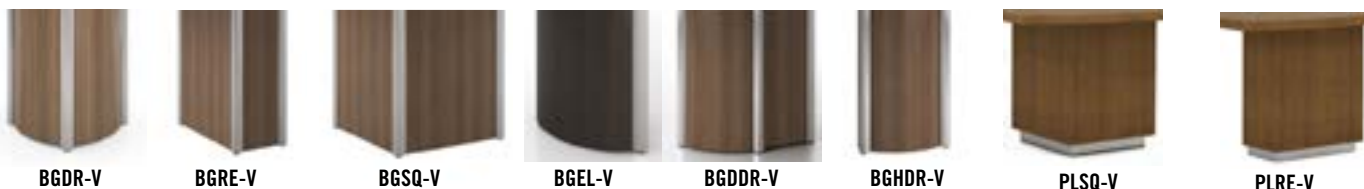



# BOARDGAMES BOARDROOM TABLES TABLETOPS

BACK TO CONTENTS



MODEL	TABLETOPS		TOP AND EDGE SPECIFICATIONS						BASES		LBS
	Code	Number of Sections	For Laminate Top			For Veneer Top			Number of Bases Required		
			SE PVF PVB 2MM	HF HB	HBV HBVR HBG	HF2 HB2 HKNR4 HBG2	HF HB HBV HBG	HF2 HB2 HKNR4 HBG2	BGEL BGRE BGHDR*	BGDR BGSQ BGDDR* PLSQ	
<i>Video Conference</i>											
48 x 96	4896VC	1	1318	2901	3196	3500	3931	4310	2	2	135
48 x 120	48120VC	2	1632	3830	4196	4581	4746	5183	3	2	168
48 x 144	48144VC	2	1998	4563	4999	5462	6046	6444	3	2	202
48 x 168	48168VC	2	2462	5264	5771	6306	6559	7194	3	3	236
48 x 192	48192VC	2	2633	6070	6654	7812	8123	9043	3	3	269
48 x 216	48216VC	2	3292	6802	7462	8902	9258	10150	3	3	303
60 x 120	60120VC	2	2041	4786	5246	5727	5934	6478	3	2	210
60 x 144	60144VC	2	2498	5705	6250	6829	7557	8056	3	2	252
60 x 168	60168VC	2	3079	6582	7215	7884	8222	8993	3	3	294
60 x 192	60192VC	2	3693	7897	8657	9461	9867	10791	3	3	336
60 x 216	60216VC	2	4155	8884	9741	10644	11100	12141	3	3	378

When specifying Half Drum (BGHDR) or D-Drum (BGDDR) bases where 3 bases are required, the middle base should be specified as a Rectangle base (BGRE).

## BASES

MODEL	BASE SHAPES	FINISH	BASE PRICE	LBS	
		<i>Aluminum or Wood Trim</i>			
BGDR-L		BOARDGAME DRUM	Laminate	1354	75
BGDR-V			Veneer	1514	75
BGRE-L		BOARDGAME RECTANGLE	Laminate	894	70
BGRE-V			Veneer	1054	70
BGSQ-L		BOARDGAME SQUARE	Laminate	894	70
BGSQ-V			Veneer	1054	70
BGEL-L		BOARDGAME ELLIPSE	Laminate	958	65
BGEL-V			Veneer	1121	65
BGDDR-L		BOARDGAME D-DRUM	Laminate	1511	85
BGDDR-V			Veneer	1675	85
BGHDR-L		BOARDGAME HALF DRUM	Laminate	1090	65
BGHDR-V			Veneer	1252	65
PLSQ-L		PLINTH BASE SQUARE	Laminate	894	70
PLSQ-V			Veneer	1054	70
PLRE-L		PLINTH BASE RECTANGLE	Laminate	894	70
PLRE-V			Veneer	1054	70

\*Bases standard in 22" width. 30" width available, please contact factory for pricing.





# BOARDGAMES BOARDROOM TABLES TABLETOPS

BACK TO CONTENTS



MODEL	TABLETOPS		TOP AND EDGE SPECIFICATIONS						BASES		LBS
	Code	Number of Sections	For Laminate Top			For Veneer Top			Number of Bases Required		
			SE PVF PVB 2MM	HF HB	HBV HBVR HBG	HF2 HB2 HKNR4 HBG2	HF HB HBV HBG	HF2 HB2 HKNR4 HBG2	BGEL BGRE BGHDR*	BGDR BGSQ BGDDR* PLSQ	
<i>Video Conference Arc Ends</i>											
48 x 96	4896VCA	1	1478	3406	3702	4008	4436	4816	2	2	135
48 x 120	48120VCA	2	1793	4337	4703	5089	5253	5688	3	2	168
48 x 144	48144VCA	2	2159	5068	5507	5970	6551	6951	3	2	202
48 x 168	48168VCA	2	2624	5771	6279	6814	7084	7702	3	3	236
48 x 192	48192VCA	2	2897	6676	7319	8594	8937	9948	3	3	269
48 x 216	48216VCA	2	3620	7484	8210	9791	10184	11167	3	3	303
60 x 120	60120VCA	2	2243	5422	5878	6361	6566	7110	3	2	210
60 x 144	60144VCA	2	2698	6336	6884	7462	8190	8687	3	2	252
60 x 168	60168VCA	2	3279	7215	7848	8515	8857	9628	3	3	294
60 x 192	60192VCA	2	3936	8657	9418	10217	10627	11554	3	3	336
60 x 216	60216VCA	2	4429	9741	10596	11495	11955	12997	3	3	378

When specifying Half Drum (BGHDR) or D-Drum (BGDDR) bases where 3 bases are required, the middle base should be specified as a Rectangle base (BGRE).

## BASES

MODEL	BASE SHAPES	FINISH	BASE PRICE	LBS	
		<i>Aluminum or Wood Trim</i>			
BGDR-L		BOARDGAME DRUM	Laminate	1354	75
BGDR-V			Veneer	1514	75
BGRE-L		BOARDGAME RECTANGLE	Laminate	894	70
BGRE-V			Veneer	1054	70
BGSQ-L		BOARDGAME SQUARE	Laminate	894	70
BGSQ-V			Veneer	1054	70
BGEL-L		BOARDGAME ELLIPSE	Laminate	958	65
BGEL-V			Veneer	1121	65
BGDDR-L		BOARDGAME D-DRUM	Laminate	1511	85
BGDDR-V			Veneer	1675	85
BGHDR-L		BOARDGAME HALF DRUM	Laminate	1090	65
BGHDR-V			Veneer	1252	65
PLSQ-L		PLINTH BASE SQUARE	Laminate	894	70
PLSQ-V			Veneer	1054	70
PLRE-L		PLINTH BASE RECTANGLE	Laminate	894	70
PLRE-V			Veneer	1054	70

\*Bases standard in 22" width. 30" width available, please contact factory for pricing.

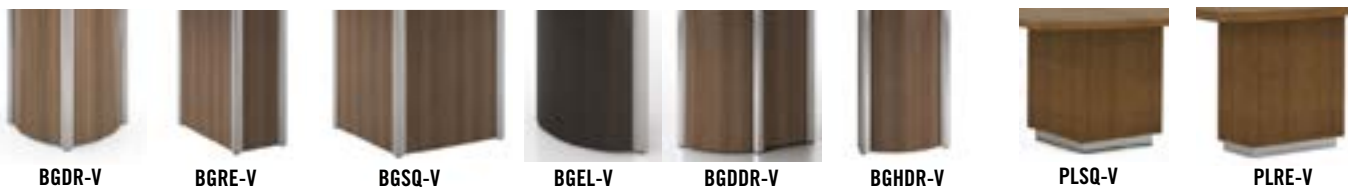



# BOARDGAMES BOARDROOM TABLES

## TABLETOP SECTIONS AND SEATING LAYOUTS

BACK TO CONTENTS

RECTANGLE		
Size / Shape	Number of Tabletop Sections	Number of Chairs (based on 25" wide chairs)
48 x 96RE	1	8
48 x 120RE	2	10
48 x 144RE	2	10
48 x 168RE	2	12
48 x 192RE	2	14
48 x 216RE	2	14
60 x 120RE	2	10
60 x 144RE	2	12
60 x 168RE	2	12
60 x 192RE	2	14
60 x 216RE	2	16

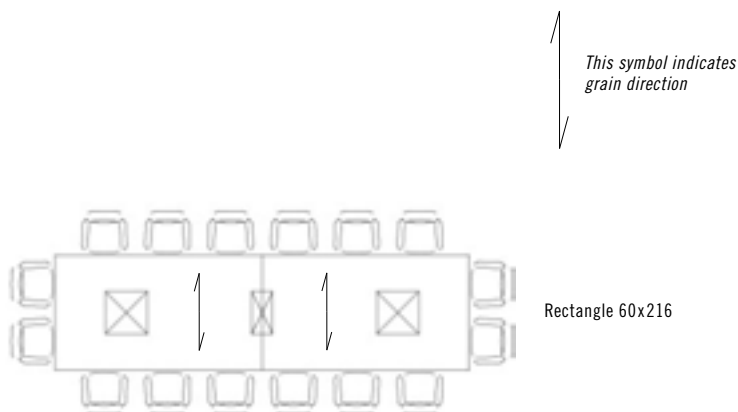

Rectangle 60x216

RACETRACK		
Size / Shape	Number of Tabletop Sections	Number of Chairs (based on 25" wide chairs)
48 x 96RT	1	8
48 x 120RT	2	10
48 x 144RT	2	10
48 x 168RT	2	12
48 x 192RT	2	14
48 x 216RT	2	14
60 x 120RT	2	10
60 x 144RT	2	12
60 x 168RT	2	12
60 x 192RT	2	14
60 x 216RT	2	16

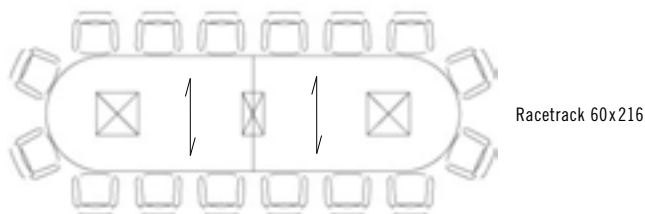

Racetrack 60x216

RECTANGLE ARC ENDS		
Size / Shape	Number of Tabletop Sections	Number of Chairs (based on 25" wide chairs)
48 x 96REA	1	8
48 x 120REA	2	10
48 x 144REA	2	10
48 x 168REA	2	12
48 x 192REA	2	14
48 x 216REA	2	14
60 x 120REA	2	10
60 x 144REA	2	12
60 x 168REA	2	12
60 x 192REA	2	14
60 x 216REA	2	16

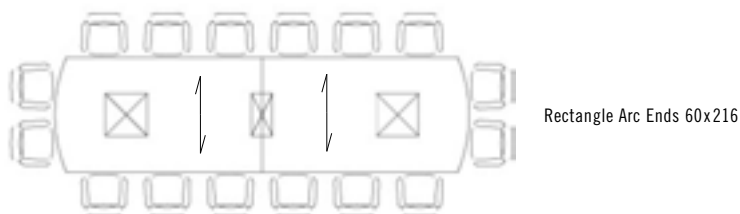

Rectangle Arc Ends 60x216



# BOARDGAMES BOARDROOM TABLES

## TABLETOP SECTIONS AND SEATING LAYOUTS

BACK TO CONTENTS

BOATSHAPE		
Size / Shape	Number of Tabletop Sections	Number of Chairs (based on 25" wide chairs)
48 x 96BT	1	8
48 x 120BT	2	10
48 x 144BT	2	10
48 x 168BT	2	12
48 x 192BT	2	14
48 x 216BT	2	14
60 x 120BT	2	10
60 x 144BT	2	12
60 x 168BT	2	12
60 x 192BT	2	14
60 x 216BT	2	16
Standard with 12" Taper		

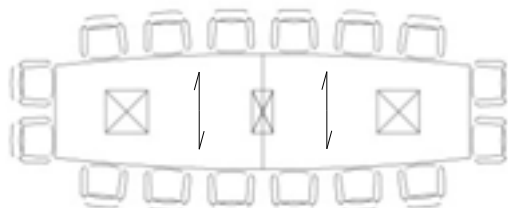

Boatshape 60x216

This symbol indicates grain direction

BOATSHAPE ARC ENDS		
Size / Shape	Number of Tabletop Sections	Number of Chairs (based on 25" wide chairs)
48 x 96BTA	1	8
48 x 120BTA	2	10
48 x 144BTA	2	10
48 x 168BTA	2	12
48 x 192BTA	2	14
48 x 216BTA	2	14
60 x 120BTA	2	10
60 x 144BTA	2	12
60 x 168BTA	2	12
60 x 192BTA	2	14
60 x 216BTA	2	16

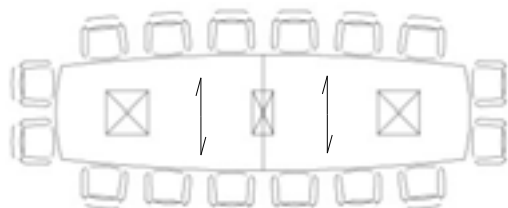

Boatshape Arc Ends 60x216

ELLIPSE		
Size / Shape	Number of Tabletop Sections	Number of Chairs (based on 25" wide chairs)
48 x 96EL	1	6
48 x 120EL	2	6
48 x 144EL	2	8
48 x 168EL	2	10
48 x 192EL	2	10
48 x 216EL	2	12
60 x 120EL	2	8
60 x 144EL	2	10
60 x 168EL	2	10
60 x 192EL	2	12
60 x 216EL	2	14

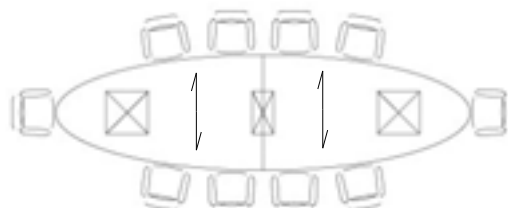

Ellipse 60x216



# BOARDGAMES BOARDROOM TABLES TABLETOP SECTIONS AND SEATING LAYOUTS

VIDEO CONFERENCE		
Size / Shape	Number of Tabletop Sections	Number of Chairs (based on 25" wide chairs)
48 x 96VC	1	4
48 x 120VC	2	6
48 x 144VC	2	6
48 x 168VC	2	8
48 x 192VC	2	10
48 x 216VC	2	10
60 x 120VC	2	6
60 x 144VC	2	6
60 x 168VC	2	8
60 x 192VC	2	14
60 x 216VC	2	16
Standard with 12" Taper		

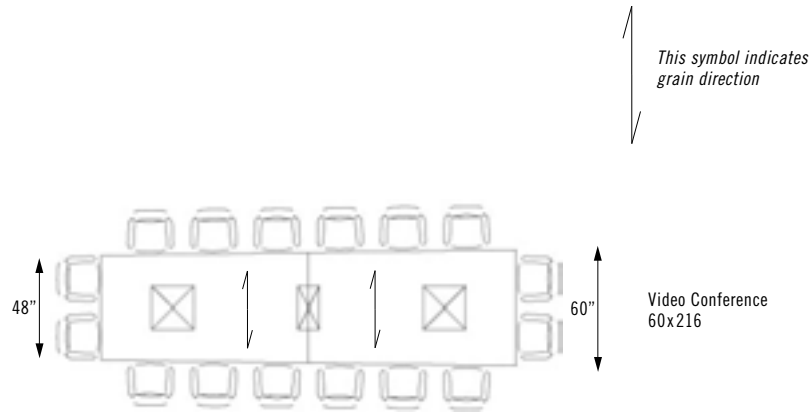

VIDEO CONFERENCE ARC		
Size / Shape	Number of Tabletop Sections	Number of Chairs (based on 25" wide chairs)
48 x 96VCA	1	4
48 x 120VCA	2	6
48 x 144VCA	2	6
48 x 168VCA	2	8
48 x 192VCA	2	10
48 x 216VCA	2	10
60 x 120VCA	2	6
60 x 144VCA	2	6
60 x 168VCA	2	8
60 x 192VCA	2	14
60 x 216VCA	2	16
Standard with 12" Taper		

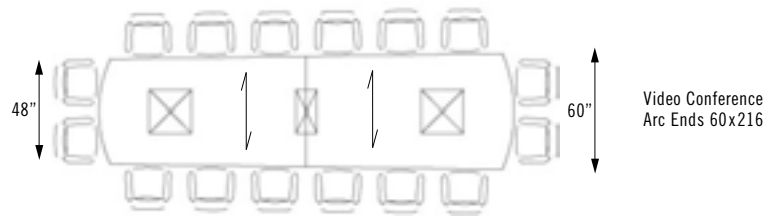

## LARGER TABLE SIZES

Boardgames tabletops with a length of 108" to 216" and a width that doesn't exceeds 60", will be made in 2 equal pieces. Boardgames tabletops with a length of 216" to 324" and a width that doesn't exceed 60", will be made in 3 equal pieces. All multiple piece tabletops are tight joint fastened. Bases standard in 22" width. 30" width available. Please contact factory for pricing.

## WOOD FINISHES AND GRAIN DIRECTION

### Finishes

Veneers and hardwood edge finishes are available in our 7 standard stains or stain-to-match which is never an upcharge.

### Grain Direction

The grain on a single piece boardroom tabletop will run lengthwise. The grain on a 2 piece or more top runs from side to side, signified on line drawing with grain direction symbol. Laminates with wood grain patterns follow the same direction as veneer wood grains.

# BOARDGAMES BOARDROOM TABLES POWER AND VOICE/DATA MODULES

BACK TO CONTENTS

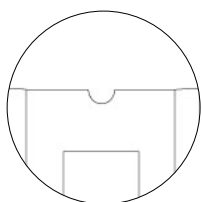
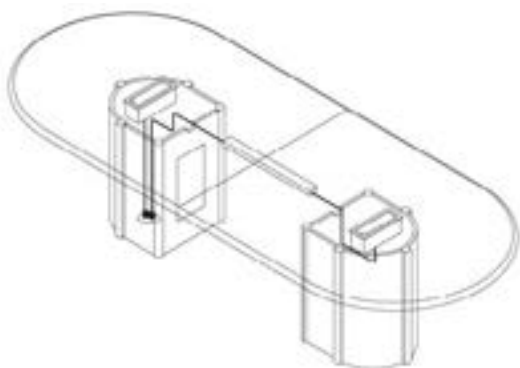
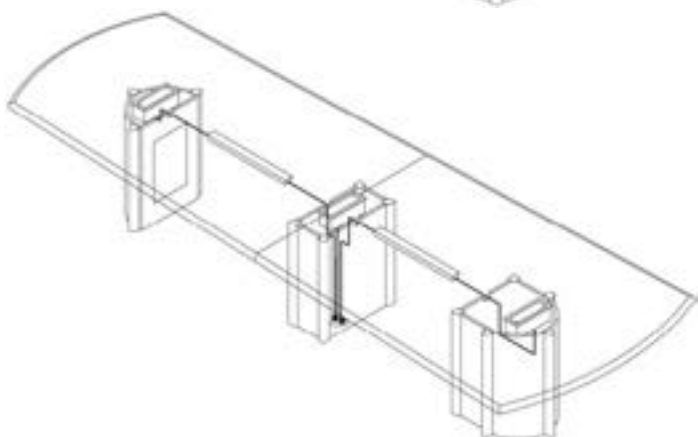
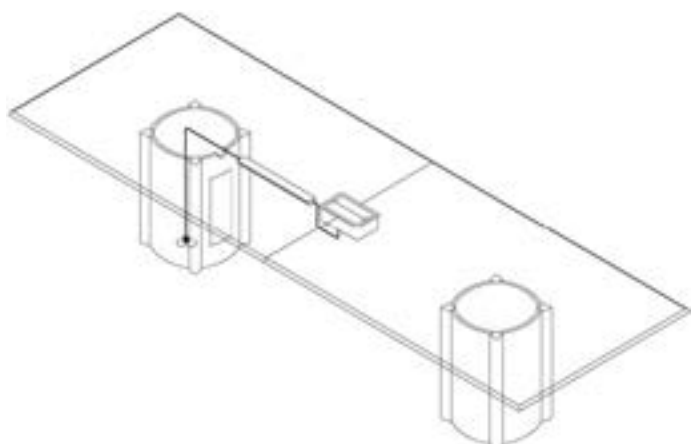

All Boardgames bases are standard with a touch latch removable door and a 3" cutout for wire pass-through at the top

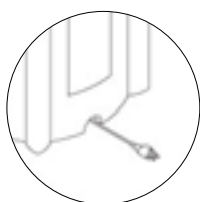

Optional cutout for wire pass-through at the bottom of Boardgames bases must be specified if required

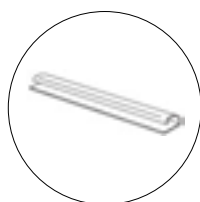

Tops are standard with 24" PVC under table wire manager between bases

BGDR  
Drum



BGHDR  
Half Drum



BGDDR  
D Drum



BGEL  
Ellipse



BGRE  
Rectangle



BGSQ  
Square



# CAST TABLES



PLACING AN ORDER IS EASY

## PRODUCT CODE

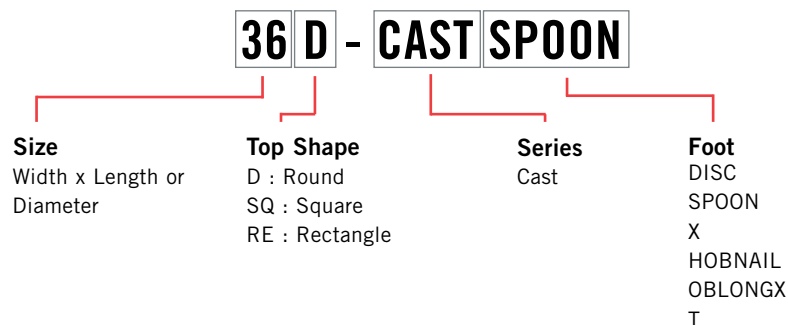

## OPTIONS

### FOOT OPTIONS



## FINISHES

### LAMINATE



Select laminate from our virtually unlimited laminate options

### VENEER

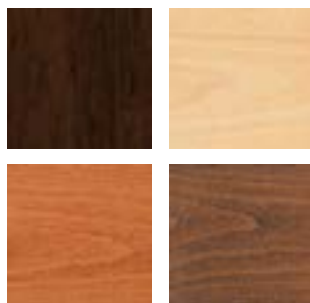

Select from one of our 7 standard wood stains or stain-to-match at no upcharge

### BASE



Select from one of our 5 textured Spectone colors at an upcharge.

### EDGE



Check out our website for a complete list of edge profiles.





# CAST BASE TABLES

BACK TO CONTENTS



MODEL	BASES		TOP SPECIFICATIONS					OPTIONS		LBS
	Code	Qty.	For Laminate Top		For Veneer Top			BAR HEIGHT	TEXTURED BASE COLORS <i>Black, Silver, Nickel, Deep Taupe, Nevada</i>	
			1"							
			PVF	HF	HF2	HF	HF2			
			PVB	HB	HB2	HB	HB2			
<i>Round</i>										
18D	CASTDISC	1	354	694	828	881	984	47	21	33
	CASTSPOON	1	375	715	849	902	1005	47	21	34
24D	CASTX	1	299	628	762	815	918	47	21	35
	CASTDISC	1	365	694	828	881	984	47	21	40
	CASTHOBNAIL	1	547	876	1010	1063	1166	47	21	58
	CASTSPOON	1	386	715	849	902	1005	47	21	41
30D	CASTX	1	394	718	961	910	1061	47	21	47
	CASTDISC	1	513	837	1080	1029	1180	47	21	62
	CASTHOBNAIL	1	642	966	1209	1158	1309	47	21	68
	CASTSPOON	1	541	865	1108	1057	1208	47	21	82
36D	CASTX	1	576	1047	1292	1342	1551	47	21	58
	CASTDISC	1	603	1074	1319	1369	1578	47	21	95
	CASTHOBNAIL	1	732	1203	1448	1498	1707	47	21	79
	CASTSPOON	1	631	1102	1347	1397	1606	47	21	93
42D	CASTX	1	837	1364	1720	1745	2031	47	21	69
	CASTDISC	1	1008	1535	1891	1916	2202	47	21	109
	CASTHOBNAIL	1	1172	1699	2055	2080	2366	47	21	119
	CASTSPOON	1	1059	1586	1942	1967	2253	47	21	107



36D-CASTDISC



36D-CASTSPOON



36D-CASTHOBNAIL



24SQ-CASTX

### STANDARD FEATURES

- Cast Bases are standard in matte black.
- Also available in 5 textured colors: Black, Silver, Nickel, Deep Taupe and Nevada at \$21 List upcharge per base.
- Laminate tops available in any standard Wilsonart, Nevamar, Formica, Arborite or Pionite matte finish offerings. For other laminate please contact the factory for pricing.
- PVC edges for 1" tops are available in flat or bullnose. 3/4" tops are only available in flat PVC.
- Hardwood edges are available for 1" tops only in flat or bullnose.
- Veneers and hardwood edges are standard in Oak, Maple, Cherry, Pecan, Walnut, Mahogany and Chocolate.
- Stain-to-match available at no upcharge.
- Standard table height 29".
- Bar height is 39". Other heights available.
- Bases are shipped unassembled. Some assembly is required.
- All bases are standard with floor leveling glides.

### OPTIONS

- Custom heights available.

### HOW TO ORDER

1. Select Model
2. Select Base
3. Select Edge Style
4. Select Options
5. Select Top Finish
6. Select Edge Finish
7. Select Base Finish

**Example:** 18D - CASTDISC - PVF -





# CAST BASE TABLES

BACK TO CONTENTS

MODEL	BASES		TOP SPECIFICATIONS					OPTIONS		LBS
	Code	Qty.	For Laminate Top			For Veneer Top		BAR HEIGHT	TEXTURED BASE COLORS <i>Black, Silver, Nickel, Deep Taupe, Nevada</i>	
			PVF PVB	HF HB	HF2 HB2	HF HB	HF2 HB2			
<i>Square</i>										
18 x 18SQ	CASTDISC	1	382	572	668	713	867	47	21	33
	CASTSPOON	1	403	593	689	734	888	47	21	34
24 x 24SQ	CASTX	1	327	506	602	647	801	47	21	35
	CASTDISC	1	393	572	668	713	867	47	21	40
	CASTHOBNAIL	1	575	754	850	895	1049	47	21	58
	CASTSPOON	1	414	593	689	734	888	47	21	41
30 x 30SQ	CASTX	1	517	647	858	799	1010	47	21	47
	CASTDISC	1	544	674	885	826	1037	47	21	62
	CASTHOBNAIL	1	673	803	1014	955	1166	47	21	68
	CASTSPOON	1	572	702	913	854	1065	47	21	82
36 x 36SQ	CASTX	1	594	798	1047	1053	1237	47	21	58
42 x 42SQ	CASTX	1	851	1146	1328	1391	1642	47	21	69



36D-CASTDISC



36D-CASTSPOON



36D-CASTHOBNAIL



24SQ-CASTX

### STANDARD FEATURES

- Cast Bases are standard in matte black.
- Also available in 5 textured colors: Black, Silver, Nickel, Deep Taupe and Nevada at \$21 List upcharge per base.
- Laminate tops available in any standard Wilsonart, Nevamar, Formica, Arborite or Pionite matte finish offerings. For other laminate please contact the factory for pricing.
- PVC edges for 1" tops are available in flat or bullnose. 3/4" tops are only available in flat PVC.
- Hardwood edges are available for 1" tops only in flat or bullnose.
- Veneers and hardwood edges are standard in Oak, Maple, Cherry, Pecan, Walnut, Mahogany and Chocolate.
- Stain-to-match available at no upcharge.
- Standard table height 29".
- Bar height is 39". Other heights available.
- Bases are shipped unassembled. Some assembly is required.
- All bases are standard with floor leveling glides.

### OPTIONS

- Custom heights available.

### HOW TO ORDER

1. Select Model
2. Select Base
3. Select Edge Style
4. Select Options
5. Select Top Finish
6. Select Edge Finish
7. Select Base Finish

**Example:** 18SQ - CASTDISC - PVF -

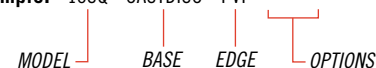



# CAST BASE TABLES

BACK TO CONTENTS

MODEL	BASES		TOP SPECIFICATIONS					OPTIONS		LBS
	Code	Qty.	For Laminate Top			For Veneer Top		BAR HEIGHT	TEXTURED BASE COLORS <i>Black, Silver, Nickel, Deep Taupe, Nevada</i>	
			1"							
			PVF PVB	HF HB	HF2 HB2	HF HB	HF2 HB2			
<i>Rectangle</i>										
24 x 36RE	OBLONGX	1	450	572	679	728	847	47	21	45
24 x 48RE	CASTT	2	580	776	919	975	1141	47	21	60
24 x 60RE	CASTT	2	635	921	1092	1171	1374	47	21	68
24 x 72RE	CASTT	2	771	1115	1324	1408	1657	47	21	77
30 x 48RE	CASTT	2	626	895	1063	1141	1343	47	21	68
30 x 60RE	CASTT	2	681	1048	1279	1369	1622	47	21	79
30 x 72RE	CASTT	2	896	1283	1579	1682	1989	47	21	89



2436RE-OBLONGX



2448RE-CASTT

### STANDARD FEATURES

- Cast Bases are standard in matte black.
- Also available in 5 textured colors: Black, Silver, Nickel, Deep Taupe and Nevada at \$21 List upcharge per base.
- Laminate tops available in any standard Wilsonart, Nevamar, Formica, Arborite or Pionite matte finish offerings. For other laminate please contact the factory for pricing.
- PVC edges for 1" tops are available in flat or bullnose. 3/4" tops are only available in flat PVC.
- Hardwood edges are available for 1" tops only in flat or bullnose.
- Veneers and hardwood edges are standard in Oak, Maple, Cherry, Pecan, Walnut, Mahogany and Chocolate.
- Stain-to-match available at no upcharge.
- Standard table height 29".
- Bar height is 39". Other heights available.
- Bases are shipped unassembled. Some assembly is required.
- All bases are standard with floor leveling glides.

### OPTIONS

- Custom heights available.

### HOW TO ORDER

1. Select Model
2. Select Base
3. Select Edge Style
4. Select Options
5. Select Top Finish
6. Select Edge Finish
7. Select Base Finish

**Example:** 2436RE - OBLONGX - PVF -

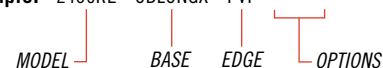

# CASTAWAY TABLES



PLACING AN ORDER IS EASY

## PRODUCT CODE

**2430 RE A T M**

**Size**

Width x Length

**Top Shape**

- D : Round RC90 : Radius (*connector*)
- SQ : Square TC90 : Triangle (*connector*)
- RE : Rectangle BT : Boatshape
- RT : Racetrack BTA : Boatshape Arc
- B : Bullet
- H : Halfmoon
- TP : Trapezoid

**Series**

Castaway Mast Column

**Base**

- X : X-Base
- X4 : 4 Column X-Base
- T : T-Base
- T2 : Double Column T-Base
- T2D : T2 with Door
- C : C-Base
- CEWT : C-Base with Trough

## OPTIONS

**FLIP TOP**



**CASTERS**



**FOLDING**



## FINISHES

**LAMINATE**



Select laminate from our virtually unlimited laminate options

**VENEER**

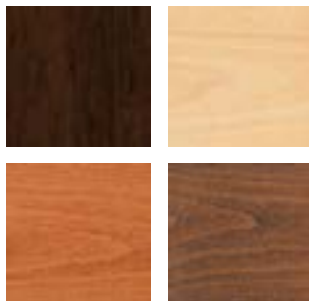

Select from one of our 7 standard wood stains or stain-to-match at no upcharge

**BASE**



Select from one of our 76 standard Spectone colors

**EDGE**



2MM PVC Hard Wood

Check out our website for a complete list of edge profiles.



# CASTAWAY GENERAL PURPOSE TABLES

MODEL	BASES		TOP SPECIFICATIONS						OPTIONS				LBS
	Code	Qty.	For Laminate Top			For Veneer Top			FLIP TOP (FL)	FOLD (F)	CASTERS (LC)	WHEELS (WB)	
			SE PVF PVB 2MM	HF HB	HBV HBVR HBG	HF2 HB2 HKNR4 HBG2	HF HB HBV HBG	HF2 HB2 HKNR4 HBG2					
<i>Round</i>													
24D	AXM	1	823	1152	1186	1286	1339	1442	141	-	84	-	33
	AXMA	1	928	1257	1291	1391	1444	1547	-	-	84	-	33
30D	AXM	1	918	1242	1286	1485	1434	1585	141	-	84	-	43
	AXMA	1	1023	1347	1391	1590	1539	1690	-	-	84	-	43
36D	AXM	1	1008	1479	1561	1724	1774	1983	141	-	84	-	54
	AXMA	1	1113	1584	1666	1829	1879	2088	-	-	84	-	54
42D	AX4M	1	1766	2293	2407	2649	2674	2960	-	-	-	-	68
48D	AX4M	1	1787	2495	2619	2739	3173	3541	-	-	84	-	84
54D	AX4M	1	2053	3096	3288	3472	3688	4160	-	-	-	-	102
60D	AX4M	1	2096	3281	3486	3641	4269	4856	-	-	-	-	121
<i>Square</i>													
24 x 24SQ	AXM	1	851	1030	1064	1126	1171	1325	141	-	84	-	33
	AXMA	1	956	1135	1169	1231	1276	1430	-	-	84	-	33
30 x 30SQ	AXM	1	949	1079	1126	1290	1231	1442	141	-	84	-	43
	AXMA	1	1054	1184	1231	1395	1336	1547	-	-	84	-	43
36 x 36SQ	AX4M	1	1523	1727	1783	1976	1982	2166	-	-	84	-	54
42 x 42SQ	AX4M	1	1780	2075	2166	2257	2320	2571	-	-	84	-	68
48 x 48SQ	AX4M	1	1921	2180	2276	2318	2665	2987	-	-	-	-	84
54 x 54SQ	AX4M	1	2055	2627	2777	2951	3046	3464	-	-	-	-	102
60 x 60SQ	AX4M	1	2083	2724	2883	3059	3484	3990	-	-	-	-	121



30D-AXM

42D-AX4M

### STANDARD FEATURES

- Laminate tops available in any standard Wilsonart, Nevamar, Formica, Arborite or Pionite matte finish offerings. For other laminate please contact the factory for pricing.
- Veneers and hardwood edges are standard in Oak, Maple, Cherry, Pecan, Walnut, Mahogany and Chocolate.
- 7 veneer and hardwood edge stains are standard. Stain-to-match available at no upcharge.
- Standard table height 29".
- The foot of the Castaway base is available in 5 textured finishes. The column is available in 76 standard finishes.
- All bases are standard with floor leveling glides.

### OPTIONS

- Custom heights available.

### HOW TO ORDER

1. Select Model
2. Select Base
3. Select Edge Style
4. Select Options
5. Select Top Finish
6. Select Edge Finish
7. Select Base Finish

**Example:** 24D - AXM - PVF -





# CASTAWAY GENERAL PURPOSE TABLES

MODEL	BASES		TOP SPECIFICATIONS						OPTIONS				LBS
	Code	Qty.	For Laminate Top			For Veneer Top			FLIP TOP (FL)	FOLD (F)	CASTERS (LC)	WHEELS (WB)	
			SE	HF	HBV	HF2	HF	HF2					
			PVF	HB	HBVR	HB2	HB	HB2					
			PVB		HBG	HKN4	HBV	HKN4					
			2MM			HKNR4	HBVR	HKNR4					
						HBG2	HBG	HBG2					
<i>Rectangle</i>													
24 x 30RE	AXM	1	938	1060	1104	1167	1216	1335	141	-	-	-	42
	ATM	2	1091	1213	1257	1320	1369	1488	282	-	84	-	58
	ATMA	2	1297	1419	1463	1526	1575	1694	-	-	84	-	58
24 x 36RE	AXM	1	938	1060	1104	1167	1216	1335	141	-	-	-	42
	ATM	2	1091	1213	1257	1320	1369	1488	282	-	84	-	58
	ATMA	2	1297	1419	1463	1526	1575	1694	-	-	84	-	58
24 x 42RE	ATM	2	1152	1348	1399	1491	1547	1713	282	-	84	-	66
	ATMA	2	1358	1554	1605	1697	1753	1919	-	-	84	-	66
24 x 48RE	ATM	2	1152	1348	1399	1491	1547	1713	282	-	84	-	66
	ATMA	2	1358	1554	1605	1697	1753	1919	-	-	84	-	66
24 x 54RE	ATM	2	1207	1493	1558	1664	1743	1946	282	-	84	-	74
	ATMA	2	1413	1699	1764	1870	1949	2152	-	-	84	-	74
24 x 60RE	ATM	2	1207	1493	1558	1664	1743	1946	282	-	84	-	74
	ATMA	2	1413	1699	1764	1870	1949	2152	-	-	84	-	83
24 x 66RE	ATM	2	1343	1687	1767	1896	1980	2229	282	-	84	-	83
	ATMA	2	1549	1893	1973	2102	2186	2435	-	-	84	-	83
24 x 72RE	ATM	2	1343	1687	1767	1896	1980	2229	282	-	84	-	83
	ATMA	2	1549	1893	1973	2102	2186	2435	-	-	84	-	83



30D-AXM



2448RE-ATM

### STANDARD FEATURES

- Laminate tops available in any standard Wilsonart, Nevamar, Formica, Arborite or Pionite matte finish offerings. For other laminate please contact the factory for pricing.
- Veneers and hardwood edges are standard in Oak, Maple, Cherry, Pecan, Walnut, Mahogany and Chocolate.
- 7 veneer and hardwood edge stains are standard. Stain-to-match available at no upcharge.
- Standard table height 29".
- The foot of the Castaway base is available in 5 textured finishes. The column is available in 76 standard finishes.
- All bases are standard with floor leveling glides.

### OPTIONS

- Custom heights available.

### HOW TO ORDER

1. Select Model
2. Select Base
3. Select Edge Style
4. Select Options
5. Select Top Finish
6. Select Edge Finish
7. Select Base Finish

**Example:** 2430RE - AXM - PVF -





# CASTAWAY GENERAL PURPOSE TABLES

MODEL	BASES		TOP SPECIFICATIONS						OPTIONS				LBS
	Code	Qty.	For Laminate Top			For Veneer Top			FLIP TOP (FL)	FOLD (F)	CASTERS (LC)	WHEELS (WB)	
			SE	HF	HBV	HF2	HF	HF2					
			PVF	HB	HBVR	HB2	HB	HB2					
			PVB		HBG	HKNR4	HBV	HKNR4					
			2MM			HKNR4	HBVR	HKNR4					
						HBG2	HBG	HBG2					
<i>Rectangle</i>													
30 x 36RE	ATM	2	1179	1320	1370	1450	1508	1652	282	-	84	-	64
	ATMA	2	1385	1526	1576	1656	1714	1858	-	-	84	-	64
30 x 42RE	ATM	2	1198	1467	1529	1635	1713	1915	282	-	84	-	74
	ATMA	2	1404	1673	1735	1841	1919	2121	-	-	84	-	74
30 x 48RE	ATM	2	1198	1467	1529	1635	1713	1915	282	-	84	-	74
	ATMA	2	1404	1673	1735	1841	1919	2121	-	-	84	-	74
30 x 54RE	ATM	2	1253	1620	1700	1851	1941	2194	282	-	84	-	85
	ATMA	2	1459	1826	1906	2057	2147	2400	-	-	84	-	85
30 x 60RE	ATM	2	1253	1620	1700	1851	1941	2194	282	-	84	-	85
	ATMA	2	1459	1826	1906	2057	2147	2400	-	-	84	-	85
30 x 66RE	ATM	2	1416	1712	1809	1963	2050	2330	282	-	84	-	95
	ATMA	2	1622	1918	2015	2169	2256	2536	-	-	84	-	95
30 x 72RE	ATM	2	1468	1855	1953	2151	2254	2561	282	-	84	-	95
	ATMA	2	1674	2061	2159	2357	2460	2767	-	-	84	-	95
30 x 78RE	ATM	2	1678	2020	2136	2366	2487	2840	282	-	84	-	106
	ATMA	2	1884	2226	2342	2572	2693	3046	-	-	84	-	106
30 x 84RE	ATM	2	1678	2020	2136	2366	2487	2840	282	-	84	-	106
	ATMA	2	1884	2226	2342	2572	2693	3046	-	-	84	-	106
30 x 90RE	ATM	2	1697	2227	2366	2579	2722	3124	-	-	84	-	116
30 x 96RE	ATM	2	1697	2227	2366	2579	2722	3124	-	-	84	-	116



2448RE-ATM

### STANDARD FEATURES

- Laminate tops available in any standard Wilsonart, Nevamar, Formica, Arborite or Pionite matte finish offerings. For other laminate please contact the factory for pricing.
- Veneers and hardwood edges are standard in Oak, Maple, Cherry, Pecan, Walnut, Mahogany and Chocolate.
- 7 veneer and hardwood edge stains are standard. Stain-to-match available at no upcharge.
- Standard table height 29".
- The foot of the Castaway base is available in 5 textured finishes. The column is available in 76 standard finishes.
- All bases are standard with floor leveling glides.

### OPTIONS

- Custom heights available.

### HOW TO ORDER

1. Select Model
2. Select Base
3. Select Edge Style
4. Select Options
5. Select Top Finish
6. Select Edge Finish
7. Select Base Finish

Example: 3036RE - ATM - PVF -





# CASTAWAY GENERAL PURPOSE TABLES

MODEL	BASES		TOP SPECIFICATIONS						OPTIONS				LBS
	Code	Qty.	For Laminate Top			For Veneer Top			FLIP TOP (FL)	FOLD (F)	CASTERS (LC)	WHEELS (WB)	
			SE	HF	HBV	HF2	HF	HF2					
			PVF	HB	HBVR	HB2	HB	HB2					
			PVB		HBG	HKN4	HBV	HKN4					
			2MM			HKNR4	HBVR	HKNR4					
						HBG2	HBG	HBG2					
<i>Rectangle</i>													
36 x 42RE	ATM	2	1291	1493	1571	1677	1758	1970	282	-	-	-	83
	ATMA	2	1497	1699	1777	1883	1964	2176	-	-	-	-	83
36 x 48RE	ATM	2	1315	1600	1683	1809	1893	2140	282	-	-	-	83
	ATMA	2	1521	1806	1889	2015	2099	2346	-	-	-	-	83
36 x 60RE	ATM	2	1405	1802	1903	2064	2166	2475	-	-	-	-	95
	ATMA	2	1611	2008	2109	2270	2372	2681	-	-	-	-	95
36 x 66RE	ATM	2	1487	1899	2015	2192	2303	2643	-	-	-	-	108
	ATMA	2	1693	2105	2221	2398	2509	2849	-	-	-	-	108
	AT2M	2	2035	2447	2563	2740	2851	3191	-	-	84	-	108
36 x 72RE	ATM	2	1523	1953	2064	2320	2443	2811	-	-	-	-	108
	ATMA	2	1729	2159	2270	2526	2649	3017	-	-	-	-	108
	AT2M	2	2071	2501	2612	2868	2991	3359	-	-	84	-	108
36 x 78RE	ATM	2	1836	2296	2440	2662	2807	3240	-	-	-	-	121
	AT2M	2	2384	2844	2988	3210	3355	3788	-	-	84	-	121
36 x 84RE	ATM	2	1836	2296	2440	2662	2807	3240	-	-	-	-	121
	AT2M	2	2384	2844	2988	3210	3355	3788	-	-	84	-	121
36 x 90RE	ATM	2	1841	2497	2662	2921	3087	3568	-	-	-	-	133
	AT2M	2	2389	3045	3210	3469	3635	4116	-	-	84	-	133
36 x 96RE	ATM	2	1841	2497	2662	2921	3087	3568	-	-	-	-	133
	AT2M	2	2389	3045	3210	3469	3635	4116	-	-	84	-	133
42 x 78RE	AT2M	2	2610	3006	3164	3546	3672	4174	-	-	-	-	135
42 x 84RE	AT2M	2	2610	3006	3164	3546	3672	4174	-	-	-	-	135



2448RE-ATM



2448RE-AT2M

### STANDARD FEATURES

- Laminate tops available in any standard Wilsonart, Nevamar, Formica, Arborite or Pionite matte finish offerings. For other laminate please contact the factory for pricing.
- Veneers and hardwood edges are standard in Oak, Maple, Cherry, Pecan, Walnut, Mahogany and Chocolate.
- 7 veneer and hardwood edge stains are standard. Stain-to-match available at no upcharge.
- Standard table height 29".
- The foot of the Castaway base is available in 5 textured finishes. The column is available in 76 standard finishes.
- All bases are standard with floor leveling glides.

### OPTIONS

- Custom heights available.

### HOW TO ORDER

1. Select Model
2. Select Base
3. Select Edge Style
4. Select Options
5. Select Top Finish
6. Select Edge Finish
7. Select Base Finish

**Example:** 3642RE - ATM - PVF -







# CASTAWAY GENERAL PURPOSE TABLES

MODEL	BASES		TOP SPECIFICATIONS						OPTIONS				LBS
	Code	Qty.	For Laminate Top			For Veneer Top			FLIP TOP (FL)	FOLD (F)	CASTERS (LC)	WHEELS (WB)	
			SE	HF	HBV	HF2	HF	HF2					
			PVF	HB	HBVR	HB2	HB	HB2					
			PVB		HBG	HKN4	HBV	HKN4					
			2MM			HKNR4	HBVR	HKNR4					
						HBG2	HBG	HBG2					
<i>Racetrack</i>													
36 x 54RT	ATM	2	1457	1980	2102	2320	2409	2728	-	-	-	-	95
	ATMA	2	1663	2186	2308	2526	2615	2934	-	-	-	-	95
	AT2M	2	2005	2528	2650	2868	2957	3276	-	-	84	-	95
36 x 60RT	ATM	2	1457	1980	2102	2320	2409	2728	-	-	-	-	95
	ATMA	2	1663	2186	2308	2526	2615	2934	-	-	-	-	95
	AT2M	2	2005	2528	2650	2868	2957	3276	-	-	84	-	95
36 x 66RT	ATM	2	1605	2151	2283	2516	2722	3120	-	-	-	-	108
	AT2M	2	2153	2699	2831	3064	3270	3668	-	-	84	-	108
36 x 72RT	ATM	2	1605	2151	2283	2516	2722	3120	-	-	-	-	108
	AT2M	2	2153	2699	2831	3064	3270	3668	-	-	84	-	108
36 x 78RT	ATM	2	1851	2545	2707	3060	3134	3599	-	-	-	-	121
	AT2M	2	2399	3093	3255	3608	3682	4147	-	-	84	-	121
36 x 84RT	ATM	2	1851	2545	2707	3060	3134	3599	-	-	-	-	121
	AT2M	2	2399	3093	3255	3608	3682	4147	-	-	84	-	121
36 x 90RT	ATM	2	1855	2781	2974	3369	3461	3990	-	-	-	-	133
	AT2M	2	2403	3329	3522	3917	4009	4538	-	-	84	-	133
36 x 96RT	ATM	2	1855	2781	2974	3369	3461	3990	-	-	-	-	133
	AT2M	2	2403	3329	3522	3917	4009	4538	-	-	84	-	133
42 x 78RT	AT2M	2	2624	3280	3479	3878	3974	4509	-	-	-	-	150
42 x 84RT	AT2M	2	2624	3280	3479	3878	3974	4509	-	-	-	-	150
48 x 78RT	AT2M	2	2627	3562	3787	4140	4361	4969	-	-	-	-	150
48 x 84RT	AT2M	2	2627	3562	3787	4140	4361	4969	-	-	-	-	150



2448RE-ATM



2448RE-AT2M

### STANDARD FEATURES

- Laminate tops available in any standard Wilsonart, Nevamar, Formica, Arborite or Pionite matte finish offerings. For other laminate please contact the factory for pricing.
- Veneers and hardwood edges are standard in Oak, Maple, Cherry, Pecan, Walnut, Mahogany and Chocolate.
- 7 veneer and hardwood edge stains are standard. Stain-to-match available at no upcharge.
- Standard table height 29".
- The foot of the Castaway base is available in 5 textured finishes. The column is available in 76 standard finishes.
- All bases are standard with floor leveling glides.

### OPTIONS

- Custom heights available.

### HOW TO ORDER

- Select Model
- Select Base
- Select Edge Style
- Select Options
- Select Top Finish
- Select Edge Finish
- Select Base Finish

**Example:** 3654RT - ATM - PVF -





# CASTAWAY GENERAL PURPOSE TABLES

MODEL	BASES		TOP SPECIFICATIONS						OPTIONS				LBS
	Code	Qty.	For Laminate Top			For Veneer Top			FLIP TOP (FL)	FOLD (F)	CASTERS (LC)	WHEELS (WB)	
			SE PVF PVB 2MM	HF HB	HBV HBVR HBG	HF2 HB2 HKNR4 HBG2	HF HB HBV HBG	HF2 HB2 HKNR4 HBG2					
<i>Bullet</i>													
30 x 54B	ATM	2	1365	1886	1994	2185	2241	2557	282	-	84	-	85
30 x 60B	ATM	2	1365	1886	1994	2185	2241	2557	282	-	84	-	85
36 x 54B	ATM	2	1478	2353	2508	2787	2825	3222	-	-	84	-	95
36 x 60B	ATM	2	1478	2353	2508	2787	2825	3222	-	-	84	-	95
36 x 72B	ATM	2	1604	2572	2743	3041	3214	3712	-	-	84	-	108
<i>Halfmoon</i>													
24 x 48H	ATM	2	1168	1638	1756	1899	2015	2283	282	-	84	-	66
	ATMA	2	1374	1844	1962	2105	2221	2489	-	-	84	-	66
30 x 60H	ATM	2	1365	2065	2228	2388	2589	2971	282	-	84	-	85
	ATMA	2	1571	2271	2434	2594	2795	3177	-	-	84	-	85
36 x 72H	ATM	2	1604	2560	2771	2968	3295	3811	-	-	84	-	108
<i>Trapezoid</i>													
30 x 60TP	ATM	2	1365	1796	1896	2070	2120	2412	-	-	84	-	85
36 x 72TP	ATM	2	1604	2188	2321	2621	2695	3116	-	-	84	-	108
<i>Radius</i>													
24 x 24	24RC90	-	362	656	741	850	871	1043	-	-	84	-	17
30 x 30	30RC90	-	462	868	975	1094	1156	1387	-	-	84	-	27
<i>Crescent</i>													
30 x 36	3036CRC90-ATM	1	936	1564	1643	1705	1905	2124	-	-	84	-	48
36 x 42	3642CRC90-ATM	1	1269	1858	1966	2048	2322	2619	-	-	84	-	61



2448RE-ATM

### STANDARD FEATURES

- Laminate tops available in any standard Wilsonart, Nevamar, Formica, Arborite or Pionite matte finish offerings. For other laminate please contact the factory for pricing.
- Veneers and hardwood edges are standard in Oak, Maple, Cherry, Pecan, Walnut, Mahogany and Chocolate.
- 7 veneer and hardwood edge stains are standard. Stain-to-match available at no upcharge.
- Standard table height 29".
- The foot of the Castaway base is available in 5 textured finishes. The column is available in 76 standard finishes.
- All bases are standard with floor leveling glides.

### OPTIONS

- Custom heights available.

### HOW TO ORDER

1. Select Model
2. Select Base
3. Select Edge Style
4. Select Options
5. Select Top Finish
6. Select Edge Finish
7. Select Base Finish

Example: 3054B - ATM - PVF -





# CASTAWAY BOARDROOM TABLES

MODEL	BASES		TOP SPECIFICATIONS						OPTIONS	LBS
	Code	Qty.	For Laminate Top			For Veneer Top				
			SE PVF PVB 2MM	HF HB	HBV HBVR HBG	HF2 HB2 HKNR4 HBG2	HF HB HBV HBG	HF2 HB2 HKNR4 HBG2		
<i>Rectangle</i>										
42 x 96RE	AT2M	2	2658	3491	3717	3944	4282	4934		167
48 x 96RE	AT2M	2	2658	3491	3717	3944	4282	4934		167
48 x 120RE	AT2M	3	3648	4723	4978	5527	5609	6370		216
48 x 144RE	AT2M	3	4011	5553	5888	6411	6287	7204		250
48 x 168RE	AT2M	3	4472	6024	6407	7137	6968	8034		284
60 x 120RE	AT2M	3	4091	5699	6050	6593	6464	7419		258
60 x 144RE	AT2M	3	4502	6431	6852	7502	7349	8495		300
60 x 168RE	AT2M	3	4913	7164	7652	8414	8233	9570		342
<i>Racetrack</i>										
42 x 96RT	AT2M	2	2678	3619	3848	4400	4790	5485		167
48 x 96RT	AT2M	2	2678	3619	3848	4400	4790	5485		167
48 x 120RT	AT2M	3	3672	5166	5465	6226	6194	7006		216
48 x 144RT	AT2M	3	4038	5899	6265	7209	6990	7974		250
48 x 168RT	AT2M	3	4502	6525	6954	8001	7797	8938		284
60 x 120RT	AT2M	3	4081	5948	6319	7275	7232	8251		258
60 x 144RT	AT2M	3	4538	6863	7323	8504	8229	9459		300
60 x 168RT	AT2M	3	5119	7649	8184	9489	9237	10663		342



4296BTA-AT2M

### STANDARD FEATURES

- Laminate tops available in any standard Wilsonart, Nevamar, Formica, Arborite or Pionite matte finish offerings. For other laminate please contact the factory for pricing.
- Veneers and hardwood edges are standard in Oak, Maple, Cherry, Pecan, Walnut, Mahogany and Chocolate.
- 7 veneer and hardwood edge stains are standard. Stain-to-match available at no upcharge.
- Standard table height 29".
- The foot of the Castaway base is available in 5 textured finishes. The column is available in 76 standard finishes.
- All bases are standard with floor leveling glides.

### OPTIONS

- Custom heights available.

### HOW TO ORDER

1. Select Model
2. Select Base
3. Select Edge Style
4. Select Top Finish
5. Select Edge Finish
6. Select Base Finish

**Example:** 4296RE - AT2M - PVF

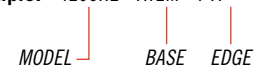



# CASTAWAY BOARDROOM TABLES

MODEL	BASES		TOP SPECIFICATIONS						OPTIONS	LBS
	Code	Qty.	For Laminate Top			For Veneer Top				
			SE PVF PVB 2MM	HF HB	HBV HBVR HBG	HF2 HB2 HKN4 HKNR4 HBG2	HF HB HBV HBG	HF2 HB2 HKN4 HKNR4 HBG2		
<i>Boatshape</i>										
42 x 96BT	AT2M	2	2678	4261	4556	4860	5291	5670		167
48 x 96BT	AT2M	2	2678	4261	4556	4860	5291	5670		216
48 x 120BT	AT2M	3	3672	5870	6236	6621	6786	7223		250
48 x 144BT	AT2M	3	4038	6603	7039	7502	8086	8484		284
48 x 168BT	AT2M	3	4502	7304	7811	8346	8619	9234		258
60 x 120BT	AT2M	3	4081	6826	7286	7767	7974	8518		300
60 x 144BT	AT2M	3	4538	7745	8290	8869	9597	10096		342
60 x 168BT	AT2M	3	5119	8622	9255	9924	10262	11033		
<i>Boatshape Arc Ends</i>										
42 x 96BTA	AT2M	2	2838	4766	5062	5368	5796	6176		167
48 x 96BTA	AT2M	2	2838	4766	5062	5368	5796	6176		167
48 x 120BTA	AT2M	3	3833	6377	6743	7129	7293	7728		216
48 x 144BTA	AT2M	3	4199	7108	7547	8010	8591	8991		250
48 x 168BTA	AT2M	3	4664	7811	8319	8854	9124	9742		284
60 x 120BTA	AT2M	3	4283	7462	7918	8401	8606	9150		258
60 x 144BTA	AT2M	3	4738	8376	8924	9502	10230	10727		300
60 x 168BTA	AT2M	3	5319	9255	9888	10555	10897	11668		342



4296BTA-AT2M

### STANDARD FEATURES

- Laminate tops available in any standard Wilsonart, Nevamar, Formica, Arborite or Pionite matte finish offerings. For other laminate please contact the factory for pricing.
- Veneers and hardwood edges are standard in Oak, Maple, Cherry, Pecan, Walnut, Mahogany and Chocolate.
- 7 veneer and hardwood edge stains are standard. Stain-to-match available at no upcharge.
- Standard table height 29".
- The foot of the Castaway base is available in 5 textured finishes. The column is available in 76 standard finishes.
- All bases are standard with floor leveling glides.

### OPTIONS

- Custom heights available.

### HOW TO ORDER

1. Select Model
2. Select Base
3. Select Edge Style
4. Select Top Finish
5. Select Edge Finish
6. Select Base Finish

**Example:** 4296BT - AT2M - PVF



# CONDUCTOR TABLES



PLACING AN ORDER IS EASY

## PRODUCT CODE

**2430 RE CT**

<p><b>Size</b> Width x Length</p>	<p><b>Top Shape</b>                  D : Round                  SQ : Square                  RE : Rectangle                  RT : Racetrack                  B : Bullet                  H : Halfmoon                  TP : Trapezoid</p>	<p><b>Series</b> Conductor</p> <p>RC90 : Radius (<i>connector</i>)                  TC90 : Triangle (<i>connector</i>)                  CRC90 : Crescent (<i>connector</i>)                  BT : Boatshape                  BTA : Boatshape Arc</p>	<p><b>Base</b>                  X : X-Base                  X4 : 4 Column X-Base                  T : T-Base                  T2 : Double Column T-Base                  T2D : T2 with Door                  C : C-Base                  CEWT : C-Base with Trough</p>
---------------------------------------	---	--	--

## OPTIONS

**FLIP TOP**



**CASTERS**



**FOLDING**



## FINISHES

**LAMINATE**



Select laminate from our virtually unlimited laminate options

**VENEER**

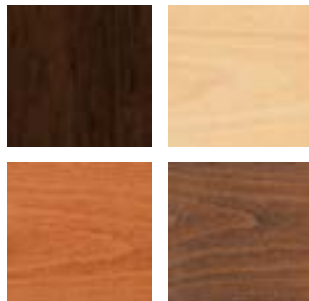

Select from one of our 7 standard wood stains or stain-to-match at no upcharge

**BASE**



Select from one of our 76 standard Spectone colors

**EDGE**



2MM      PVC      Hard Wood

Check out our website for a complete list of edge profiles.



# CONDUCTOR GENERAL PURPOSE TABLES

BACK TO CONTENTS



MODEL	BASES		TOP SPECIFICATIONS						OPTIONS				LBS
	Code	Qty.	For Laminate Top			For Veneer Top			FLIP TOP (FL)	FOLD (F)	CASTERS (LC)	WHEELS (WB)	
			SE PVF PVB 2MM	HF HB	HBV HBVR HBG	HF2 HB2 HKNR4 HBG2	HF HB HBV HBG	HF2 HB2 HKNR4 HBG2					
<i>Round</i>													
24D	CX	1	559	888	922	1022	1075	1178	141	-	84	-	34
30D	CX	1	654	978	1022	1221	1170	1321	141	-	84	-	44
36D	CX	1	744	1215	1297	1460	1510	1719	141	-	84	-	55
42D	CX	1	1005	1532	1646	1888	1913	2199	-	-	-	-	69
	CX4	1	1146	1673	1787	2029	2054	2340	-	-	84	-	77
48D	CX4	1	1167	1875	1999	2119	2553	2921	-	-	84	-	93
54D	CX4	1	1433	2476	2668	2852	3068	3540	-	-	-	-	111
60D	CX4	1	1476	2661	2866	3021	3649	4236	-	-	-	-	130
<i>Square</i>													
24 x 24SQ	CX	1	587	766	800	862	907	1061	141	-	84	-	34
30 x 30SQ	CX	1	685	815	862	1026	967	1178	141	-	84	-	44
36 x 36SQ	CX	1	762	966	1022	1215	1221	1405	141	-	84	-	55
42 x 42SQ	CX4	1	1160	1455	1546	1637	1700	1951	-	-	84	-	77
48 x 48SQ	CX4	1	1301	1560	1656	1698	2045	2367	-	-	84	-	93
54 x 54SQ	CX4	1	1435	2007	2157	2331	2426	2844	-	-	-	-	111
60 x 60SQ	CX4	1	1463	2104	2263	2439	2864	3370	-	-	-	-	130



30D-CX



42D-CX4

### STANDARD FEATURES

- Laminate tops available in any standard Wilsonart, Nevamar, Formica, Arborite or Pionite matte finish offerings. For other laminate please contact the factory for pricing.
- Veneers and hardwood edges are standard in Oak, Maple, Cherry, Pecan, Walnut, Mahogany and Chocolate.
- 7 veneer and hardwood edge stains are standard. Stain-to-match available at no upcharge.
- Standard table height 29".
- All bases are standard with floor leveling glides.

### OPTIONS

- Custom heights available.

### HOW TO ORDER

- Select Model
- Select Base
- Select Edge Style
- Select Options
- Select Top Finish
- Select Edge Finish
- Select Base Finish

Example: 24D - CX - PVF -





# CONDUCTOR GENERAL PURPOSE TABLES

BACK TO CONTENTS



MODEL	BASES		TOP SPECIFICATIONS						OPTIONS				LBS
	Code	Qty.	For Laminate Top			For Veneer Top			FLIP TOP (FL)	FOLD (F)	CASTERS (LC)	WHEELS (WB)	
			SE PVF PVB 2MM	HF HB	HBV HBVR HBG	HF2 HB2 HKNR4 HBG2	HF HB HBV HBG	HF2 HB2 HKNR4 HBG2					
<i>Rectangle</i>													
24 x 30RE	CX	1	674	796	840	903	952	1071	141	-	-	-	43
	CT	2	743	865	909	972	1021	1140	282	-	84	84	52
24 x 36RE	CX	1	674	796	840	903	952	1071	141	-	-	-	43
	CT	2	743	865	909	972	1021	1140	282	-	84	84	52
24 x 42RE	CT	2	804	1000	1051	1143	1199	1365	282	-	84	84	60
24 x 48RE	CT	2	804	1000	1051	1143	1199	1365	282	-	84	84	60
24 x 54RE	CT	2	859	1145	1210	1316	1395	1598	282	273	84	84	68
24 x 60RE	CT	2	859	1145	1210	1316	1395	1598	282	273	84	84	68
24 x 66RE	CT	2	995	1339	1419	1548	1632	1881	282	273	84	84	77
24 x 72RE	CT	2	995	1339	1419	1548	1632	1881	282	273	84	84	77
30 x 36RE	CX	1	762	903	953	1033	1091	1235	141	-	-	-	49
	CT	2	831	972	1022	1102	1160	1304	282	-	84	84	58
30 x 42RE	CT	2	850	1119	1181	1287	1365	1567	282	-	84	84	68
30 x 48RE	CT	2	850	1119	1181	1287	1365	1567	282	-	84	84	68
30 x 54RE	CT	2	905	1272	1352	1503	1593	1846	282	273	84	84	79
30 x 60RE	CT	2	905	1272	1352	1503	1593	1846	282	273	84	84	79
30 x 66RE	CT	2	1068	1364	1461	1615	1702	1982	282	273	84	84	89
30 x 72RE	CT	2	1120	1507	1605	1803	1906	2213	282	273	84	84	89
30 x 78RE	CT	2	1330	1672	1788	2018	2139	2492	282	273	84	-	100
30 x 84RE	CT	2	1330	1672	1788	2018	2139	2492	282	273	84	-	100
30 x 90RE	CT	2	1349	1879	2018	2231	2374	2776	-	273	84	84	110
30 x 96RE	CT	2	1349	1879	2018	2231	2374	2776	-	273	84	84	110

\*Folding tables available with PVC Bullnose edge only.



30D-CX



2448RE-CT

### STANDARD FEATURES

- Laminate tops available in any standard Wilsonart, Nevamar, Formica, Arborite or Pionite matte finish offerings. For other laminate please contact the factory for pricing.
- Veneers and hardwood edges are standard in Oak, Maple, Cherry, Pecan, Walnut, Mahogany and Chocolate.
- 7 veneer and hardwood edge stains are standard. Stain-to-match available at no upcharge.
- Standard table height 29".
- All bases are standard with floor leveling glides.

### OPTIONS

- Custom heights available.

### HOW TO ORDER

1. Select Model
2. Select Base
3. Select Edge Style
4. Select Options
5. Select Top Finish
6. Select Edge Finish
7. Select Base Finish

Example: 2430RE - CX - PVF -





# CONDUCTOR GENERAL PURPOSE TABLES

BACK TO CONTENTS



MODEL	BASES		TOP SPECIFICATIONS						OPTIONS				LBS
	Code	Qty.	For Laminate Top			For Veneer Top			FLIP TOP (FL)	FOLD (F)	CASTERS (LC)	WHEELS (WB)	
			SE PVF PVB 2MM	HF HB	HBV HBVR HBG	HF2 HB2 HKN4 HKNR4 HBG2	HF HB HBV HBG	HF2 HB2 HKN4 HKNR4 HBG2					
<i>Rectangle</i>													
36 x 42RE	CT	2	943	1145	1223	1329	1410	1622	282	-	84	84	77
36 x 48RE	CT	2	967	1252	1335	1461	1545	1792	282	-	84	84	77
36 x 60RE	CT	2	1057	1454	1555	1716	1818	2127	282	273	84	84	89
36 x 66RE	CT	2	1139	1551	1667	1844	1955	2295	-	273	84	84	102
	CT2	2	1311	1723	1839	2016	2127	2467	-	547	84	-	112
36 x 72RE	CT	2	1175	1605	1716	1972	2095	2463	-	273	84	84	102
	CT2	2	1347	1777	1888	2144	2267	2635	-	547	84	-	112
36 x 78RE	CT	2	1488	1948	2092	2314	2459	2892	-	-	84	84	115
	CT2	2	1660	2120	2264	2486	2631	3064	-	547	84	-	125
36 x 84RE	CT	2	1488	1948	2092	2314	2459	2892	-	-	84	84	115
	CT2	2	1660	2120	2264	2486	2631	3064	-	547	84	-	125
36 x 90RE	CT	2	1493	2149	2314	2573	2739	3220	-	-	84	84	127
	CT2	2	1665	2321	2486	2745	2911	3392	-	547	84	-	137
36 x 96RE	CT	2	1493	2149	2314	2573	2739	3220	-	-	84	84	127
	CT2	2	1665	2321	2486	2745	2911	3392	-	547	84	-	137
42 x 78RE	CT2	2	1886	2282	2440	2822	2948	3450	-	547	84	-	139
	CT2D	2	3012	3408	3566	3948	4074	4576	-	-	-	-	153
42 x 84RE	CT2	2	1886	2282	2440	2822	2948	3450	-	547	84	-	139
	CT2D	2	3012	3408	3566	3948	4074	4576	-	-	-	-	153

\*Folding tables available with PVC Bullnose edge only.



2448RE-CT

### STANDARD FEATURES

- Laminate tops available in any standard Wilsonart, Nevamar, Formica, Arborite or Pionite matte finish offerings. For other laminate please contact the factory for pricing.
- Veneers and hardwood edges are standard in Oak, Maple, Cherry, Pecan, Walnut, Mahogany and Chocolate.
- 7 veneer and hardwood edge stains are standard. Stain-to-match available at no upcharge.
- Standard table height 29".
- All bases are standard with floor leveling glides.

### OPTIONS

- Custom heights available.

### HOW TO ORDER

1. Select Model
2. Select Base
3. Select Edge Style
4. Select Options
5. Select Top Finish
6. Select Edge Finish
7. Select Base Finish

**Example:** 3642RE - CT - PVF -







# CONDUCTOR GENERAL PURPOSE TABLES

BACK TO CONTENTS



MODEL	BASES		TOP SPECIFICATIONS						OPTIONS				LBS
	Code	Qty.	For Laminate Top			For Veneer Top			FLIP TOP (FL)	FOLD (F)	CASTERS (LC)	WHEELS (WB)	
			SE PVF PVB 2MM	HF HB	HBV HBVR HBG	HF2 HB2 HKN4 HKNR4 HBG2	HF HB HBV HBG	HF2 HB2 HKN4 HKNR4 HBG2					
<i>Racetrack</i>													
36 x 54RT	CT	2	1109	1632	1754	1972	2061	2380	282	-	84	84	89
	CT2	2	1281	1804	1926	2144	2233	2552	-	-	84	84	99
36 x 60RT	CT	2	1109	1632	1754	1972	2061	2380	282	-	84	84	89
	CT2	2	1281	1804	1926	2144	2233	2552	-	-	84	84	99
36 x 66RT	CT	2	1257	1803	1935	2168	2374	2772	282	-	84	84	102
	CT2	2	1429	1975	2107	2340	2546	2944	-	-	84	84	112
36 x 72RT	CT	2	1257	1803	1935	2168	2374	2772	282	-	84	84	102
	CT2	2	1429	1975	2107	2340	2546	2944	-	-	84	84	112
36 x 78RT	CT	2	1503	2197	2359	2712	2786	3251	-	-	84	84	115
	CT2	2	1675	2369	2531	2884	2958	3423	-	-	84	84	125
36 x 84RT	CT	2	1503	2197	2359	2712	2786	3251	-	-	84	84	115
	CT2	2	1675	2369	2531	2884	2958	3423	-	-	84	84	125
36 x 90RT	CT	2	1507	2433	2626	3021	3113	3642	-	-	84	84	127
	CT2	2	1679	2605	2798	3193	3285	3814	-	-	84	84	137
36 x 96RT	CT	2	1507	2433	2626	3021	3113	3642	-	-	84	84	127
	CT2	2	1679	2605	2798	3193	3285	3814	-	-	84	84	137
42 x 78RT	CT2	2	1900	2556	2755	3154	3250	3785	-	-	84	84	154
	CT2D	2	3026	3682	3881	4280	4376	4911	-	-	-	-	168
42 x 84RT	CT2	2	1900	2556	2755	3154	3250	3785	-	-	84	84	154
	CT2D	2	3026	3682	3881	4280	4376	4911	-	-	-	-	168
48 x 78RT	CT2	2	1903	2838	3063	3416	3637	4245	-	-	84	84	154
	CT2D	2	3029	3964	4189	4542	4763	5371	-	-	-	-	168
48 x 84RT	CT2	2	1903	2838	3063	3416	3637	4245	-	-	84	84	154
	CT2D	2	3029	3964	4189	4542	4763	5371	-	-	-	-	168



2448RE-CT

### STANDARD FEATURES

- Laminate tops available in any standard Wilsonart, Nevamar, Formica, Arborite or Pionite matte finish offerings. For other laminate please contact the factory for pricing.
- Veneers and hardwood edges are standard in Oak, Maple, Cherry, Pecan, Walnut, Mahogany and Chocolate.
- 7 veneer and hardwood edge stains are standard. Stain-to-match available at no upcharge.
- Standard table height 29".
- All bases are standard with floor leveling glides.

### OPTIONS

- Custom heights available.

### HOW TO ORDER

1. Select Model
2. Select Base
3. Select Edge Style
4. Select Options
5. Select Top Finish
6. Select Edge Finish
7. Select Base Finish

**Example:** 3654RT - CT - PVF -





# CONDUCTOR GENERAL PURPOSE TABLES

BACK TO CONTENTS

MODEL	BASES		TOP SPECIFICATIONS						OPTIONS				LBS
	Code	Qty.	For Laminate Top			For Veneer Top			FLIP TOP (FL)	FOLD (F)	CASTERS (LC)	WHEELS (WB)	
			SE PVF PVB 2MM	HF HB	HBV HBVR HBG	HF2 HB2 HKN4 HKNR4 HBG2	HF HB HBV HBG	HF2 HB2 HKN4 HKNR4 HBG2					
<i>Bullet</i>													
<b>30 x 54B</b>	CT	2	1017	1538	1646	1837	1893	2209	282	-	84	84	79
<b>30 x 60B</b>	CT	2	1017	1538	1646	1837	1893	2209	282	-	84	84	79
<b>36 x 54B</b>	CT	2	1130	2005	2160	2439	2477	2874	-	-	84	84	89
<b>36 x 60B</b>	CT	2	1130	2005	2160	2439	2477	2874	-	-	84	84	89
<b>36 x 72B</b>	CT	2	1256	2224	2395	2693	2866	3364	-	-	84	84	102
<i>Halfmoon</i>													
<b>24 x 48H</b>	CC	2	744	1214	1332	1475	1591	1859	-	-	84	-	56
	CT	2	820	1290	1408	1551	1667	1935	282	-	84	84	60
<b>30 x 60H</b>	CC	2	941	1641	1804	1964	2165	2547	-	-	84	-	75
	CT	2	1017	1717	1880	2040	2241	2623	282	-	84	84	79
<b>36 x 72H</b>	CT	2	1256	2212	2423	2620	2947	3463	-	-	-	84	102
<i>Trapezoid</i>													
<b>30 x 60TP</b>	CC	2	941	1372	1472	1646	1696	1988	-	-	84	-	75
	CT	2	1017	1448	1548	1722	1772	2064	-	-	84	-	79
<b>36 x 72TP</b>	CC	2	1180	1764	1897	2197	2271	2692	-	-	84	-	98
	CT	2	1256	1840	1973	2273	2347	2768	-	-	84	-	102
<i>Radius (connector)</i>													
<b>24 x 24</b>	<b>24RC90</b>	-	362	656	741	850	871	1043	-	-	-	-	17
	<b>30RC90</b>	-	462	868	975	1094	1156	1387	-	-	-	-	27
<i>Crescent (connector)</i>													
<b>30 x 36</b>	<b>3036CRC90-CT</b>	1	762	1390	1469	1531	1731	1950	-	-	-	-	45
<b>36 x 42</b>	<b>3642CRC90-CT</b>	1	1095	1684	1792	1874	2148	2445	-	-	-	-	58



2448RE-CT

### STANDARD FEATURES

- Laminate tops available in any standard Wilsonart, Nevamar, Formica, Arborite or Pionite matte finish offerings. For other laminate please contact the factory for pricing.
- Veneers and hardwood edges are standard in Oak, Maple, Cherry, Pecan, Walnut, Mahogany and Chocolate.
- 7 veneer and hardwood edge stains are standard. Stain-to-match available at no upcharge.
- Standard table height 29".
- All bases are standard with floor leveling glides.

### OPTIONS

- Custom heights available.

### HOW TO ORDER

1. Select Model
2. Select Base
3. Select Edge Style
4. Select Options
5. Select Top Finish
6. Select Edge Finish
7. Select Base Finish

**Example:** 3054B - CT - PVF -





# CONDUCTOR TRAINING TABLES

BACK TO CONTENTS



MODEL	BASES		TOP SPECIFICATIONS					OPTIONS				LBS
	Code	Qty.	For Laminate Top			For Veneer Top		FLIP TOP (FL)	FOLD (F)	CASTERS (LC)	WHEELS (WB)	
			PVF 2MM	HF	HKN1	HF	HKN1					
<i>Rectangle</i>												
18 x 42RE	CC	2	686	861	981	1034	1174	-	-	84	84	48
	CCEWT	2	920	1095	1215	1268	1408	-	-	84	84	62
18 x 48RE	CC	2	686	861	981	1034	1174	-	-	84	84	48
	CCEWT	2	920	1095	1215	1268	1408	-	-	84	84	62
18 x 54RE	CC	2	728	924	1067	1123	1289	-	-	84	84	54
	CCEWT	2	962	1158	1301	1357	1523	-	-	84	84	68
18 x 60RE	CC	2	728	924	1067	1123	1289	-	273	84	84	54
	CCEWT	2	962	1158	1301	1357	1523	-	-	84	84	68
18 x 66RE	CC	2	783	1069	1240	1319	1522	-	273	84	84	60
	CCEWT	2	1017	1303	1474	1553	1756	-	-	84	84	74
18 x 72RE	CC	2	783	1069	1240	1319	1522	-	273	84	84	60
	CCEWT	2	1017	1303	1474	1553	1756	-	-	84	84	74
24 x 42RE	CC	2	728	924	1067	1123	1289	-	-	84	84	56
	CCEWT	2	962	1158	1301	1357	1523	-	-	84	84	70
24 x 48RE	CC	2	728	924	1067	1123	1289	-	-	84	84	56
	CCEWT	2	962	1158	1301	1357	1523	-	-	84	84	70
24 x 54RE	CC	2	783	1069	1240	1319	1522	-	-	84	84	64
	CCEWT	2	1017	1303	1474	1553	1756	-	-	84	84	78
24 x 60RE	CC	2	783	1069	1240	1319	1522	-	273	84	84	64
	CCEWT	2	1017	1303	1474	1553	1756	-	-	84	84	78
24 x 66RE	CC	2	919	1263	1472	1556	1805	-	273	84	84	73
	CCEWT	2	1153	1497	1706	1790	2039	-	-	84	84	87
24 x 72RE	CC	2	919	1263	1472	1556	1805	-	273	84	84	73
	CCEWT	2	1153	1497	1706	1790	2039	-	-	84	84	87

\*Folding tables available with PVC Bullnose edge only.

### STANDARD FEATURES

- Laminate tops available in any standard Wilsonart, Nevamar, Formica, Arborite or Pionite matte finish offerings. For other laminate please contact the factory for pricing.
- Veneers and hardwood edges are standard in Oak, Maple, Cherry, Pecan, Walnut, Mahogany and Chocolate.
- 7 veneer and hardwood edge stains are standard. Stain-to-match available at no upcharge.
- Standard table height 29".
- All bases are standard with floor leveling glides.
- Training tables without a wire management trough are provided with inserts to attach a trough later if required.

### OPTIONS

- Custom heights available.

### HOW TO ORDER

1. Select Model
2. Select Base
3. Select Edge Style
4. Select Options
5. Select Top Finish
6. Select Edge Finish
7. Select Base Finish

**Example:** 1842RE - CC - PVF -





# CONDUCTOR TRAINING TABLES

BACK TO CONTENTS



MODEL	BASES		TOP SPECIFICATIONS					OPTIONS				LBS
	Code	Qty.	For Laminate Top			For Veneer Top		FLIP TOP (FL)	FOLD (F)	CASTERS (LC)	WHEELS (WB)	
			PVF 2MM	HF	HKN1	HF	HKN1					
<i>Rectangle</i>												
30 x 42RE	CC	2	774	1043	1211	1289	1491	-	-	84	84	64
	CCEWT	2	1008	1277	1445	1523	1725	-	-	84	84	78
30 x 48RE	CC	2	774	1043	1211	1289	1491	-	-	84	84	64
	CCEWT	2	1008	1277	1445	1523	1725	-	-	84	84	78
30 x 54RE	CC	2	829	1196	1427	1517	1770	-	-	84	84	75
	CCEWT	2	1063	1430	1661	1751	2004	-	-	84	84	89
30 x 60RE	CC	2	829	1196	1427	1517	1770	-	273	84	84	75
	CCEWT	2	1063	1430	1661	1751	2004	-	-	84	84	89
30 x 66RE	CC	2	992	1288	1539	1626	1906	-	273	84	84	85
	CCEWT	2	1226	1522	1773	1860	2140	-	-	84	84	99
30 x 72RE	CC	2	1044	1431	1727	1830	2137	-	273	84	84	85
	CCEWT	2	1278	1665	1961	2064	2371	-	-	84	84	85
<i>Radius (connector)</i>												
24, 90°	24RC90	-	362	656	850	871	1043	-	-	-	-	16
30, 90°	30RC90	-	462	868	1094	1156	1387	-	-	-	-	23
24, 30°	24RC30	-	330	626	821	840	1013	-	-	-	-	10
30, 30°	30RC30	-	434	839	1065	1127	1360	-	-	-	-	16
<i>Triangle (connector)</i>												
24, 90°	24TC90	-	362	656	850	871	1043	-	-	-	-	16
30, 90°	30TC90	-	462	868	1094	1156	1387	-	-	-	-	23
24, 30°	24TC30	-	330	626	821	840	1013	-	-	-	-	10
30, 30°	30TC30	-	434	839	1065	1127	1360	-	-	-	-	16

\*Folding tables available with PVC Bullnose edge only.

### STANDARD FEATURES

- Laminate tops available in any standard Wilsonart, Nevamar, Formica, Arborite or Pionite matte finish offerings. For other laminate please contact the factory for pricing.
- Veneers and hardwood edges are standard in Oak, Maple, Cherry, Pecan, Walnut, Mahogany and Chocolate.
- 7 veneer and hardwood edge stains are standard. Stain-to-match available at no upcharge.
- Standard table height 29".
- All bases are standard with floor leveling glides.
- Training tables without a wire management trough are provided with inserts to attach a trough later if required.

### OPTIONS

- Custom heights available.

### HOW TO ORDER

- Select Model
- Select Base
- Select Edge Style
- Select Options
- Select Top Finish
- Select Edge Finish
- Select Base Finish

Example: 3042RE - CC - PVF -





# COOPER TABLES



PLACING AN ORDER IS EASY

### PRODUCT CODE

**2448 RE - COOPER 64**

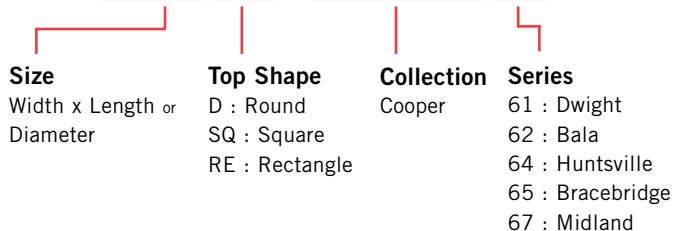

### OPTIONS

#### SERIES



Bala      Bracebridge      Dwight      Huntsville      Midland

### FINISHES

#### LAMINATE



Select laminate from our virtually unlimited laminate options

#### VENEER

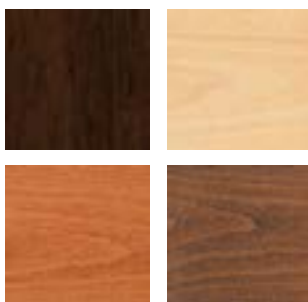

Select from one of our 7 standard wood stains or stain-to-match at no upcharge

#### BASE



Select from one of our 76 standard Spectone colors

#### EDGE



2MM      PVC      Hard Wood

Check out our website for a complete list of edge profiles.



# COOPER COLLECTION

## OCCASIONAL AND LOUNGE TABLES

BACK TO CONTENTS

MODEL	BASES		TOP SPECIFICATIONS						OPTIONS	LBS
	Code	Qty.	For Laminate Top			For Veneer Top				
			SE PVF PVB 2MM	HF HB	HBV HBG	HF2 HKN4	HF HB HBV HBG	HF2 HKN4		
<i>Round</i>										
<b>22D</b>	<b>COOPER61</b>	1	732	1061	1095	1195	1248	1351		45
	<b>COOPER62</b>	1	887	1216	1250	1350	1403	1506		43
	<b>COOPER64</b>	1	966	1295	1329	1429	1482	1585		43
	<b>COOPER65</b>	1	966	1295	1329	1429	1482	1585		43
	<b>COOPER67</b>	1	966	1295	1329	1429	1482	1585		43
<i>Square</i>										
<b>18 x 18SQ</b>	<b>COOPER61</b>	1	573	763	797	859	904	1058		40
	<b>COOPER62</b>	1	733	923	957	1019	1064	1218		38
	<b>COOPER64</b>	1	813	1003	1037	1099	1144	1298		38
	<b>COOPER65</b>	1	813	1003	1037	1099	1144	1298		38
	<b>COOPER67</b>	1	813	1003	1037	1099	1144	1298		38
<b>24 x 24SQ</b>	<b>COOPER61</b>	1	584	763	797	859	904	1058		47
	<b>COOPER62</b>	1	744	923	957	1019	1064	1218		45
	<b>COOPER64</b>	1	824	1003	1037	1099	1144	1298		45
	<b>COOPER65</b>	1	824	1003	1037	1099	1144	1298		45
	<b>COOPER67</b>	1	824	1003	1037	1099	1144	1298		45
<b>30 x 30SQ</b>	<b>COOPER61</b>	1	682	812	859	1023	964	1175		57
	<b>COOPER62</b>	1	842	972	1019	1183	1124	1335		55
	<b>COOPER64</b>	1	922	1052	1099	1263	1204	1415		55
	<b>COOPER65</b>	1	922	1052	1099	1263	1204	1415		55
	<b>COOPER67</b>	1	922	1052	1099	1263	1204	1415		55
<b>36 x 36SQ</b>	<b>COOPER61</b>	1	759	963	1019	1212	1218	1402		68
	<b>COOPER62</b>	1	919	1123	1179	1372	1378	1562		66
	<b>COOPER64</b>	1	999	1203	1259	1452	1458	1642		66
	<b>COOPER65</b>	1	999	1203	1259	1452	1458	1642		66
	<b>COOPER67</b>	1	999	1203	1259	1452	1458	1642		66



22D-COOPER61



22D-COOPER62



22D-COOPER64



22D-COOPER65



22D-COOPER67

### STANDARD FEATURES

- Laminate tops available in any standard Wilsonart, Nevamar, Formica, Arborite or Pionite matte finish offerings. For other laminate please contact the factory for pricing.
- Veneers and hardwood edges are standard in Oak, Maple, Cherry, Pecan, Walnut, Mahogany and Chocolate.
- 7 veneer and hardwood edge stains are standard. Stain-to-match available at no upcharge.
- Standard table height 18".
- All bases are standard with floor leveling glides.

### OPTIONS

- Custom heights available.

### HOW TO ORDER

- Select Model
- Select Base
- Select Edge Style
- Select Top Finish
- Select Edge Finish
- Select Base Finish

**Example:** 22D - COOPER61 - PVF





# COOPER COLLECTION OCCASIONAL AND LOUNGE TABLES

BACK TO CONTENTS

MODEL	BASES		TOP SPECIFICATIONS						OPTIONS	LBS
	<i>Code</i>	<i>Qty.</i>	<i>For Laminate Top</i>			<i>For Veneer Top</i>				
			SE	HF	HBV	HF2	HF	HF2		
			PVF	HB	HBG	HKN4	HB	HKN4		
			PVB				HBV			
			2MM				HBG			
<i>Rectangle</i>										
<b>24 x 48RE</b>	<b>COOPER61</b>	1	732	928	979	1071	1127	1293		64
	<b>COOPER62</b>	1	892	1088	1139	1231	1287	1453		62
	<b>COOPER64</b>	1	972	1168	1219	1311	1367	1533		62
	<b>COOPER65</b>	1	972	1168	1219	1311	1367	1533		62
	<b>COOPER67</b>	1	972	1168	1219	1311	1367	1533		62



22D-COOPER61



22D-COOPER62



22D-COOPER64



22D-COOPER65



22D-COOPER67

### STANDARD FEATURES

- Laminate tops available in any standard Wilsonart, Nevamar, Formica, Arborite or Pionite matte finish offerings. For other laminate please contact the factory for pricing.
- Veneers and hardwood edges are standard in Oak, Maple, Cherry, Pecan, Walnut, Mahogany and Chocolate.
- 7 veneer and hardwood edge stains are standard. Stain-to-match available at no upcharge.
- Standard table height 18".
- All bases are standard with floor leveling glides.

### OPTIONS

- Custom heights available.

### HOW TO ORDER

1. Select Model
2. Select Base
3. Select Edge Style
4. Select Top Finish
5. Select Edge Finish
6. Select Base Finish

**Example:** 2448RE - COOPER61 - PVF  
MODEL      BASE      EDGE

# DANI TABLES



## PLACING AN ORDER IS EASY

### PRODUCT CODE

**2430 RE DANI O**

**Size**  
Width x Length

**Top Shape**  
D : Round  
SQ : Square  
RE : Rectangle

**Series**  
Dani

**Base**  
N/A : Round Post Leg  
O : Oval Post Leg  
OM : O with Magazine Shelf

### OPTIONS

#### ROUND LEG



#### OVAL LEG



#### MAGAZINE SHELF



### FINISHES

#### LAMINATE



Select laminate from our virtually unlimited laminate options

#### VENEER

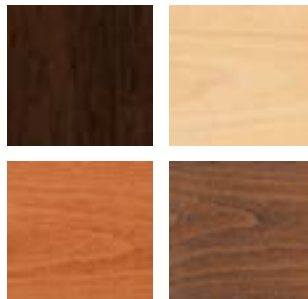

Select from one of our 7 standard wood stains or stain-to-match at no upcharge

#### BASE



Select from one of our 76 standard Spectone colors

#### EDGE



2MM

PVC

Hard Wood

Check out our website for a complete list of edge profiles.





# DANI OCCASIONAL AND LOUNGE TABLES

BACK TO CONTENTS

MODEL	BASES		TOP SPECIFICATIONS						OPTIONS	LBS
	Code	Qty.	For Laminate Top			For Veneer Top				
			SE	HF	HBV	HF2	HF	HF2		
			PVF	HB	HBVR	HB2	HB	HB2		
			PVB		HGG	HKN4	HBV	HKN4		
			2MM			HKNR4	HBVR	HKNR4		
						HGG2	HGG	HGG2		
<i>Round</i>										
18D	DANI	1	455	795	829	929	982	1085		20
	DANIO	1	560	900	934	1034	1087	1190		20
	DANIOM	1	704	1384	1452	1652	1758	1964		30
24D	DANI	1	466	795	829	929	982	1085		27
	DANIO	1	571	900	934	1034	1087	1190		27
	DANIOM	1	726	1384	1452	1652	1758	1964		37
30D	DANI	1	561	885	929	1128	1077	1228		37
	DANIO	1	666	990	1034	1233	1182	1333		37
	DANIOM	1	916	1564	1652	2050	1948	2250		47
36D	DANI	1	651	1122	1204	1367	1417	1626		48
	DANIO	1	756	1227	1309	1472	1522	1731		48
	DANIOM	1	1096	2038	2202	2528	2628	3046		58
42D	DANI	1	912	1439	1553	1795	1820	2106		62
	DANIO	1	1017	1544	1658	1900	1925	2211		62
	DANIOM	1	1618	2672	2900	3384	3434	4006		72



18D-DANI

### STANDARD FEATURES

- Laminate tops available in any standard Wilsonart, Nevamar, Formica, Arborite or Pionite matte finish offerings. For other laminate please contact the factory for pricing.
- Veneers and hardwood edges are standard in Oak, Maple, Cherry, Pecan, Walnut, Mahogany and Chocolate.
- 7 veneer and hardwood edge stains are standard. Stain-to-match available at no upcharge.
- Standard table height 18".
- All bases are standard with floor leveling glides.

### OPTIONS

- Custom heights available.

### HOW TO ORDER

- Select Model
- Select Base
- Select Edge Style
- Select Top Finish
- Select Edge Finish
- Select Base Finish

Example: 18D - DANI - PVF





# DANI OCCASIONAL AND LOUNGE TABLES

BACK TO CONTENTS

MODEL	BASES		TOP SPECIFICATIONS						OPTIONS	LBS
	Code	Qty.	For Laminate Top			For Veneer Top				
			SE	HF	HBV	HF2	HF	HF2		
			PVF	HB	HBVR	HB2	HB	HB2		
			PVB		HGG	HKN4	HBV	HKN4		
			2MM			HKNR4	HBVR	HKNR4		
						HGG2	HGG	HGG2		
<i>Square</i>										
18 x 18SQ	DANI	1	483	673	707	769	814	968		20
	DANIO	1	588	778	812	874	919	1073		20
	DANIOM	1	760	1140	1208	1332	1422	1730		30
24 x 24SQ	DANI	1	494	673	707	769	814	968		27
	DANIO	1	599	778	812	874	919	1073		27
	DANIOM	1	782	1140	1208	1332	1422	1730		37
30 x 30SQ	DANI	1	592	722	769	933	874	1085		37
	DANIO	1	697	827	874	1038	979	1190		37
	DANIOM	1	978	1238	1332	1660	1542	1964		47
36 x 36SQ	DANI	1	669	873	929	1122	1128	1312		48
	DANIO	1	774	978	1034	1227	1233	1417		48
	DANIOM	1	1132	1540	1652	2038	2050	2418		58
<i>Rectangle</i>										
24 x 36RE	DANI	1	581	703	747	810	859	978		36
	DANIO	1	686	808	852	915	964	1083		36
	DANIOM	1	956	1200	1288	1414	1512	1750		46



18SQ-DANI



18D-DANIO



2436RE-DANI



2436RE-DANIO

### STANDARD FEATURES

- Laminate tops available in any standard Wilsonart, Nevamar, Formica, Arborite or Pionite matte finish offerings. For other laminate please contact the factory for pricing.
- Veneers and hardwood edges are standard in Oak, Maple, Cherry, Pecan, Walnut, Mahogany and Chocolate.
- 7 veneer and hardwood edge stains are standard. Stain-to-match available at no upcharge.
- Standard table height 18".
- All bases are standard with floor leveling glides.

### OPTIONS

- Custom heights available.

### HOW TO ORDER

- Select Model
- Select Base
- Select Edge Style
- Select Top Finish
- Select Edge Finish
- Select Base Finish

Example: 18SQ - DANI - PVF





# DANI OCCASIONAL AND LOUNGE TABLES

BACK TO CONTENTS

MODEL	BASES		TOP SPECIFICATIONS						OPTIONS	LBS
	<i>Code</i>	<i>Qty.</i>	<i>For Laminate Top</i>			<i>For Veneer Top</i>				
			SE	HF	HBV	HF2	HF	HF2		
			PVF	HB	HBVR	HB2	HB	HB2		
			PVB		HGG	HKN4	HBV	HKN4		
			2MM			HKNR4	HBVR	HKNR4		
						HGG2	HGG	HGG2		
<i>Rectangle</i>										
24 x 42RE	DANI	1	642	838	889	981	1037	1203		40
	DANIO	1	747	943	994	1086	1142	1308		40
	DANIOM	1	1078	1470	1572	1756	1868	2200		50
24 x 48RE	DANI	1	642	838	889	981	1037	1203		44
	DANIO	1	747	943	994	1086	1142	1308		44
	DANIOM	1	1078	1470	1572	1756	1868	2200		54
30 x 36RE	DANI	1	669	810	860	940	998	1142		42
	DANIO	1	774	915	965	1045	1103	1247		42
	DANIOM	1	1132	1414	1514	1674	1790	2078		52
30 x 42RE	DANI	1	688	957	1019	1125	1203	1405		47
	DANIO	1	793	1062	1124	1230	1308	1510		47
	DANIOM	1	1170	1708	1832	2044	2200	2604		57
30 x 48RE	DANI	1	688	957	1019	1125	1203	1405		52
	DANIO	1	793	1062	1124	1230	1308	1510		52
	DANIOM	1	1170	1708	1832	2044	2200	2604		62



2436RE-DANI



2436RE-DANIO

### STANDARD FEATURES

- Laminate tops available in any standard Wilsonart, Nevamar, Formica, Arborite or Pionite matte finish offerings. For other laminate please contact the factory for pricing.
- Veneers and hardwood edges are standard in Oak, Maple, Cherry, Pecan, Walnut, Mahogany and Chocolate.
- 7 veneer and hardwood edge stains are standard. Stain-to-match available at no upcharge.
- Standard table height 18".
- All bases are standard with floor leveling glides.

### OPTIONS

- Custom heights available.

### HOW TO ORDER

1. Select Model
2. Select Base
3. Select Edge Style
4. Select Top Finish
5. Select Edge Finish
6. Select Base Finish

**Example:** 2442RE - DANI - PVF





# DRUM & CUBE TABLES



PLACING AN ORDER IS EASY

## PRODUCT CODE

**1818 SQ CUBE - 16**

**Size**

Width x Length

**Shape**

D : Round  
SQ : Square  
N/A : Oval

**Series**

CUBE : Square Cube  
DRUM : Round Drum  
OVAL : Oval Drum

**Height**

16: 16"  
18: 18"  
20: 20"  
22: 22"



## FINISHES

### LAMINATE



Select laminate from our virtually unlimited laminate options

### VENEER

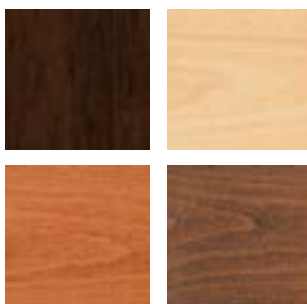

Select from one of our 7 standard wood stains or stain-to-match at no upcharge



# DRUM & CUBE TABLES

BACK TO CONTENTS

MODEL	BASES		TOP SPECIFICATIONS		OPTIONS	LBS
	Code	Qty.	Laminate	Veneer	Kickplate	
			SE	SE	KP	
<i>Round</i>						
<b>18D</b>	<b>DRM</b>	1	721	759	47	34
<b>24D</b>	<b>DRM</b>	1	762	803	47	48
<b>30D</b>	<b>DRM</b>	1	957	1000	47	62
<b>36D</b>	<b>DRM</b>	1	1084	1129	47	77
<b>42D</b>	<b>DRM</b>	1	1202	1281	47	94
<i>Square</i>						
<b>18 x 18SQ</b>	<b>CUBE</b>	1	547	759	47	37
<b>24 x 24SQ</b>	<b>CUBE</b>	1	577	802	47	56
<b>30 x 30SQ</b>	<b>CUBE</b>	1	725	885	47	69
<b>36 x 36SQ</b>	<b>CUBE</b>	1	843	1379	47	106
<i>Oval</i>						
<b>30 x 36</b>	<b>OVAL</b>	1	1595	1661	69	78
<b>30 x 42</b>	<b>OVAL</b>	1	1767	1884	69	91
<b>30 x 48</b>	<b>OVAL</b>	1	2241	2361	69	104



**DRM**

**CUBE**

**OVAL**

### STANDARD FEATURES

- Laminate tops available in any standard Wilsonart, Nevamar, Formica, Arborite or Pionite matte finish offerings. For other laminate please contact the factory for pricing.
- Veneers and hardwood edges are standard in Oak, Maple, Cherry, Pecan, Walnut, Mahogany and Chocolate.
- Other sizes are available. Contact the factory for pricing.
- Standard heights: 16", 18", 20" and 22". Please specify when ordering
- All bases are standard with floor leveling glides.

### OPTIONS

- Custom heights available.
- 2" kickplate.
- Power modules, add \$60 List for power cut-out, plus price of module in Table Accessories Price List

### HOW TO ORDER

1. Select Model
2. Select Base
3. Select Edge Style
4. Select Top Finish
5. Select Edge Finish
6. Select Base Finish

**Example:** 18D - DRM - SE

MODEL | BASE | EDGE

# DRUM BASES TABLES



PLACING AN ORDER IS EASY

## PRODUCT CODE

**4896 RE DR - L**

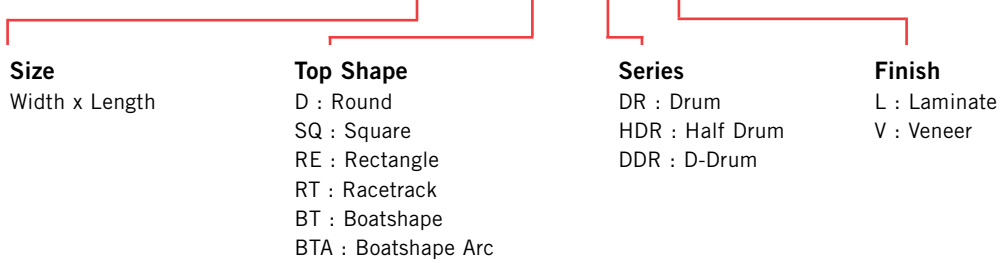

## OPTIONS

**DRUM**

**HALF DRUM**



## FINISHES

**LAMINATE**



Select laminate from our virtually unlimited laminate options

**VENEER**

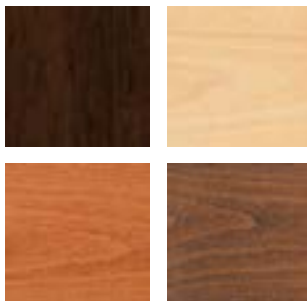

Select from one of our 7 standard wood stains or stain-to-match at no upcharge

**EDGE**



Check out our website for a complete list of edge profiles.



# DRUM BASES BOARDROOM AND CONFERENCE TABLES

MODEL	BASES		TOP SPECIFICATIONS						OPTIONS	LBS
	Code	Qty.	For Laminate Top			For Veneer Top				
			SE PVF PVB 2MM	HF HB	HBV HBVR HBG	HF2 HB2 HKNR4 HBG2	HF HB HBV HBG	HF2 HB2 HKNR4 HBG2		
<i>Round</i>										
42D	DR-L	1	1568	2095	2209	2451	2476	2762		102
	DR-V	1	1731	2258	2372	2614	2639	2925		102
48D	DR-L	1	1589	2297	2421	2541	2975	3343		118
	DR-V	1	1752	2460	2584	2704	3138	3506		118
54D	DR-L	1	1855	2898	3090	3274	3490	3962		136
	DR-V	1	2018	3061	3253	3437	3653	4125		136
60D	DR-L	1	1898	3083	3288	3443	4071	4658		155
	DR-V	1	2061	3246	3451	3606	4234	4821		155
<i>Square</i>										
36 x 36SQ	DR-L	1	1325	1529	1585	1778	1784	1968		88
	DR-V	1	1488	1692	1748	1941	1947	2131		88
42 x 42SQ	DR-L	1	1582	1877	1968	2059	2122	2373		102
	DR-V	1	1745	2040	2131	2222	2285	2536		102
48 x 48SQ	DR-L	1	1723	1982	2078	2120	2467	2789		118
	DR-V	1	1886	2145	2241	2283	2630	2952		118
54 x 54SQ	DR-L	1	1857	2429	2579	2753	2848	3266		136
	DR-V	1	2020	2592	2742	2916	3011	3429		136
60 x 60SQ	DR-L	1	1885	2526	2685	2861	3286	3792		155
	DR-V	1	2048	2689	2848	3024	3449	3955		155



4296RT-DR-L

### STANDARD FEATURES

- Laminate tops available in any standard Wilsonart, Nevamar, Formica, Arborite or Pionite matte finish offerings. For other laminate please contact the factory for pricing.
- Veneers and hardwood edges are standard in Oak, Chocolate, Maple, Cherry, Pecan, Walnut, Mahogany.
- 7 veneer and hardwood edge stains are standard. Stain-to-match available at no upcharge.
- Standard table height 29".
- All bases are standard with floor leveling glides.

### OPTIONS

- Custom heights available.

### HOW TO ORDER

1. Select Model
2. Select Base
3. Select Edge Style
4. Select Options
5. Select Top Finish
6. Select Edge Finish
7. Select Base Finish

Example: 42D - DR-L - PVF -





# DRUM BASES BOARDROOM AND CONFERENCE TABLES

MODEL	BASES		TOP SPECIFICATIONS						OPTIONS	LBS
	Code	Qty.	For Laminate Top			For Veneer Top				
			SE PVF PVB 2MM	HF HB	HBV HBVR HBG	HF2 HB2 HKN4 HKNR4 HBG2	HF HB HBV HBG	HF2 HB2 HKN4 HKNR4 HBG2		
<i>Rectangle</i>										
36 x 66RE	HDR-L	2	2591	3003	3119	3296	3407	3747		176
	HDR-V	2	2917	3329	3445	3622	3733	4073		176
36 x 72RE	HDR-L	2	2627	3057	3168	3424	3547	3915		176
	HDR-V	2	2953	3383	3494	3750	3873	4241		176
36 x 78RE	HDR-L	2	2940	3400	3544	3766	3911	4344		189
	HDR-V	2	3266	3726	3870	4092	4237	4670		189
36 x 84RE	HDR-L	2	2940	3400	3544	3766	3911	4344		189
	HDR-V	2	3266	3726	3870	4092	4237	4670		189
36 x 90RE	HDR-L	2	2945	3601	3766	4025	4191	4672		201
	HDR-V	2	3271	3927	4092	4351	4517	4998		201
36 x 96RE	HDR-L	2	2945	3601	3766	4025	4191	4672		201
	HDR-V	2	3271	3927	4092	4351	4517	4998		201
42 x 78RE	HDR-L	2	3166	3562	3720	4102	4228	4730		203
	HDR-V	2	3492	3888	4046	4428	4554	5056		203
42 x 84RE	HDR-L	2	3166	3562	3720	4102	4228	4730		203
	HDR-V	2	3492	3888	4046	4428	4554	5056		203
42 x 96RE	HDR-L	2	3214	4047	4273	4500	4838	5490		235
	HDR-V	2	3540	4373	4599	4826	5164	5816		235



4296RT-HDR-L

### STANDARD FEATURES

- Laminate tops available in any standard Wilsonart, Nevamar, Formica, Arborite or Pionite matte finish offerings. For other laminate please contact the factory for pricing.
- Veneers and hardwood edges are standard in Oak, Chocolate, Maple, Cherry, Pecan, Walnut, Mahogany.
- 7 veneer and hardwood edge stains are standard. Stain-to-match available at no upcharge.
- Standard table height 29".
- All bases are standard with floor leveling glides.

### OPTIONS

- Custom heights available.

### HOW TO ORDER

1. Select Model
2. Select Base
3. Select Edge Style
4. Select Options
5. Select Top Finish
6. Select Edge Finish
7. Select Base Finish

**Example:** 3666RE - HDR-L - PVF -







# DRUM BASES BOARDROOM AND CONFERENCE TABLES

MODEL	BASES		TOP SPECIFICATIONS						OPTIONS	LBS
	Code	Qty.	For Laminate Top			For Veneer Top				
			SE	HF	HBV	HF2	HF	HF2		
			PVF	HB	HBVR	HB2	HB	HB2		
			PVB		HBG	HKN4	HBV	HKN4		
			2MM			HKNR4	HBVR	HKNR4		
						HBG2	HBG	HBG2		
<i>Rectangle</i>										
48 x 96RE	HDR-L	2	3214	4047	4273	4500	4838	5490		235
	HDR-V	2	3540	4373	4599	4826	5164	5816		235
48 x 120RE	DR-L	2	3524	4599	4854	5403	5485	6246		268
	DR-V	2	3850	4925	5180	5729	5811	6572		268
	DDR-L	2	3776	4851	5106	5655	5737	6498		284
48 X 144RE	DDR-V	2	4102	5177	5432	5981	6063	6824		284
	DR-L	2	3887	5429	5764	6287	6163	7080		302
	DR-V	2	4213	5755	6090	6613	6489	7406		302
48 X 168RE	DDR-L	2	4139	5681	6016	6539	6415	7332		318
	DDR-V	2	4465	6007	6342	6865	6741	7658		318
	DR-L	3	5306	6858	7241	7971	7802	8868		386
48 X 168RE	DR-V	3	5795	7347	7730	8460	8291	9357		386
	DDR-L	3	5561	7113	7496	8226	8057	9123		410
	DDR-V	3	6047	7599	7982	8712	8543	9609		410



4296RT-HDR-L



4296RT-DR-L

### STANDARD FEATURES

- Laminate tops available in any standard Wilsonart, Nevamar, Formica, Arborite or Pionite matte finish offerings. For other laminate please contact the factory for pricing.
- Veneers and hardwood edges are standard in Oak, Chocolate, Maple, Cherry, Pecan, Walnut, Mahogany.
- 7 veneer and hardwood edge stains are standard. Stain-to-match available at no upcharge.
- Standard table height 29".
- All bases are standard with floor leveling glides.

### OPTIONS

- Custom heights available.

### HOW TO ORDER

1. Select Model
2. Select Base
3. Select Edge Style
4. Select Options
5. Select Top Finish
6. Select Edge Finish
7. Select Base Finish

**Example:** 4896RE - HDR-L - PVF -





# DRUM BASES BOARDROOM AND CONFERENCE TABLES

MODEL	BASES		TOP SPECIFICATIONS						OPTIONS	LBS
	Code	Qty.	For Laminate Top			For Veneer Top				
			SE	HF	HBV	HF2	HF	HF2		
			PVF	HB	HBVR	HB2	HB	HB2		
			PVB		HGG	HKN4	HBV	HKN4		
			2MM			HKNR4	HBVR	HKNR4		
						HGG2	HGG	HGG2		
<i>Rectangle</i>										
60 x 120RE	DR-L	2	3967	5575	5926	6469	6340	7295		310
	DR-V	2	4293	5901	6252	6795	6666	7621		310
	DDR-L	2	4219	5827	6178	6721	6592	7547		326
	DDR-V	2	4545	6153	6504	7047	6918	7873		326
60 X 144RE	DR-L	2	4378	6307	6728	7378	7225	8371		352
	DR-V	2	4704	6633	7054	7704	7551	8697		352
	DDR-L	2	4630	6559	6980	7630	7477	8623		368
	DDR-V	2	4956	6885	7306	7956	7803	8949		368
60 X 168RE	DR-L	3	5747	7998	8486	9248	9067	10404		444
	DR-V	3	6236	8487	8975	9737	9556	10893		444
	DDR-L	3	6002	8253	8741	9503	9322	10659		468
	DDR-V	3	6488	8739	9227	9989	9808	11145		468



4296RT-DR-L

### STANDARD FEATURES

- Laminate tops available in any standard Wilsonart, Nevamar, Formica, Arborite or Pionite matte finish offerings. For other laminate please contact the factory for pricing.
- Veneers and hardwood edges are standard in Oak, Chocolate, Maple, Cherry, Pecan, Walnut, Mahogany.
- 7 veneer and hardwood edge stains are standard. Stain-to-match available at no upcharge.
- Standard table height 29".
- All bases are standard with floor leveling glides.

### OPTIONS

- Custom heights available.

### HOW TO ORDER

1. Select Model
2. Select Base
3. Select Edge Style
4. Select Options
5. Select Top Finish
6. Select Edge Finish
7. Select Base Finish

**Example:** 60120RE - DR-L - PVF -





# DRUM BASES BOARDROOM AND CONFERENCE TABLES

MODEL	BASES		TOP SPECIFICATIONS						OPTIONS	LBS
	Code	Qty.	For Laminate Top			For Veneer Top				
			SE PVF PVB 2MM	HF HB	HBV HBVR HBG	HF2 HB2 HKN4 HBG2	HF HB HBV HBG	HF2 HB2 HKN4 HBG2		
<i>Racetrack</i>										
36 x 54RT	HDR-L	2	2561	3084	3206	3424	3513	3832		163
	HDR-V	2	2887	3410	3532	3750	3839	4158		163
36 x 60RT	HDR-L	2	2561	3084	3206	3424	3513	3832		163
	HDR-V	2	2887	3410	3532	3750	3839	4158		163
36 x 66RT	HDR-L	2	2709	3255	3387	3620	3826	4224		176
	HDR-V	2	3035	3581	3713	3946	4152	4550		176
36 x 72RT	HDR-L	2	2709	3255	3387	3620	3826	4224		176
	HDR-V	2	3035	3581	3713	3946	4152	4550		176
36 x 78RT	HDR-L	2	2955	3649	3811	4164	4238	4703		189
	HDR-V	2	3281	3975	4137	4490	4564	5029		189
36 x 84RT	HDR-L	2	2955	3649	3811	4164	4238	4703		189
	HDR-V	2	3281	3975	4137	4490	4564	5029		189
36 x 90RT	HDR-L	2	2959	3885	4078	4473	4565	5094		201
	HDR-V	2	3285	4211	4404	4799	4891	5420		201
36 x 96RT	HDR-L	2	2959	3885	4078	4473	4565	5094		201
	HDR-V	2	3285	4211	4404	4799	4891	5420		201
42 x 78RT	HDR-L	2	3180	3836	4035	4434	4530	5065		218
	HDR-V	2	3506	4162	4361	4760	4856	5391		218
42 x 84RT	HDR-L	2	3180	3836	4035	4434	4530	5065		218
	HDR-V	2	3506	4162	4361	4760	4856	5391		218
42 x 96RT	HDR-L	2	3234	4175	4404	4956	5346	6041		235
	HDR-V	2	3560	4501	4730	5282	5672	6367		235



4296RT-HDR-L

### STANDARD FEATURES

- Laminate tops available in any standard Wilsonart, Nevamar, Formica, Arborite or Pionite matte finish offerings. For other laminate please contact the factory for pricing.
- Veneers and hardwood edges are standard in Oak, Chocolate, Maple, Cherry, Pecan, Walnut, Mahogany.
- 7 veneer and hardwood edge stains are standard. Stain-to-match available at no upcharge.
- Standard table height 29".
- All bases are standard with floor leveling glides.

### OPTIONS

- Custom heights available.

### HOW TO ORDER

1. Select Model
2. Select Base
3. Select Edge Style
4. Select Options
5. Select Top Finish
6. Select Edge Finish
7. Select Base Finish

**Example:** 3654RT - HDR-L - PVF -





# DRUM BASES BOARDROOM AND CONFERENCE TABLES

MODEL	BASES		TOP SPECIFICATIONS						OPTIONS	LBS
	Code	Qty.	For Laminate Top			For Veneer Top				
			SE	HF	HBV	HF2	HF	HF2		
			PVF	HB	HBVR	HB2	HB	HB2		
			PVB		HGG	HKN4	HBV	HKN4		
			2MM			HKNR4	HBVR	HKNR4		
						HGG2	HGG	HGG2		
<i>Racetrack</i>										
48 x 78RT	HDR-L	2	3183	4118	4343	4696	4917	5525		218
	HDR-V	2	3509	4444	4669	5022	5243	5851		218
48 x 84RT	DR-L	2	3183	4118	4343	4696	4917	5525		218
	DR-V	2	3509	4444	4669	5022	5243	5851		218
48 x 96RT	DDR-L	2	3234	4175	4404	4956	5346	6041		235
	DDR-V	2	3560	4501	4730	5282	5672	6367		235
48 x 120RT	DR-L	2	3548	5042	5341	6102	6070	6882		268
	DR-V	2	3874	5368	5667	6428	6396	7208		268
	DDR-L	2	3800	5294	5593	6354	6322	7134		284
	DDR-V	2	4126	5620	5919	6680	6648	7460		284
48 x 144RT	DR-L	2	3914	5775	6141	7085	6866	7850		302
	DR-V	2	4240	6101	6467	7411	7192	8176		302
	DDR-L	2	4166	6027	6393	7337	7118	8102		318
	DDR-V	2	4492	6353	6719	7663	7444	8428		318
48 x 168RT	DR-L	3	5336	7359	7788	8835	8631	9772		386
	DR-V	3	5825	7848	8277	9324	9120	10261		386
	DDR-L	3	5591	7614	8043	9090	8886	10027		410
	DDR-V	3	6077	8100	8529	9576	9372	10513		410



4296RT-HDR-L



4296RT-DR-L

### STANDARD FEATURES

- Laminate tops available in any standard Wilsonart, Nevamar, Formica, Arborite or Pionite matte finish offerings. For other laminate please contact the factory for pricing.
- Veneers and hardwood edges are standard in Oak, Chocolate, Maple, Cherry, Pecan, Walnut, Mahogany.
- 7 veneer and hardwood edge stains are standard. Stain-to-match available at no upcharge.
- Standard table height 29".
- All bases are standard with floor leveling glides.

### OPTIONS

- Custom heights available.

### HOW TO ORDER

1. Select Model
2. Select Base
3. Select Edge Style
4. Select Options
5. Select Top Finish
6. Select Edge Finish
7. Select Base Finish

**Example:** 4878RT - HDR-L - PVF -





# DRUM BASES BOARDROOM AND CONFERENCE TABLES

MODEL	BASES		TOP SPECIFICATIONS						OPTIONS	LBS
	Code	Qty.	For Laminate Top			For Veneer Top				
			SE	HF	HBV	HF2	HF	HF2		
			PVF	HB	HBVR	HB2	HB	HB2		
			PVB		HGG	HKN4	HBV	HKN4		
			2MM			HKNR4	HBVR	HKNR4		
						HGG2	HGG	HGG2		
<i>Racetrack</i>										
60 x 120RT	DR-L	2	3957	5824	6195	7151	7108	8127		310
	DR-V	2	4283	6150	6521	7477	7434	8453		310
	DDR-L	2	4209	6076	6447	7403	7360	8379		326
	DDR-V	2	4535	6402	6773	7729	7686	8705		326
60 x 144RT	DR-L	2	4414	6739	7199	8380	8105	9335		352
	DR-V	2	4740	7065	7525	8706	8431	9661		352
	DDR-L	2	4666	6991	7451	8632	8357	9587		368
	DDR-V	2	4992	7317	7777	8958	8683	9913		368
60 x 168RT	DR-L	3	5953	8483	9018	10323	10071	11497		444
	DR-V	3	6442	8972	9507	10812	10560	11986		444
	DDR-L	3	6208	8738	9273	10578	10326	11752		468
	DDR-V	3	6694	9224	9759	11064	10812	12238		468



4296RT-DR-L

### STANDARD FEATURES

- Laminate tops available in any standard Wilsonart, Nevamar, Formica, Arborite or Pionite matte finish offerings. For other laminate please contact the factory for pricing.
- Veneers and hardwood edges are standard in Oak, Chocolate, Maple, Cherry, Pecan, Walnut, Mahogany.
- 7 veneer and hardwood edge stains are standard. Stain-to-match available at no upcharge.
- Standard table height 29".
- All bases are standard with floor leveling glides.

### OPTIONS

- Custom heights available.

### HOW TO ORDER

1. Select Model
2. Select Base
3. Select Edge Style
4. Select Options
5. Select Top Finish
6. Select Edge Finish
7. Select Base Finish

**Example:** 60120RT - DR-L - PVF -





# DRUM BASES BOARDROOM AND CONFERENCE TABLES

MODEL	BASES		TOP SPECIFICATIONS						OPTIONS	LBS
	Code	Qty.	For Laminate Top			For Veneer Top				
			SE	HF	HBV	HF2	HF	HF2		
			PVF	HB	HBVR	HB2	HB	HB2		
			PVB		HBG	HKN4	HBV	HKN4		
			2MM			HKNR4	HBVR	HKNR4		
						HBG2	HBG	HBG2		
<i>Boatshape</i>										
42 x 96BT	HDR-L	2	3234	4817	5112	5416	5847	6226		235
	HDR-V	2	3560	5143	5438	5742	6173	6552		235
48 x 96BT	HDR-L	2	3234	4817	5112	5416	5847	6226		235
	HDR-V	2	3560	5143	5438	5742	6173	6552		235
48 x 120BT	DR-L	2	3548	5746	6112	6497	6662	7099		268
	DR-V	2	3874	6072	6438	6823	6988	7425		268
	DDR-L	2	3800	5998	6364	6749	6914	7351		284
48 x 144BT	DDR-V	2	4126	6324	6690	7075	7240	7677		284
	DR-L	2	3914	6479	6915	7378	7962	8360		302
	DR-V	2	4240	6805	7241	7704	8288	8686		302
48 x 168BT	DDR-L	2	4166	6731	7167	7630	8214	8612		318
	DDR-V	2	4492	7057	7493	7956	8540	8938		318
	DR-L	3	5336	8138	8645	9180	9453	10068		386
	DR-V	3	5825	8627	9134	9669	9942	10557		386
	DDR-L	3	5591	8393	8900	9435	9708	10323		410
	DDR-V	3	6077	8879	9386	9921	10194	10809		410



4296RT-HDR-L



4296RT-DR-L

### STANDARD FEATURES

- Laminate tops available in any standard Wilsonart, Nevamar, Formica, Arborite or Pionite matte finish offerings. For other laminate please contact the factory for pricing.
- Veneers and hardwood edges are standard in Oak, Chocolate, Maple, Cherry, Pecan, Walnut, Mahogany.
- 7 veneer and hardwood edge stains are standard. Stain-to-match available at no upcharge.
- Standard table height 29".
- All bases are standard with floor leveling glides.

### OPTIONS

- Custom heights available.

### HOW TO ORDER

1. Select Model
2. Select Base
3. Select Edge Style
4. Select Top Finish
5. Select Edge Finish
6. Select Base Finish

**Example:** 4296BT - HDR-L - PVF





# DRUM BASES BOARDROOM AND CONFERENCE TABLES

MODEL	BASES		TOP SPECIFICATIONS						OPTIONS	LBS
	Code	Qty.	For Laminate Top			For Veneer Top				
			SE	HF	HBV	HF2	HF	HF2		
			PVF	HB	HBVR	HB2	HB	HB2		
			PVB		HGG	HKN4	HBV	HKN4		
			2MM			HKNR4	HBVR	HKNR4		
						HGG2	HGG	HGG2		
<i>Boatshape</i>										
60 x 120BT	DR-L	2	3957	6702	7162	7643	7850	8394		310
	DR-V	2	4283	7028	7488	7969	8176	8720		310
	DDR-L	2	4209	6954	7414	7895	8102	8646		326
	DDR-V	2	4535	7280	7740	8221	8428	8972		326
60 x 144BT	DR-L	2	4414	7621	8166	8745	9473	9972		352
	DR-V	2	4740	7947	8492	9071	9799	10298		352
	DDR-L	2	4666	7873	8418	8997	9725	10224		368
	DDR-V	2	4992	8199	8744	9323	10051	10550		368
60 x 168BT	DR-L	3	5953	9456	10089	10758	11096	11867		444
	DR-V	3	6442	9945	10578	11247	11585	12356		444
	DDR-L	3	6208	9711	10344	11013	11351	12122		468
	DDR-V	3	6694	10197	10830	11499	11837	12608		468



4296RT-DR-L

### STANDARD FEATURES

- Laminate tops available in any standard Wilsonart, Nevamar, Formica, Arborite or Pionite matte finish offerings. For other laminate please contact the factory for pricing.
- Veneers and hardwood edges are standard in Oak, Chocolate, Maple, Cherry, Pecan, Walnut, Mahogany.
- 7 veneer and hardwood edge stains are standard. Stain-to-match available at no upcharge.
- Standard table height 29".
- All bases are standard with floor leveling glides.

### OPTIONS

- Custom heights available.

### HOW TO ORDER

1. Select Model
2. Select Base
3. Select Edge Style
4. Select Top Finish
5. Select Edge Finish
6. Select Base Finish

**Example:** 60120BT - DR-L - PVF

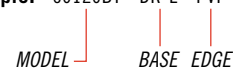



# DRUM BASES BOARDROOM AND CONFERENCE TABLES

MODEL	BASES		TOP SPECIFICATIONS						OPTIONS	LBS
	<i>Code</i>	<i>Qty.</i>	<i>For Laminate Top</i>			<i>For Veneer Top</i>				
			SE	HF	HBV	HF2	HF	HF2		
			PVF	HB	HBVR	HB2	HB	HB2		
			PVB		HGG	HKN4	HBV	HKN4		
			2MM			HKNR4	HBVR	HKNR4		
						HGG2	HGG	HGG2		
<i>Boatshape</i>										
<i>Arc Ends</i>										
<b>42 x 96BTA</b>	HDR-L	2	3394	5322	5618	5924	6352	6732		235
	HDR-V	2	3720	5648	5944	6250	6678	7058		235
<b>48 x 96BTA</b>	HDR-L	2	3394	5322	5618	5924	6352	6732		235
	HDR-V	2	3720	5648	5944	6250	6678	7058		235
<b>48 x 120BTA</b>	DR-L	2	3709	6253	6619	7005	7169	7604		268
	DR-V	2	4035	6579	6945	7331	7495	7930		268
	DDR-L	2	3961	6505	6871	7257	7421	7856		284
	DDR-V	2	4287	6831	7197	7583	7747	8182		284
<b>48 x 144BTA</b>	DR-L	2	4075	6984	7423	7886	8467	8867		302
	DR-V	2	4401	7310	7749	8212	8793	9193		302
	DDR-L	2	4327	7236	7675	8138	8719	9119		318
	DDR-V	2	4653	7562	8001	8464	9045	9445		318
<b>48 x 168BTA</b>	DR-L	3	5498	8645	9153	9688	9958	10576		386
	DR-V	3	5987	9134	9642	10177	10447	11065		386
	DDR-L	3	5753	8900	9408	9943	10213	10831		410
	DDR-V	3	6239	9386	9894	10429	10699	11317		410



4296RT-HDR-L



4296RT-DR-L

### STANDARD FEATURES

- Laminate tops available in any standard Wilsonart, Nevamar, Formica, Arborite or Pionite matte finish offerings. For other laminate please contact the factory for pricing.
- Veneers and hardwood edges are standard in Oak, Chocolate, Maple, Cherry, Pecan, Walnut, Mahogany.
- 7 veneer and hardwood edge stains are standard. Stain-to-match available at no upcharge.
- Standard table height 29".
- All bases are standard with floor leveling glides.

### OPTIONS

- Custom heights available.

### HOW TO ORDER

1. Select Model
2. Select Base
3. Select Edge Style
4. Select Top Finish
5. Select Edge Finish
6. Select Base Finish

**Example:** 4296BTA - HDR-L - PVF







# DRUM BASES BOARDROOM AND CONFERENCE TABLES

MODEL	BASES		TOP SPECIFICATIONS						OPTIONS	LBS
	<i>Code</i>	<i>Qty.</i>	<i>For Laminate Top</i>			<i>For Veneer Top</i>				
			SE	HF	HBV	HF2	HF	HF2		
			PVF	HB	HBVR	HB2	HB	HB2		
			PVB		HGG	HKN4	HBV	HKN4		
			2MM			HKNR4	HBVR	HKNR4		
						HGG2	HGG	HGG2		
<i>Boatshape</i>										
<i>Arc Ends</i>										
<b>60 x 120BTA</b>	DR-L	2	4159	7338	7794	8277	8482	9026		310
	DR-V	2	4485	7664	8120	8603	8808	9352		310
	DDR-L	2	4411	7590	8046	8529	8734	9278		326
	DDR-V	2	4737	7916	8372	8855	9060	9604		326
<b>60 x 144BTA</b>	DR-L	2	4614	8252	8800	9378	10106	10603		352
	DR-V	2	4940	8578	9126	9704	10432	10929		352
	DDR-L	2	4866	8504	9052	9630	10358	10855		368
	DDR-V	2	5192	8830	9378	9956	10684	11181		368
<b>60 x 168BTA</b>	DR-L	3	6153	10089	10722	11389	11731	12502		444
	DR-V	3	6642	10578	11211	11878	12220	12991		444
	DDR-L	3	6408	10344	10977	11644	11986	12757		468
	DDR-V	3	6894	10830	11463	12130	12472	13243		468



4296RT-DR-L

### STANDARD FEATURES

- Laminate tops available in any standard Wilsonart, Nevamar, Formica, Arborite or Pionite matte finish offerings. For other laminate please contact the factory for pricing.
- Veneers and hardwood edges are standard in Oak, Chocolate, Maple, Cherry, Pecan, Walnut, Mahogany.
- 7 veneer and hardwood edge stains are standard. Stain-to-match available at no upcharge.
- Standard table height 29".
- All bases are standard with floor leveling glides.

### OPTIONS

- Custom heights available.

### HOW TO ORDER

1. Select Model
2. Select Base
3. Select Edge Style
4. Select Top Finish
5. Select Edge Finish
6. Select Base Finish

**Example:** 60120BTA - DR-L - PVF

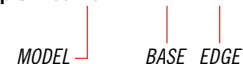



# ENDZONE TABLES

BACK TO CONTENTS



PLACING AN ORDER IS EASY

## PRODUCT CODE

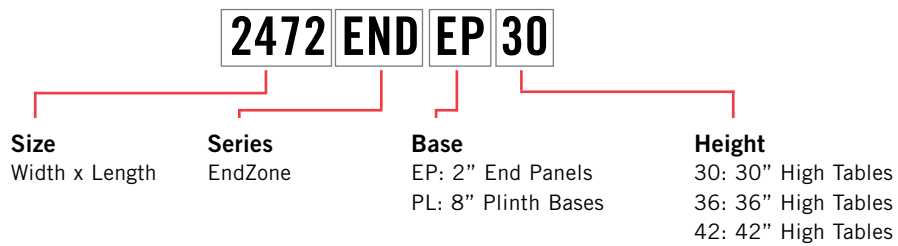

## OPTIONS

### END PANEL



2" End Panel



8" Plinth Bases

### RECTANGLE WIRE MANAGER



### POWER OPTIONS



Power Access Door



Cove with multiple placement options

### FOOT REST



## FINISHES

### LAMINATE



Select laminate from our virtually unlimited laminate options

### VENEER

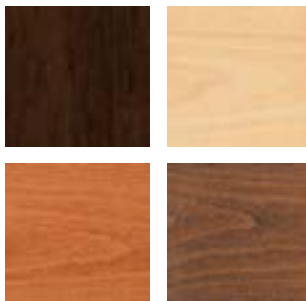

Select from one of our 7 standard wood stains or stain-to-match at no upcharge

### EDGE



2MM

PVC

Check out our website for a complete list of edge profiles.

### TROUGH

Select from one of our 76 standard Spectone colors.





# ENDZONE WITH 2" END PANELS

## 30" HIGH TABLE

BACK TO CONTENTS



SIZE	MODEL			LIST		OPTIONS		LBS
Depth x Length	Code	# Legs	# Top Sections	Laminate SE 2MM	Veneer SE 2MM	VERTICAL WIRE MGR (EACH) Add	FOOT REST (PER SIDE) Add	
<b>24" DEPTH</b>								
24 x 72	2472ENDEP30	2	1	2852	4392	172	459	163
24 x 84	2484ENDEP30	2	1	3039	4758	172	459	174
24 x 96	2496ENDEP30	2	1	3118	5138	172	459	186
24 x 108	24108ENDEP30	2	1	4555	6751	172	459	221
24 x 120	24120ENDEP30	2	1	4817	7013	172	459	236
24 x 144	24144ENDEP30	3	2	4917	7913	172	918	277
24 x 168	24168ENDEP30	3	2	7106	10462	172	918	300
24 x 192	24192ENDEP30	3	2	7462	11416	172	918	365
24 x 216	24216ENDEP30	3	2	8572	12466	172	918	394
<b>30" DEPTH</b>								
30 x 72	3072ENDEP30	2	1	3008	4870	172	459	194
30 x 84	3084ENDEP30	2	1	3320	5321	172	459	207
30 x 96	3096ENDEP30	2	1	3396	5781	172	459	220
30 x 108	30108ENDEP30	2	1	4698	7462	172	459	257
30 x 120	30120ENDEP30	2	1	4960	7724	172	459	273
30 x 144	30144ENDEP30	3	2	5228	8869	172	918	328
30 x 168	30168ENDEP30	3	2	7669	11586	172	918	355
30 x 192	30192ENDEP30	3	2	8018	12705	172	918	423
30 x 216	30216ENDEP30	3	2	8859	13900	172	918	455

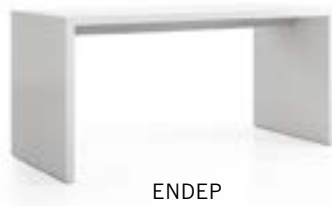

### STANDARD FEATURES

- 2" built up edge
- Specify Self edge (SE) or 2mm Edge (2MM)
- 30" height
- Undersurface Support Trough
- Recessed Glides
- Ships Knocked Down

### OPTIONS

- 2mm Bio edge available in 38 solid colors
- 2mm PVC edge available in wood grain to match 7 standard stains
- Specify power modules for EndZone. Power Access Door and Cove power available, see the end of EndZone tables section
- Rectangular Vertical Wire Manager
- For Solid Core laminate, call factory for pricing
- Foot Rest only available in chrome
- For two different laminate colors, call factory for pricing

### HOW TO ORDER

1. Select Size
2. Select Base Style
3. Select Edge Style
4. Select Top Finish
5. Select Edge Finish
6. Select Base Finish
7. Select Metal Finish

**Example:** 3072- ENDEP - 30 - 2MM -





# ENDZONE WITH 2" END PANELS

## 30" HIGH TABLE

BACK TO CONTENTS



SIZE	MODEL			LIST		OPTIONS		LBS
Depth x Length	Code	# Legs	# Top Sections	Laminate SE 2MM	Veneer SE 2MM	VERTICAL WIRE MGR (EACH) <i>Add</i>	FOOT REST (PER SIDE) <i>Add</i>	
<b>36" DEPTH</b>								
36 x 72	3672ENDEP30	2	1	3077	5690	172	459	225
36 x 84	3684ENDEP30	2	1	3518	6355	172	459	240
36 x 96	3696ENDEP30	2	1	3575	6879	172	459	255
36 x 108	36108ENDEP30	2	1	4803	8253	172	459	293
36 x 120	36120ENDEP30	2	1	5065	8993	172	459	310
36 x 144	36144ENDEP30	3	2	5366	10278	172	918	379
36 x 168	36168ENDEP30	3	2	8065	13426	172	918	409
36 x 192	36192ENDEP30	3	2	8377	14670	172	918	480
36 x 216	36216ENDEP30	3	2	9038	15669	172	918	515
<b>42" DEPTH</b>								
42 x 72	4272ENDEP30	2	1	3416	6177	172	459	256
42 x 84	4284ENDEP30	2	1	3800	6911	172	459	272
42 x 96	4296ENDEP30	2	1	3912	8056	172	459	289
42 x 108	42108ENDEP30	2	1	5236	9528	172	459	328
42 x 120	42120ENDEP30	2	1	5498	9790	172	459	348
42 x 144	42144ENDEP30	3	2	6044	11252	172	918	430
42 x 168	42168ENDEP30	3	2	8628	14538	172	918	463
42 x 192	42192ENDEP30	3	2	9051	17023	172	918	538
42 x 216	42216ENDEP30	3	2	9935	17130	172	918	576



### STANDARD FEATURES

- 2" built up edge
- Specify Self edge (SE) or 2mm Edge (2MM)
- 30" height
- Undersurface Support Trough
- Recessed Glides
- Ships Knocked Down

### OPTIONS

- 2mm Bio edge available in 38 solid colors
- 2mm PVC edge available in wood grain to match 7 standard stains
- Specify power modules for EndZone. Power Access Door and Cove power available, see the end of EndZone tables section
- Rectangular Vertical Wire Manager
- For Solid Core laminate, call factory for pricing
- Foot Rest only available in chrome
- For two different laminate colors, call factory for pricing

### HOW TO ORDER

1. Select Size
2. Select Base Style
3. Select Edge Style
4. Select Top Finish
5. Select Edge Finish
6. Select Base Finish
7. Select Metal Finish

**Example:** 3072- ENDEP - 30 - 2MM -  
 DEPTH x LENGTH      BASE      HEIGHT      EDGE



# ENDZONE WITH 2" END PANELS

## 36" HIGH TABLE

BACK TO CONTENTS

SIZE	MODEL			LIST		OPTIONS		LBS
Depth x Length	Code	# Legs	# Top Sections	Laminate SE 2MM	Veneer SE 2MM	VERTICAL WIRE MGR (EACH) <i>Add</i>	FOOT REST (PER SIDE) <i>Add</i>	
<b>24" DEPTH</b>								
24 x 72	2472ENDEP36	2	1	3002	4544	172	459	167
24 x 84	2484ENDEP36	2	1	3189	4910	172	459	179
24 x 96	2496ENDEP36	2	1	3268	5290	172	459	191
24 x 108	24108ENDEP36	2	1	4705	6903	172	459	227
24 x 120	24120ENDEP36	2	1	4967	7165	172	459	241
24 x 144	24144ENDEP36	3	2	5142	8141	172	918	284
24 x 168	24168ENDEP36	3	2	7331	10690	172	918	308
24 x 192	24192ENDEP36	3	2	7687	11644	172	918	374
24 x 216	24216ENDEP36	3	2	8797	12694	172	918	404
<b>30" DEPTH</b>								
30 x 72	3072ENDEP36	2	1	3158	5022	172	459	198
30 x 84	3084ENDEP36	2	1	3470	5473	172	459	212
30 x 96	3096ENDEP36	2	1	3546	5933	172	459	226
30 x 108	30108ENDEP36	2	1	4848	7614	172	459	263
30 x 120	30120ENDEP36	2	1	5110	7876	172	459	280
30 x 144	30144ENDEP36	3	2	5453	9097	172	918	336
30 x 168	30168ENDEP36	3	2	7894	11814	172	918	363
30 x 192	30192ENDEP36	3	2	8243	12933	172	918	433
30 x 216	30216ENDEP36	3	2	9084	14128	172	918	466



### STANDARD FEATURES

- 2" built up edge
- Specify Self edge (SE) or 2mm Edge (2MM)
- 36" height
- Undersurface Support Trough
- Recessed Glides
- Ships Knocked Down

### OPTIONS

- 2mm Bio edge available in 38 solid colors
- 2mm PVC edge available in wood grain to match 7 standard stains
- Specify power modules for EndZone. Power Access Door and Cove power available, see the end of EndZone tables section
- Rectangular Vertical Wire Manager
- For Solid Core laminate, call factory for pricing
- Foot Rest only available in chrome
- For two different laminate colors, call factory for pricing

### HOW TO ORDER

1. Select Size
2. Select Base Style
3. Select Edge Style
4. Select Top Finish
5. Select Edge Finish
6. Select Base Finish
7. Select Metal Finish

**Example:** 3072- ENDEP - 30 - 2MM -





# ENDZONE WITH 2" END PANELS

## 36" HIGH TABLE

BACK TO CONTENTS

SIZE	MODEL			LIST		OPTIONS		LBS
Depth x Length	Code	# Legs	# Top Sections	Laminate SE 2MM	Veneer SE 2MM	VERTICAL WIRE MGR (EACH) <i>Add</i>	FOOT REST (PER SIDE) <i>Add</i>	
<b>36" DEPTH</b>								
36 x 72	3672ENDEP36	2	1	3227	5840	172	459	230
36 x 84	3684ENDEP36	2	1	3668	6505	172	459	245
36 x 96	3696ENDEP36	2	1	3725	7029	172	459	261
36 x 108	36108ENDEP36	2	1	4953	8403	172	459	300
36 x 120	36120ENDEP36	2	1	5215	9143	172	459	318
36 x 144	36144ENDEP36	3	2	5591	10503	172	918	388
36 x 168	36168ENDEP36	3	2	8290	13651	172	918	419
36 x 192	36192ENDEP36	3	2	8602	14895	172	918	492
36 x 216	36216ENDEP36	3	2	9263	15894	172	918	528
<b>42" DEPTH</b>								
42 x 72	4272ENDEP36	2	1	3566	6327	172	459	262
42 x 84	4284ENDEP36	2	1	3950	7061	172	459	279
42 x 96	4296ENDEP36	2	1	4062	8206	172	459	296
42 x 108	42108ENDEP36	2	1	5386	9678	172	459	336
42 x 120	42120ENDEP36	2	1	5648	9940	172	459	356
42 x 144	42144ENDEP36	3	2	6269	11477	172	918	441
42 x 168	42168ENDEP36	3	2	8853	14763	172	918	475
42 x 192	42192ENDEP36	3	2	9276	17248	172	918	551
42 x 216	42216ENDEP36	3	2	10160	17355	172	918	590

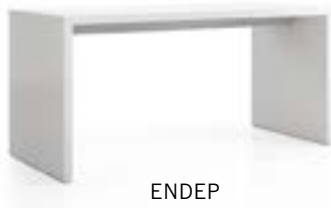

### STANDARD FEATURES

- 2" built up edge
- Specify Self edge (SE) or 2mm Edge (2MM)
- 36" height
- Undersurface Support Trough
- Recessed Glides
- Ships Knocked Down

### OPTIONS

- 2mm Bio edge available in 38 solid colors
- 2mm PVC edge available in wood grain to match 7 standard stains
- Specify power modules for EndZone. Power Access Door and Cove power available, see the end of EndZone tables section
- Rectangular Vertical Wire Manager
- For Solid Core laminate, call factory for pricing
- Foot Rest only available in chrome
- For two different laminate colors, call factory for pricing

### HOW TO ORDER

1. Select Size
2. Select Base Style
3. Select Edge Style
4. Select Top Finish
5. Select Edge Finish
6. Select Base Finish
7. Select Metal Finish

**Example:** 3072- ENDEP - 30 - 2MM -





# ENDZONE WITH 2" END PANELS

## 42" HIGH TABLE

BACK TO CONTENTS

SIZE	MODEL			LIST		OPTIONS		LBS
Depth x Length	Code	# Legs	# Top Sections	Laminate SE 2MM	Veneer SE 2MM	VERTICAL WIRE MGR (EACH) <i>Add</i>	FOOT REST (PER SIDE) <i>Add</i>	
<b>24" DEPTH</b>								
24 x 72	2472ENDEP42	2	1	3002	4544	172	459	171
24 x 84	2484ENDEP42	2	1	3189	4910	172	459	183
24 x 96	2496ENDEP42	2	1	3268	5290	172	459	196
24 x 108	24108ENDEP42	2	1	4705	6903	172	459	232
24 x 120	24120ENDEP42	2	1	4967	7165	172	459	247
24 x 144	24144ENDEP42	3	2	5142	8141	172	918	291
24 x 168	24168ENDEP42	3	2	7331	10690	172	918	315
24 x 192	24192ENDEP42	3	2	7687	11644	172	918	383
24 x 216	24216ENDEP42	3	2	8797	12694	172	918	414
<b>30" DEPTH</b>								
30 x 72	3072ENDEP42	2	1	3158	5022	172	459	203
30 x 84	3084ENDEP42	2	1	3470	5473	172	459	217
30 x 96	3096ENDEP42	2	1	3546	5933	172	459	231
30 x 108	30108ENDEP42	2	1	4848	7614	172	459	270
30 x 120	30120ENDEP42	2	1	5110	7876	172	459	287
30 x 144	30144ENDEP42	3	2	5453	9097	172	918	344
30 x 168	30168ENDEP42	3	2	7894	11814	172	918	372
30 x 192	30192ENDEP42	3	2	8243	12933	172	918	444
30 x 216	30216ENDEP42	3	2	9084	14128	172	918	477



### STANDARD FEATURES

- 2" built up edge
- Specify Self edge (SE) or 2mm Edge (2MM)
- 42" height
- Undersurface Support Trough
- Recessed Glides
- Ships Knocked Down

### OPTIONS

- 2mm Bio edge available in 38 solid colors
- 2mm PVC edge available in wood grain to match 7 standard stains
- Specify power modules for EndZone. Power Access Door and Cove power available, see the end of EndZone tables section
- Rectangular Vertical Wire Manager
- For Solid Core laminate, call factory for pricing
- Foot Rest only available in chrome
- For two different laminate colors, call factory for pricing

### HOW TO ORDER

1. Select Size
2. Select Base Style
3. Select Edge Style
4. Select Top Finish
5. Select Edge Finish
6. Select Base Finish
7. Select Metal Finish

**Example:** 3072- ENDEP - 30 - 2MM -





# ENDZONE WITH 2" END PANELS

## 42" HIGH TABLE

BACK TO CONTENTS



SIZE	MODEL			LIST		OPTIONS		LBS
Depth x Length	Code	# Legs	# Top Sections	Laminate SE 2MM	Veneer SE 2MM	VERTICAL WIRE MGR (EACH) Add	FOOT REST (PER SIDE) Add	
<b>36" DEPTH</b>								
36 x 72	3672ENDEP42	2	1	3227	5840	172	459	236
36 x 84	3684ENDEP42	2	1	3668	6505	172	459	252
36 x 96	3696ENDEP42	2	1	3725	7029	172	459	267
36 x 108	36108ENDEP42	2	1	4953	8403	172	459	307
36 x 120	36120ENDEP42	2	1	5215	9143	172	459	326
36 x 144	36144ENDEP42	3	2	5591	10503	172	918	398
36 x 168	36168ENDEP42	3	2	8290	13651	172	918	430
36 x 192	36192ENDEP42	3	2	8602	14895	172	918	504
36 x 216	36216ENDEP42	3	2	9263	15894	172	918	541
<b>42" DEPTH</b>								
42 x 72	4272ENDEP42	2	1	3566	6327	172	459	268
42 x 84	4284ENDEP42	2	1	3950	7061	172	459	286
42 x 96	4296ENDEP42	2	1	4062	8206	172	459	303
42 x 108	42108ENDEP42	2	1	5386	9678	172	459	345
42 x 120	42120ENDEP42	2	1	5648	9940	172	459	365
42 x 144	42144ENDEP42	3	2	6269	11477	172	918	452
42 x 168	42168ENDEP42	3	2	8853	14763	172	918	487
42 x 192	42192ENDEP42	3	2	9276	17248	172	918	565
42 x 216	42216ENDEP42	3	2	10160	17355	172	918	605



### STANDARD FEATURES

- 2" built up edge
- Specify Self edge (SE) or 2mm Edge (2MM)
- 42" height
- Undersurface Support Trough
- Recessed Glides
- Ships Knocked Down

### OPTIONS

- 2mm Bio edge available in 38 solid colors
- 2mm PVC edge available in wood grain to match 7 standard stains
- Specify power modules for EndZone. Power Access Door and Cove power available, see the end of EndZone tables section
- Rectangular Vertical Wire Manager
- Solid Core laminate, call factory for pricing
- Foot Rest only available in chrome
- For two different laminate colors, call factory for pricing

### HOW TO ORDER

1. Select Size
2. Select Base Style
3. Select Edge Style
4. Select Top Finish
5. Select Edge Finish
6. Select Base Finish
7. Select Metal Finish

**Example:** 3072- ENDEP - 30 - 2MM -  
 DEPTH x LENGTH | BASE | HEIGHT | EDGE





# ENDZONE WITH 8" PLINTH BASES

## 30" HIGH TABLE

BACK TO CONTENTS

SIZE	MODEL			FINISH		OPTIONS	LBS
Depth x Length	Code	# Legs	# Top Sections	Laminate SE 2MM	Veneer SE 2MM	FOOT REST (PER SIDE) <i>Add</i>	
<b>24" DEPTH</b>							
24 x 72	2472ENDPL30	2	1	2974	4666	459	176
24 x 84	2484ENDPL30	2	1	3161	5032	459	187
24 x 96	2496ENDPL30	2	1	3240	5412	459	199
24 x 108	24108ENDPL30	2	1	4677	7025	459	234
24 x 120	24120ENDPL30	2	1	4939	7287	459	249
24 x 144	24144ENDPL30	3	2	5100	8324	918	296
24 x 168	24168ENDPL30	3	2	7289	10873	918	320
24 x 192	24192ENDPL30	3	2	7645	11827	918	385
24 x 216	24216ENDPL30	3	2	8755	12877	918	413
<b>30" DEPTH</b>							
30 x 72	3072ENDPL30	2	1	3130	5144	459	210
30 x 84	3084ENDPL30	2	1	3442	5595	459	223
30 x 96	3096ENDPL30	2	1	3518	6055	459	237
30 x 108	30108ENDPL30	2	1	4820	7736	459	273
30 x 120	30120ENDPL30	2	1	5082	7998	459	289
30 x 144	30144ENDPL30	3	2	5411	9280	918	352
30 x 168	30168ENDPL30	3	2	7852	11997	918	379
30 x 192	30192ENDPL30	3	2	8201	13116	918	447
30 x 216	30216ENDPL30	3	2	9042	14311	918	479



### STANDARD FEATURES

- 2" built up edge
- Specify Self edge (SE) or 2mm Edge (2MM)
- 30" height
- Undersurface Support Trough
- Recessed Glides
- Ships Knocked Down

### OPTIONS

- 2mm Bio edge available in 38 solid colors
- 2mm PVC edge available in wood grain to match 7 standard stains
- Specify power modules for EndZone. Power Access Door and Cove power available, see the end of EndZone tables section
- For Solid Core laminate, call factory for pricing
- Foot Rest only available in chrome
- For two different laminate colors, call factory for pricing

### HOW TO ORDER

1. Select Size
2. Select Base Style
3. Select Edge Style
4. Select Top Finish
5. Select Edge Finish
6. Select Base Finish
7. Select Metal Finish

**Example:** 3072- ENDEP - 30 - 2MM -





# ENDZONE WITH 8" PLINTH BASES

## 30" HIGH TABLE

BACK TO CONTENTS



SIZE	MODEL			FINISH		OPTIONS	LBS
Depth x Length	Code	# Legs	# Top Sections	Laminate SE 2MM	Veneer SE 2MM	FOOT REST (PER SIDE) <i>Add</i>	
<b>36" DEPTH</b>							
36 x 72	3672ENDPL30	2	1	3199	6030	459	244
36 x 84	3684ENDPL30	2	1	3640	6695	459	259
36 x 96	3696ENDPL30	2	1	3697	7219	459	274
36 x 108	36108ENDPL30	2	1	4925	8593	459	312
36 x 120	36120ENDPL30	2	1	5187	9333	459	330
36 x 144	36144ENDPL30	3	2	5549	10788	918	408
36 x 168	36168ENDPL30	3	2	8248	13936	918	438
36 x 192	36192ENDPL30	3	2	8560	15180	918	509
36 x 216	36216ENDPL30	3	2	9221	16179	918	544
<b>42" DEPTH</b>							
42 x 72	4272ENDPL30	2	1	3538	6517	459	278
42 x 84	4284ENDPL30	2	1	3922	7251	459	295
42 x 96	4296ENDPL30	2	1	4034	8396	459	311
42 x 108	42108ENDPL30	2	1	5358	9868	459	351
42 x 120	42120ENDPL30	2	1	5620	10130	459	370
42 x 144	42144ENDPL30	3	2	6227	11762	918	464
42 x 168	42168ENDPL30	3	2	8811	15048	918	497
42 x 192	42192ENDPL30	3	2	9234	17533	918	572
42 x 216	42216ENDPL30	3	2	10118	17640	918	610



On tables with 3 legs, center leg is 18" Deep

### STANDARD FEATURES

- 2" built up edge
- Specify Self edge (SE) or 2mm Edge (2MM)
- 30" height
- Undersurface Support Trough
- Recessed Glides
- Ships Knocked Down

### OPTIONS

- 2mm Bio edge available in 38 solid colors
- 2mm PVC edge available in wood grain to match 7 standard stains
- Specify power modules for EndZone. Power Access Door and Cove power available, see the end of EndZone tables section
- For Solid Core laminate, call factory for pricing
- Foot Rest only available in chrome
- For two different laminate colors, call factory for pricing

### HOW TO ORDER

1. Select Size
2. Select Base Style
3. Select Edge Style
4. Select Top Finish
5. Select Edge Finish
6. Select Base Finish
7. Select Metal Finish

**Example:** 3072- ENDEP - 30 - 2MM -





# ENDZONE WITH 8" PLINTH BASES

## 36" HIGH TABLE

BACK TO CONTENTS

SIZE <i>Depth x Length</i>	MODEL			FINISH		OPTIONS	LBS
	<i>Code</i>	<i># Legs</i>	<i># Top Sections</i>	<i>Laminate SE 2MM</i>	<i>Veneer SE 2MM</i>	<b>FOOT REST (PER SIDE)</b> <i>Add</i>	
<b>24" DEPTH</b>							
24 x 72	2472ENDPL36	2	1	3138	4830	459	180
24 x 84	2484ENDPL36	2	1	3325	5196	459	192
24 x 96	2496ENDPL36	2	1	3404	5576	459	204
24 x 108	24108ENDPL36	2	1	4841	7189	459	240
24 x 120	24120ENDPL36	2	1	5103	7451	459	255
24 x 144	24144ENDPL36	3	2	5346	8570	918	304
24 x 168	24168ENDPL36	3	2	7535	11119	918	328
24 x 192	24192ENDPL36	3	2	7891	12073	918	394
24 x 216	24216ENDPL36	3	2	9001	13123	918	424
<b>30" DEPTH</b>							
30 x 72	3072ENDPL36	2	1	3294	5308	459	215
30 x 84	3084ENDPL36	2	1	3606	5759	459	229
30 x 96	3096ENDPL36	2	1	3682	6219	459	242
30 x 108	30108ENDPL36	2	1	4984	7900	459	280
30 x 120	30120ENDPL36	2	1	5246	8162	459	296
30 x 144	30144ENDPL36	3	2	5657	9526	918	361
30 x 168	30168ENDPL36	3	2	8098	12243	918	388
30 x 192	30192ENDPL36	3	2	8447	13362	918	458
30 x 216	30216ENDPL36	3	2	9288	14557	918	491



### STANDARD FEATURES

- 2" built up edge
- Specify Self edge (SE) or 2mm Edge (2MM)
- 36" height
- Undersurface Support Trough
- Recessed Glides
- Ships Knocked Down

### OPTIONS

- 2mm Bio edge available in 38 solid colors
- 2mm PVC edge available in wood grain to match 7 standard stains
- Specify power modules for EndZone. Power Access Door and Cove power available, see the end of EndZone tables section
- For Solid Core laminate, call factory for pricing
- Foot Rest only available in chrome
- For two different laminate colors, call factory for pricing

### HOW TO ORDER

1. Select Size
2. Select Base Style
3. Select Edge Style
4. Select Top Finish
5. Select Edge Finish
6. Select Base Finish
7. Select Metal Finish

**Example:** 3072- ENDEP - 30 - 2MM -  
 DEPTH x LENGTH      BASE      HEIGHT      EDGE



# ENDZONE WITH 8" PLINTH BASES

## 36" HIGH TABLE

BACK TO CONTENTS



SIZE	MODEL			FINISH		OPTIONS	LBS
Depth x Length	Code	# Legs	# Top Sections	Laminate SE 2MM	Veneer SE 2MM	FOOT REST (PER SIDE) <i>Add</i>	
<b>36" DEPTH</b>							
36 x 72	3672ENDPL36	2	1	3363	6194	459	250
36 x 84	3684ENDPL36	2	1	3804	6859	459	265
36 x 96	3696ENDPL36	2	1	3861	7383	459	281
36 x 108	36108ENDPL36	2	1	5089	8757	459	320
36 x 120	36120ENDPL36	2	1	5351	9497	459	338
36 x 144	36144ENDPL36	3	2	5795	11034	918	418
36 x 168	36168ENDPL36	3	2	8494	14182	918	449
36 x 192	36192ENDPL36	3	2	8806	15426	918	522
36 x 216	36216ENDPL36	3	2	9467	16425	918	558
<b>42" DEPTH</b>							
42 x 72	4272ENDPL36	2	1	3702	6681	459	285
42 x 84	4284ENDPL36	2	1	4086	7415	459	302
42 x 96	4296ENDPL36	2	1	4198	8560	459	319
42 x 108	42108ENDPL36	2	1	5522	10032	459	360
42 x 120	42120ENDPL36	2	1	5784	10294	459	379
42 x 144	42144ENDPL36	3	2	6473	12008	918	476
42 x 168	42168ENDPL36	3	2	9057	15294	918	509
42 x 192	42192ENDPL36	3	2	9480	17779	918	586
42 x 216	42216ENDPL36	3	2	10364	17886	918	625



### STANDARD FEATURES

- 2" built up edge
- Specify Self edge (SE) or 2mm Edge (2MM)
- 36" height
- Undersurface Support Trough
- Recessed Glides
- Ships Knocked Down

### OPTIONS

- 2mm Bio edge available in 38 solid colors
- 2mm PVC edge available in wood grain to match 7 standard stains
- Specify power modules for EndZone. Power Access Door and Cove power available, see the end of EndZone tables section
- For Solid Core laminate, call factory for pricing
- Foot Rest only available in chrome
- For two different laminate colors, call factory for pricing

### HOW TO ORDER

1. Select Size
2. Select Base Style
3. Select Edge Style
4. Select Top Finish
5. Select Edge Finish
6. Select Base Finish
7. Select Metal Finish

**Example:** 3072- ENDEP - 30 - 2MM -  
 DEPTH x LENGTH BASE HEIGHT EDGE



# ENDZONE WITH 8" PLINTH BASES

## 42" HIGH TABLE

BACK TO CONTENTS

SIZE	MODEL			FINISH		OPTIONS	LBS
<i>Depth x Length</i>	<i>Code</i>	<i># Legs</i>	<i># Top Sections</i>	<i>Laminate</i>	<i>Veneer</i>	<b>FOOT REST (PER SIDE)</b>	
				<b>SE</b>	<b>SE</b>	<i>Add</i>	
				<b>2MM</b>	<b>2MM</b>		
<b>24" DEPTH</b>							
24 x 72	2472ENDPL42	2	1	3138	4830	459	184
24 x 84	2484ENDPL42	2	1	3325	5196	459	197
24 x 96	2496ENDPL42	2	1	3404	5576	459	209
24 x 108	24108ENDPL42	2	1	4841	7189	459	246
24 x 120	24120ENDPL42	2	1	5103	7451	459	261
24 x 144	24144ENDPL42	3	2	5346	8570	918	311
24 x 168	24168ENDPL42	3	2	7535	11119	918	336
24 x 192	24192ENDPL42	3	2	7891	12073	918	404
24 x 216	24216ENDPL42	3	2	9001	13123	918	434
<b>30" DEPTH</b>							
30 x 72	3072ENDPL42	2	1	3294	5308	459	220
30 x 84	3084ENDPL42	2	1	3606	5759	459	234
30 x 96	3096ENDPL42	2	1	3682	6219	459	248
30 x 108	30108ENDPL42	2	1	4984	7900	459	287
30 x 120	30120ENDPL42	2	1	5246	8162	459	304
30 x 144	30144ENDPL42	3	2	5657	9526	918	370
30 x 168	30168ENDPL42	3	2	8098	12243	918	398
30 x 192	30192ENDPL42	3	2	8447	13362	918	469
30 x 216	30216ENDPL42	3	2	9288	14557	918	503



ENDPL



On tables with 3 legs, center leg is 18" Deep

### STANDARD FEATURES

- 2" built up edge
- Specify Self edge (SE) or 2mm Edge (2MM)
- 42" height
- Undersurface Support Trough
- Recessed Glides
- Ships Knocked Down

### OPTIONS

- 2mm Bio edge available in 38 solid colors
- 2mm PVC edge available in wood grain to match 7 standard stains
- Specify power modules for EndZone. Power Access Door and Cove power available, see the end of EndZone tables section
- For Solid Core laminate, call factory for pricing
- Foot Rest only available in chrome
- For two different laminate colors, call factory for pricing

### HOW TO ORDER

1. Select Size
2. Select Base Style
3. Select Edge Style
4. Select Top Finish
5. Select Edge Finish
6. Select Base Finish
7. Select Metal Finish

**Example:** 3072- ENDEP - 30 - 2MM -





# ENDZONE WITH 8" PLINTH BASES

## 42" HIGH TABLE

BACK TO CONTENTS



SIZE <i>Depth x Length</i>	MODEL			FINISH		OPTIONS	LBS
	<i>Code</i>	<i># Legs</i>	<i># Top Sections</i>	<i>Laminate SE 2MM</i>	<i>Veneer SE 2MM</i>	<b>FOOT REST (PER SIDE)</b> <i>Add</i>	
<i>36" DEPTH</i>							
36 x 72	3672ENDPL42	2	1	3363	6194	459	256
36 x 84	3684ENDPL42	2	1	3804	6859	459	272
36 x 96	3696ENDPL42	2	1	3861	7383	459	288
36 x 108	36108ENDPL42	2	1	5089	8757	459	328
36 x 120	36120ENDPL42	2	1	5351	9497	459	346
36 x 144	36144ENDPL42	3	2	5795	11034	918	429
36 x 168	36168ENDPL42	3	2	8494	14182	918	460
36 x 192	36192ENDPL42	3	2	8806	15426	918	535
36 x 216	36216ENDPL42	3	2	9467	16425	918	572
<i>42" DEPTH</i>							
42 x 72	4272ENDPL42	2	1	3702	6681	459	292
42 x 84	4284ENDPL42	2	1	4086	7415	459	310
42 x 96	4296ENDPL42	2	1	4198	8560	459	327
42 x 108	42108ENDPL42	2	1	5522	10032	459	369
42 x 120	42120ENDPL42	2	1	5784	10294	459	389
42 x 144	42144ENDPL42	3	2	6473	12008	918	487
42 x 168	42168ENDPL42	3	2	9057	15294	918	522
42 x 192	42192ENDPL42	3	2	9480	17779	918	600
42 x 216	42216ENDPL42	3	2	10364	17886	918	640



ENDPL



On tables with 3 legs, center leg is 18" Deep

### STANDARD FEATURES

- 2" built up edge
- Specify Self edge (SE) or 2mm Edge (2MM)
- 42" height
- Undersurface Support Trough
- Recessed Glides
- Ships Knocked Down

### OPTIONS

- 2mm Bio edge available in 38 solid colors
- 2mm PVC edge available in wood grain to match 7 standard stains
- Specify power modules for EndZone. Power Access Door and Cove power available, see the end of EndZone tables section
- For Solid Core laminate, call factory for pricing
- Foot Rest only available in chrome
- For two different laminate colors, call factory for pricing

### HOW TO ORDER

1. Select Size
2. Select Base Style
3. Select Edge Style
4. Select Top Finish
5. Select Edge Finish
6. Select Base Finish
7. Select Metal Finish

**Example:** 3072- ENDEP - 30 - 2MM -



# ENDZONE

## POWER & COMMUNICATION

### Cove Power Modules

	MODEL	DESCRIPTION	LIST	
	<b>COVC2P2U-B</b>	<b>Cove, Clamp Mounted</b> Cove, 2 power, 2USB, <b>Black</b>	386	
	<b>COVC2P2U-S</b>	Cove, 2 power, 2USB, <b>Silver Pearl</b>	386	
	<b>COVC2P2U-W</b>	Cove, 2 power, 2USB, <b>Gloss White</b>	386	
<p><i>Cord is 108". USB is for charging only.</i></p>				

Cove Power Module comes standard with 2 power and 2 USB. USB is for charging only. Choose from Black, Silver Pearl or Gloss White.

### Power Access Door

TOP LENGTH	MODEL	DESCRIPTION	LIST	
<i>Table Top Length</i>		<i># of doors</i> <i>Length of Door(s)</i>	<i>Upcharge per table</i>	
72"	AD40	1      40"	519	
84"	AD52	1      52"	653	
96"	AD76	1      76"	693	
108"	-	-      -	-	
120"	-	-      -	-	
144"	AD40-2	2      40"	1038	
168"	AD76-2	2      52"	1306	
192"	-	-      -	-	
216"	-	-      -	-	

### Number of Duplexes and Data & Communication Cutouts

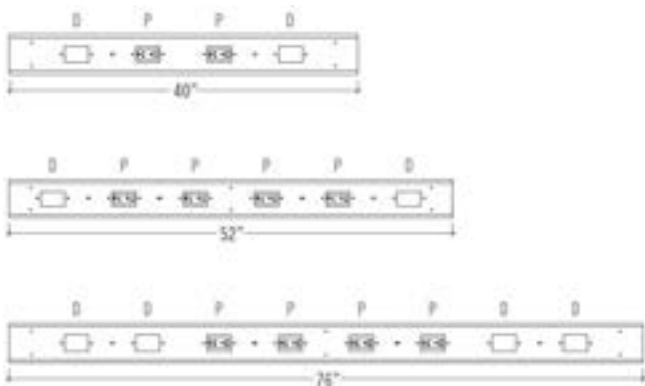

EndZone Power Access Door comes standard with 2 or 4 Duplexes (depending on size of table) and 2 communication cutouts. Specify data separately.

**Example:** 3072- ENDEP - 30 - 2MM -  
 DEPTH x LENGTH      BASE      HEIGHT      EDGE

# FITT TABLES



PLACING AN ORDER IS EASY

## PRODUCT CODE

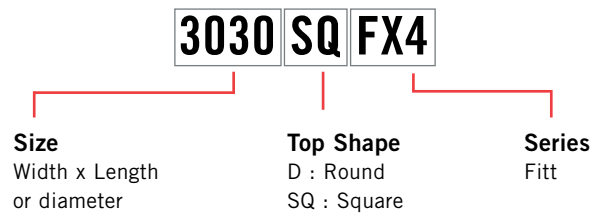

## OPTIONS

### CASTERS



### CAFE HEIGHT



## FINISHES

### LAMINATE



Select laminate from our virtually unlimited laminate options

### VENEER

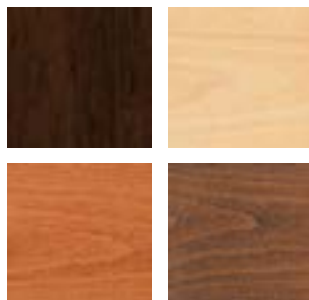

Select from one of our 7 standard wood stains or stain-to-match at no upcharge

### BASE



Select from one of our 76 standard Spectone colors

### EDGE



2MM

PVC

Check out our website for a complete list of edge profiles.





# FITT 10 DAY TABLES PROGRAM



BACK TO CONTENTS



MODEL	BASES		TOP SPECIFICATIONS For Laminate Top PVF	OPTIONS				LBS
	Code	Qty.		FLIP TOP (FL)	FOLD (F)	CASTERS (LC)	WHEELS (WB)	
<i>Round</i>								
30D	FX4	1	551	-	-	84	-	38
36D	FX4	1	628	-	-	84	-	46
42D	FX4	1	678	-	-	84	-	56
48D	FX4	1	819	-	-	84	-	85
54D	FX4	1	882	-	-	84	-	98
60D	FX4	1	950	-	-	84	-	113
<i>Square</i>								
30 x 30SQ	FX4	1	582	-	-	84	-	38
36 x 36SQ	FX4	1	634	-	-	84	-	46
42 x 42SQ	FX4	1	770	-	-	84	-	73
48 x 48SQ	FX4	1	824	-	-	84	-	85
54 x 54SQ	FX4	1	888	-	-	84	-	98
60 x 60SQ	FX4	1	957	-	-	84	-	113



42D-FX4

### 10 DAY EDGE AND FRAME CHOICES

- Nickel or black flat PVC edge
- Nickel or black textured base finishes

### 10 DAY TOP FINISH CHOICES

For images of all current 10 Day laminates, visit [www.specfurniture.com](http://www.specfurniture.com) and go to Fabrics/Finishes.

### 10 DAY NOTES AND OPTIONS

- Quantity limits may apply. 10 Folding, 20 in total.

### STANDARD FEATURES

- Fitt is a lightweight multiuse table designed for light use contract applications.
- Tops are constructed from 0.75" particle board core with laminate surface and backer.
- Standard table height is 29".
- All bases are standard with floor leveling glides.
- Base span increases with size of top.
- Casters are not self-leveling.

### OPTIONS

- 2" grommet and oval grommet.

### HOW TO ORDER

1. Select Model
2. Select Base
3. Select Edge Style
4. Select Options
5. Select Top Finish
6. Select Edge Finish
7. Select Base Finish

Example: 30D - FX4 - PVC -





# FITT GENERAL PURPOSE TABLES

MODEL	BASES		TOP SPECIFICATIONS	OPTIONS				LBS
	Code	Qty.		FLIP TOP (FL)	FOLD (F)	CASTERS (LC)	WHEELS (WB)	
			<i>For Laminate Top</i>					
			PVF 2MM SE					
<i>Round</i>								
30D	FX4	1	551	-	-	84	-	38
	FX4 CAFE HEIGHT	1	616	-	-	-	-	40
36D	FX4	1	628	-	-	84	-	46
	FX4 CAFE HEIGHT	1	693	-	-	-	-	48
42D	FX4	1	678	-	-	84	-	56
	FX4 CAFE HEIGHT	1	743	-	-	-	-	58
48D	FX4	1	819	-	-	84	-	85
54D	FX4	1	882	-	-	84	-	98
60D	FX4	1	950	-	-	84	-	113
<i>Square</i>								
30 x 30SQ	FX4	1	582	-	-	84	-	38
	FX4 CAFE HEIGHT	1	647	-	-	-	-	40
36 x 36SQ	FX4	1	634	-	-	84	-	46
	FX4 CAFE HEIGHT	1	699	-	-	-	-	48
42 x 42SQ	FX4	1	770	-	-	84	-	73
48 x 48SQ	FX4	1	824	-	-	84	-	85
54 x 54SQ	FX4	1	888	-	-	84	-	98
60 x 60SQ	FX4	1	957	-	-	84	-	113



42D-FX4



30D-FX4 CAFE HEIGHT

### STANDARD FEATURES

- Fitt is a lightweight multiuse table designed for light use contract applications.
- Tops are constructed from 0.75" particle board core with laminate surface and backer.
- Laminate tops available in any standard Wilsonart, Nevamar, Formica, Arborite or Pionite matte finish offerings. For other laminate please contact the factory for pricing.
- Standard table height is 29". Cafe height is 39".
- Base available in any Spectone color.
- All bases are standard with floor leveling glides.
- Base span increases with size of top.
- Casters are not self-leveling.

### OPTIONS

- Table cart available. Holds 4 to 6 tables.
- Mesh modesty in nickel or black.
- Seam connectors to join and level tops.
- 2" grommet and oval grommet.

### HOW TO ORDER

1. Select Model
2. Select Base
3. Select Edge Style
4. Select Options
5. Select Top Finish
6. Select Edge Finish
7. Select Base Finish

Example: 30D - FX4 - PVC -



# HALF ROUND TABLES



PLACING AN ORDER IS EASY

## PRODUCT CODE

**2430 RE X HR**

**Size**  
Width x Length

**Top Shape**  
D : Round  
SQ : Square  
RE : Rectangle  
RT : Racetrack  
B : Bullet  
H : Halfmoon  
TP : Trapezoid

**Base**  
C90 : Radius (*connector*)  
CRC90 : Crescent  
BT : Boatshape  
BTA : Boatshape Arc

X : X-Base  
X4 : 4 Column X-Base  
T : T-Base  
T2 : Double Column T-Base

**Series**  
Half Round

## OPTIONS

**FLIP TOP**



**CASTERS**



**FOLDING**



## FINISHES

**LAMINATE**



Select laminate from our virtually unlimited laminate options

**VENEER**

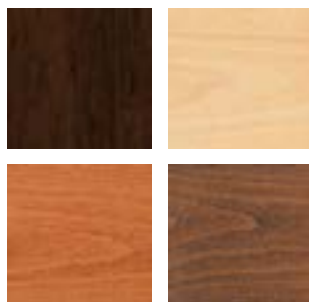

Select from one of our 7 standard wood stains or stain-to-match at no upcharge

**BASE**



Select from one of our 76 standard Spectone colors

**EDGE**



2MM

PVC

Hard Wood

Check out our website for a complete list of edge profiles.



# HALF ROUND GENERAL PURPOSE TABLES

BACK TO CONTENTS



MODEL	BASES		TOP SPECIFICATIONS						OPTIONS				LBS
	Code	Qty.	For Laminate Top			For Veneer Top			FLIP TOP (FT)	FOLD (FL)	CASTERS (LC)	WHEELS (WB)	
			SE PVF PVB 2MM	HF HB	HBV HBVR HBG	HF2 HB2 HKNR4 HBG2	HF HB HBV HBG	HF2 HB2 HKNR4 HBG2					
<i>Round</i>													
24D	XHR	1	624	953	987	1087	1140	1243	141	-	84	-	47
30D	XHR	1	719	1043	1087	1286	1235	1386	141	-	84	-	57
36D	XHR	1	809	1280	1362	1525	1575	1784	141	-	84	-	68
42D	XHR	1	1070	1597	1711	1953	1978	2264	141	-	84	-	82
	X4HR	1	1330	1857	1971	2213	2238	2524	-	-	84	-	94
48D	XHR	1	1091	1799	1923	2043	2477	2845	141	-	84	-	98
	X4HR	1	1351	2059	2183	2303	2737	3105	-	-	84	-	110
54D	X4HR	1	1617	2660	2852	3036	3252	3724	-	-	-	-	128
60D	X4HR	1	1660	2845	3050	3205	3833	4420	-	-	-	-	147
<i>Square</i>													
24 x 24SQ	XHR	1	652	831	865	927	972	1126	141	-	84	-	47
30 x 30SQ	XHR	1	750	880	927	1091	1032	1243	141	-	84	-	57
36 x 36SQ	XHR	1	827	1031	1087	1280	1286	1470	141	-	84	-	68
42 x 42SQ	XHR	1	1224	1519	1610	1701	1764	2015	282	-	-	-	82
	X4HR	1	1344	1639	1730	1821	1884	2135	-	-	84	-	94
48 x 48SQ	X4HR	1	1485	1744	1840	1882	2229	2551	-	-	84	-	110
54 x 54SQ	X4HR	1	1619	2191	2341	2515	2610	3028	-	-	-	-	128
60 x 60SQ	X4HR	1	1647	2288	2447	2623	3048	3554	-	-	-	-	147



30D-XHR

42D-X4HR

### STANDARD FEATURES

- Laminate tops available in any standard Wilsonart, Nevamar, Formica, Arborite or Pionite matte finish offerings. For other laminate please contact the factory for pricing.
- Veneers and hardwood edges are standard in Oak, Chocolate, Maple, Cherry, Pecan, Walnut, Mahogany
- 7 veneer and hardwood edge stains are standard. Stain-to-match available at no upcharge.
- Standard table height 29".
- All bases are standard with floor leveling glides.

### OPTIONS

- Custom heights available.
- Two tone base available, add \$84 List per base.

### HOW TO ORDER

- Select Model
- Select Base
- Select Edge Style
- Select Options
- Select Top Finish
- Select Edge Finish
- Select Base Finish

Example: 24D - XHR - PVF -





# HALF ROUND GENERAL PURPOSE TABLES

BACK TO CONTENTS



MODEL	BASES		TOP SPECIFICATIONS						OPTIONS				LBS
	Code	Qty.	For Laminate Top			For Veneer Top			FLIP TOP (FT)	FOLD (FL)	CASTERS (LC)	WHEELS (WB)	
			SE PVF PVB 2MM	HF HB	HBV HBVR HBG	HF2 HB2 HKN4 HKNR4 HBG2	HF HB HBV HBG	HF2 HB2 HKN4 HKNR4 HBG2					
<i>Rectangle</i>													
24 x 30RE	XHR	1	739	861	905	968	1017	1136	141	-	-	-	56
	THR	2	841	963	1007	1070	1119	1238	282	-	84	84	58
24 x 36RE	XHR	1	739	861	905	968	1017	1136	141	-	-	-	56
	THR	2	841	963	1007	1070	1119	1238	282	-	84	84	58
24 x 42RE	THR	2	902	1098	1149	1241	1297	1463	282	-	84	84	66
24 x 48RE	THR	2	902	1098	1149	1241	1297	1463	282	-	84	84	66
24 x 54RE	THR	2	957	1243	1308	1414	1493	1696	282	-	84	84	74
24 x 60RE	THR	2	957	1243	1308	1414	1493	1696	282	272	84	84	74
24 x 66RE	THR	2	1093	1437	1517	1646	1730	1979	282	272	84	84	83
24 x 72RE	THR	2	1093	1437	1517	1646	1730	1979	282	272	84	84	83
30 x 36RE	XHR	1	827	968	1018	1098	1156	1300	141	-	-	-	62
	THR	2	929	1070	1120	1200	1258	1402	282	-	84	84	64
30 x 42RE	XHR	1	846	1115	1177	1283	1361	1563	141	-	-	-	72
	THR	2	948	1217	1279	1385	1463	1665	282	-	84	84	74
30 x 48RE	XHR	1	846	1115	1177	1283	1361	1563	141	-	-	-	72
	THR	2	948	1217	1279	1385	1463	1665	282	-	84	84	74
30 x 54RE	THR	2	1003	1370	1450	1601	1691	1944	282	-	84	84	85
30 x 60RE	THR	2	1003	1370	1450	1601	1691	1944	282	272	84	84	85
30 x 66RE	THR	2	1166	1462	1559	1713	1800	2080	282	272	84	84	95
30 x 72RE	THR	2	1218	1605	1703	1901	2004	2311	282	272	84	84	95

\*Folding tables available with PVC Bullnose edge only



30D-XHR



2448RE-THR

### STANDARD FEATURES

- Laminate tops available in any standard Wilsonart, Nevamar, Formica, Arborite or Pionite matte finish offerings. For other laminate please contact the factory for pricing.
- Veneers and hardwood edges are standard in Oak, Chocolate, Maple, Cherry, Pecan, Walnut, Mahogany.
- 7 veneer and hardwood edge stains are standard. Stain-to-match available at no upcharge.
- Standard table height 29".
- All bases are standard with floor leveling glides.

### OPTIONS

- Custom heights available.
- Two tone base available, add \$84 List per base.

### HOW TO ORDER

1. Select Model
2. Select Base
3. Select Edge Style
4. Select Options
5. Select Top Finish
6. Select Edge Finish
7. Select Base Finish

Example: 2430RE - XHR - PVF -





# HALF ROUND GENERAL PURPOSE TABLES

BACK TO CONTENTS



MODEL	BASES		TOP SPECIFICATIONS						OPTIONS				LBS
	Code	Qty.	For Laminate Top			For Veneer Top			FLIP TOP (FT)	FOLD (FL)	CASTERS (LC)	WHEELS (WB)	
			SE PVF PVB 2MM	HF HB	HBV HBVR HBG	HF2 HB2 HKNR4 HBG2	HF HB HBV HBG	HF2 HB2 HKNR4 HBG2					
<i>Rectangle</i>													
30 x 78RE	THR	2	1428	1770	1886	2116	2237	2590	282	272	84	-	106
30 x 84RE	THR	2	1428	1770	1886	2116	2237	2590	282	272	84	-	106
30 x 90RE	THR	2	1447	1977	2116	2329	2472	2874	-	272	84	84	116
30 x 96RE	THR	2	1447	1977	2116	2329	2472	2874	-	272	84	84	116
36 x 42RE	THR	2	1041	1243	1321	1427	1508	1720	282	-	84	84	83
36 x 48RE	THR	2	1065	1350	1433	1559	1643	1890	282	-	84	84	83
36 x 60RE	THR	2	1155	1552	1653	1814	1916	2225	282	272	84	84	95
36 x 66RE	THR	2	1237	1649	1765	1942	2053	2393	282	272	84	84	108
	T2HR	2	1473	1885	2001	2178	2289	2629	-	547	84	-	134
36 x 72RE	THR	2	1273	1703	1814	2070	2193	2561	282	272	84	84	108
	T2HR	2	1509	1939	2050	2306	2429	2797	-	547	84	-	134
36 x 78RE	THR	2	1586	2046	2190	2412	2557	2990	-	272	84	84	121
	T2HR	2	1822	2282	2426	2648	2793	3226	-	547	84	-	147
36 x 84RE	THR	2	1586	2046	2190	2412	2557	2990	-	272	84	84	121
	T2HR	2	1822	2282	2426	2648	2793	3226	-	547	84	-	147
36 x 90RE	THR	2	1591	2247	2412	2671	2837	3318	-	-	84	84	133
	T2HR	2	1827	2483	2648	2907	3073	3554	-	547	84	-	159
36 x 96RE	THR	2	1591	2247	2412	2671	2837	3318	-	-	84	84	133
	T2HR	2	1827	2483	2648	2907	3073	3554	-	547	84	-	159
42 x 78RE	T2HR	2	2048	2444	2602	2984	3110	3612	-	547	84	-	161
42 x 84RE	T2HR	2	2048	2444	2602	2984	3110	3612	-	547	84	-	161

\*Folding tables available with PVC Bullnose edge only



2448RE-THR

### STANDARD FEATURES

- Laminate tops available in any standard Wilsonart, Nevamar, Formica, Arborite or Pionite matte finish offerings. For other laminate please contact the factory for pricing.
- Veneers and hardwood edges are standard in Oak, Chocolate, Maple, Cherry, Pecan, Walnut, Mahogany.
- 7 veneer and hardwood edge stains are standard. Stain-to-match available at no upcharge.
- Standard table height 29".
- All bases are standard with floor leveling glides.

### OPTIONS

- Custom heights available.
- Two tone base available, add \$84 List per base.

### HOW TO ORDER

1. Select Model
2. Select Base
3. Select Edge Style
4. Select Options
5. Select Top Finish
6. Select Edge Finish
7. Select Base Finish

Example: 3078RE - THR - PVF -





# HALF ROUND GENERAL PURPOSE TABLES

BACK TO CONTENTS



MODEL	BASES		TOP SPECIFICATIONS						OPTIONS				LBS
	Code	Qty.	For Laminate Top			For Veneer Top			FLIP TOP (FT)	FOLD (FL)	CASTERS (LC)	WHEELS (WB)	
			SE PVF PVB 2MM	HF HB	HBV HBVR HBG	HF2 HB2 HKN4 HKNR4 HBG2	HF HB HBV HBG	HF2 HB2 HKN4 HKNR4 HBG2					
<i>Racetrack</i>													
36 x 54RT	THR	2	1207	1730	1852	2070	2159	2478	282	-	84	84	95
	T2HR	2	1443	1966	2088	2306	2395	2714	-	-	84	84	121
36 x 60RT	THR	2	1207	1730	1852	2070	2159	2478	282	-	84	84	95
	T2HR	2	1443	1966	2088	2306	2395	2714	-	-	84	84	121
36 x 66RT	THR	2	1355	1901	2033	2266	2472	2870	282	-	84	84	108
	T2HR	2	1591	2137	2269	2502	2708	3106	-	-	84	84	134
36 x 72RT	THR	2	1355	1901	2033	2266	2472	2870	282	-	84	84	108
	T2HR	2	1591	2137	2269	2502	2708	3106	-	-	84	84	134
36 x 78RT	THR	2	1601	2295	2457	2810	2884	3349	-	-	84	84	121
	T2HR	2	1837	2531	2693	3046	3120	3585	-	-	84	84	147
36 x 84RT	THR	2	1601	2295	2457	2810	2884	3349	-	-	84	84	121
	T2HR	2	1837	2531	2693	3046	3120	3585	-	-	84	84	147
36 x 90RT	THR	2	1605	2531	2724	3119	3211	3740	-	-	84	84	133
	T2HR	2	1841	2767	2960	3355	3447	3976	-	-	84	84	159
36 x 96RT	THR	2	1605	2531	2724	3119	3211	3740	-	-	84	84	133
	T2HR	2	1841	2767	2960	3355	3447	3976	-	-	84	84	159
42 x 78RT	T2HR	2	2062	2718	2917	3316	3412	3947	-	-	84	84	176
42 x 84RT	T2HR	2	2062	2718	2917	3316	3412	3947	-	-	84	84	176
48 x 78RT	T2HR	2	2065	3000	3225	3578	3799	4407	-	-	84	84	176
48 x 84RT	T2HR	2	2065	3000	3225	3578	3799	4407	-	-	84	84	176



2448RE-THR

### STANDARD FEATURES

- Laminate tops available in any standard Wilsonart, Nevamar, Formica, Arborite or Pionite matte finish offerings. For other laminate please contact the factory for pricing.
- Veneers and hardwood edges are standard in Oak, Chocolate, Maple, Cherry, Pecan, Walnut, Mahogany.
- 7 veneer and hardwood edge stains are standard. Stain-to-match available at no upcharge.
- Standard table height 29".
- All bases are standard with floor leveling glides.

### OPTIONS

- Custom heights available.
- Two tone base available, add \$84 List per base.

### HOW TO ORDER

1. Select Model
2. Select Base
3. Select Edge Style
4. Select Options
5. Select Top Finish
6. Select Edge Finish
7. Select Base Finish

**Example:** 3654RT - THR - PVF -





# HALF ROUND GENERAL PURPOSE TABLES

BACK TO CONTENTS

MODEL	BASES		TOP SPECIFICATIONS						OPTIONS				LBS
	Code	Qty.	For Laminate Top			For Veneer Top			FLIP TOP (FT)	FOLD (FL)	CASTERS (LC)	WHEELS (WB)	
			SE PVF PVB 2MM	HF HB	HBV HBVR HBG	HF2 HB2 HKN4 HKNR4 HBG2	HF HB HBV HBG	HF2 HB2 HKN4 HKNR4 HBG2					
<i>Bullet</i>													
<b>30 x 54B</b>	THR	2	1115	1636	1744	1935	1991	2307	-	-	84	84	85
<b>30 x 60B</b>	THR	2	1115	1636	1744	1935	1991	2307	-	-	84	84	85
<b>36 x 54B</b>	THR	2	1228	2103	2258	2537	2575	2972	282	-	84	84	95
<b>36 x 60B</b>	THR	2	1228	2103	2258	2537	2575	2972	282	-	84	84	95
<b>36 x 72B</b>	THR	2	1354	2322	2493	2791	2964	3462	282	-	84	84	108
<i>Halfmoon</i>													
<b>24 x 48H</b>	THR	2	918	1388	1506	1649	1765	2033	282	-	84	84	66
<b>30 x 60H</b>	THR	2	1115	1815	1978	2138	2339	2721	282	-	84	84	85
<b>36 x 72H</b>	THR	2	1354	2310	2521	2718	3045	3561	282	-	84	84	108
<i>Trapezoid</i>													
<b>30 x 60TP</b>	THR	2	1115	1546	1646	1820	1870	2162	282	-	84	84	85
<b>36 x 72TP</b>	THR	2	1354	1938	2071	2371	2445	2866	282	-	84	84	108
<i>Radius (connector)</i>													
<b>24 x 24</b>	<b>24RC90</b>	-	362	656	741	850	871	1043	-	-	-	-	17
<b>30 x 30</b>	<b>30RC90</b>	-	462	868	975	1094	1156	1387	-	-	-	-	27
<i>Crescent</i>													
<b>30 x 36</b>	<b>3036CRC90-THR</b>	1	811	1439	1518	1580	1780	1999	-	-	-	-	48
<b>36 x 42</b>	<b>3642CRC90-THR</b>	1	1144	1733	1841	1923	2197	2494	-	-	-	-	61

\*Folding tables available with PVC Bullnose edge only



2448RE-THR

### STANDARD FEATURES

- Laminate tops available in any standard Wilsonart, Nevamar, Formica, Arborite or Pionite matte finish offerings. For other laminate please contact the factory for pricing.
- Veneers and hardwood edges are standard in Oak, Chocolate, Maple, Cherry, Pecan, Walnut, Mahogany.
- 7 veneer and hardwood edge stains are standard. Stain-to-match available at no upcharge.
- Standard table height 29".
- All bases are standard with floor leveling glides.

### OPTIONS

- Custom heights available.
- Two tone base available, add \$84 List per base.

### HOW TO ORDER

- Select Model
- Select Base
- Select Edge Style
- Select Options
- Select Top Finish
- Select Edge Finish
- Select Base Finish

Example: 3054B - THR - PVF -







# HALF ROUND BOARDROOM TABLES

BACK TO CONTENTS



MODEL	BASES		TOP SPECIFICATIONS						OPTIONS	LBS
	Code	Qty.	For Laminate Top			For Veneer Top				
			SE	HF	HBV	HF2	HF	HF2		
			PVF	HB	HBVR	HB2	HB	HB2		
			PVB		HGG	HKN4	HBV	HKN4		
			2MM			HKNR4	HBVR	HKNR4		
						HGG2	HGG	HGG2		
<i>Rectangle</i>										
42 x 96RE	T2HR	2	2096	2929	3155	3382	3720	4372		193
48 x 96RE	T2HR	2	2096	2929	3155	3382	3720	4372		193
48 x 120RE	T2HR	3	2805	3880	4135	4684	4766	5527		255
48 x 144RE	T2HR	3	3168	4710	5045	5568	5444	6361		289
48 x 168RE	T2HR	3	3629	5181	5564	6294	6125	7191		323
60 x 120RE	T2HR	3	3248	4856	5207	5750	5621	6576		297
60 x 144RE	T2HR	3	3659	5588	6009	6659	6506	7652		339
60 x 168RE	T2HR	3	4070	6321	6809	7571	7390	8727		381
<i>Racetrack</i>										
42 x 96RT	T2HR	2	2116	3057	3286	3838	4228	4923		193
48 x 96RT	T2HR	2	2116	3057	3286	3838	4228	4923		193
48 x 120RT	T2HR	3	2829	4323	4622	5383	5351	6163		255
48 x 144RT	T2HR	3	3195	5056	5422	6366	6147	7131		289
48 x 168RT	T2HR	3	3659	5682	6111	7158	6954	8095		323
60 x 120RT	T2HR	3	3238	5105	5476	6432	6389	7408		297
60 x 144RT	T2HR	3	3695	6020	6480	7661	7386	8616		339
60 x 168RT	T2HR	3	4276	6806	7341	8646	8394	9820		381



4296BTA-T2HR

### STANDARD FEATURES

- Laminate tops available in any standard Wilsonart, Nevamar, Formica, Arborite or Pionite matte finish offerings. For other laminate please contact the factory for pricing.
- Veneers and hardwood edges are standard in Oak, Chocolate, Maple, Cherry, Pecan, Walnut, Mahogany.
- 7 veneer and hardwood edge stains are standard. Stain-to-match available at no upcharge.
- Standard table height 29".
- All bases are standard with floor leveling glides.

### OPTIONS

- Custom heights available.
- Two tone base available, add \$84 List per base.

### HOW TO ORDER

1. Select Model
2. Select Base
3. Select Edge Style
4. Select Top Finish
5. Select Edge Finish
6. Select Base Finish

**Example:** 4296RE - T2HR - PVF

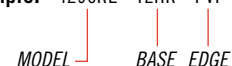



# HALF ROUND BOARDROOM TABLES

BACK TO CONTENTS



MODEL	BASES		TOP SPECIFICATIONS						OPTIONS	LBS
	Code	Qty.	For Laminate Top			For Veneer Top				
			SE	HF	HBV	HF2	HF	HF2		
			PVF	HB	HBVR	HB2	HB	HB2		
			PVB		HGG	HKN4	HBV	HKN4		
			2MM			HKNR4	HBVR	HKNR4		
						HGG2	HGG	HGG2		
<i>Boatshape</i>										
42 x 96BT	T2HR	2	2116	3699	3994	4298	4729	5108		193
48 x 96BT	T2HR	2	2116	3699	3994	4298	4729	5108		193
48 x 120BT	T2HR	2	2829	5027	5393	5778	5943	6380		255
48 x 144BT	T2HR	3	3195	5760	6196	6659	7243	7641		289
48 x 168BT	T2HR	3	3659	6461	6968	7503	7776	8391		323
60 x 120BT	T2HR	3	3238	5983	6443	6924	7131	7675		297
60 x 144BT	T2HR	3	3695	6902	7447	8026	8754	9253		339
60 x 168BT	T2HR	3	4276	7779	8412	9081	9419	10190		381
<i>Boatshape Arc Ends</i>										
42 x 96BTA	T2HR	2	2276	4204	4500	4806	5234	5614		193
48 x 96BTA	T2HR	2	2276	4204	4500	4806	5234	5614		193
48 x 120BTA	T2HR	2	2990	5534	5900	6286	6450	6885		255
48 x 144BTA	T2HR	3	3356	6265	6704	7167	7748	8148		289
48 x 168BTA	T2HR	3	3821	6968	7476	8011	8281	8899		323
60 x 120BTA	T2HR	3	3440	6619	7075	7558	7763	8307		297
60 x 144BTA	T2HR	3	3895	7533	8081	8659	9387	9884		339
60 x 168BTA	T2HR	3	4476	8412	9045	9712	10054	10825		381



4296BTA-T2HR

### STANDARD FEATURES

- Laminate tops available in any standard Wilsonart, Nevamar, Formica, Arborite or Pionite matte finish offerings. For other laminate please contact the factory for pricing.
- Veneers and hardwood edges are standard in Oak, Chocolate, Maple, Cherry, Pecan, Walnut, Mahogany.
- 7 veneer and hardwood edge stains are standard. Stain-to-match available at no upcharge.
- Standard table height 29".
- All bases are standard with floor leveling glides.

### OPTIONS

- Custom heights available.
- Two tone base available, add \$84 List per base.

### HOW TO ORDER

1. Select Model
2. Select Base
3. Select Edge Style
4. Select Top Finish
5. Select Edge Finish
6. Select Base Finish

**Example:** 4296BT - T2HR - PVF

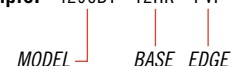



# HEAVY DUTY TABLES



PLACING AN ORDER IS EASY

## PRODUCT CODE

**2424SQ-TR HD**

Product Code

Specification  
HD: Heavy Duty\*

\*The code for our heavy duty tables featured in the pages below is the same as a regular model of the table you are specifying. By adding the letters "HD" at the end of the product code, it lets us know the product is intended for a behavioral health environment and the features below will automatically be specified.

## FEATURES

TAMPER PROOF



WEIGHTED



LOCTITE GLIDES



## FINISHES

LAMINATE



Select laminate from our virtually unlimited laminate options

VENEER

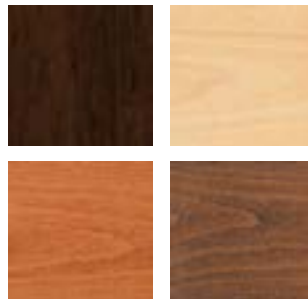

Select from one of our 7 standard wood stains or stain-to-match at no upcharge

BASE



Select from one of our 76 standard Spectone colors

EDGE



2MM

PVC

Hard Wood







Check out our website for a complete list of edge profiles.

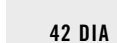

# HEAVY DUTY TABLES

## NOTES AND OPTIONS

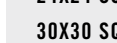
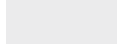
- Laminate tops available in any standard Wilsonart, Nevamar, Pionite, Formica or Arborite matte finish offerings. For other laminate please contact the factory for pricing.
- Veneers and hardwood edges are standard in Oak, Maple, Cherry, Walnut, Mahogany, Pecan and Chocolate.
- 7 veneer and hardwood edge stains are standard. Stain-to-match available at no upcharge.
- Standard table height: 29". Customs available.
- All bases are standard with floor leveling glides.
- Chrome bases may be available as an upcharge. Please contact the factory.

MODEL <i>Size / Shape</i>	BASES		TOP SPECIFICATIONS						OPTIONS	MOBILITY	LBS
	<i>Code</i>	<i>#of</i>	<i>For Laminate Top</i>			<i>For Veneer Top</i>					
			SE PVF PVB 2MM	HF HB	HBV HBVR HBG	HF2 HB2 HKN4 HKNR4 HBG2	HF HB HBV HBVR HBG	HF2 HB2 HKN4 HKNR4 HBG2			
 24 DIA	TRHD	1	812	1141	1175	1275	1328	1431			99
	DISCHD	1	1042	1371	1405	1505	1558	1661			116
 30 DIA	TRHD	1	907	1231	1275	1474	1423	1574			109
	DISCHD	1	1137	1461	1505	1704	1653	1804			126
 36 DIA	TRHD	1	997	1468	1550	1713	1763	1972			120
	DISCHD	1	1227	1698	1780	1943	1993	2202			137
 42 DIA	TRHD	1	1258	1785	1899	2141	2166	2452			134
	DISCHD	1	1488	2015	2129	2371	2396	2682			161
 48 DIA	TRHD	1	1279	1987	2111	2231	2665	3033			150
	DISCHD	1	1509	2217	2341	2461	2895	3263			177
 24X24 SQ	TRHD	1	840	1019	1053	1115	1160	1314			99
	DISCHD	1	1168	1298	1345	1509	1450	1661			136
 30X30 SQ	TRHD	1	938	1068	1115	1279	1220	1431			106
	DISCHD	1	1168	1298	1345	1509	1450	1661			136
 36X36 SQ	TRHD	1	1015	1219	1275	1468	1474	1658			120
	DISCHD	1	1245	1449	1505	1698	1704	1888			147



Weighted Trumpet Base



Weighted Disc Base



Weighted Trumpet Base  
Lounge Height



## Heavy Duty Drums and Cubes





Drums



Cubes

### NOTES AND OPTIONS

- Laminate tops available in any standard Wilsonart, Nevamar, Pionite, Formica or Arborite matte finish offerings. For other laminate please contact the factory for pricing.
- Veneers are standard in Oak, Maple, Cherry, Walnut, Mahogany, Pecan and Chocolate.
- Other sizes are available. Contact the factory for pricing.
- Standard heights: 16", 18", 20", 22".
- 2" Kickplate option add \$47 to list prices shown.

MODEL <i>Size / Shape</i>	BASES	SPECIFICATIONS		LBS	
		<i>Laminate</i> SE	<i>Veneer</i> SE		
	18 DIA	DRMHD	751	789	78
	24 DIA	DRMHD	792	833	92
	30 DIA	DRMHD	987	1030	106
	36 DIA	DRMHD	1114	1159	121
	42 DIA	DRMHD	1232	1311	138
	18 SQ	CUBEHD	577	789	81
	24 SQ	CUBEHD	607	832	100
	30 SQ	CUBEHD	755	915	113
	36 SQ	CUBEHD	873	1409	150





# MANHATTAN TABLES



PLACING AN ORDER IS EASY

## PRODUCT CODE

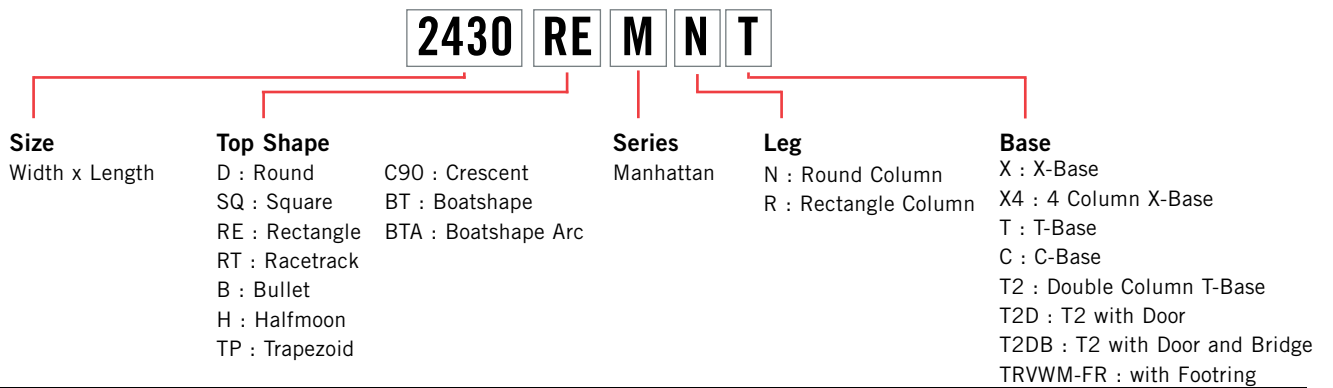

## OPTIONS

**FLIP TOP**



**CASTERS**



**FOLDING**



**ELECTRIC HEIGHT ADJUSTABLE**



**VERTICAL WIRE MANAGER**



Oval



Rectangular

## FINISHES

**LAMINATE**



Select laminate from our virtually unlimited laminate options

**VENEER**

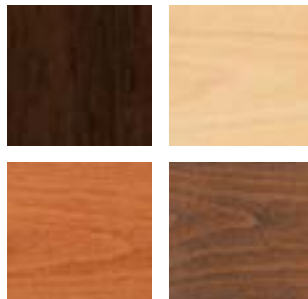

Select from one of our 7 standard wood stains or stain-to-match at no upcharge

**BASE**



Select from one of our 76 standard Spectone colors

**EDGE**



2MM

PVC

Hard Wood

Check out our website for a complete list of edge profiles.



# MANHATTAN GENERAL PURPOSE TABLES



BACK TO CONTENTS

MODEL	BASES		TOP SPECIFICATIONS						OPTIONS			MOBILITY	LBS
	Code	Qty.	For Laminate Top			For Veneer Top			FLIP TOP	FOLD	BAR HEIGHT	CASTERS	
			SE PVF PVB 2MM	HF HB	HBV HBVR HBG	HF2 HB2 HKNR4 HBG2	HF HB HBV HBG	HF2 HB2 HKNR4 HBG2	Add	Add	Add	Add	
<i>Round</i>													
24D	MNX	1	569	898	932	1032	1085	1188	141	-	35	84	34
30D	MNX	1	664	988	1032	1231	1180	1331	141	-	35	84	44
36D	MNX	1	754	1225	1307	1470	1520	1729	141	-	35	84	55
42D	MNX	1	1015	1542	1656	1898	1923	2209	141	-	-	84	69
42D	MNX4	1	1125	1652	1766	2008	2033	2319	-	-	-	84	74
48D	MNX4	1	1146	1854	1978	2098	2532	2900	-	-	-	84	93
<i>Square</i>													
24 X 24SQ	MNX	1	597	776	810	872	917	1071	141	-	35	84	34
30 X 30SQ	MNX	1	695	825	872	1036	977	1188	141	-	35	84	44
36 X 36SQ	MNX	1	772	976	1032	1225	1231	1415	141	-	35	84	55
42 X 42SQ	MNX4	1	1139	1434	1525	1616	1679	1930	-	-	-	84	77
48 X 48SQ	MNX4	1	1280	1539	1635	1677	2024	2346	-	-	-	84	93
<i>Rectangle</i>													
20 X 42RE	MNT, MNC	2	746	942	993	1085	1141	1307	282	-	-	84	69
20 X 48RE	MNT, MNC	2	746	942	993	1085	1141	1307	282	-	-	84	71
20 X 54RE	MNT, MNC	2	801	1087	1152	1258	1337	1540	282	-	-	84	74
20 X 60RE	MNT, MNC	2	801	1087	1152	1258	1337	1540	282	273*	-	84	79
20 X 66RE	MNT, MNC	2	937	1281	1361	1490	1574	1823	282	273*	-	84	83
20 X 72RE	MNT, MNC	2	937	1281	1361	1490	1574	1823	282	273*	-	84	88

\*Folding tables available with PVC Bullnose edge only.  
Note: Tap-in Powerway and Flip Top combination can not be specified on 20" deep tops.



MNX



MNX4



MNT



MNC

### STANDARD FEATURES

- Laminates Tops are available in any standard Wilsonart, Nevamar, Formica, Arborite or Pionite matte Finish.
- For other laminates please contact the factory.
- Veneers and hardwood edge stains are standard in Maple, Mahogany, Cherry, Oak, Walnut, Pecan and Chocolate, or Stain-to-Match at no upcharge.
- Standard with leveling glides.
- Bases available in any Spectone color.
- Standard 29" table height.
- Locking Casters are not self-leveling.
- Base span increases with size of top.

### OPTIONS

For Oval or Rectangle Vertical wire manager, Tap-in Powerway and Dash & Dots modesty panel see accessories at the end of this section. For all other accessories refer to the table accessories price list.

### HOW TO ORDER

- Select Model
- Select Base
- Select Edge Style
- Select Options
- Select Top Finish
- Select Edge Finish
- Select Base Finish

**Example:** 24D - MNX - PVF -  
 MODEL | BASE | EDGE | OPTIONS



# MANHATTAN GENERAL PURPOSE TABLES

MODEL	BASES		TOP SPECIFICATIONS						OPTIONS			MOBILITY	LBS
	<i>Code</i>	<i>Qty.</i>	<i>For Laminate Top</i>			<i>For Veneer Top</i>			<b>FLIP TOP</b>	<b>FOLD</b>	<b>BAR HEIGHT</b>	<b>CASTERS</b>	
			<b>SE</b>	<b>HF</b>	<b>HBV</b>	<b>HF2</b>	<b>HF</b>	<b>HF2</b>	<b>Add</b>	<b>Add</b>	<b>Add</b>	<b>Add</b>	
			<b>PVF</b>	<b>HB</b>	<b>HBVR</b>	<b>HB2</b>	<b>HB</b>	<b>HB2</b>					
			<b>PVB</b>		<b>HKG</b>	<b>HKN4</b>	<b>HBV</b>	<b>HKN4</b>					
			<b>2MM</b>			<b>HKNR4</b>	<b>HBVR</b>	<b>HKNR4</b>					
						<b>HKG2</b>	<b>HKG</b>	<b>HKG2</b>					
<i>Rectangle</i>													
<b>24 X 30RE</b>	<b>MNX</b>	1	684	806	850	913	962	1081	141	-	-	-	43
<b>24 X 30RE</b>	<b>MNT, MNC</b>	2	685	807	851	914	963	1082	282	-	-	84	58
<b>24 X 36RE</b>	<b>MNX</b>	1	684	806	850	913	962	1081	141	-	-	-	48
<b>24 X 36RE</b>	<b>MNT, MNC</b>	2	685	807	851	914	963	1082	282	-	-	84	63
<b>24 X 42RE</b>	<b>MNT, MNC</b>	2	746	942	993	1085	1141	1307	282	-	-	84	66
<b>24 X 48RE</b>	<b>MNT, MNC</b>	2	746	942	993	1085	1141	1307	282	-	-	84	71
<b>24 X 54RE</b>	<b>MNT, MNC</b>	2	801	1087	1152	1258	1337	1540	282	-	-	84	74
<b>24 X 60RE</b>	<b>MNT, MNC</b>	2	801	1087	1152	1258	1337	1540	282	273*	-	84	79
<b>24 X 66RE</b>	<b>MNT, MNC</b>	2	937	1281	1361	1490	1574	1823	282	273*	-	84	83
<b>24 X 72RE</b>	<b>MNT, MNC</b>	2	937	1281	1361	1490	1574	1823	282	273*	-	84	88

\*Folding tables available with PVC Bullnose edge only.  
Note: MNC base can not be specified with flip top and tap-in powerway on tables 24" deep.



**MNX**



**MNT**



**MNC**

**STANDARD FEATURES**

- Laminate Tops are available in any standard Wilsonart, Nevamar, Formica, Arborite or Pionite matte Finish.
- For other laminates please contact the factory.
- Veneers and hardwood edge stains are standard in Maple, Mahogany, Cherry, Oak, Walnut, Pecan and Chocolate or Stain-to-Match at no upcharge.
- Standard with leveling glides.
- Bases available in any Spectone color.
- Standard 29" table height.
- Locking Casters are not self-leveling.
- Base span increases with size of top.

**OPTIONS**

For Oval or Rectangle Vertical wire manager, Tap-in Powerway and Dash & Dots modesty panel see accessories at the end of this section. For all other accessories refer to the table accessories price list.

**HOW TO ORDER**

1. Select Model
2. Select Base
3. Select Edge Style
4. Select Options
5. Select Top Finish
6. Select Edge Finish
7. Select Base Finish







# MANHATTAN GENERAL PURPOSE TABLES

BACK TO CONTENTS

MODEL	BASES		TOP SPECIFICATIONS						OPTIONS			MOBILITY	LBS
	Code	Qty.	For Laminate Top			For Veneer Top			FLIP TOP	FOLD	BAR HEIGHT	CASTERS	
			SE PVF PVB 2MM	HF HB	HBV HBVR HBG	HF2 HB2 HKNR4 HBG2	HF HB HBV HBG	HF2 HB2 HKNR4 HBG2	Add	Add	Add	Add	
<i>Rectangle</i>													
30 X 36RE	MNX	1	772	913	963	1043	1101	1245	141	-	-	84	59
30 X 36RE	MNT, MNC	2	773	914	964	1044	1102	1246	282	-	-	84	64
30 X 42RE	MNT, MNC	2	792	1061	1123	1229	1307	1509	282	-	-	84	74
30 X 48RE	MNT, MNC	2	792	1061	1123	1229	1307	1509	282	-	-	84	79
30 X 54RE	MNT, MNC	2	847	1214	1294	1445	1535	1788	282	-	-	84	85
30 X 60RE	MNT, MNC	2	847	1214	1294	1445	1535	1788	282	273*	-	84	90
30 X 66RE	MNT, MNC	2	1010	1306	1403	1557	1644	1924	282	273*	-	84	95
30 X 72RE	MNT, MNC	2	1062	1449	1547	1745	1848	2155	282	273*	-	84	100
30 X 78RE	MNT, MNC	2	1272	1614	1730	1960	2081	2434	282	273*	-	84	106
30 X 84RE	MNT, MNC	2	1272	1614	1730	1960	2081	2434	282	273*	-	84	111
30 X 90RE	MNT, MNC	2	1291	1821	1960	2173	2316	2718	282	273*	-	84	116
30 X 96RE	MNT, MNC	2	1291	1821	1960	2173	2316	2718	282	273*	-	84	121

\*Folding tables available with PVC Bullnose edge only.



MNX



MNT



MNC

### STANDARD FEATURES

- Laminate Tops are available in any standard Wilsonart, Nevamar, Formica, Arborite or Pionite matte Finish.
- For other laminates please contact the factory.
- Veneers and hardwood edge stains are standard in Maple, Mahogany, Cherry, Oak, Walnut, Pecan and Chocolate or Stain-to-Match at no upcharge.
- Standard with leveling glides.
- Bases available in any Spectone color.
- Standard 29" table height.
- Locking Casters are not self-leveling.
- Base span increases with size of top.

### OPTIONS

For Oval or Rectangle Vertical wire manager, Tap-in Powerway and Dash & Dots modesty panel see accessories at the end of this section. For all other accessories refer to the table accessories price list.

### HOW TO ORDER

1. Select Model
2. Select Base
3. Select Edge Style
4. Select Options
5. Select Top Finish
6. Select Edge Finish
7. Select Base Finish

Example: 3036RE- MNX - PVF -





# MANHATTAN GENERAL PURPOSE TABLES

BACK TO CONTENTS

MODEL	BASES		TOP SPECIFICATIONS						OPTIONS			MOBILITY	LBS
	<i>Code</i>	<i>Qty.</i>	<i>For Laminate Top</i>			<i>For Veneer Top</i>			FLIP TOP	FOLD	BAR HEIGHT	CASTERS	
			SE PVF PVB 2MM	HF HB	HBV HBVR HBG	HF2 HB2 HKN4 HKNR4 HBG2	HF HB HBV HBVR HBG	HF2 HB2 HKN4 HKNR4 HBG2	<i>Add</i>	<i>Add</i>	<i>Add</i>	<i>Add</i>	
<i>Rectangle</i>													
36 X 42RE	MNT, MNC	2	885	1087	1165	1271	1352	1564	282	-	-	84	88
36 X 48RE	MNT, MNC	2	909	1194	1277	1403	1487	1734	282	-	-	84	88
36 X 54RE	MNT, MNC	2	981	1290	1385	1527	1631	1903	282	-	-	84	90
36 X 60RE	MNT, MNC	2	999	1396	1497	1658	1760	2069	282	273*	-	84	95
36 X 66RE	MNT, MNC	2	1081	1493	1609	1786	1897	2237	282	273*	-	84	94
36 X 66RE	MNT2	2	1383	1795	1911	2088	2199	2539	282	547*	-	84	108
36 X 72RE	MNT	2	1117	1547	1658	1914	2037	2405	282	273*	-	84	107
36 X 72RE	MNT2	2	1419	1849	1960	2216	2339	2707	-	547*	-	84	115
36 X 78RE	MNT	2	1430	1890	2034	2256	2401	2834	282	273*	-	84	114
36 X 78RE	MNT2	2	1732	2192	2336	2558	2703	3136	-	547*	-	84	121
36 X 84RE	MNT	2	1430	1890	2034	2256	2401	2834	282	273*	-	84	120
36 X 84RE	MNT2	2	1732	2192	2336	2558	2703	3136	-	547*	-	84	127
36 X 90RE	MNT	2	1435	2091	2256	2515	2681	3162	282	273*	-	84	126
36 X 90RE	MNT2	2	1737	2393	2558	2817	2983	3464	-	547*	-	84	133
36 X 96RE	MNT	2	1435	2091	2256	2515	2681	3162	282	273*	-	84	132
36 X 96RE	MNT2	2	1737	2393	2558	2817	2983	3464	-	547*	-	84	135
42 X 78RE	MNT2	2	1958	2354	2512	2894	3020	3522	-	547*	-	84	143
42 X 84RE	MNT2	2	1958	2354	2512	2894	3020	3522	-	547*	-	84	148

\*Folding tables available with PVC Bullnose edge only.



### STANDARD FEATURES

- Laminates Tops are available in any standard Wilsonart, Nevamar, Formica, Arborite or Pionite matte Finish.
- For other laminates please contact the factory.
- Veneers and hardwood edge stains are standard in Maple, Mahogany, Cherry, Oak, Walnut, Pecan and Chocolate or Stain-to-Match at no upcharge.
- Standard with leveling glides.
- Bases available in any Spectone color.
- Standard 29" table height.
- Locking Casters are not self-leveling.
- Base span increases with size of top.

### OPTIONS

For Oval or Rectangle Vertical wire manager, Tap-in Powerway and Dash & Dots modesty panel see accessories at the end of this section. For all other accessories refer to the table accessories price list.

### HOW TO ORDER

- Select Model
- Select Base
- Select Edge Style
- Select Options
- Select Top Finish
- Select Edge Finish
- Select Base Finish

**Example:** 3642RE- MNT - PVF -

MODEL | BASE | EDGE | OPTIONS



# MANHATTAN GENERAL PURPOSE TABLES

BACK TO CONTENTS

MODEL	BASES		TOP SPECIFICATIONS						OPTIONS			MOBILITY	LBS
	Code	Qty.	For Laminate Top			For Veneer Top			FLIP TOP	FOLD	BAR HEIGHT	CASTERS	
			SE PVF PVB 2MM	HF HB	HBV HBVR HBG	HF2 HB2 HKNR4 HBG2	HF HB HBV HBG	HF2 HB2 HKNR4 HBG2	Add	Add	Add	Add	
<i>Racetrack</i>													
36 X 54RT	MNT	2	1051	1574	1696	1914	2003	2322	282	-	-	84	84
36 X 54RT	MNT2	2	1353	1876	1998	2216	2305	2624	-	-	-	84	90
36 X 60RT	MNT	2	1051	1574	1696	1914	2003	2322	282	-	-	84	89
36 X 60RT	MNT2	2	1353	1876	1998	2216	2305	2624	-	-	-	84	95
36 X 66RT	MNT	2	1199	1745	1877	2110	2316	2714	282	-	-	84	94
36 X 66RT	MNT2	2	1501	2047	2179	2412	2618	3016	-	-	-	84	108
36 X 72RT	MNT	2	1199	1745	1877	2110	2316	2714	282	-	-	84	107
36 X 72RT	MNT2	2	1501	2047	2179	2412	2618	3016	-	-	-	84	115
36 X 78RT	MNT	2	1445	2139	2301	2654	2728	3193	282	-	-	84	114
36 X 78RT	MNT2	2	1747	2441	2603	2956	3030	3495	-	-	-	84	121
36 X 84RT	MNT	2	1445	2139	2301	2654	2728	3193	282	-	-	84	120
36 X 84RT	MNT2	2	1747	2441	2603	2956	3030	3495	-	-	-	84	127
36 X 90RT	MNT	2	1449	2375	2568	2963	3055	3584	282	-	-	84	130
36 X 90RT	MNT2	2	1751	2677	2870	3265	3357	3886	-	-	-	84	133
36 X 96RT	MNT	2	1449	2375	2568	2963	3055	3584	282	-	-	84	130
36 X 96RT	MNT2	2	1751	2677	2870	3265	3357	3886	-	-	-	84	135
42 X 78RT	MNT2	2	1972	2628	2827	3226	3322	3857	-	-	-	84	143
42 X 84RT	MNT2	2	1972	2628	2827	3226	3322	3857	-	-	-	84	148
48 X 78RT	MNT2	2	1975	2910	3135	3488	3709	4317	-	-	-	84	143
48 X 84RT	MNT2	2	1975	2910	3135	3488	3709	4317	-	-	-	84	148



MNT



MNT2

### STANDARD FEATURES

- Laminates are available in any standard Wilsonart, Nevamar, Formica, Arborite or Pionite matte Finish.
- For other laminates please contact the factory.
- Veneers and hardwood edge stains are standard in Maple, Mahogany, Cherry, Oak, Walnut, Pecan and Chocolate or Stain-to-Match at no upcharge.
- Standard with leveling glides.
- Bases available in any Spectone color.
- Standard 29" table height.
- Locking Casters are not self-leveling.
- Base span increases with size of top.

### OPTIONS

For Oval or Rectangle Vertical wire manager, Tap-in Powerway and Dash & Dots modesty panel see accessories at the end of this section. For all other accessories refer to the table accessories price list.

### HOW TO ORDER

- Select Model
- Select Base
- Select Edge Style
- Select Options
- Select Top Finish
- Select Edge Finish
- Select Base Finish

Example: 3654RT- MNT - PVF -





# MANHATTAN GENERAL PURPOSE TABLES



BACK TO CONTENTS

MODEL	BASES		TOP SPECIFICATIONS						OPTIONS			MOBILITY	LBS
	<i>Code</i>	<i>Qty.</i>	<i>For Laminate Top</i>			<i>For Veneer Top</i>			<b>FLIP TOP</b>	<b>FOLD</b>	<b>BAR HEIGHT</b>	<b>CASTERS</b>	
			<b>SE</b>	<b>HF</b>	<b>HBV</b>	<b>HF2</b>	<b>HF</b>	<b>HF2</b>	<b>FLIP TOP</b>	<b>FOLD</b>	<b>BAR HEIGHT</b>	<b>CASTERS</b>	
			<b>PVF</b>	<b>HB</b>	<b>HBVR</b>	<b>HB2</b>	<b>HB</b>	<b>HB2</b>	<i>Add</i>	<i>Add</i>	<i>Add</i>	<i>Add</i>	
			<b>PVB</b>		<b>HKG</b>	<b>HKN4</b>	<b>HBV</b>	<b>HKN4</b>					
			<b>2MM</b>			<b>HKNR4</b>	<b>HBVR</b>	<b>HKNR4</b>					
						<b>HKG2</b>	<b>HKG</b>	<b>HKG2</b>					
<i>Bullet</i>													
<b>30 X 54B</b>	MNT	2	959	1480	1588	1779	1835	2151	282	-	-	84	85
<b>30 X 60B</b>	MNT	2	959	1480	1588	1779	1835	2151	282	-	-	84	90
<b>36 X 54B</b>	MNT	2	1072	1947	2102	2381	2419	2816	282	-	-	84	90
<b>36 X 60B</b>	MNT	2	1072	1947	2102	2381	2419	2816	282	-	-	84	95
<b>36 X 66B</b>	MNT	2	1198	2166	2337	2635	2808	3306	282	-	-	84	108
<b>36 X 72B</b>	MNT	2	1198	2166	2337	2635	2808	3306	282	-	-	84	115
<i>Halfmoon</i>													
<b>24 X 48H</b>	MNT	2	762	1232	1350	1493	1609	1877	282	-	-	84	71
<b>30 X 60H</b>	MNT	2	959	1659	1822	1982	2183	2565	282	-	-	84	90
<b>36 X 72H</b>	MNT	2	1198	2154	2365	2562	2889	3405	282	-	-	84	115
<i>Trapezoid</i>													
<b>30 X 60TP</b>	MNT	2	959	1390	1490	1664	1714	2006	282	-	-	84	90
<b>36 X 72TP</b>	MNT	2	1198	1782	1915	2215	2289	2710	282	-	-	84	115
<i>Crescent</i>													
<b>30 X 36RC90</b>	MNT	2	936	1564	1643	1705	1905	2124	-	-	-	84	48
<b>36 X 42RC90</b>	MNT	2	1269	1858	1966	2048	2322	2619	-	-	-	84	61



MNT

### STANDARD FEATURES

- Laminate Tops are available in any standard Wilsonart, Nevamar, Formica, Arborite or Pionite matte Finish.
- For other laminates please contact the factory.
- Veneers and hardwood edge stains are standard in Maple, Mahogany, Cherry, Oak, Walnut, Pecan and Chocolate or Stain-to-Match at no upcharge.
- Standard with leveling glides.
- Bases available in any Spectone color.
- Standard 29" table height.
- Locking Casters are not self-leveling.
- Base span increases with size of top.

### OPTIONS

For Oval or Rectangle Vertical wire manager, Tap-in Powerway and Dash & Dots modesty panel see accessories at the end of this section. For all other accessories refer to the table accessories price list.

### HOW TO ORDER

1. Select Model
2. Select Base
3. Select Edge Style
4. Select Options
5. Select Top Finish
6. Select Edge Finish
7. Select Base Finish

**Example:** 3054B - MNT - PVF -





# MANHATTAN BOARDROOM TABLES

BACK TO CONTENTS



MODEL	BASES		TOP SPECIFICATIONS						OPTIONS	MOBILITY	LBS
	<i>Code</i>	<i>Qty.</i>	<i>For Laminate Top</i>			<i>For Veneer Top</i>					
			SE	HF	HBV	HF2	HF	HF2			
			PVF	HB	HBVR	HB2	HB	HB2			
			PVB		HBG	HKN4	HBV	HKN4			
			2MM			HKNR4	HBVR	HKNR4			
						HBG2	HBG	HBG2			
<i>Rectangle</i>											
42 X 96RE	MNT2	2	2006	2839	3065	3292	3630	4282			175
42 X 96RE	MNT2D	2	3070	3903	4129	4356	4694	5346			185
48 X 96RE	MNT2	2	2006	2839	3065	3292	3630	4282			179
48 X 96RE	MNT2D	2	3070	3903	4129	4356	4694	5346			189
48 X 120RE	MNT2	3	2670	3745	4000	4549	4631	5392			228
48 X 120RE	MNT2D	3	4266	5341	5596	6145	6227	6988			238
48 X 120RE	MNT2DB	2	3662	4737	4992	5541	5623	6384			236
48 X 144RE	MNT2	3	3033	4575	4910	5433	5309	6226			262
48 X 144RE	MNT2D	3	4629	6171	6506	7029	6905	7822			272
48 X 144RE	MNT2DB	2	4025	5567	5902	6425	6301	7218			280
48 X 168RE	MNT2	3	3494	5046	5429	6159	5990	7056			296
48 X 168RE	MNT2D	3	5090	6642	7025	7755	7586	8652			306
60 X 120RE	MNT2	3	3113	4721	5072	5615	5486	6441			270
60 X 120RE	MNT2D	3	4709	6317	6668	7211	7082	8037			280
60 X 120RE	MNT2DB	2	4105	5713	6064	6607	6478	7433			288
60 X 144RE	MNT2	3	3524	5453	5874	6524	6371	7517			312
60 X 144RE	MNT2D	3	5120	7049	7470	8120	7967	9113			322
60 X 144RE	MNT2DB	2	4516	6445	6866	7516	7363	8509			330
60 X 168RE	MNT2	3	3935	6186	6674	7436	7255	8592			354
60 X 168RE	MNT2D	3	5531	7782	8270	9032	8851	10188			364



MNT2



MNT2D



MNT2DB

### STANDARD FEATURES

- Laminate Tops are available in any standard Wilsonart, Nevamar, Formica, Arborite or Pionite matte Finish.
- For other laminates please contact the factory.
- Veneers and hardwood edge stains are standard in Maple, Mahogany, Cherry, Oak, Walnut, Pecan and Chocolate or Stain-to-Match at no upcharge.
- Standard with leveling glides.
- Bases available in any Spectone color.
- Standard 29" table height.
- Locking Casters are not self-leveling.
- Base span increases with size of top.

### OPTIONS

For Tap-in Powerway and Dash & Dots modesty panel see accessories at the end of this section.  
For all other accessories refer to the table accessories price list.

### HOW TO ORDER

1. Select Model
2. Select Base
3. Select Edge Style
4. Select Options
5. Select Top Finish
6. Select Edge Finish
7. Select Base Finish

**Example:** 4296RE - MNT2 - PVF -





# MANHATTAN BOARDROOM TABLES

BACK TO CONTENTS

MODEL	BASES		TOP SPECIFICATIONS						OPTIONS	MOBILITY	LBS
	Code	Qty.	For Laminate Top			For Veneer Top					
			SE PVF PVB 2MM	HF HB	HBV HBVR HBG	HF2 HB2 HKNR4 HBG2	HF HB HBV HBG	HF2 HB2 HKNR4 HBG2			
<i>Racetrack</i>											
42 X 96RT	MNT2	2	2026	2967	3196	3748	4138	4833			175
42 X 96RT	MNT2D	2	3090	4031	4260	4812	5202	5897			185
48 X 96RT	MNT2	2	2026	2967	3196	3748	4138	4833			179
48 X 96RT	MNT2D	2	3090	4031	4260	4812	5202	5897			189
48 X 120RT	MNT2	3	2694	4188	4487	5248	5216	6028			228
48 X 120RT	MNT2D	3	4290	5784	6083	6844	6812	7624			238
48 X 120RT	MNT2DB	2	3686	5180	5479	6240	6208	7020			236
48 X 144RT	MNT2	3	3060	4921	5287	6231	6012	6996			262
48 X 144RT	MNT2D	3	4656	6517	6883	7827	7608	8592			272
48 X 144RT	MNT2DB	2	4052	5913	6279	7223	7004	7988			280
48 X 168RT	MNT2	3	3524	5547	5976	7023	6819	7960			296
48 X 168RT	MNT2D	3	5120	7143	7572	8619	8415	9556			306
60 X 120RT	MNT2	3	3103	4970	5341	6297	6254	7273			270
60 X 120RT	MNT2D	3	4699	6566	6937	7893	7850	8869			280
60 X 120RT	MNT2DB	2	4095	5962	6333	7289	7246	8265			288
60 X 144RT	MNT2	3	3560	5885	6345	7526	7251	8481			312
60 X 144RT	MNT2D	3	5156	7481	7941	9122	8847	10077			322
60 X 144RT	MNT2DB	2	4552	6877	7337	8518	8243	9473			330
60 X 168RT	MNT2	3	4141	6671	7206	8511	8259	9685			354
60 X 168RT	MNT2D	3	5737	8267	8802	10107	9855	11281			364



MNT2



MNT2D



MNT2DB

**STANDARD FEATURES**

- Laminate Tops are available in any standard Wilsonart, Nevamar, Formica, Arborite or Pionite matte Finish.
- For other laminates please contact the factory.
- Veneers and hardwood edge stains are standard in Maple, Mahogany, Cherry, Oak, Walnut, Pecan and Chocolate or Stain-to-Match at no upcharge.
- Standard with leveling glides.
- Bases available in any Spectone color.
- Standard 29" table height.
- Locking Casters are not self-leveling.
- Base span increases with size of top.

**OPTIONS**

For Tap-in Powerway and Dash & Dots modesty panel see accessories at the end of this section.  
For all other accessories refer to the table accessories price list.

**HOW TO ORDER**

1. Select Model
2. Select Base
3. Select Edge Style
4. Select Options
5. Select Top Finish
6. Select Edge Finish
7. Select Base Finish

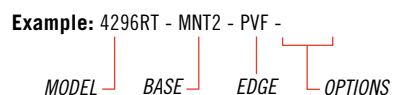



# MANHATTAN BOARDROOM TABLES



BACK TO CONTENTS

MODEL	BASES		TOP SPECIFICATIONS						OPTIONS	MOBILITY	LBS
	Code	Qty.	For Laminate Top			For Veneer Top					
			SE PVF PVB 2MM	HF HB	HBV HBVR HBG	HF2 HB2 HKN4 HKNR4 HBG2	HF HB HBV HBG	HF2 HB2 HKN4 HKNR4 HBG2			
<i>Boatshape</i>											
42 X 96BT	MNT2	2	2026	3609	3904	4208	4639	5018			175
42 X 96BT	MNT2D	2	3090	4673	4968	5272	5703	6082			185
48 X 96BT	MNT2	2	2026	3609	3904	4208	4639	5018			179
48 X 96BT	MNT2D	2	3090	4673	4968	5272	5703	6082			189
48 X 120BT	MNT2	3	2694	4892	5258	5643	5808	6245			228
48 X 120BT	MNT2D	3	4290	6488	6854	7239	7404	7841			238
48 X 120BT	MNT2DB	2	3686	5884	6250	6635	6800	7237			236
48 X 144BT	MNT2	3	3060	5625	6061	6524	7108	7506			262
48 X 144BT	MNT2D	3	4656	7221	7657	8120	8704	9102			272
48 X 144BT	MNT2DB	2	4052	6617	7053	7516	8100	8498			280
48 X 168BT	MNT2	3	3524	6326	6833	7368	7641	8256			296
48 X 168BT	MNT2D	3	5120	7922	8429	8964	9237	9852			306
60 X 120 BT	MNT2	3	3103	5848	6308	6789	6996	7540			270
60 X 120 BT	MNT2D	3	4699	7444	7904	8385	8592	9136			280
60 X 120 BT	MNT2DB	2	4095	6840	7300	7781	7988	8532			288
60 X 144BT	MNT2	3	3560	6767	7312	7891	8619	9118			312
60 X 144BT	MNT2D	3	5156	8363	8908	9487	10215	10714			322
60 X 144BT	MNT2DB	2	4552	7759	8304	8883	9611	10110			330
60 X 168BT	MNT2	3	4141	7644	8277	8946	9284	10055			354
60 X 168BT	MNT2D	3	5737	9240	9873	10542	10880	11651			364



MNT2



MNT2D



MNT2DB

**STANDARD FEATURES**

- Laminate Tops are available in any standard Wilsonart, Nevamar, Formica, Arborite or Pionite matte Finish.
- For other laminates please contact the factory.
- Veneers and hardwood edge stains are standard in Maple, Mahogany, Cherry, Oak, Walnut, Pecan and Chocolate or Stain-to-Match at no upcharge.
- Standard with leveling glides.
- Bases available in any Spectone color.
- Standard 29" table height.
- Locking Casters are not self-leveling.
- Base span increases with size of top.

**OPTIONS**

For Tap-in Powerway and Dash & Dots modesty panel see accessories at the end of this section.  
For all other accessories refer to the table accessories price list.

**HOW TO ORDER**

1. Select Model
2. Select Base
3. Select Edge Style
4. Select Options
5. Select Top Finish
6. Select Edge Finish
7. Select Base Finish

**Example:** 4296BT - MNT2 - PVF -





# MANHATTAN BOARDROOM TABLES



BACK TO CONTENTS

MODEL	BASES		TOP SPECIFICATIONS						OPTIONS	MOBILITY	LBS
	Code	Qty.	For Laminate Top			For Veneer Top					
			SE PVF PVB 2MM	HF HB	HBV HBVR HBG	HF2 HB2 HKN4 HKNR4 HBG2	HF HB HBV HBVR HBG	HF2 HB2 HKN4 HKNR4 HBG2			
<i>Boat Arc</i>											
42 X 96BTA	MNT2	2	2186	4114	4410	4716	5144	5524			175
42 X 96BTA	MNT2D	2	3250	5178	5474	5780	6208	6588			185
48 X 96BTA	MNT2	2	2186	4114	4410	4716	5144	5524			179
48 X 96BTA	MNT2D	2	3250	5178	5474	5780	6208	6588			189
48 X 120BTA	MNT2	3	2855	5399	5765	6151	6315	6750			228
48 X 120BTA	MNT2D	3	4451	6995	7361	7747	7911	8346			238
48 X 120BTA	MNT2DB	2	3847	6391	6757	7143	7307	7742			236
48 X 144BTA	MNT2	3	3221	6130	6569	7032	7613	8013			262
48 X 144BTA	MNT2D	3	4817	7726	8165	8628	9209	9609			272
48 X 144BTA	MNT2DB	2	4213	7122	7561	8024	8605	9005			280
48 X 168BTA	MNT2	3	3686	6833	7341	7876	8146	8764			296
48 X 168BTA	MNT2D	3	5282	8429	8937	9472	9742	10360			306
60 X 120 BTA	MNT2	3	3305	6484	6940	7423	7628	8172			270
60 X 120 BTA	MNT2D	3	4901	8080	8536	9019	9224	9768			280
60 X 120 BTA	MNT2DB	2	4297	7476	7932	8415	8620	9164			288
60 X 144BTA	MNT2	3	3760	7398	7946	8524	9252	9749			312
60 X 144BTA	MNT2D	3	5356	8994	9542	10120	10848	11345			322
60 X 144BTA	MNT2DB	2	4752	8390	8938	9516	10244	10741			330
60 X 168BTA	MNT2	3	4341	8277	8910	9577	9919	10690			354
60 X 168BTA	MNT2D	3	5937	9873	10506	11173	11515	12286			364



MNT2



MNT2D



MNT2DB

### STANDARD FEATURES

- Laminate Tops are available in any standard Wilsonart, Nevamar, Formica, Arborite or Pionite matte Finish.
- For other laminates please contact the factory.
- Veneers and hardwood edge stains are standard in Maple, Mahogany, Cherry, Oak, Walnut, Pecan and Chocolate or Stain-to-Match at no upcharge.
- Standard with leveling glides.
- Bases available in any Spectone color.
- Standard 29" table height.
- Locking Casters are not self-leveling.
- Base span increases with size of top.

### OPTIONS

For Tap-in Powerway and Dash & Dots modesty panel see accessories at the end of this section.

For all other accessories refer to the table accessories price list.

### HOW TO ORDER

1. Select Model
2. Select Base
3. Select Edge Style
4. Select Options
5. Select Top Finish
6. Select Edge Finish
7. Select Base Finish

**Example:** 4296BTA - MNT2 - PVF -

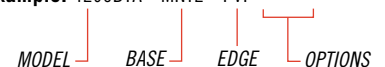





# MANHATTAN - RECTANGLE COLUMN GENERAL PURPOSE TABLES

BACK TO CONTENTS

MODEL	BASES		TOP SPECIFICATIONS						OPTIONS			MOBILITY	LBS	
	Code	Qty.	For Laminate Top			For Veneer Top			FLIP TOP	FOLD	BAR HEIGHT	ELECTRIC HEIGHT	CASTERS	
			SE PVF PVB 2MM	HF HB	HBV HBVR HBG	HF2 HB2 HKNR4 HBG2	HF HB HBV HKNR4 HBG	HF2 HB2 HKNR4 HBG2	Add	Add	Add	Add	Add	
<i>Rectangle</i>														
20 X 42RE	MRT, MRC	2	786	982	1033	1125	1181	1347	282	-	-	1100 <sup>1</sup>	84	69 <sup>2</sup>
20 X 48RE	MRT, MRC	2	786	982	1033	1125	1181	1347	282	-	-	1100 <sup>1</sup>	84	71 <sup>2</sup>
20 X 54RE	MRT, MRC	2	841	1127	1192	1298	1377	1580	282	-	-	1100 <sup>1</sup>	84	74 <sup>2</sup>
20 X 60RE	MRT, MRC	2	841	1127	1192	1298	1377	1580	282	-	-	1100 <sup>1</sup>	84	79 <sup>2</sup>
20 X 66RE	MRT, MRC	2	977	1321	1401	1530	1614	1863	282	-	-	1100 <sup>1</sup>	84	83 <sup>2</sup>
20 X 72RE	MRT, MRC	2	977	1321	1401	1530	1614	1863	282	-	-	1100 <sup>1</sup>	84	88 <sup>2</sup>
24 X 30RE	MRT, MRC	2	725	847	891	954	1003	1122	282	-	-	1100 <sup>1</sup>	84	58 <sup>2</sup>
24 X 36RE	MRT, MRC	2	725	847	891	954	1003	1122	282	-	-	1100 <sup>1</sup>	84	63 <sup>2</sup>
24 X 42RE	MRT, MRC	2	786	982	1033	1125	1181	1347	282	-	-	1100 <sup>1</sup>	84	66 <sup>2</sup>
24 X 48RE	MRT, MRC	2	786	982	1033	1125	1181	1347	282	-	-	1100 <sup>1</sup>	84	71 <sup>2</sup>
24 X 54RE	MRT, MRC	2	841	1127	1192	1298	1377	1580	282	-	-	1100 <sup>1</sup>	84	74 <sup>2</sup>
24 X 60RE	MRT, MRC	2	841	1127	1192	1298	1377	1580	282	-	-	1100 <sup>1</sup>	84	79 <sup>2</sup>
24 X 66RE	MRT, MRC	2	977	1321	1401	1530	1614	1863	282	-	-	1100 <sup>1</sup>	84	83 <sup>2</sup>
24 X 72RE	MRT, MRC	2	977	1321	1401	1530	1614	1863	282	-	-	1100 <sup>1</sup>	84	88 <sup>2</sup>

<sup>1</sup> Electric Height Adjustable available with T-base in Silver or Black only. Optional casters can be added. Flip top, fold options not available. 18" height range from 24" to 42" on a table with leveling glides, and from 26" to 44" on tables specified with casters. Electrical cord is 11ft long.

<sup>2</sup> For Electric Height Adjustable table add 18 lbs per table.

Note: Tap-in Powerway and Flip Top combination cannot be specified on 20" deep MRT base or on 20" and 24" deep MRC base.



MRT



MRC



ELECTRIC HEIGHT ADJUSTABLE



HEIGHT ADJUSTMENT BUTTON

Control push button can be mounted left or right.

### STANDARD FEATURES

- Laminate Tops are available in any standard Wilsonart, Nevamar, Formica, Arborite or Pionite matte Finish.
- For other laminates please contact the factory.
- Veneers and hardwood edge stains are standard in Maple, Mahogany, Cherry, Oak, Walnut, Pecan and Chocolate, or Stain-to-Match at no upcharge.
- Standard with leveling glides.
- Bases for electric height adjustable tables available in silver or black. Bases for all other tables available in any Spectone color.
- Standard 29" table height.
- Locking Casters are not self-leveling.
- Base span increases with size of top.

### OPTIONS

For Tap-in Powerway and Dash & Dots modesty panel see accessories at the end of this section. For all other accessories refer to the table accessories price list.

### HOW TO ORDER

1. Select Model
2. Select Base
3. Select Edge Style
4. Select Options
5. Select Top Finish
6. Select Edge Finish
7. Select Base Finish

Example: 2460RE - MRT - PVF -





# MANHATTAN - RECTANGLE COLUMN GENERAL PURPOSE TABLES

BACK TO CONTENTS

MODEL	BASES		TOP SPECIFICATIONS						OPTIONS				MOBILITY	LBS
	Code	Qty.	For Laminate Top			For Veneer Top			FLIP TOP	FOLD	BAR HEIGHT	ELECTRIC HEIGHT	CASTERS	
			SE	HF	HBV	HF2	HF	HF2	Add	Add	Add	Add	Add	
			PVF	HB	HBVR	HB2	HB	HB2						
			PVB			HKNR4	HBV	HKNR4						
			2MM			HKG2	HKG	HKG2						
<i>Rectangle</i>														
30 X 36RE	MRT, MRC	2	813	954	1004	1084	1142	1286	282	-	-	1100 <sup>1</sup>	84	64 <sup>2</sup>
30 X 42RE	MRT, MRC	2	832	1101	1163	1269	1347	1549	282	-	-	1100 <sup>1</sup>	84	74 <sup>2</sup>
30 X 48RE	MRT, MRC	2	832	1101	1163	1269	1347	1549	282	-	-	1100 <sup>1</sup>	84	79 <sup>2</sup>
30 X 54RE	MRT, MRC	2	887	1254	1334	1485	1575	1828	282	-	-	1100 <sup>1</sup>	84	85 <sup>2</sup>
30 X 60RE	MRT, MRC	2	887	1254	1334	1485	1575	1828	282	-	-	1100 <sup>1</sup>	84	90 <sup>2</sup>
30 X 66RE	MRT, MRC	2	1050	1346	1443	1597	1684	1964	282	-	-	1100 <sup>1</sup>	84	95 <sup>2</sup>
30 X 72RE	MRT, MRC	2	1102	1489	1587	1785	1888	2195	282	-	-	1100 <sup>1</sup>	84	100 <sup>2</sup>
30 X 78RE	MRT, MRC	2	1312	1654	1770	2000	2121	2474	282	-	-	-	84	106
30 X 84RE	MRT, MRC	2	1312	1654	1770	2000	2121	2474	282	-	-	-	84	111
30 X 90RE	MRT, MRC	2	1331	1861	2000	2213	2356	2758	282	-	-	-	84	116
30 X 96RE	MRT, MRC	2	1331	1861	2000	2213	2356	2758	282	-	-	-	84	121

<sup>1</sup> Electric Height Adjustable available with T-base in Silver or Black only. Optional casters can be added. Flip top, fold options not available. 18" height range from 24" to 42" on a table with leveling glides, and from 26" to 44" on tables specified with casters. Electrical cord is 11ft long.

<sup>2</sup> For Electric Height Adjustable table add 18 lbs per table.



MRT



MRC



ELECTRIC HEIGHT ADJUSTABLE



HEIGHT ADJUSTMENT BUTTON

Control push button can be mounted left or right.

### STANDARD FEATURES

- Laminate Tops are available in any standard Wilsonart, Nevamar, Formica, Arborite or Pionite matte Finish.
- For other laminates please contact the factory.
- Veneers and hardwood edge stains are standard in Maple, Mahogany, Cherry, Oak, Walnut, Pecan and Chocolate, or Stain-to-Match at no upcharge.
- Standard with leveling glides.
- Bases for electric height adjustable tables available in silver or black. Bases for all other tables available in any Spectone color.
- Standard 29" table height.
- Locking Casters are not self-leveling.
- Base span increases with size of top.

### OPTIONS

For Tap-in Powerway and Dash & Dots modesty panel see accessories at the end of this section. For all other accessories refer to the table accessories price list.

### HOW TO ORDER

1. Select Model
2. Select Base
3. Select Edge Style
4. Select Options
5. Select Top Finish
6. Select Edge Finish
7. Select Base Finish

**Example:** 3060RE - MRT - PVF -  
 MODEL | BASE | EDGE | OPTIONS



# MANHATTAN - RECTANGLE COLUMN GENERAL PURPOSE TABLES

BACK TO CONTENTS

MODEL	BASES		TOP SPECIFICATIONS						OPTIONS				MOBILITY	LBS
	<i>Code</i>	<i>Qty.</i>	<i>For Laminate Top</i>			<i>For Veneer Top</i>			FLIP TOP	FOLD	BAR HEIGHT	ELECTRIC HEIGHT	CASTERS	
			SE	HF	HBV	HF2	HF	HF2						
			PVF	HB	HBVR	HB2	HB	HB2						
			PVB		HBG	HKN4	HBV	HKN4						
			2MM			HKNR4	HBVR	HKNR4		<i>Add</i>	<i>Add</i>	<i>Add</i>	<i>Add</i>	
						HKG2	HKG2	HKG2						
<i>Rectangle</i>														
36 X 42RE	MRT, MRC	2	925	1127	1205	1311	1392	1604	282	-	-	1100 <sup>1</sup>	84	88 <sup>2</sup>
36 X 48RE	MRT, MRC	2	949	1234	1317	1443	1527	1774	282	-	-	1100 <sup>1</sup>	84	88 <sup>2</sup>
36 X 54RE	MRT, MRC	2	1021	1330	1425	1567	1671	1943	282	-	-	1100 <sup>1</sup>	84	90 <sup>2</sup>
36 X 60RE	MRT, MRC	2	1039	1436	1537	1698	1800	2109	282	-	-	1100 <sup>1</sup>	84	95 <sup>2</sup>
36 X 66RE	MRT, MRC	2	1121	1533	1649	1826	1937	2277	282	-	-	1100 <sup>1</sup>	84	94 <sup>2</sup>
36 X 66RE	MRT2	2	1455	1867	1983	2160	2271	2611	282	-	-	-	84	108
36 X 72RE	MRT	2	1157	1587	1698	1954	2077	2445	282	-	-	1100 <sup>1</sup>	84	107 <sup>2</sup>
36 X 72RE	MRT2	2	1491	1921	2032	2288	2411	2779	-	-	-	-	84	115
36 X 78RE	MRT	2	1470	1930	2074	2296	2441	2874	282	-	-	-	84	114
36 X 78RE	MRT2	2	1804	2264	2408	2630	2775	3208	-	-	-	-	84	121
36 X 84RE	MRT	2	1470	1930	2074	2296	2441	2874	282	-	-	-	84	120
36 X 84RE	MRT2	2	1804	2264	2408	2630	2775	3208	-	-	-	-	84	127
36 X 90RE	MRT	2	1475	2131	2296	2555	2721	3202	282	-	-	-	84	126
36 X 90RE	MRT2	2	1809	2465	2630	2889	3055	3536	-	-	-	-	84	133
36 X 96RE	MRT	2	1475	2131	2296	2555	2721	3202	282	-	-	-	84	132
36 X 96RE	MRT2	2	1809	2465	2630	2889	3055	3536	-	-	-	-	84	135
42 X 78RE	MRT2	2	2030	2426	2584	2966	3092	3594	-	-	-	-	84	143
42 X 84RE	MRT2	2	2030	2426	2584	2966	3092	3594	-	-	-	-	84	148

<sup>1</sup> Electric Height Adjustable available with T-base in Silver or Black only. Optional casters can be added. Flip top, fold options not available. 18" height range from 24" to 42" on a table with leveling glides, and from 26" to 44" on tables specified with casters. Electrical cord is 11ft long.

<sup>2</sup> For Electric Height Adjustable table add 18 lbs per table.



MRT



MRC



MRT2



ELECTRIC HEIGHT ADJUSTABLE



HEIGHT ADJUSTMENT BUTTON  
Control push button can be mounted left or right.

### STANDARD FEATURES

- Laminate Tops are available in any standard Wilsonart, Nevamar, Formica, Arborite or Pionite matte Finish.
- For other laminates please contact the factory.
- Veneers and hardwood edge stains are standard in Maple, Mahogany, Cherry, Oak, Walnut, Pecan and Chocolate, or Stain-to-Match at no upcharge.
- Standard with leveling glides.
- Bases for electric height adjustable tables available in silver or black. Bases for all other tables available in any Spectone color.
- Standard 29" table height.
- Locking Casters are not self-leveling.
- Base span increases with size of top.

### OPTIONS

For Tap-in Powerway and Dash & Dots modesty panel see accessories at the end of this section. For all other accessories refer to the table accessories price list.

### HOW TO ORDER

- Select Model
- Select Base
- Select Edge Style
- Select Options
- Select Top Finish
- Select Edge Finish
- Select Base Finish

Example: 3642RE- MRT - PVF -





# MANHATTAN - RECTANGLE COLUMN GENERAL PURPOSE TABLES

BACK TO CONTENTS

MODEL	BASES		TOP SPECIFICATIONS						OPTIONS			MOBILITY	LBS
	Code	Qty.	For Laminate Top			For Veneer Top			FLIP TOP	FOLD	BAR HEIGHT	CASTERS	
			SE PVF PVB 2MM	HF HB	HBV HBVR HBG	HF2 HB2 HKN4 HKNR4 HBG2	HF HB HBV HBG	HF2 HB2 HKN4 HKNR4 HBG2	Add	Add	Add	Add	
<i>Racetrack</i>													
36 X 54RT	MRT	2	1091	1614	1736	1954	2043	2362	282	-	-	84	84
36 X 54RT	MRT2	2	1425	1948	2070	2288	2377	2696	-	-	-	84	90
36 X 60RT	MRT	2	1091	1614	1736	1954	2043	2362	282	-	-	84	89
36 X 60RT	MRT2	2	1425	1948	2070	2288	2377	2696	-	-	-	84	95
36 X 66RT	MRT	2	1239	1785	1917	2150	2356	2754	282	-	-	84	94
36 X 66RT	MRT2	2	1573	2119	2251	2484	2690	3088	-	-	-	84	108
36 X 72RT	MRT	2	1239	1785	1917	2150	2356	2754	282	-	-	84	107
36 X 72RT	MRT2	2	1573	2119	2251	2484	2690	3088	-	-	-	84	115
36 X 78RT	MRT	2	1485	2179	2341	2694	2768	3233	282	-	-	84	114
36 X 78RT	MRT2	2	1819	2513	2675	3028	3102	3567	-	-	-	84	121
36 X 84RT	MRT	2	1485	2179	2341	2694	2768	3233	282	-	-	84	120
36 X 84RT	MRT2	2	1819	2513	2675	3028	3102	3567	-	-	-	84	127
36 X 90RT	MRT	2	1489	2415	2608	3003	3095	3624	282	-	-	84	130
36 X 90RT	MRT2	2	1823	2749	2942	3337	3429	3958	-	-	-	84	133
36 X 96RT	MRT	2	1489	2415	2608	3003	3095	3624	282	-	-	84	130
36 X 96RT	MRT2	2	1823	2749	2942	3337	3429	3958	-	-	-	84	135
42 X 78RT	MRT2	2	2044	2700	2899	3298	3394	3929	-	-	-	84	143
42 X 84RT	MRT2	2	2044	2700	2899	3298	3394	3929	-	-	-	84	148
48 X 78RT	MRT2	2	2047	2982	3207	3560	3781	4389	-	-	-	-	143
48 X 84RT	MRT2	2	2047	2982	3207	3560	3781	4389	-	-	-	-	148



MRT



MRT2

### STANDARD FEATURES

- Laminate Tops are available in any standard Wilsonart, Nevamar, Formica, Arborite or Pionite matte Finish.
- For other laminates please contact the factory.
- Veneers and hardwood edge stains are standard in Maple, Mahogany, Cherry, Oak, Walnut, Pecan and Chocolate or Stain-to-Match at no upcharge.
- Standard with leveling glides.
- Bases available in any Spectone color.
- Standard 29" table height.
- Locking Casters are not self-leveling.
- Base span increases with size of top.

### OPTIONS

For Vertical wire manager, Tap-in Powerway and Dash & Dots modesty panel see accessories at the end of this section. For all other accessories refer to the table accessories price list.

### HOW TO ORDER

1. Select Model
2. Select Base
3. Select Edge Style
4. Select Options
5. Select Top Finish
6. Select Edge Finish
7. Select Base Finish

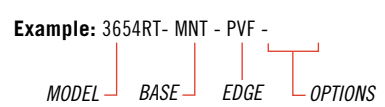



# MANHATTAN - RECTANGLE COLUMN GENERAL PURPOSE TABLES



BACK TO CONTENTS



MODEL	BASES		TOP SPECIFICATIONS						OPTIONS			MOBILITY	LBS
	<i>Code</i>	<i>Qty.</i>	<i>For Laminate Top</i>			<i>For Veneer Top</i>			<b>FLIP TOP</b>	<b>FOLD</b>	<b>BAR HEIGHT</b>	<b>CASTERS</b>	
			<b>SE</b>	<b>HF</b>	<b>HBV</b>	<b>HF2</b>	<b>HF</b>	<b>HF2</b>	<b>Add</b>	<b>Add</b>	<b>Add</b>	<b>Add</b>	
			<b>PVF</b>	<b>HB</b>	<b>HBVR</b>	<b>HB2</b>	<b>HB</b>	<b>HB2</b>					
			<b>PVB</b>		<b>HKG</b>	<b>HKN4</b>	<b>HBV</b>	<b>HKN4</b>					
			<b>2MM</b>			<b>HKNR4</b>	<b>HBVR</b>	<b>HKNR4</b>					
						<b>HKG2</b>	<b>HKG</b>	<b>HKG2</b>					
<i>Bullet</i>													
<b>30 X 54B</b>	<b>MRT</b>	2	999	1520	1628	1819	1875	2191	282	-	-	84	85
<b>30 X 60B</b>	<b>MRT</b>	2	999	1520	1628	1819	1875	2191	282	-	-	84	90
<b>36 X 54B</b>	<b>MRT</b>	2	1112	1987	2142	2421	2459	2856	282	-	-	84	90
<b>36 X 60B</b>	<b>MRT</b>	2	1112	1987	2142	2421	2459	2856	282	-	-	84	95
<b>36 X 66B</b>	<b>MRT</b>	2	1238	2206	2377	2675	2848	3346	282	-	-	84	108
<b>36 X 72B</b>	<b>MRT</b>	2	1238	2206	2377	2675	2848	3346	282	-	-	84	115
<i>Halfmoon</i>													
<b>24 X 48H</b>	<b>MRT</b>	2	802	1272	1390	1533	1649	1917	282	-	-	84	71
<b>30 X 60H</b>	<b>MRT</b>	2	999	1699	1862	2022	2223	2605	282	-	-	84	90
<b>36 X 72H</b>	<b>MRT</b>	2	1238	2194	2405	2602	2929	3445	282	-	-	84	115
<i>Trapezoid</i>													
<b>30 X 60TP</b>	<b>MRT</b>	2	999	1430	1530	1704	1754	2046	282	-	-	84	90
<b>36 X 72TP</b>	<b>MRT</b>	2	1238	1822	1955	2255	2329	2750	282	-	-	84	115
<i>Crescent</i>													
<b>30 X 36RC90</b>	<b>MRT</b>	2	976	1604	1683	1745	1945	2164	-	-	-	84	48
<b>36 X 42RC90</b>	<b>MRT</b>	2	1309	1898	2006	2088	2362	2659	-	-	-	84	61



MRT

### STANDARD FEATURES

- Laminate Tops are available in any standard Wilsonart, Nevamar, Formica, Arborite or Pionite matte Finish.
- For other laminates please contact the factory.
- Veneers and hardwood edge stains are standard in Maple, Mahogany, Cherry, Oak, Walnut, Pecan and Chocolate or Stain-to-Match at no upcharge.
- Standard with leveling glides.
- Bases available in any Spectone color.
- Standard 29" table height.
- Locking Casters are not self-leveling.
- Base span increases with size of top.

### OPTIONS

For Vertical wire manager, Tap-in Powerway and Dash & Dots modesty panel see accessories at the end of this section. For all other accessories refer to the table accessories price list.

### HOW TO ORDER

1. Select Model
2. Select Base
3. Select Edge Style
4. Select Options
5. Select Top Finish
6. Select Edge Finish
7. Select Base Finish

**Example:** 3054B - MNT - PVF -





# MANHATTAN - RECTANGLE COLUMN BOARDROOM TABLES



BACK TO CONTENTS

MODEL	BASES		TOP SPECIFICATIONS						OPTIONS	MOBILITY	LBS
	<i>Code</i>	<i>Qty.</i>	<i>For Laminate Top</i>			<i>For Veneer Top</i>					
			SE PVF PVB 2MM	HF HB	HBV HBVR HBG	HF2 HB2 HKNR4 HBG2	HF HB HBV HBG	HF2 HB2 HKNR4 HBG2			
<i>Rectangle</i>											
42 X 96RE	MRT2	2	2078	2911	3137	3364	3702	4354			175
48 X 96RE	MRT2	2	2078	2911	3137	3364	3702	4354			179
48 X 120RE	MRT2	3	2778	3853	4108	4657	4739	5500			228
48 X 144RE	MRT2	3	3141	4683	5018	5541	5417	6334			262
48 X 168RE	MRT2	3	3602	5154	5537	6267	6098	7164			296
60 X 120RE	MRT2	3	3221	4829	5180	5723	5594	6549			270
60 X 144RE	MRT2	3	3632	5561	5982	6632	6479	7625			312
60 X 168RE	MRT2	3	4043	6294	6782	7544	7363	8700			354
<i>Racetrack</i>											
42 X 96RT	MRT2	2	2098	3039	3268	3820	4210	4905			175
48 X 96RT	MRT2	2	2098	3039	3268	3820	4210	4905			179
48 X 120RT	MRT2	3	2802	4296	4595	5356	5324	6136			228
48 X 144RT	MRT2	3	3168	5029	5395	6339	6120	7104			262
48 X 168RT	MRT2	3	3632	5655	6084	7131	6927	8068			296
60 X 120RT	MRT2	3	3211	5078	5449	6405	6362	7381			270
60 X 144RT	MRT2	3	3668	5993	6453	7634	7359	8589			312
60 X 168RT	MRT2	3	4249	6779	7314	8619	8367	9793			354



MRT2

### STANDARD FEATURES

- Laminate Tops are available in any standard Wilsonart, Nevamar, Formica, Arborite or Pionite matte Finish.
- For other laminates please contact the factory.
- Veneers and hardwood edge stains are standard in Maple, Mahogany, Cherry, Oak, Walnut, Pecan and Chocolate or Stain-to-Match at no upcharge.
- Standard with leveling glides.
- Bases available in any Spectone color.
- Standard 29" table height.
- Locking Casters are not self-leveling.
- Base span increases with size of top.

### OPTIONS

For Tap-in Powerway and Dash & Dots modesty panel see accessories at the end of this section.  
For all other accessories refer to the table accessories price list.

### HOW TO ORDER

1. Select Model
2. Select Base
3. Select Edge Style
4. Select Options
5. Select Top Finish
6. Select Edge Finish
7. Select Base Finish

**Example:** 4296RE - MNT2 - PVF -





# MANHATTAN - RECTANGLE COLUMN BOARDROOM TABLES



BACK TO CONTENTS

MODEL	BASES		TOP SPECIFICATIONS						OPTIONS	MOBILITY	LBS
	Code	Qty.	SE PVF PVB 2MM	For Laminate Top HF HB	HBV HBVR HBG	HF2 HB2 HKN4 HKNR4 HBG2	For Veneer Top HF HB HBV HBG	HF2 HB2 HKN4 HKNR4 HBG2			
<i>Boatshape</i>											
42 X 96BT	MRT2	2	2098	3681	3976	4280	4711	5090		175	
48 X 96BT	MRT2	2	2098	3681	3976	4280	4711	5090		179	
48 X 120BT	MRT2	3	2802	5000	5366	5751	5916	6353		228	
48 X 144BT	MRT2	3	3168	5733	6169	6632	7216	7614		262	
48 X 168BT	MRT2	3	3632	6434	6941	7476	7749	8364		296	
60 X 120 BT	MRT2	3	3211	5956	6416	6897	7104	7648		270	
60 X 144BT	MRT2	3	3668	6875	7420	7999	8727	9226		312	
60 X 168BT	MRT2	3	4249	7752	8385	9054	9392	10163		354	
<i>Boat Arc</i>											
42 X 96BTA	MRT2	2	2258	4186	4482	4788	5216	5596		175	
48 X 96BTA	MRT2	2	2258	4186	4482	4788	5216	5596		179	
48 X 120BTA	MRT2	3	2963	5507	5873	6259	6423	6858		228	
48 X 144BTA	MRT2	3	3329	6238	6677	7140	7721	8121		262	
48 X 168BTA	MRT2	3	3794	6941	7449	7984	8254	8872		296	
60 X 120BTA	MRT2	3	3413	6592	7048	7531	7736	8280		270	
60 X 144BTA	MRT2	3	3868	7506	8054	8632	9360	9857		312	
60 X 168BTA	MRT2	3	4449	8385	9018	9685	10027	10798		354	



MRT2

### STANDARD FEATURES

- Laminate Tops are available in any standard Wilsonart, Nevamar, Formica, Arborite or Pionite matte Finish.
- For other laminates please contact the factory.
- Veneers and hardwood edge stains are standard in Maple, Mahogany, Cherry, Oak, Walnut, Pecan and Chocolate or Stain-to-Match at no upcharge.
- Standard with leveling glides.
- Bases available in any Spectone color.
- Standard 29" table height.
- Locking Casters are not self-leveling.
- Base span increases with size of top.

### OPTIONS

For Tap-in Powerway and Dash & Dots modesty panel see accessories at the end of this section.

For all other accessories refer to the table accessories price list.

### HOW TO ORDER

1. Select Model
2. Select Base
3. Select Edge Style
4. Select Options
5. Select Top Finish
6. Select Edge Finish
7. Select Base Finish

**Example:** 4296BT - MNT2 - PVF -





# MANHATTAN WITH FOOTRING - FREESTANDING GENERAL PURPOSE TABLES



BACK TO CONTENTS



MODEL	BASES		TOP SPECIFICATIONS						LBS
	Code	Qty.	For Laminate Top			For Veneer Top			
			SE PVF PVB 2MM	HF HB	HBV HBVR HBG	HF2 HB2 HKN4 HKNR4 HBG2	HF HB HBV HBG	HF2 HB2 HKN4 HKNR4 HBG2	
<i>Round</i>									
48D	48D-MNTRVWM-FR <sup>1</sup>	3	3157	3865	3989	4109	4543	4911	124
60D	60D-MNTRVWM-FR <sup>1</sup>	3	3466	4651	4856	5011	5639	6226	176
<i>Rectangle</i>									
48 X 66RE	4866RE-MNTRVWM-FR	4	4301	4888	5045	5396	5454	5916	187
48 X 72RE	4872RE-MNTRVWM-FR	4	4340	4952	5116	5482	5542	6023	196
48 X 84RE	4884RE-MNTRVWM-FR <sup>1</sup>	4	4602	5227	5420	5793	5906	6477	213
48 X 96RE	4896RE-MNTRVWM-FR <sup>1</sup>	4	4649	5482	5708	5935	6273	6925	274
60 X 66RE	6066RE-MNTRVWM-FR	4	4602	5227	5420	5793	5906	6477	210
60 X 72RE	6072RE-MNTRVWM-FR	4	4649	5482	5708	5935	6273	6925	221
60 X 84RE	6084RE-MNTRVWM-FR <sup>1</sup>	4	4844	5801	6062	6322	6712	7462	242
60 X 96RE	6096RE-MNTRVWM-FR <sup>1</sup>	4	4959	6034	6289	6838	6920	7681	307
<i>Racetrack</i>									
48 X 72RT	4872RT-MNTRVWM-FR	4	4532	5413	5604	5910	6095	6624	180
48 X 84RT	4884RT-MNTRVWM-FR <sup>1</sup>	4	4795	5730	5955	6308	6529	7137	197
48 X 96RT	4896RT-MNTRVWM-FR <sup>1</sup>	4	4846	5787	6016	6568	6958	7653	258
48 X 120RT	48120RT-MNTRVWM-FR	6	6315	7809	8108	8869	8837	9649	293
60 X 72RT	6072RT-MNTRVWM-FR	4	4846	5787	6016	6568	6958	7653	197
60 X 84RT	6084RT-MNTRVWM-FR <sup>1</sup>	4	4977	6014	6265	6872	7301	8065	218
60 X 96RT	6096RT-MNTRVWM-FR <sup>1</sup>	4	5160	6654	6953	7714	7682	8494	283
60 X 120RT	60120RT-MNTRVWM-FR	6	6724	8591	8962	9918	9875	10894	325

<sup>1</sup> Features an extra footring support.

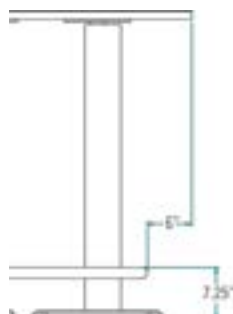

Footring location.

### STANDARD FEATURES

- Laminate Tops are available in any standard Wilsonart, Nevamar, Formica, Arborite or Pionite matte Finish.
- For other laminates please contact the factory.
- Veneers and hardwood edge stains are standard in Maple, Mahogany, Cherry, Oak, Walnut, Pecan and Chocolate or Stain-to-Match at no upcharge.
- Cove and Villa power options available - refer to the table accessories price list.
- Standard with leveling glides.
- Base available in any Spectone color.
- Standard 42" table height.
- Footring is inset 6" from table edge, and available in chrome only.
- Rectangular vertical wire manager comes standard on all table legs.

### HOW TO ORDER

1. Select Model
2. Select Edge Style
3. Select Top Finish
4. Select Edge Finish
5. Select Base Finish

Example: 6066RE - MRTFR - PVF







# MANHATTAN WITH FOOTRING - WALL ADJACENT GENERAL PURPOSE TABLES



BACK TO CONTENTS

MODEL	BASES		TOP SPECIFICATIONS						LBS
	Code	Qty.	For Laminate Top			For Veneer Top			
			SE PVF 2MM	HF HB	HBV HBVR HBG	HF2 HB2 HKNR4 HBG2	HF HB HBV HBG	HF2 HB2 HKNR4 HBG2	
<i>Rectangle</i>									
48 X 66RE	4866RE-MNTRVWM-FRWA	4	3941	4528	4685	5036	5094	5556	184
48 X 72RE	4872RE-MNTRVWM-FRWA	4	3980	4592	4756	5122	5182	5663	193
48 X 84RE	4884RE-MNTRVWM-FRWA <sup>1</sup>	4	4242	4867	5060	5433	5546	6117	210
48 X 96RE	4896RE-MNTRVWM-FRWA <sup>1</sup>	4	4289	5122	5348	5575	5913	6565	271
60 X 66RE	6066RE-MNTRVWM-FRWA	4	4242	4867	5060	5433	5546	6117	206
60 X 72RE	6072RE-MNTRVWM-FRWA	4	4289	5122	5348	5575	5913	6565	217
60 X 84RE	6084RE-MNTRVWM-FRWA <sup>1</sup>	4	4484	5441	5702	5962	6352	7102	238
60 X 96RE	6096RE-MNTRVWM-FRWA <sup>1</sup>	4	4599	5674	5929	6478	6560	7321	302
<i>Bullet</i>									
42 X 66B	4266B-MNTRVWM-FRWA	4	4165	4740	4947	5223	5293	5754	167
42 X 72B	4272B-MNTRVWM-FRWA	4	4287	4927	5157	5464	5541	6053	175
42 X 84B	4284B-MNTRVWM-FRWA <sup>1</sup>	4	4387	5085	5337	5671	5755	6313	190
42 X 96B	4296B-MNTRVWM-FRWA <sup>1</sup>	4	4588	5402	5695	6085	6183	6834	249
48 X 66B	4866B-MNTRVWM-FRWA	4	4287	4927	5157	5464	5541	6053	176
48 X 72B	4872B-MNTRVWM-FRWA	4	4387	5085	5337	5671	5755	6313	185
48 X 84B	4884B-MNTRVWM-FRWA <sup>1</sup>	4	4588	5402	5695	6085	6183	6834	202
48 X 96B	4896B-MNTRVWM-FRWA <sup>1</sup>	4	4788	5718	6053	6499	6611	7355	263
60 X 66B	6066B-MNTRVWM-FRWA	4	4448	5181	5445	5797	5884	6471	194
60 X 72B	6072B-MNTRVWM-FRWA	4	4562	5362	5650	6033	6129	6769	205
60 X 84B	6084B-MNTRVWM-FRWA <sup>1</sup>	4	4792	5724	6060	6508	6620	7365	226
60 X 96B	6096B-MNTRVWM-FRWA <sup>1</sup>	4	5020	6086	6471	6982	7110	7963	290



Shown with optional power module.

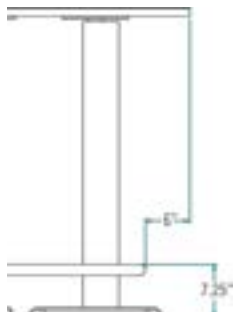

Footring location.

<sup>1</sup> Features an extra footring support.

### STANDARD FEATURES

- Laminate Tops are available in any standard Wilsonart, Nevamar, Formica, Arborite or Pionite matte Finish.
- For other laminates please contact the factory.
- Veneers and hardwood edge stains are standard in Maple, Mahogany, Cherry, Oak, Walnut, Pecan and Chocolate or Stain-to-Match at no upcharge.
- Cove and Villa power options available - refer to the table accessories price list.
- Standard with leveling glides.
- Base available in any Spectone color.
- Standard 42" table height.
- Footring is inset 6" from table edge, and available in chrome only.
- Rectangular vertical wire manager comes standard on all table legs.





### HOW TO ORDER

1. Select Model
2. Select Edge Style
3. Select Top Finish
4. Select Edge Finish
5. Select Base Finish

Example: 6066B - MRTFRWA - PVF

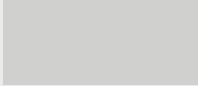

## MANHATTAN ACCESSORIES

MODEL	Code	Price	
<b>VERTICAL WIRE MANAGER*</b> Attaches to single column T or C leg. Can be used in conjunction with Flip6. If ordering one vertical wire manager per table, specify right or left handed while sitting at the table. <b>Cannot be used with Rectangular Column*</b>	<b>VWM</b>	172	
	<b>RVWM</b>	172	
<b>TAP-IN POWERWAY</b> Can be used with 2MM and HF and HBV edges only. Comes standard with both left and right end caps.	<b>TPWT-42</b>	339	
	<b>TPWT-48</b>	339	
	<b>TPWT-54</b>	339	
	<b>TPWT-60</b>	391	
	<b>TPWT-66</b>	391	
	<b>TPWT-72</b>	443	
<b>PERFORATED MODESTY PANEL - DASH &amp; DOTS</b> When specified on a table with vertical wire managers, modesty panel attaches to the leg. If table is ordered without vertical wire manager, modesty panel attaches to the underside of the top. For additional perforated modesty panel options, see accessories in the main price list. Can not be used on a flip top without vertical wire managers.	<b>PMPDD-42</b>	258	
	<b>PMPDD-48</b>	258	
	<b>PMPDD-54</b>	258	
	<b>PMPDD-60</b>	309	
	<b>PMPDD-66</b>	309	
	<b>PMPDD-72</b>	361	
<b>RESIN MODESTY PANEL</b> When specified on a table with vertical wire managers, modesty panel attaches to the leg. If table is ordered without vertical wire manager, modesty panel attaches to the underside of the top. Eco-Resin modesty panel is available in Nickel.	<b>PMP-RESIN42</b>	323	
	<b>PMP-RESIN48</b>	323	
	<b>PMP-RESIN54</b>	323	
	<b>PMP-RESIN60</b>	323	
	<b>PMP-RESIN66</b>	323	
	<b>PMP-RESIN70</b>	323	
<b>CABLE MANAGER FOR HEIGHT ADJUSTABLE TABLES</b> Cable management, spiral tube. Black. Plastic. 6" base diameter. Spiral 3-3/8" dia. Maximum height 84".	<b>CMHA</b>	260	

# MIDWAY & COMPANION TABLES



MIDWAY



COMPANION

PLACING AN ORDER IS EASY

## PRODUCT CODE

**36 D - MIDWAY**

**Size**

Width x Length or  
Diameter

**Top Shape**

D : Round  
SQ : Square  
RE : Rectangle

**Series**

MIDWAY : Midway  
COMPANION : Companion



## FINISHES

### LAMINATE



Select laminate from our virtually unlimited laminate options

### VENEER

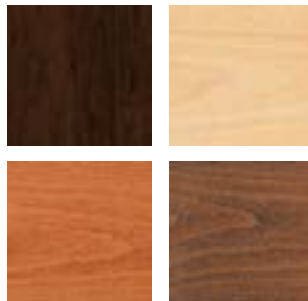

Select from one of our 7 standard wood stains or stain-to-match at no upcharge

### BASE



Select from one of our 76 standard Spectone colors

### EDGE



2MM      PVC      Hard Wood

Check out our website for a complete list of edge profiles.



# MIDWAY AND COMPANION OCCASIONAL AND LOUNGE TABLES

BACK TO CONTENTS

MODEL	BASES		TOP SPECIFICATIONS						OPTIONS	LBS
	Code	Qty.	For Laminate Top			For Veneer Top				
			SE	HF	HBV	HF2	HF	HF2		
			PVF	HB	HBG	HKN4	HB	HKN4		
			PVB				HBV			
			2MM				HBG			
<i>Round</i>										
24D	MIDWAY	1	596	925	959	1059	1112	1215		27
	COMPANION	1	728	1057	1091	1191	1244	1347		27
30D	MIDWAY	1	691	1015	1059	1258	1207	1358		37
	COMPANION	1	823	1147	1191	1390	1339	1490		37
36D	MIDWAY	1	781	1252	1334	1497	1547	1756		48
	COMPANION	1	913	1384	1466	1629	1679	1888		48
<i>Square</i>										
18 x 18SQ	MIDWAY	1	613	803	837	899	944	1098		20
	COMPANION	1	745	935	969	1031	1076	1230		20
24 x 24SQ	MIDWAY	1	624	803	837	899	944	1098		27
	COMPANION	1	756	935	969	1031	1076	1230		27
30 x 30SQ	MIDWAY	1	722	852	899	1063	1004	1215		37
	COMPANION	1	854	984	1031	1195	1136	1347		37
36 x 36SQ	MIDWAY	1	799	1003	1059	1252	1258	1442		48
	COMPANION	1	931	1135	1191	1384	1390	1574		48
<i>Rectangle</i>										
24 x 48RE	MIDWAY	1	772	968	1019	1111	1167	1333		44
	COMPANION	1	904	1100	1151	1243	1299	1465		44



24D-MIDWAY

24SQ-MIDWAY

24D-COMPANION

24SQ-COMPANION

2448RE-COMPANION

**STANDARD FEATURES**

- Laminate tops available in any standard Wilsonart, Nevamar, Formica, Arborite or Pionite matte finish offerings. For other laminate please contact the factory for pricing.
- Veneers and hardwood edges are standard in Oak, Maple, Cherry, Pecan, Walnut, Mahogany and Chocolate.
- 7 veneer and hardwood edge stains are standard. Stain-to-match available at no upcharge.
- Standard table height 18".
- All bases are standard with floor leveling glides.

**OPTIONS**

- Custom heights available.

**HOW TO ORDER**

1. Select Model
2. Select Base
3. Select Edge Style
4. Select Top Finish
5. Select Edge Finish
6. Select Base Finish

**Example:** 24D - MIDWAY - PVF



# POST LEGS TABLES

BACK TO CONTENTS



## PLACING AN ORDER IS EASY

### PRODUCT CODE

**2430 RE P LO**

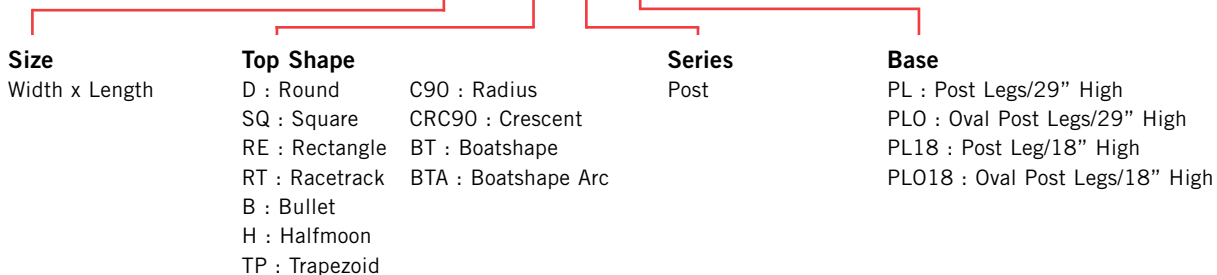

### OPTIONS

#### CASTERS



#### FOLDING



### FINISHES

#### LAMINATE



Select laminate from our virtually unlimited laminate options

#### VENEER

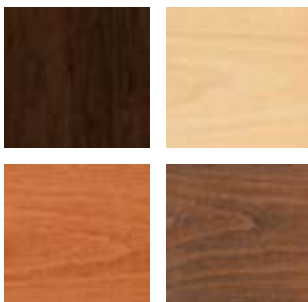

Select from one of our 7 standard wood stains or stain-to-match at no upcharge

#### BASE



Select from one of our 76 standard Spectone colors

#### EDGE



2MM      PVC      Hard Wood

Check out our website for a complete list of edge profiles.



# POST LEGS OCCASIONAL AND LOUNGE TABLES

BACK TO CONTENTS



MODEL	BASES		TOP SPECIFICATIONS						OPTIONS	LBS
	Code	Qty.	For Laminate Top			For Veneer Top				
			SE	HF	HBV	HF2	HF	HF2		
			PVF	HB	HBVR	HB2	HB	HB2		
			PVB		HGG	HKN4	HBV	HKN4		
			2MM			HKNR4	HBVR	HKNR4		
						HGG2	HGG	HGG2		
<i>Round</i>										
24D	PL18	4	596	925	959	1059	1112	1215		37
	PL018	4	632	961	995	1095	1148	1251		37
30D	PL18	4	691	1015	1059	1258	1207	1358		47
	PL018	4	727	1051	1095	1294	1243	1394		47
36D	PL18	4	781	1252	1334	1497	1547	1756		58
	PL018	4	817	1288	1370	1533	1583	1792		58
42D	PL18	4	1042	1569	1683	1925	1950	2236		76
	PL018	4	1078	1605	1719	1961	1986	2272		76
<i>Square</i>										
18 x 18SQ	PL18	4	613	803	837	899	944	1098		34
	PL018	4	649	839	873	935	980	1134		34
24 x 24SQ	PL18	4	624	803	837	899	944	1098		41
	PL018	4	660	839	873	935	980	1134		41
30 x 30SQ	PL18	4	722	852	899	1063	1004	1215		51
	PL018	4	758	888	935	1099	1040	1251		51
36 x 36SQ	PL18	4	799	1003	1059	1252	1258	1442		62
	PL018	4	835	1039	1095	1288	1294	1478		62



### STANDARD FEATURES

- Laminate tops available in any standard Wilsonart, Nevamar, Formica, Arborite or Pionite matte finish offerings. For other laminate please contact the factory for pricing.
- Veneers and hardwood edges are standard in Oak, Maple, Cherry, Pecan, Walnut, Mahogany and Chocolate.
- 7 veneer and hardwood edge stains are standard. Stain-to-match available at no upcharge.
- Standard table height 18".
- All bases are standard with floor leveling glides.

### OPTIONS

- Custom heights available.

### HOW TO ORDER

1. Select Model
2. Select Base
3. Select Edge Style
4. Select Top Finish
5. Select Edge Finish
6. Select Base Finish

**Example:** 24D - PL18 - PVF





# POST LEGS OCCASIONAL AND LOUNGE TABLES

BACK TO CONTENTS

MODEL	BASES		TOP SPECIFICATIONS						OPTIONS	LBS
	<i>Code</i>	<i>Qty.</i>		<i>For Laminate Top</i>			<i>For Veneer Top</i>			
			SE	HF	HBV	HF2	HF	HF2		
			PVF	HB	HBVR	HB2	HB	HB2		
			PVB		HBG	HKN4	HBV	HKN4		
			2MM			HKNR4	HBVR	HKNR4		
						HBG2	HBG	HBG2		
<i>Rectangle</i>										
24 x 36RE	PL18	4	711	833	877	940	989	1108	50	
	PL018	4	747	869	913	976	1025	1144	50	
24 x 42RE	PL18	4	772	968	1019	1111	1167	1333	58	
	PL018	4	808	1004	1055	1147	1203	1369	58	
24 x 48RE	PL18	4	772	968	1019	1111	1167	1333	58	
	PL018	4	808	1004	1055	1147	1203	1369	58	
30 x 36RE	PL18	4	799	940	990	1070	1128	1272	56	
	PL018	4	835	976	1026	1106	1164	1308	56	
30 x 42RE	PL18	4	818	1087	1149	1255	1333	1535	66	
	PL018	4	854	1123	1185	1291	1369	1571	66	
30 x 48RE	PL18	4	818	1087	1149	1255	1333	1535	66	
	PL018	4	854	1123	1185	1291	1369	1571	66	



2448RE-PL18

### STANDARD FEATURES

- Laminate tops available in any standard Wilsonart, Nevamar, Formica, Arborite or Pionite matte finish offerings. For other laminate please contact the factory for pricing.
- Veneers and hardwood edges are standard in Oak, Maple, Cherry, Pecan, Walnut, Mahogany and Chocolate.
- 7 veneer and hardwood edge stains are standard. Stain-to-match available at no upcharge.
- Standard table height 18".
- All bases are standard with floor leveling glides.

### OPTIONS

- Custom heights available.

### HOW TO ORDER

1. Select Model
2. Select Base
3. Select Edge Style
4. Select Top Finish
5. Select Edge Finish
6. Select Base Finish

**Example:** 2448RE - PL18 - PVF  
MODEL     BASE     EDGE



# POST LEGS GENERAL PURPOSE TABLES

BACK TO CONTENTS

MODEL	BASES		TOP SPECIFICATIONS						OPTIONS				LBS
	Code	Qty.	For Laminate Top			For Veneer Top			FLIP TOP (FT)	FOLD (FL)	CASTERS (LC)	WHEELS (WB)	
			SE	HF	HBV	HF2	HF	HF2					
			PVF	HB	HBVR	HB2	HB	HB2					
			PVB		HGG	HKN4	HBV	HKN4					
			2MM			HKNR4	HBVR	HKNR4					
						HGG2	HGG	HGG2					
<i>Round</i>													
24D	PL	4	596	925	959	1059	1112	1215	-	-	84	-	41
	PLO	4	632	961	995	1095	1148	1251	-	-	84	-	37
30D	PL	4	691	1015	1059	1258	1207	1358	-	-	84	-	51
	PLO	4	727	1051	1095	1294	1243	1394	-	-	84	-	47
36D	PL	4	781	1252	1334	1497	1547	1756	-	-	84	-	62
	PLO	4	817	1288	1370	1533	1583	1792	-	-	84	-	58
42D	PL	4	1042	1569	1683	1925	1950	2236	-	-	84	-	76
	PLO	4	1078	1605	1719	1961	1986	2272	-	-	84	-	72
48D	PL	4	1063	1771	1895	2015	2449	2817	-	-	84	-	92
	PLO	4	1099	1807	1931	2051	2485	2853	-	-	84	-	88
54D	PL	4	1329	2372	2564	2748	2964	3436	-	547	84	-	110
	PLO	4	1365	2408	2600	2784	3000	3472	-	-	84	-	106
60D	PL	4	1372	2557	2762	2917	3545	4132	-	547	84	-	129
	PLO	4	1408	2593	2798	2953	3581	4168	-	-	84	-	125

\*Folding tables available with PVC Bullnose edge only.



2448RE-PL



2448RE-PLO

### STANDARD FEATURES

- Laminate tops available in any standard Wilsonart, Nevamar, Formica, Arborite or Pionite matte finish offerings. For other laminate please contact the factory for pricing.
- Veneers and hardwood edges are standard in Oak, Maple, Cherry, Pecan, Walnut, Mahogany and Chocolate.
- 7 veneer and hardwood edge stains are standard. Stain-to-match available at no upcharge.
- Standard table height 29".
- All bases are standard with floor leveling glides.

### OPTIONS

- Custom heights available.

### HOW TO ORDER

1. Select Model
2. Select Base
3. Select Edge Style
4. Select Options
5. Select Top Finish
6. Select Edge Finish
7. Select Base Finish

Example: 24D - PL - PVF -







# POST LEGS GENERAL PURPOSE TABLES

BACK TO CONTENTS

MODEL	BASES		TOP SPECIFICATIONS						OPTIONS				LBS
	Code	Qty.	For Laminate Top			For Veneer Top			FLIP TOP (FT)	FOLD (FL)	CASTERS (LC)	WHEELS (WB)	
			SE PVF PVB 2MM	HF HB	HBV HBVR HBG	HF2 HB2 HKNR4 HBG2	HF HB HBV HBG	HF2 HB2 HKNR4 HBG2					
<i>Square</i>													
24 x 24SQ	PL	4	624	803	837	899	944	1098	-	-	84	-	41
	PLO	4	660	839	873	935	980	1134	-	-	84	-	37
30 x 30SQ	PL	4	722	852	899	1063	1004	1215	-	-	84	-	51
	PLO	4	758	888	935	1099	1040	1251	-	-	84	-	47
36 x 36SQ	PL	4	799	1003	1059	1252	1258	1442	-	-	84	-	58
	PLO	4	835	1039	1095	1288	1294	1478	-	-	84	-	58
42 x 42SQ	PL	4	1056	1351	1442	1533	1596	1847	-	547	84	-	76
	PLO	4	1092	1387	1478	1569	1632	1883	-	-	84	-	72
48 x 48SQ	PL	4	1197	1456	1552	1594	1941	2263	-	547	84	-	92
	PLO	4	1233	1492	1588	1630	1977	2299	-	-	84	-	88
54 x 54SQ	PL	5	1439	2011	2161	2335	2430	2848	-	683	84	-	116
	PLO	5	1484	2056	2206	2380	2475	2893	-	-	84	-	111
60 x 60SQ	PL	5	1467	2108	2267	2443	2868	3374	-	683	84	-	135
	PLO	5	1512	2153	2312	2488	2913	3419	-	-	84	-	130

\*Folding tables available with PVC Bullnose edge only.



2448RE-PL



2448RE-PLO

### STANDARD FEATURES

- Laminate tops available in any standard Wilsonart, Nevamar, Formica, Arborite or Pionite matte finish offerings. For other laminate please contact the factory for pricing.
- Veneers and hardwood edges are standard in Oak, Maple, Cherry, Pecan, Walnut, Mahogany and Chocolate.
- 7 veneer and hardwood edge stains are standard. Stain-to-match available at no upcharge.
- Standard table height 29".
- All bases are standard with floor leveling glides.

### OPTIONS

- Custom heights available.

### HOW TO ORDER

1. Select Model
2. Select Base
3. Select Edge Style
4. Select Options
5. Select Top Finish
6. Select Edge Finish
7. Select Base Finish

**Example:** 2424SQ - PL - PVF -





# POST LEGS GENERAL PURPOSE TABLES

BACK TO CONTENTS



MODEL	BASES		TOP SPECIFICATIONS						OPTIONS				LBS
	Code	Qty.	For Laminate Top			For Veneer Top			FLIP TOP (FT)	FOLD (FL)	CASTERS (LC)	WHEELS (WB)	
			SE	HF	HBV	HF2	HF	HF2					
			PVF	HB	HBVR	HB2	HB	HB2					
			PVB		HGG	HKN4	HBV	HKN4					
			2MM			HKNR4	HBVR	HKNR4					
						HGG2	HGG	HGG2					
<i>Rectangle</i>													
24 x 30RE	PL	4	711	833	877	940	989	1108	-	-	84	-	50
	PLO	4	747	869	913	976	1025	1144	-	-	84	-	46
24 x 36RE	PL	4	711	833	877	940	989	1108	-	-	84	-	50
	PLO	4	747	869	913	976	1025	1144	-	-	84	-	46
24 x 42RE	PL	4	772	968	1019	1111	1167	1333	-	-	84	-	58
	PLO	4	808	1004	1055	1147	1203	1369	-	-	84	-	54
24 x 48RE	PL	4	772	968	1019	1111	1167	1333	-	-	84	-	58
	PLO	4	808	1004	1055	1147	1203	1369	-	-	84	-	54
24 x 54RE	PL	4	827	1113	1178	1284	1363	1566	-	-	84	-	66
	PLO	4	863	1149	1214	1320	1399	1602	-	-	84	-	62
24 x 60RE	PL	4	827	1113	1178	1284	1363	1566	-	547	84	-	66
	PLO	4	863	1149	1214	1320	1399	1602	-	-	84	-	62
24 x 66RE	PL	4	963	1307	1387	1516	1600	1849	-	-	84	-	81
	PLO	4	999	1343	1423	1552	1636	1885	-	-	84	-	76
24 x 72RE	PL	5	1071	1415	1495	1624	1708	1957	-	-	105	-	81
	PLO	5	1116	1460	1540	1669	1753	2002	-	-	105	-	76



2448RE-PL



2448RE-PLO

### STANDARD FEATURES

- Laminate tops available in any standard Wilsonart, Nevamar, Formica, Arborite or Pionite matte finish offerings. For other laminate please contact the factory for pricing.
- Veneers and hardwood edges are standard in Oak, Maple, Cherry, Pecan, Walnut, Mahogany and Chocolate.
- 7 veneer and hardwood edge stains are standard. Stain-to-match available at no upcharge.
- Standard table height 29".
- All bases are standard with floor leveling glides.

### OPTIONS

- Custom heights available.

### HOW TO ORDER

1. Select Model
2. Select Base
3. Select Edge Style
4. Select Options
5. Select Top Finish
6. Select Edge Finish
7. Select Base Finish

**Example:** 2430RE - PL - PVF -





# POST LEGS GENERAL PURPOSE TABLES

BACK TO CONTENTS



MODEL	BASES		TOP SPECIFICATIONS						OPTIONS				LBS
	Code	Qty.	For Laminate Top			For Veneer Top			FLIP TOP (FT)	FOLD (FL)	CASTERS (LC)	WHEELS (WB)	
			SE PVF PVB 2MM	HF HB	HBV HBVR HBG	HF2 HB2 HKNR4 HBG2	HF HB HBV HBG	HF2 HB2 HKNR4 HBG2					
<i>Rectangle</i>													
30 x 36RE	PL	4	799	940	990	1070	1128	1272	-	-	84	-	56
	PLO	4	835	976	1026	1106	1164	1308	-	-	84	-	52
30 x 42RE	PL	4	818	1087	1149	1255	1333	1535	-	-	84	-	66
	PLO	4	854	1123	1185	1291	1369	1571	-	-	84	-	62
30 x 48RE	PL	4	818	1087	1149	1255	1333	1535	-	-	84	-	66
	PLO	4	854	1123	1185	1291	1369	1571	-	-	84	-	62
30 x 54RE	PL	4	873	1240	1320	1471	1561	1814	-	-	84	-	77
	PLO	4	909	1276	1356	1507	1597	1850	-	-	84	-	73
30 x 60RE	PL	4	873	1240	1320	1471	1561	1814	-	547	84	-	77
	PLO	4	909	1276	1356	1507	1597	1850	-	-	84	-	73
30 x 66RE	PL	4	1036	1332	1429	1583	1670	1950	-	683	84	-	93
	PLO	4	1072	1368	1465	1619	1706	1986	-	-	84	-	88
30 x 72RE	PL	5	1196	1583	1681	1879	1982	2289	-	683	105	-	93
	PLO	5	1241	1628	1726	1924	2027	2334	-	-	105	-	88
30 x 78RE	PL	5	1406	1748	1864	2094	2215	2568	-	683	105	-	104
	PLO	5	1451	1793	1909	2139	2260	2613	-	-	105	-	99
30 x 84RE	PL	5	1406	1748	1864	2094	2215	2568	-	683	105	-	104
	PLO	5	1451	1793	1909	2139	2260	2613	-	-	105	-	99
30 x 90RE	PL	5	1425	1955	2094	2307	2450	2852	-	683	105	-	114
	PLO	5	1470	2000	2139	2352	2495	2897	-	-	105	-	109
30 x 96RE	PL	6	1533	2063	2202	2415	2558	2960	-	683	126	-	114
	PLO	6	1587	2117	2256	2469	2612	3014	-	-	126	-	109

\*Folding tables available with PVC Bullnose edge only.



2448RE-PL



2448RE-PLO

### STANDARD FEATURES

- Laminate tops available in any standard Wilsonart, Nevamar, Formica, Arborite or Pionite matte finish offerings. For other laminate please contact the factory for pricing.
- Veneers and hardwood edges are standard in Oak, Maple, Cherry, Pecan, Walnut, Mahogany and Chocolate.
- 7 veneer and hardwood edge stains are standard. Stain-to-match available at no upcharge.
- Standard table height 29".
- All bases are standard with floor leveling glides.

### OPTIONS

- Custom heights available.

### HOW TO ORDER

1. Select Model
2. Select Base
3. Select Edge Style
4. Select Options
5. Select Top Finish
6. Select Edge Finish
7. Select Base Finish

Example: 3036RE - PL - PVF -





# POST LEGS GENERAL PURPOSE TABLES

BACK TO CONTENTS



MODEL	BASES		TOP SPECIFICATIONS						OPTIONS				LBS
	Code	Qty.	For Laminate Top			For Veneer Top			FLIP TOP (FT)	FOLD (FL)	CASTERS (LC)	WHEELS (WB)	
			SE PVF PVB 2MM	HF HB	HBV HBVR HBG	HF2 HB2 HKNR4 HBG2	HF HB HBV HBG	HF2 HB2 HKNR4 HBG2					
<i>Rectangle</i>													
36 x 42RE	PL	4	911	1113	1191	1297	1378	1590	-	-	84	-	75
	PLO	4	947	1149	1227	1333	1414	1626	-	-	84	-	71
36 x 48RE	PL	4	935	1220	1303	1429	1513	1760	-	-	84	-	75
	PLO	4	971	1256	1339	1465	1549	1796	-	-	84	-	71
36 x 60RE	PL	4	1025	1422	1523	1684	1786	2095	-	547	84	-	87
	PLO	4	1061	1458	1559	1720	1822	2131	-	-	84	-	83
36 x 66RE	PL	4	1107	1519	1635	1812	1923	2263	-	683	84	-	106
	PLO	4	1143	1555	1671	1848	1959	2299	-	-	84	-	101
36 x 72RE	PL	5	1251	1681	1792	2048	2171	2539	-	683	105	-	106
	PLO	5	1296	1726	1837	2093	2216	2584	-	-	105	-	101
36 x 78RE	PL	5	1564	2024	2168	2390	2535	2968	-	683	105	-	119
	PLO	5	1609	2069	2213	2435	2580	3013	-	-	105	-	114
36 x 84RE	PL	5	1564	2024	2168	2390	2535	2968	-	683	105	-	119
	PLO	5	1609	2069	2213	2435	2580	3013	-	-	105	-	114
36 x 90RE	PL	6	1677	2333	2498	2757	2923	3404	-	-	126	-	137
	PLO	6	1731	2387	2552	2811	2977	3458	-	-	126	-	131
36 x 96RE	PL	6	1677	2333	2498	2757	2923	3404	-	-	126	-	137
	PLO	6	1731	2387	2552	2811	2977	3458	-	-	126	-	131

\*Folding tables available with PVC Bullnose edge only.



2448RE-PL



2448RE-PLO

### STANDARD FEATURES

- Laminate tops available in any standard Wilsonart, Nevamar, Formica, Arborite or Pionite matte finish offerings. For other laminate please contact the factory for pricing.
- Veneers and hardwood edges are standard in Oak, Maple, Cherry, Pecan, Walnut, Mahogany and Chocolate.
- 7 veneer and hardwood edge stains are standard. Stain-to-match available at no upcharge.
- Standard table height 29".
- All bases are standard with floor leveling glides.

### OPTIONS

- Custom heights available.

### HOW TO ORDER

1. Select Model
2. Select Base
3. Select Edge Style
4. Select Options
5. Select Top Finish
6. Select Edge Finish
7. Select Base Finish

**Example:** 3642RE - PL - PVF -





# POST LEGS GENERAL PURPOSE TABLES

BACK TO CONTENTS

MODEL	BASES		TOP SPECIFICATIONS						OPTIONS				LBS
	Code	Qty.	For Laminate Top			For Veneer Top			FLIP TOP (FT)	FOLD (FL)	CASTERS (LC)	WHEELS (WB)	
			SE	HF	HBV	HF2	HF	HF2					
			PVF	HB	HBVR	HB2	HB	HB2					
			PVB		HGG	HKN4	HBV	HKN4					
			2MM			HKNR4	HBVR	HKNR4					
						HGG2	HGG	HGG2					
<i>Rectangle</i>													
42 x 78RE	PL	5	1790	2186	2344	2726	2852	3354	-	-	105	-	133
	PLO	5	1835	2231	2389	2771	2897	3399	-	-	105	-	128
42 x 84RE	PL	5	1790	2186	2344	2726	2852	3354	-	-	105	-	133
	PLO	5	1835	2231	2389	2771	2897	3399	-	-	105	-	128



2448RE-PL



2448RE-PLO

### STANDARD FEATURES

- Laminate tops available in any standard Wilsonart, Nevamar, Formica, Arborite or Pionite matte finish offerings. For other laminate please contact the factory for pricing.
- Veneers and hardwood edges are standard in Oak, Maple, Cherry, Pecan, Walnut, Mahogany and Chocolate.
- 7 veneer and hardwood edge stains are standard. Stain-to-match available at no upcharge.
- Standard table height 29".
- All bases are standard with floor leveling glides.

### OPTIONS

- Custom heights available.

### HOW TO ORDER

1. Select Model
2. Select Base
3. Select Edge Style
4. Select Options
5. Select Top Finish
6. Select Edge Finish
7. Select Base Finish

**Example:** 3696RE - PL - PVF -





# POST LEGS GENERAL PURPOSE TABLES

BACK TO CONTENTS



MODEL	BASES		TOP SPECIFICATIONS						OPTIONS				LBS
	Code	Qty.	For Laminate Top			For Veneer Top			FLIP TOP (FT)	FOLD (FL)	CASTERS (LC)	WHEELS (WB)	
			SE PVF PVB 2MM	HF HB	HBV HBVR HBG	HF2 HB2 HKNR4 HBG2	HF HB HBV HBG	HF2 HB2 HKNR4 HBG2					
<i>Racetrack</i>													
36 x 54RT	PL	4	1077	1600	1722	1940	2029	2348	-	-	84	-	87
	PLO	4	1113	1636	1758	1976	2065	2384	-	-	84	-	83
36 x 60RT	PL	4	1077	1600	1722	1940	2029	2348	-	-	84	-	87
	PLO	4	1113	1636	1758	1976	2065	2384	-	-	84	-	83
36 x 66RT	PL	4	1225	1771	1903	2136	2342	2740	-	-	84	-	100
	PLO	4	1261	1807	1939	2172	2378	2776	-	-	84	-	96
36 x 72RT	PL	4	1225	1771	1903	2136	2342	2740	-	-	84	-	100
	PLO	4	1261	1807	1939	2172	2378	2776	-	-	84	-	96
36 x 78RT	PL	4	1471	2165	2327	2680	2754	3219	-	-	84	-	119
	PLO	4	1507	2201	2363	2716	2790	3255	-	-	84	-	114
36 x 84RT	PL	5	1579	2273	2435	2788	2862	3327	-	-	105	-	119
	PLO	5	1624	2318	2480	2833	2907	3372	-	-	105	-	114
36 x 90RT	PL	5	1583	2509	2702	3097	3189	3718	-	-	105	-	131
	PLO	5	1628	2554	2747	3142	3234	3763	-	-	105	-	126
36 x 96RT	PL	6	1691	2617	2810	3205	3297	3826	-	-	126	-	131
	PLO	6	1745	2671	2864	3259	3351	3880	-	-	126	-	126



2448RE-PL



2448RE-PLO

### STANDARD FEATURES

- Laminite tops available in any standard Wilsonart, Nevamar, Formica, Arborite or Pionite matte finish offerings. For other laminate please contact the factory for pricing.
- Veneers and hardwood edges are standard in Oak, Maple, Cherry, Pecan, Walnut, Mahogany and Chocolate.
- 7 veneer and hardwood edge stains are standard. Stain-to-match available at no upcharge.
- Standard table height 29".
- All bases are standard with floor leveling glides.

### OPTIONS

- Custom heights available.

### HOW TO ORDER

- Select Model
- Select Base
- Select Edge Style
- Select Options
- Select Top Finish
- Select Edge Finish
- Select Base Finish

Example: 3654RT - PL - PVF -





# POST LEGS GENERAL PURPOSE TABLES

BACK TO CONTENTS

MODEL	BASES		TOP SPECIFICATIONS						OPTIONS				LBS
	Code	Qty.	For Laminate Top			For Veneer Top			FLIP TOP (FT)	FOLD (FL)	CASTERS (LC)	WHEELS (WB)	
			SE	HF	HBV	HF2	HF	HF2					
			PVF	HB	HBVR	HB2	HB	HB2					
			PVB		HGG	HKNR4	HBV	HKNR4					
			2MM			HKNR4	HBVR	HKNR4					
						HGG2	HGG	HGG2					
<i>Racetrack</i>													
42 x 78RT	PL	4	1804	2460	2659	3058	3154	3689	-	-	84	-	142
	PLO	4	1849	2505	2704	3103	3199	3734	-	-	84	-	138
42 x 84RT	PL	4	1804	2460	2659	3058	3154	3689	-	-	84	-	142
	PLO	4	1849	2505	2704	3103	3199	3734	-	-	84	-	138
48 x 78RT	PL	4	1807	2742	2967	3320	3541	4149	-	-	84	-	142
	PLO	4	1852	2787	3012	3365	3586	4194	-	-	84	-	138
48 x 84RT	PL	4	1807	2742	2967	3320	3541	4149	-	-	84	-	142
	PLO	4	1852	2787	3012	3365	3586	4194	-	-	84	-	138



2448RE-PL



2448RE-PLO

### STANDARD FEATURES

- Laminate tops available in any standard Wilsonart, Nevamar, Formica, Arborite or Pionite matte finish offerings. For other laminate please contact the factory for pricing.
- Veneers and hardwood edges are standard in Oak, Maple, Cherry, Pecan, Walnut, Mahogany and Chocolate.
- 7 veneer and hardwood edge stains are standard. Stain-to-match available at no upcharge.
- Standard table height 29".
- All bases are standard with floor leveling glides.

### OPTIONS

- Custom heights available.

### HOW TO ORDER

1. Select Model
2. Select Base
3. Select Edge Style
4. Select Options
5. Select Top Finish
6. Select Edge Finish
7. Select Base Finish

**Example:** 4278RT - PL - PVF -





# POST LEGS GENERAL PURPOSE TABLES

BACK TO CONTENTS

MODEL	BASES		TOP SPECIFICATIONS						OPTIONS				LBS
	Code	Qty.	For Laminate Top			For Veneer Top			FLIP TOP (FT)	FOLD (FL)	CASTERS (LC)	WHEELS (WB)	
			SE	HF	HBV	HF2	HF	HF2					
			PVF	HB	HBVR	HB2	HB	HB2					
			PVB		HGG	HKNR4	HBV	HKNR4					
			2MM			HKNR4	HBVR	HKNR4					
						HGG2	HGG	HGG2					
<i>Bullet</i>													
30 x 54B	PL	4	985	1506	1614	1805	1861	2177	-	-	84	-	77
	PLO	4	1021	1542	1650	1841	1897	2213	-	-	84	-	73
30 x 60B	PL	4	985	1506	1614	1805	1861	2177	-	-	84	-	77
	PLO	4	1021	1542	1650	1841	1897	2213	-	-	84	-	73
36 x 54B	PL	4	1098	1973	2128	2407	2445	2842	-	-	84	-	87
	PLO	4	1134	2009	2164	2443	2481	2878	-	-	84	-	83
36 x 60B	PL	4	1098	1973	2128	2407	2445	2842	-	-	84	-	87
	PLO	4	1134	2009	2164	2443	2481	2878	-	-	84	-	83
36 x 72B	PL	4	1224	2192	2363	2661	2834	3332	-	-	84	-	100
	PLO	4	1260	2228	2399	2697	2870	3368	-	-	84	-	96



2448RE-PL



2448RE-PLO

### STANDARD FEATURES

- Laminate tops available in any standard Wilsonart, Nevamar, Formica, Arborite or Pionite matte finish offerings. For other laminate please contact the factory for pricing.
- Veneers and hardwood edges are standard in Oak, Maple, Cherry, Pecan, Walnut, Mahogany and Chocolate.
- 7 veneer and hardwood edge stains are standard. Stain-to-match available at no upcharge.
- Standard table height 29".
- All bases are standard with floor leveling glides.

### OPTIONS

- Custom heights available.

### HOW TO ORDER

1. Select Model
2. Select Base
3. Select Edge Style
4. Select Options
5. Select Top Finish
6. Select Edge Finish
7. Select Base Finish

**Example:** 3054B - PL - PVF -







# POST LEGS GENERAL PURPOSE TABLES

BACK TO CONTENTS

MODEL	BASES		TOP SPECIFICATIONS						OPTIONS				LBS
	Code	Qty.	For Laminate Top			For Veneer Top			FLIP TOP (FT)	FOLD (FL)	CASTERS (LC)	WHEELS (WB)	
			SE	HF	HBV	HF2	HF	HF2					
			PVF	HB	HBVR	HB2	HB	HB2					
			PVB		HGG	HKN4	HBV	HKN4					
			2MM			HKNR4	HBVR	HKNR4					
						HGG2	HGG	HGG2					
<i>Halfmoon</i>													
24 x 48H	PL	4	788	1258	1376	1519	1635	1903	-	-	84	-	58
	PLO	4	824	1294	1412	1555	1671	1939	-	-	84	-	54
30 x 60H	PL	4	985	1685	1848	2008	2209	2591	-	-	84	-	77
	PLO	4	1021	1721	1884	2044	2245	2627	-	-	84	-	73
36 x 72H	PL	4	1224	2180	2391	2588	2915	3431	-	-	84	-	100
	PLO	4	1260	2216	2427	2624	2951	3467	-	-	84	-	96
<i>Trapezoid</i>													
30 x 60TP	PL	4	985	1416	1516	1690	1740	2032	-	-	84	-	77
	PLO	4	1021	1452	1552	1726	1776	2068	-	-	84	-	73
36 x 72TP	PL	4	1224	1808	1941	2241	2315	2736	-	-	84	-	100
	PLO	4	1260	1844	1977	2277	2351	2772	-	-	84	-	96
<i>Radius (connector)</i>													
24 x 24	24RC90	-	362	656	741	850	871	1043	-	-	-	-	17
30 x 30	30RC90	-	462	868	975	1094	1156	1387	-	-	-	-	27
<i>Crescent</i>													
30 x 36	3036CRC90-PL	1	638	1266	1345	1407	1607	1826	-	-	-	-	38
	3036CRC90-PLO	1	647	1275	1354	1416	1616	1835	-	-	-	-	37
36 x 42	3642CRC90-PL	1	971	1560	1668	1750	2024	2321	-	-	-	-	51
	3642CRC90-PLO	1	980	1569	1677	1759	2033	2330	-	-	-	-	50



2448RE-PL



2448RE-PLO

### STANDARD FEATURES

- Laminate tops available in any standard Wilsonart, Nevamar, Formica, Arborite or Pionite matte finish offerings. For other laminate please contact the factory for pricing.
- Veneers and hardwood edges are standard in Oak, Maple, Cherry, Pecan, Walnut, Mahogany and Chocolate.
- 7 veneer and hardwood edge stains are standard. Stain-to-match available at no upcharge.
- Standard table height 29".
- All bases are standard with floor leveling glides.

### OPTIONS

- Custom heights available.

### HOW TO ORDER

- Select Model
- Select Base
- Select Edge Style
- Select Options
- Select Top Finish
- Select Edge Finish
- Select Base Finish

Example: 2448H - PL - PVF -





# POST LEGS BOARDROOM TABLES

BACK TO CONTENTS

MODEL	BASES		TOP SPECIFICATIONS						OPTIONS	LBS
	Code	Qty.	For Laminate Top			For Veneer Top				
			SE	HF	HBV	HF2	HF	HF2		
			PVF	HB	HBVR	HB2	HB	HB2		
			PVB		HGG	HKN4	HBV	HKN4		
			2MM			HKNR4	HBVR	HKNR4		
						HGG2	HGG	HGG2		
<i>Rectangle</i>										
42 x 96RE	PL	5	1838	2671	2897	3124	3462	4114		165
	PLO	5	1883	2716	2942	3169	3507	4159		160
	PLH	5	2050	2883	3109	3336	3674	4326		179
48 x 96RE	PL	5	1838	2671	2897	3124	3462	4114		165
	PLO	5	1883	2716	2942	3169	3507	4159		160
	PLH	5	2050	2883	3109	3336	3674	4326		179
48 x 120RE	PLH	6	2736	3811	4066	4615	4697	5458		234
48 x 144RE	PLH	6	3099	4641	4976	5499	5375	6292		268
48 x 168RE	PLH	6	3560	5112	5495	6225	6056	7122		302
60 x 120RE	PLH	6	3179	4787	5138	5681	5552	6507		276
60 x 144RE	PLH	6	3590	5519	5940	6590	6437	7583		318
60 x 168RE	PLH	6	4001	6252	6740	7502	7321	8658		360



**4296BTA-PL**  
PLH LEG IS 2.5" DIA



**4296BTA-PLO**



**4296BTA-PLH**  
PLH LEG IS 3.5" DIA

### STANDARD FEATURES

- Laminate tops available in any standard Wilsonart, Nevamar, Formica, Arborite or Pionite matte finish offerings. For other laminate please contact the factory for pricing.
- Veneers and hardwood edges are standard in Oak, Maple, Cherry, Pecan, Walnut, Mahogany and Chocolate.
- 7 veneer and hardwood edge stains are standard. Stain-to-match available at no upcharge.
- Standard table height 29".
- All bases are standard with floor leveling glides.

### OPTIONS

- Custom heights available.

### HOW TO ORDER

1. Select Model
2. Select Base
3. Select Edge Style
4. Select Top Finish
5. Select Edge Finish
6. Select Base Finish

**Example:** 4296RE - PL - PVF





# POST LEGS BOARDROOM TABLES

BACK TO CONTENTS

MODEL	BASES		TOP SPECIFICATIONS						OPTIONS	LBS
	Code	Qty.	For Laminate Top			For Veneer Top				
			SE	HF	HBV	HF2	HF	HF2		
			PVF	HB	HBVR	HB2	HB	HB2		
			PVB		HGG	HKN4	HBV	HKN4		
			2MM			HKNR4	HBVR	HKNR4		
						HGG2	HGG	HGG2		
<i>Racetrack</i>										
42 x 96RT	PL	5	1858	2799	3028	3580	3970	4665		165
	PLO	5	1903	2844	3073	3625	4015	4710		160
	PLH	5	2070	3011	3240	3792	4182	4877		179
48 x 96RT	PL	5	1858	2799	3028	3580	3970	4665		165
	PLO	5	1903	2844	3073	3625	4015	4710		160
	PLH	5	2070	3011	3240	3792	4182	4877		179
48 x 120RT	PLH	6	2760	4254	4553	5314	5282	6094		234
48 x 144RT	PLH	6	3126	4987	5353	6297	6078	7062		268
48 x 168RT	PLH	6	3590	5613	6042	7089	6885	8026		302
60 x 120RT	PLH	6	3169	5036	5407	6363	6320	7339		276
60 x 144RT	PLH	6	3626	5951	6411	7592	7317	8547		318
60 x 168RT	PLH	6	4207	6737	7272	8577	8325	9751		360



**4296BTA-PL**  
PLH LEG IS 2.5" DIA



**4296BTA-PLO**



**4296BTA-PLH**  
PLH LEG IS 3.5" DIA

### STANDARD FEATURES

- Laminate tops available in any standard Wilsonart, Nevamar, Formica, Arborite or Pionite matte finish offerings. For other laminate please contact the factory for pricing.
- Veneers and hardwood edges are standard in Oak, Maple, Cherry, Pecan, Walnut, Mahogany and Chocolate.
- 7 veneer and hardwood edge stains are standard. Stain-to-match available at no upcharge.
- Standard table height 29".
- All bases are standard with floor leveling glides.

### OPTIONS

- Custom heights available.

### HOW TO ORDER

1. Select Model
2. Select Base
3. Select Edge Style
4. Select Top Finish
5. Select Edge Finish
6. Select Base Finish

**Example:** 4296RT - PL - PVF





# POST LEGS BOARDROOM TABLES

BACK TO CONTENTS

MODEL	BASES		TOP SPECIFICATIONS						OPTIONS	LBS
	<i>Code</i>	<i>Qty.</i>		<i>For Laminate Top</i>			<i>For Veneer Top</i>			
			SE	HF	HBV	HF2	HF	HF2		
			PVF	HB	HBVR	HB2	HB	HB2		
			PVB		HGG	HKN4	HBV	HKN4		
			2MM			HKNR4	HBVR	HKNR4		
						HGG2	HGG	HGG2		
<i>Boatshape</i>										
42 x 96BT	PL	5	1858	3441	3736	4040	4471	4850		165
	PLO	5	1903	3486	3781	4085	4516	4895		160
	PLH	5	2070	3653	3948	4252	4683	5062		179
48 x 96BT	PL	5	1858	3441	3736	4040	4471	4850		165
	PLO	5	1903	3486	3781	4085	4516	4895		160
	PLH	5	2070	3653	3948	4252	4683	5062		179
48 x 120BT	PLH	6	2760	4958	5324	5709	5874	6311		234
48 x 144BT	PLH	6	3126	5691	6127	6590	7174	7572		268
48 x 168BT	PLH	6	3590	6392	6899	7434	7707	8322		302
60 x 120BT	PLH	6	3169	5914	6374	6855	7062	7606		276
60 x 144BT	PLH	6	3626	6833	7378	7957	8685	9184		318
60 x 168BT	PLH	6	4207	7710	8343	9012	9350	10121		360



**4296BTA-PL**  
PLH LEG IS 2.5" DIA



**4296BTA-PLO**



**4296BTA-PLH**  
PLH LEG IS 3.5" DIA

### STANDARD FEATURES

- Laminate tops available in any standard Wilsonart, Nevamar, Formica, Arborite or Pionite matte finish offerings. For other laminate please contact the factory for pricing.
- Veneers and hardwood edges are standard in Oak, Maple, Cherry, Pecan, Walnut, Mahogany and Chocolate.
- 7 veneer and hardwood edge stains are standard. Stain-to-match available at no upcharge.
- Standard table height 29".
- All bases are standard with floor leveling glides.

### OPTIONS

- Custom heights available.

### HOW TO ORDER

1. Select Model
2. Select Base
3. Select Edge Style
4. Select Top Finish
5. Select Edge Finish
6. Select Base Finish

**Example:** 4296BT - PL - PVF

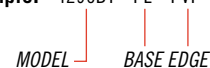



# POST LEGS BOARDROOM TABLES

BACK TO CONTENTS

MODEL	BASES		TOP SPECIFICATIONS						OPTIONS	LBS
	<i>Code</i>	<i>Qty.</i>	<i>For Laminate Top</i>			<i>For Veneer Top</i>				
			SE	HF	HBV	HF2	HF	HF2		
			PVF	HB	HBVR	HB2	HB	HB2		
			PVB		HGG	HKN4	HBV	HKN4		
			2MM			HKNR4	HBVR	HKNR4		
						HGG2	HGG	HGG2		
<i>Boatshape</i>										
<i>Arc Ends</i>										
<b>42 x 96BTA</b>	PL	5	2018	3946	4242	4548	4976	5356		165
	PLO	5	2063	3991	4287	4593	5021	5401		160
	PLH	5	2230	4158	4454	4760	5188	5568		179
<b>48 x 96BTA</b>	PL	5	2018	3946	4242	4548	4976	5356		165
	PLO	5	2063	3991	4287	4593	5021	5401		160
	PLH	5	2230	4158	4454	4760	5188	5568		179
<b>48 x 120BTA</b>	PLH	6	2921	5465	5831	6217	6381	6816		234
<b>48 x 144BTA</b>	PLH	6	3287	6196	6635	7098	7679	8079		268
<b>48 x 168BTA</b>	PLH	6	3752	6899	7407	7942	8212	8830		302
<b>60 x 120BTA</b>	PLH	6	3371	6550	7006	7489	7694	8238		276
<b>60 x 144BTA</b>	PLH	6	3826	7464	8012	8590	9318	9815		318
<b>60 x 168BTA</b>	PLH	6	4407	8343	8976	9643	9985	10756		360



**4296BTA-PL**  
PLH LEG IS 2.5" DIA



**4296BTA-PLO**



**4296BTA-PLH**  
PLH LEG IS 3.5" DIA

### STANDARD FEATURES

- Laminate tops available in any standard Wilsonart, Nevamar, Formica, Arborite or Pionite matte finish offerings. For other laminate please contact the factory for pricing.
- Veneers and hardwood edges are standard in Oak, Maple, Cherry, Pecan, Walnut, Mahogany and Chocolate.
- 7 veneer and hardwood edge stains are standard. Stain-to-match available at no upcharge.
- Standard table height 29".
- All bases are standard with floor leveling glides.

### OPTIONS

- Custom heights available.

### HOW TO ORDER

1. Select Model
2. Select Base
3. Select Edge Style
4. Select Top Finish
5. Select Edge Finish
6. Select Base Finish

**Example:** 4296BTA - PL - PVF



# SIDEKICK TABLES



PLACING AN ORDER IS EASY

## PRODUCT CODE

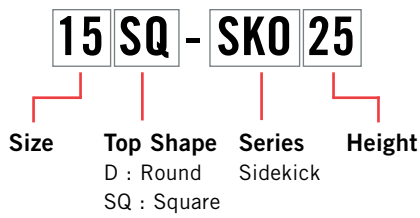

## OPTIONS

### UPHOLSTERY CAP



### BASE SHAPE\*



\*Table top shape determines base shape.

## FINISHES

### LAMINATE



Select laminate from our virtually unlimited laminate options

### VENEER

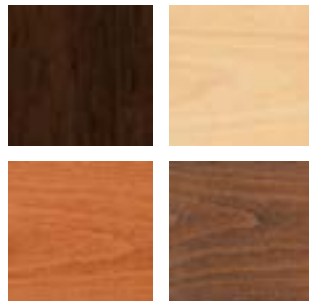

Select from one of our 7 standard wood stains or stain-to-match at no upcharge

### BASE



Select from one of our 76 standard Spectone colors

### EDGE



2MM      PVC      Hard Wood

Check out our website for a complete list of edge profiles.



# SIDEKICK

BACK TO CONTENTS

SIZE	MODEL <i>Code</i>	DESCRIPTION	BASE <i>Qty.</i>	TOP SPECIFICATIONS						OPTION  UPHOLSTERY CAP  <i>Add</i>	LBS
				SE PVF PVB 2MM	HF HB	HBV HBVR HBG	HF2 HB2 HKN4 HBG2	HF HB HBV HBG	HF2 HB2 HKN4 HBG2		
<i>Round</i>											
15	15D-SK018	15" Round Top with 18" High Offset Base	1	587	909	942	1037	1088	1186	47	26
	15D-SK022	15" Round Top with 22" High Offset Base	1	587	909	942	1037	1088	1186	47	26
	15D-SK025	15" Round Top with 25" High Offset Base	1	587	909	942	1037	1088	1186	-	26
18	18D-SK018	18" Round Top with 18" High Offset Base	1	648	988	1022	1122	1175	1278	47	33
	18D-SK022	18" Round Top with 22" High Offset Base	1	648	988	1022	1122	1175	1278	47	33
	18D-SK025	18" Round Top with 25" High Offset Base	1	648	988	1022	1122	1175	1278	-	33
22	22D-SK018	22" Round Top with 18" High Offset Base	1	751	1080	1114	1214	1267	1370	-	44
	22D-SK022	22" Round Top with 22" High Offset Base	1	751	1080	1114	1214	1267	1370	-	44
	22D-SK025	22" Round Top with 25" High Offset Base	1	751	1080	1114	1214	1267	1370	-	44
<i>Square</i>											
15	15SQ-SK018	15" Square Top with 18" High Offset Base	1	557	739	771	830	873	1018	-	26
	15SQ-SK022	15" Square Top with 22" High Offset Base	1	557	739	771	830	873	1018	-	27
	15SQ-SK025	15" Square Top with 25" High Offset Base	1	557	739	771	830	873	1018	-	27
18	18SQ-SK018	18" Square Top with 18" High Offset Base	1	615	805	839	901	946	1100	-	34
	18SQ-SK022	18" Square Top with 22" High Offset Base	1	615	805	839	901	946	1100	-	35
	18SQ-SK025	18" Square Top with 25" High Offset Base	1	615	805	839	901	946	1100	-	35
22	22SQ-SK018	22" Square Top with 18" High Offset Base	1	719	899	933	995	1040	1194	-	47
	22SQ-SK022	22" Square Top with 22" High Offset Base	1	719	899	933	995	1040	1194	-	47
	22SQ-SK025	22" Square Top with 25" High Offset Base	1	719	899	933	995	1040	1194	-	48

Exceeds BIFMA Seating Durability Test to 300 lbs.



### STANDARD FEATURES

- Available in 15", 18" and 22" round or square tops at 18", 22" and 25" heights.
- Round Base and offset column is used with round tops.
- Square Base and offset column is used with square tops.
- Laminate tops are available in any standard Wilsonart, Nevamar, Formica, Arborite or Pionite matte finish.
- For other laminates please contact the factory.
- Veneers and hardwood edge stains are standard in Maple, Mahogany, Cherry, Oak, Pecan, Walnut and Chocolate or Stain-to Match at no upcharge.
- Base and column available in any of 76 Spectone colors.

### OPTION

- Upholstery cap is available on some models.

### HOW TO ORDER

1. Select Model
2. Select Edge Style
3. Select Option
4. Select Top Finish
5. Select Edge Finish
6. Select Base Finish

Example: 15D-SK018-PVF-



## TAILGATE TABLES



## INTRODUCTION

### STRENGTHEN THE ABILITY TO WORK, LEARN AND CREATE TOGETHER

Tailgate is a series of collaborative tables designed around a unique power and communication trough, making interaction and data sharing simple and straightforward. Available with a Media Wall or Freestanding, two base designs and endless finish options, Tailgate can be specified to fit virtually any environment from boardroom to hardworking collaborative groupings.

Access to power and communication is instant with the Tailgate Power and Communication Trough that runs along the center of the table surface. The trough door has a dual hinge, allowing users to access power and communication from either side of the table. Ports within the trough can be customized to meet your needs. Tailgate Tables will adapt to the inevitable changes of technology.

Our Customer Service and Design Team is always ready to help you find the best solution for collaboration and teamwork through standard or custom designs.

### CONSIDERATIONS

- How many people do you need to accommodate?
- Do you require an attached media wall support for your collaborative area?
- Do you require a freestanding solution where your monitor(s) will be wall-mounted or on a credenza?
- What kind of collaborative enhancing hardware and software will be utilized?
- Which base design will you specify?
- Where will you access necessary power and/or communication requirements?





# TAILGATE TABLES



## TABLE OF CONTENTS

### TAILGATE TABLES WITH MEDIA WALL

Tailgate Tables – Statement of Line . . . . . 03

Tailgate Tables – with Media Wall – Media Wall Overview . . . . . 04

Tailgate Tables – with Media Wall – Power and Communication Trough Overview . . . . . 05

Tailgate Tables – with Media Wall – Manhattan Base Overview . . . . . 06

Tailgate Tables – with Media Wall – Plinth Base Overview . . . . . 07

Tailgate Tables – with Media Wall – Manhattan and Plinth Base – How to Order . . . . . 08

Sizes, Line Drawings, Specifications and Pricing - Manhattan Base without Vertical Wire Managers . . . . . 09

Sizes, Line Drawings, Specifications and Pricing - Manhattan Base with Vertical Wire Managers . . . . . 12

Sizes, Line Drawings, Specifications and Pricing - Plinth Base . . . . . 15

### TAILGATE TABLES - FREESTANDING

Tailgate Tables – Freestanding– How to Order . . . . . 18

Tailgate Tables – Freestanding – Manhattan and Plinth Base Overview . . . . . 19

Tailgate Tables – Freestanding – Power and Communication Trough Overview . . . . . 20

Sizes, Line Drawings, Specifications and Pricing – Manhattan and Plinth Bases . . . . . 21

Tailgate Tables – Freestanding – Plinth Base Power and Voice/Data Modules . . . . . 29

Tailgate Tables – Freestanding – Power and Voice/Data Accessories . . . . . 30

# TAILGATE TABLES STATEMENT OF LINE

## TAILGATE TABLES WITH MEDIA WALL



Manhattan Bases Rectangular Top



Manhattan Bases Bullet Top

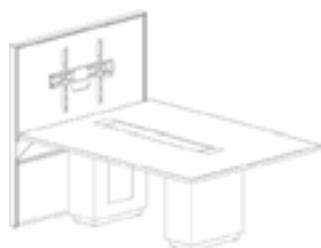

Plinth Bases Rectangular Top



Plinth Bases Bullet Top



## TAILGATE TABLES - FREESTANDING



Manhattan Base



Plinth Base



Plinth Base



Manhattan Base

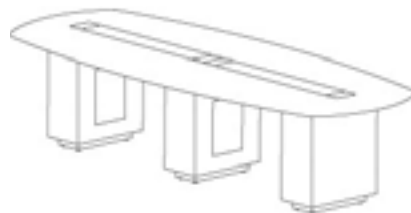

Plinth Base

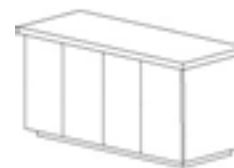

Credenza

### Tailgate Tables and Credenzas

- A variety of sizes and shapes
- Manhattan Bases or Plinth Bases
- Laminate and veneer standard (stain-to-match is available at no upcharge)
- 2mm Bio Edge is standard on tops with Media Wall. Freestanding tables have a wide choice of edges
- Matching credenzas



# TAILGATE TABLES WITH MEDIA WALL MEDIA WALL OVERVIEW

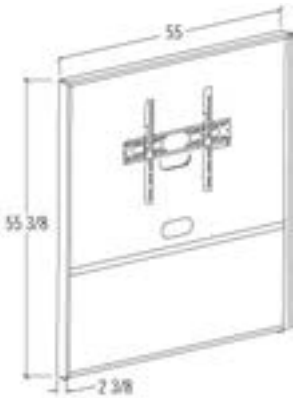

The media wall is attached to the table to create a structural wall to mount desired monitor.

Height: 55 3/8"  
Width: 55"  
Thickness: 2 3/8"

Custom sizes may be available, please contact factory.

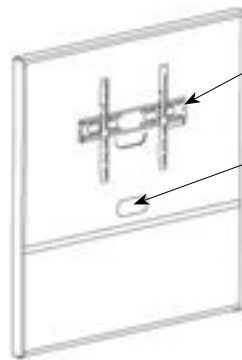

Monitor mounting brackets included. Accommodates monitor up to 165 lbs.

Standard with wire pass through for power/data and monitor. Interior of media wall allows routing of necessary wiring to the floor, or trough.

Trim and end caps are standard in anodized aluminum.

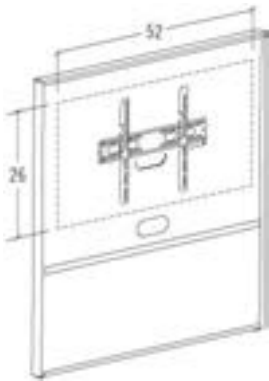

Media wall accommodates monitors that can fit within an area measuring up to a maximum of 52" W and 26" H. Holds up to 165 lbs.

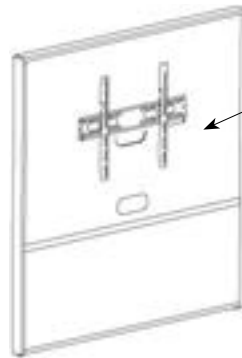

Finished front and back in any standard Wilsonart, Nevamar, Formica, Pionite or Arborite laminate matte finish options. For veneer, fabric finishes, or writeable surface materials, please contact factory.

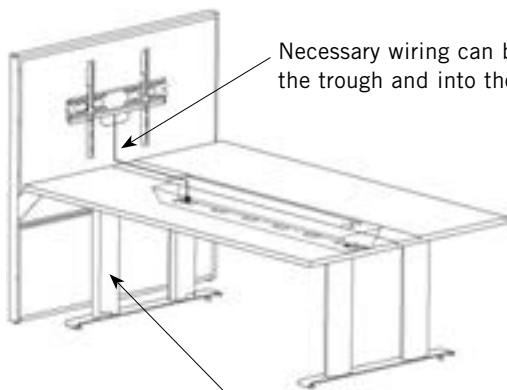

Necessary wiring can be routed under the trough and into the media wall.

The optional vertical wire manager on the Manhattan base allows necessary wires to be routed to the floor.

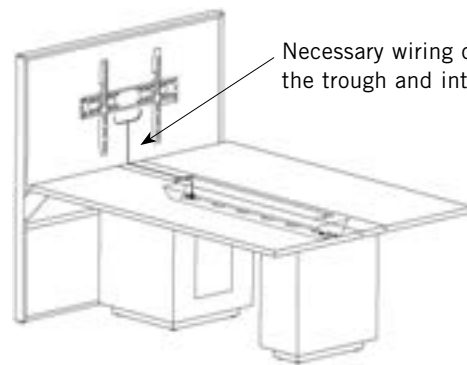

Necessary wiring can be routed under the trough and into the media wall.

All Plinth bases are standard with a touch latch door which allows necessary wires to be routed to the floor.



# TAILGATE TABLES WITH MEDIA WALL POWER AND COMMUNICATION TROUGH OVERVIEW

Tailgate power and communication troughs are shipped fully assembled and are included in the price of the table. There are three trough sizes to accommodate different size tops. The Trough door opens and closes from either side. It can be customized to meet your power and/or communication specification. An open perimeter around each side of the trough door allows the door to be closed while laptops and other items are plugged in.

Each trough is standard with power duplexes (labelled P) with a 9 ft. cord. Cutouts for data and communication (labelled D) are also included, however data ports must be specified separately and can be configured to meet specific requirements, see page 30. Specify blank plates when data and communication is not required at no upcharge.

## Number of Duplexes and Data & Communication Cutouts

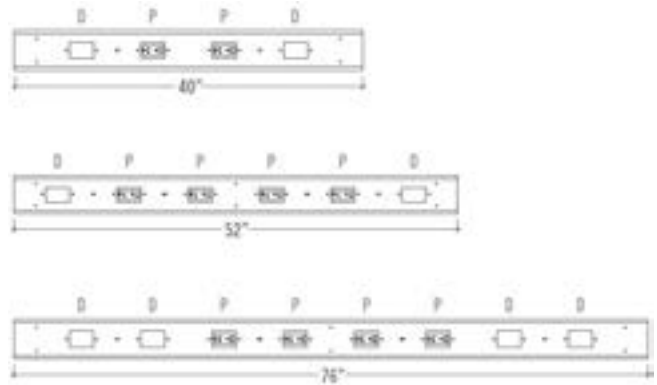

## Trough End Caps Sizes

Tailgate with Media Wall

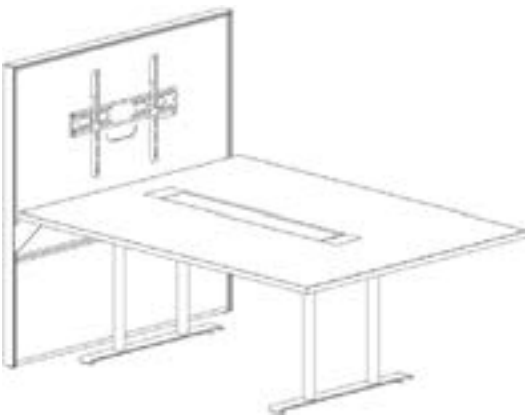

When specifying Tailgate with a Media Wall and Rectangular top or a Bullet top, the trough end caps are 4" on both ends.

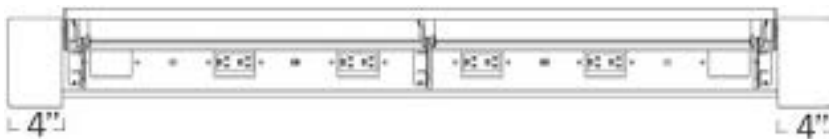



# TAILGATE TABLES WITH MEDIA WALL MANHATTAN BASE – OVERVIEW

The Manhattan Double Column T Base is available with or without Vertical Wire Manager.

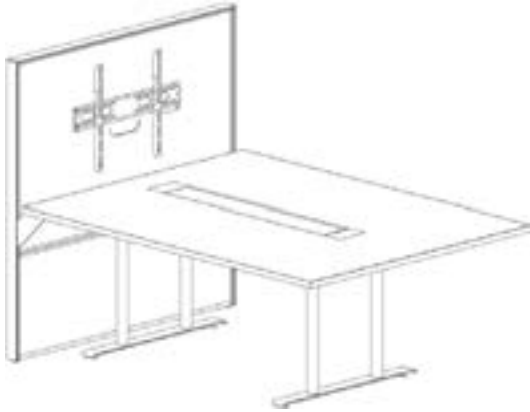

Manhattan Double Column T Base and Rectangular top  
Shown without Vertical Wire Managers



Manhattan Single Column T Base and Bullet top  
Shown with Vertical Wire Managers

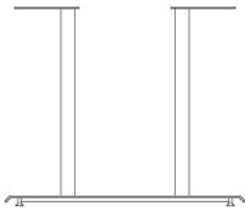

Double Column T Base is standard without Vertical Wire Manager, includes adjustable glides.  
*Specify Round or Rectangular Column*

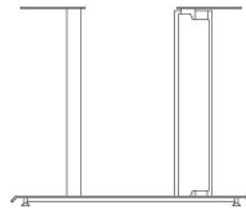

Optional Vertical Wire Manager can be attached to one of the columns on a Round Double Column T Base to route wires from table surface to floor.  
*Specify Oval or Rectangular Vertical Wire Manager.*

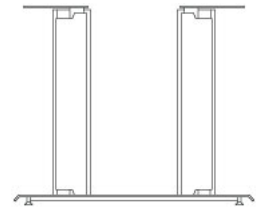

Two optional Vertical Wire Managers can be attached to Round Double Column T Base to route wires from table surface to floor and provide a consistent look. *Specify Oval or Rectangular Vertical Wire Manager.*

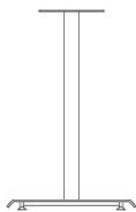

Manhattan Single Column T Base supports Tailgate Manhattan base tables with bullet top at end, and is standard without a vertical wire manager.  
*Specify Round or Rectangular Column*

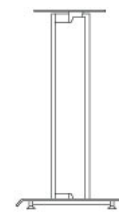

Optional Vertical Wire Manager attaches to single column Round T Base to route wires from the table top surface to floor.  
*Specify Oval or Rectangular Vertical Wire Manager.*

## TAILGATE TABLES WITH MEDIA WALL PLINTH BASE – OVERVIEW

Tailgate Plinth bases are available in square or rectangular in laminate or veneer. Veneer bases are available in 7 standard stains or stain-to-match at no upcharge. Laminate bases are available in any standard Wilsonart, Nevamar, Formica, Pionite or Arborite laminate matte finish.

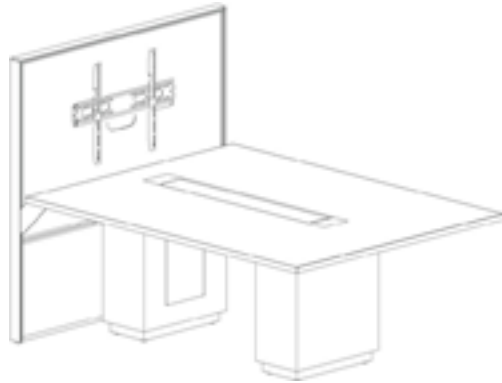

Rectangular top



Bullet top

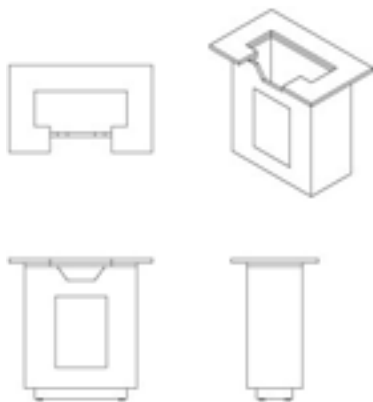

Rectangular 11”x 22” Plinth Base is standard on rectangular tops.

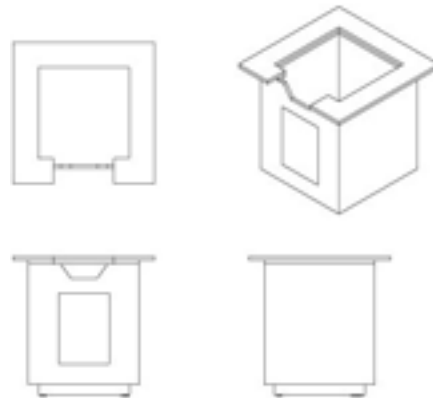

Square 22” Plinth Base is standard when used against a media wall to ensure adequate support. An 11”x 22” rectangle Plinth Base may not be specified against the media wall.

- When a bullet top is specified, a square 22” Plinth Base is required to support the top.

**NOTE:**

All Tailgate Plinth Bases are standard with a touch latch door and kickplate. Kickplate is finished in Wilsonart 6257 Satin Brushed Natural Aluminum.

## TAILGATE TABLES WITH MEDIA WALL HOW TO ORDER



### HOW TO ORDER

Tailgate is a series of tabletops and bases that allows complete flexibility when specifying boardrooms, meeting rooms, video conferencing and training areas.

For simplicity, Tailgate with Media Wall is priced as a unit. All Tailgate Plinth bases are standard with a touch latch door for wire access and a cutout at the top for wire pass-through. Manhattan double column bases are available with or without vertical wire management.

---

#### STEP 1 TABLETOP - *Power and Communication Trough is included*

1. Choose the shape and size of the tabletop
2. Choose laminate top finish - For veneer pricing contact the factory
3. Choose edge color

---

#### STEP 2 BASE

1. Choose a base design - Manhattan or Plinth
2. Choose a base finish
  - Plinth in laminate or Manhattan in any Spectone finish

---

#### STEP 3 POWER AND COMMUNICATION

1. Duplexes are included
2. For each module select the appropriate data configuration

---

#### STEP 4 MEDIA WALL

1. Choose from any standard Wilsonart, Nevamar, Formica, Pionite or Arborite laminate matte finish

# TAILGATE WITH MEDIA WALL



PLACING AN ORDER IS EASY

## PRODUCT CODE

**TGM 5584 RE - MRT2**

**Series**

TG with Media Wall

**Size**

Width x Length

**Top Shape**

RE : Rectangle  
B : Bullet

**Base**

MRT2: Manhattan Round Double Column  
MNT2: Manhattan Double Column Rectangle Leg  
P : Plinth Base

## OPTIONS

### BASES



Manhattan Round Double Column



Manhattan Rectangular Double Column



Plinth Base

### VERTICAL WIRE MANAGER



VWM



RVWM

## FINISHES

### LAMINATE



Select laminate from our virtually unlimited laminate options

### VENEER

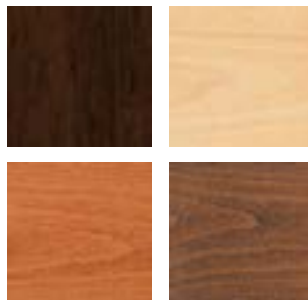

Select from one of our 7 standard wood stains or stain-to-match at no upcharge

### BASE



Select from one of our 76 standard Spectone colors

### EDGE



2MM

PVC

Hard Wood

Check out our website for a complete list of edge profiles.



## TAILGATE TABLES WITH MEDIA WALL MANHATTAN BASE - RECTANGULAR TOP PRICING AND SPECIFICATIONS

### All Units Include:

- Laminate Media Wall and TV mounting bracket
- 2 - Double Column T Bases
- 2mm Bio Edge on top, in any of 38 colors
- Inside edge of trough cutout is standard in a silver 2mm Bio Edge to match trough finish

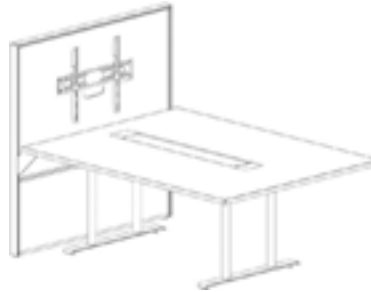

Round Column

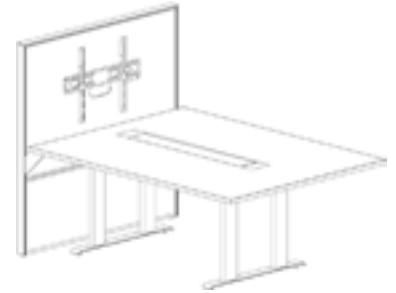

Rectangular Column

### Options:

For Vertical wire mangers and Media Box see Pricing & Specifications at the end of this section.

<b>55" x 66" Laminate Rectangular Top</b> <ul style="list-style-type: none"> <li>• 40" W Power and Communication Trough with 2 - 4"W End Caps</li> <li>• 2 Power Duplexes and 2 Data cutouts are included, specify Data separately</li> <li>• Total length with Media wall is 70"</li> </ul>	<b>TGM5566RE-MNT2</b>  <b>4478</b>	<b>TGM5566RE-MRT2</b>  <b>4550</b>
<b>55" x 72" Laminate Rectangular Top</b> <ul style="list-style-type: none"> <li>• 40" W Power and Communication Trough with 2 - 4"W End Caps</li> <li>• 2 Power Duplexes and 2 Data cutouts are included, specify Data separately</li> <li>• Total length with Media wall is 76"</li> </ul>	<b>TGM5572RE-MNT2</b>  <b>4584</b>	<b>TGM5572RE-MRT2</b>  <b>4656</b>
<b>55" x 84" Laminate Rectangular Top</b> <ul style="list-style-type: none"> <li>• 52" W Power and Communication Trough with 2 - 4"W End Caps</li> <li>• 2 Power Duplexes and 2 Data cutouts are included, specify Data separately</li> <li>• Total length with Media wall is 88"</li> </ul>	<b>TGM5584RE-MNT2</b>  <b>5025</b>	<b>TGM5584RE-MRT2</b>  <b>5097</b>
<b>55" x 96" Laminate Rectangular Top</b> <ul style="list-style-type: none"> <li>• 52" W Power and Communication Trough with 2 - 4"W End Caps</li> <li>• 4 Power Duplexes and 2 Data cutouts are included, specify Data separately</li> <li>• Total length with Media wall is 100"</li> </ul>	<b>TGM5596RE-MNT2</b>  <b>5235</b>	<b>TGM5596RE-MRT2</b>  <b>5307</b>



# TAILGATE TABLES WITH MEDIA WALL MANHATTAN BASE - BULLET TOP PRICING AND SPECIFICATIONS

**All Units Include:**

- Laminate Media Wall and TV mounting bracket
- 2 - Double Column T Bases
- 2mm Bio Edge on top, in any of 38 colors
- Inside edge of trough cutout is standard in a silver 2mm Bio Edge to match trough finish

**Options:**

For Vertical wire mangers and Media Box see Pricing & Specifications at the end of this section.



Round Column





Rectangular Column

<p><b>55" x 66" Laminate Bullet Top</b></p> <ul style="list-style-type: none"> <li>• 40" W Power and Communication Trough with 2 - 4"W End Caps</li> <li>• 2 Power Duplexes and 2 Data cutouts are included, specify Data separately</li> <li>• Total length with Media wall is 70"</li> </ul>	<p><b>TGM5566B-MNT2</b></p> <p><b>4478</b></p>	<p><b>TGM5566B-MRT2</b></p> <p><b>4550</b></p>
<p><b>55" x 72" Laminate Bullet Top</b></p> <ul style="list-style-type: none"> <li>• 40" W Power and Communication Trough with 2 - 4"W End Caps</li> <li>• 2 Power Duplexes and 2 Data cutouts are included, specify Data separately</li> <li>• Total length with Media wall is 76"</li> </ul>	<p><b>TGM5572B-MNT2</b></p> <p><b>4584</b></p>	<p><b>TGM5572B-MRT2</b></p> <p><b>4656</b></p>
<p><b>55" x 84" Laminate Bullet Top</b></p> <ul style="list-style-type: none"> <li>• 52" W Power and Communication Trough with 2 - 4"W End Caps</li> <li>• 2 Power Duplexes and 2 Data cutouts are included, specify Data separately</li> <li>• Total length with Media wall is 88"</li> </ul>	<p><b>TGM5584B-MNT2</b></p> <p><b>5025</b></p>	<p><b>TGM5584B-MRT2</b></p> <p><b>5097</b></p>
<p><b>55" x 96" Laminate Bullet Top</b></p> <ul style="list-style-type: none"> <li>• 52" W Power and Communication Trough with 2 - 4"W End Caps</li> <li>• 4 Power Duplexes and 2 Data cutouts are included, specify Data separately</li> <li>• Total length with Media wall is 100"</li> </ul>	<p><b>TGM5596B-MNT2</b></p> <p><b>5235</b></p>	<p><b>TGM5596B-MRT2</b></p> <p><b>5307</b></p>

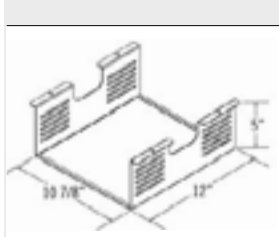

# TAILGATE TABLES WITH MEDIA WALL VERTICAL WIRE MANAGERS & MEDIA BOXES PRICING AND SPECIFICATIONS

	<p><b>Oval Vertical Wire Manager</b> Can be added to the Manhattan round base to neatly conceal and direct power and communication to the floor. Add Vertical Wire Managers to each base column as required. <i>*Compatible with Round Manhattan base column only</i></p>	<p><b>VWM</b> <i>Single Column</i> 172</p>	<p><b>VWM2</b> <i>Double Column</i> 345</p>
	<p><b>Rectangular Vertical Wire Manager</b> Can be added to the Manhattan round base to neatly conceal and direct power and communication to the floor. Add Vertical Wire Managers to each base column as required. <i>*Compatible with Round Manhattan base column only</i></p>	<p><b>RVWM</b> <i>Single Column</i> 172</p>	<p><b>RVWM2</b> <i>Double Column</i> 345</p>
	<p><b>Media Box</b> Attaches under the top to enclose desired hardware if required. <i>*Standard in silver</i></p>	<p><b>MB</b> 115</p>	





# TAILGATE TABLES WITH MEDIA WALL PLINTH BASE - RECTANGULAR TOP PRICING AND SPECIFICATIONS

**All Units Include:**

- Laminate Media Wall and TV mounting bracket
- 2 - 11" x 22" Rectangle Plinth Base
- 2mm Bio Edge on top, in any of 38 colors
- Inside edge of trough cutout is standard in a silver 2mm Bio Edge to match trough finish

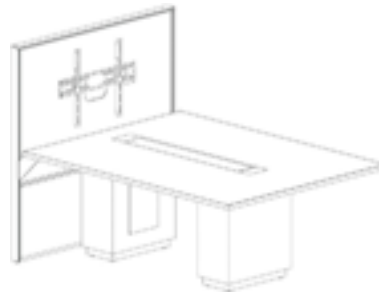

<p><b>55" x 66" Laminate Rectangular Top, Plinth Base</b></p> <ul style="list-style-type: none"> <li>• 40" W Power and Communication Trough with 2 - 4"W End Caps</li> <li>• 2 Power Duplexes and 2 Data cutouts are included, specify Data separately</li> <li>• Total length with Media wall is 70"</li> </ul>	<p><b>TGM5566RE-P</b> <b>5558</b></p>
<p><b>55" x 72" Laminate Rectangular Top, Plinth Base</b></p> <ul style="list-style-type: none"> <li>• 40" W Power and Communication Trough with 2 - 4"W End Caps</li> <li>• 2 Power Duplexes and 2 Data cutouts are included, specify Data separately</li> <li>• Total length with Media wall is 76"</li> </ul>	<p><b>TGM5572RE-P</b> <b>5664</b></p>
<p><b>55" x 84" Laminate Rectangular Top, Plinth Base</b></p> <ul style="list-style-type: none"> <li>• 52" W Power and Communication Trough with 2 - 4"W End Caps</li> <li>• 2 Power Duplexes and 2 Data cutouts are included, specify Data separately</li> <li>• Total length with Media wall is 88"</li> </ul>	<p><b>TGM5584RE-P</b> <b>6105</b></p>
<p><b>55" x 96" Laminate Rectangular Top, Plinth Base</b></p> <ul style="list-style-type: none"> <li>• 52" W Power and Communication Trough with 2 - 4"W End Caps</li> <li>• 4 Power Duplexes and 2 Data cutouts are included, specify Data separately</li> <li>• Total length with Media wall is 100"</li> </ul>	<p><b>TGM5596RE-P</b> <b>6315</b></p>

**Options:**

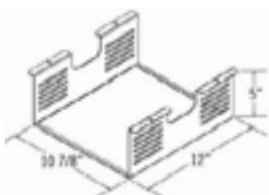

**Media Box** **MB**  
 Attaches under the top to enclose desired hardware if required. 115  
*\*Standard in silver*



# TAILGATE TABLES WITH MEDIA WALL PLINTH BASE - BULLET TOP PRICING AND SPECIFICATIONS

**All Units Include:**

- Laminate Media Wall and TV mounting bracket
- 2 - 11" x 22" Rectangle Plinth Base
- 2mm Bio Edge on top, in any of 38 colors
- Inside edge of trough cutout is standard in a silver 2mm Bio Edge to match trough finish

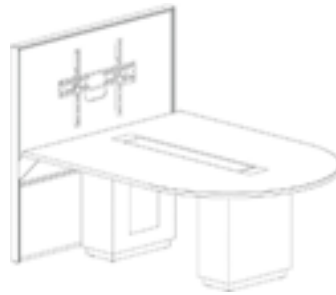

<p><b>55" x 66" Laminate Bullet Top, Plinth Base</b></p> <ul style="list-style-type: none"> <li>• 40" W Power and Communication Trough with 2 - 4"W End Caps</li> <li>• 2 Power Duplexes and 2 Data cutouts are included, specify Data separately</li> <li>• Total length with Media wall is 70"</li> </ul>	<p><b>TGM5566B-P</b> <b>5558</b></p>
<p><b>55" x 72" Laminate Bullet Top, Plinth Base</b></p> <ul style="list-style-type: none"> <li>• 40" W Power and Communication Trough with 2 - 4"W End Caps</li> <li>• 2 Power Duplexes and 2 Data cutouts are included, specify Data separately</li> <li>• Total length with Media wall is 76"</li> </ul>	<p><b>TGM5572B-P</b> <b>5664</b></p>
<p><b>55" x 84" Laminate Bullet Top, Plinth Base</b></p> <ul style="list-style-type: none"> <li>• 52" W Power and Communication Trough with 2 - 4"W End Caps</li> <li>• 2 Power Duplexes and 2 Data cutouts are included, specify Data separately</li> <li>• Total length with Media wall is 88"</li> </ul>	<p><b>TGM5584B-P</b> <b>6105</b></p>
<p><b>55" x 96" Laminate Bullet Top, Plinth Base</b></p> <ul style="list-style-type: none"> <li>• 52" W Power and Communication Trough with 2 - 4"W End Caps</li> <li>• 4 Power Duplexes and 2 Data cutouts are included, specify Data separately</li> <li>• Total length with Media wall is 100"</li> </ul>	<p><b>TGM5596B-P</b> <b>6315</b></p>

**Options:**

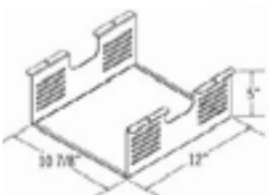

**Media Box** **MB**  
 Attaches under the top to enclose desired hardware if required. 115  
*\*Standard in silver*

## TAILGATE FREESTANDING TABLES



### HOW TO ORDER

Tailgate is a series of tabletops and bases that allows complete flexibility when specifying boardrooms, meeting rooms, video conferencing and training areas.

For simplicity and ease of choice, tabletops and bases are priced separately. All Tailgate Plinth bases are standard with a touch latch door for wire access and a cutout at the top for wire pass-through. Manhattan double column bases are available with or without vertical wire management.

---

#### STEP 1 - TABLETOP - *Power and Communication Trough is included*

1. Choose the shape and size of the tabletop
2. Choose laminate or veneer top finish
3. Choose an edge profile in hardwood, Self edge, PVC or 2mm Bio Edge

---

#### STEP 2 - BASE

1. Choose a base design - Manhattan or Plinth
  - be sure to select the correct number of bases required for the table
2. Choose a base finish
  - Plinth in laminate or veneer, or Manhattan in any Spectone finish

---

#### STEP 3 - POWER AND COMMUNICATION MODULES

1. Duplexes are included
2. For each module select the appropriate data configuration

# TAILGATE FREESTANDING TABLES

## FREESTANDING TABLETOP SHAPES

On one piece tabletops, grain direction runs lengthwise.  
 On tabletops of two or more pieces, grain direction runs from side to side, as standard.

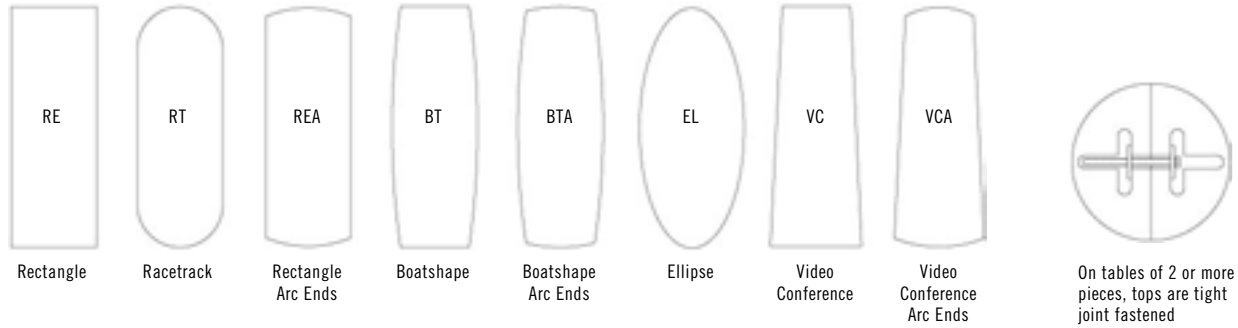

## EDGE PROFILES

Tailgate tabletops in veneer or laminate can be specified with any one of our standard hardwood edge profiles.  
 Also available in self edge, PVC flat, PVC bullnose and 2mm Bio Edge.

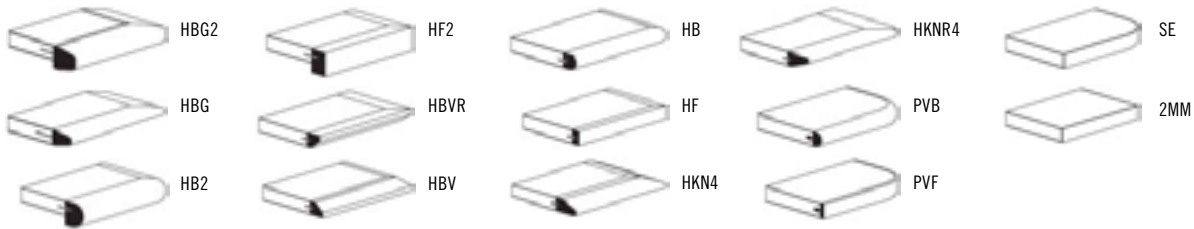

## BASE DESIGNS

### Tailgate - Base Designs

Two different bases designs are available, Plinth and Manhattan Double Column T Base. The Plinth bases are available in two shapes and sizes, 11" x 22" rectangular and 22" square. Plinth bases can be specified in laminate or veneer. Manhattan bases are available in any of 76 Spectone finishes.

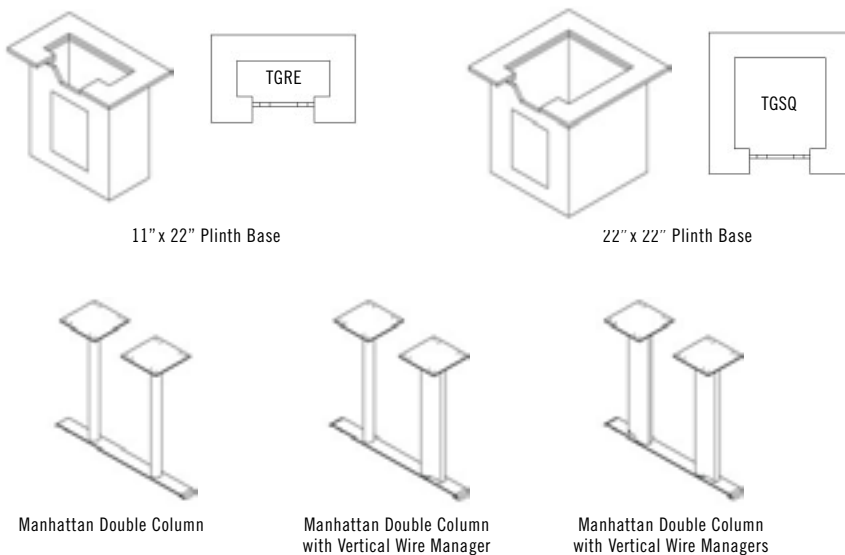



# TAILGATE FREESTANDING TABLES POWER AND COMMUNICATION TROUGH OVERVIEW

Tailgate power and communication troughs are shipped fully assembled and are included in the price of the table. There are three trough sizes to accommodate different size tops. The Trough door opens and closes from either side. It can be customized to meet your power and/or communication specification. An open perimeter around each side of the trough door allows the door to be closed while laptops and other items are plugged in.

Each trough is standard with power duplexes (labelled P) with a 9 ft. cord. Cutouts for data and communication (labelled D) are also included, however data ports must be specified separately and can be configured to meet specific requirements, see page 30. Specify blank plates when data and communication is not required at no upcharge.

## Number of Duplexes and Data & Communication Cutouts

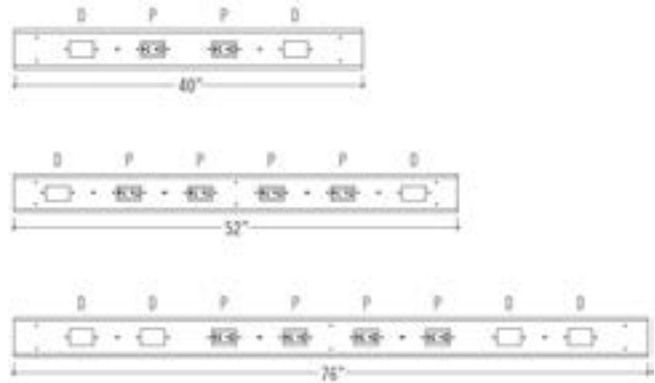

## Trough End Caps Sizes

### Freestanding Tailgate

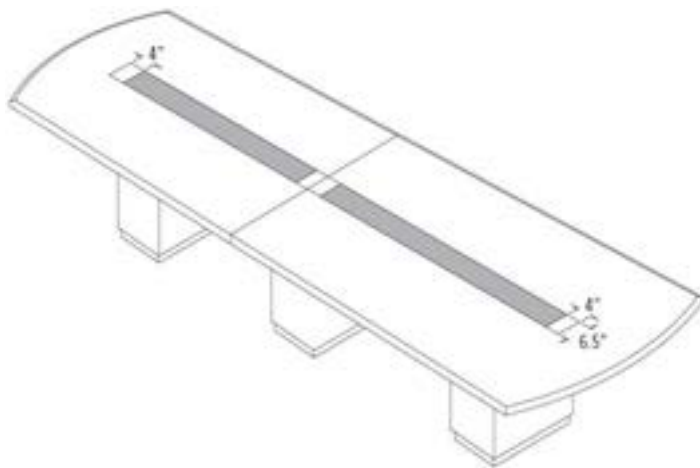

When specifying Freestanding Tailgate tables the trough end caps are always 4".



## Power and Communication Trough included in price

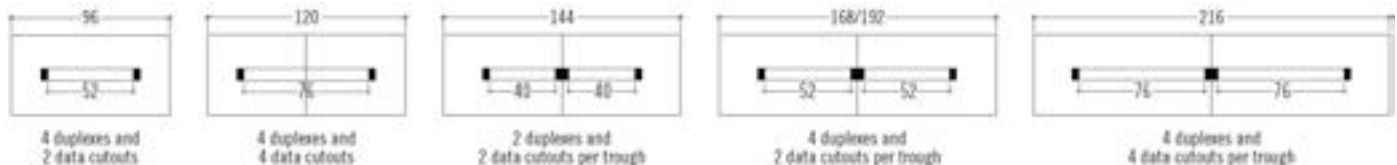



# TAILGATE FREESTANDING



BACK TO CONTENTS

## PLACING AN ORDER IS EASY

### PRODUCT CODE



Series	Size	Top Shape	Series	Base	Finish
	Width x Length	B : Bullet RE : Rectangle RT : Racetrack BT : Boatshape REA : Rectangle Arc Ends		RE : Rectangle Plinth SQ : Square Plinth MNT2 : Manhattan Rect Double Column MRT2 : Manhattan Round Double Column	L : Laminate V : Veneer
		BTA : Boatshape Arc Ends EL : Ellipse VC : Video Conference VCA : Video Conference Arc Ends			

## OPTIONS

### BASES



Manhattan Round Double Column



Manhattan Rectangular Double Column



Plinth Base

### VERTICAL WIRE MANAGER



VWM



RVWM

## FINISHES

### LAMINATE



Select laminate from our virtually unlimited laminate options

### VENEER

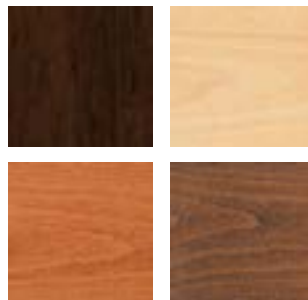

Select from one of our 7 standard wood stains or stain-to-match at no upcharge

### BASE



Select from one of our 76 standard Spectone colors

### EDGE



2MM

PVC

Hard Wood

Check out our website for a complete list of edge profiles.



# TAILGATE FREESTANDING TABLES TABLETOPS









Includes Power & Communication Trough



SIZE	TABLETOPS		TOP AND EDGE SPECIFICATIONS						TROUGHS		BASES		SEATS	LBS
	Model	Number of Sections	SE PVF PVB 2MM	For Laminate Top HF HB	HBV HBVR HBG	HF2 HB2 HKN4 HKNR4 HBG2	For Veneer Top HF HB HBV HBVR HBG	HF2 HB2 HKN4 HKNR4 HBG2	Number of Troughs	Length of Trough(s)	Number of Bases Required  TGRE TGMNT2 TGSQ		Number of Seats	
<i>Bullet</i>														
48 x 66	TG4866B	1	2060	2700	2930	3237	3314	3826	1	40	2	2	4	135
48 x 72	TG4872B	1	2160	2858	3110	3444	3528	4086	1	40	2	2	4	168
48 x 84	TG4884B	1	2592	3406	3699	4089	4187	4838	1	52	2	2	6	202
48 x 96	TG4896B	1	2792	3722	4057	4503	4615	5359	1	52	2	2	8	236
60 x 66	TG6066B	1	2221	2954	3218	3570	3657	4244	1	40	2	2	4	269
60 x 72	TG6072B	1	2335	3135	3423	3806	3902	4542	1	40	2	2	4	303
60 x 84	TG6084B	1	2796	3728	4064	4512	4624	5369	1	52	2	2	6	210
60 x 96	TG6096B	1	3024	4090	4475	4986	5114	5967	1	52	2	2	8	252

Note: Price of top includes troughs and power duplexes. Number of duplexes varies depending on trough size and number of troughs per table, see below. For custom trough configurations contact factory.

## BASES

MODEL	BASE SHAPE	FINISH	LIST PRICE	LBS
TGRE-L	 RECTANGLE PLINTH*	Laminate	894	60
TGRE-V		Veneer	1054	60
TGSQ-L	 SQUARE PLINTH*	Laminate	894	70
TGSQ-V		Veneer	1054	70
TGMNT2	 MANHATTAN ROUND DOUBLE COLUMN	Spectone	354	22
TGMRT2	 MANHATTAN RECTANGULAR DOUBLE COLUMN	Spectone	390	22
TGMNT2-VWM	 MANHATTAN ROUND DOUBLE COLUMN WITH 1 OVAL VERTICAL WIRE MANAGER	Spectone	526	27
TGMNT2-RVWM	 MANHATTAN ROUND DOUBLE COLUMN WITH 1 RECTANGULAR VERTICAL WIRE MANAGER	Spectone	526	27
TGMNT2-VWM2	 MANHATTAN DOUBLE COLUMN WITH 2 OVAL VERTICAL WIRE MANAGERS	Spectone	699	32
TGMNT2-RVWM2	 MANHATTAN DOUBLE COLUMN WITH 2 RECTANGULAR VERTICAL WIRE MANAGERS	Spectone	699	32

\*Plinth Bases come standard with kickplate in Wilsonart 6257 Satin Brushed Natural Aluminum



TGRE

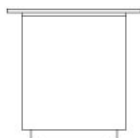

TGSQ

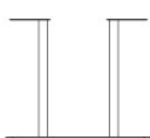

MANHATTAN  
DOUBLE COLUMN

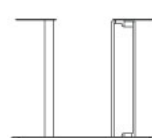

MANHATTAN DOUBLE COLUMN  
WITH 1 VERTICAL WIRE MANAGER

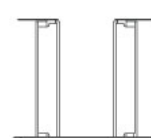

MANHATTAN DOUBLE COLUMN  
WITH 2 VERTICAL WIRE MANAGERS



# TAILGATE FREESTANDING TABLES TABLETOPS

Includes Power & Communication Trough









BACK TO CONTENTS



SIZE	TABLETOPS		TOP AND EDGE SPECIFICATIONS						TROUGHS		BASES		SEATS	LBS
	Model	Number of Sections	SE PVF PVB 2MM	For Laminate Top HF HB	HBV HBVR HBG	HF2 HB2 HKN4 HKNR4 HBG2	For Veneer Top HF HB HBV HBVR HBG	HF2 HB2 HKN4 HKNR4 HBG2	Number of Troughs	Length of Trough(s)	Number of Bases Required  TGRE TGMNT2 TGSQ		Number of Seats	
<i>Rectangle</i>														
48 x 96	TG4896RE	1	2362	3195	3421	3648	3986	4638	1	52	2	2	8	135
48 x 120	TG48120RE	2	2737	3812	4067	4616	4698	5459	1	76	3	2	10	168
48 x 144	TG48144RE	2	3637	5179	5514	6037	5913	6830	2	40	3	2	10	202
48 x 168	TG48168RE	2	4560	6112	6495	7225	7056	8122	2	52	3	3	12	236
48 x 192	TG48192RE	2	4855	6877	7342	8383	8027	9302	2	52	3	3	14	269
48 x 216	TG48216RE	2	5550	7552	8064	9171	8834	10271	2	76	3	3	14	303
60 x 120	TG60120RE	2	3180	4788	5139	5682	5553	6508	1	76	3	2	10	210
60 x 144	TG60144RE	2	4128	6057	6478	7128	6975	8121	2	40	3	2	12	252
60 x 168	TG60168RE	2	5001	7252	7740	8502	8321	9658	2	52	3	3	12	294
60 x 192	TG60192RE	2	5578	8277	8861	9775	9560	11164	2	52	3	3	14	336
60 x 216	TG60216RE	2	6137	9175	9836	10861	10619	12422	2	76	3	3	16	378

Note: Price of top includes troughs and power duplexes. Number of duplexes varies depending on trough size and number of troughs per table, see below. For custom trough configurations contact factory.

## BASES

MODEL	BASE SHAPE	FINISH	LIST PRICE	LBS
TGRE-L	 RECTANGLE PLINTH*	Laminate	894	60
TGRE-V		Veneer	1054	60
TGSQ-L	 SQUARE PLINTH*	Laminate	894	70
TGSQ-V		Veneer	1054	70
TGMNT2	 MANHATTAN ROUND DOUBLE COLUMN	Spectone	354	22
TGMRT2	 MANHATTAN RECTANGULAR DOUBLE COLUMN	Spectone	390	22
TGMNT2-VWM	 MANHATTAN ROUND DOUBLE COLUMN WITH 1 OVAL VERTICAL WIRE MANAGER	Spectone	526	27
TGMNT2-RVWM	 MANHATTAN ROUND DOUBLE COLUMN WITH 1 RECTANGULAR VERTICAL WIRE MANAGER	Spectone	526	27
TGMNT2-VWM2	 MANHATTAN DOUBLE COLUMN WITH 2 OVAL VERTICAL WIRE MANAGERS	Spectone	699	32
TGMNT2-RVWM2	 MANHATTAN DOUBLE COLUMN WITH 2 RECTANGULAR VERTICAL WIRE MANAGERS	Spectone	699	32

\*Plinth Bases come standard with kickplate in Wilsonart 6257 Satin Brushed Natural Aluminum



TGRE

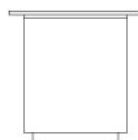

TGSQ



MANHATTAN  
DOUBLE COLUMN



MANHATTAN DOUBLE COLUMN  
WITH 1 VERTICAL WIRE MANAGER

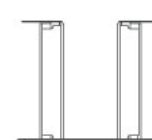

MANHATTAN DOUBLE COLUMN  
WITH 2 VERTICAL WIRE MANAGERS



# TAILGATE FREESTANDING TABLES TABLETOPS

Includes Power & Communication Trough

BACK TO CONTENTS



SIZE	TABLETOPS		TOP AND EDGE SPECIFICATIONS						TROUGHS		BASES		SEATS	LBS
	Model	Number of Sections	SE	For Laminate Top			For Veneer Top			Number of Troughs	Length of Trough(s)	Number of Bases Required		Number of Seats
			PVF	HF	HBV	HF2	HF	HF2			TGRE	TGSQ		
			PVB	HB	HBVR	HB2	HB	HB2						
			2MM		HBG	HKN4	HBV	HKN4						
						HKNR4	HBVR	HKNR4						
						HBG2	HBG	HBG2						
<i>Rectangle Arc Ends</i>														
48 x 96	TG4896REA	1	2382	3323	3552	4104	4494	5189	1	52	2	2	8	135
48 x 120	TG48120REA	2	2761	4255	4554	5315	5283	6095	1	76	3	2	10	168
48 x 144	TG48144REA	2	3664	5525	5891	6835	6616	7600	2	40	3	2	10	202
48 x 168	TG48168REA	2	4590	6613	7042	8089	7885	9026	2	52	3	3	12	236
48 x 192	TG48192REA	2	4761	7403	7913	8922	9192	9992	2	52	3	3	14	269
48 x 216	TG48216REA	2	5550	8174	8748	9999	10308	11085	2	76	3	3	14	303
60 x 120	TG60120REA	2	3170	5037	5408	6364	6321	7340	1	76	3	2	10	210
60 x 144	TG60144REA	2	4164	6489	6949	8130	7855	9085	2	40	3	2	12	252
60 x 168	TG60168REA	2	5207	7737	8272	9577	9325	10751	2	52	3	3	12	294
60 x 192	TG60192REA	2	5821	8858	9502	11067	11426	12476	2	52	3	3	14	336
60 x 216	TG60216REA	2	6413	9829	10552	12315	12718	13899	2	76	3	3	16	378

Note: Price of top includes troughs and power duplexes. Number of duplexes varies depending on trough size and number of troughs per table, see below. For custom trough configurations contact factory.

## BASES

MODEL	BASE SHAPE	FINISH	LIST PRICE	LBS
TGRE-L	RECTANGLE PLINTH*	Laminate	894	60
TGRE-V		Veneer	1054	60
TGSQ-L	SQUARE PLINTH*	Laminate	894	70
TGSQ-V		Veneer	1054	70
TGMNT2	MANHATTAN ROUND DOUBLE COLUMN	Spectone	354	22
TGMRT2	MANHATTAN RECTANGULAR DOUBLE COLUMN	Spectone	390	22
TGMNT2-VWM	MANHATTAN ROUND DOUBLE COLUMN WITH 1 OVAL VERTICAL WIRE MANAGER	Spectone	526	27
TGMNT2-RVWM	MANHATTAN ROUND DOUBLE COLUMN WITH 1 RECTANGULAR VERTICAL WIRE MANAGER	Spectone	526	27
TGMNT2-VWM2	MANHATTAN DOUBLE COLUMN WITH 2 OVAL VERTICAL WIRE MANAGERS	Spectone	699	32
TGMNT2-RVWM2	MANHATTAN DOUBLE COLUMN WITH 2 RECTANGULAR VERTICAL WIRE MANAGERS	Spectone	699	32

\*Plinth Bases come standard with kickplate in Wilsonart 6257 Satin Brushed Natural Aluminum



TGRE

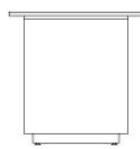

TGSQ



MANHATTAN  
DOUBLE COLUMN

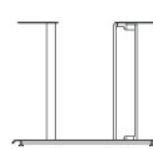

MANHATTAN DOUBLE COLUMN  
WITH 1 VERTICAL WIRE MANAGER

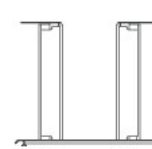

MANHATTAN DOUBLE COLUMN  
WITH 2 VERTICAL WIRE MANAGERS



# TAILGATE FREESTANDING TABLES TABLETOPS

Includes Power & Communication Trough

BACK TO CONTENTS



SIZE	TABLETOPS		TOP AND EDGE SPECIFICATIONS						TROUGHS		BASES		SEATS	LBS
	Model	Number of Sections	SE PVF PVB 2MM	For Laminate Top HF HB	HBV HBVR HBG	HF2 HB2 HKN4 HKNR4 HBG2	For Veneer Top HF HB HBV HBVR HBG	HF2 HB2 HKN4 HKNR4 HBG2	Number of Troughs	Length of Trough(s)	Number of Bases Required  TGRE TGMNT2 TGSQ		Number of Seats	
<i>Racetrack</i>														
48 x 96	TG4896RT	1	2382	3323	3552	4104	4494	5189	1	52	2	2	8	135
48 x 120	TG48120RT	2	2761	4255	4554	5315	5283	6095	1	76	3	2	10	168
48 x 144	TG48144RT	2	3664	5525	5891	6835	6616	7600	2	40	3	2	10	202
48 x 168	TG48168RT	2	4590	6613	7042	8089	7885	9026	2	52	3	3	12	236
48 x 192	TG48192RT	2	4761	7403	7913	8922	9192	9992	2	52	3	3	14	269
48 x 216	TG48216RT	2	5550	8174	8748	9999	10308	11085	2	76	3	3	14	303
60 x 120	TG60120RT	2	3170	5037	5408	6364	6321	7340	1	76	3	2	10	210
60 x 144	TG60144RT	2	4164	6489	6949	8130	7855	9085	2	40	3	2	12	252
60 x 168	TG60168RT	2	5207	7737	8272	9577	9325	10751	2	52	3	3	12	294
60 x 192	TG60192RT	2	5821	8858	9502	11067	11426	12476	2	52	3	3	14	336
60 x 216	TG60216RT	2	6413	9829	10552	12315	12718	13899	2	76	3	3	16	378

Note: Price of top includes troughs and power duplexes. Number of duplexes varies depending on trough size and number of troughs per table, see below. For custom trough configurations contact factory.



## BASES

MODEL	BASE SHAPE	FINISH	LIST PRICE	LBS
TGRE-L	RECTANGLE PLINTH*	Laminate	894	60
TGRE-V		Veneer	1054	60
TGSQ-L	SQUARE PLINTH*	Laminate	894	70
TGSQ-V		Veneer	1054	70
TGMNT2	MANHATTAN ROUND DOUBLE COLUMN	Spectone	354	22
TGMRT2	MANHATTAN RECTANGULAR DOUBLE COLUMN	Spectone	390	22
TGMNT2-VWM	MANHATTAN ROUND DOUBLE COLUMN WITH 1 OVAL VERTICAL WIRE MANAGER	Spectone	526	27
TGMNT2-RVWM	MANHATTAN ROUND DOUBLE COLUMN WITH 1 RECTANGULAR VERTICAL WIRE MANAGER	Spectone	526	27
TGMNT2-VWM2	MANHATTAN DOUBLE COLUMN WITH 2 OVAL VERTICAL WIRE MANAGERS	Spectone	699	32
TGMNT2-RVWM2	MANHATTAN DOUBLE COLUMN WITH 2 RECTANGULAR VERTICAL WIRE MANAGERS	Spectone	699	32

\*Plinth Bases come standard with kickplate in Wilsonart 6257 Satin Brushed Natural Aluminum



TGRE

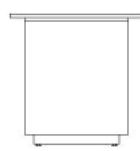

TGSQ

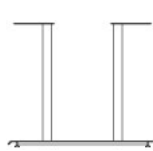

MANHATTAN  
DOUBLE COLUMN

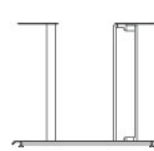

MANHATTAN DOUBLE COLUMN  
WITH 1 VERTICAL WIRE MANAGER

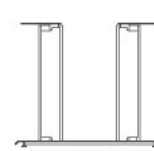

MANHATTAN DOUBLE COLUMN  
WITH 2 VERTICAL WIRE MANAGERS



BACK TO CONTENTS

# TAILGATE FREESTANDING TABLES TABLETOPS

Includes Power & Communication Trough



SIZE	TABLETOPS		TOP AND EDGE SPECIFICATIONS						TROUGHS		BASES		SEATS	LBS
	Model	Number of Sections	SE PVF PVB 2MM	For Laminate Top HF HB	HBV HBVR HBG	HF2 HB2 HKN4 HKNR4 HBG2	For Veneer Top HF HB HBV HBVR HBG	HF2 HB2 HKN4 HKNR4 HBG2	Number of Troughs	Length of Trough(s)	Number of Bases Required	TGRE TGMNT2	TGSQ	Number of Seats
<i>Boatshape</i>														
48 x 96	TG4896BT	1	2382	3965	4260	4564	4995	5374	1	52	2	2	8	135
48 x 120	TG48120BT	2	2761	4959	5325	5710	5875	6312	1	76	3	2	10	168
48 x 144	TG48144BT	2	3664	6229	6665	7128	7712	8110	2	40	3	2	10	202
48 x 168	TG48168BT	2	4590	7392	7899	8434	8707	9322	2	52	3	3	12	236
48 x 192	TG48192BT	2	4761	8198	8782	9940	10251	11171	2	52	3	3	14	269
48 x 216	TG48216BT	2	5550	9060	9720	11160	11516	12408	2	76	3	3	14	303
60 x 120	TG60120BT	2	3170	5915	6375	6856	7063	7607	1	76	3	2	10	210
60 x 144	TG60144BT	2	4164	7371	7916	8495	9223	9722	2	40	3	2	12	252
60 x 168	TG60168BT	2	5207	8710	9343	10012	10350	11121	2	52	3	3	12	294
60 x 192	TG60192BT	2	5821	10025	10785	11589	11995	12919	2	52	3	3	14	336
60 x 216	TG60216BT	2	6413	11142	11999	12902	13358	14399	2	76	3	3	16	378

Note: Price of top includes troughs and power duplexes. Number of duplexes varies depending on trough size and number of troughs per table, see below. For custom trough configurations contact factory.

## BASES

MODEL	BASE SHAPE	FINISH	LIST PRICE	LBS
TGRE-L	RECTANGLE PLINTH*	Laminate	894	60
TGRE-V		Veneer	1054	60
TGSQ-L	SQUARE PLINTH*	Laminate	894	70
TGSQ-V		Veneer	1054	70
TGMNT2	MANHATTAN ROUND DOUBLE COLUMN	Spectone	354	22
TGMRT2	MANHATTAN RECTANGULAR DOUBLE COLUMN	Spectone	390	22
TGMNT2-VWM	MANHATTAN ROUND DOUBLE COLUMN WITH 1 OVAL VERTICAL WIRE MANAGER	Spectone	526	27
TGMNT2-RVWM	MANHATTAN ROUND DOUBLE COLUMN WITH 1 RECTANGULAR VERTICAL WIRE MANAGER	Spectone	526	27
TGMNT2-VWM2	MANHATTAN DOUBLE COLUMN WITH 2 OVAL VERTICAL WIRE MANAGERS	Spectone	699	32
TGMNT2-RVWM2	MANHATTAN DOUBLE COLUMN WITH 2 RECTANGULAR VERTICAL WIRE MANAGERS	Spectone	699	32

\*Plinth Bases come standard with kickplate in Wilsonart 6257 Satin Brushed Natural Aluminum



TGRE

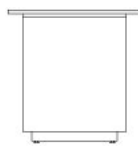

TGSQ

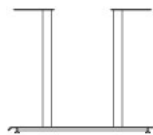

MANHATTAN  
DOUBLE COLUMN

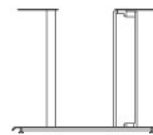

MANHATTAN DOUBLE COLUMN  
WITH 1 VERTICAL WIRE MANAGER

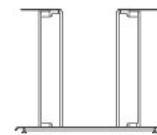

MANHATTAN DOUBLE COLUMN  
WITH 2 VERTICAL WIRE MANAGERS



# TAILGATE FREESTANDING TABLES TABLETOPS

Includes Power & Communication Trough

BACK TO CONTENTS



SIZE	TABLETOPS		TOP AND EDGE SPECIFICATIONS						TROUGHS		BASES		SEATS	LBS
	Model	Number of Sections	SE PVF PVB 2MM	For Laminate Top HF HB	HBV HBVR HBG	HF2 HB2 HKN4 HBG2	For Veneer Top HF HB HBV HBVR HBG	HF2 HB2 HKN4 HBG2	Number of Troughs	Length of Trough(s)	Number of Bases Required	TGRE TGMNT2	TGSQ	Number of Seats
<i>Boatshape Arc Ends</i>														
48 x 96	TG4896BTA	1	2542	4470	4766	5072	5500	5880	1	52	2	2	8	135
48 x 120	TG48120BTA	2	2922	5466	5832	6218	6382	6817	1	76	3	2	10	168
48 x 144	TG48144BTA	2	3825	6734	7173	7636	8217	8617	2	40	3	2	10	202
48 x 168	TG48168BTA	2	4752	7899	8407	8942	9212	9830	2	52	3	3	12	236
48 x 192	TG48192BTA	2	5025	8804	9447	10722	11065	12076	2	52	3	3	14	269
48 x 216	TG48216BTA	2	5878	9742	10468	12049	12442	13425	2	76	3	3	14	303
60 x 120	TG60120BTA	2	3372	6551	7007	7490	7695	8239	1	76	3	2	10	210
60 x 144	TG60144BTA	2	4364	8002	8550	9128	9856	10353	2	40	3	2	12	252
60 x 168	TG60168BTA	2	5407	9343	9976	10643	10985	11756	2	52	3	3	12	294
60 x 192	TG60192BTA	2	6064	10785	11546	12345	12755	13682	2	52	3	3	14	336
60 x 216	TG60216BTA	2	6687	11999	12854	13753	14213	15255	2	76	3	3	16	378

Note: Price of top includes troughs and power duplexes. Number of duplexes varies depending on trough size and number of troughs per table, see below. For custom trough configurations contact factory.

## BASES

MODEL	BASE SHAPE	FINISH	LIST PRICE	LBS	
TGRE-L		RECTANGLE PLINTH*	Laminate	894	60
TGRE-V		Veneer	1054	60	
TGSQ-L		SQUARE PLINTH*	Laminate	894	70
TGSQ-V		Veneer	1054	70	
TGMNT2		MANHATTAN ROUND DOUBLE COLUMN	Spectone	354	22
TGMRT2		MANHATTAN RECTANGULAR DOUBLE COLUMN	Spectone	390	22
TGMNT2-VWM		MANHATTAN ROUND DOUBLE COLUMN WITH 1 OVAL VERTICAL WIRE MANAGER	Spectone	526	27
TGMNT2-RVWM		MANHATTAN ROUND DOUBLE COLUMN WITH 1 RECTANGULAR VERTICAL WIRE MANAGER	Spectone	526	27
TGMNT2-VWM2		MANHATTAN DOUBLE COLUMN WITH 2 OVAL VERTICAL WIRE MANAGERS	Spectone	699	32
TGMNT2-RVWM2		MANHATTAN DOUBLE COLUMN WITH 2 RECTANGULAR VERTICAL WIRE MANAGERS	Spectone	699	32

\*Plinth Bases come standard with kickplate in Wilsonart 6257 Satin Brushed Natural Aluminum



TGRE

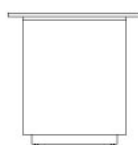

TGSQ

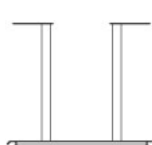

MANHATTAN DOUBLE COLUMN



MANHATTAN DOUBLE COLUMN WITH 1 VERTICAL WIRE MANAGER

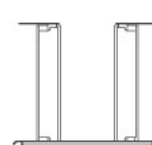

MANHATTAN DOUBLE COLUMN WITH 2 VERTICAL WIRE MANAGERS



# TAILGATE FREESTANDING TABLES TABLETOPS

Includes Power & Communication Trough

BACK TO CONTENTS



SIZE	TABLETOPS		TOP AND EDGE SPECIFICATIONS						TROUGHS		BASES		SEATS	LBS
	Model	Number of Sections	SE PVF PVB 2MM	For Laminate Top HF HB	HBV HBVR HBG	HF2 HB2 HKN4 HKNR4 HBG2	For Veneer Top HF HB HBV HBVR HBG	HF2 HB2 HKN4 HKNR4 HBG2	Number of Troughs	Length of Trough(s)	Number of Bases Required	TGRE TGMNT2	TGSQ	Number of Seats
<i>Ellipse</i>														
48 x 96	TG4896EL	1	2645	4544	4899	5265	5780	6234	1	52	2	2	6	135
48 x 120	TG48120EL	2	3089	5725	6165	6627	6826	7347	1	76	3	2	6	168
48 x 144	TG48144EL	2	4063	7141	7665	8222	8921	9400	2	40	3	2	8	202
48 x 168	TG48168EL	2	5084	8445	9054	9695	9997	10762	2	52	3	3	10	236
48 x 192	TG48192EL	2	5313	9472	10179	11580	11959	13071	2	52	3	3	10	269
48 x 216	TG48216EL	2	6240	10490	11288	13028	13459	14541	2	76	3	3	12	303
60 x 120	TG60120EL	2	3709	7364	7889	8444	8680	9305	1	76	3	2	8	210
60 x 144	TG60144EL	2	4769	8952	9582	10248	11084	11657	2	40	3	2	10	252
60 x 168	TG60168EL	2	5900	10426	11154	11921	12314	13200	2	52	3	3	10	294
60 x 192	TG60192EL	2	6655	12083	12958	13878	14350	15415	2	52	3	3	12	336
60 x 216	TG60216EL	2	7352	13459	14443	15477	16007	17204	2	76	3	3	14	378

Note: Price of top includes troughs and power duplexes. Number of duplexes varies depending on trough size and number of troughs per table, see below. For custom trough configurations contact factory.

## BASES

MODEL	BASE SHAPE	FINISH	LIST PRICE	LBS
TGRE-L	RECTANGLE PLINTH*	Laminate	894	60
TGRE-V		Veneer	1054	60
TGSQ-L	SQUARE PLINTH*	Laminate	894	70
TGSQ-V		Veneer	1054	70
TGMNT2	MANHATTAN ROUND DOUBLE COLUMN	Spectone	354	22
TGMRT2	MANHATTAN RECTANGULAR DOUBLE COLUMN	Spectone	390	22
TGMNT2-VWM	MANHATTAN ROUND DOUBLE COLUMN WITH 1 OVAL VERTICAL WIRE MANAGER	Spectone	526	27
TGMNT2-RVWM	MANHATTAN ROUND DOUBLE COLUMN WITH 1 RECTANGULAR VERTICAL WIRE MANAGER	Spectone	526	27
TGMNT2-VWM2	MANHATTAN DOUBLE COLUMN WITH 2 OVAL VERTICAL WIRE MANAGERS	Spectone	699	32
TGMNT2-RVWM2	MANHATTAN DOUBLE COLUMN WITH 2 RECTANGULAR VERTICAL WIRE MANAGERS	Spectone	699	32

\*Plinth Bases come standard with kickplate in Wilsonart 6257 Satin Brushed Natural Aluminum



TGRE

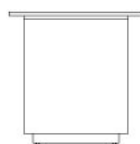

TGSQ



MANHATTAN  
DOUBLE COLUMN

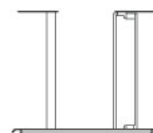

MANHATTAN DOUBLE COLUMN  
WITH 1 VERTICAL WIRE MANAGER

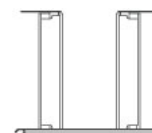

MANHATTAN DOUBLE COLUMN  
WITH 2 VERTICAL WIRE MANAGERS





# TAILGATE FREESTANDING TABLES TABLETOPS

Includes Power & Communication Trough



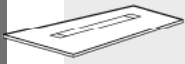





BACK TO CONTENTS



SIZE	TABLETOPS		TOP AND EDGE SPECIFICATIONS						TROUGHS		BASES		SEATS	LBS
	Model	Number of Sections	SE	For Laminate Top			For Veneer Top			Number of Troughs	Length of Trough(s)	Number of Bases Required		Number of Seats
			PVF	HF	HBV	HF2	HF	HF2			TGRE	TGSQ		
			PVB	HB	HBVR	HB2	HB	HB2						
			2MM		HVG	HKN4	HBV	HKN4						
						HKNR4	HBVR	HKNR4						
						HVG2	HVG	HVG2						
<i>Video Conference</i>														
48 x 96	TG4896VC	1	2382	3965	4260	4564	4995	5374	1	52	2	2	8	135
48 x 120	TG48120VC	2	2761	4959	5325	5710	5875	6312	1	76	3	2	10	168
48 x 144	TG48144VC	2	3664	6229	6665	7128	7712	8110	2	40	3	2	10	202
48 x 168	TG48168VC	2	4590	7392	7899	8434	8687	9322	2	52	3	3	12	236
48 x 192	TG48192VC	2	4761	8198	8782	9940	10251	11171	2	52	3	3	14	269
48 x 216	TG48216VC	2	5550	9060	9720	11160	11516	12408	2	76	3	3	14	303
60 x 120	TG60120VC	2	3170	5915	6375	6856	7063	7607	1	76	3	2	10	210
60 x 144	TG60144VC	2	4164	7371	7916	8495	9223	9722	2	40	3	2	12	252
60 x 168	TG60168VC	2	5207	8710	9343	10012	10350	11121	2	52	3	3	12	294
60 x 192	TG60192VC	2	5821	10025	10785	11589	11995	12919	2	52	3	3	14	336
60 x 216	TG60216VC	2	6413	11142	11999	12902	13358	14399	2	76	3	3	14	378

Note: Price of top includes troughs and power duplexes. Number of duplexes varies depending on trough size and number of troughs per table, see below. For custom trough configurations contact factory.

## BASES

MODEL	BASE SHAPE	FINISH	LIST PRICE	LBS
TGRE-L	 RECTANGLE PLINTH*	Laminate	894	60
TGRE-V		Veneer	1054	60
TGSQ-L	 SQUARE PLINTH*	Laminate	894	70
TGSQ-V		Veneer	1054	70
TGMNT2	 MANHATTAN ROUND DOUBLE COLUMN	Spectone	354	22
TGMRT2	 MANHATTAN RECTANGULAR DOUBLE COLUMN	Spectone	390	22
TGMNT2-VWM	 MANHATTAN ROUND DOUBLE COLUMN WITH 1 OVAL VERTICAL WIRE MANAGER	Spectone	526	27
TGMNT2-RVWM	 MANHATTAN ROUND DOUBLE COLUMN WITH 1 RECTANGULAR VERTICAL WIRE MANAGER	Spectone	526	27
TGMNT2-VWM2	 MANHATTAN DOUBLE COLUMN WITH 2 OVAL VERTICAL WIRE MANAGERS	Spectone	699	32
TGMNT2-RVWM2	 MANHATTAN DOUBLE COLUMN WITH 2 RECTANGULAR VERTICAL WIRE MANAGERS	Spectone	699	32

\*Plinth Bases come standard with kickplate in Wilsonart 6257 Satin Brushed Natural Aluminum



TGRE

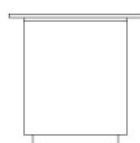

TGSQ

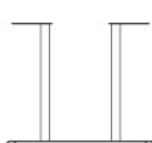

MANHATTAN DOUBLE COLUMN



MANHATTAN DOUBLE COLUMN WITH 1 VERTICAL WIRE MANAGER

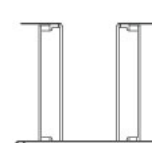

MANHATTAN DOUBLE COLUMN WITH 2 VERTICAL WIRE MANAGERS



# TAILGATE FREESTANDING TABLES TABLETOPS

Includes Power & Communication Trough

BACK TO CONTENTS



SIZE	TABLETOPS		TOP AND EDGE SPECIFICATIONS						TROUGHS		BASES		SEATS	LBS
	Model	Number of Sections	For Laminate Top			For Veneer Top			Number of Troughs	Length of Trough(s)	Number of Bases Required		Number of Seats	
			SE PVF PVB 2MM	HF HB	HBV HBVR HBG	HF2 HB2 HKN4 HBG2	HF HB HBV HBVR HBG	HF2 HB2 HKN4 HBG2			TGRE TGMNT2	TGSQ		
<i>Video Conference</i>														
<i>Arc Ends</i>														
48 x 96	TG4896VCA	1	2542	4470	4766	5072	5500	5880	1	52	2	2	8	135
48 x 120	TG48120VCA	2	2922	5466	5832	6218	6382	6817	1	76	3	2	10	168
48 x 144	TG48144VCA	2	3825	6734	7173	7636	8217	8617	2	40	3	2	10	202
48 x 168	TG48168VCA	2	4752	7899	8407	8942	9212	9830	2	52	3	3	12	236
48 x 192	TG48192VCA	2	5025	8804	9447	10722	11065	12076	2	52	3	3	14	269
48 x 216	TG48216VCA	2	5878	9742	10468	12049	12442	13425	2	76	3	3	14	303
60 x 120	TG60120VCA	2	3372	6551	7007	7490	7695	8239	1	76	3	2	10	210
60 x 144	TG60144VCA	2	4364	8002	8550	9128	9856	10353	2	40	3	2	12	252
60 x 168	TG60168VCA	2	5407	9343	9976	10643	10985	11756	2	52	3	3	12	294
60 x 192	TG60192VCA	2	6064	10785	11546	12345	12755	13682	2	52	3	3	14	336
60 x 216	TG60216VCA	2	6687	11999	12854	13753	14213	15255	2	76	3	3	14	378

Note: Price of top includes troughs and power duplexes. Number of duplexes varies depending on trough size and number of troughs per table, see below. For custom trough configurations contact factory.

## BASES

MODEL	BASE SHAPE	FINISH	LIST PRICE	LBS
TGRE-L	RECTANGLE PLINTH*	Laminate	894	60
TGRE-V		Veneer	1054	60
TGSQ-L	SQUARE PLINTH*	Laminate	894	70
TGSQ-V		Veneer	1054	70
TGMNT2	MANHATTAN ROUND DOUBLE COLUMN	Spectone	354	22
TGMRT2	MANHATTAN RECTANGULAR DOUBLE COLUMN	Spectone	390	22
TGMNT2-VWM	MANHATTAN ROUND DOUBLE COLUMN WITH 1 OVAL VERTICAL WIRE MANAGER	Spectone	526	27
TGMNT2-RVWM	MANHATTAN ROUND DOUBLE COLUMN WITH 1 RECTANGULAR VERTICAL WIRE MANAGER	Spectone	526	27
TGMNT2-VWM2	MANHATTAN DOUBLE COLUMN WITH 2 OVAL VERTICAL WIRE MANAGERS	Spectone	699	32
TGMNT2-RVWM2	MANHATTAN DOUBLE COLUMN WITH 2 RECTANGULAR VERTICAL WIRE MANAGERS	Spectone	699	32

\*Plinth Bases come standard with kickplate in Wilsonart 6257 Satin Brushed Natural Aluminum



TGRE

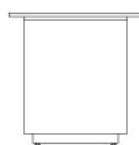

TGSQ



MANHATTAN  
DOUBLE COLUMN

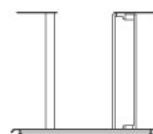

MANHATTAN DOUBLE COLUMN  
WITH 1 VERTICAL WIRE MANAGER

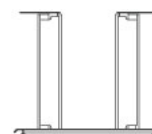

MANHATTAN DOUBLE COLUMN  
WITH 2 VERTICAL WIRE MANAGERS



# TAILGATE FREESTANDING TABLES PLINTH BASE - POWER AND VOICE/DATA MODULES

BACK TO CONTENTS

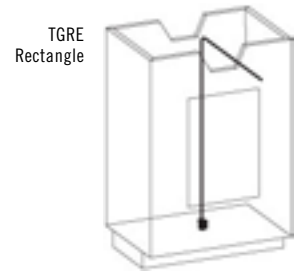
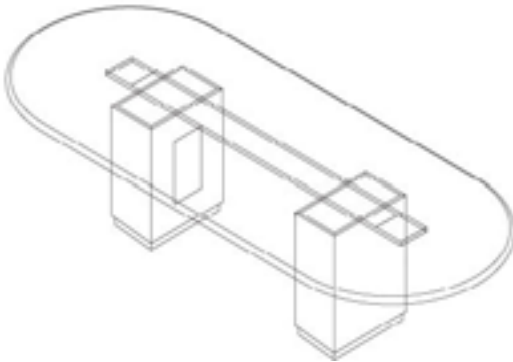
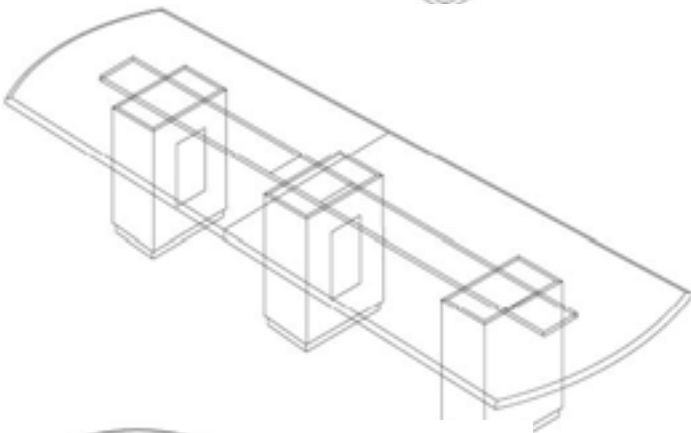
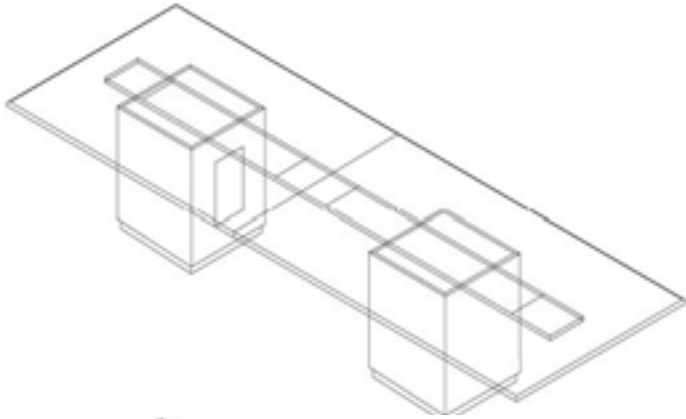

TGRE  
Rectangle

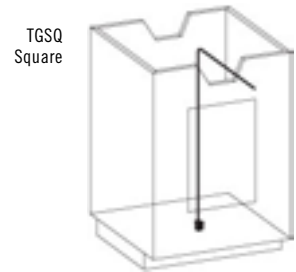

TGSQ  
Square



All Tailgate bases are standard with a touch latch removable door

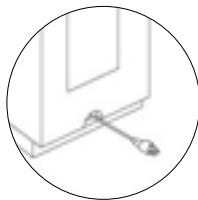

Optional cutout for wire pass-through at the bottom of Tailgate bases must be specified if required



# POWER AND VOICE/DATA ACCESSORIES TAILGATE

Each trough is standard with power duplexes (labelled P) with a 9 ft. cord. Cutouts for data and communication (labelled D) are also included, however, data ports must be specified separately and can be configured to meet specific requirements. Specify blank plates when data and communication is not required at no upcharge.

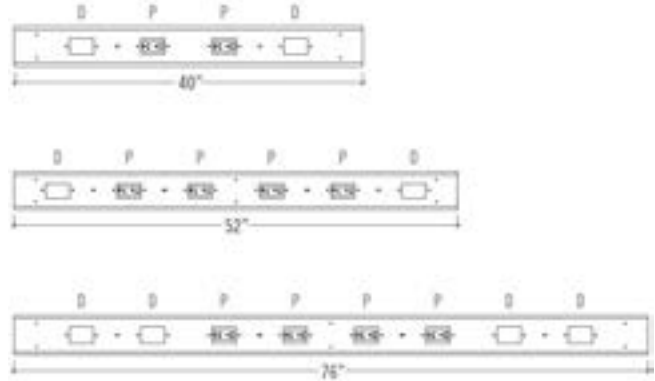

Units in data plates must equal 3. Plates can be made up of items that equal 1 unit each for a total of 3 units or a combination of items that total 3 units.

**Example 1**

**Example 2**

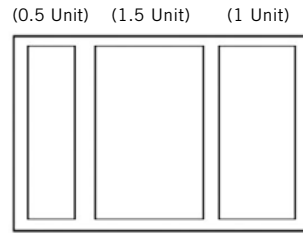
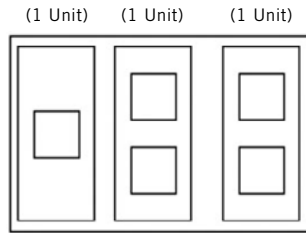

**OPTION 2** - \$290 List  
15 Pin VGA, 3.5mm Stereo  
(1.5 Unit)  
Front: 15 Pin VGA Female,  
3.5mm  
Back: Solder



**OPTION 11** - \$126 List  
15 Pin VGA  
(1 Unit)  
Front: 15 Pin Female  
Back: 15 Pin Female



**OPTION 13** - No Charge  
Blank  
(0.5 Unit)



**OPTION 14** - No Charge  
Blank  
(1 Unit)



**OPTION 15** - No Charge  
Blank  
(1.5 Unit)



**OPTION 30** - \$60 List  
RJ 11 (cat. 3)/  
RJ 45 (cat. 6)  
(1 Unit)



**OPTION 17** - \$70 List  
RJ 11 (cat. 3) X 2  
(1 Unit)



**OPTION 28** - \$52 List  
RJ 45 (cat. 6) X 2  
(1 Unit)



**OPTION 19** - \$40 List  
RJ 11 (cat. 3) X 1  
(1 Unit)



**OPTION 29** - \$31 List  
RJ 45 (cat. 6) X 1  
(1 Unit)



**OPTION 21** - \$315 List  
USB 2.0 Performance  
(1 Unit)  
Front: Type A & B (F/F)  
Back: Type A & B (F/F)



**OPTION 22** - \$309 List  
USB 2.0 Performance  
(1 Unit)  
Front: Type A & A (F/F)  
Back: Type A & A (F/F)



**OPTION 23** - \$399 List  
HDMI-A/V Connector  
(1 Unit)  
Front: Female  
Back: Female



**OPTION 32** - \$194 List  
RJ 45 (cat. 6)  
USB 2.0 (F/F) Type A & A  
(1 Unit)

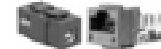

**OPTION 26** - \$194 List  
RJ 45 (cat. 6)  
USB 2.0 (F/F) Type A to B  
(1 Unit)



**OPTION 27** - \$209 List  
RJ 11 (cat. 3)  
USB 2.0 (F/F) Type A to B  
(1 Unit)



# VOICE/DATA ACCESSORIES TAILGATE

Examples of 1 Data Plate

BACK TO CONTENTS



## PLATE CONFIGURATION OPTIONS FOR DATA & PHONE

### 6X RJ 45 (CAT. 6)

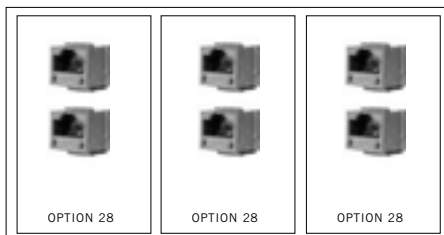

**CONFIGURATION A**  
Consists of the following:

3x **OPTION 28** = \$52 LIST  
**TOTAL LIST = \$156 LIST**

### 1X RJ 11 (CAT. 3), AND 5X RJ 45 (CAT. 6)

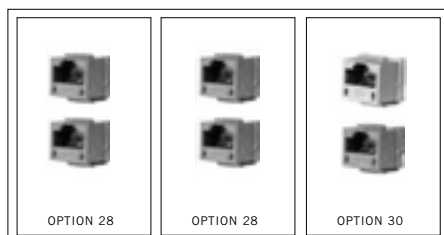

**CONFIGURATION B**  
Consists of the following:

1x **OPTION 30** = \$60 LIST  
2x **OPTION 28** = \$52 LIST  
**TOTAL LIST = \$164 LIST**

## PLATE CONFIGURATION OPTIONS FOR AUDIO/VIDEO

### 1X 15 PIN VGA, BLANK AND RJ 11, RJ 45 (CAT. 6)

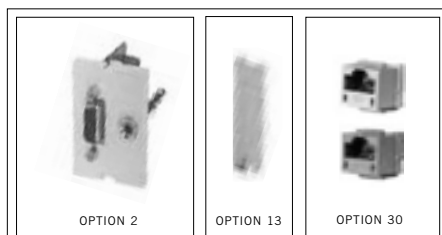

**CONFIGURATION C**  
Consists of the following:

1x **OPTION 2** = \$290 LIST  
1x **OPTION 13** = NO CHARGE  
1x **OPTION 30** = \$60 LIST  
**TOTAL LIST = \$350 LIST**

### 1X HDMI A/V CONNECTOR, 15 PIN V99 AND BLANK



**CONFIGURATION D**  
Consists of the following:

1x **OPTION 23** = \$399 LIST  
1x **OPTION 2** = \$290 LIST  
1x **OPTION 13** = NO CHARGE  
**TOTAL LIST = \$689 LIST**

# TRIOUS TABLES



PLACING AN ORDER IS EASY

## PRODUCT CODE

**2430 RE TST**

**Size**

Width x Length

**Top Shape**

- DIA : Round
- SQ : Square
- RE : Rectangle
- RT : Racetrack
- B : Bullet
- H : Halfmoon
- TP : Trapezoid
- CRC90 : Crescent

**Series**

Trius

**Base**

- X : X-Base
- X4 : 4 Column X-Base
- T : T-Base
- TV : V-Base
- T2 : Double Column T-Base

## OPTIONS

**FLIP TOP**



**CASTERS**



**FOLDING**



**FOOT**



TST



TSV

## FINISHES

**LAMINATE**



Select laminate from our virtually unlimited laminate options

**VENEER**

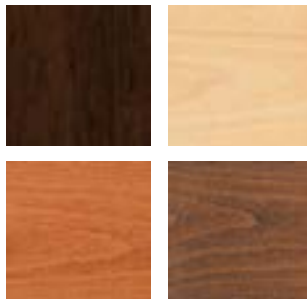

Select from one of our 7 standard wood stains or stain-to-match at no upcharge

**BASE**



Select from one of our 76 standard Spectone colors

**EDGE**



2MM

PVC

Hard Wood

Check out our website for a complete list of edge profiles.



# TRUIS TABLES



BACK TO CONTENTS

MODEL		BASES		TOP SPECIFICATIONS					OPTIONS			MOBILITY	LBS
Size / Shape	Code	#of	For Laminate Top			For Veneer Top		FLIP TOP	FOLD	BAR HEIGHT	CASTERS		
			SE PVF PVB 2MM	HF HB	HBV HBVR HBG	HF2 HB2 HKN4 HKNR4 HBG2	HF HB HBV HBVR HBG	HF2 HB2 HKN4 HKNR4 HBG2	Add	Add	Add	Add	
<b>ROUND</b>													
24 DIA	TSX	1	711	1040	1074	1174	1227	1330	141	-	35	84	34
30 DIA	TSX	1	806	1130	1174	1373	1322	1473	141	-	35	84	44
36 DIA	TSX	1	896	1367	1449	1612	1662	1871	141	-	35	84	55
42 DIA	TSX	1	1157	1684	1798	2040	2065	2351	141	-	-	84	69
42 DIA	TSX4	1	1360	1887	2001	2243	2268	2554	-	-	-	84	74
48 DIA	TSX4	1	1381	2089	2213	2333	2767	3135	-	-	-	84	93
<b>SQUARE</b>													
24x24 SQ	TSX	1	739	918	952	1014	1059	1213	141	-	35	84	34
30x30 SQ	TSX	1	837	967	1014	1178	1119	1330	141	-	35	84	44
36x36 SQ	TSX	1	914	1118	1174	1367	1373	1557	141	-	35	84	55
42x42 SQ	TSX4	1	1374	1669	1760	1851	1914	2165	-	-	-	84	77
48x48 SQ	TSX4	1	1515	1774	1870	1912	2259	2581	-	-	-	84	93
<b>RECTANGLE</b>													
20x42 RE	TST, TSTV	2	924	1120	1171	1263	1319	1485	-	-	-	84	66
20x48 RE	TST, TSTV	2	924	1120	1171	1263	1319	1485	282	-	-	84	71
20x54 RE	TST, TSTV	2	979	1265	1330	1436	1515	1718	282	-	-	84	74
20x60 RE	TST, TSTV	2	979	1265	1330	1436	1515	1718	282	273*	-	84	79
20x66 RE	TST, TSTV	2	1115	1459	1539	1668	1752	2001	282	273*	-	84	83
20x72 RE	TST, TSTV	2	1115	1459	1539	1668	1752	2001	282	273*	-	84	88

\*Spec does not offer folding tables with V shaped bases. Folding tables available with PVC Bullnose edge only.



### NOTES AND OPTIONS

- Laminite Tops are available in any standard Wilsonart, Nevamar, Formica, Arborite or Pionite matte Finish.
- For other laminates please contact the factory.
- Veneers and hardwood edge stains are standard in Maple, Pecan, Mahogany, Cherry, Oak, Walnut and Chocolate or Stain-to-Match at no upcharge.
- Standard with leveling glides.
- Bases available in any Spectone color.
- T and TV bases are available at the same price. Specify TST or TSTV when ordering.
- Standard 29" table height.
- Locking Casters are not self-leveling.
- Table Carts are available for folding tables. Holds 6 tables.
- Base span increases with size of top.
- For table accessories, including grommets, seam connectors and modesty panels, refer to table accessories price list.



# TRIOUS TABLES

BACK TO CONTENTS

MODEL		BASES		TOP SPECIFICATIONS						OPTIONS			MOBILITY	LBS
Size / Shape	Code	#of	For Laminate Top			For Veneer Top			FLIP TOP	FOLD	BAR HEIGHT	CASTERS		
			SE PVF PVB 2MM	HF HB	HBV HBVR HBG	HF2 HB2 HKN4 HKNR4 HBG2	HF HB HBV HBVR HBG	HF2 HB2 HKN4 HKNR4 HBG2	Add	Add	Add	Add		
<b>RECTANGLE</b>														
24x30 RE	TSX	1	826	948	992	1055	1104	1223	141	-	-	-	43	
24x30 RE	TST, TSTV	2	863	985	1029	1092	1141	1260	282	-	-	84	58	
24x36 RE	TSX	1	826	948	992	1055	1104	1223	141	-	-	-	48	
24x36 RE	TST, TSTV	2	863	985	1029	1092	1141	1260	282	-	-	84	63	
24x42 RE	TST, TSTV	2	924	1120	1171	1263	1319	1485	282	-	-	84	66	
24x48 RE	TST, TSTV	2	924	1120	1171	1263	1319	1485	282	-	-	84	71	
24x54 RE	TST, TSTV	2	979	1265	1330	1436	1515	1718	282	-	-	84	74	
24x60 RE	TST, TSTV	2	979	1265	1330	1436	1515	1718	282	273*	-	84	79	
24x66 RE	TST, TSTV	2	1115	1459	1539	1668	1752	2001	282	273*	-	84	83	
24x72 RE	TST, TSTV	2	1115	1459	1539	1668	1752	2001	282	273*	-	84	88	
<b>RECTANGLE</b>														
30x36 RE	TSX	1	914	1055	1105	1185	1243	1387	141	-	-	-	59	
30x36 RE	TST, TSTV	2	951	1092	1142	1222	1280	1424	282	-	-	84	64	
30x42 RE	TST, TSTV	2	970	1239	1301	1407	1485	1687	282	-	-	84	74	
30x48 RE	TST, TSTV	2	970	1239	1301	1407	1485	1687	282	-	-	84	79	
30x54 RE	TST, TSTV	2	1025	1392	1472	1623	1713	1966	282	-	-	84	85	
30x60 RE	TST, TSTV	2	1025	1392	1472	1623	1713	1966	282	273*	-	84	90	
30x66 RE	TST, TSTV	2	1188	1484	1581	1735	1822	2102	282	273*	-	84	95	
30x72 RE	TST, TSTV	2	1240	1627	1725	1923	2026	2333	282	273*	-	84	100	
30x78 RE	TST, TSTV	2	1450	1792	1908	2138	2259	2612	282	273*	-	84	106	
30x84 RE	TST, TSTV	2	1450	1792	1908	2138	2259	2612	282	273*	-	84	111	
30x90 RE	TST, TSTV	2	1469	1999	2138	2351	2494	2896	282	273*	-	84	116	
30x96 RE	TST, TSTV	2	1469	1999	2138	2351	2494	2896	282	273*	-	84	121	

\*Spec does not offer folding tables with V shaped bases. Folding tables available with PVC Bullnose edge only.



### NOTES AND OPTIONS

- Laminate Tops are available in any standard Wilsonart, Nevamar, Formica, Arborite or Pionite matte Finish.
- For other laminates please contact the factory.
- Veneers and hardwood edge stains are standard in Maple, Pecan, Mahogany, Cherry, Oak, Walnut and Chocolate or Stain-to-Match at no upcharge.
- Standard with leveling glides.
- Bases available in any Spectone color.
- T and TV bases are available at the same price. Specify TST or TSTV when ordering.
- Standard 29" table height.
- Locking Casters are not self-leveling.
- Table Carts are available for folding tables. Holds 6 tables.
- Base span increases with size of top.
- For table accessories, including grommets, seam connectors and modesty panels, refer to table accessories price list.





# TRUIS TABLES

BACK TO CONTENTS

MODEL		BASES		TOP SPECIFICATIONS						OPTIONS			MOBILITY	LBS
Size / Shape	Code	#of	For Laminate Top			For Veneer Top			FLIP TOP	FOLD	BAR HEIGHT	CASTERS		
			SE PVF PVB 2MM	HF HB	HBV HBVR HBG	HF2 HB2 HKN4 HKNR4 HBG2	HF HB HBV HBVR HBG	HF2 HB2 HKN4 HKNR4 HBG2	Add	Add	Add	Add		
<b>RECTANGLE</b>														
36x42 RE	TST, TSTV	2	1063	1265	1343	1449	1530	1742	282	-	-	84	83	
36x48 RE	TST, TSTV	2	1087	1372	1455	1581	1665	1912	282	-	-	84	88	
36x54 RE	TST, TSTV	2	1159	1468	1563	1705	1809	2081	282	-	-	84	90	
36x60 RE	TST, TSTV	2	1177	1574	1675	1836	1938	2247	282	273*	-	84	95	
36x66 RE	TST, TSTV	2	1259	1671	1787	1964	2075	2415	282	273*	-	84	94	
36x66 RE	TST2	2	1521	1933	2049	2226	2337	2677	282	547*	-	84	108	
36x72 RE	TST, TSTV	2	1295	1725	1836	2092	2215	2583	282	273*	-	84	107	
36x72 RE	TST2	2	1557	1987	2098	2354	2477	2845	-	547*	-	84	115	
36x78 RE	TST, TSTV	2	1608	2068	2212	2434	2579	3012	282	273*	-	84	114	
36x78 RE	TST2	2	1870	2330	2474	2696	2841	3274	-	547*	-	84	121	
36x84 RE	TST, TSTV	2	1608	2068	2212	2434	2579	3012	282	273*	-	84	120	
36x84 RE	TST2	2	1870	2330	2474	2696	2841	3274	-	547*	-	84	127	
36x90 RE	TST, TSTV	2	1613	2269	2434	2693	2859	3340	282	273*	-	84	126	
36x90 RE	TST2	2	1875	2531	2696	2955	3121	3602	-	547*	-	84	133	
36x96 RE	TST, TSTV	2	1613	2269	2434	2693	2859	3340	282	267*	-	84	132	
36x96 RE	TST2	2	1875	2531	2696	2955	3121	3602	-	547*	-	84	135	
<b>RECTANGLE</b>														
42x78 RE	TST2	2	2096	2492	2650	3032	3158	3660	-	547*	-	84	143	
42x84 RE	TST2	2	2096	2492	2650	3032	3158	3660	-	547*	-	84	148	

\*Spec does not offer folding tables with V shaped bases. Folding tables available with PVC Bullnose edge only.

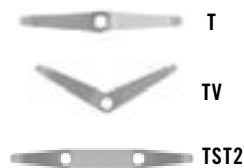

TST2



TST



TSTV



TSTV FLIP-TOP WITH CASTERS

### NOTES AND OPTIONS

- Laminates are available in any standard Wilsonart, Nevamar, Formica, Arborite or Pionite matte Finish.
- For other laminates please contact the factory.
- Veneers and hardwood edge stains are standard in Maple, Pecan, Mahogany, Cherry, Oak, Walnut and Chocolate or Stain-to-Match at no upcharge.
- Standard with leveling glides.
- Bases available in any Spectone color.
- T and TV bases are available at the same price. Specify TST or TSTV when ordering.

- Standard 29" table height.
- Locking Casters are not self-leveling.
- Table Carts are available for folding tables. Holds 6 tables.
- Base span increases with size of top.
- For table accessories, including grommets, seam connectors and modesty panels, refer to table accessories price list.



# TRUIS TABLES

BACK TO CONTENTS

MODEL		BASES		TOP SPECIFICATIONS						OPTIONS			MOBILITY	LBS
Size / Shape	Code	#of	For Laminate Top			For Veneer Top			FLIP TOP	FOLD	BAR HEIGHT	CASTERS		
			SE PVF PVB 2MM	HF HB	HBV HBVR HBG	HF2 HB2 HKN4 HKG2	HF HB HBV HBVR HBG	HF2 HB2 HKN4 HKG2	Add	Add	Add	Add		
<b>RACETRACK</b>														
36x54 RT	TST, TSTV	2	1229	1752	1874	2092	2181	2500	282	-	-	84	84	
36x54 RT	TST2	2	1491	2014	2136	2354	2443	2762	-	-	-	84	90	
36x60 RT	TST, TSTV	2	1229	1752	1874	2092	2181	2500	282	-	-	84	89	
36x60 RT	TST2	2	1491	2014	2136	2354	2443	2762	-	-	-	84	95	
36x66 RT	TST, TSTV	2	1377	1923	2055	2288	2494	2892	282	-	-	84	94	
36x66 RT	TST2	2	1639	2185	2317	2550	2756	3154	-	-	-	84	108	
36x72 RT	TST, TSTV	2	1377	1923	2055	2288	2494	2892	282	-	-	84	107	
36x72 RT	TST2	2	1639	2185	2317	2550	2756	3154	-	-	-	84	115	
36x78 RT	TST, TSTV	2	1623	2317	2479	2832	2906	3371	282	-	-	84	114	
36x78 RT	TST2	2	1885	2579	2741	3094	3168	3633	-	-	-	84	121	
36x84 RT	TST, TSTV	2	1623	2317	2479	2832	2906	3371	282	-	-	84	120	
36x84 RT	TST2	2	1885	2579	2741	3094	3168	3633	-	-	-	84	127	
36x90 RT	TST, TSTV	2	1627	2553	2746	3141	3233	3762	282	-	-	84	130	
36x90 RT	TST2	2	1889	2815	3008	3403	3495	4024	-	-	-	84	133	
36x96 RT	TST, TSTV	2	1627	2553	2746	3141	3233	3762	282	-	-	84	130	
36x96 RT	TST2	2	1889	2815	3008	3403	3495	4024	-	-	-	84	135	
<b>RACETRACK</b>														
42x78 RT	TST2	2	2110	2766	2965	3364	3460	3995	-	-	-	84	143	
42x84 RT	TST2	2	2110	2766	2965	3364	3460	3995	-	-	-	84	148	
<b>RACETRACK</b>														
48x78 RT	TST2	2	2113	3048	3273	3626	3847	4455	-	-	-	84	143	
48x84 RT	TST2	2	2113	3048	3273	3626	3847	4455	-	-	-	84	148	



TST2



TST



TSTV



TSTV FLIP-TOP WITH CASTERS

**NOTES AND OPTIONS**

- Laminate Tops are available in any standard Wilsonart, Nevamar, Formica, Arborite or Pionite matte Finish.
- For other laminates please contact the factory.
- Veneers and hardwood edge stains are standard in Maple, Pecan, Mahogany, Cherry, Oak, Walnut and Chocolate or Stain-to-Match at no upcharge.
- Standard with leveling glides.
- Bases available in any Spectone color.
- T and TV bases are available at the same price. Specify TST or TSTV when ordering.

- Standard 29" table height.
- Locking Casters are not self-leveling.
- Table Carts are available for folding tables. Holds 6 tables.
- Base span increases with size of top.
- For table accessories, including grommets, seam connectors and modesty panels, refer to table accessories price list.



# TRUIS TABLES



BACK TO CONTENTS

MODEL		BASES		TOP SPECIFICATIONS						OPTIONS			MOBILITY	LBS
Size / Shape	Code	#of	For Laminate Top			For Veneer Top			FLIP TOP	FOLD	BAR HEIGHT	CASTERS		
			SE PVF PVB 2MM	HF HB	HBV HBVR HBG	HF2 HB2 HKN4 HKNR4 HBG2	HF HB HBV HBVR HBG	HF2 HB2 HKN4 HKNR4 HBG2	FLIP TOP <i>Add</i>	FOLD <i>Add</i>	BAR HEIGHT <i>Add</i>	CASTERS <i>Add</i>		
<b>BULLET</b>														
30x54 B	TST, TSTV	2	1137	1658	1766	1957	2013	2329	282	-	-	84	85	
30x60 B	TST, TSTV	2	1137	1658	1766	1957	2013	2329	282	-	-	84	90	
36x54 B	TST, TSTV	2	1250	2125	2280	2559	2597	2994	282	-	-	84	90	
36x60 B	TST, TSTV	2	1250	2125	2280	2559	2597	2994	282	-	-	84	95	
36x66 B	TST, TSTV	2	1376	2344	2515	2813	2986	3484	282	-	-	84	108	
36x72 B	TST, TSTV	2	1376	2344	2515	2813	2986	3484	282	-	-	84	115	
<b>HALFMOON</b>														
24x48 H	TST, TSTV	2	940	1410	1528	1671	1787	2055	282	-	-	84	71	
30x60 H	TST, TSTV	2	1137	1837	2000	2160	2361	2743	282	-	-	84	90	
36x72 H	TST, TSTV	2	1376	2332	2543	2740	3067	3583	282	-	-	84	115	
<b>TRAPEZOID</b>														
30x60 TP	TST, TSTV	2	1137	1568	1668	1842	1892	2184	282	-	-	84	90	
36x72 TP	TST, TSTV	2	1376	1960	2093	2393	2467	2888	282	-	-	84	115	
<b>CRESCENT</b>														
30x36 CRC90	TST, TSTV	2	1114	1742	1821	1883	2083	2302	-	-	-	84	48	
36x42 CRC90	TST, TSTV	2	1447	2036	2144	2226	2500	2797	-	-	-	84	61	

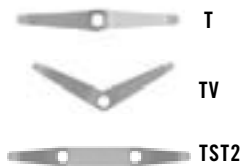

TSTV FLIP-TOP WITH CASTERS

**NOTES AND OPTIONS**

- Laminate Tops are available in any standard Wilsonart, Nevamar, Formica, Arborite or Pionite matte Finish.
- For other laminates please contact the factory.
- Veneers and hardwood edge stains are standard in Maple, Pecan, Mahogany, Cherry, Oak, Walnut and Chocolate or Stain-to-Match at no upcharge.
- Standard with leveling glides.
- Bases available in any Spectone color.
- T and TV bases are available at the same price. Specify TST or TSTV when ordering.

- Standard 29" table height.
- Locking Casters are not self-leveling.
- Table Carts are available for folding tables. Holds 6 tables.
- Base span increases with size of top.
- For table accessories, including grommets, seam connectors and modesty panels, refer to table accessories price list.

# TRUMPET AND DISC TABLES

BACK TO CONTENTS



PLACING AN ORDER IS EASY

## PRODUCT CODE

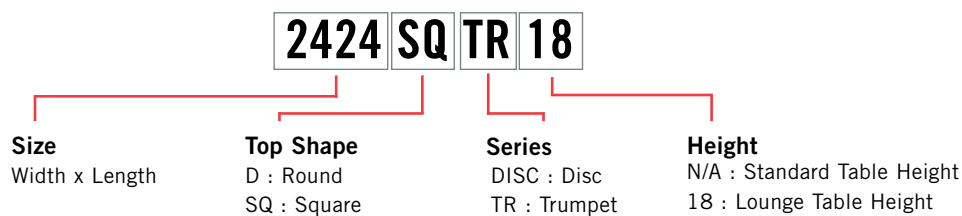

## OPTIONS

**DISC**



**TRUMPET**



## FINISHES

**LAMINATE**



Select laminate from our virtually unlimited laminate options

**VENEER**

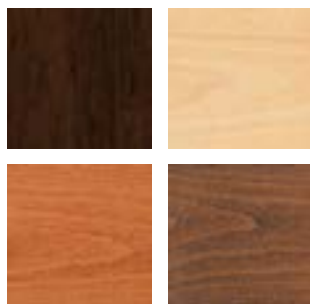

Select from one of our 7 standard wood stains or stain-to-match at no upcharge

**BASE**



Select from one of our 76 standard Spectone colors

**EDGE**



2MM      PVC      Hard Wood

Check out our website for a complete list of edge profiles.



# TRUMPET AND DISC OCCASIONAL AND LOUNGE TABLES

BACK TO CONTENTS



MODEL	BASES		TOP SPECIFICATIONS						OPTIONS	LBS
	Code	Qty.	For Laminate Top			For Veneer Top				
			SE	HF	HBV	HF2	HF	HF2		
			PVF	HB	HBVR	HB2	HB	HB2		
			PVB		HGG	HKNR4	HBV	HKNR4		
			2MM			HKNR4	HBVR	HKNR4		
						HBG2	HBG	HBG2		
<i>Round</i>										
24D	TR18	1	599	928	962	1062	1115	1218		61
	DISC18	1	887	1216	1250	1350	1403	1506		71
30D	TR18	1	694	1018	1062	1261	1210	1361		71
	DISC18	1	982	1306	1350	1549	1498	1649		81
36D	TR18	1	784	1255	1337	1500	1550	1759		82
	DISC18	1	1072	1543	1625	1788	1838	2047		92
42D	TR18	1	1045	1572	1686	1928	1953	2239		96
	DISC18	1	1333	1860	1974	2216	2241	2527		116
<i>Square</i>										
18 x 18SQ	TR18	1	616	806	840	902	947	1101		54
	DISC18	1	904	1094	1128	1190	1235	1389		54
24 x 24SQ	TR18	1	627	806	840	902	947	1101		61
	DISC18	1	915	1094	1128	1190	1235	1389		61
30 x 30SQ	TR18	1	725	855	902	1066	1007	1218		71
	DISC18	1	1013	1143	1190	1354	1295	1506		91
36 x 36SQ	TR18	1	802	1006	1062	1255	1261	1445		82
	DISC18	1	1090	1294	1350	1543	1549	1733		102



24D-TR18



24D-DISC18

### STANDARD FEATURES

- Laminate tops available in any standard Wilsonart, Nevamar, Formica, Arborite or Pionite matte finish offerings. For other laminate please contact the factory for pricing.
- Veneers and hardwood edges are standard in Oak, Maple, Cherry, Pecan, Walnut, Mahogany and Chocolate.
- 7 veneer and hardwood edge stains are standard. Stain-to-match available at no upcharge.
- Standard table height 18".
- All bases are standard with floor leveling glides.

### OPTIONS

- Chrome bases may be available as an upcharge. Please contact the factory.
- Custom heights available.

### HOW TO ORDER

1. Select Model
2. Select Base
3. Select Edge Style
4. Select Top Finish
5. Select Edge Finish
6. Select Base Finish

Example: 24D - TR18 - PVF





# TRUMPET AND DISC GENERAL PURPOSE TABLES

BACK TO CONTENTS

MODEL	BASES		TOP SPECIFICATIONS						OPTIONS	LBS
	Code	Qty.	For Laminate Top			For Veneer Top				
			SE	HF	HBV	HF2	HF	HF2		
			PVF	HB	HBVR	HB2	HB	HB2		
			PVB		HGG	HKNR4	HBV	HKNR4		
			2MM			HKNR4	HBVR	HKNR4		
						HBG2	HGG	HBG2		
<i>Round</i>										
24D	TR	1	599	928	962	1062	1115	1218		61
	DISC	1	887	1216	1250	1350	1403	1506		71
30D	TR	1	694	1018	1062	1261	1210	1361		71
	DISC	1	982	1306	1350	1549	1498	1649		81
36D	TR	1	784	1255	1337	1500	1550	1759		82
	DISC	1	1072	1543	1625	1788	1838	2047		92
42D	TR	1	1045	1572	1686	1928	1953	2239		96
	DISC	1	1333	1860	1974	2216	2241	2527		116
48D	TR	1	1066	1774	1898	2018	2452	2820		112
	DISC	1	1354	2062	2186	2306	2740	3108		132
<i>Square</i>										
24 x 24SQ	TR	1	627	806	840	902	947	1101		61
30 x 30SQ	TR	1	725	855	902	1066	1007	1218		71
	DISC	1	1013	1143	1190	1354	1295	1506		91
36 x 36SQ	TR	1	802	1006	1062	1255	1261	1445		82
	DISC	1	1090	1294	1350	1543	1549	1733		102



### STANDARD FEATURES

- Laminate tops available in any standard Wilsonart, Nevamar, Formica, Arborite or Pionite matte finish offerings. For other laminate please contact the factory for pricing.
- Veneers and hardwood edges are standard in Oak, Maple, Cherry, Pecan, Walnut, Mahogany and Chocolate.
- 7 veneer and hardwood edge stains are standard. Stain-to-match available at no upcharge.
- Standard table height 29".
- All bases are standard with floor leveling glides.

### OPTIONS

- Chrome bases may be available as an upcharge. Please contact the factory.
- Custom heights available.

### HOW TO ORDER

1. Select Model
2. Select Base
3. Select Edge Style
4. Select Top Finish
5. Select Edge Finish
6. Select Base Finish

Example: 24D - TR - PVF



# TUBULAR TABLES

BACK TO CONTENTS



PLACING AN ORDER IS EASY

## PRODUCT CODE

**2430 RE T**

### Size

Width x Length

### Top Shape

- D : Round
- SQ : Square
- RE : Rectangle
- RT : Racetrack
- B : Bullet
- H : Halfmoon
- TP : Trapezoid

- C90 : Radius (*connector*)
- CRC90 : Crescent (*connector*)
- BT : Boatshape
- BTA : Boatshape Arc

### Base

- X : X-Base
- X4 : 4 Column X-Base
- T : T-Base
- T2 : Double Column T-Base



## OPTIONS

### FLIP TOP



### CASTERS



### FOLDING



## FINISHES

### LAMINATE



Select laminate from our virtually unlimited laminate options

### VENEER

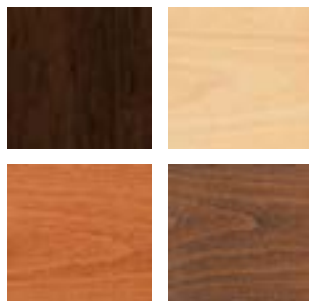

Select from one of our 7 standard wood stains or stain-to-match at no upcharge

### BASE



Select from one of our 76 standard Spectone colors

### EDGE



2MM      PVC      Hard Wood

Check out our website for a complete list of edge profiles.



# TUBULAR GENERAL PURPOSE TABLES

BACK TO CONTENTS



MODEL	BASES		TOP SPECIFICATIONS						OPTIONS				LBS
	Code	Qty.	For Laminate Top			For Veneer Top			FLIP TOP (FT)	FOLD (FL)	CASTERS (LC)	WHEELS (WB)	
			SE PVF PVB 2MM	HF HB	HBV HBVR HBG	HF2 HB2 HKNR4 HBG2	HF HB HBV HBG	HF2 HB2 HKNR4 HBG2					
<i>Round</i>													
24D	X	1	476	805	839	939	992	1095	141	-	84	-	37
30D	X	1	571	895	939	1138	1087	1238	141	-	84	-	47
36D	X	1	661	1132	1214	1377	1427	1636	141	-	84	-	58
42D	X	1	922	1449	1563	1805	1830	2116	141	-	84	-	72
	X4	1	1101	1628	1742	1984	2009	2295	-	-	84	-	87
48D	X	1	943	1651	1775	1895	2329	2697	141	-	84	-	88
	X4	1	1122	1830	1954	2074	2508	2876	-	-	84	-	103
54D	X4	1	1388	2431	2623	2807	3023	3495	-	-	-	-	121
60D	X4	1	1431	2616	2821	2976	3604	4191	-	-	-	-	140
<i>Square</i>													
24 x 24SQ	X	1	504	683	717	779	824	978	141	-	84	-	37
30 x 30SQ	X	1	602	732	779	943	884	1095	141	-	84	-	47
36 x 36SQ	X	1	679	883	939	1132	1138	1322	141	-	84	-	58
42 x 42SQ	X	1	1077	1372	1463	1554	1617	1868	282	-	-	-	92
	X4	1	1115	1410	1501	1592	1655	1906	-	-	84	-	87
48 x 48SQ	X4	1	1256	1515	1611	1653	2000	2322	-	-	84	-	103
54 x 54SQ	X4	1	1390	1962	2112	2286	2381	2799	-	-	-	-	121
60 x 60SQ	X4	1	1418	2059	2218	2394	2819	3325	-	-	-	-	140



30D-X



42D-X4

### STANDARD FEATURES

- Laminate tops available in any standard Wilsonart, Nevamar, Formica, Arborite or Pionite matte finish offerings. For other laminate please contact the factory for pricing.
- Veneers and hardwood edges are standard in Oak, Chocolate, Maple, Cherry, Pecan, Walnut and Mahogany.
- 7 veneer and hardwood edge stains are standard. Stain-to-match available at no upcharge.
- Standard table height 29".
- All bases are standard with floor leveling glides.

### OPTIONS

- Custom heights available.

### HOW TO ORDER

1. Select Model
2. Select Base
3. Select Edge Style
4. Select Options
5. Select Top Finish
6. Select Edge Finish
7. Select Base Finish

Example: 24D - X - PVF -







# TUBULAR GENERAL PURPOSE TABLES

BACK TO CONTENTS

MODEL	BASES		TOP SPECIFICATIONS						OPTIONS				LBS
	Code	Qty.	For Laminate Top			For Veneer Top			FLIP TOP (FT)	FOLD (FL)	CASTERS (LC)	WHEELS (WB)	
			SE PVF PVB 2MM	HF HB	HBV HBVR HBG	HF2 HB2 HKN4 HBG2	HF HB HBV HBG	HF2 HB2 HKN4 HBG2					
<i>Rectangle</i>													
24 x 30RE	X	1	591	713	757	820	869	988	141	-	-	-	46
	T	2	693	815	859	922	971	1090	282	-	84	-	54
24 x 36RE	X	1	591	713	757	820	869	988	141	-	-	-	46
	T	2	693	815	859	922	971	1090	282	-	84	-	54
24 x 42RE	T	2	754	950	1001	1093	1149	1315	282	-	84	-	62
24 x 48RE	T	2	754	950	1001	1093	1149	1315	282	-	84	-	62
24 x 54RE	T	2	809	1095	1160	1266	1345	1548	282	-	84	-	70
24 x 60RE	T	2	809	1095	1160	1266	1345	1548	282	273	84	-	70
24 x 66RE	T	2	945	1289	1369	1498	1582	1831	282	273	84	-	79
24 x 72RE	T	2	945	1289	1369	1498	1582	1831	282	273	84	-	79
30 x 36RE	X	1	679	820	870	950	1008	1152	141	-	-	-	52
	T	2	781	922	972	1052	1110	1254	282	-	84	-	60
30 x 42RE	X	1	698	967	1029	1135	1213	1415	141	-	-	-	62
	T	2	800	1069	1131	1237	1315	1517	282	-	84	-	70
30 x 48RE	X	1	698	967	1029	1135	1213	1415	141	-	-	-	62
	T	2	800	1069	1131	1237	1315	1517	282	-	84	-	70
30 x 54RE	T	2	855	1222	1302	1453	1543	1796	282	273	84	-	81
30 x 60RE	T	2	855	1222	1302	1453	1543	1796	282	273	84	-	81
30 x 66RE	T	2	1018	1314	1411	1565	1652	1932	282	273	84	-	91
30 x 72RE	T	2	1070	1457	1555	1753	1856	2163	282	273	84	-	91

\*Folding tables available with PVC Bullnose edge only.



30D-X

2448RE-T

### STANDARD FEATURES

- Laminate tops available in any standard Wilsonart, Nevamar, Formica, Arborite or Pionite matte finish offerings. For other laminate please contact the factory for pricing.
- Veneers and hardwood edges are standard in Oak, Chocolate, Maple, Cherry, Pecan, Walnut and Mahogany.
- 7 veneer and hardwood edge stains are standard. Stain-to-match available at no upcharge.
- Standard table height 29".
- All bases are standard with floor leveling glides.

### OPTIONS

- Custom heights available.

### HOW TO ORDER

1. Select Model
2. Select Base
3. Select Edge Style
4. Select Options
5. Select Top Finish
6. Select Edge Finish
7. Select Base Finish

Example: 2430RE - X - PVF -





# TUBULAR GENERAL PURPOSE TABLES

BACK TO CONTENTS



MODEL	BASES		TOP SPECIFICATIONS						OPTIONS				LBS
	Code	Qty.	For Laminate Top			For Veneer Top			FLIP TOP (FT)	FOLD (FL)	CASTERS (LC)	WHEELS (WB)	
			SE PVF PVB 2MM	HF HB	HBV HBVR HBG	HF2 HB2 HKNR4 HBG2	HF HB HBV HBG	HF2 HB2 HKNR4 HBG2					
<i>Rectangle</i>													
30 x 78RE	T	2	1280	1622	1738	1968	2089	2442	282	273	84	-	102
30 x 84RE	T	2	1280	1622	1738	1968	2089	2442	282	273	84	-	102
30 x 90RE	T	2	1299	1829	1968	2181	2324	2726	-	273	84	-	112
30 x 96RE	T	2	1299	1829	1968	2181	2324	2726	-	273	84	-	112
36 x 42RE	T	2	893	1095	1173	1279	1360	1572	282	-	84	-	79
36 x 48RE	T	2	917	1202	1285	1411	1495	1742	282	-	84	-	79
36 x 60RE	T	2	1007	1404	1505	1666	1768	2077	282	273	84	-	91
36 x 66RE	T	2	1089	1501	1617	1794	1905	2245	282	273	84	-	104
	T2	2	1275	1687	1803	1980	2091	2431	-	547	84	-	124
36 x 72RE	T	2	1125	1555	1666	1922	2045	2413	282	273	84	-	104
	T2	2	1311	1741	1852	2108	2231	2599	-	547	84	-	124
36 x 78RE	T	2	1438	1898	2042	2264	2409	2842	-	273	84	-	117
	T2	2	1624	2084	2228	2450	2595	3028	-	547	84	-	137
36 x 84RE	T	2	1438	1898	2042	2264	2409	2842	-	273	84	-	117
	T2	2	1624	2084	2228	2450	2595	3028	-	547	84	-	137
36 x 90RE	T	2	1443	2099	2264	2523	2689	3170	-	-	84	-	129
	T2	2	1629	2285	2450	2709	2875	3356	-	547	84	-	149
36 x 96RE	T	2	1443	2099	2264	2523	2689	3170	-	-	84	-	129
	T2	2	1629	2285	2450	2709	2875	3356	-	547	84	-	149
42 x 78RE	T2	2	1850	2246	2404	2786	2912	3414	-	547	84	-	151
42 x 84RE	T2	2	1850	2246	2404	2786	2912	3414	-	547	84	-	151

\*Folding tables available with PVC Bullnose edge only.



2448RE-T

### STANDARD FEATURES

- Laminate tops available in any standard Wilsonart, Nevamar, Formica, Arborite or Pionite matte finish offerings. For other laminate please contact the factory for pricing.
- Veneers and hardwood edges are standard in Oak, Chocolate, Maple, Cherry, Pecan, Walnut and Mahogany.
- 7 veneer and hardwood edge stains are standard. Stain-to-match available at no upcharge.
- Standard table height 29".
- All bases are standard with floor leveling glides.

### OPTIONS

- Custom heights available.

### HOW TO ORDER

1. Select Model
2. Select Base
3. Select Edge Style
4. Select Options
5. Select Top Finish
6. Select Edge Finish
7. Select Base Finish

Example: 3078RE - T - PVF -





# TUBULAR GENERAL PURPOSE TABLES

BACK TO CONTENTS



MODEL	BASES		TOP SPECIFICATIONS						OPTIONS				LBS
	Code	Qty.	For Laminate Top			For Veneer Top			FLIP TOP (FT)	FOLD (FL)	CASTERS (LC)	WHEELS (WB)	
			SE PVF PVB 2MM	HF HB	HBV HBVR HBG	HF2 HB2 HKN4 HBG2	HF HB HBV HBG	HF2 HB2 HKN4 HBG2					
<i>Racetrack</i>													
36 x 54RT	T	2	1059	1582	1704	1922	2011	2330	282	-	84	-	91
	T2	2	1245	1768	1890	2108	2197	2516	-	-	84	-	111
36 x 60RT	T	2	1059	1582	1704	1922	2011	2330	282	-	84	-	91
	T2	2	1245	1768	1890	2108	2197	2516	-	-	84	-	111
36 x 66RT	T	2	1207	1753	1885	2118	2324	2722	282	-	84	-	104
	T2	2	1393	1939	2071	2304	2510	2908	-	-	84	-	124
36 x 72RT	T	2	1207	1753	1885	2118	2324	2722	282	-	84	-	104
	T2	2	1393	1939	2071	2304	2510	2908	-	-	84	-	124
36 x 78RT	T	2	1453	2147	2309	2662	2736	3201	-	-	84	-	117
	T2	2	1639	2333	2495	2848	2922	3387	-	-	84	-	132
36 x 84RT	T	2	1453	2147	2309	2662	2736	3201	-	-	84	-	117
	T2	2	1639	2333	2495	2848	2922	3387	-	-	84	-	132
36 x 90RT	T	2	1457	2383	2576	2971	3063	3592	-	-	84	-	129
	T2	2	1643	2569	2762	3157	3249	3778	-	-	84	-	149
36 x 96RT	T	2	1457	2383	2576	2971	3063	3592	-	-	84	-	129
	T2	2	1643	2569	2762	3157	3249	3778	-	-	84	-	149
42 x 78RT	T2	2	1864	2520	2719	3118	3214	3749	-	-	84	-	166
42 x 84RT	T2	2	1864	2520	2719	3118	3214	3749	-	-	84	-	166
48 x 78RT	T2	2	1867	2802	3027	3380	3601	4209	-	-	84	-	166
48 x 84RT	T2	2	1867	2802	3027	3380	3601	4209	-	-	84	-	166



2448RE-T

### STANDARD FEATURES

- Laminate tops available in any standard Wilsonart, Nevamar, Formica, Arborite or Pionite matte finish offerings. For other laminate please contact the factory for pricing.
- Veneers and hardwood edges are standard in Oak, Chocolate, Maple, Cherry, Pecan, Walnut and Mahogany.
- 7 veneer and hardwood edge stains are standard. Stain-to-match available at no upcharge.
- Standard table height 29".
- All bases are standard with floor leveling glides.

### OPTIONS

- Custom heights available.

### HOW TO ORDER

1. Select Model
2. Select Base
3. Select Edge Style
4. Select Options
5. Select Top Finish
6. Select Edge Finish
7. Select Base Finish

Example: 3654RT - T - PVF -





# TUBULAR GENERAL PURPOSE TABLES

BACK TO CONTENTS

MODEL	BASES		TOP SPECIFICATIONS						OPTIONS				LBS
	Code	Qty.	For Laminate Top			For Veneer Top			FLIP TOP (FT)	FOLD (FL)	CASTERS (LC)	WHEELS (WB)	
			SE PVF PVB 2MM	HF HB	HBV HBVR HBG	HF2 HB2 HKN4 HKNR4 HBG2	HF HB HBV HBG	HF2 HB2 HKN4 HKNR4 HBG2					
<i>Bullet</i>													
<b>30 x 54B</b>	T	2	967	1488	1596	1787	1843	2159	282	-	84	-	81
<b>30 x 60B</b>	T	2	967	1488	1596	1787	1843	2159	282	-	84	-	81
<b>36 x 54B</b>	T	2	1080	1955	2110	2389	2427	2824	282	-	84	-	91
<b>36 x 60B</b>	T	2	1080	1955	2110	2389	2427	2824	282	-	84	-	91
<b>36 x 72B</b>	T	2	1206	2174	2345	2643	2816	3314	282	-	84	-	104
<i>Halfmoon</i>													
<b>24 x 48H</b>	T	2	770	1240	1358	1501	1617	1885	282	-	84	-	62
<b>30 x 60H</b>	T	2	967	1667	1830	1990	2191	2573	282	-	84	-	81
<b>36 x 72H</b>	T	2	1206	2162	2373	2570	2897	3413	282	-	84	-	104
<i>Trapezoid</i>													
<b>30 x 60TP</b>	T	2	967	1398	1498	1672	1722	2014	282	-	84	-	81
<b>36 x 72TP</b>	T	2	1206	1790	1923	2223	2297	2718	282	-	84	-	104
<i>Radius (connector)</i>													
<b>24 x 24</b>	<b>24RC90</b>	-	362	656	741	850	871	1043	-	-	-	-	17
<b>30 x 30</b>	<b>30RC90</b>	-	462	868	975	1094	1156	1387	-	-	-	-	27
<i>Crescent (connector)</i>													
<b>30 x 36</b>	<b>3036CRC90-T</b>	1	737	1365	1444	1506	1706	1925	-	-	-	-	46
<b>36 x 42</b>	<b>3642CRC90-T</b>	1	1070	1659	1767	1849	2123	2420	-	-	-	-	59



2448RE-T

### STANDARD FEATURES

- Laminate tops available in any standard Wilsonart, Nevamar, Formica, Arborite or Pionite matte finish offerings. For other laminate please contact the factory for pricing.
- Veneers and hardwood edges are standard in Oak, Chocolate, Maple, Cherry, Pecan, Walnut and Mahogany.
- 7 veneer and hardwood edge stains are standard. Stain-to-match available at no upcharge.
- Standard table height 29".
- All bases are standard with floor leveling glides.

### OPTIONS

- Custom heights available.

### HOW TO ORDER

1. Select Model
2. Select Base
3. Select Edge Style
4. Select Options
5. Select Top Finish
6. Select Edge Finish
7. Select Base Finish

**Example:** 3054B - T - PVF -



# TUBULAR BOARDROOM TABLES

MODEL	BASES		TOP SPECIFICATIONS						OPTIONS	LBS
	Code	Qty.	For Laminate Top			For Veneer Top				
			SE	HF	HBV	HF2	HF	HF2		
			PVF	HB	HBVR	HB2	HB	HB2		
			PVB		HGG	HKN4	HBV	HKN4		
			2MM			HKNR4	HBVR	HKNR4		
						HGG2	HGG	HGG2		
<i>Rectangle</i>										
42 x 96RE	T2	2	1898	2731	2957	3184	3522	4174		183
48 x 96RE	T2	2	1898	2731	2957	3184	3522	4174		183
48 x 120RE	T2	3	2508	3583	3838	4387	4469	5230		240
48 x 144RE	T2	3	2871	4413	4748	5271	5147	6064		274
48 x 168RE	T2	3	3332	4884	5267	5997	5828	6894		308
60 x 120RE	T2	3	2951	4559	4910	5453	5324	6279		282
60 x 144RE	T2	3	3362	5291	5712	6362	6209	7355		324
60 x 168RE	T2	3	3773	6024	6512	7274	7093	8430		366
<i>Racetrack</i>										
42 x 96RT	T2	2	1918	2859	3088	3640	4030	4725		183
48 x 96RT	T2	2	1918	2859	3088	3640	4030	4725		183
48 x 120RT	T2	3	2532	4026	4325	5086	5054	5866		240
48 x 144RT	T2	3	2898	4759	5125	6069	5850	6834		274
48 x 168RT	T2	3	3362	5385	5814	6861	6657	7798		308
60 x 120RT	T2	3	2941	4808	5179	6135	6092	7111		282
60 x 144RT	T2	3	3398	5723	6183	7364	7089	8319		324
60 x 168RT	T2	3	3979	6509	7044	8349	8097	9523		366



4296BTA-T2

## STANDARD FEATURES

- Laminate tops available in any standard Wilsonart, Nevamar, Formica, Arborite or Pionite matte finish offerings. For other laminate please contact the factory for pricing.
- Veneers and hardwood edges are standard in Oak, Chocolate, Maple, Cherry, Pecan, Walnut and Mahogany.
- 7 veneer and hardwood edge stains are standard. Stain-to-match available at no upcharge.
- Standard table height 29".
- All bases are standard with floor leveling glides.

## OPTIONS

- Custom heights available.

## HOW TO ORDER

1. Select Model
2. Select Base
3. Select Edge Style
4. Select Top Finish
5. Select Edge Finish
6. Select Base Finish

**Example:** 4296RE - T2 - PVF

MODEL | BASE | EDGE



# TUBULAR BOARDROOM TABLES

BACK TO CONTENTS



MODEL	BASES		TOP SPECIFICATIONS						OPTIONS	LBS
	Code	Qty.	For Laminate Top			For Veneer Top				
			SE PVF PVB 2MM	HF HB	HBV HBVR HBG	HF2 HB2 HKNR4 HBG2	HF HB HBV HBG	HF2 HB2 HKNR4 HBG2		
<i>Boatshape</i>										
42 x 96BT	T2	2	1918	3501	3796	4100	4531	4910		183
48 x 96BT	T2	2	1918	3501	3796	4100	4531	4910		183
48 x 120BT	T2	2	2532	4730	5096	5481	5646	6083		240
48 x 144BT	T2	3	2898	5463	5899	6362	6946	7344		274
48 x 168BT	T2	3	3362	6164	6671	7206	7479	8094		308
60 x 120BT	T2	3	2941	5686	6146	6627	6834	7378		282
60 x 144BT	T2	3	3398	6605	7150	7729	8457	8956		324
60 x 168BT	T2	3	3979	7482	8115	8784	9122	9893		366
<i>Boatshape Arc Ends</i>										
42 x 96BTA	T2	2	2078	4006	4302	4608	5036	5416		183
48 x 96BTA	T2	2	2078	4006	4302	4608	5036	5416		183
48 x 120BTA	T2	2	2693	5237	5603	5989	6153	6588		240
48 x 144BTA	T2	3	3059	5968	6407	6870	7451	7851		274
48 x 168BTA	T2	3	3524	6671	7179	7714	7984	8602		308
60 x 120BTA	T2	3	3143	6322	6778	7261	7466	8010		282
60 x 144BTA	T2	3	3598	7236	7784	8362	9090	9587		324
60 x 168BTA	T2	3	4179	8115	8748	9415	9757	10528		366



4296BTA-T2

### STANDARD FEATURES

- Laminate tops available in any standard Wilsonart, Nevamar, Formica, Arborite or Pionite matte finish offerings. For other laminate please contact the factory for pricing.
- Veneers and hardwood edges are standard in Oak, Chocolate, Maple, Cherry, Pecan, Walnut and Mahogany.
- 7 veneer and hardwood edge stains are standard. Stain-to-match available at no upcharge.
- Standard table height 29".
- All bases are standard with floor leveling glides.

### OPTIONS

- Custom heights available.

### HOW TO ORDER

1. Select Model
2. Select Base
3. Select Edge Style
4. Select Top Finish
5. Select Edge Finish
6. Select Base Finish

Example: 4296BT - T2 - PVF





# VARSITY TABLES



PLACING AN ORDER IS EASY

## PRODUCT CODE

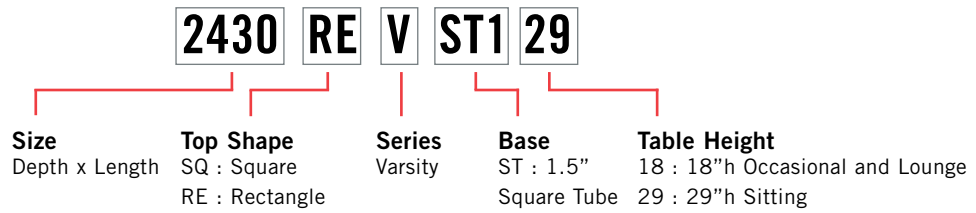

## OPTIONS

### SEAM CONNECTORS



### CASTERS



1.5" Low Profile Locking Caster

## FINISHES

### LAMINATE



Select laminate from our virtually unlimited laminate options

### VENEER

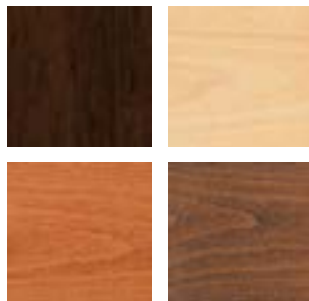

Select from one of our 7 standard wood stains or stain-to-match at no upcharge

### BASE



Select from one of our 76 standard Spectone colors

### EDGE



2MM

SE

HF



# VARSITY TABLES OCCASIONAL AND LOUNGE TABLES

BACK TO CONTENTS



MODEL	BASES		TOP SPECIFICATIONS			OPTIONS	MOBILITY	LBS
	Code	Qty.	For Laminate Top		For Veneer Top			
			SE 2MM	HF	HF			
<i>Square</i>								
<b>24 X 24SQ</b>	VST1	1	792	971	1112			54
<b>30 X 30SQ</b>	VST1	1	890	1020	1172			64
<b>36 X 36SQ</b>	VST1	1	967	1171	1426			76
<i>Rectangle</i>								
<b>24 X 48RE</b>	VST1	1	940	1136	1335			72



REVST1

SQVST1

**STANDARD FEATURES**

- Laminate Tops are available in any standard Wilsonart, Nevamar, Formica, Arborite or Pionite matte Finish.
- For other laminates please contact the factory.
- Veneers and hardwood edge stains are standard in Maple, Mahogany, Cherry, Oak, Walnut, Pecan and Chocolate, or Stain-to-Match at no upcharge.
- Standard with leveling glides.
- Bases available in any Spectone color.
- Standard 18" table height.
- 1" apron; 1.5" square tube legs; 1" top
- Ships Knocked Down.

**OPTIONS**

For Seam Connectors see accessories at the end of this section.

**HOW TO ORDER**

1. Select Model
2. Select Base
3. Select Edge Style
4. Select Options
5. Select Top Finish
6. Select Edge Finish
7. Select Base Finish







# VARSITY TABLES

## GENERAL PURPOSE TABLES

BACK TO CONTENTS

MODEL	BASES		TOP SPECIFICATIONS		OPTIONS	MOBILITY	LBS
	Code	Qty.	For Laminate Top SE 2MM	For Veneer Top HF			
<i>Square</i>							
24 X 24SQ	VST1	1	792	971	1112	84	54
30 X 30SQ	VST1	1	890	1020	1172	84	64
36 X 36SQ	VST1	1	967	1171	1426	84	76
<i>Rectangle</i>							
18 X 24RE	VST1	1	743	826	909	84	49
18 X 30RE	VST1	1	779	882	987	84	53
18 X 36RE	VST1	1	830	962	1098	84	56
18 X 42RE	VST1	1	898	1073	1246	84	60
18 X 48RE	VST1	1	898	1073	1246	84	64
18 X 54RE	VST1	1	940	1136	1335	84	68
18 X 60RE	VST1	1	940	1136	1335	84	72
18 X 66RE	VST1	1	995	1281	1531	84	75
18 X 72RE	VST1	1	995	1281	1531	84	79
24 X 30RE	VST1	1	879	1001	1157	84	58
24 X 36RE	VST1	1	879	1001	1157	84	63
24 X 42RE	VST1	1	940	1136	1335	84	68
24 X 48RE	VST1	1	940	1136	1335	84	72
24 X 54RE	VST1	1	995	1281	1531	84	77
24 X 60RE	VST1	1	995	1281	1531	84	82
24 X 66RE	VST1	1	1131	1475	1768	84	86
24 X 72RE	VST1	1	1131	1475	1768	84	91



VST1



VST1

### STANDARD FEATURES

- Laminate Tops are available in any standard Wilsonart, Nevamar, Formica, Arborite or Pionite matte Finish.
- For other laminates please contact the factory.
- Veneers and hardwood edge stains are standard in Maple, Mahogany, Cherry, Oak, Walnut, Pecan and Chocolate, or Stain-to-Match at no upcharge.
- Standard with leveling glides.
- Bases available in any Spectone color.
- Standard 29" table height.
- 1" apron; 1.5" square tube legs; 1" top
- Ships Knocked Down.

### OPTIONS

- For Seam Connectors see accessories at the end of this section.
- Low profile 1.5"D locking casters.

### HOW TO ORDER

1. Select Model
2. Select Base
3. Select Edge Style
4. Select Options
5. Select Top Finish
6. Select Edge Finish
7. Select Base Finish

**Example:** 1836RE - VST1 - 2MM -





# VARSITY TABLES

## GENERAL PURPOSE TABLES

BACK TO CONTENTS

MODEL	BASES		TOP SPECIFICATIONS		OPTIONS	MOBILITY	LBS
	<i>Code</i>	<i>Qty.</i>	<i>For Laminate Top</i>	<i>For Veneer Top</i>			
			SE 2MM	HF		CASTERS	
						<i>Add</i>	
<i>Rectangle</i>							
30 X 36RE	VST1	1	967	1108	1296	84	69
30 X 42RE	VST1	1	986	1255	1501	84	75
30 X 48RE	VST1	1	986	1255	1501	84	81
30 X 54RE	VST1	1	1041	1408	1729	84	86
30 X 60RE	VST1	1	1041	1408	1729	84	92
30 X 66RE	VST1	1	1204	1500	1838	84	97
30 X 72RE	VST1	1	1256	1643	2042	84	103
36 X 42RE	VST1	1	1079	1281	1546	84	82
36 X 48RE	VST1	1	1103	1388	1681	84	89
36 X 54RE	VST1	1	1175	1484	1825	84	95
36 X 60RE	VST1	1	1193	1590	1954	84	102
36 X 66RE	VST1	1	1275	1687	2091	84	108
36 X 72RE	VST1	1	1311	1741	2231	84	115



VST1



VST1

### STANDARD FEATURES

- Laminate Tops are available in any standard Wilsonart, Nevamar, Formica, Arborite or Pionite matte Finish.
- For other laminates please contact the factory.
- Veneers and hardwood edge stains are standard in Maple, Mahogany, Cherry, Oak, Walnut, Pecan and Chocolate, or Stain-to-Match at no upcharge.
- Standard with leveling glides.
- Bases available in any Spectone color.
- Standard 29" table height.
- 1" apron; 1.5" square tube legs; 1" top
- Ships Knocked Down.

### OPTIONS

- For Seam Connectors see accessories at the end of this section.
- Low profile 1.5"D locking casters.

### HOW TO ORDER

1. Select Model
2. Select Base
3. Select Edge Style
4. Select Options
5. Select Top Finish
6. Select Edge Finish
7. Select Base Finish

**Example:** 3642RE - VST1 - 2MM -





# VARSITY ACCESSORIES

BACK TO CONTENTS

MODEL	Code	Price	
<b>SEAM CONNECTOR</b> Seam Connectors join and level tops. Includes 2 connectors, 4 thumb screws, 4 counter sunk threaded metal inserts. Standard in Black.	<b>VSC</b>	80	



# VESPA TABLES

BACK TO CONTENTS



PLACING AN ORDER IS EASY

### PRODUCT CODE

**2430 RE VB X**

**Size**

Width x Length

**Top Shape**

- D : Round
- SQ : Square
- RE : Rectangle
- RT : Racetrack
- B : Bullet
- H : Halfmoon
- TP : Trapezoid

CRC90 : Crescent

BT : Boatshape

BTA : Boatshape Arc

**Series**

Vespa

**Base**

- X : 4 Column X-Base
- T : Double Column T-Base



### OPTIONS

**FLIP TOP**



**CASTERS**



### FINISHES

**LAMINATE**



Select laminate from our virtually unlimited laminate options

**VENEER**

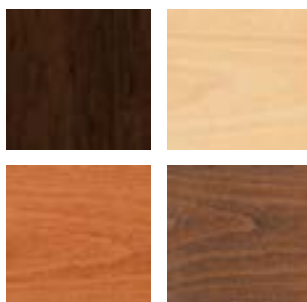

Select from one of our 7 standard wood stains or stain-to-match at no upcharge

**BASE**



Select from one of our 76 standard Spectone colors

**EDGE**



2MM

PVC

Hard Wood

Check out our website for a complete list of edge profiles.



# VESPA GENERAL PURPOSE TABLES

BACK TO CONTENTS

MODEL	BASES		TOP SPECIFICATIONS						OPTIONS				LBS
	Code	Qty.	For Laminate Top			For Veneer Top			FLIP TOP (FT)	FOLD (FL)	CASTERS (LC)	WHEELS (WB)	
			SE PVF PVB 2MM	HF HB	HBV HBVR HBG	HF2 HB2 HKNR4 HBG2	HF HB HBV HBG	HF2 HB2 HKNR4 HBG2					
<i>Round</i>													
24D	VBX	1	804	1133	1167	1267	1320	1423	-	-	84	-	41
30D	VBX	1	899	1223	1267	1466	1415	1566	-	-	84	-	51
36D	VBX	1	989	1460	1542	1705	1755	1964	-	-	84	-	62
42D	VBX	1	1250	1777	1891	2133	2158	2444	-	-	84	-	76
48D	VBX	1	1271	1979	2103	2223	2657	3025	-	-	-	-	92
<i>Square</i>													
24 x 24SQ	VBX	1	832	1011	1045	1107	1152	1306	-	-	84	-	41
30 x 30SQ	VBX	1	930	1060	1107	1271	1212	1423	-	-	84	-	51
36 x 36SQ	VBX	1	1007	1211	1267	1460	1466	1650	-	-	84	-	62
42 x 42SQ	VBX	1	1264	1559	1650	1741	1804	2055	-	-	84	-	76
48 x 48SQ	VBX	1	1405	1664	1760	1802	2149	2471	-	-	84	-	92
<i>Rectangle</i>													
24 x 30RE	VBX	1	919	1041	1085	1148	1197	1316	-	-	-	-	50
	VB	2	883	1005	1049	1112	1161	1280	282	-	84	-	52
24 x 36RE	VBX	1	919	1041	1085	1148	1197	1316	-	-	-	-	50
	VB	2	883	1005	1049	1112	1161	1280	282	-	84	-	52
24 x 42RE	VB	2	944	1140	1191	1283	1339	1505	282	-	84	-	60
24 x 48RE	VB	2	944	1140	1191	1283	1339	1505	282	-	84	-	60
24 x 54RE	VB	2	999	1285	1350	1456	1535	1738	282	-	84	-	68
24 x 60RE	VB	2	999	1285	1350	1456	1535	1738	282	-	84	-	68
24 x 66RE	VB	2	1135	1479	1559	1688	1772	2021	282	-	84	-	77
24 x 72RE	VB	2	1135	1479	1559	1688	1772	2021	282	-	84	-	77



42D-VBX



2448RE-VB

### STANDARD FEATURES

- Laminate tops available in any standard Wilsonart, Nevamar, Formica, Arborite or Pionite matte finish offerings. For other laminate please contact the factory for pricing.
- Veneers and hardwood edges are standard in Oak, Chocolate, Maple, Cherry, Pecan, Walnut, Mahogany.
- 7 veneer and hardwood edge stains are standard. Stain-to-match available at no upcharge.
- Standard table height 29".
- All bases are standard with floor leveling glides.

### OPTIONS

- Custom heights available.
- Two tone base available, add \$104 List per base.

### HOW TO ORDER

1. Select Model
2. Select Base
3. Select Edge Style
4. Select Options
5. Select Top Finish
6. Select Edge Finish
7. Select Base Finish

**Example:** 24D - VBX - PVF -





# VESPA GENERAL PURPOSE TABLES

BACK TO CONTENTS



MODEL	BASES		TOP SPECIFICATIONS						OPTIONS				LBS
	Code	Qty.	For Laminate Top			For Veneer Top			FLIP TOP (FT)	FOLD (FL)	CASTERS (LC)	WHEELS (WB)	
			SE PVF PVB 2MM	HF HB	HBV HBVR HBG	HF2 HB2 HKNR4 HBG2	HF HB HBV HBG	HF2 HB2 HKNR4 HBG2					
<i>Rectangle</i>													
30 x 36RE	VBX	1	1007	1148	1198	1278	1336	1480	-	-	-	-	56
	VB	2	971	1112	1162	1242	1300	1444	282	-	84	-	58
30 x 42RE	VB	2	990	1259	1321	1427	1505	1707	282	-	84	-	68
30 x 48RE	VB	2	990	1259	1321	1427	1505	1707	282	-	84	-	68
30 x 54RE	VB	2	1045	1412	1492	1643	1733	1986	282	-	84	-	79
30 x 60RE	VB	2	1045	1412	1492	1643	1733	1986	282	-	84	-	79
30 x 66RE	VB	2	1208	1504	1601	1755	1842	2122	282	-	84	-	89
30 x 72RE	VB	2	1260	1647	1745	1943	2046	2353	282	-	84	-	89
30 x 78RE	VB	2	1470	1812	1928	2158	2279	2632	282	-	84	-	100
30 x 84RE	VB	2	1470	1812	1928	2158	2279	2632	282	-	84	-	100
30 x 90RE	VB	2	1489	2019	2158	2371	2514	2916	-	-	84	-	110
30 x 96RE	VB	2	1489	2019	2158	2371	2514	2916	-	-	84	-	110
36 x 42RE	VB	2	1083	1285	1363	1469	1550	1762	282	-	84	-	77
36 x 48RE	VB	2	1107	1392	1475	1601	1685	1932	282	-	84	-	77
36 x 60RE	VB	2	1197	1594	1695	1856	1958	2267	282	-	84	-	89
36 x 66RE	VB	2	1279	1691	1807	1984	2095	2435	282	-	84	-	102
36 x 72RE	VB	2	1315	1745	1856	2112	2235	2603	282	-	84	-	102
36 x 78RE	VB	2	1628	2088	2232	2454	2599	3032	-	-	84	-	115
36 x 84RE	VB	2	1628	2088	2232	2454	2599	3032	-	-	84	-	115
36 x 90RE	VB	2	1633	2289	2454	2713	2879	3360	-	-	84	-	127
36 x 96RE	VB	2	1633	2289	2454	2713	2879	3360	-	-	84	-	127
42 x 78RE	VB	2	1854	2250	2408	2790	2916	3418	-	-	-	-	129
42 x 84RE	VB	2	1854	2250	2408	2790	2916	3418	-	-	-	-	129



42D-VBX



2448RE-VB

### STANDARD FEATURES

- Laminate tops available in any standard Wilsonart, Nevamar, Formica, Arborite or Pionite matte finish offerings. For other laminate please contact the factory for pricing.
- Veneers and hardwood edges are standard in Oak, Chocolate, Maple, Cherry, Pecan, Walnut, Mahogany.
- 7 veneer and hardwood edge stains are standard. Stain-to-match available at no upcharge.
- Standard table height 29".
- All bases are standard with floor leveling glides.

### OPTIONS

- Custom heights available.
- Two tone base available, add \$104 List per base.

### HOW TO ORDER

- Select Model
- Select Base
- Select Edge Style
- Select Options
- Select Top Finish
- Select Edge Finish
- Select Base Finish

Example: 3036RE - VBX - PVF -





# VESPA GENERAL PURPOSE TABLES

BACK TO CONTENTS

MODEL	BASES		TOP SPECIFICATIONS						OPTIONS				LBS
	Code	Qty.	For Laminate Top			For Veneer Top			FLIP TOP (FT)	FOLD (FL)	CASTERS (LC)	WHEELS (WB)	
			SE	HF	HBV	HF2	HF	HF2					
			PVF	HB	HBVR	HB2	HB	HB2					
			PVB		HGG	HKN4	HBV	HKN4					
			2MM			HKNR4	HBVR	HKNR4					
						HGG2	HGG	HGG2					
<i>Racetrack</i>													
36 x 54RT	VB	2	1249	1772	1894	2112	2201	2520	-	-	84	-	89
36 x 60RT	VB	2	1249	1772	1894	2112	2201	2520	-	-	84	-	89
36 x 66RT	VB	2	1397	1943	2075	2308	2514	2912	282	-	84	-	102
36 x 72RT	VB	2	1397	1943	2075	2308	2514	2912	282	-	84	-	102
36 x 78RT	VB	2	1643	2337	2499	2852	2926	3391	-	-	84	-	115
36 x 84RT	VB	2	1643	2337	2499	2852	2926	3391	-	-	84	-	115
36 x 90RT	VB	2	1647	2573	2766	3161	3253	3782	-	-	84	-	127
36 x 96RT	VB	2	1647	2573	2766	3161	3253	3782	-	-	84	-	127
42 x 78RT	VB	2	1868	2524	2723	3122	3218	3753	-	-	-	-	144
42 x 84RT	VB	2	1868	2524	2723	3122	3218	3753	-	-	-	-	144
48 x 78RT	VB	2	1871	2806	3031	3384	3605	4213	-	-	-	-	144
48 x 84RT	VB	2	1871	2806	3031	3384	3605	4213	-	-	-	-	144



2448RE-VB

### STANDARD FEATURES

- Laminate tops available in any standard Wilsonart, Nevamar, Formica, Arborite or Pionite matte finish offerings. For other laminate please contact the factory for pricing.
- Veneers and hardwood edges are standard in Oak, Chocolate, Maple, Cherry, Pecan, Walnut, Mahogany.
- 7 veneer and hardwood edge stains are standard. Stain-to-match available at no upcharge.
- Standard table height 29".
- All bases are standard with floor leveling glides.

### OPTIONS

- Custom heights available.
- Two tone base available, add \$104 List per base.

### HOW TO ORDER

- Select Model
- Select Base
- Select Edge Style
- Select Options
- Select Top Finish
- Select Edge Finish
- Select Base Finish

Example: 3654RT - VB - PVF -





# VESPA GENERAL PURPOSE TABLES

BACK TO CONTENTS

MODEL	BASES		TOP SPECIFICATIONS						OPTIONS				LBS
	Code	Qty.	For Laminate Top			For Veneer Top			FLIP TOP (FT)	FOLD (FL)	CASTERS (LC)	WHEELS (WB)	
			SE PVF PVB 2MM	HF HB	HBV HBVR HBG	HF2 HB2 HKN4 HBG2	HF HB HBV HBG	HF2 HB2 HKN4 HBG2					
<i>Bullet</i>													
<b>30 x 54B</b>	<b>VB</b>	2	1157	1678	1786	1977	2033	2349	282	-	84	-	79
<b>30 x 60B</b>	<b>VB</b>	2	1157	1678	1786	1977	2033	2349	282	-	84	-	79
<b>36 x 54B</b>	<b>VB</b>	2	1270	2145	2300	2579	2617	3014	-	-	84	-	89
<b>36 x 60B</b>	<b>VB</b>	2	1270	2145	2300	2579	2617	3014	-	-	84	-	89
<b>36 x 72B</b>	<b>VB</b>	2	1396	2364	2535	2833	3006	3504	282	-	84	-	102
<i>Halfmoon</i>													
<b>24 x 48H</b>	<b>VB</b>	2	960	1430	1548	1691	1807	2075	282	-	84	-	60
<b>30 x 60H</b>	<b>VB</b>	2	1157	1857	2020	2180	2381	2763	282	-	84	-	79
<b>36 x 72H</b>	<b>VB</b>	2	1396	2352	2563	2760	3087	3603	-	-	84	-	102
<i>Trapezoid</i>													
<b>30 x 60TP</b>	<b>VB</b>	2	1157	1588	1688	1862	1912	2204	-	-	84	-	79
<b>36 x 72TP</b>	<b>VB</b>	2	1396	1980	2113	2413	2487	2908	-	-	84	-	102
<i>Radius</i>													
<b>24 x 24</b>	<b>24RC90</b>	-	362	656	741	850	871	1043	-	-	-	-	17
<b>30 x 30</b>	<b>30RC90</b>	-	462	868	975	1094	1156	1387	-	-	-	-	27



2448RE-VB

### STANDARD FEATURES

- Laminate tops available in any standard Wilsonart, Nevamar, Formica, Arborite or Pionite matte finish offerings. For other laminate please contact the factory for pricing.
- Veneers and hardwood edges are standard in Oak, Chocolate, Maple, Cherry, Pecan, Walnut, Mahogany.
- 7 veneer and hardwood edge stains are standard. Stain-to-match available at no upcharge.
- Standard table height 29".
- All bases are standard with floor leveling glides.

### OPTIONS

- Custom heights available.
- Two tone base available, add \$104 List per base.

### HOW TO ORDER

- Select Model
- Select Base
- Select Edge Style
- Select Options
- Select Top Finish
- Select Edge Finish
- Select Base Finish

Example: 3054B - VB - PVF -







# VESPA BOARDROOM TABLES

BACK TO CONTENTS



MODEL	BASES		TOP SPECIFICATIONS						OPTIONS	LBS
	Code	Qty.	For Laminate Top			For Veneer Top				
			SE	HF	HBV	HF2	HF	HF2		
			PVF	HB	HBVR	HB2	HB	HB2		
			PVB		HGG	HKN4	HBV	HKN4		
			2MM			HKNR4	HBVR	HKNR4		
						HGG2	HGG	HGG2		
<i>Rectangle</i>										
42 x 96RE	VB	2	1902	2735	2961	3188	3526	4178		161
48 x 96RE	VB	2	1902	2735	2961	3188	3526	4178		161
48 x 120RE	VB	3	2514	3589	3844	4393	4475	5236		207
48 x 144RE	VB	3	2877	4419	4754	5277	5153	6070		241
48 x 168RE	VB	3	3338	4890	5273	6003	5834	6900		275
60 x 120RE	VB	3	2957	4565	4916	5459	5330	6285		249
60 x 144RE	VB	3	3368	5297	5718	6368	6215	7361		291
60 x 168RE	VB	3	3779	6030	6518	7280	7099	8436		333
<i>Racetrack</i>										
42 x 96RT	VB	2	1922	2863	3092	3644	4034	4729		161
48 x 96RT	VB	2	1922	2863	3092	3644	4034	4729		161
48 x 120RT	VB	3	2538	4032	4331	5092	5060	5872		207
48 x 144RT	VB	3	2904	4765	5131	6075	5856	6840		241
48 x 168RT	VB	3	3368	5391	5820	6867	6663	7804		275
60 x 120RT	VB	3	2947	4814	5185	6141	6098	7117		249
60 x 144RT	VB	3	3404	5729	6189	7370	7095	8325		291
60 x 168RT	VB	3	3985	6515	7050	8355	8103	9529		333



4296BTA-VB

### STANDARD FEATURES

- Laminate tops available in any standard Wilsonart, Nevamar, Formica, Arborite or Pionite matte finish offerings. For other laminate please contact the factory for pricing.
- Veneers and hardwood edges are standard in Oak, Chocolate, Maple, Cherry, Pecan, Walnut, Mahogany.
- 7 veneer and hardwood edge stains are standard. Stain-to-match available at no upcharge.
- Standard table height 29".
- All bases are standard with floor leveling glides.

### OPTIONS

- Custom heights available.
- Two tone base available, add \$104 List per base.

### HOW TO ORDER

1. Select Model
2. Select Base
3. Select Edge Style
4. Select Top Finish
5. Select Edge Finish
6. Select Base Finish

**Example:** 4296RE - VB - PVF

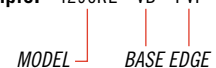



# VESPA BOARDROOM TABLES

BACK TO CONTENTS



MODEL	BASES		TOP SPECIFICATIONS						OPTIONS	LBS
	Code	Qty.	For Laminate Top			For Veneer Top				
			SE	HF	HBV	HF2	HF	HF2		
			PVF	HB	HBVR	HB2	HB	HB2		
			PVB		HGG	HKN4	HBV	HKN4		
			2MM			HKNR4	HBVR	HKNR4		
						HGG2	HGG	HGG2		
<i>Boatshape</i>										
42 x 96BT	VB	2	1922	3505	3800	4104	4535	4914		161
48 x 96BT	VB	2	1922	3505	3800	4104	4535	4914		161
48 x 120BT	VB	2	2538	4736	5102	5487	5652	6089		207
48 x 144BT	VB	3	2904	5469	5905	6368	6952	7350		241
48 x 168BT	VB	3	3368	6170	6677	7212	7485	8100		275
60 x 120BT	VB	3	2947	5692	6152	6633	6840	7384		249
60 x 144BT	VB	3	3404	6611	7156	7735	8463	8962		291
60 x 168BT	VB	3	3985	7488	8121	8790	9128	9899		333
<i>Boatshape Arc Ends</i>										
42 x 96BTA	VB	2	2082	4010	4306	4612	5040	5420		161
48 x 96BTA	VB	2	2082	4010	4306	4612	5040	5420		161
48 x 120BTA	VB	2	2699	5243	5609	5995	6159	6594		207
48 x 144BTA	VB	3	3065	5974	6413	6876	7457	7857		241
48 x 168BTA	VB	3	3530	6677	7185	7720	7990	8608		275
60 x 120BTA	VB	3	3149	6328	6784	7267	7472	8016		249
60 x 144BTA	VB	3	3604	7242	7790	8368	9096	9593		291
60 x 168BTA	VB	3	4185	8121	8754	9421	9763	10534		333



4296BTA-VB

### STANDARD FEATURES

- Laminate tops available in any standard Wilsonart, Nevamar, Formica, Arborite or Pionite matte finish offerings. For other laminate please contact the factory for pricing.
- Veneers and hardwood edges are standard in Oak, Chocolate, Maple, Cherry, Pecan, Walnut, Mahogany.
- 7 veneer and hardwood edge stains are standard. Stain-to-match available at no upcharge.
- Standard table height 29".
- All bases are standard with floor leveling glides.

### OPTIONS

- Custom heights available.
- Two tone base available, add \$104 List per base.

### HOW TO ORDER

1. Select Model
2. Select Base
3. Select Edge Style
4. Select Top Finish
5. Select Edge Finish
6. Select Base Finish

Example: 4296BT - VB - PVF

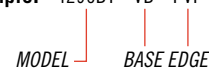

## MODESTY PANELS

SIZE	MODEL	DESCRIPTION	LIST	
For 42W Top	PMP-SR42	<b>SMALL ROUND (.266) PERFORATIONS</b>  Perforated Metal Modesty Panels are available in any Spectone color. Modesty Panels are 3" shorter than table and are 10" in height.	249	
For 48W Top	PMP-SR48		249	
For 54W Top	PMP-SR54		249	
For 60W Top	PMP-SR60		249	
For 66W Top	PMP-SR66		249	
For 72W Top	PMP-SR72		249	
For 42W Top	PMP-SS42	<b>SMALL SQUARE (.255) PERFORATIONS</b>  Perforated Metal Modesty Panels are available in any Spectone color. Modesty Panels are 3" shorter than table and are 10" in height.	249	
For 48W Top	PMP-SS48		249	
For 54W Top	PMP-SS54		249	
For 60W Top	PMP-SS60		249	
For 66W Top	PMP-SS66		249	
For 72W Top	PMP-SS72		249	
For 42W Top	PMP-BACKER42	<b>LARGE SQUARE (1.0) PERFORATIONS WITH ECO RESIN BACKER</b>  Perforated Metal Modesty Panels are available in any Spectone color. Modesty Panels are 3" shorter than table and are 10" in height. Eco Resin Backer available in semi-opaque, Nickel.	577	
For 48W Top	PMP-BACKER48		577	
For 54W Top	PMP-BACKER54		577	
For 60W Top	PMP-BACKER60		577	
For 66W Top	PMP-BACKER66		577	
For 72W Top	PMP-BACKER72		577	
For 42W Top	PMP-RESIN42	<b>ECO RESIN MODESTY PANEL</b>  Available in semi-opaque, Nickel	323	
For 48W Top	PMP-RESIN48		323	
For 54W Top	PMP-RESIN54		323	
For 60W Top	PMP-RESIN60		323	
For 66W Top	PMP-RESIN66		323	
For 72W Top	PMP-RESIN72		323	
For 42W Top	MP42	<b>WOOD OR LAMINATE MODESTY PANEL</b>  Self edge veneer or laminate modesty panel. Available on fixed tables only.	307	
For 48W Top	MP48		307	
For 54W Top	MP54		307	
For 60W Top	MP60		307	
For 66W Top	MP66		307	
For 72W Top	MP72		307	

**OPTIONS**

- Specify Modesty Panel to be fixed (add suffix F) or hinged (add suffix H)

## WIRE MANAGEMENT TROUGHS

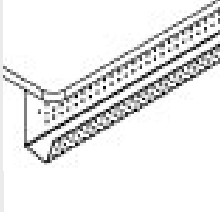
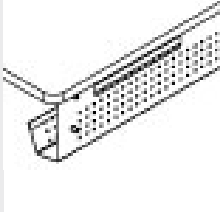
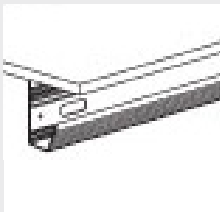
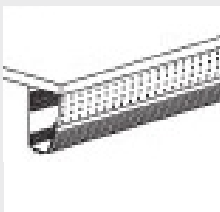
SIZE	MODEL	DESCRIPTION	LIST	
For 42W Top	CRWT42	<b>PERFORATED WIRE MANAGEMENT/MODESTY PANEL</b>  Perforated Wire Management/Modesty Panel available in any Spectone Color.	288	
For 48W Top	CRWT48		288	
For 54W Top	CRWT54		288	
For 60W Top	CRWT60		288	
For 66W Top	CRWT66		288	
For 72W Top	CRWT72		288	
For 42W Top	CRWTR42	<b>REVERSE MOUNTED PERFORATED WIRE MANAGEMENT/MODESTY PANEL</b>  Perforated Wire Management/Modesty Panel available in any Spectone Color.	288	
For 48W Top	CRWTR48		288	
For 54W Top	CRWTR54		288	
For 60W Top	CRWTR60		288	
For 66W Top	CRWTR66		288	
For 72W Top	CRWTR72		288	
For 42W Top	CEWT42	<b>EXTRUDED WIRE MANAGEMENT TROUGH</b>  Extruded Wire Management Trough is standard 3" shorter than table length and come with a 1.5" x 3.5" oval wire pass-through placed 3.5" from each end to allow for entry and exit of wiring. Available in any Spectone Color. To fill 3" gap use CET Trough Joiner.	237	
For 48W Top	CEWT48		237	
For 54W Top	CEWT54		237	
For 60W Top	CEWT60		237	
For 66W Top	CEWT66		237	
For 72W Top	CEWT72		237	
For 42W Top	CEPD42	<b>PERFORATED DOOR FOR WIRE MANAGEMENT TROUGH</b>  Spring hinged door attaches to the Extruded Wire Management Trough.	237	
For 48W Top	CEPD48		237	
For 54W Top	CEPD54		237	
For 60W Top	CEPD60		237	
For 66W Top	CEPD66		237	
For 72W Top	CEPD72		237	

## WIRE MANAGEMENT TROUGHS

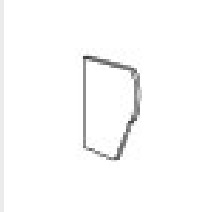
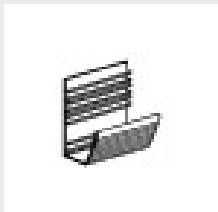
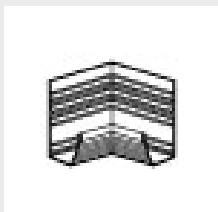



SIZE	MODEL	DESCRIPTION	LIST	
12" LENGTH	CESWN	<b>PVC WIRE MANAGER</b>  Snaps neatly in place inside or under the Extruded Wire Management Trough. There are two inside channels and two channels under the trough. All channels run the entire length of the trough. PVC Wire Manager is standard in 12" lengths in matte black.	14	
	CECAP	<b>END CAP</b>  For Extruded Wire Management Troughs. Specify left or right when seated.	38	
	CET	<b>EXTRUDED TROUGH JOINER</b>  To join Extruded Wire Management Troughs in a straight line together.	29	
	CCET	<b>EXTRUDED CORNER TROUGH JOINER</b>  To join corners of Extruded Wire Management Troughs.	69	





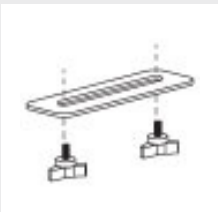

# GROMMETS, SEAM CONNECTORS AND TABLE CART

BACK TO CONTENTS

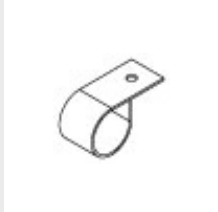

	MODEL	DESCRIPTION	LIST		LBS
	<b>CTRG</b>	<b>OVAL GROMMET</b>  3" x 5" oval surface grommet. Specify centered or to the left or right on the desktop. Custom locations are available, please specify.	35		
	<b>CTRS</b>	<b>ROUND GROMMET</b>  2" round surface grommet. Specify centered or to the left or right on the desktop. Custom locations are available, please specify.	22		
	<b>CSC</b>	<b>SEAM CONNECTOR</b>  Seam Connectors join and level tops. Includes 2 connectors, 4 thumb screws, 4 counter sunk threaded metal inserts.	80		
	<b>TABLE CART</b>	<b>TABLE CART</b>  Holds 4 to 6 tables of varying sizes. Comes standard with hard wheel swivel casters. Custom Carts are available. Ships KD.	902		48

## WIRE MANAGEMENT

	MODEL	DESCRIPTION	LIST	
	<b>CWMT</b>	<b>PVC SNAP TO LEG WIRE MANAGER</b>  Snaps to table base column to conceal and manage unsightly wires. Standard in 13.5" lengths and matte black or Nickel finish.	35	
	<b>VELCROWIREMGR</b>	<b>VELCRO WIRE MANAGER</b>  Affix to underside of table.	12	
	<b>WIREMGR</b>	<b>UNDER TABLE WIRE MANAGER</b>  24" PVC under table wire manager affix to underside of table.	27	
	<b>5PVCWIREMGR</b>	<b>5" PVC WIRE MANAGER</b>  Set of 4, for under table wire management.	49	
	<b>CMHA</b>	<b>CABLE MANAGER FOR HEIGHT ADJUSTABLE TABLES</b>  Cable management, spiral tube. Black. Plastic. 6" base diameter. Spiral 3-3/8" dia. Maximum height 84".	260	

# POWER AND COMMUNICATION PACKAGES CPCM AND CPCMJ

BACK TO CONTENTS

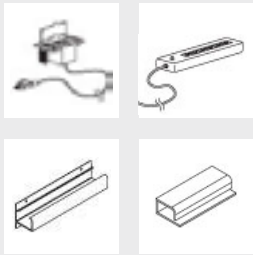
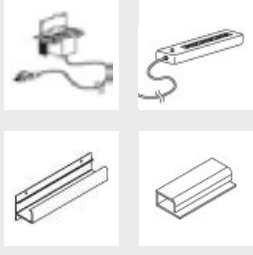
MODEL	DESCRIPTION	LIST	
<b>CPCMPP1</b>	<p><b>CPCM POWER PACKAGE 1</b></p> <p>Includes CPCM, CSP Surge Supressed Power Bar with 10' cord, CSP Snap in Power Bar Holder and 5" PVC Wire Managers (set of 4). Does not include data communication jacks. Specify 3", 6" or 9" cord length for CPCM.</p>	340	
<b>CPCMJP2</b>	<p><b>CPCMJ POWER PACKAGE 2</b></p> <p>Includes CPCMJ, CSP Surge Supressed Power Bar with 10' cord, CSP Snap in Power Bar Holder and 5" PVC Wire Managers (set of 4). <b>Includes RJ45 Cat 6 or RJ11.</b> Specify 1 of each or 2 of either. Specify 3", 6" or 9" cord length for CPCMJ.</p>	419	

**STANDARD FEATURES**

- 15 Amp
- UL and CSA Listed







# POWER AND COMMUNICATION ACCESSORIES

## CPCM AND CPCMJ

BACK TO CONTENTS



	MODEL	DESCRIPTION	LIST	
	<b>CPCM-3</b> <b>CPCM-6</b> <b>CPCM-9</b>	<b>SINGLE DUPLEX WITHOUT JACKS</b>  Molded plastic housing and “flip-drop” lid. Available with cord lengths of 3’, 6’ or 9’.	192 192 192	
	<b>CPCMJ-3</b> <b>CPCMJ-6</b> <b>CPCMJ-9</b>	<b>SINGLE DUPLEX WITH JACKS</b>  Molded plastic housing and “flip-drop” lid. Includes RJ45 Cat 6 or RJ11. Specify 1 of each or 2 of either. Available with cord lengths of 3’, 6’ or 9’.	271 271 271	
	<b>CSP</b>	<b>SURGE SUPPRESSED SIX OUTLET POWER BAR</b>  Fits snug in the wire management trough and is standard with 10’ cord in matte black. Is UL and CSA approved and can meet regional requirements.	53	
	<b>CSPHOLDER</b>	<b>CSP HOLDER</b>  PVC snap in holder secures power bar beneath table top.	41	



# POWER AND COMMUNICATION ACCESSORIES PHANTOM

BACK TO CONTENTS



MODEL	DESCRIPTION	LIST	
PH2	<b>PHANTOM 2</b>  The Phantom 2 is Split into 2 sections. Each section can hold either 1 duplex or 1 data plate with 3 units of options.	652	
PH4	<b>PHANTOM 4</b>  The Phantom 4 is Split into 4 sections. Each section can hold either 1 duplex or 1 data plate with 3 units of options.	807	

### STANDARD FEATURES

- Available in Black Textured or Nickel Textured finishes.
- Standard with 9' plug in cord with a 6" cord with single receptacle.
- Units daisy chain together.
- 15 amp.
- UL and CSA Listed.

### OPTIONS

- For hardwired applications, contact Spec for pricing.



# POWER AND COMMUNICATION ACCESSORIES PHANTOM CONFIGURATION OPTIONS

BACK TO CONTENTS

## PHANTOM 2 (PH2)

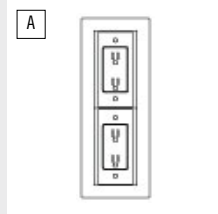

2 Duplexes

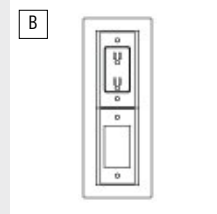

1 Duplex and 1 Data

## PHANTOM 4 (PH4)

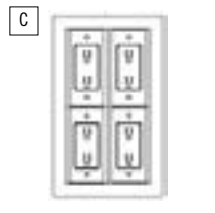

4 Duplexes  
Audio/Video  
Faceplate

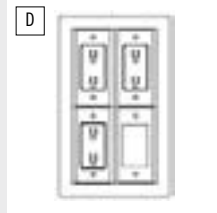

3 Duplexes  
1 Data/Phone  
Audio/Video  
Faceplate

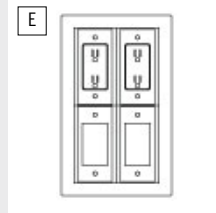

2 Duplexes  
2 Data/Phone  
Audio/Video  
Faceplate

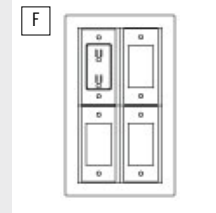

1 Duplex  
3 Data/Phone  
Audio/Video  
Faceplate

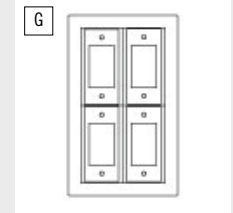

4 Data/Phone  
Audio/Video  
Faceplate

### PLEASE NOTE

- When ordering a phantom box with no communication plate option, a safety plate will be provided.

### TO ORDER

- Specify either PH2 or PH4 and add the letter to the desired configuration. e.g. PH2-B.
- Also specify quantity of: RJ11 voice jack and RJ45 Cat 6 data jack. e.g. 3xRJ25 or 3xRJ45.



# POWER AND COMMUNICATION ACCESSORIES

## PHANTOM POWER AND VOICE/DATA ACCESSORIES

EXAMPLES OF 1 DATA PLATE

BACK TO CONTENTS



### PHANTOM PLATE CONFIGURATION OPTIONS FOR DATA & PHONE

#### 6x RJ 45 (CAT.6)



#### CONFIGURATION A

Consists of the following:

- 3x **OPTION 28** = \$52 LIST
- TOTAL LIST = \$156 LIST**

#### 1x RJ 11 (CAT.3), AND 5x RJ 45 (CAT.6)

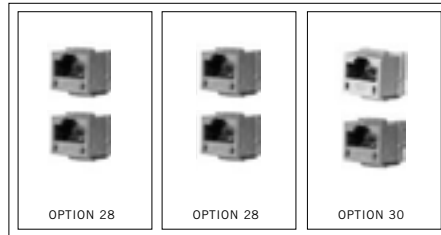

#### CONFIGURATION B

Consists of the following:

- 1x **OPTION 30** = \$60 LIST
- 2x **OPTION 28** = \$52 LIST
- TOTAL LIST = \$164 LIST**

### PHANTOM PLATE CONFIGURATION OPTIONS FOR AUDIO/VIDEO

#### 1x 15 PIN VGA, BLANK AND RJ 11, RJ 45 (CAT. 6)

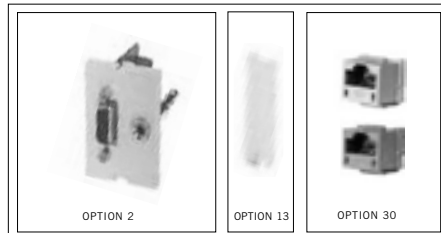

#### CONFIGURATION C

Consists of the following:

- 1x **OPTION 2** = \$290 LIST
- 1x **OPTION 13** = NO CHARGE
- 1x **OPTION 30** = \$60 LIST
- TOTAL LIST = \$350 LIST**

#### 1x HDMI A/V CONNECTOR, 15 PIN V99 AND BLANK

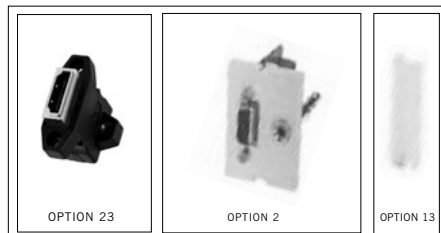

#### CONFIGURATION D

Consists of the following:

- 1x **OPTION 23** = \$399 LIST
- 1x **OPTION 2** = \$290 LIST
- 1x **OPTION 13** = NO CHARGE
- TOTAL LIST = \$689 LIST**



# POWER AND COMMUNICATION ACCESSORIES

## PHANTOM POWER AND VOICE/DATA ACCESSORIES

BACK TO CONTENTS



**OPTION 2** - \$290 List  
15 Pin VGA, 3.5mm Stereo  
(1.5 Unit)  
Front: 15 Pin VGA Female, 3.5mm  
Back: Solder



**OPTION 11** - \$126 List  
15 Pin VGA  
(1 Unit)  
Front: 15 Pin Female  
Back: 15 Pin Female



**OPTION 13** - No Charge  
Blank  
(0.5 Unit)



**OPTION 14** - No Charge  
Blank  
(1 Unit)



**OPTION 15** - No Charge  
Blank  
(1.5 Unit)



**OPTION 30** - \$60 List  
RJ 11 (cat. 3)/  
RJ 45 (cat. 6)  
(1 Unit)



**OPTION 17** - \$70 List  
RJ 11 (cat. 3) X 2  
(1 Unit)



**OPTION 28** - \$52 List  
RJ 45 (cat. 6) X 2  
(1 Unit)



**OPTION 19** - \$40 List  
RJ 11 (cat. 3) X 1  
(1 Unit)



**OPTION 29** - \$31 List  
RJ 45 (cat. 6) X 1  
(1 Unit)



**OPTION 21** - \$315 List  
USB 2.0 Performance  
(1 Unit)  
Front: Type A & B (F/F)  
Back: Type A & B (F/F)



**OPTION 22** - \$309 List  
USB 2.0 Performance  
(1 Unit)  
Front: Type A & A (F/F)  
Back: Type A & A (F/F)



**OPTION 23** - \$399 List  
HDMI-A/V Connector  
(1 Unit)  
Front: Female  
Back: Female



**OPTION 32** - \$194 List  
RJ 45 (cat. 6)  
USB 2.0 (F/F) Type A & A  
(1 Unit)



**OPTION 26** - \$194 List  
RJ 45 (cat. 6)  
USB 2.0 (F/F) Type A-to-B  
(1 Unit)



**OPTION 27** - \$209 List  
RJ 11 (cat. 3)  
USB 2.0 (F/F) Type A-to-B  
(1 Unit)

(1 Unit) (1 Unit) (1 Unit) (0.5 Unit) (1.5 Unit) (1 Unit)

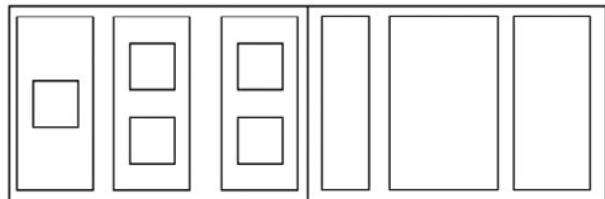

**NOTE:** Phantom 2 with 1 duplex will only accept 3 X 1 Unit or 2 X 1.5 Unit.  
Phantom 2 with no duplex will accept 6 X 1 Unit or 4 X 1.5 Unit.

All plate options are standard in black colour only.



# POWER AND COMMUNICATION ACCESSORIES

## MHO - CORDED

BACK TO CONTENTS



	MODEL	DESCRIPTION	LIST	
	<b>MHO1P3D-10</b> <b>MHO1P3D-6</b> <b>MHO1P3D-2</b>	<b>MHO CORDED</b> Mho, 1 power, 3 data ports, 10' cord Mho, 1 power, 3 data ports, 6' cord Mho, 1 power, 3 data ports, 2' cord <b>Data Jacks are not included</b>	559 559 559	
	<b>MHO2P2D-10</b> <b>MHO2P2D-6</b> <b>MHO2P2D-2</b>	<b>MHO CORDED</b> Mho, 2 power, 2 data ports, 10' cord Mho, 2 power, 2 data ports, 6' cord Mho, 2 power, 2 data ports, 2' cord <b>Data Jacks are not included</b>	559 559 559	
	<b>MHO3P1D-10</b> <b>MHO3P1D-6</b> <b>MHO3P1D-2</b>	<b>MHO CORDED</b> Mho, 3 power, 1 data ports, 10' cord Mho, 3 power, 1 data ports, 6' cord Mho, 3 power, 1 data ports, 2' cord <b>Data Jacks are not included</b>	559 559 559	
	<b>MHO4P-10</b> <b>MHO4P-6</b> <b>MHO4P-2</b>	<b>MHO CORDED</b> Mho, 4 power, 0 data ports, 10' cord Mho, 4 power, 0 data ports, 6' cord Mho, 4 power, 0 data ports, 2' cord <b>Data Jacks are not included</b>	712 712 712	

### STANDARD FEATURES

- Use with powerbars.
- MHO exterior clear anodized aluminum, interior black.
- Rated for 15 AMPS.
- UL and CSA Listed.
- One touch door that remains open during use.

### OPTIONS

- For hardwired applications, contact Spec for pricing.
- Specify data and other communication jacks if required.



# POWER AND COMMUNICATION ACCESSORIES

## MHO - INTERLINK IQ

BACK TO CONTENTS



	MODEL	DESCRIPTION	LIST	
	<b>MIQS1P3D-10</b>	<b>STARTER KIT</b> Interlink IQ Starter kit including Mho, 1 power, 3 data ports, 10' cord. <b>Data Jacks are not included</b>	1136	
	<b>MIQS2P2D-10</b>	Interlink IQ Starter kit including Mho, 2 power, 2 data ports, 10' cord. <b>Data Jacks are not included</b>	1136	
	<b>MIQS3P1D-10</b>	Interlink IQ Starter kit including Mho, 3 power, 1 data port, 10' cord. <b>Data Jacks are not included</b>	1136	
	<b>MIQA1P3D-6</b>	<b>ADD-ONS</b> Interlink IQ Add-on includes Mho, 1 power, 3 data ports, 60" modular connection. <b>Data Jacks are not included</b>	569	
	<b>MIQA2P2D-6</b>	Interlink IQ Add-on includes Mho, 2 power, 2 data ports, 60" modular connection. <b>Data Jacks are not included</b>	569	
	<b>MIQA3P1D-6</b>	Interlink IQ Add-on includes Mho, 3 power, 1 data port, 60" modular connection. <b>Data Jacks are not included</b>	569	
	<b>MIQPASS - 12</b>	<b>PASS-THRU</b> 12" Pass through for connections over 60" but not over 72". For every pass through used reduce the number of Mho's by one.	109	

### STANDARD FEATURES

- Specify one Starter per row and up to 7 Add-ons.
- Daisy chain is non sequential.
- Up to 8 Connections.
- Limit of 3 Power per unit.
- 12 AMP Single Circuit System.
- 15 AMP Corded Infeed.
- UL 962 recognized.

### OPTIONS

- For hardwired applications, contact Spec for pricing.
- Specify data and other communication jacks if required.



# POWER AND COMMUNICATION ACCESSORIES

## MHO - DATA ACCESSORIES

BACK TO CONTENTS



	MODEL	DESCRIPTION	LIST	
	<b>MHO-RJ45C5</b>	AMP RJ45 Data Jack Cat 5e	28	
	<b>MHO-RJ45C6</b>	AMP RJ45 Data Jack Cat 6	45	
	<b>MHO-RJ11C3</b>	AMP RJ11 Telephone Jack Cat 3	17	
	<b>MHO-RJ45-6</b>	Siemon RJ45 Data Jack, Cat 6 with 6' patch cord	107	
	<b>MHO-RJ45-10</b>	Siemon RJ45 Data Jack, Cat 6 with 10' patch cord	111	
	<b>MHO-VGA-6</b>	15 Pin VGA with 6' patch cord	105	
	<b>MHO-VGA-10</b>	15 Pin VGA with 10' patch cord	129	
	<b>MHO-USBA-6</b>	Passive USB - A Jack (rectangular opening) 4' cord	64	
	<b>MHO-USBB-4</b>	Passive USB - B Jack (square opening) 4' cord	64	
	<b>MHO-AUDIO-10</b>	Audio - 3.5mm Mini Stereo w/10' MF cable	28	
	<b>MHO-HDMI-10</b>	HDMI Port w/ 18" Coupler	103	









# POWER AND COMMUNICATION ACCESSORIES

## COVE

BACK TO CONTENTS

	MODEL	DESCRIPTION	LIST	
		<b>Cove, Clamp Mounted</b>		
	<b>COVC2P2U-B</b>	Cove, 2 power, 2USB, <b>Black</b>	386	
	<b>COVC2P2U-S</b>	Cove, 2 power, 2USB, <b>Silver Pearl</b>	386	
	<b>COVC2P2U-W</b>	Cove, 2 power, 2USB, <b>Gloss White</b>	386	
		<b>Clamp mount method works well for desks, benches, tables and casegoods. Cord is 108". USB is for charging only.</b>		
		<b>Cove, Screw Mounted</b>		
	<b>COVS2P2U-B</b>	Cove, 2 power, 2USB, <b>Black</b>	386	
	<b>COVS2P2U-S</b>	Cove, 2 power, 2USB, <b>Silver Pearl</b>	386	
	<b>COVS2P2U-W</b>	Cove, 2 power, 2USB, <b>Gloss White</b>	386	
		<b>Screw mount method is best suited to installations where the back of the unit has limited, or no access. Cord is 108". USB is for charging only.</b>		







# POWER AND COMMUNICATION ACCESSORIES

## VILLA™ SERIES - DAISYLINK™ SYSTEM - SINGLE KIT

BACK TO CONTENTS



TABLE SIZE	MODEL	DESCRIPTION	LIST	
36" L TABLE	VILLS2P2D-36B	36" Villa, 2 power, 2 data ports, <b>Black</b>	348	
	VILLS2P2D-36S	36" Villa, 2 power, 2 data ports, <b>Silver</b>	348	
	VILLS2P2D-36W	36" Villa, 2 power, 2 data ports, <b>White</b>	391	
42" L TABLE	VILLS2P2D-42B	42" Villa, 2 power, 2 data ports, <b>Black</b>	348	
	VILLS2P2D-42S	42" Villa, 2 power, 2 data ports, <b>Silver</b>	348	
	VILLS2P2D-42W	42" Villa, 2 power, 2 data ports, <b>White</b>	391	
48" L TABLE	VILLS2P2D-48B	48" Villa, 2 power, 2 data ports, <b>Black</b>	348	
	VILLS2P2D-48S	48" Villa, 2 power, 2 data ports, <b>Silver</b>	348	
	VILLS2P2D-48W	48" Villa, 2 power, 2 data ports, <b>White</b>	391	
60" L TABLE	VILLS2P2D-60B	60" Villa, 2 power, 2 data ports, <b>Black</b>	348	
	VILLS2P2D-60S	60" Villa, 2 power, 2 data ports, <b>Silver</b>	348	
	VILLS2P2D-60W	60" Villa, 2 power, 2 data ports, <b>White</b>	391	
72" L TABLE	VILLS2P2D-72B	72" Villa, 2 power, 2 data ports, <b>Black</b>	348	
	VILLS2P2D-72S	72" Villa, 2 power, 2 data ports, <b>Silver</b>	348	
	VILLS2P2D-72W	72" Villa, 2 power, 2 data ports, <b>White</b>	391	
		<b>Single Kit</b>		
		<b>2 Data Caps are included. RJ45 Data Jacks are not included.</b>		
	VRJ45	Single RJ45 Cat6, <b>Black</b>	54	

**SINGLE KIT INCLUDES:**

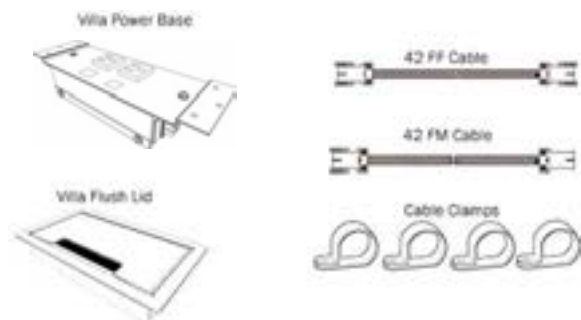





# POWER AND COMMUNICATION ACCESSORIES

## VILLA™ SERIES - DAISYLINK™ SYSTEM - DOUBLE KIT

BACK TO CONTENTS

TABLE SIZE	MODEL	DESCRIPTION	LIST	
60" L TABLE	VILLD2P2D-60B	60" Villa, 2 power, 2 data ports, <b>Black</b>	653	
	VILLD2P2D-60S	60" Villa, 2 power, 2 data ports, <b>Silver</b>	653	
	VILLD2P2D-60W	60" Villa, 2 power, 2 data ports, <b>White</b>	696	
72" L TABLE	VILLD2P2D-72B	72" Villa, 2 power, 2 data ports, <b>Black</b>	653	
	VILLD2P2D-72S	72" Villa, 2 power, 2 data ports, <b>Silver</b>	653	
	VILLD2P2D-72W	72" Villa, 2 power, 2 data ports, <b>White</b>	696	
84" L TABLE	VILLD2P2D-84B	84" Villa, 2 power, 2 data ports, <b>Black</b>	653	
	VILLD2P2D-84S	84" Villa, 2 power, 2 data ports, <b>Silver</b>	653	
	VILLD2P2D-84W	84" Villa, 2 power, 2 data ports, <b>White</b>	696	
96" L TABLE	VILLD2P2D-96B	96" Villa, 2 power, 2 data ports, <b>Black</b>	653	
	VILLD2P2D-96S	96" Villa, 2 power, 2 data ports, <b>Silver</b>	653	
	VILLD2P2D-96W	96" Villa, 2 power, 2 data ports, <b>White</b>	696	
		<b>Double Kit</b>		
		<b>2 Data Caps per unit are included. RJ45 Data Jacks are not included.</b>		
	VRJ45	Single RJ45 Cat6, <b>Black</b>	54	

Specify double kit when two Villas are in one single table

### DOUBLE KIT INCLUDES

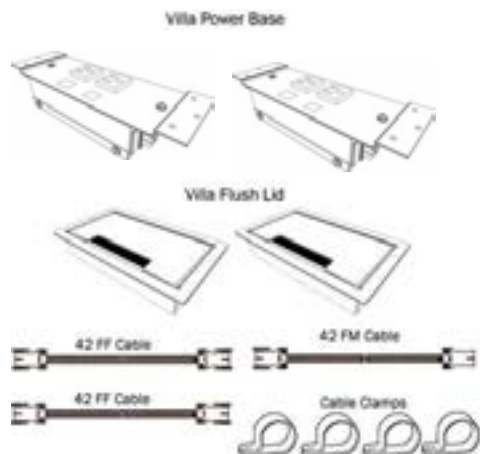





# POWER AND COMMUNICATION ACCESSORIES

## VILLA™ SERIES - CORDED

BACK TO CONTENTS



MODEL	DESCRIPTION	LIST	
<b>VILLCDKO-36B</b>	Corded Villa, 2 power, 2 data ports, 36" cord, <b>Black</b>	262	 
<b>VILLCDKO-36S</b>	Corded Villa, 2 power, 2 data ports, 36" cord, <b>Silver</b>	262	
<b>VILLCDKO-72B</b>	Corded Villa, 2 power, 2 data ports, 72" cord, <b>Black</b>	262	
<b>VILLCDKO-72S</b>	Corded Villa, 2 power, 2 data ports, 72" cord, <b>Silver</b>	262	
<b>VILLCDKO-108B</b>	Corded Villa, 2 power, 2 data ports, 108" cord, <b>Black</b>	262	
<b>VILLCDKO-108S</b>	Corded Villa, 2 power, 2 data ports, 108 cord, <b>Silver</b>	262	
	<b>2 Data Caps are included. RJ45 Data Jacks are not included.</b>		
<b>VRJ45</b>	Single RJ45 Cat6, <b>Black</b>	54	







# POWER AND COMMUNICATION ACCESSORIES

## VILLA™ SERIES - OPTIONS

BACK TO CONTENTS



	MODEL	DESCRIPTION	LIST	
	<b>VILLPOWERFEED</b>	Multi-Circuit Hardwired Power Infeed UL Listed & CSA Certified	150	
	<b>VILLQDINSERT</b>	Insert for floor box and wall outlet applications. Fits standard Decora® opening. UL Listed & CSA Certified	86	
	<b>VILLFEEDPLUG</b>	Single Circuit Power Infeed with 72" Molded Plug Required for non-sequenced power applications. UL Listed	169	
	<b>VILL42FFL-72</b>	Female/Female Interconnecting Cable UL Listed & CSA Certified	120	
	<b>VILLDAISYT</b>	Daisy-T Power Manager	129	



# OVERBED TABLES & BEDSIDE CABINETS

# BEDSIDE CABINETS & CASEGOODS



PLACING AN ORDER IS EASY

## PRODUCT CODE

**TBCAB - BR**

### Series

TBCAB : Standard  
ATCABNR : Aluminum Trim

### Configuration

A : 3 Drawer  
BR : 1 Drawer with Right Hinged Door  
BL : 1 Drawer with Left Hinged Door  
C : 1 Drawer with Open Shelf  
F : 2 Drawer with Floating Top  
DHD : Heavy Duty with Recessed Shelf

## OPTIONS

### GALLERY RAIL



EXTENDED BASE



### SPILL COLLECTOR ALUMINUM TRIM



LOCKABLE CASTERS



### HANDLES



Arc Door Handle



Straight Door Handle



Integrated Pull

## FINISHES

### LAMINATE



Select from a variety of laminate colors for tops to match melamine sides.

### THERMOFOIL

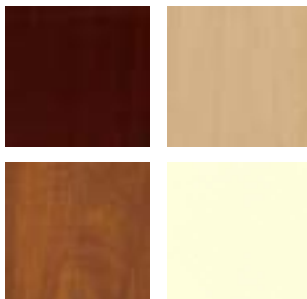

Select from one of our 7 standard wood stains or stain-to-match at no upcharge

### ALUMINUM TRIM



Select from one of our 76 standard Spectone colors

# BEDSIDE CABINETS AND CASEGOODS

## Standard

### Standard Features

- Choice of thermofoil top and fronts or laminate tops with melamine fronts
- Sides and backs of cabinet standard with melamine
- 8 Standard thermofoil finishes available to match 8 standard melamine finishes
- Steel drawer slides
- Arc and straight handle profiles are brushed nickel Integrated pull also available
- Standard at 32" height
- Rear ventilation holes

### Options

- Choice of 4 post legs or 4 locking casters (front 2 locking) at same price
- 3 drawer model not available with casters
- Spill Collector Edge, for thermofoil tops only, add \$59 List
- Gallery Rail option add \$95 List (straight profile handle design)
- Plastic Drawer Insert add \$50 List
- Key Lock add \$55 List
- Extended Base Platform, add \$51 List
- Thermofoil finishes are located on the last page of the price list
- For cabinets manufactured with NAUF Particle Board, call factory for pricing



Gallery Rail Top



Spill Collector Edge



Arc Handle



Straight Handle



Integrated Pull



Extended Base Platform



Cabinet Glides



Post Leg

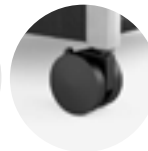

Lockable Casters

### Bedside Cabinets

		Laminate Top with Melamine Fronts	Thermofoil Tops and Fronts
3 Drawer	TBCAB-A	<b>954</b>	<b>1061</b>
1 Drawer with hinged door on right and shelf	TBCAB-BR	<b>857</b>	<b>962</b>
1 Drawer with hinged door on left and shelf	TBCAB-BL	<b>857</b>	<b>962</b>
1 Drawer with open shelf	TBCAB-C	<b>821</b>	<b>882</b>
2 Drawer with floating top	TBCAB-F	<b>1019</b>	<b>1186</b>
Heavy Duty Cabinet with recessed shelf	TBCAB-DHD	<b>1081</b>	-

Dimensions (inches) - Unless otherwise noted  
 Width 20    Depth 21    Height 32



TBCAB-A



TBCAB-BR



TBCAB-C



TBCAB-F  
26 7/8" H



TBCAB-DHD





## BEDSIDE CABINETS AND CASEGOODS

### Aluminum Side Trim

#### Standard Features

- Choice of thermofoil top and fronts or laminate tops with melamine fronts
- Aluminum side trim available in 76 Spectone colors
- Sides and backs of cabinet standard with melamine
- 8 Standard thermofoil finishes available to match 8 standard melamine finishes
- Steel drawer slides
- Arc and straight handle profiles are brushed nickel Integrated pull also available
- Standard at 32" height
- Rear ventilation holes

#### Options

- Choice of 4 post legs or 4 locking casters (front 2 locking) at same price
- 3 drawer model not available with casters
- Spill Collector Edge, for thermofoil tops only, add \$59 List
- Gallery Rail option add \$95 List (straight profile handle design)
- Plastic Drawer Insert add \$50 List
- Key Lock add \$55 List
- Thermofoil finishes are located on the last page of the price list
- For cabinets manufactured with NAUF Particle Board, call factory for pricing



Gallery Rail Top



Spill Collector Edge



Arc Handle



Straight Handle



Integrated Pull



Cabinet Glides

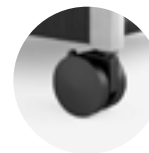

Lockable Casters

#### Bedside Cabinets

		Laminate Top with Melamine Fronts	Thermofoil Tops and Fronts
3 Drawer	ATCABNR-A	<b>1058</b>	<b>1174</b>
1 Drawer with hinged door on right and shelf	ATCABNR-BR	<b>951</b>	<b>1064</b>
1 Drawer with hinged door on left and shelf	ATCABNR-BL	<b>951</b>	<b>1064</b>
1 Drawer with open shelf	ATCABNR-C	<b>916</b>	<b>982</b>

Dimensions (inches)

Width	20	Depth	21	Height	32
-------	----	-------	----	--------	----



ATCABNR-A



ATCABNR-BR



ATCABNR-C



## BEDSIDE CABINETS AND CASEGOODS – Dressers

### Standard Features

- Choice of thermofoil top and fronts or laminate tops with melamine fronts
- Sides and backs of cabinet standard with melamine
- 8 Standard thermofoil finishes available to match 8 standard melamine finishes
- Steel drawer slides
- Arc and straight handle profiles are brushed nickel
- Rear ventilation holes

### Options

- Handles available in arc shape or straight profile
- Thermofoil finishes are located on the last page of the price list
- For cabinets manufactured with NAUF Particle Board, call factory for pricing



Arc Handle



Straight Handle

### Dressers

TBCAS-A	Laminate Top with Melamine Fronts	Thermofoil Tops and Fronts
3 Drawer Dresser	<b>1246</b>	<b>1379</b>
Dimensions (inches)		
Width 32.5	Depth 21	Height 32



**TBCAS-A 3 Drawer Dresser**  
143 Lbs  
15 Cu Ft

TBCAS-B	Laminate Top with Melamine Fronts	Thermofoil Tops and Fronts
4 Drawer Dresser	<b>1460</b>	<b>1671</b>
Dimensions (inches)		
Width 32.5	Depth 21	Height 41.5



**TBCAS-B 4 Drawer Dresser**  
178 Lbs  
19 Cu Ft



## BEDSIDE CABINETS AND CASEGOODS – TV Unit

### Standard Features

- Choice of thermofoil top and fronts or laminate tops with melamine fronts
- Sides and backs of cabinet standard with melamine
- 8 Standard thermofoil finishes available to match 8 standard melamine finishes
- Steel drawer slides
- Arc and straight handle profiles are brushed nickel
- Rear ventilation holes
- Post legs

### Options

- Handles available in arc shape or straight profile
- Thermofoil finishes are located on the last page of the price list
- For cabinets manufactured with NAUF Particle Board, call factory for pricing



Arc Handle



Straight Handle

### TV Unit

TBTV-A	Laminate Top with Melamine Fronts	Thermofoil Tops and Fronts
TV Unit - Open shelf above, 3 drawers below	<b>2091</b>	<b>2574</b>
Dimensions (inches)		
Width 32.5	Depth 25	Height 68.5



**TBTV-A TV Unit**  
236 Lbs  
42 Cu Ft

## BEDSIDE CABINETS AND CASEGOODS – Wardrobes

### Standard Features

- Choice of thermofoil top and fronts or laminate tops with melamine fronts
- Sides and backs of cabinet standard with melamine
- 8 Standard thermofoil finishes available to match 8 standard melamine finishes
- Steel drawer slides
- Arc and straight handle profiles are brushed nickel
- Rear ventilation holes
- Post legs

### Options

- Handles available in arc shape or straight profile
- Thermofoil finishes are located on the last page of the price list
- For cabinets manufactured with NAUF Particle Board, call factory for pricing



Arc Handle



Straight Handle

### Wardrobes

TBWAR-A	Laminate Top with Melamine Fronts	Thermoform Tops and Fronts
Wardrobe - Full length doors	<b>2129</b>	<b>2702</b>

Dimensions (inches)			
Width	32.5	Depth	25
		Height	68.5



**TBWAR-A Wardrobe**  
249 Lbs  
42 Cu Ft

TBWAR-B	Laminate Top with Melamine Fronts	Thermoform Tops and Fronts
Wardrobe - 2 Doors, 1 drawer	<b>2261</b>	<b>3002</b>

Dimensions (inches)			
Width	32.5	Depth	25
		Height	68.5



**TBWAR-B Wardrobe/Drawer**  
249 Lbs  
42 Cu Ft



# THERMOFOIL FINISHES – Cabinets & Casegoods

## Standard Features

- Tops and Fronts are available in thermofoil finishes
- Sides and backs are standard in matching melamine

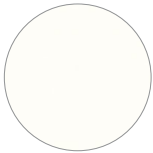

**Antique White**  
Matches Wilsonart  
Antique White 1572-60



**Libretti**  
Matches Wilsonart  
Cafelle 7933-07



**Wild Cherry**  
Matches Wilsonart  
Wild Cherry 7054-60



**Brazilian Walnut**  
Matches Wilsonart Figure  
Mahogany 7040A-60

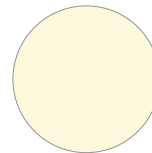

**Almond**  
Matches Wilsonart  
Natural Almond D30-60



**Hard Rock Maple**  
Matches Arborite  
Hard Rock Maple L303



**Wild Apple**  
Matches Arborite  
Candelight T421



**Dark Walnut**  
Matches Wilsonart  
Montana Walnut 7110T-60





# OVERBED TABLES

BACK TO CONTENTS



PLACING AN ORDER IS EASY

## PRODUCT CODE

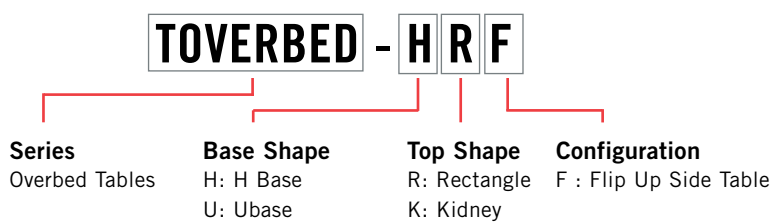

## OPTIONS

### BASES



H Base

U Base

### TOPS



Kidney

Rectangle

### SIDE TABLE



### SPILL COLLECTOR



### HIDEAWAY VANITY



### WIRE BASKET



## FINISHES

### LAMINATE



Select laminate from our virtually unlimited laminate options

### THERMOFOIL

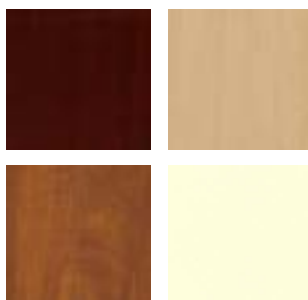

Select from one of our 7 standard wood stains or stain-to-match at no upcharge

### BASE



Select from one of our 76 standard Spectone colors



# OVERBED TABLES

DESIGNED FOR TODAY'S HEALTHCARE FACILITIES

## NOTES

- 3/4" laminate or thermofoil tops are available in Rectangle or Kidney shapes
- Thermofoil tops come standard with spill collector edge
- Laminate tops are available in any standard Wilsonart, Nevamar, Formica, Pionite or Arborite matte finish offerings
- For other laminates please contact the factory for pricing
- 38 PVC edge colors are available
- Thermoform tops with Spill Collector Edge available in choice of 8 standard finishes (see below)
- Bases are standard in Nevada or Graphite Grey
- Standard with swivel non-locking casters
- Height range is 29"-43"
- Ships 1 per box
- H and U Frame foot height are 1.75"

## OPTIONS

- Choice of 2 top shapes - Rectangle and Kidney
- Choice of 2 base designs - H and U
- Hide-away Vanity, add \$206 List
- Storage Basket, add \$104 List
- See finish options below



STORAGE BASKET



HIDE-AWAY VANITY



U BASE



H BASE

## Overbed Tables

		Laminate	Thermofoil
H Base with Rectangle Top - 18x32	TOVERBED-HR	923	950
H Base with Kidney Top - 18x32	TOVERBED-HK	923	950
H Base with Rectangle Top & Side Table - 18x40	TOVERBED-HRF	-	1637
H Base with Kidney Top & Side Table - 18x40	TOVERBED-HKF	-	1637
U Base with Rectangle Top - 18x32	TOVERBED-UR	923	950
U Base with Kidney Top - 18x32	TOVERBED-UK	923	950
U Base with Rectangle Top & Side Table - 18x40	TOVERBED-URF	-	1637
U Base with Kidney Top & Side Table - 18x40	TOVERBED-UKF	-	1637

## 8 Thermofoil Finishes

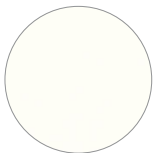

ANTIQUE WHITE  
MATCHES WILSONART  
ANTIQUE WHITE 1572-60



LIBRETTI  
MATCHES WILSONART  
CAFELLE 7933-07



WILD CHERRY HD  
MATCHES WILSONART  
WILD CHERRY 7054-60

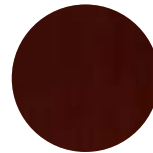

BRAZILIAN WALNUT  
MATCHES WILSONART  
FIGURE MAHOGANY  
7040A-60

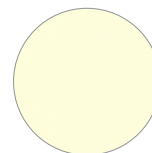

ALMOND  
MATCHES WILSONART  
NATURAL ALMOND D30-60



HARD ROCK MAPLE  
MATCHES WILSONART  
FUSION MAPLE 7909-60



WILD APPLE  
MATCHES ARBORITE  
CANDELIGHT T421



DARK WALNUT  
MATCHES WILSONART  
MONTANA WALNUT  
7110T-60



# CREDENZAS & LECTERNS



# CREDENZAS, CARTS & LECTERNS



\*Shown with an edge handle, and optional 1" x 1" Square Steel Tube Base.

PLACING AN ORDER IS EASY

**PRODUCT CODE**

**CR 243629**

**Series**  
Credenza

**Size**  
Width x Length x Height

**OPTIONS**

**FOOT OPTIONS**



2" Laminate or Veneer Kickplate Base



2" Brushed Aluminum Laminate Kickplate Base



1" x 1" Square Steel Tube Base



Casters on Hospitality Carts

**HANDLES**

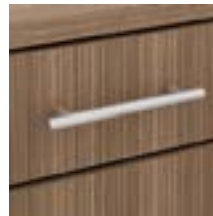

Straight Handle  
(Brushed Stainless Steel)

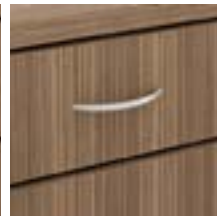

Arc Handle  
(Brushed Stainless Steel)



Edge Handle  
(Chrome)

**GARBAGE PULL-OUT**



Available with Buffet Height Credenzas only

**FINISHES**

**LAMINATE**



Select laminate from our virtually unlimited laminate options

**VENEER**

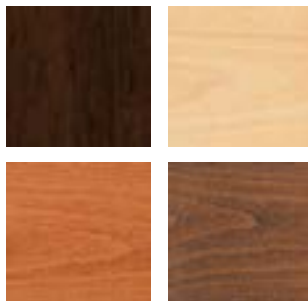

Select from one of our 7 standard wood stains or stain-to-match at no upcharge

**EDGE**



2MM

PVC

Hard Wood

**CORIAN TOP**

See [specfurniture.com](http://specfurniture.com) for current Group A & B Corian Top finishes





**1" x 1" SQ STEEL TUBE BASE**

Select from 76 standard Spectone colors.





# CREDENZAS - 29" HIGH

	MODEL	SIZE	TOP SPECIFICATIONS			OPTIONS	LBS
	<i>Code</i>		<i>For Laminate Top</i>		<i>For Veneer Top</i>	<i>Corian Top</i>	
			PVF PVB 2MM SE	HF HB HBV HBVR HB2 HKN	HF HB HBV HBVR HB2 HKN SE	GROUP A&B	
<b>CREDENZA</b>  Two doors. One adjustable shelf.    Product shown with optional 1" x 1" Square Steel Tube Base.	<b>CR243629-2D</b>	24D x 36W x 29H	2507	2974	3469	1441	110 <sup>1</sup>
<b>CREDENZA</b>  Three doors. One adjustable shelf.    Product shown with optional 1" x 1" Square Steel Tube Base.	<b>CR244829-3D</b>	24D x 48W x 29H	2707	3220	3716	1922	140 <sup>1</sup>
<b>CREDENZA</b>  Two center drawers and two doors. One adjustable shelf.    Product shown with optional 1" x 1" Square Steel Tube Base.	<b>CR244829-2F2D</b>	24D x 48W x 29H	3089	3602	4098	1922	170 <sup>1</sup>

<sup>1</sup> For Corian Top add 20lbs for 2436, and 27lbs for 2448 credenza.

All product images are shown with an edge handle, and optional 1" x 1" Square Steel Tube Base.



2" Laminate or Veneer Kickplate Base      2" Brushed Aluminum Laminate Kickplate Base      1" x 1" Square Steel Tube Base

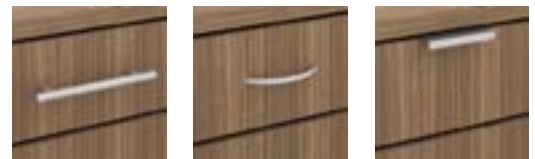

Straight Handle (Brushed Stainless Steel)      Arc Handle (Brushed Stainless Steel)      Edge Handle (Chrome)

### STANDARD FEATURES

- Laminate available in any standard Wilsonart, Nevamar, Formica, Arborite or Pionite matte finish offerings. For other laminate please contact the factory for pricing.
- Veneers and hardwood edges are standard in Oak, Maple, Cherry, Pecan, Walnut, Mahogany and Chocolate.
- 7 veneer and hardwood edge stains are standard. Stain-to-match available at no upcharge.
- Standard credenza height 29".
- Touch latch doors are standard.
- 2" Laminate or Veneer Kickplate Base is standard.
- Interior of laminate credenzas is finished in black melamine.

### OPTIONS

- Specify straight, arc or edge handles at no upcharge.
- For Locks, add \$38 List per door.
- For standard size Ventilation cut-outs, add \$131. Contact Customer Service for size and location.
- For 1" x 1" Square Steel Tube Base, add \$281 List per credenza.
- 1" x 1" Square Steel Tube Base available in 76 solid Spectone colors.

### HOW TO ORDER

- Select Model
- Select Edge Style
- Select Credenza Finish
- Select Edge Finish
- Select Base
- Select Base Finish
- Select Corian Top Finish, if applicable

**Example:** CR243629-2D - PVF





# CREDENZAS - 29" HIGH

BACK TO CONTENTS

	MODEL <i>Code</i>	SIZE	TOP SPECIFICATIONS			OPTIONS <i>Corian Top</i> <b>GROUP A&amp;B</b>	LBS
			<i>For Laminate Top</i>		<i>For Veneer Top</i>		
			PVF PVB 2MM SE	HF HB HBV HBVR HB2 HKN	HF HB HBV HBVR HB2 HKN SE		
<b>CREDENZA</b>  Four doors. One adjustable shelf.    <small>Product shown with optional 1" x 1" Square Steel Tube Base.</small>	<b>CR246029-4D</b>	<b>24D x 60W x 29H</b>	3384	4212	4706	2402	170 <sup>1</sup>
	<b>CR247229-4D</b>	<b>24D x 72W x 29H</b>	3978	5204	5698	2883	200 <sup>1</sup>
<b>CREDENZA</b>  Two 6" drawers and four doors. One adjustable shelf.    <small>Product shown with optional 1" x 1" Square Steel Tube Base.</small>	<b>CR246029-2B4D</b>	<b>24D x 60W x 29H</b>	3766	4594	5088	2402	200 <sup>1</sup>
	<b>CR247229-2B4D</b>	<b>24D x 72W x 29H</b>	4360	5586	6080	2883	235 <sup>1</sup>

<sup>1</sup> For Corian Top add 33lbs for 2460, and 39lbs for 2472 credenza.  
 All product images are shown with an edge handle, and optional 1" x 1" Square Steel Tube Base.



2" Laminate or Veneer Kickplate Base  
 2" Brushed Aluminum Laminate Kickplate Base  
 1" x 1" Square Steel Tube Base



Straight Handle (Brushed Stainless Steel)  
 Arc Handle (Brushed Stainless Steel)  
 Edge Handle (Chrome)

### STANDARD FEATURES

- Laminate available in any standard Wilsonart, Nevamar, Formica, Arborite or Pionite matte finish offerings. For other laminate please contact the factory for pricing.
- Veneers and hardwood edges are standard in Oak, Maple, Cherry, Pecan, Walnut, Mahogany and Chocolate.
- 7 veneer and hardwood edge stains are standard. Stain-to-match available at no upcharge.
- Standard credenza height 29".
- Touch latch doors are standard.
- 2" Laminate or Veneer Kickplate Base is standard.
- Interior of laminate credenzas is finished in black melamine.

### OPTIONS

- Specify straight, arc or edge handles at no upcharge.
- For Locks, add \$38 List per door.
- For standard size Ventilation cut-outs, add \$131. Contact Customer Service for size and location.
- For 1" x 1" Square Steel Tube Base, add \$281 List per credenza.
- 1" x 1" Square Steel Tube Base available in 76 solid Spectone colors

### HOW TO ORDER

- Select Model
- Select Edge Style
- Select Credenza Finish
- Select Edge Finish
- Select Base
- Select Base Finish
- Select Corian Top Finish, if applicable





**Example:** CR246029-4D - PVF





# BUFFET HEIGHT CREDENZAS

BACK TO CONTENTS

	MODEL	SIZE	TOP SPECIFICATIONS			OPTIONS	LBS
	<i>Code</i>		<i>For Laminate Top</i>	<i>For Veneer Top</i>	<i>Corian Top</i>		
			PVF PVB 2MM SE	HF HB HBV HBVR HB2 HKN	HF HB HBV HBVR HB2 HKN SE	<b>GROUP A&amp;B</b>	
<b>BUFFET HEIGHT CREDENZA</b>    Two doors. One adjustable shelf.  Product shown with optional 1" x 1" Square Steel Tube Base.	<b>BUF243636-2D</b>	24D x 36W x 36H	2592	3059	3554	1441	130 <sup>1</sup>
<b>BUFFET HEIGHT CREDENZA</b>    Three doors. One adjustable shelf.  Product shown with optional 1" x 1" Square Steel Tube Base.	<b>BUF244836-3D</b>	24D x 48W x 36H	2792	3305	3801	1922	160 <sup>1</sup>
 <b>BUFFET HEIGHT CREDENZA</b>    Two center drawers and two doors. One adjustable shelf.  Product shown with optional 1" x 1" Square Steel Tube Base.	<b>BUF244836-2F2D</b>	24D x 48W x 36H	3174	3687	4183	1922	190 <sup>1</sup>

<sup>1</sup> For Corian Top add 27lbs for 2448, 33lbs for 2460, and 39lbs for 2472 credenza. All product images are shown with an edge handle, and optional 1" x 1" Square Steel Tube Base.



2" Laminate or Veneer Kickplate Base  
 2" Brushed Aluminum Laminate Kickplate Base  
 1" x 1" Square Steel Tube Base

Garbage Pull-out with two Bins

Straight Handle (Brushed Stainless Steel)

Arc Handle (Brushed Stainless Steel)

Edge Handle (Chrome)

### STANDARD FEATURES

- Laminite Buffet Height Credenzas are available in any standard Wilsonart, Nevamar, Formica, Arborite or Pionite matte finish offerings. For other laminate please contact the factory for pricing.
- Veneers and hardwood edges are available in 7 standard stains (Oak, Maple, Cherry, Pecan, Walnut, Mahogany and Chocolate) or stain-to-match at no upcharge.
- Standard Credenza height is 36".
- Straight handle is standard.
- 2" Laminate or Veneer Kickplate Base is standard.
- Interior of laminate credenzas is finished in black melamine.

### OPTIONS

- Specify touch latch doors, arc or edge handles at no upcharge.
- For Locks, add \$38 List per door.
- For Ventilation cut-outs, add \$131. Contact Customer Service for size and location.
- For 1" x 1" Square Steel Tube Base, add \$281 List per credenza.
- 1" x 1" Square Steel Tube Base available in 76 solid Spectone colors
- For Garbage Pull-Out, add \$1388 List each.
- Available at 20" deep.

### HOW TO ORDER

- Select Model
- Select Edge Style
- Select Credenza Finish
- Select Edge Finish
- Select Base Finish
- Select Corian Top Finish, if applicable



**Example:** BUF244836-2F2D





# BUFFET HEIGHT CREDENZAS

BACK TO CONTENTS

	MODEL	SIZE	TOP SPECIFICATIONS			OPTIONS	LBS
			Code		For Laminate Top		
			PVF PVB 2MM SE	HF HB HBV HBVR HB2 HKN	HF HB HBV HBVR HB2 HKN SE		
<b>BUFFET HEIGHT CREDENZA</b>    Four doors. One adjustable shelf.  <small>Product shown with optional 1" x 1" Square Steel Tube Base.</small>	<b>BUF246036-4D</b>	24D x 60W x 36H	3469	4297	4791	2402	195 <sup>1</sup>
	<b>BUF247236-4D</b>	24D x 72W x 36H	4063	5289	5783	2883	230 <sup>1</sup>
<b>BUFFET HEIGHT CREDENZA</b>    Two 6" drawers and four doors. One adjustable shelf.  <small>Product shown with optional 1" x 1" Square Steel Tube Base.</small>	<b>BUF246036-2B4D</b>	24D x 60W x 36H	3851	4679	5173	2402	225 <sup>1</sup>
	<b>BUF247236-2B4D</b>	24D x 72W x 36H	4445	5671	6165	2883	265 <sup>1</sup>

<sup>1</sup> For Corian Top add 27lbs for 2448, 33lbs for 2460, and 39lbs for 2472 credenza. All product images are shown with an edge handle, and optional 1" x 1" Square Steel Tube Base.



2" Laminate or Veneer Kickplate Base    2" Brushed Aluminum Laminate Kickplate Base    1" x 1" Square Steel Tube Base



Garbage Pull-out with two Bins

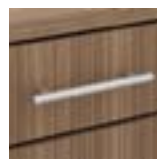

Straight Handle (Brushed Stainless Steel)

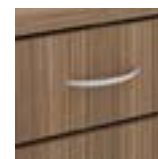

Arc Handle (Brushed Stainless Steel)

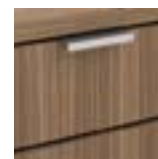

Edge Pull Handle (Chrome)

### STANDARD FEATURES

- Laminate Buffet Height Credenzas are available in any standard Wilsonart, Nevamar, Formica, Arborite or Pionite matte finish offerings. For other laminate please contact the factory for pricing.
- Veneers and hardwood edges are available in 7 standard stains (Oak, Maple, Cherry, Pecan, Walnut, Mahogany and Chocolate) or stain-to-match at no upcharge.
- Standard Credenza height is 36".
- Straight handle is standard.
- 2" Laminate or Veneer Kickplate Base is standard.
- Interior of laminate credenzas is finished in black melamine.

### OPTIONS

- Specify touch latch doors, arc or edge handles at no upcharge.
- For Locks, add \$38 List per door.
- For Ventilation cut-outs, add \$131. Contact Customer Service for size and location.
- For 1" x 1" Square Steel Tube Base, add \$281 List per credenza.
- 1" x 1" Square Steel Tube Base available in 76 solid Spectone colors
- For Garbage Pull-Out, add \$1388 List each.
- Available at 20" deep.

### HOW TO ORDER

- Select Model
- Select Edge Style
- Select Credenza Finish
- Select Edge Finish
- Select Base Finish
- Select Corian Top Finish, if applicable



**Example:** BUF246036-4D

MODEL ↓



# HOSPITALITY CARTS

BACK TO CONTENTS

	MODEL	SIZE	TOP SPECIFICATIONS		LBS
			For Laminate Top SE	For Veneer Top SE	
<b>HOSPITALITY CART</b> Two open fixed shelves. 	<b>HSP243036-2SH</b>	24D x 30W x 36H	2392	3354	95
	<b>HSP243636-2SH</b>	24D x 36W x 36H	2492	3454	108
	<b>HSP244236-2SH</b>	24D x 42W x 36H	2592	3601	122
<b>HOSPITALITY CART</b> Two doors. One adjustable shelf. 	<b>HSP243036-2D</b>	24D x 30W x 36H	2492	3454	112
	<b>HSP243636-2D</b>	24D x 36W x 36H	2592	3554	128
	<b>HSP244236-2D</b>	24D x 42W x 36H	2692	3701	145
<b>HOSPITALITY CART</b> Two 6" drawers and two doors. One adjustable shelf. 	<b>HSP243036-2B2D</b>	24D x 30W x 36H	2874	3836	133
	<b>HSP243636-2B2D</b>	24D x 36W x 36H	2974	3936	152
	<b>HSP244236-2B2D</b>	24D x 42W x 36H	3074	4083	171

All product images are shown with an edge handle.

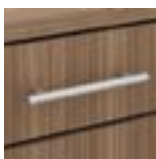

**Straight Handle**  
(Brushed Stainless Steel)

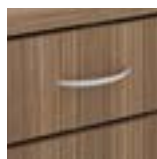

**Arc Handle**  
(Brushed Stainless Steel)

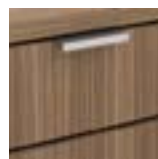

**Edge Handle**  
(Chrome)



**Locking Casters on Hospitality Carts**

### STANDARD FEATURES

- Laminate Hospitality Carts are available in any standard Wilsonart, Nevamar, Formica, Arborite or Pionite matte finish offerings. For other laminate please contact the factory for pricing.
- Veneers and hardwood edges are available in 7 standard stains (Oak, Maple, Cherry, Pecan, Walnut, Mahogany and Chocolate) or stain-to-match at no upcharge.
- Standard hospitality cart height is 36".
- Straight handle is standard on doors and drawers. Side handle (to push or pull hospitality cart) is standard as square profile in Chrome.
- Locking Casters.

### OPTIONS

- Specify touch latch doors, arc or edge handles at no upcharge.
- For Locks, add \$38 List per door.
- For Ventilation cut-outs, add \$131. Contact Customer Service for size and location.
- Available at 20" deep.
- 2MM available on all outside edges

### HOW TO ORDER

- Select Model
- Select Edge Style
- Select Cart Finish
- Select Edge Finish
- Select Corian Top Finish, if applicable

**Example:** HSP243636-2D





# LECTERNS

BACK TO CONTENTS

	MODEL	SIZE	TOP SPECIFICATIONS		LBS
	<i>Code</i>		<i>Laminate</i>	<i>Veneer</i>	
<b>CONDUCTOR LECTERN</b>  <p>One adjustable shelf and one keyboard tray.</p> <p>Specify metal finish for perforated metal.</p>	<b>CCLEC</b>	24D x 24W x 50.5H	2812	3599	110
<b>BOARDGAMES LECTERN</b>  <p>One adjustable shelf.</p> <p>Specify aluminum or wood trim details.</p>	<b>BGLEC</b>	24D x 24W x 50.5H	2695	3415	100



### STANDARD FEATURES

- Laminate available in any standard Wilsonart, Nevamar, Formica, Arborite or Pionite matte finish offerings. For other laminate please contact the factory for pricing.
- Veneers and hardwood edges are available in 7 standard stains (Oak, Maple, Cherry, Pecan, Walnut, Mahogany and Chocolate) or stain-to-match at no upcharge.
- Locking casters.
- Specify any spectone color for metal components.



QUICKSHIP



## 10 DAY QUICKSHIP PROGRAM



### 10 Day Guarantee

Upon Acceptance and acknowledgement, 10 Day Quickship orders will ship from our factory (165 City View Drive Toronto, On, Canada) within 10 Business Days (excluding any statutory holidays) or the order will be deemed free. The original bill of lading, with your shipment from the Spec factory at 165 City View Drive Toronto, On, Canada, shall determine the shipping date.

Spec will endeavor to expedite your shipment upon departure from the factory.

Spec reserves the right to cancel or change the 10 Day Quickship program at any time, and may refuse to acknowledge a 10 Day Quickship order at our discretion.

### Credit

All purchase orders are subject to credit approval. For our established dealers, terms are net 30 days from date of invoice. In some instances a deposit may be required to accompany an order. We will advise you if a deposit is required when we acknowledge your order.

### Damage and Claim

All products are carefully examined before packaging for shipment. Ownership of your product passes to you upon pick-up by the carrier at our factory. Upon receipt of your order, check for any physical damage to the product (even if the carton is unmarked) that may have occurred during transit. Note any physical damage on all copies of the bill of lading and enter a freight claim with the carrier immediately. If you discover damage while unpacking, arrange for a carrier inspection immediately. Any damage, visible or concealed, must be reported to the carrier within 15 days from delivery. Our customer service people would be pleased to help you in any way during the process.

### Cancellations, Returns and Changes

Orders are in process once acknowledged and may not be canceled without our consent. You may be responsible for work in process and administration costs including labor and raw materials. Merchandise may be returned only with our clear written authorization. Freight costs for return are your responsibility. Our product designs, processes, and materials are always under review ensuring the best quality and value to you. We will do our best to notify you as improvements occur.

### Ordering Procedures

Please submit all 10 Day Quickship orders in writing via fax or e-mail direct to factory. Orders sent by fax do not require confirmation. Please use model numbers and finish codes with a brief description of the product(s) being ordered. Your order will

be acknowledged in writing to you (usually by fax) once clarified. We request your assistance in checking our acknowledgement's accuracy to your order to ensure discrepancies do not occur. It is your responsibility to let us know of any discrepancies within 24 hours of receiving the acknowledgement.

### Quantity Limit

The 10 Day Shipping Program is available for a selection of Fitt, General Purpose tables and Snowball chairs to a maximum quantity of 20 pieces per order. If you need more than this quantity on your 10 day shipment, please contact Spec Customer service for approval. We will do our best to accommodate your needs. Spec reserves the right to limit product quantities for 10 Day shipments. The standard Spec shipping program applies to all 10 Day orders. Please refer to the online Shipping Program or contact Customer Service at 1.888.761.7732.

Spec reserves the right to cancel or change the 10 day program at any time and may refuse to acknowledge a 10 day order at our discretion.



# Snowball 1

## 10 Day Program

BACK TO CONTENTS

### Standard Features

- Black polyurethane arms
- Nickel or black textured frame finish
- A selection of fabrics and vinyls can be seen on our website under 10 Day Quickship

### Options

- Connecting clips for ganging chairs, add \$8 List/set
- Snowball Dolly, stacks regular width four-point Snowballs up to 10 high, Midsize and Bariatric Snowballs up to 4 high

For information on the 10 Day Program guarantee and terms and conditions, visit our website and go to 10 Day Quickship, Terms & Conditions tab.

### Snowball 1 – 10 Day Program

COM 1.0 yd  
0.5 yd COM per single seat  
0.5 yd COM per single back

MODEL	COM	GR 1	GR 2	GR 3	GR 4	GR 5	GR 6
1801	311	357	372	406	452	488	533
1811	311	357	372	406	452	488	533
1831	325	371	387	418	465	501	549
1841	325	371	387	418	465	501	549

COM 1.5 yd  
0.75 yd COM per single seat  
0.75 yd COM per single back

MODEL	COM	GR 1	GR 2	GR 3	GR 4	GR 5	GR 6
1804	425	519	551	612	706	777	871

COM 2.0 yd  
1.0 yd COM per single seat  
1.0 yd COM per single back

MODEL	COM	GR 1	GR 2	GR 3	GR 4	GR 5	GR 6
1803	499	592	623	684	779	850	944

Dolly

MODEL	COM
1899	343
1899M	491
1899G	491



1899  
Standard  
18 lbs

1899 G&M  
Midsize & Bariatric  
24 lbs



1801  
With arms  
16 lbs



1811  
Without arms  
15 lbs



1831  
With arms  
18 lbs



1841  
Without arms  
17 lbs



1804  
With arms  
18 lbs



1803  
With arms  
23 lbs



# Snowball 2

## 10 Day Program

BACK TO CONTENTS

### Standard Features

- Black polyurethane arms
- Back with enhanced contours for superior comfort
- Nickel or black textured frame finish
- A selection of fabrics and vinyls can be seen on our website under 10 Day Quickship

### Options

- Connecting clips for ganging chairs, add \$8 List/set
- Snowball Dolly, stacks regular width four-point Snowballs up to 10 high, Midsize and Bariatric Snowballs up to 4 high

For information on the 10 Day Program guarantee and terms and conditions, visit our website and go to 10 Day Quickship, Terms & Conditions tab.

### Snowball 2 – 10 Day Program

COM 1.0 yd  
0.5 yd COM per single seat  
0.5 yd COM per single back

MODEL	COM	GR 1	GR 2	GR 3	GR 4	GR 5	GR 6
1851	330	384	401	435	488	527	579
1861	330	384	401	435	488	527	579
1881	346	397	414	449	501	540	592
1891	346	397	414	449	501	540	592

COM 1.5 yd  
0.75 yd COM per single seat  
0.75 yd COM per single back

MODEL	COM	GR 1	GR 2	GR 3	GR 4	GR 5	GR 6
1854	456	553	584	647	745	819	915

COM 2.0 yd  
1.0 yd COM per single seat  
1.0 yd COM per single back

MODEL	COM	GR 1	GR 2	GR 3	GR 4	GR 5	GR 6
1853	529	625	659	721	819	890	988

Dolly

MODEL	COM
1899	343
1899M	491
1899G	491



**1899**  
Standard  
18 lbs

**1899 G&M**  
Midsize & Bariatric  
24 lbs



**1851**  
With arms  
16 lbs



**1861**  
Without arms  
15 lbs



**1881**  
With arms  
18 lbs



**1891**  
Without arms  
17 lbs



**1854**  
With arms  
18 lbs



**1853**  
With arms  
23 lbs



# Snowball 3

10 Day Program

BACK TO CONTENTS

## Standard Features

- Black polyurethane arms
- Upholstered seat and wood back
- Back in Cherry stain or Natural Maple stain
- Back cut-out A
- Nickel or black textured frame finish
- A selection of fabrics and vinyls can be seen on our website under 10 Day Quickship

## Options

- Connecting clips for ganging chairs, add \$8 List/set
- Snowball Dolly, stacks regular width four-point Snowballs up to 10 high, Midsize and Bariatric Snowballs up to 4 high

For information on the 10 Day Program guarantee and terms and conditions, visit our website and go to 10 Day Quickship, Terms & Conditions tab.

## Snowball 3 – 10 Day Program

COM 0.5 yd  
0.5 yd COM per single seat

MODEL	COM	GR 1	GR 2	GR 3	GR 4	GR 5	GR 6
1901	402	427	436	454	479	500	525
1911	402	427	436	454	479	500	525
1931	415	441	450	467	493	513	539
1941	415	441	450	467	493	513	539

COM 0.75 yd  
0.75 yd COM per single seat

MODEL	COM	GR 1	GR 2	GR 3	GR 4	GR 5	GR 6
1904	503	545	559	585	627	660	701

COM 1.0 yd  
1.0 yd COM per single seat

MODEL	COM	GR 1	GR 2	GR 3	GR 4	GR 5	GR 6
1903	544	585	601	626	668	700	742

Dolly

MODEL	COM
1899	343
1899M	491
1899G	491



1899  
Standard  
18 lbs

1899 G&M  
Midsize & Bariatric  
24 lbs



1901  
With arms  
16 lbs



1911  
Without arms  
15 lbs



1931  
With arms  
18 lbs



1941  
Without arms  
17 lbs



1904  
With arms  
18 lbs



1903  
With arms  
23 lbs



# FITT 10 DAY TABLES PROGRAM

BACK TO CONTENTS

MODEL	BASES		TOP SPECIFICATIONS		OPTIONS				LBS
	Code	Qty.	For Laminate Top PVC		FLIP TOP (FL)	FOLD (F)	CASTERS (LC)	WHEELS (WB)	
<i>Round</i>									
30D	FX4	1	551		-	-	84	-	38
36D	FX4	1	628		-	-	84	-	46
42D	FX4	1	678		-	-	84	-	56
48D	FX4	1	819		-	-	84	-	85
54D	FX4	1	882		-	-	84	-	98
60D	FX4	1	950		-	-	84	-	113
<i>Square</i>									
30 x 30SQ	FX4	1	582		-	-	84	-	38
36 x 36SQ	FX4	1	634		-	-	84	-	46
42 x 42SQ	FX4	1	770		-	-	84	-	73
48 x 48SQ	FX4	1	824		-	-	84	-	85
54 x 54SQ	FX4	1	888		-	-	84	-	98
60 x 60SQ	FX4	1	957		-	-	84	-	113



42D-FX4

### 10 DAY EDGE AND FRAME CHOICES

- Nickel or black flat PVC edge
- Nickel or black textured base finishes

### 10 DAY TOP FINISH CHOICES

For images of all current 10 Day laminates, visit [www.specfurniture.com](http://www.specfurniture.com) and go to Fabrics/Finishes.

### 10 DAY NOTES AND OPTIONS

- Quantity limits may apply. 10 Folding, 20 in total.

### STANDARD FEATURES

- Fitt is a lightweight multiuse table designed for light use contract applications.
- Tops are constructed from 0.75" particle board core with laminate surface and backer.
- Standard table height is 29".
- All bases are standard with floor leveling glides.
- Base span increases with size of top.
- Casters are not self-leveling.

### OPTIONS

- 2" grommet and oval grommet.

### HOW TO ORDER

1. Select Model
2. Select Base
3. Select Edge Style
4. Select Options
5. Select Top Finish
6. Select Edge Finish
7. Select Base Finish

Example: 30D - FX4 - PVC -



Toll Free: 1-888-761-7732



# GENERAL PURPOSE TABLES 10 DAY TABLES PROGRAM



BACK TO CONTENTS

**BASE**      **FIXED**

**T BASE  
T**



**BASE**      **FIXED**

**2.5" POST LEG  
PL**



**T BASE  
WITH CASTERS**



**POST LEG  
WITH CASTERS**



### EDGE AND FRAME CHOICES

- Nickel or black PVC edges in Flat or Bullnose.
- Nickel or black textured base finishes.

### TOP FINISH CHOICES

For images of all current 10 Day laminates, visit [www.specfurniture.com](http://www.specfurniture.com) and go to Fabrics/Finishes.

### 10 DAY NOTES AND OPTIONS

- Quantity limit of 20 tables.
- Casters available on T or P bases.
- Seam connectors for joining and leveling tops.
- 2" round or oval grommets.

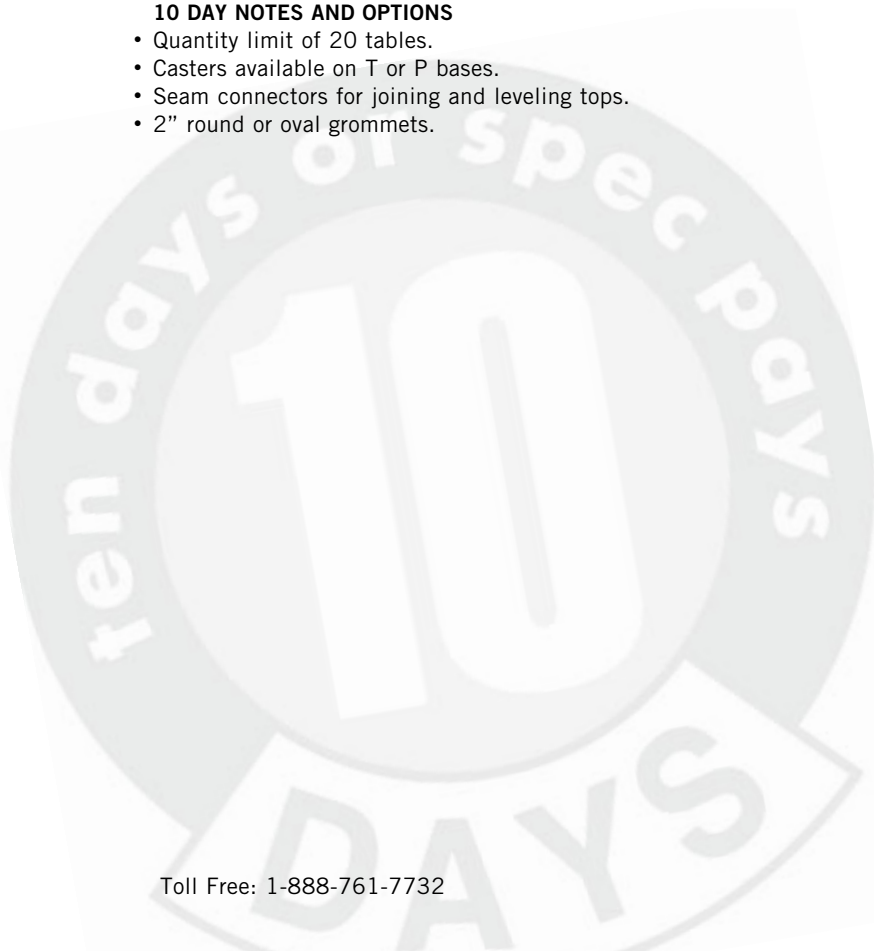



# GENERAL PURPOSE TABLES

 Rectangle

BACK TO CONTENTS

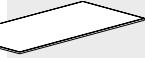
SHAPE	MODEL <i>Size/Shape</i>	BASE OPTIONS		LAMINATE TOP <i>Flat PVC Edge or Bullnose PVC Edge</i>	CASTERS <i>Upcharge</i>	LBS
		<i>Code</i>	<i># of</i>			
	24X36 RE	T	2	693	84	54
		PL	4	711	84	50
	24X48 RE	T	2	754	84	62
		PL	4	772	84	58
	24X60 RE	T	2	809	84	70
		PL	4	827	84	66
	24X72 RE	T	2	945	84	79
		PL	5	1071	105	81
	30X36 RE	T	2	781	84	60
		PL	4	799	84	56
	30X48 RE	T	2	800	84	70
		PL	4	818	84	66
	30X60 RE	T	2	855	84	81
		PL	4	873	84	77
	30X72 RE	T	2	1070	84	91
		PL	5	1196	105	93
	30X96 RE	T	2	1299	84	112
		PL	6	1425	105	114
	36X48 RE	T	2	917	84	79
		PL	4	935	84	71
	36X60 RE	T	2	1007	84	91
		PL	4	1025	84	71
	36X72 RE	T	2	1125	84	104
		PL	5	1251	105	106
	36X84 RE	T	2	1438	84	117
		PL	5	1564	105	119
	36X96 RE	T	2	1443	84	129
		PL	6	1677	126	137

**NOTES AND OPTIONS**

- Tops are constructed from 1" particle board core with laminate surface and backer.
- Seam connectors: add \$80 List per table.
- Standard 29" table height.
- 2" grommet add \$28 List. Oval grommet add \$35 List.

*Spectone frame finish options are presented on our finish card.*

Toll Free: 1-888-761-7732

**REVISIONS**

<b>DATE</b>	<b>PAGE</b>	<b>DETAILS</b>	<b>DESCRIPTION</b>
Oct 15, 2015	Page 130	PRICE CORRECTION	48 diameter table price corrected to \$2426
Oct 28, 2015	Page 236	PRICE CORRECTION	MidSize Stool in Grade 2 fabric corrected to \$628
Dec 22, 2015	Page 13-19	FINISH CHANGE	Chair arms are made from Beech instead of Maple
Dec 22, 2015	Page 231	PRICE CORRECTION	GR6 Upholstered Back Stools prices corrected to \$622
Feb 5, 2016	Page 138	PRICE CORRECTION	GR6 price corrected to \$649 for 1715-US
Feb 11, 2016	Page 316-317	FINISH CHANGE	Removed edge options
Feb 11, 2016	Page 386	FINISH CHANGE	Removed edge options
Mar 31, 2016	Page 246	FINISH CHANGE	Discontinued Arms Caps
May 11, 2016	Pages 277-293	DESIGN CHANGE	Aluminum Extrusion design updated
June 02, 2016	Page 434-435	PRICE CHANGE	Adjusted Blank Plate price to no upcharge
June 02, 2016	Page 472	PRICE CHANGE	Adjusted Phantom Price
June 02, 2016	Page 474	PRICE CHANGE	Adjusted Blank Plate price to no upcharge
June 30, 2016	Page 501	DISCONTINUED PRODUCT	Multimedia & CPU Carts have been discontinued
Dec 9, 2016	Page 459	OPTION CORRECTION	Removed flip option for X bases
Dec 12, 2016	Page 487	OPTION CORRECTION	Removed Post Leg Option with Aluminum Extrusions