



**UNCLE MIKE'S**  
**LAW ENFORCEMENT®**

**2006 CATALOG**







# UNCLE MIKE'S LAW ENFORCEMENT<sup>®</sup>

Designed through experience, focused  
on performance <sup>SM</sup>

## TABLE OF CONTENTS

<b>Uncle Mike's Law Enforcement</b>	<b>4-29</b>
Duty Holsters	4-5
TASER Holsters	6
PRO-3 Tactical Holsters	7
Dual Retention Tactical Holsters	7
Tactical Holsters and Accessories	7-9
Injection-molded Kydex	10-11
Off Duty/Concealed Carry Holsters	12-15
Belt Pouch Holsters	14
Super Belt Slide Holsters	15
Hip Holsters	16
Pro-Pak Holsters and Accessories	17
Duty Belts and Suspenders	18-19
Uniform & Concealment Accessories	20-23
Radio and Pager Cases	24-25
Slings and Swivels	26-27
Ammo Holders	26-27
Bags and Gun Cases	28-29
Duty Belt Systems	48
<b>Armor Skins Gloves</b>	<b>30-31</b>
<b>Hoppe's</b>	<b>32-39</b>
Hoppe's Elite	32-33
Solvents and Lubricants	34-35
BoreSnake	36
Cleaning Kits	36-37
Cleaning Rods, Brushes, and Swabs	38
Cleaning Patches	39
Shooting Accessories and Targets	39
<b>Butler Creek</b>	<b>40-41</b>
Shotgun Stocks	40
LULA Loaders and Benchloaders	40
Slip-On Grips and Scope Covers	41
Quick Carry Slings	41
<b>Stoney Point</b>	<b>42-43</b>
Monopods and Bipods	42-43
Shooting Accessories and Bags	43
Handcuff Case Fit Chart	44
Light Case Fit Chart	44
Butler Creek Scope Cover Chart	45
Holster Selection Guide	46-47

©2006 B.O.P. All rights reserved. Product specifications, styles and packaging are subject to change without notice. No. 9, Weatherguard, Baby Bet, Gun Pak, Key-Per, Mountain Sling, MIRAGE, Side Bet, Tri-Lock, HiddenHammer, SlimLine, and Strap Trap are trademarks of B.O.P. BoreSnake, Butler Creek, Elite, GunRunner, Hoppe's, Bench Rest 9, Pro-Pak, Quick Loader, Uncle Mike's, Uncle Mike's Law Enforcement, Sidekick, SwivelLock, Super Swivel, Ultra, QD, and "World's Fastest Gun Bore Cleaner" are Registered Trademarks owned or licensed by B.O.P. Designed Through Experience, Focused On Performance is a Service Mark of B.O.P. Uncle Mike's Law Enforcement® holsters are protected by U.S. Patents 5,282,559 and 5,419,474. BoreSnake is protected by US Patents 5,871,589 and 5,972,125; Australian Patent 723,977 and Canadian Patent 2,264,899. The PRO-3 Duty Belt Buckle is protected by U.S. Patent 5,774,956. The LoPro Swivel is protected by U.S. Patent 6,536,154. All other trademarks used in this catalog are property of their respective owners.

# Safety first! Your firearm stays holstered with the patented PRO-3 locking system

## PRO-3® Duty Holsters

Our triple retention feature makes Uncle Mike's® PRO-3 Duty Holster the best on the market today. With it, your firearm stays exactly where it's supposed to stay until you draw it. Our PRO-3 is:

- **Hard to Grab** — Our patented locking system positively locks the firearm from the front, rear, top and side.
- **Easy to Draw** — No complicated buttons or straps, drawing is as easy as releasing the thumb break.
- **Easy to Carry** — Ergonomically designed to work with your body so the strains of carrying a holster are kept to a minimum. And for even less bulk, our SlimLine™ PRO-3 model offers the same triple retention in a smaller profile than our standard PRO-3 duty holster.



### Deconstructing our patented PRO-3 Triple Retention

- 1 Patented internal locking device\*
- 2 Molded thumb break
- 3 Adjustable tensioning device
- 4 Patented laminated construction— either MIRAGE® or Cordura® nylon exterior, foam core and smooth nylon lining
- 5 Positive triggerguard stop positions gun the same way every time
- 6 Holster suspended within patented Kydex® exoskeleton for support, strength and rigidity
- 7 Non-stretch retention strap works with molded thumb break to stay open for easy, one-handed reholstering. Contoured thumb break discourages blading
- 8 Patented, molded sight track protects front sight and reduces holster wear
- 9 Injection-molded belt loop accepts Spacer Pack, keeping the holster parallel to the body while compensating for body contours (See Spacer Pack on Page 5)

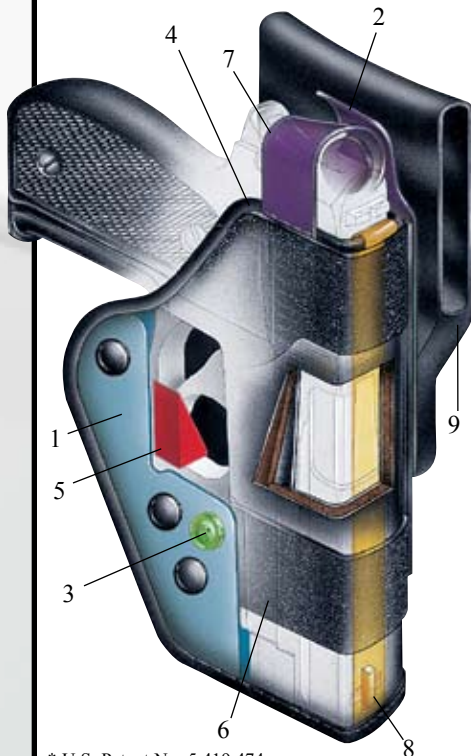

**FYI** A 10-minute video explaining the features, functions and operations of the PRO-3 Triple Retention Holster is available. Contact us for availability.



Original PRO-3® Holster

SlimLine PRO-3® Holster

### PRO-3® Duty Holsters SlimLine™

SIZE	SlimLine™			Original			MIRAGE FIT INFORMATION
	CORDURA	MIRAGE Plain	MIRAGE Basketweave	CORDURA Plain	MIRAGE Basketweave		
18				9518-1	6518-1	6518-4	Smith & Wesson 9mm, .40, Sub-Compact .45 (3½"-4" barrels), Beretta Centurion
L				9518-2	6518-2	6518-5	
20	R	3520-1	3520-3	3520-5	9520-1	6520-1	Beretta 9mm, .40, Smith & Wesson 10mm, .45 (5" barrels except w/hook-type or extended trigger guards)
	L	3520-2	3520-4	3520-6	9520-2	6520-2	
21	R	3521-1	3521-3	3521-5	9521-1	6521-1	Glock 17, 19, 22, 23, 31
	L	3521-2	3521-4	3521-6	9521-2	6521-2	
22	R	3522-1	3522-3	3522-5	9522-1	6522-1	SIGARMS 9mm, .38S, .40, .45
	L	3522-2	3522-4	3522-6	9522-2	6522-2	
23	R				9523-1	6523-1	Ruger P85, P89, P90, P91, P93, P94, P95, KP90, KP93, KP94
	L				9523-2	6523-2	
25	R				9525-1	6525-1	Glock 20, 21, 29, 30, 36
	L				9525-2	6525-2	
28	R				9528-1		Smith & Wesson SIGMA 9mm, .40
	L				9528-2		
29	R				9529-1		Smith & Wesson SW99
	L				9529-2		
30	R				9530-1	6530-1	HK USP 9mm, .40, .45, USP Compact,

\* U.S. Patent No. 5,419,474

# Dual Retention holsters for security and ease of use

## PRO-2® Dual Retention Holsters

Our PRO-2 Dual Retention holsters are for departments who need more than a conventional thumb break device, but not as much retention as our PRO-3. The PRO-2 uses both a non-stretch retention strap and traditional outboard tensioning device, as well as an internal detent to engage its trigger-guard. But even with these effective dual retention devices, a simple upward drawstroke is all that is required to produce the handgun.

Constructed from a tough foam laminate, the PRO-2 features an injection-molded welt, a riveted body and the same jacket slot belt loop as our famous PRO-3 model.

PRO-2® Dual Retention Holster in MIRAGE Basketweave finish



PRO-2® Dual Retention Holsters – Jacket Slot				
SIZE	CORDURA	MIRAGE Plain	MIRAGE Basketweave	FIT INFORMATION
Right/Left				
18 R	4318-1	4318-3	4318-5	Smith & Wesson 9mm, .40, Sub-compact .45, 3½" - 4" barrels, Beretta Centurion
L	4318-2	4318-4	4318-6	
20 R	4320-1	4320-3	4320-5	Beretta 92, 96 all variations
L	4320-2	4320-4	4320-6	
21 R	4321-1	4321-3	4321-5	Glock 17, 19, 22, 23, 31, 32, 36
L	4321-2	4321-4	4321-6	
22 R	4322-1	4322-3	4322-5	SIGARMS P220, P226, P228, P229, P245, 229 DAK
L	4322-2	4322-4	4322-6	
25 R	4325-1	4325-3	4325-5	Glock 20, 21, 29, 30, 36

## Standard Dual Retention Holsters

These Dual Retention Holsters are designed to fit a wide variety of law enforcement pistols and revolvers and a broad range of law enforcement and security situations.

Retention is provided by the non-stretch retention strap, plus an independent adjustable tensioning device that applies varying amounts of pressure to the surface of the firearm.

Standard Dual Retention Holster—Auto



Standard Dual Retention Holster—Revolver



## Standard Dual Retention Holsters – Jacket Slot

SIZE	CORDURA	MIRAGE Plain	MIRAGE Basketweave	FIT INFORMATION
Right/Left				
2 R	9852-1	6752-1	6752-4	Certain 4" barrel med. & intermediate double action revolvers such as Colt, Ruger, S&W, Taurus, Dan Wesson
L	9852-2	6752-2	6752-5	
18 R	9818-1	—	6718-4	Smith & Wesson 9mm, .40, Sub-Compact .45 (3½"-4" barrels)
L	9818-2	—	6718-5	
19 R	9819-1	—	—	Colt Gov't 9mm, .38S, .40, 10mm, .45
L	9819-2	—	—	
20 R	9820-1	—	—	Beretta 9mm, .40, Smith & Wesson 10mm, .45 (5" barrels), Taurus 9mm, .40
L	9820-2	—	—	
21 R	9821-1	—	—	Glock 17, 19, 22, 23, 31, 36
L	9821-2	—	—	
22 R	9822-1	—	—	SIGARMS 9mm, .38S, .40, .45, 229 DAK
L	9822-2	—	—	
23 R	9823-1	—	—	Ruger P85, P89, P90, P91, P93, P94, P95, KP90, KP93, KP94
L	9823-2	—	—	
25 R	9825-1	—	6725-4	Glock 20, 21, 29, 30

## Jacket Slot Duty Holster Spacer Pack



- Use with PRO-3, PRO-2 and Dual Retention Jacket Slot Holsters.
- Spacers compensate for body contours that keep Jacket Slot holster from riding parallel to centerline of body.
- Especially useful for women officers whose narrow waists can cause gun muzzles to angle outward, away from the body, putting the grip into their ribs or under body armor.
- Includes ¼" and ⅛" thick spacers.



Without Spacer Pack      With Spacer Pack      # 9890-0

## Removable Rotating Belt Loop

- Seated officers can rotate holster from the locked vertical position, allowing muzzle to clear obstructing surfaces.
- Mobile officers entering "no gun" areas can rotate and detach locked holster and firearm without handling the firearm.
- Off-duty officers can safely remove the still holstered firearm from belt, and lock both pieces up as an assembly.

# 9890-1



Rotating Belt Loop allows holster to go from locked position to removal with the push of a button. Holster can also be rotated for optimum comfort while seated.

## NEW High Ride Belt Loop Accessory

If high ride is your preferred carry method, this belt loop accessory allows you to convert an Uncle Mike's PRO-3, PRO-2 or Dual Retention holster into a high ride holster.

- Conversion tools included.
- Works with Mirage Plain, Basketweave or Cordura finishes.

MIRAGE Plain      #6699-0  
Cordura            #9699-0

## Jacket Slot Duty Holsters

For 4" and 5" barreled pistols employing Insight Technology, M3 and M5 Light Modules.



SIZE	M3 or M5	FIT INFORMATION
Right/Left		
5 R	9905-7	4½ - 5" lg. auto
L	9905-8	4½ - 5" lg. auto
15 R	9915-7	3¾ - 4¼" lg. auto

## FYL Jacket Slot Belt Loop

Provides a defined offset to position the holster outside an Ike or Tuffy jacket. The cant angle is fixed for PRO-3 holsters, but adjustable for vertical, muzzle forward or butt forward cant on Dual Retention Holsters and PRO-2 holsters.



# Carry the X26 TASER comfortably in our Jacket Slot Holster and Thigh Rig

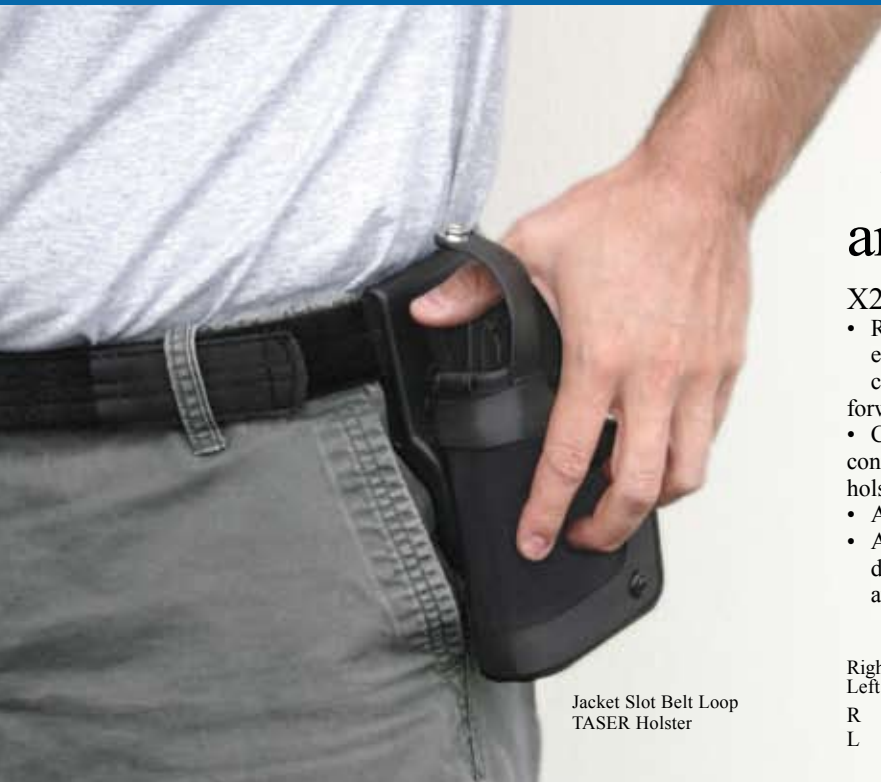

Jacket Slot Belt Loop  
TASER Holster

## X26 TASER Holster

- Rotating belt loop allows holster and device to be carried either in a conventional “strong side” location, or as a cross draw, with the weapon carried and employed butt-forward, vertically, horizontally or at any point in-between.
- Can be used with a drop-style leg mount, allowing the connector to be snapped on the belt and left there with the holster being snapped into it only when needed.
- Available in right-and-left hand versions.
- Accommodates department policies where a less than lethal device is carried on the non-dominant side of the body and away from the firearm.

	Tactical	Jacket Slot with Belt Loop		
Right/ Left	Cordura	Cordura	MIRAGE Plain	MIRAGE Basketweave
R	9951-1	9851-1	6751-1	6751-3
L	9951-2	9851-2	6751-2	6751-4

## **NEW** TASER Holster with MOLLE attachment

Attach your TASER holster to any MOLLE-compatible vest system or drop leg platform. TASER holster with Cordura finish can be mounted vertically or angled.

Right Hand #6851-1  
Left Hand #6851-2



TASER Holster can be mounted in vertical or angled positions.

## TASER Cartridge Pouch

- Single compartment cartridge pouch designed to carry a spare projectile cartridge.

Cordura #8827-1  
MIRAGE Plain #7427-1



## It's all about options when it comes to Uncle Mike's duty gear

Our Mirage® Nylon looks and feels like leather, but outperforms it in 6 ways!

1. **Appearance**—A Mirage duty rig starts out looking like leather and continues to look sharp despite wear, dirt, moisture and rough usage.
2. **Weight**—Your lower back will thank you because Mirage products are constructed of Nytek nylon, making them significantly lighter than leather or other synthetic rigs.
3. **Durability**—Mirage is incredibly strong and abrasion-resistant, developed from microfibers that are 1,000 times finer than silk. It needs virtually no maintenance.
4. **Comfort**—More pliable than leather, Mirage flexes to your body's contours for better fit and feel.
5. **Cleaning**—A damp cloth is all it takes. And spilled blood won't seep into the pores of the Mirage material, so there's no threat of pathogens remaining behind. It's easy to decontaminate with bleach water.
6. **Odor**—Mirage doesn't absorb body odor, perfume or other odors. Nor will it rot, mildew or wear away your gun's bluing.

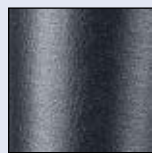

Mirage Plain

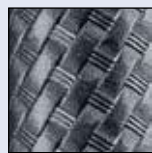

Mirage Basketweave

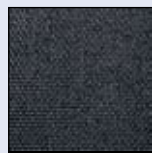

Cordura

Our pioneering use of multi-layer laminates and Cordura® nylon assures benefits you just can't get from nylon alone!

1. **Appearance**—The bonded foam creates clean lines and long-lasting good looks, while the Cordura® exterior provides a professional, non-reflective surface.
2. **Performance**—Your duty items are properly supported and immediately removable—even under stress—thanks to the use of hardened inserts.
3. **Durability**—All materials used in our line resist abrasion and wear and protect your sidearm, radio, cuffs and chemical canisters from harm.
4. **Weight**—Your rig weighs less, so it's less tiring for you to wear. Your back and hips will welcome the change.
5. **Comfort**—Soft flaps, flexible bound edges and backwalls won't poke or cut into you. You'll be more comfortable at work and less fatigued at the end of your shift when you wear Uncle Mike's gear.
6. **Cleaning**—A damp cloth will work for most stains, while a soft nylon brush and water lifts out stubborn stains.

# PRO-3 in service worldwide

## PRO-3® and Dual Retention Tactical Holsters

Adverse conditions require a tactical holster you can rely on in every situation. Uncle Mike's Law Enforcement lets you choose between our triple retention PRO-3 and our steadfast Dual Retention holsters. Whichever holster you choose, we mount it onto our new double strap tactical platform—creating an effective rig that carries well and is extraordinarily stable.

**The Holsters:** The PRO-3 has an independent internal locking device that provides positive retention under all conditions. The injection-molded Thumb Break and Retention Strap will not stretch over time. Our PRO-3 is popular with police high-risk units and is also used by Force Protection and specialized military units. Our Dual Retention offers two retention devices and fits most standard duty needs.

**The Platform:** Our tactical platform has two leg straps, which increases stability and rigidity. The platform is injection-molded for solidity. Leg straps stay put, due to a rubberized inlay woven throughout. Straps buckle into place and are MOLLE-system compatible.



Double Strap Tactical Leg Platform



### Double Strap Tactical Platform

Our ultra-stable tactical holster platform is available separately, allowing you to convert your current holster into a tactical holster. Platform is injection-molded, MOLLE-compatible and has rubber-inlaid webbing on the leg straps.

#5700-0

SIZE	Right/Left	DUAL	PRO-3	FIT INFORMATION
18	R	9918-1	6918-1	Smith & Wesson 9mm, .40, Sub-Compact .45 (3 1/2"-4" barrels)
	L	9918-2	6918-2	
19	R	9919-1	—	Colt Gov't 9mm, .38S, .40, 10mm, .45
	L	9919-2	—	
20	R	9920-1	6920-1	Beretta 9mm, .40, Smith & Wesson 10mm, .45 (5" barrels); Taurus 9mm, .40
	L	9920-2	6920-2	
21	R	9921-1	6921-1	Glock 17, 19, 22, 23,
	L	9921-2	6921-2	
22	R	9922-1	6922-1	Sig Sauer 9mm, .38S, .40, .45
	L	9922-2	6922-2	
23	R	9923-1	—	Ruger P85, P89, P90, P91, P93, P94, P95, KP90, KP93, KP94
	L	9923-2	—	
25	R	9925-1	6925-1	Glock 20, 21, 29, 30
	L	9925-2	6925-2	
30	R	9930-1	6930-1	HK USP 9mm, .40, .45, USP Compact (PRO-3 also fits Walther P99)
	L	9930-2	6930-2	



See our new Kydex Retention Tactical Holsters on Page 11, and our Tactical Holsters for Firearms with Underbarrel Lights on Page 8.

Please see our holster fit chart on Page 46 - 47.

## Tactical Holsters for Firearms with Underbarrel Lights

- Dual Retention Tactical Holsters to fit guns with SureFire® L-30 or L-60 type lights, or Insight Technology M3 and M5 type clip-on light modules.
- Sizes for both 4" and 5" barrel pistols.

SIZE	ITEM NO	FIT INFORMATION
Right/Left	L30 or L60	
5 R	9905-1	4 1/2 - 5" lg. auto with SureFire Type Lights
L	9905-2	
15 R	9915-1	3 3/4 - 4 1/2" lg. auto with SureFire Type Lights
L	9915-2	
Right/Left	M3 or M5 Modules	
5 R	9905-5	4 1/2 - 5" lg. auto with Insight
L	9905-6	
Technology Lights		
15 R	9915-5	3 3/4 - 4 1/2" lg. auto with Insight Technology Lights
L	9915-6	



## Everything to outfit your AR15/M16 tactical firearms

### 3-Point Tactical Sling

- Designed primarily for use with AR-15-type patrol rifles but this 1 1/4" nylon web sling will also clip onto M16's, M4 Carbines, HK MP5's and a number of police and combat shotguns.
- Length is adjustable; sling converts easily from a carrying to a shooting sling.

#2699-2



3-Point Tactical Sling attaches quickly to the rifle buttstock and fore end

### Mil-Spec Swivel Set QD SS MIM

- Developed at the request of the U.S. Military, these 1 1/4" Mil-Spec Parkerized swivels were designed to meet their strength and surface treatment standards.

Set No. 1402-3



### AR15/M16 20-Round Magazine Case

- Compact Double Mag Case doubles as a 20 Round .223 Mag Case.
- Low profile is perfect for patrol division applications.
- Only 3 inches wide; takes up little room on the belt.

Cordura #8895-1



### QD 115 AR15 Swivels

Two Super Swivels plus special fore-end adapter replace factory loops on Colt AR-15.

Set No. 1090-2



### Dual 30-Round Buttstock Mag Carrier

- Designed at the request of several major tactical units.
- Pouches are set "low" so they will not interfere with the shooter's "cheek weld".
- Magazines are easily removed even with the firearm in the mounted position.

Cordura #8848-7





# Sling converts quickly from carry to shooting mode

## Tactical Shotgun Sling with Sewn-On Swivels

- 1¼" nylon web tactical sling includes Uncle Mike's® 1¼" QD® swivels.
- Flip-open snap converts sling from carry mode to shooting mode.
- 48" length easily adjusts with snap open or closed.

#2699-3



A complete line of Law Enforcement slings can be found on page 26



Unsnap to lengthen sling, swing forward



Raise to shooting position



Sling tightens over bicep, anchoring gun



Also use as hasty sling

## Our Tactical Accessories give you many carry options

### Double Strap Tactical Platform

Our ultra-stable tactical holster platform is available separately, allowing you to convert your current holster into a tactical holster. Platform is injection-molded, MOLLE-compatible and has rubber inlaid webbing on the leg straps.

#5700-0

### Off-Side, Load-Bearing Accessory Harness

- Free-standing model designed to be worn on the leg opposite the one carrying the firearm.
- Puts accessories directly under the officer's hand.

#9958-1



Harness and Leg Platform only—Accessories not included

### Leg Mounted, Load-Bearing Accessory Harness

- Fits PRO-3®, Kydex and Dual Retention Tactical Holsters.
- Carry accessories down on the leg—where they're comfortable, out-of-the-way and still within reach.

#9958-0



### Magazine Case

- Fits all magazine sizes.
- Gives better access because it positions magazine case on leg harness rather than on holster.

#9957-1



### Light Carrier Cases

- Carries clip-on tactical lights for pistols.

Cordura #8853-1  
Mirage Plain #7453-1  
Mirage Basketweave #7453-2



# Uncle Mike's makes Kydex affordable!

If you've always wanted the performance and durability of true Kydex®, but thought you couldn't afford it, think Uncle Mike's®. Instead of using the standard process of taking sheets of Kydex and hand-molding them around a form, we injection-mold our Kydex to create custom-fit holsters with precision measurements at a price that's more affordable than most other holsters!

## Kydex Paddle Holster

Customer demand drove us to introduce this holster. It's been a winner because it can do so much. We designed our paddle holster for carry—it's comfortable against the hip and the venting aids air circulation to minimize perspiration. Plus it's adjustable for rake and height, so you can tailor the holster position to better match your torso height and body type.

- Drawing is easier because the body's lead edge is cut down.
- An excellent choice for both men and women.



Kydex Paddle Holster



## Kydex Belt Holster

Designed to ride close to the body at a mid-level height, this holster is an excellent choice for IDPA.

- Nearly vertical rake allows for conventional behind-the-hip carry. Can be used as an appendix carry.
- Cut-down lead edge aids in presentation of firearm.
- Fits belts up to 1 3/4".



Kydex Thumb Break Belt Holster



Kydex Thumb Break Paddle Holster

## Kydex Thumb Break Holster

With both an adjustable thumb break and tension screws, these holsters meet the requirements of agencies or municipalities where a thumb break is required.

- Available in Paddle or Belt Loop formats.

Kydex Concealment Holsters					
SIZE	ITEM NO.		FIT INFORMATION		
	Open Top	Thumb Break			
Right/Left	Belt Slide	Paddle	Belt Slide	Paddle	
12	R 5312-1	5412-1	5512-1	5612-1	Glock 26, 27, 33
	L 5312-2	5412-2	5512-2	5612-2	
15	R 5315-1	5415-1	5515-1	5615-1	Ruger P85, P89, P90, P91
	L				
16	R 5316-1	5416-1	5516-1	5616-1	Ruger P93, P94, P95, P97
	L				
18	R 5318-1	5418-1	5518-1	5618-1	S&W 5900 & certain 4000 Series
	L 5318-2	5418-2	5518-2	5618-2	
19	R 5319-1	5419-1	5519-1	5619-1	Up To 5" bbl 1911 Types
	L 5319-2	5419-2	5519-2	5619-2	
20	R 5320-1	5420-1	5520-1	5620-1	Most Beretta 92 & 96 Models
	L 5320-2	5420-2	5520-2	5620-2	
21	R 5321-1	5421-1	5521-1	5621-1	Glock 17, 22, 19, 23
	L 5321-2	5421-2	5521-2	5621-2	
22	R 5322-1	5422-1	5522-1	5622-1	SIGARMS 220, 226
	L 5322-2	5422-2	5522-2	5622-2	
23	R 5323-1	5423-1	5523-1	5623-1	SIGARMS Pro 2340
	L 5323-2	5423-2	5523-2	5623-2	
24	R 5324-1	5424-1	5524-1	5624-1	SIGARMS 225, 245, 228, 229
	L 5324-2	5424-2	5524-2	5624-2	
25	R 5325-1	5425-1	5525-1	5625-1	Glock 21, 20, 29, 30, 36
	L 5325-2	5425-2	5525-2	5625-2	
26	R 5326-1	5426-1	5526-1	5626-1	Springfield XD - Full Size
	L 5326-2	5426-2	5526-2	5626-2	
27	R 5327-1	5427-1	5527-1	5627-1	Springfield XD - Compact
	L 5327-2	5427-2	5527-2	5627-2	
29	R 5329-1	5429-1	5529-1	5629-1	Walther P99/SW99 Full size & compact
	L 5329-2	5429-2	5529-2	5629-2	
30	R 5330-1	5430-1	5530-1	5630-1	HK USP Full size
	L 5330-2	5430-2	5530-2	5630-2	
31	R 5331-1	5431-1	5531-1	5631-1	HK P2000, HK USP Compact (All Calibers)
	L 5331-2	5431-2	5531-2	5631-2	
36	R 5336-1	5436-1	—	—	S&W J Frame 38/357 up to 2 7/8" barrel
	L 5336-2	5436-2	—	—	



Hi-Lo Adjustment—Paddle lets you adjust holster height to fit body contours for best concealment.



Enhanced paddle design holds even more solidly. For 2006, we re-engineered our paddle to help it stay more solidly against the interior of your pants and your belt, without compromising comfort. Newly developed wedges provide additional resistance to solidify your holster's hold.

## Kydex paddle holsters cant options



Butt Forward behind-the-hip position



Vertical position



Muzzle Forward position for crossdraw



## Kydex Retention Holster

Our Kydex Retention holster is a brilliant combination of Kydex strength and dual retention. Perfect for Close Quarter Combat operations, this Kydex holster retains your firearm, even if someone tries to grab it. Engineered with the same retention device as our Uncle Mike's Law Enforcement dual retention duty holsters, this holster also takes safety to a new level with its release that aligns your finger along the frame of the firearm, rather than on the trigger—preventing accidental discharges. This holster is a great choice for concealment and undercover operations.

### **NEW** Kydex Retention Holster with MOLLE Platform

This system includes both a Cordura MOLLE-compatible platform and a Kydex injection-molded plate. Utilizing both the plate and the platform together allows you to mount an Uncle Mike's Law Enforcement Kydex holster anywhere you need it on a MOLLE-compatible system. By dismantling the plate from the platform, you can attach any Uncle Mike's Law Enforcement holster to a Molle compatible vest system. Holster can be mounted in a vertical or angled position.

- Size 20 #6820-1 Right handfits most Beretta 92 & 96 Models
- Size 21 #6821-1 Right handfits Glock 17, 22, 19, 23
- Size 22 #6822-1 Right handfits Sigarms 220, 226



Kydex Retention Holster with MOLLE Platform: Angled Carry (left), Vertical Carry (right)

## Kydex Tactical Holsters and

### **NEW** Tactical Internal Retention Holsters

- Solid Kydex body is matched to the fully adjustable leg strap and platform used on our Dual Retention and Tactical designs.
- Holster uses a conventional two-screw tensioning system and a molded external thumb break to retain the firearm.
- Tactical Retention Holster is available for 2006!

Kydex Tactical Retention Holster



### **NEW** Kydex Tactical Internal Retention Holsters

SIZE	ITEM NO.	FIT INFORMATION
Right/Left		
18 R L	5918-1 5918-2	S&W 5900 & 4000 Series
20 R L	5920-1 5920-2	Most Beretta 92 & 96 Models
21 R L	5921-1 5921-2	Glock 17, 22, 19, 23
22 R L	5922-1 5922-2	SIGARMS 220, 226
24 R L	5924-1 L5924-2	SIGARMS 225, 245, 228, 229
25 R L	5925-1 5925-2	Glock 21, 20, 29, 30, 36

Kydex Internal Retention Holsters		
SIZE	ITEM NO.	FIT INFORMATION
Right/Left		
12 R L	6012-1 6012-2	Glock 26, 27, 33 & other subcompact 9mm/.40 cal.
18 R L	6018-1 6018-2	S&W 5900 & certain 4000 series
20 R L	6020-1 6020-2	Beretta 92, 96
21 R L	6021-1 6021-2	Glock 17, 19, 22, 23
22 R L	6022-1 6022-2	Sig 220, 226
24 R L	6024-1 6024-2	Sig 228, 229
25 R L	6025-1 6025-2	Glock 21, 20, 29, 30, 36

### Kydex Tactical Holsters

SIZE	ITEM NO.	FIT INFORMATION
Right/Left	Thumb Break	
15 R L	5715-1	Ruger P85, P89, P90, P91
16 R L	5716-1	Ruger P93, P94, P95, P97
18 R L	5718-1 5718-2	S&W 5900 & 4000 Series
19 R	5719-1 L5719-2	Up To 5-inch Bbl 1911 Types
20 R	5720-1 L5720-2	Most Beretta 92 & 96 Models
21 R L	5721-1 5721-2	Glock 17, 22, 19, 23
22 R L	5722-1 5722-2	SIGARMS 220, 226
23 R L	5723-1 5723-2	SIGARMS Pro 2340
24 R L	5724-1 5724-2	SIGARMS 225, 245, 228, 229
25 R L	5725-1 5725-2	Glock 21, 20, 29, 30, 36
26 R L	5726-1 5726-2	Springfield XD 4" barrel
29 R L	5729-1 5729-2	Walther P99/SW99
30 R L	5730-1 5730-2	HK USP Full Size
31 R	5731-1 L5731-2	HK P2000, HK USP compact (All Calibers)

# Kydex durability now comes in these accessories

## Kydex Mag Cases

Now protect your magazines like you do your firearm. Choose from single or double cases, each with an internal tensioning device to assure your magazine is secure.

- Fits belt loops up to 1 3/4" or can be clipped over a waistband.

ITEM NO.	FIT INFORMATION
Single Mag Cases	
5037-1	Single Row 9mm-.45 caliber
5036-2	Double Row Polymer 9mm-.40 cal. Metal .45 caliber
5036-1	Large Double Row Polymer 10mm-45 caliber
Double Mag Cases	
5137-1	Single Row Belt Model
5137-2	Single Row Paddle Model
5136-1	Double Row Belt Model
5136-2	Double Row Paddle Model



## Kydex Molded Cuff Case

- Fits traditionally-sized chain or hinge cuffs.
- Belt loop for 1" to 1 3/4" belt widths.

Belt loop case #5125-1  
Paddle case #5125-2

## Kydex Belt Loops and Paddle

Change your existing belt holster into a paddle holster with our ambidextrous paddle. Change paddle holster to belt holster with our belt loops.

Right hand Belt Loop #5011-1  
Left hand Belt Loop #5011-2  
Paddle #5012-1

## Kydex Clip-On Tactical Light Holder

This holder accepts Insight Technology M-3, M-5 and M-6 lights, Glock lights, and some Surefire models.

- Clips on to any dress or duty belt up to 2 1/4".
- Carries light in either lens-up (tactical) or lens down (protective) position.

# 5030-1 Lens-up and Lens-down positions

Side view of Light Holder



# Decades of experience helps us design superior concealed carry options

Uncle Mike's® knows concealed carry. After working for decades with law enforcement agencies and understanding what works for undercover officers, we've been able to develop what is arguably the best and widest selection of concealed carry holsters on the market today. From inside-the-pant to ankle to belt pouches, you're certain to find the size and carry option that works best.

## The ultimate in concealment

### Inside-the-pant holsters

- Unique, ultra-thin four-layer laminate no thicker than conventional suede leather holsters.
- Internal moisture barrier won't transmit perspiration to firearm.
- Smooth nylon lining for easy draw.

Inside-the-Pant Holsters				
SIZE	ITEM NO.		FIT INFORMATION	
	Right/Left	Open Style		
0	R	8900-1	7600-1	2 - 3" barrel small/medium double action revolvers except 2" 5-shot
	L	8900-2	7600-2	
1	R	8901-1	7601-1	3 - 4" barrel medium autos
	L	8901-2	7601-2	
2	R	8902-1	7602-1	4" barrel medium and intermediate double action revolvers
	L	8902-2	7602-2	
5	R	8905-1	7605-1	4½ - 5" barrel large autos
	L	8905-2	7605-2	
10	R	8910-1	7610-1	Small autos (.22-.25 cal.)
	L	8910-2	7610-2	
12	R	8912-1	—	Glock 26, 27, 33 & other sub-compact 9 mm/.40 cal
	L	8912-2	—	
15	R	8915-1	7615-1	¾ - 4½" barrel large autos
	L	8915-2	7615-2	
16	R	8916-1	7616-1	¾ - 3¾" barrel medium and large autos
	L	8916-2	7616-2	
36	R	8936-1	7636-1	2" barrel small frame 5-shot revolvers with hammer spur
	L	8936-2	7636-2	

Inside-the-Pant holsters are offered in two styles; Open Style as shown here, or with Fold-over Velcro® retention strap

Suede-like exterior helps anchor holster inside pants or skirt

Belt clip slips over pant top & belt to hold gun securely and anchor firearm for positive draw



Fold-over Velcro retention strap releases quickly with thumb and meets requirements of many jurisdictions



Please see our holster fit chart on page 46-47.

## Excellent protection for firearm and clothing

### Inside-the-Pocket Holsters

- Laminated construction lessens print-through recognition, cushions the wearer's leg from sharp contours of the firearm, and provides a barrier against perspiration.
- Open-top holster provides grip-up positioning and prevents the movement of levers, buttons or catches that are common to loose pocket carry.
- Non-slip material band surrounds holster body to retain holster in pocket when firearm is drawn.

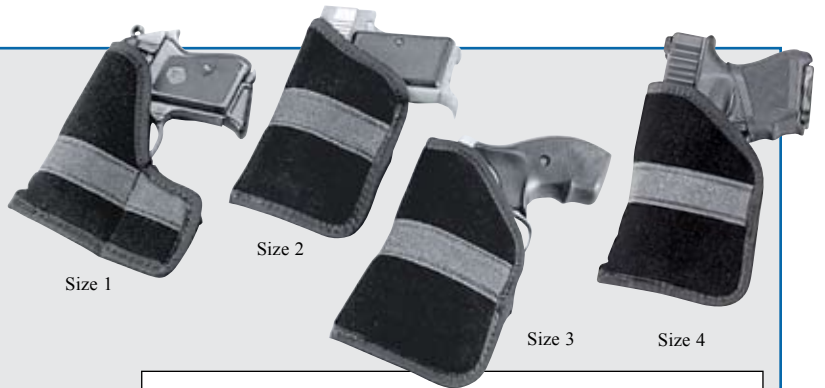

Gun rides upright for a clean draw and is protected from lint and debris inside pocket

SIZE	ITEM NO.	FIT INFORMATION
R/L		
1	8744-1	Small autos (.22-.25 cal.)
2	8744-2	Most .380s
3	8744-3	2" 5-shot revolvers; Sigma .380
4	8744-4	Most sub-compact 9mm/.40 autos

Holsters are Constructed With a Unique Four-Layer Laminate

Inside-the-Pant Inside-the-Pocket Belly Band/Body Armor

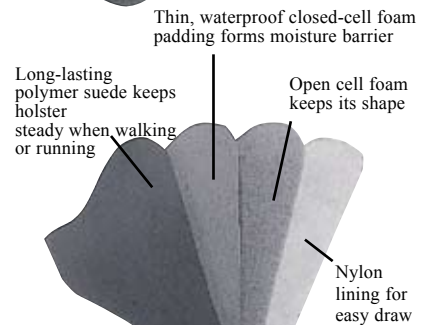

### Concealment Vest Holster

- Completely covered on both sides with Velcro hook, this nylon holster is intended for use in vests and other garments with compatible Velcro loop mounting surfaces.
- Holster can be positioned to facilitate popular drawing techniques, and fits most autos and revolvers. Comes with a Velcro overstrap.
- Integral front pocket accommodates most spare magazines and clip-on pocket knives or flashlights.



#8745-8



### Sidekick Ambidextrous Hip Holsters

Fully ambidextrous holster easily converts from right to left-handed.

- **Two holsters in one**—Wear as a belt holster (fits belts up to 2 1/4" wide) or an inside-pant holster, just by reversing the belt clip.
- **Secure**—Non-stretch Velcro® retention strap and molded thumb break keep your firearm secure. Holster includes a Strap Trap™ adjustment tool.
- **Durable**—Constructed of our patented Sidekick laminate of Cordura® nylon. Padded, waterproof interior holds the firearm snugly. Spring steel belt clip is powder coated for rust and corrosion resistance.

Removable and reversible belt clip



#### Sidekick Ambidextrous Hip Holster Sizing

SIZE R/L	ITEM NO.	FIT INFORMATION
1	7001-0	3 - 4" barrel medium autos
2	7002-0	3 - 4" barrel medium and large double action revolvers
5	7005-0	4 1/2 - 5" barrel large autos
15	7015-0	3 3/4 - 4 1/2" barrel large autos
16	7016-0	3 1/4 - 3 3/4" barrel medium and large autos
36	7036-0	Up to 2 1/4" small frame 5- and 6-shot revolvers with hammer spur



### Belly Band/Body Armor Holster

- Works for everyone because holster can be worn ambidextrously.
- Velcro®-covered belt loop accommodates both body armor side adjustment straps or Belly Band straps.
- Allows deep concealment because suede-like exterior is comfortable enough to be worn right against the skin.

Shown with reversible Velcro overstrap

SIZE R/L	ITEM NO.	FIT INFORMATION
1	8745-1	Small autos (.22-.25 cal.)
2	8745-2	Most .380s
3	8745-3	2" 5-shot revolvers; Sigma .380
4	8745-4	Most sub-compact 9mm/.40 autos, up to 3 1/2" barrels



Belly Band application

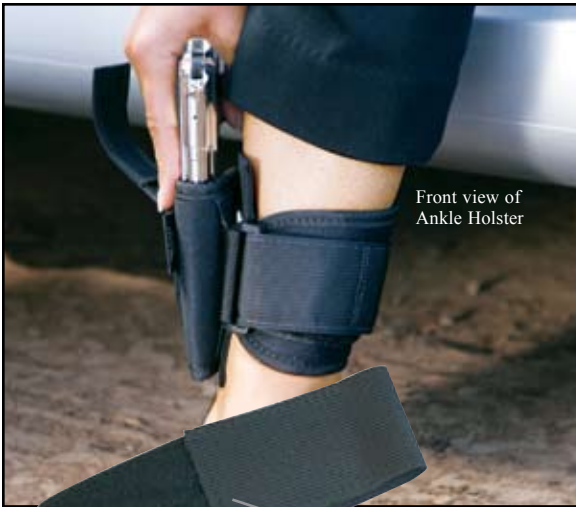

Front view of Ankle Holster

### Ankle Holsters

- Cordura® nylon holster conceals small and medium firearms, even some compact large frame autos inside pant leg.
- Soft knit fabric is comfortable enough to be worn right against skin.
- Closed cell foam acts as a moisture barrier and padding for comfort.
- Nylon web retention strap with reinforced thumb break.
- Cinch-down design with Velcro adjustment.
- Right hand model works inside left leg.
- Left hand model is for inside right leg.



Side view of Ankle Holster



Velcro adjustable, removable calf strap

Wrap-around design snugs holster strap around ankle

Open view

SIZE Right/Left	ITEM NO.	FIT INFORMATION
0 R	8820-1	2" barrel small frame 5-shot revolvers w/hammer spur
L	8820-2	
1 R	8821-1	3-4" barrel medium autos (.32-.380 cal.)
L	8821-2	
10 R	8810-1	Small autos (.22-.25 cal.)
L	8810-2	
12 R	8812-1	Glock 26, 27, 33 & other sub-compact 9mm/.40 cal
L	8812-2	
16 R	8816-1	3 1/4 - 3 3/4" barrel medium and large autos
L	8816-2	

# Pouches and Fanny Packs offer versatility for informal concealed carry

## Gun Pak™ Belt Pouch Holsters

Specifically designed for discreet handgun carry, the Uncle Mike's® Gun Pak™ utilizes an innovative hidden rear compartment that allows for a quick, smooth draw. The gun compartment is accessed first through a zippered top and then through a Velcro® closure. The unique design of the Gun Pak allows you to open the center compartment without exposing the firearm, making it an ideal choice for off-duty carry. Fits on any belt up to 2 1/4" wide.

- **Handy**—Enough room to carry sunglasses, a wallet and ID—in addition to a concealed firearm.
- **Discreet**—Black Gun Pak attracts no more attention than a conventional fanny pack.
- **Original size:** 8" w x 5 1/2" h x 1 5/8" d. Carries most small and medium frame pocket autos, compact 9mms, and small frame 2" to 3" barrel revolvers.
- **Federal size:** 8 3/4" w x 7" h x 1 5/8" d. Carries most medium and large frame autos and many medium frame short barrel revolvers.

Original #8889-1      Federal #8889-5



Reach front compartment without exposing firearm in rear



Quick access to firearm in rear compartment



Divided compartments, plus outside pocket



## GunRunner® Fanny Pack Holsters

The GunRunner® is an unassuming Fanny Pack holster designed to accommodate all basic firearm sizes. Like the Gun Pak, its lack of an internal holster allows a quick, smooth draw and, more importantly, a one-handed return.

- Generic-appearing black belt pack has 3 zippered compartments.
- Reholster with one hand to secure gun and wipe Velcro shut—all without taking your eyes off surroundings.
- All-Velcro back panel and a 12" strap included to position and secure firearm.
- Tough, 1 1/2" wide adjustable nylon web belt with quick-release buckle.
- **Small size** is 11 1/2" x 5 3/4". Holster compartment fits small frame 2" barrel revolvers, most .380 autos and some sub compact 9mm or .40 autos. **Medium size** is 12 1/2" x 6 1/8". Holster compartment fits compact 9mm, .40 and .45 autos, 2" - 3" barrel medium revolvers and most full size service pistols.
- **Large size** is 12 1/2" x 7". Holster compartment fits larger autos and 4" barrel revolvers.

Small #8872-1

Medium #8873-1

Large #8874-1



Velcro belt loop on rear secures GunRunner to belt if desired



## Briefcase with Hidden Holster

This is the perfect commuter briefcase because it gives you unsurpassed security. Although it looks like an ordinary briefcase, this Uncle Mike's model is completely different because it gives you ready access to a hidden holster built right into the interior.

- Internal holster can be adjusted for most handguns and positioned to facilitate most drawing techniques.
- Firearm is easily reached, even with flap secured and the rear compartment closed.
- Conventional in appearance, this expandable briefcase has a multi-use front panel and large interior pockets. Full-flap cover secures with two quick-release buckles to keep all interior contents secure.

#5255-1



**One-way Velcro solidly holds our retention straps** Non-stretch retention straps and molded thumb breaks—available on most Uncle Mike's Law Enforcement concealment and shoulder holsters—utilize an improved Velcro material for better performance. The molded, uni-directional teeth grab onto the loop material in just one direction, keeping your retention straps from slipping. The result is a tight, solid hold that can be easily pushed into place.

Draw your firearm directly through the Velcro®-sealed opening at the front of the bag

# More choices for concealment... belt holsters that really stand up!

## Super Belt Slide Holsters

Optimum for concealed carry because of the flattened profile. Plus, the medium-high-ride design positions firearm for a smooth draw. 3-slot design on all configurations (except PRO-3®) allows for crossdraw, dual position or strong-side carry.

- Extra-thin laminate has minimal thickness and conforms to body contours for comfort and concealment.
- Thumb break and retention strap are both protected by Strap Traps™ to prevent straps from detaching and to prevent chafing. Adjustment tool included.

## PRO-3® Super Belt Slide Holsters

Our triple retention design makes this holster a great choice for concealed carry. Choose from Cordura® or plain Mirage® finishes.



Interior view of the PRO-3 Super Belt Slide Holster



Cordura nylon has a woven rugged appearance. It's abrasion-resistant and water-resistant. Super Belt Slide Holster pictured above.

### PRO-3® Super Belt Slide Holsters

SIZE	CORDURA	MIRAGE	FIT INFORMATION
Right/Left	Plain		
20	R 3820-1	3920-1	Beretta 9mm, .40, Smith & Wesson 10mm, .45 (5" barrels except w/hook-type or extended trigger guards)
	L 3820-2	3920-2	
21	R 3821-1	3921-1	Glock 17, 19, 22, 23
	L 3821-2	3921-2	
22	R 3822-1	3922-1	Sig Sauer 9mm, .38S, .40, .45
	L 3822-2	3922-2	
30	R 3830-1	3930-1	HK USP 9mm, .40, .45, USP Compact, Walther P99

## HiddenHammer™ Super Belt Slide Holster

If you've had problems finding a holster that works for your firearm with a concealed, shrouded or spurless hammer, we've got the solution with our Hidden-Hammer™ Super Belt Slide holster.

- Holds 2-inch 5-shot revolvers, using an internal retention mechanism, similar to that patented on the Uncle Mike's professional PRO-3 holster.
- Internal locking device fits into revolver trigger guard. A separate, sewn-down retention strap fits positively over firearm frame.
- Right hand only.



Size 40 #6340-1

MIRAGE nylon looks like leather and wears like steel. Easy to clean, it'll look great for years.

### Super Belt Slide Holsters

SIZE	ITEM NO.	CORDURA	MIRAGE	FIT INFORMATION
Right/Left		Plain		
0	8600-0	6300-0		2 - 3" barrel sml/med double action revolvers except 2" 5-shot
1	8601-0	6301-0		3 - 4" barrel medium autos
2	8602-0	6302-0		4" barrel medium and intermediate double action revolvers
5	8605-0	6305-0		4 1/2 - 5" barrel large autos
12	8612-0	6312-0		Glock 26, 27, 33 and other sub-compact 9mm/.40 cal autos
15	8615-0	6315-0		3 3/4 - 4 1/2" barrel large autos
16	8616-0	6316-0		3 1/4 - 3 3/4" barrel medium & large autos
19	8619-0	6319-0		Colt Gov't large autos, Browning Hi-Power
30	8630-0	6330-0		HK USP 9mm, .40, .45, USP Compact
36	8636-0	6336-0		2" barrel small frame 5-shot revolvers with hammer spur

## Side Bet™ and Baby Bet™ Belt Slide Holsters

Now you have a choice for carrying very small revolvers and autos. Our Side Bet™ and Baby Bet™ carry the firearm at a butt forward angle, making them ideal for strong side concealment.

- Ambidextrous design. Just reverse thumb break and retention strap to change from right to left.
- Nylon web belt loops on both sides fit belts up to 1 1/2" wide.
- Side Bet fits most autos and revolvers.
- Baby Bet fits .22 and .25 autos and very small frame .380s.

Side Bet #8690-0

Baby Bet #8690-1



Baby Bet for baby autos



Side Bet for most handguns





## Our most versatile holster

### Paddle Holsters

- Paddle adjusts for vertical, butt-forward or muzzle-forward (cross draw) carry.
- Molded offset spacer adjusts holster height to accommodate various body types, torso lengths, gun butt configurations and modes of dress.
- Paddle made of semi-rigid material that conforms to hip for comfort & concealability.
- Offset spacer and vertical adjustability make this a great holster for women.
- Thin Cordura® laminate reduces bulk.
- Holster completely encloses triggerguard and features a non-stretch retention strap and molded thumb break.
- Offset spacer keeps gun off of hip structure and parallel to centerline of body.



Hi-Lo Adjustment—offset spacer lets you adjust height of paddle to fit body contours for best concealment

SIZE	ITEM NO.	FIT INFORMATION
0	7800-1	2 - 3" barrel sml/med double action revolvers except 2" 5-shot
1	7801-1	3 - 4" barrel medium autos
2	7802-1	4" barrel medium and intermediate double action revolvers
5	7805-1	4½ - 5" barrel large autos
15	7815-1	¾ - 4½" barrel large autos
16	7816-1	¾ - ¾" barrel medium and large autos
19	7819-1	Colt Gov't large autos, Browning Hi-Power
21	7821-1	Glock 17, 19, 20, 21, 22, 23, 29, 30
36	7836-1	2" barrel small frame 5-shot revolvers with hammer spur

## Great value and full features make this holster a winner

### Hip Holsters with Thumb Break

We thought of everything in this Cordura nylon holster, including features not found in more expensive holsters:

- A great choice for officers on inside duty, security officers and institutional personnel.
- Can be used on a duty or dress belt, thanks to a dual-slot belt loop.
- Patented laminate construction makes holster waterproof and protective. There's even a sight track for protecting the front sight.
- Molded thumb break and non-stretch retention strap assure safety.
- Strap Trap™ Technology included.



SIZE	ITEM NO.	FIT INFORMATION
R action	7100-1	2 - 3" barrel small/medium double
L	7100-2	revolvers except 2" 5-shot
1	R 7101-1 L 7101-2	3 - 4" barrel medium autos
2	R 7102-1 L 7102-2	4" barrel medium and intermediate double action revolvers
3	R 7103-1 L 7103-2	6" barrel medium and intermediate double action revolvers
5	R 7105-1 L 7105-2	4½ - 5" barrel large autos
5	R 7205-1 L	4½ - 5" barrel large autos with lasers
15	R 7115-1 L 7115-2	¾ - 4½" barrel large autos
15	R 7215-1 L	¾ - 4½" barrel large autos with lasers
16	R 7116-1 L 7116-2	¾ - ¾" barrel medium and large autos
19	R 7119-1 L 7119-2	Colt Gov't large autos, Browning Hi-Power
21	R 7121-1 L 7121-2	Glock 17, 19, 20, 21, 22, 23, 29, 30
36	R 7136-1	2" barrel small frame 5-shot revolvers



Strap Trap™ innovation assures adjustability and staying power

Many Uncle Mike's nylon holsters, including Pro-Pak and Paddle Holsters, benefit from our Strap Trap technology, which keeps thumb breaks and straps from stripping away. This exclusive technology not only assures your adjustment will stay put, it also helps prevent chafing that can occur without such technology. All holsters with Strap Trap include a tool to make adjustment quick and easy.

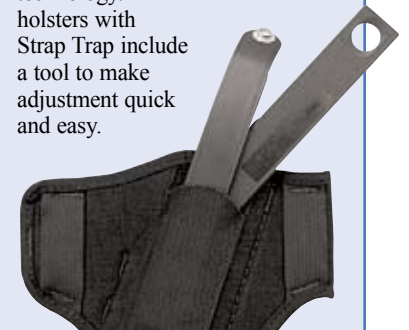



# Pro-Pak Holsters and the art of concealment

## Your personal carry and drawing style are accommodated

For everyday wear, Uncle Mike's® Pro-Pak® holsters are unbeatable. Developed for simplicity and wearability, our Pro-Pak holsters weigh just ounces, but are engineered to hold up to the stresses of every-day firearm carrying and are ergonomically designed for comfort.

Pro-Pak holsters lay flat against your body, making them an excellent choice for use under jackets. Constructed of an extra-thin laminate with

a Cordura® nylon outer shell, the Pro-Pak doesn't print, thanks to a smooth nylon lining that protects your firearm's finish and aids in drawing and reholstering.

Developed for professional detectives, Pro-Pak holsters are now widely used by people outside of law enforcement because they fit the bill for durability and ease-of-wear.



### Pro-Pak Horizontal Shoulder Holsters

- Horizontal carry for a fast draw and lightweight comfort.
- Offside tie-down has single mag case for autos or single speedloader case for revolvers.
- Weight: (Size 15) 6.3 oz.

Most popular of the three Pro-Pak models



SIZE	ITEM NO.	FIT INFORMATION	
Right/Left			
0	7700-0	2 - 3" barrel sml/med double action revolvers except 2" 5-shot	
1	7701-0	3 - 4" barrel medium autos	
2	7702-0	4" barrel medium and intermediate double action revolvers	
5	7705-0	4½ - 5" barrel large autos	
15	7715-0	3¾ - 4½" barrel large autos	
16	7716-0	3¾ - 3¾" barrel medium and large autos	

### Pro-Pak Vertical Shoulder Holsters

- Vertical carry provides excellent concealment, comfort and retention, especially with large firearms.
- Off-side tie-down has single magazine case for autos or single speedloader case for revolvers.
- Weight: (Size 15) 6.6 oz.



Easiest to reholster of the three Pro-Pak models

SIZE	ITEM NO.	FIT INFORMATION	
Right Only			
1	7501-1	3 - 4" barrel medium autos	
2	7502-1	4" barrel medium and intermediate double action revolvers	
5	7505-1	4½ - 5" barrel large autos	
15	7515-1	3¾ - 4½" barrel large autos	

### Pro-Pak Undercover Shoulder Holsters

- Elastic back strap adjusts for best fit and attaches to harness yoke with spring clip for optimum positioning.
- Weight: (Size 15) 5.3 oz.



Lightest of the three Pro-Pak models

SIZE	ITEM NO.	FIT INFORMATION	
Right/Left			
0	9700-0	2 - 3" barrel sml/med double action revolvers except 2" 5-shot	
1	9701-0	3 - 4" barrel medium autos	
2	9702-0	4" barrel medium and intermediate double action revolver	
5	9705-0	4½ - 5" barrel large autos	
10	9710-0	Small autos (.22-.25 cal.)	
15	9715-0	3¾ - 4½" barrel large autos	
16	9716-0	3¾ - 3¾" barrel medium and large autos	
36	9736-0	2" barrel small frame 5-shot revolvers with hammer spur	

## Accessorize your Pro-Pak Holster with these cases

### Double Magazine Case

Can be carried vertically or horizontally.

#7790-1

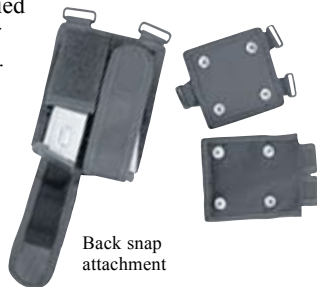

Back snap attachment

### Open Handcuff Case

This one-piece design assures a fast draw. Just pull on cuffs to break snap open. Reholster cuffs with one hand. Attaches horizontally to the off-side tie-down strap, below the double mag case for both the Vertical and the Horizontal Shoulder Holsters.

#7792-1



### Universal Radio Case

Fully adjustable to hold any handheld radio. Radio can be carried with antenna up or down. Offers a quick release buckle to make access to the radio both easy and secure.

#7793-1





# Nylon duty belts for every uniform, every kind of duty

For lightweight flexibility and comfort, nothing compares to our line of duty belts.

Uncle Mike's Law Enforcement® offers four styles of belts in three finishes of nylon and MIRAGE®-laminated nylon to match our duty accessories and holsters. Our duty belts are tough, lightweight, flexible and offer such features as triple retention buckles for security, layered construction for durability and advanced Velcro® for fit.

Your duty belt is the platform on which you carry all your vital tools into the field. Your choice of duty belt is as important as your choice of holster or service firearm. Make sure you choose Uncle Mike's Law Enforcement.



Triple Retention Buckle

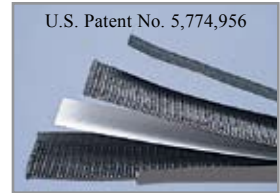

U.S. Patent No. 5,774,956

## Duty Belts



Nylon Web Ultra® Duty Belt



MIRAGE Plain Ultra® Duty Belt

### Ultra® Duty Belt

- Designed and constructed of a double layer of tough 2" nylon that minimizes bulk and maximizes comfort with its padded edges. The entire belt is stiffened with polymer for support.
- All belt finishes share the same construction, based on sturdy nylon webbing. Leather-look plain and basketweave finishes are added to all MIRAGE models.
- Rigid enough to support duty gear, yet flexible for comfort.
- All belts have Velcro lining to mate with Ultra and Loop-Back Inner Duty belts; nylon web model is also available without Velcro.
- Edges of web belts are finished with smooth nylon to prevent snagging and cutting into your side; MIRAGE models have rolled edges.

### Deluxe Duty Belt

- Designed for light to moderate use, this lightweight belt is nearly as rigid as many heavy leather belts.
- Made of a double layer of tough 2" nylon web for comfort and support.



Uncle Mike's Law Enforcement® Belts	SIZE	Sm	Med	Lg	X-Lg	XX-Lg
	inches	26-30	32-36	38-42	44-48	50-54
	mm	660-762	813-914	965-1067	1118-1219	1270-1372
Web Ultra® Duty Belt with Velcro		8776-1	8777-1	8778-1	8779-1	8779-2
Web Ultra® Duty Belt without Velcro		8772-1	8773-1	8774-1	8775-1	—
MIRAGE Plain Ultra® Duty Belt with Velcro			7076-1	7077-1	7078-1	7079-1
MIRAGE Basketweave Ultra® Duty Belt w/Velcro 7095-1				7092-1	7093-1	7094-1
Ultra® Inner Duty Belt		8781-1	8782-1	8783-1	8784-1	8784-2
Loop-Back Inner Duty Belt		—	8792-1	8793-1	8794-1	—
Deluxe Duty Belt		8823-1	8801-1	8802-1	8822-1	—

Other sizes of Ultra Duty Belts are available by Special Order only

## Inner Duty Belts

### Ultra Inner Duty Belt

- Adds even more stability for times when you're carrying a lot of gear.
- 1½" wide double layer nylon web with bound edges and Velcro sizing adjustment.
- Outer surface has full length of Velcro loop to mate with Velcro hook on Ultra or Duty Belts.
- Reversible for administrative wear.



### Deluxe Inner Duty Belt

- Made of a single thickness of sturdy 1½" nylon web.
- Velcro-adjustable.

### Loop Back Inner Duty Belts

- Reversible belt can be worn nylon side out for dress use.
- Loop back system with Nylon Loop and Velcro fastening permits easy tightening and superior strength in a low-profile configuration.
- Constructed of 1½" nylon web covered with Velcro loop to mate with Velcro hook on Ultra Duty Belts.



### Reinforced Instructor's Belt

- Styled after traditional rescue or "riggers" belt.
- 1 1/2" width allows for wear with khakis and jeans, as well as BDUs.
- Polymer reinforcement is sandwiched between two layers of rigid nylon, to support even the heaviest pistol.
- Works great at the range, in the squad room or on a casual day off.

Medium	32" - 36"	#8767-1
Large	38" - 42"	#8768-1
X-Large	44" - 48"	#8769-1
XX-Large	50" - 54"	#8769-2



### Looks like a dress belt, but works like a holster belt

#### Reinforced Holster Belt

- Smart dress belt appearance, with the rigidity to support even the heaviest handgun.
- Laminated construction sandwiches a polymer stiffener between two layers of MIRAGE® nylon.
- Belt remains flexible and is no thicker than an average leather dress belt, yet provides a good platform for carrying a holstered handgun, radio and other accessories.
- Black belt is 1 1/4" wide.

Polymer stiffener reinforces belt between two layers of MIRAGE nylon

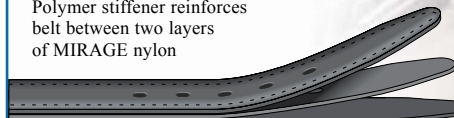

WAIST SIZE								
inches		32	34	36	38	40	42	44
mm		813	864	914	965	1016	1067	1118
ITEM NO.		9102-1	9102-2	9102-3	9102-4	9102-5	9102-6	9102-7



### PRO-3® Triple Retention Buckle

All Ultra and Deluxe Duty Belts utilize our patented PRO-3 Triple Retention Buckle. The top, bottom and center releases must be used together to open the buckle. Easily done with one hand, this reduces the possibility of accidental opening or opening under attack. The buckle is contoured to fit closely and comfortably against your body. Please contact us for more information.

## Keep your duty and inner belt together with Uncle Mike's Belt Keepers

Uncle Mike's Law Enforcement Belt Keepers are designed to lock the duty belt and the inner duty belt together. Tough, no-wear, no-glare snaps stay secure despite the most rigorous activity. Comes in sets of 4.

### Molded Belt Keepers

- Best on the market because they're more flexible than hardened plastic belt keepers.
- Molded polymer won't stretch out of shape, crack, fray or fade with age like other web belt keepers can.

Molded for 2" belts	#8865-3
Molded for 2 1/4" belts	#8865-4
Basketweave molded for 2" belts	#8865-7
Basketweave molded for 2 1/4" belts	#8865-8



### Nylon Web Belt Keepers

- Resist stretching or fraying.
- |                            |         |
|----------------------------|---------|
| Nylon web for 2" belts     | #8865-1 |
| Nylon web for 2 1/4" belts | #8865-2 |

### Key-Per™

- Special belt keeper with hidden cuff key.
- Molded and nylon web models for 2" belts.
- Matches Uncle Mike's keepers shown above.

Nylon Web Key-Per	#8865-5
Molded Key-Per	#8865-6



### Duty Suspenders

Transfer the weight of the duty rig from your hips to your shoulders to prevent lower back injuries.

- Fully adjustable front and rear, with a special cross piece in back that adjusts as you move.
- A break-away snap design helps defeat grabbing.

Sm/Med	Fits up to 40" chest	#9120-3
Lg/XL	Fits 42" and up chest	#9120-4



Break-away snap design



# Designed for function and durability

## Fitted Pistol Magazine Cases with Protective Inserts

For long lasting, hard working mag cases that really look professional on your duty belt, you can't beat Fitted Pistol Magazine Cases from Uncle Mike's Law Enforcement®.

All of our mag cases offer:

- Hardened inserts that are rigid on the sides, front and bottom for maximum protection.
- Separate compartments for each magazine.
- Separate internal devices retain each magazine.
- Soft-molded belt loop for belts up to 2 1/4".

Open top models also provide:

- Increased retention of the magazine.
- Direct access to the magazine.

Flap models have:

- Padded, reinforced flaps with knit lining to cover and protect magazine.
- A nylon stiffener in the flaps makes them easier to open and helps them keep their shape after continued use.
- Versions for both single and double row, metal and polymer mags in 9mm, .40 S&W, 10mm and .45ACP.



A Guide to the special features of our Law Enforcement mag cases



Molded Insert

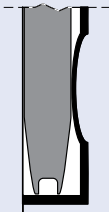

Internal Tensioning Device



**Reinforced Flaps on Belt Accessories**  
A layer of polymer has been added to the laminate of the accessory flaps. This construction helps avoid crushing and allows flaps to retain their shape, despite continued use.

Fitted Pistol Magazine Cases	Cordura	MIRAGE Plain	MIRAGE Basketweave
Single Case (Open Top) for Sgl and Dbl Metal Mag	8817-3	—	—
Single Case (Open Top) for Double Row Polymer Mag	8817-4	—	—
Single Case w/Flap for Double Row Mag	8817-2	—	—
Single Case w/Flap for Single Row Mag	8817-1	—	—
Double Case w/Flaps for Double Row Mags	8836-1	7436-1	7436-2
Double Case w/Flaps for Single Row Mags	8837-1	—	—
Divided Case w/Flaps for Lg. Frame Glock & HK Mags	8826-1	—	7426-2
Divided Case w/Flaps for Double Row Mags	8836-7	7436-6	7436-7
Divided Case w/Flaps for Single Row Mags	8837-7	7437-6	7437-7
Quad Case w/Flaps for Double Row Mags	8836-4	—	—
Quad Case w/Flaps for Single Row Mags	8837-4	—	—



Double Cases, Divided Double Cases and Quad Cases can be carried either horizontally or vertically. Single Cases are designed for vertical carry only.

Fitted Pistol Magazine Cases with Insert  
Divided Double Cases have traditional separated compartments to facilitate grip on magazines.



Open Top Single Magazine Case with Insert



Fitted Quad Magazine Case

### SlimLine™ Dual Magazine Case

- Originally intended for smaller waistlines, this mag case can also be used on load-bearing tactical leg platforms, in plainclothes use for carrying two mags as conveniently as one, in specialty units that need maneuverability, and in uniform duty where space makes it easier to access the equipment under stress.
- The SlimLine Dual Mag Case is 2/3 the width of our standard models.
- Case is designed for metal or polymer, double-column, 9mm or .40 S&W magazines.
- Separate compartments with independent tensioning devices protect and retain the mags.
- Case uses a molded "Dual Slot" belt loop for either dress or duty belts up to 2 1/4".

Cordura

#8894-1

### Police Wallet Badge Holder

- Long-lasting police wallet constructed of Cordura nylon.
- Currency and credit card compartments.
- Window for I.D. holds card up to 2 1/2" x 3 1/2" (64mm x 89mm).

#8856-1



# Universal Pistol Magazine Cases work with every magazine and other field tools

Use these universal cases not just for mags, but also for holding knives and multi-purpose tools. All have a protective knit interior laminated to a closed-cell foam laminated to a Cordura® outer shell.

## Large Frame Glock Single Mag Case

Fits Glock 10mm or .45ACP magazines, polymer HK .45 mags and larger folding knives. Fits belts up to 2 1/4" when carried vertically or belts up to 1 1/2" when carried horizontally.

#8819-1

## Universal Double Mag Case

Can be carried both horizontally or vertically. Fits most standard single and double row metal and polymer mags in 9mm, .40 S&W, 10mm, and .45ACP. Fits belts up to 1 1/2".

#8829-1

## Single .380 Mag Case

Fits single row .380 magazines, single row compact and subcompact 9mm magazines, small folding knives and multi-purpose tools. Vertical carry only on belts up to 2 1/4".

#8893-1

## Universal Single MagCase/ Undercover Single Mag Case with Belt Clip

Fit most standard 9mm, .40 S&W, and single row 10mm and .45ACP metal magazines and mid-to-large police-type knives. Undercover model has belt clip allowing it to be worn on most dress belts.

Universal Single Mag Case #8832-1  
Undercover Single Mag Case #8824-1



## Fitted Speedloader Cases

- Reinforced flaps have nylon stiffener for easier opening; no-glare, no-wear snap closures.
- Accepts most popular .38 and .357 speedloaders including Safariland® and HKS (not for N-frame or Ruger Redhawk).
- Cases fit belts up to 2 1/4".
- Molded insert holds speedloader upright; makes it easier to remove.

Single Cordura #8830-1  
Double Cordura #8831-1  
MIRAGE Basketweave #7431-2



## Universal Speedloader Cases

- Sturdy Cordura nylon cases hold most speedloaders from .38 to .45 Colt; fit belts up to 2 1/4".
- Closed-cell foam padding and knit lining; flaps have Velcro closure.
- Double model has Cordura divider to keep speedloaders apart.
- Single case fits TASER cartridges.

Single Cordura #8827-1  
Double Cordura #8828-1



# Uncle Mike's offers more variety in flashlight holders

We offer cases for the most popular police and professional-grade flashlights, including Streamlight® Scorpion®, Strion™, and Stinger® models, and Pelican® and SureFire® models.



## Light Cases

- Molded belt loop fits belts up to 2 1/4".
- Choose open or closed designs depending on flashlight design. On closed designs, a reinforced flap protects the flashlight from damage. A no-glare, no-wear snap secures the flap.
  - Available in Mirage® or Cordura® nylon finishes.

	Cordura	MIRAGE Plain	MIRAGE Basketweave
SureFire 6P and Streamlight® Scorpion, T2 and Strion™	8818-1	7418-1	7418-5
SureFire 6R and Streamlight T3	8818-2	—	—
Streamlight Stinger or Pelican M7	8818-3	7418-3	7418-7
Streamlight Stinger XT™	8818-4	7418-4	7418-9
Streamlight Stinger HP™	8815-1	7415-1	7415-2

See our **FYI** Flashlight Fit Chart on Page 44.



Stinger HP Light Holders

## Mini Light Cases

- Carry a Mini-Mag® or other AA flashlights in these handy nylon belt cases.
- Molded belt loop fits any belt up to 2 1/4".
- Available in open or closed style.

OPEN STYLE	
Cordura	8866-1
FLAP STYLE	
Cordura Black	8867-1
MIRAGE Basketweave	7467-2



Open Top Cuff Case has a break open snap—just pull on cuffs to remove them

Single Duty Cuff Case flap has rust-proof snap closure and a no-glare, no-wear snap

SlimLine Cuff Case

	Cordura	MIRAGE Plain	MIRAGE Basketweave
Open Top Single Cuff Case with Belt Loop 7792-1	—	—	—
Open Top Single Cuff Case with Belt Clip 8825-1	—	—	—
Duty Cuff Case w/Flap - Single 8878-1	8878-1	7478-1	7478-2
Duty Cuff Case w/Flap - Double 8857-1	—	—	7457-2
Compact Cuff Case w/Flap 8835-1	—	—	—
SlimLine Dual Retention Cuff Case - Single 8885-1	8885-1	7485-1	7485-2

Double Duty Cuff Case has two interior compartments and flap with both snap and Velcro® closures so it can be pressed shut after one set of cuffs has been removed.

## Leave it to Uncle Mike's for the best innovations in handcuff retention

### Handcuff Cases

- Innovative one-piece design limits bulk and allows for additional reinforcement from flap to back wall.
- Fast, easy gripping is assured, thanks to a low-cut front wall. Reholstering is easy, too.
- Works with plainclothes applications as easily as uniformed.
- Narrow width uses a minimum of belt space.
- Dual slot belt loops on all models except the open top belt clip allow wearer to move the case to either dress or duty belts up to 2 1/4".
- Open top belt model comes with a strong clip for easy fit on dress belts and waistbands.

### SlimLine™ Dual Retention Cuff Case

- No bigger than our Single Duty Cuff Case with Flap.
- Cuffs are better protected due to a "pull-through" internal fastener.
- Produce cuffs simply by opening the flap and pulling them through.
- Ideal for special response teams, bike and motor patrols, marine units and natural resource departments.
- Works with conventionally sized cuffs from S&W, Peerless, American Handcuff and Hyatt.



See our Handcuff Fit Chart on Page 44.

## Aerosol Chemical Agent Cases

- Perfect for keeping personal chemical agents right at your fingertips. Four sizes will fit pocket, mid-size and 1 1/2" diameter canisters.
- Works for conventional duty and larger canisters of most popular agents, including CS, CN, Mace, Pepper Mace, Cap Stun and Punch.
- Polymer insert in medium and large models prevents canister denting; smooth lining preserves canister markings.
- Foam spacer on medium and large cases accommodates canisters with over-sized nozzles.
- Fits belts up to 2 1/4".

## IMPROVED FOR 2006!

We've upgraded the attachment system for our Chemical Agent case by adding a metal clip, increasing the durability.



SIZE	Inside Dimensions	Cordura	MIRAGE Plain	MIRAGE Basketweave
Medium (belt loop)	1 1/2" x 4 1/2" 38mm x 114mm	8877-1	7477-1	7477-5
Medium (belt clip)	1 1/2" x 4 1/2" 38mm x 114mm	8877-2	—	—
Large	1 1/2" x 6 1/2" * 38mm x 165mm	8869-1	7469-1	7469-2
Extra Large	1 1/2" x 7" * 38mm x 178mm	8870-1	—	—

\* Will accept fogger handle



Belt Clip Model



Medium and large models have an impact-resistant insert to protect canister from damage.

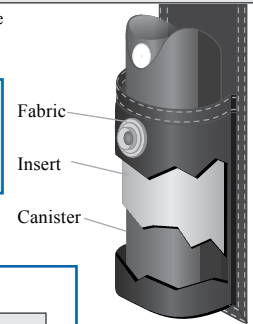

## Expandable Baton Holders

- Injection-molded for durability.
- Same tension arm principle as in our magazine pouches—keeps baton in place.
- 16" model retains previous flexible design with body made of Cordura.
- Holders have hole in back to permit holstering fully extended baton.

Rear slot allows open baton to be reholstered under stress



	For 16" Batons	For 21" & 26" Batons
Cordura	8881-1	8884-1
MIRAGE Plain	—	7484-1
MIRAGE Basketweave	—	7484-2

Mirage® or Cordura® nylon appliques enhance appearance

## C-Cell and D-Cell Flashlight Holders

- Nylon web or molded belt loop.
- Plain ring for holding Mag-Lite® or other C-cell or D-cell flashlights.
- Double snap loop attaches to belts up to 2 1/4"; no-glare, no-wear snaps.

### C-Cell Flashlight Holders

Nylon Web #8863-1  
Molded #7463-1

### D-Cell Flashlight Holders

Nylon Web #8862-1  
Molded #7462-1

## PR-24 Nightstick Holder

- Nylon web for side handle baton.
- Special retainer on ring controls nightstick when officer is running.
- Double snap loop attaches to belts up to 2 1/4"; no-glare, no-wear snaps.
- Inside diameter 1 1/2".

#8861-1

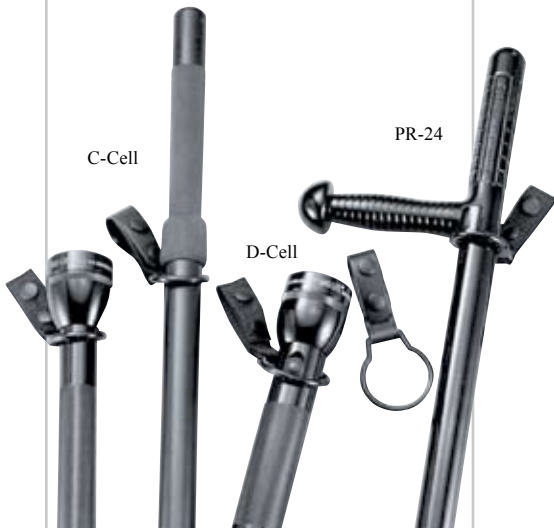

## Key Ring Holders

- Our Silent Key Ring Holder rides higher, keeps out of your way, yet is readily accessible.
- Silent Key Ring Holder has wrap-around Velcro® flap to hold keys quietly and securely.
- Open Holder has padded nylon flap to prevent trouser wear, and no-wear, no-glare double snaps on belt loops.
- Holders fit belts up to 2 1/4".

	Silent	Open w/Flap	Standard
Cordura	8858-1	8860-1	8871-1
MIRAGE Plain	7458-1	7460-1	7471-1
MIRAGE Basketweave	7458-2	—	—



## Latex Glove Pouches

- Made of Mirage or Cordura nylon, laminated to 1/8" closed-cell foam core and knit interior to prevent snagging gloves.
- Double pouch with fold-up design has two pockets for standard latex gloves; remove one pair without disturbing second pair.
- Fits belts up to 2 1/4".

### SINGLE POUCH

Cordura #8887-1

### DOUBLE POUCH

Cordura #8896-1

MIRAGE Plain #7496-1

MIRAGE Basketweave



# Trust Uncle Mike's to protect your important communications tools

Radios and phones are life lines for our customers; that's why we design our radio cases and other belt cases to stand up to the rigors of field use. Whether constructed from our signature Mirage® laminate or extra tough Cordura® nylon, we've engineered strength and long life into all our communications carrying products. With Uncle Mike's® you can assure your radio and phone are always there when you need them.



## Laminated Radio Cases

- Padded to protect against the day-to-day abuse of striking the handheld radio against steering wheels, desktops and door frames.
- Two configurations—Swivel Belt Loop and Fixed Belt Loop.



Laminated Radio Case

## Fitted Handheld Radio Cases with Insert

- Cordura nylon outer cover with rigid polymer insert for protection.
- Ideal for bicycle, motorcycle, tactical and specialized unit applications where severe abrasion is possible.
- Fitted with a swivel belt loop, case can be detached quickly from the belt loop simply by rotating radio.



Fitted Handheld Radio Case with Insert

## Universal Radio Case

- Available in both fixed belt loop and swivel belt loop for easy removal of case.
- Fits most police, fire and business-band radios.
- Nylon web and Velcro® construction adjusts the height, width and depth of the case to fit your specific needs.
- Excellent for agencies with mixed inventories or hard-to-fit designs.



Universal Radio Case



Belt Loop Configurations

Handheld Radio Cases		LAMINATED				
FITTED		Swivel Belt Loop			Fixed Belt Loop	Swivel Belt Loop
All belt loops fit belts up to 2 1/4"		Cordura	MIRAGE Plain	MIRAGE Basketweave	Cordura	Cordura
Radio Compartment Measures:						
Size 1	1 3/4" D x 2 7/8" W x 4 3/4" H (44mm x 73mm x 121mm)	8898-1	—	—	8897-1	8880-1
Size 2	1 3/4" D x 2 7/8" W x 3 3/4" H (44mm x 73mm x 95mm)	8898-2	—	—	—	8880-2
Size 3	1 1/2" D x 3" W x 4 3/4" H (38mm x 76mm x 121mm)	8898-3	—	—	—	8880-3
Size 4	1 3/8" D x 2 3/4" W x 3 3/8" H (35mm x 70mm x 86mm) Fits Motorola MTX/Radius/3000/3500	8898-4	7498-4	7499-4	8897-4	—
Universal Radio Case		8880-6	—	—	8880-4	—
Extra Swivel Belt Loop Only—fits all models		8880-9	8880-9	8880-9	—	8880-9





### Remote Microphone Carrier for Epaulet

- Positions microphone for easy, one-handed operation; no need to look down while talking.
- Snaps around epaulet.
- Versatile—offers snap, Velcro® and Delrin® loop to accept remote microphone with variety of attachments.



#8880-8

### Blackberry/PDA Case

- Case will now hold your Blackberry and PDA devices!
- Also accommodates the Motorola TalkAbout® series of two-way radios and similar models, and some Nextel® phones.
- Case will also hold Voice Recorders.
- Size 4 1/2" x 2 1/2" x 1 1/4"  
Interior Dimensions (114 x 32 mm).

Cordura #8851-2  
Mirage Basketweave #7451-2



### Nokia Phone Case with Belt Clip

- Rugged, padded Cordura® phone case for popular Nokia® and similarly-sized cell phones.
- Fits right on your belt. Belt loop accepts up to 2 1/4" duty belts. A removable belt clip accepts up to 1 3/4" dress belts.
- Spring clip works even without belt.

Black #8855-1

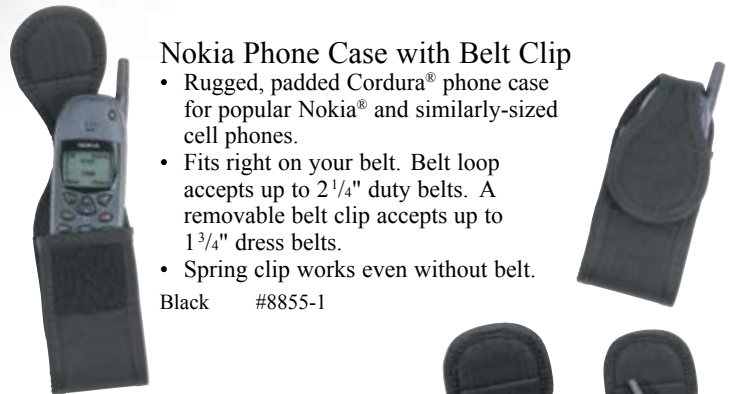

## Mags and knives fit these handy cases

### Single .380 Magazine/Knife Case

- Specially designed for single row .380 magazines, compact and subcompact 9mm magazines, small folding knives and multi-purpose tools.
- Cordura nylon exterior, closed-cell foam core and polyester knit interior.
- Molded belt loop for vertical carry on belts up to 2 1/4".

Black #8893-1



### Universal Single Pistol Magazine/Knife Case

- Cordura® nylon outer shell.
- Back wall padded for comfort; padded flap knit lining and Velcro closure.
- Fits most standard 9mm, .40 and single row .45 and 10mm magazines.
- Ideal for carrying large folding knives.
- Belt loop fits belts up to 2 1/4" for vertical carry; up to 1 1/2" for horizontal carry.

Black #8832-1



### Pager Cases

- Water resistant case with molded belt loop fits belts up to 2 1/4".
- Two sizes fit most common pagers, with or without their belt clips attached.
- Also holds clip-on lights for pistols.
- Medium case accepts many smaller-sized cell phones.



SIZE	Cordura	MIRAGE Plain	MIRAGE Basketweave
Small (3" x 2" x 1" I.D.)	8852-1	—	—
Medium (3 1/2" x 2" x 1" I.D.)	8853-1	7453-1	7453-2

### All-Purpose Belt Pouch

- Made of durable, water-resistant Cordura nylon.
- Single compartment pouch.
- 7" wide, 4 3/4" high, 1 1/2" deep, expanding to 3".

Black #8838-1





### Neoprene Butt Stock Shell Holders

- Heavy-duty neoprene sleeve stretches over gun stock.
- Non-slip surface for improved gun handling.
- Sewn-on elastic loops secure ammo.

Rifle (6 loops) #8848-3  
 Shotgun (5 loops) #8849-3



### Butt Stock Shell Holders

- Two styles—open or with flap.
- Elastic sleeve slips over rifle or gun stock.
- Sewn-on elastic loops secure ammo.
- Flap models have Cordura nylon flap that folds from bottom and is secured by Velcro.

#### Open Style

Rifle (9 loops) #8848-1  
 Shotgun (5 loops) #8849-1

#### Flap Style

Rifle (6 loops) #8848-2  
 Shotgun (5 loops) #8849-2



## Slings For Law Enforcement

### Tactical Shotgun Sling

with Swivels

- 1 1/4" nylon web tactical sling with sewn-in swivels. See page 9 for details.



### Mountain Sling

- 1 1/4" nylon web sling with Super Swivel® sewn on both ends; non-slip lining.



### Utility Sling

- 1" nylon web with adjustment buckle.



### Ultra® Sling

- Padded Cordura® 1" nylon sling.
- Stitched, quilted non-slip shoulder pad.



### Rifle Cartridge Sling

- Padded 1" nylon sling carries 6 cartridges.



### Shotgun Cartridge Sling

- Carries 4 shells vertically.



### Leather Military Sling

- Designed for shooting accuracy in prone or kneeling position.



### 3-Point Tactical Sling

- Converts easily from a carry to a shooting sling. See page 8 for details.



### Law Enforcement Slings

MODEL	LENGTH	WIDTH	ITEM NO.
Tactical	—	1 1/4"	2699-3
Mountain	48"	1 1/4"	2692-3
Utility	48"	1"	2670-2
	48"	1 1/4"	2670-3
	72"	1"	2671-2
Ultra®	48"	1"	2676-2
	72"	1"	2674-2
Rifle Cartridge	48"	1"	2697-2
Shotgun Cartridge	48"	1"	2698-2
Military (leather)	—	1"	2611-2
	—	1 1/4"	2611-3
3-Point Tactical	—	1 1/4"	2699-2

# Swivel Sets

## Premier Swivel

For decades, Uncle Mike's has led the way with our full line of QD® Quick Detachable Sling Swivels. Drawing from the enhanced safety of our patented screw-down Super Swivel and the enhanced performance of our solid loop Mil-Spec model, the Premier Swivel is low profile, strong and silent. Covered by the sling to which it attaches, noise and glare are all but eliminated.

Set No. 1400-2  
LoPro Patent No. 6,536,154

## Mil-Spec Swivel Set

QD SS MIM  
Developed at the request of the U.S. Military, these 1/4" Mil-Spec Parkerized swivels were designed to meet their strength and surface treatment standards.

Set No. 1402-3

## Tri-Lock® Swivel

The registered Tri-Lock® represents another advance in QD Quick Detachable Swivel design by Uncle Mike's. Building upon the closed link of the original QD Swivel and the patented SwiveLock® of the Super Swivel, this adds a third locking mechanism to offer optimum security against accidental opening. Tri-Lock also stops the metal swivel body from contacting the gun to reduce noise transmission.

QD SS BL  
1" Loops – Blued Set No. 1403-2  
1/4" Loops – Blued Set No. 1403-3  
1" Loops – Nickel-Plated Set No. 1093-2  
1/4" Loops – Nickel-Plated Set No. 1093-3

## Push Button Detachable Swivels

QD 100  
Special flush-mount front and rear bases for stud-free profile when sling and swivels are removed.  
Set No. 1011-2

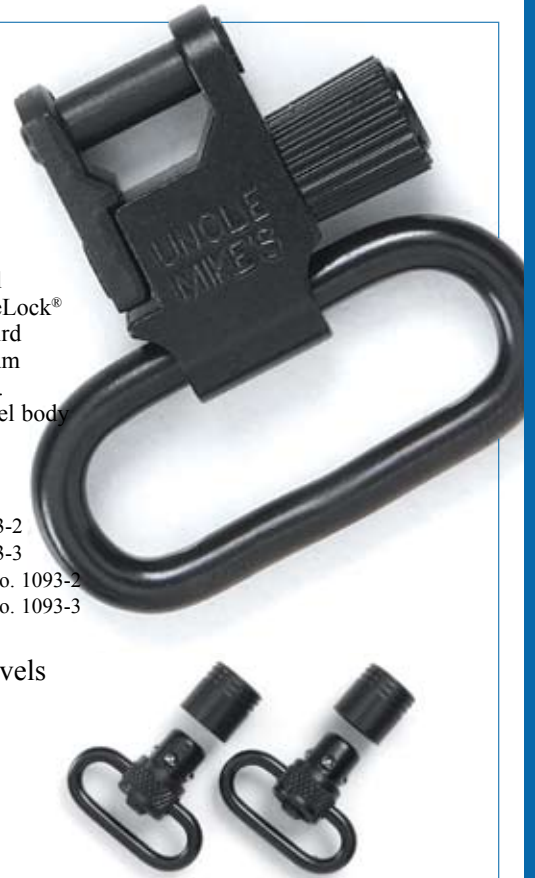

## Slotted Sling Mount QD Swivel Assembly

- Attaches QD Swivels to slotted mounts on specialty shotguns.
- Allows conventional mounting of sling.
- Eliminates "roping" or gathering problems common to slotted designs.

Set No. 1089-2



## QD Magazine Cap Swivel Sets for Pump and Auto Shotguns

These swivel sets include a replacement magazine cap with a swivel base for most pump and auto shotguns.

Remington 870 Express QD REM-870 EXP CAP	12 Ga.	Set No. 1800-2
Remington 870 QD REM-870 CAP	20 Ga.	Set No. 1800-5
Remington 870 QD REM-870 CAP	12 Ga.	Set No. 1801-2
Remington 870 QD REM-870 CAP	20 Ga.	Set No. 1801-5
Remington 1100 QD REM-1100	12 Ga.	Set No. 1802-2
Remington 1100 QD REM-1100	20 Ga.	Set No. 1802-5
Remington 11-87 QD REM-11-87 CAP	12 Ga.	Set No. 1803-2
Remington 11-87 QD REM-11-87 CAP	20 Ga.	Set No. 1803-5
Mossberg 500 QD MOSS-500 CAP	12 Ga.	Set No. 1810-2
Mossberg 500 QD MOSS-500 CAP	20 Ga.	Set No. 1810-5
Mossberg 590/835 QD MOSS-590/835 CAP	12 Ga.	Set No. 1811-2
Winchester 1200/1300 QD WIN-1200/1300 CAP	12 Ga.	Set No.



## Swivels for Police Shotguns

### QD 115 UPSFL

For shotguns with flashlights. Two Super Swivels plus special mounting bracket for Remington, Mossberg and Winchester pumps with extended magazines. Bracket holds a 1" diameter flashlight such as the Sure Fire® L-30.  
Set No. 1673-2

### QD 115 UPS

Two Super Swivels plus hardware for Remington 870P Shotguns with factory and after-market extended magazines.  
Set No. 1671-2

### QD 115 UPS II

Two Super Swivels plus hardware for Mossberg 500 and 590, Remington 1100 and 11-87, and Winchester 1200 and 1300 with factory and after-market extended magazines  
Set No. 1672-2



## Cartridge Slides

- Keeps your ammunition organized.
- Fit all belts up to 2 1/4".
- Shell loops made of sturdy elastic sewn to tough nylon web backing.

Handgun (6 loops) #8840-1  
Shotgun (6 loops) #8847-1  
Rifle (10 loops) #8841-1



## Folding Handgun Cartridge Carrier

- Keeps ammunition dry, protected and out of sight.
  - Lift Velcro® secured flap and the carrier with 12 loops folds down.
  - Fits all belts up to 2 1/4".
- Cordura #8844-1



# Take it with you! Uncle Mike's makes moving gear easier than ever!

All Uncle Mike's bags and gun cases are built tough to withstand all the needs of the police and military professional. We use the finest 1200 denier PVC-coated nylon fabric to offer superior scuff resistance and water repellency. All zippers are heavy duty and provide dual locking tabs to keep your gear secure. For outstanding durability at reasonable prices, trust Uncle Mike's bags and gun cases.

## Police Briefcase with Hidden Holster Compartment

- Looks like a conventional briefcase, but the hidden compartment inside gives you ready access to a holster velcroed into the interior.
- Internal holster can be adjusted for most handguns and can be positioned to facilitate most drawing techniques.
- Firearm is easily reached, even with flap secured and rear compartment closed.
- Conventional in appearance, this expandable briefcase has a multi-use front panel for pens, keys, etc. plus pockets that are large enough for conventional writing tablets. A full-flap cover that secures with two quick-release buckles keeps all interior contents secure.
- Soft molded carry handle and detachable shoulder strap.

# 5255-1



Draw your gun directly through the Velcro®-sealed opening at the front of the bag



## Deluxe Range Bag

This is THE bag you want for the range because it's a workhorse. Durable with ample storage, you'll be able to load this bag with everything you need for a day of shooting.

- Easy entry—A roll-up double-zippered flap with hook-and-loop fastener secures the main compartment.
- Easy carry—Bag features over-the-shoulder strap with quick-release buckles and two web-constructed carry handles make this bag easy to tote.
- Secure—A padded pistol rug is included and it fits in one of two lockable side compartments. The other compartment is thickly padded.

Black #5241-1  
Ranger Green #5241-2

Dimensions: Main compartment 15" w x 9" h x 7" d  
(381 x 229 x 178mm).



## Wheeled Duffel Bag

If you're going out into the field for an extended time, you'll need a bag with this much carry room to get you there. And because it's on wheels, you won't be straining your back to get all your gear there.

- Huge center compartment and padded top-end compartment. Two full-length zippered side compartments—one is conveniently divided in half, the other offers generous storage. All compartments have lockable zippers.
- Internal tie downs in large center compartment keep your gear secured.
- Radius urethane wheels provide maneuverability and easy transport, even with the heaviest loads.
- Polymer "pull" handle with metal legs collapses completely into molded recess for travel.

Black #5245-1

Dimensions: Center compartment is 13 1/2" w x 27 1/2" h x 14" d (343 x 699 x 356mm).  
Top-end compartment is 13 1/2" w x 13 1/2" h x 2" d (343 x 343 x 51mm).



Urethane wheels provide better maneuverability than older designs

## Car Seat Organizer

Move your gear from the car to the station without missing a beat with this handy car seat organizer.

- Perfect for people who share vehicles because it can store everything at your fingertips, and then be moved quickly to facilitate other drivers.
- Sits flat against the seat to make its main compartments quickly accessible. Store notebooks, pens, even a 1-liter water bottle right in the bag.
- Zippered front compartment keeps items secure.
- Great quality and innovation, especially when compared to similar carryalls at twice the price!

#5256-1



## Field Bag

- Roomy carry bag with removable hard bottom and dual zippers.
- External pouches at both ends—one with a zippered compartment for carrying I.D.
- Large front and rear external zippered compartments; front has divider.
- Three-sided zipper on main compartment allows full access while keeping bag upright.
- Wrap-around web handle and removable shoulder strap.
- Lockable zippers.

#5248-1

Dimensions: Center is 10" w x 20 1/2" l x 12" h (254 x 645 x 305mm).  
Ends are 10" w x 12" h x 3" d (254 x 305 x 76mm).  
Front/Rear is 20 1/2" w x 9" h x 3" d (645 x 229 x 76mm).



## Tactical Equipment Bag

- Holds nearly 3 cubic feet of gear. Perfect for helmet, vest, fatigues and other items.
- Water repellent and reinforced construction will stand up to abuse and rugged conditions.
- Lockable zippers.

Black #5249-1  
Ranger Green #5249-3

Dimensions: Main compartment is 26" w x 14" h x 10" d (660 x 356 x 254mm).  
Zippered side pocket is 22" w x 13" h x 3" d (559 x 330 x 76mm).  
Two zippered end pockets are 9" w x 11 1/2" h x 3" d (229 x 292 x 76mm).



## Police Equipment Bags

- Choose wheeled or carry bags, each with rigid bottom, front, back and end panels.
- Top is heavily padded.
- Handle collapses for storage and will fit in most police lockers.
- Lockable zippers.

Police Equipment Bag #5247-1

Wheeled Police Equipment Bag #5247-2

Original Police Equipment Bag

Wheeled Police Equipment Bag



305 x 12" w x 12" h x 9" d (229mm)



Dimensions: Main compartment is 18 1/2" w x 12" h x 7 1/2" d (470 x 191mm) on Original Bag. Wheeled Bag is 18 1/2"

## Compact Duffel Bag

- Choose from plain, Police or Sheriff versions.
- Clear plastic I.D. holder.

Plain #5244-1  
Police #5244-2  
Sheriff #5244-3

Dimensions: 12" w x 26" l (305 x 660mm).



## Tactical Bag with Shoulder Straps

- Use as a duffel bag or a pack. This sturdy pack stands up to the rigors of tactical conditions.
- Wrap-around web carry handle and two padded, adjustable shoulder straps allow multiple carrying options.
- Special reinforced bottom panel increases abrasion resistance and water repellency.
- Lockable zippers.

#5249-2

Dimensions: Main compartment is 12" w x 31" h x 18" d (305 x 787 x 457mm).  
One end compartment is two-tiered with a 10" x 10 1/2" (254 x 267mm) zippered pocket behind a 5 3/4" x 7" (146 x 178mm) Velcro-sealed front



## Tactical Rifle Cases

- Full-length zipper opens case out flat for better access. Tab and loop can lock bag open.
- Adjustable web shoulder strap.
- Zippered accessory pouch for storage.
- Large case has five magazine pouches, medium case has three.
- Quick access center pocket.

Medium #5212-1  
Large #5214-1



Dimensions:  
Medium: 33" w x 10" h (838 x 254mm).  
Large: 41" w x 10" h (1041 x 254mm).

Medium Tactical Case shown at left

Large Tactical Case shown below



## Tactical Submachine Gun Case

- Heavy duty case designed specifically for HK collapsible stock MP-5 and similar weapons with magazine attached.
- Case opens at end to insert gun barrel first.
- Six magazine pockets covered with three Velcro® flaps.
- Large flapped pocket provides storage for essentials.

#5210-1

Dimensions: 24 1/2" w x 13" h (622 x 330mm).



## Police Gun Cases

- Medium Shotgun Case is sized to carry police shotguns with barrels up to 22" and other guns up to 42" long.
- Rifle cases designed to carry scoped or unscoped rifles (3 sizes).
- Large pocket on exterior of case.
- Full length lockable zipper opens case flat for use as a shooting mat.
- Wrap-around web carry handles.
- Available in Black.

Medium Shotgun Case (up to 42" length) #5205-1  
Small Rifle Case (up to 40" length) #5200-1  
Medium Rifle Case (up to 44" length) #5201-1  
Large Rifle Case (up to 48" length) #5202-1





FULL PROTECTION GLOVES

# Protect your hands in every situation with Armor Skins!

## The perfect duty glove

### Leather Shooting Gloves

- Black leather gloves with Lycra® inserts for flexibility.
- Rugged but lightweight leather lets you feel what you're touching and permits writing without removing gloves.
- Knuckles covered with leather to protect hands from cold and abrasion.

Small #00100 X-Large #00103  
 Medium #00101 XX-Large #00104  
 Large #00102



## Great for range days or bicycle patrols

### Half-finger Leather Shooting Gloves

- Half-finger design with extended middle finger to protect against sharp trigger-guards and rollback effects of revolvers.
- Gel padded palm assures that trigger reach and aim remain intact.
- Dampens vibrations on bicycles.

Small #00110 X-Large #00113  
 Medium #00111 XX-Large #00114  
 Large #00112



## Excellent sensitivity, yet still protective during searches

### Neoprene Gloves

- Searching for small objects? These flexible gloves allow you to feel subtle surroundings, without giving up durability.
- Non-slip material on fingertips, except trigger finger.
- Adjustable wrist closure and reinforced leather palm add to wearability.
- All-weather durability, even in wet conditions.

Small #00120  
 Medium #00121  
 Large #00122  
 X-Large #00123  
 XX-Large #00124



## Warmth and waterproofing in the same glove

### Insulated Neoprene Gloves

- Perfect working glove in cold, wet conditions.
- Thinsulate® technology lining keeps hands warm.
- Secondary liner of breathable waterproof Hipora®.
- Non-slip material on fingertips, except trigger finger.

Small #00130 X-Large #00133  
 Medium #00131 XX-Large #00134  
 Large #00132



## Real leather protection at an economical price

### Premium Leather Gloves

- Authentic rich cowhide leather makes these gloves look good on full uniform occasions.
- Thin enough to give sensitivity during searches, but still protective.
- Treated, water-repellent leather outer shell.
- Black, unlined.

Small #00140 X-Large #00143  
 Medium #00141 XX-Large #00144  
 Large #00142



## Protection wherever the job takes you

### Nomex Flight Gloves

- Flame and flash protective up to 800° F (427° C).
- Made to the standard of the US Mil Spec.
- Constructed of Dupont Nomex® fabric and thread.
- Soft leather palms and elongated cuffs for best protection.

	Black	OD Green	Sand
Small	#00150	#00160	#00170
Medium	#00151	#00161	#00171
Large	#00152	#00162	#00172
X-Large	#00153	#00163	#00173
XX-Large	#00154	#00164	#00174

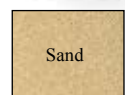



## Be ready for action whatever the conditions

### Searcher Gloves with Kevlar®

- 100% Kevlar fabric, covered with a synthetic leather on palm.
- Sure grip and weapon control comes from non-slip material in hand cradle.
- Back of hands feature 1.5mm neoprene and nylon Spandex® for a snug fit.
- Adjustable wrist closure.

Small #00180 X-Large #00183  
 Medium #00181 XX-Large #00184  
 Large #00182



## Premium leather with a cut-resistant lining

### Premium Leather Gloves with Spectra® Lining

- Premium aniline-dyed cowhide.
- Lining is made from 100% Spectra, known for its protection and cutting resistance.
- Extended wrist protects lower portions of arms.

Small #00190 X-Large #00193  
 Medium #00191 XX-Large #00194  
 Large #00192



## Water, fire and cut resistant!

### Tac Ops Gloves

- Kevlar shell provides cut resistance and flash protection to 800° F (427° C).
- Water resilient two-layer leather palms.
- Elasticized wrist keeps gloves snug.
- Hand cradle material gives exceptional gripability for weapons handling.
- Elongated cuffs for added protection.

	Black	OD Green	Sand
Small	#00200	#00210	#00220
Medium	#00201	#00211	#00221
Large	#00202	#00212	#00222
X-Large	#00203	#00213	#00223
XX-large	#00204	#00214	#00224



UNCLE MIKE'S  
LAW ENFORCEMENT

## Traffic duty just got a whole lot easier

### Traffic "S" and Traffic "T" Gloves

- No need for signs, your glove tells the whole story.
- Can be worn as a standalone glove or over other gloves.
- Traffic "S" glove has a red reflective Reflexite® STOP on palm. Back-side has lime/yellow reflective directional markers for traffic direction.
- Traffic "T" glove (not shown) has neon green directional signals on palm.
- Visible from 200-600 feet (60-183 m).
- Washable.

### Stop Sign/Triangles Gloves

Small/Medium #00230  
 Large/X-Large #00231

### Traffic T Gloves

Small/Medium #00240  
 Large/X-Large #00241



## Ultimate protection, superior grip and unbeatable performance

### The Protector Super Fabric® Gloves

- Black Kevlar backs to Spandex for added cut resistance over the entire hand.
- Exceeds NIJ's highest level category for cut and puncture/tear performance.
- Super-gripping action comes from a thin silicone pattern applied to palm and finger areas.
- Extremely flexible with superior gripping for apprehending and controlling suspects.

Small #00250 X-Large #00253  
 Medium #00251 XX-Large #00254  
 Large #00252



# Clean your gun faster, easier and keep it clean longer

## Hoppe's Elite® Gun Cleaner

Hoppe's Elite Gun Cleaner cleans down to the pores, removing layers of fouling and embedded carbon that has been there since your gun's first firing. With continued use, Hoppe's Elite conditions your bore to resist additional carbon fouling—making gun cleaning easier and faster. In fact, using Hoppe's Elite regularly can cut your gun cleaning time by up to 80%.

Plus, Hoppe's Elite is non-toxic and biodegradable, so you can literally clean your gun at your kitchen sink, without worrying about harmful chemicals and fumes.

2 oz.	#GC2	1 gallon	#GC1
4 oz.	#GC4	5 gallon	#GC5
8 oz.	#GC8	55 gallon	#GC55
32 oz.	#GC32		

Glock in a submersion tank containing Hoppe's Elite Gun Cleaner

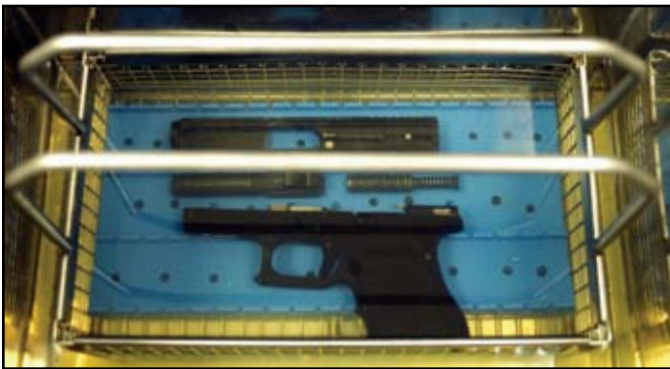

- Biodegradable
- Non-flammable
- Low odor
- Non-toxic

Side-by-side comparison shows how Hoppe's Elite cleans down to the pores



## Hoppe's Elite Gun Oil

Hoppe's Elite Gun Oil is the perfect match to our Hoppe's Elite Gun Cleaner. The oil uses super slick technology that eliminates puddling in the bore and instead creates a micro-fine layer of oil all over the surface. With this superior coating layer, you actually get better, longer-lasting protection throughout your firearm.

2 oz.	#GO2	5 gallon	#GO5
4 oz.	#GO4	55 gallon drum	#GO55
1 gallon	#GO1		

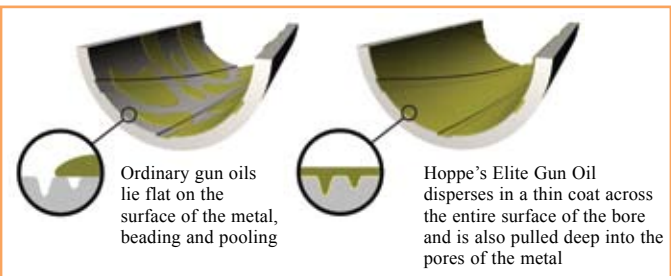

## Hoppe's Elite Bore Gel

For deep cleaning and metal conditioning, Hoppe's Elite Bore Gel is the right choice. Its thicker formula clings to the unique interior shapes within a bore to clean more deeply. It contains the same state-of-the-art aerosolvents, surfactants and other compounds found in Hoppe's Elite Gun Cleaner.

4 oz.	#BG4	5 gallon	#BG5
1 gallon	#BG1	55 gallon drum	#BG55

## **NEW** Hoppe's Elite Copper Terminator

Our new Hoppe's Elite Copper Terminator creates a powerful system when combined with Hoppe's Elite Gun Cleaner. The gun cleaner removes the carbon which typically slows the copper etching process. The Copper Terminator etches faster than standard ammonia-based products, which allows the gun cleaner (used intermittently in the process) to penetrate under the copper and remove it even faster.

- Works up to 4 times faster than other copper removal systems.
- Is ammonia free, virtually odorless, non-hazardous, non-flammable and can be shipped overnight.
- Is completely safe on bore steel.
- Does not leave ammonia-type crystals after use that can attract water from the air, expand and cause corrosion and/or microscopic stress fractures.
- Conditions the bore so copper does not build up as quickly.

2 oz.	#ECC2
4 oz.	#ECC4

### HOW HOPPE'S ELITE COPPER TERMINATOR WORKS

Here the surface carbon and copper fouling have been removed by Hoppe's Elite Gun Cleaner; exposing the "welded" copper attached to the bore. Hoppe's Elite Copper Terminator is needed to dissolve or etch the welded copper from the bore steel. Removal of the carbon allows for the copper cutter to "attack" from all angles. Etching of copper from above and below makes for maximum removal time and speedier cleanings.





# Introducing a new innovation in cleaning rods...

## **NEW** Hoppe's Elite Cleaning Rod System

If you have several firearms that need cleaning, you're going to love this new Hoppe's Elite cleaning rod concept that uses a single handle to accept all rod diameters and lengths. The handle is ergonomically designed and comfortable enough to handle even the toughest cleaning project. Change to a new rod length or diameter simply by pushing a button.



### Handle

- Push button attachment and detachment allows for quick changeovers.
- Precision ball bearings allow smooth rotation of rod.
- Accepts all rod diameters and lengths.

Hoppe's Elite Interchangeable Rods			
	Rod Length	Stainless Steel Item #	Coated Item #
<b>Rifle</b>			
.220 - 6.5mm	30"	ER2230S	ER2230C
.220 - 6.5mm	38"	ER2238S	ER2238C
.220 - 6.5mm	44"	ER2244S	ER2244C
.270 - .30+	30"	ER2730S	ER2730C
.270 - .30+	38"	ER2738S	ER2738C
.270 - .30+	44"	ER2744S	ER2744C
<b>Pistol</b>			
.22+	8"	ER228S	---
.22+	16"	ER2216S	---
Cleaning Rod Handle		#ECRH	

### Rods

- Available in all rod diameters and lengths: pistol, rifle and shotgun.
- Choose from stainless or coated rods. The stainless rods are manufactured from 17-4 stainless steel and the coated rods from high quality spring steel. Both rod materials offer exceptional yield and tensile strength to ensure that your rods remain straight and true through years of use. Stainless rods are polished to a micro-fine finish and coated rods employ a unique DuPont® hard epoxy coating for protection of rifling.
- Encased in a self-storing package for extra protection.
- Rods accept standard 8-32 threaded brushes and jags, and are long enough to use with a Hoppe's Universal Bore Guide.

Storage for Elite Cleaning Rods is easy, because each rod comes in its own clear acrylic tube, keeping the rods straight and true. Simply hang them on a peg board or workbench for quick access.



Handle attaches quickly to any Hoppe's Elite Cleaning Rod, and formed cushion grip assures comfort and ergonomic fit

With the Hoppe's Elite Cleaning Rod system, one single handle gives you access to a wide variety of cleaning rods, all at the push of a button. Quality ball bearing design and state-of-the-art engineering assure you can clean effortlessly, with perfect rod rotation and the strength you need.



## **NEW** Hoppe's Elite Foaming Gun Cleaner

Now get the excellent bore cleaning action of Hoppe's Elite in a foaming cleaner. This spray-on foam cleans deep into the bore, removing carbon and fouling better than ordinary cleaners. Hoppe's Elite Foaming Gun Cleaner is odorless, non-toxic, non-flammable and bio-degradable, so you can clean anywhere, even in unventilated rooms.

4 oz. #EFGC4



## Hoppe's Elite BoreSnake Cleaning Kit

Strap this onto your belt or put it in your bag the next time you head to the range. This soft-sided kit holds everything you need to quickly clean your gun, including the patented one-step Hoppe's BoreSnake, Hoppe's Elite Gun Cleaner and Hoppe's Elite Gun Oil.

- |              |        |              |        |
|--------------|--------|--------------|--------|
| .22 cal. kit | #EBS22 | 9mm kit      | #EBS9  |
| .40 cal. kit | #EBS40 | .45 cal. kit | #EBS45 |
| 12 ga. kit   | #EBS12 | .30 cal. kit | #EBS30 |
| 50 cal. kit  | #EBS50 |              |        |



# The most universally used solvent for over 100 years

## Famous No. 9™ Solvent

Our Hoppe's No. 9 remains the best-known remover of powder, lead, metal fouling and rust. Quick, super-efficient, safe and easy to use, Hoppe's No. 9 flows freely and penetrates rapidly. It's the standard of law enforcement agencies throughout the world!

### Size

2 oz. Bottle	#902
5 oz. Bottle	#904
5 oz. Bottle in Clamshell	#904B
2 oz. Aerosol	#905
Pint	#916
Quart	#932
Gallon Drum	#9501
55 Gallon Drum	#95050



## Specifically developed for Semi-Autos

### Semi-Auto Solvent

To remove copper, lead and powder fouling from today's high performance, semi-auto firearms, look no further than Hoppe's Semi-Auto Solvent. This cleaner leaves no trace of residue that can cause sticking or jamming in semis that are finely tuned. Perfect for competition shooters. Use on semi-autos or any firearm. 5 oz. bottle.

#SA904



## Eliminate copper quickly

### Bench Rest 9 Copper Solvent

Copper fouling, the bane of shooters, doesn't have to be a problem any longer—thanks to Hoppe's Bench Rest 9®. With this powerful solvent, copper fouling can be cleaned from the bore overnight, instead of taking the standard 3 to 4 days. Bench Rest 9 is safe and effective and contains no abrasives. Although the solvent is essentially a copper buster, it's also great for removing powder, lead and plastic fouling from rifles, shotguns, pistols and revolvers.

### Size

5 oz. Bottle	#BR904
5 oz. Bottle Clamshell	#BR904B
Pint	#BR916

# Keep your firearms working their best with quality Hoppe's lubricants

## Lubricating Oil

High viscosity oil refined to perfection for use in firearms, fishing reels and other precision mechanisms. Does not harden, gum or become rancid. Gives extra long service.

14.9 ml Precision Lubricator	#3060
2 1/4 oz Squeeze Bottle	#1003
2 1/4 oz. Squeeze Bottle Clamshell	#1003B
4 oz. Pump	#1004
4 oz. Aerosol	#1605
Pint	#1016
Quart	#1032
Gallon Drum	#10501

Left to right:  
Hoppe's Lubricating Oil in 2 1/4 oz. Squeeze Bottle, 4 oz. Pump, 4 oz. Aerosol, and 14.9 ml Precision Lubricator



## Moly works in extreme heat applications

### Moly Aerosol, Paste and Oil

A molybdenum disulfide compound, Hoppe's® Moly provides excellent lubrication under extreme heat and pressure. Bullets achieve higher velocities and greater accuracy. Also prevents wear and reduces fouling, making barrels easier to clean. Perfect for competition shooters. Use the paste and oil for coating bores, the aerosol for bores and bullets.

14.9 ml oil in Precision Lubricator	#3064
4 oz. Aerosol	#3068
3 1/2 oz. Paste (Pegboardable)	#3069



## Grease will protect firearms for storage

### Gun Grease

Specifically compounded for protecting idle firearms, Gun Grease displaces metal "sweat" when applied to bore or exterior metal. It also provides long-term protection when cleaning is delayed by lubricating moving parts and protecting them from corrosion. 1 3/4 oz. Tube.

#1102



### Dri-Lube

Dri-Lube reduces friction on metal and bearing surfaces, without sticky oils or silicones. Plus, Dri-Lube doesn't attract dust or dirt and it evaporates in seconds, leaving a dry lubricating film. Available in a 4 oz. Aerosol.

#DL1

### Moisture Displacing Lubricant

MDL drives out moisture while it cleans, lubricates, protects and prevents corrosion on metal surfaces. Ideal for immediate after-use protection of guns, fishing gear and most outdoor equipment. Prevents damage from moisture, salt and friction.

4 oz. Aerosol	#MDL
Quart	#MDL-32

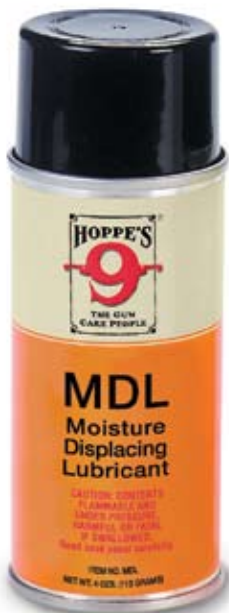

### Bench Rest Lubricating Oil with Weatherguard™

A proven winner for all shooters. Use before and after range practice to provide moisture and rust protection. Unlike conventional lubricating oil, Hoppe's Bench Rest Lubricating Oil with Weatherguard contains a moisture-fighting agent that drives moisture out while lubricating your firearm. Available in 2 1/4 oz. Squeeze Bottle.

Squeeze Bottle	#BR1003
Squeeze Bottle with Clamshell	#BR1003B

# Only the BoreSnake cleans, brushes and swabs in a single pass

BoreSnake®, quite simply, is the “World’s Fastest Gun Bore Cleaner” and never before has something so simple made such an impact in the shooting industry. The revolutionary single-piece BoreSnake takes the hassle and mess out of cleaning rifles, pistols and shotguns. One or two pulls of the BoreSnake and you get a shiny clean bore that’s ready for more action. Ideal for quick cleans or for cleaning in the field. Add a few drops of Hoppe’s No. 9™, Hoppe’s Elite® or Hoppe’s Lubricating Oil and your bore is ready for storage. Don’t be fooled by imitators, BoreSnake is the only patented one-piece system on the market. It comes in all the most popular calibers and gauges. A brass weight on the pull cord has the size stamp. Machine washable. See chart below for sizes.



## Give a soldier the perfect tool to clean his weapon

Project BoreSnake provides U.S. Soldiers and Marines with Hoppe’s BoreSnake Cleaning Kits. This 501-c 3 non-profit group sends kits to any named soldier serving in Iraq or Afghanistan.

Soldiers receive a kit with the appropriate sized BoreSnake for their weapon, along with Hoppe’s Elite Gun Cleaner and Hoppe’s Elite Gun Oil. The kits make gun cleaning easier and faster for the soldiers and they work well against the sand and elements that get trapped in their military firearms.

To learn more about Project BoreSnake or to make a donation, log on to [www.projectboresnake.org](http://www.projectboresnake.org).

Dear Projectboresnake.org,

Thanks so much for the cleaning kit. One of my Soldiers received several kits and passed them out to others. The sands and elements are hell on weapons and the BoreSnake and Hoppe’s [Elite] are excellent for getting my weapons clear quickly. As you know the M16 and M4’s have tight fits and any dirt or grime makes the weapons difficult to fire. Being able to quickly clean the action of the weapons with a kit that fits in my pocket keeps my weapons ready.

Major M.L.,  
Camp Summerall, Iraq

### BoreSnake Cleaner Fit Guide

#### Rifles

ITEM NO.	CALIBER
24009	.177 Airgun (no brush)
24010	.17 cal. Centerfire & .17HMR
24011	.22 cal. Centerfire & Rimfire, .223
24012	6mm, .243 caliber
24013	.25, 6.5mm, .264 caliber
24014	.270, 7mm, .284, .280 caliber
24015	.308, 30-30, .30-06, .300, .303 caliber
24016	.32, 8mm caliber
24017	.338, .340 caliber
24018	.35, .350, .357, .358, .375 caliber
24019	.416, .44, .45-70, .458, .460 caliber
24020	.50, .54 caliber
24025	.204 caliber
<b>NEW</b> 24026	.25mm

#### Gas Guns

ITEM NO.	CALIBER
24040	37mm, 40mm Gas Guns

#### Pistols & Revolvers

ITEM NO.	CALIBER
24000	.22, .223, 5.56 caliber
24001	.30, .32 caliber
24002	.380, 9mm, .38, .357 caliber
24003	.40, .41 caliber
24004	.44, .45 caliber

#### Shotguns

ITEM NO.	GAUGE
24031	.410 gauge
24032	28 gauge
24033	20 gauge
24034	16 gauge
24035	12 gauge
24036	10 gauge
24037	Paintball Marker (no brush)

Note: Blue text indicates popular law enforcement sizes



## BoreSnake Soft-Sided Gun Cleaning Kit

A complete BoreSnake Gun Cleaning Kit in a rugged, soft-sided case that attaches easily to a belt or fits compactly into a box or bag. Kit includes BoreSnake, Hoppe’s No. 9 Solvent, Hoppe’s Lubricating Oil, Hoppe’s Weatherguard Cloths and Pulling Tool.

### BoreSnake Soft-Sided Kit

ITEM NO.	FITS
34002	.357-38mm, 9 mm cal. Pistols
34004	.44, .45 cal. Pistols
34010	17 HMR Rifles
34011	.22 cal. Centerfire/Rimfire Rifles, .223, 5.56 cal.
34014	.270-7mm cal. Rifles
34015	.30 cal. Rifles
34033	20 ga. Shotguns
34035	12 ga. Shotguns
34040	Gas Gun

Note: Blue text indicates popular law enforcement sizes

## Here’s how the BoreSnake works...



Main Floss area provides 160 times more surface area than a “patch.”

Brass Weight slips easily through the barrel. Grasp and pull cleaning cord through bore. Stamped for identification of caliber or gauge.

Bore Brush, with bronze bristles embedded in cord, loosens hard deposits.

First Floss area removes foreign particles prior to the scrubbing action of the brush.

# Hoppe's Cleaning Kits with Aluminum Rods

Cleaning kits are some of our most popular items because they make so much sense for so many people. You'll find our kits contain everything you need to get your firearm as clean as it can be. From solvents to lubricating oils, patches, slotted ends and brushes, Hoppe's cleaning kits come complete with the elements you need for shooting and/or storage. We offer kits in plastic reusable boxes with instructions mounted right in. They make storing your components easy. Or if you want a more economical cleaning kit, select from a Hoppe's clamshell kit—each has the same accessories, except for the plastic storage box.

Here's what's included in Hoppe's Cleaning kits:

- Hoppe's No. 9 Solvent, 2 oz.
- Hoppe's Lubricating Oil, 2.25 oz.
- Patches, square die-cut patches for an absorbent surface with deep cleaning
- Slotted ends and adapters, where appropriate
- Aluminum Cleaning Rods



## Rifle Cleaning Kit

Includes a brush to fit your specific caliber.

Calibers	Box	Clamshell
.22, .222, .223, .224, .225	U22	U22B
.243, .25, .25-06, .257, 6mm, 6.5mm	—	U243B
.270, 7mm, .280	—	U270B
.30, 30-06, 30-30, .303, .308, .32, 8mm	U30	U30B

## Shotgun Cleaning Kit

Includes a brush to fit your specific gauge, unless otherwise noted.

Gauges	Box	Clamshell
12 gauge	SGO12	SGO12B
20 gauge	—	SGO20B
All gauges (brushes not included)	SGOU	SGOUB

## Rifle & Shotgun Cleaning Kit

No brushes included.

Calibers/Gauges	Box	Clamshell
All calibers and gauges (brushes not included)	UO	UOB

## Pistol Cleaning Kit

Includes a knob and brush.

Calibers	Box	Clamshell
.22	—	PCO22B
.38, .357, 9mm	PCO38	PCO38B
.40, 10mm	PCO40	PCO40B
.44, .45	PCO45	PCO45B
All calibers (brushes not included)	PCO	PCOB

"I love the smell of Hoppe's in the morning."  
American Handgunner  
June 2005



## Universal Field Cleaning Kit

This handy Universal Kit works equally well for pistols, rifles and shotguns. Accessories are neatly packed into a rugged soft-sided case that attaches easily to a belt or fits compactly into a box or bag. Contains all necessary accessories, except brushes, with plenty of added

room for things like Hoppe's silicone cloth and cleaning brushes.

Specially designed cleaning rod uses single rotating handle for all types of firearms. Great when you can't pack a full-size Hoppe's cleaning kit.

#FC2

## Premium Universal Field Kit

Bring all your cleaning supplies and accessories to the range in this soft-sided version of our popular wooden Bench Rest Premium Gun Cleaning Kit. This full-sized field cleaning kit has everything you need, plus extra room to add your personal tools. Kit includes: No. 9™ Solvent, Lubricating Oil, assorted gun cleaning patches, 3-piece solid brass cleaning rod, 3 slotted ends, 2 adapters, 5 popular phosphor bronze cleaning brushes, silicone cleaning cloth, phosphor bronze utility brush, bore light, 12" x 36" gun cleaning mat, and Hoppe's "Guide to Gun Care."

#DFC

# Count on Hoppe's to give you the components and accessories you need for the deepest cleaning

## Premium One-Piece Graphite Rod

No longer do professionals have to fear inadvertent metal contact that can harm fine rifling and affect accuracy. These new one-piece graphite cleaning rods were created by Hoppe's to eliminate worries. Combining high strength and light weight, these rods are 100% graphite, not coated metal that can chip and peel. The advanced design has a comfortable, ergonomic handle, too—the rifle rod even rotates to follow delicate barrel rifling. Length 36".

Rifle #RG1R  
Shotgun #RG1S

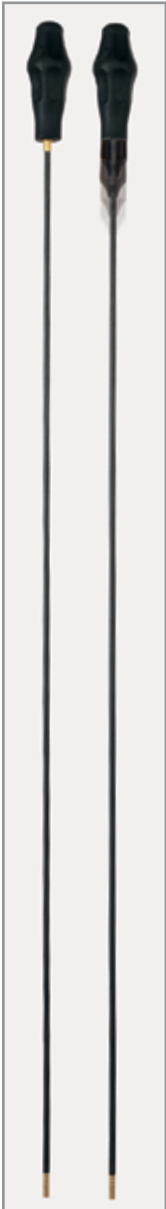

The Bore Guide prevents damage caused by misalignment, which protects precision crowning.

## Nylon and Phosphor Bronze Brushes

Nylon brushes will handle most cleaning jobs and the built-in memory makes the bristles return to their original shape, so the brushes can be used over and over again. Nylon offers a unique scrubbing action for a thorough cleaning. Phosphor bronze brushes are available in the same styles and calibers as the nylon, but these brushes are most effective on lead.



## Tornado Brushes

Known as "The Gunsmith's Brush," the Tornado brush has a special spiral-wound design that's highly effective for cleaning bores. The stainless steel loops eliminate any bristle ends that could leave scratches, yet still removes fouling without damaging the bore.



## Cleaning Swabs

100% cotton swabs are soft, washable, and will not scratch smooth shotgun bores. Swabs available for all gauges and most rifle calibers.



### Cleaning Swabs

ITEM NO.	GAUGE/CALIBER	ITEM NO.	GAUGE/CALIBER
1317	.410 gauge	1321	.22/.270 caliber
1317A	28 gauge	1322	.280/.32 caliber
1318	20 gauge	1323	.35/.375 caliber
1319	16 gauge	1324	.40/.45 caliber
1320	12 gauge	1325	17 HMR/.204

## NEW Muzzle Guides

Protect your muzzles from rod and cleaning handle scrapes with these muzzle guides. They fit right into the bore.

Rifle #RMS  
Shotgun #SMS



## NEW Universal Bore Guide

The Universal Bore Guide is just what's needed to properly clean almost any caliber of centerfire bolt-action firearm. Three interchangeable chamber tips fit bore sizes from .17 to .416 caliber. Aluminum Action Collar fits .695"/.700" (17.65mm/17.78mm) diameter bolt actions of any action length. Threaded Brass Pin locks the guide into the action in place of the bolt to allow proper cleaning from the breech.

#UBG



### Phosphor Bronze & Nylon Brushes

NYLON RIFLE	PHOSPHOR BRONZE	GAUGE/CALIBER
1301	1301P	6mm
1302	1302P	.17 cal, Centerfire/17HMR/.204
1303	1303P	.22 caliber
1304	1304P	.270 caliber/7mm
1305	1305P	.30 caliber
1309	1309P	.35 caliber/9mm
1310	1310P	.243/.25 caliber
1315	1315P	.44/.45 caliber
1316	1316P	.375 caliber

### PISTOL

1306	1306P	.22 caliber
1306A	1306AP	.32 caliber
1307	1307P	.38 caliber
1307A	1307AP	9mm
1308	1308P	.44/.45 caliber
1308A	1308AP	.40 caliber/10mm

### SHOTGUN

1311	1311P	.410 gauge
1311A	1311AP	28 gauge
1312	1312P	20 gauge
1313	1313P	16 gauge
1314	1314P	12 gauge
1314A	1314AP	10 gauge

### Tornado Brushes

ITEM NO.	GAUGE/CALIBER	PISTOL	ITEM NO.	GAUGE/CALIBER
1256		1256		.38 caliber
1250	.22 caliber	1257		.44/.45 caliber
1251	.30 caliber	1258		.40 caliber
1252	.35 caliber/9mm			
1253	.243/.25 caliber			
1254	.270 caliber/7mm	1260		12 gauge
1255	.32 caliber	1261		16 gauge
		1262		20 gauge
		1263		.410 gauge

## 3-Pack Brush/Swab Kits

What could be easier? Our 3-packs give you a cleaning swab, a Tornado brush and a Phosphor Bronze brush all in the same caliber or gauge—and all in the same package!



ITEM NO.	GAUGE/CALIBER	ITEM NO.	GAUGE/CALIBER
1451BK	.357/9mm	1456BK	.30 caliber
1452BK	.44/.45	1458BK	20 gauge
1454BK	.22 caliber	1459BK	12 gauge
1455BK	.270/7mm		

## Patches

Uniformly woven patches. Pre-cut caliber and gauge sizes for optimum cleaning performance.



### Standard Patches

ITEM NO.	CALIBER	#PER PAK
1201	No.1 Small Bore, 17 HMR, .204	60
1202	No.2 .22 to .270 caliber	60
1203	No.3 .270 to .35 caliber	50
1204	No.4 .38 to .45 caliber and .410 to 20 ga.	40
1205	No.5 16/12 gauge	25

### Bulk Patches

ITEM NO.	CALIBER	#PER PAK
1202S	.22 to .270 caliber	500
1203S	.270 to .35 caliber	650
1204S	.38 to .45 caliber and .410 to 20 ga.	500
1205S	16/12 gauge	300

## Assorted Competition Targets

All targets are printed to precise specifications on special target tag board or paper. Targets are shrink wrapped 20 per package or 100 per package (bulk).

SHRINK WRAPPED 20/PKG.

### Rifle

ITEM NO.	DESCRIPTION
A-1	50 ft Junior Rifle Single Bull 7 x 9 Paper
A-5	50 ft Five Bulls 7 x 9 Tag
A-9	50 yd Single Bull 7 x 9 Paper
A-10	50 yd Two Bulls 9 x 14 Paper
A-14	100 yd Small Bore Single Bull 14 x 14 Paper
A-17	50 ft 11 Bulls 10 1/2 x 12 Tag

### Pistol

ITEM NO.	DESCRIPTION
B-1	25 ft Slow Fire 6 x 7 Tag
B-2	50 ft Slow Fire 10 1/2 x 12 Tag
B-3	50 ft Timed and Rapid Fire 10 1/2 x 12 Tag
B-7	50 yd Slow Fire Centers 10 1/2 x 10 1/2 Paper
B-9	25 yd Rapid Fire Center 10 1/2 x 10 1/2 Paper
B-16	25 yd Slow Fire Center 10 1/2 x 12 Tag
B-24	50 ft Rapid Fire Silhouette 12 x 20 Tag
B-27B*	Police Silhouette 35 x 45 Paper

\* Packed only in box of 100.

### Air Rifle and Pistol

ITEM NO.	DESCRIPTION
A-45	5 Meter Rifle Five Bulls 10 x 12 Tag
B-32	10 Meter Pistol Single Bull 7 x 8 Tag



## Self-Adhering Bullseye Dots

Bullseye Dots allow the shooter or archer to pinpoint the way to better groupings and scores. Available in three different sizes—for sighting-in rifles and target practice with slug shotguns and pistols.

ITEM NO. PACKAGE	SIZE	PER
#DOT1	1"	105
For sighting-in rifles & patching paper targets		
#DOT2	1" & 2"	35 of each
For target practice with slug shotguns/pistols		

## Fold-Up Sound Muffler—28 dB

Our best 28 dB Sound Muffler is available in a fold-up style for convenience and compact storage. Ideal for field use. Features durable ABS plastic ear cups with foam pillow inserts. Fully adjustable. Unique design folds into itself when not in use. Provides superior ear protection by muffling noise to 28 dB. #3092



## Sound Muffler—25 dB

Our 25 dB Sound Muffler is perfect for the range, trap and skeet, in the field or wherever superior sound protection is required. Constructed of durable ABS plastic ear cups with foam pillow inserts. Fully adjustable to fit all shapes and sizes when worn over the head, behind the neck/head, or under the chin. #3090



## Hoppe's Ear Plugs—25 dB

Many professional shooters prefer ear plugs to mufflers. Plugs allow freedom of movement and eliminate problems when shouldering or mounting firearms. Hoppe's Ear Plugs more than fit the bill. Industrial-grade ultra-soft polymer with flanged conical design offers superior protection against loud noises, with a soft, flexible fit. Handy plastic container with Hoppe's logo included. #3085



## Standard Safety Glasses

Can fit over standard eye glasses. Great for shooting and industrial work.

Yellow	#3070
Gray	#3071
Clear	#3073



## Comfort Fit Safety Glasses

A wide vision field and total comfort make these glasses a top choice.

Yellow	#3053
Gray	#3054
Clear	#3055



## Sport and Safety Glasses

Great for target shooting because no bottom frame gets in the way. Adjustable length bows.

Yellow	#3056
Gray	#3057
Clear	#3058



# Folding Stocks make shooting and storage easier

## Protector Shell Carrier Folding Stock

The Protector series of shotgun stocks has a shell carrier buttstock option for Remington, Mossberg and Winchester pump shotguns.

- Carry three 12-gauge shotgun shells in the stock.
- Wide, radiused comb assures comfort in shooting.



Finger formed pistol grip offers solid control and proper wrist positioning

## Solid Steel Folding Stock

Available for 12-gauge Remington, Mossberg and Winchester pump shotguns.

- Certain shotguns require replacement of forearms with a shorter version to allow shell ejection while stock is folded.



Stock in folded position

## Pistol Grip

Finger-formed pistol grip has raised checkering for solid control and proper wrist positioning for 12-gauge shooting. Available for Mossberg, Winchester and Remington shotguns.



Standard Blued Folding Stock

## Folding Stock

### Ruger Mini-14, MiniThirty

Black pistol grip with raised checkering offers solid control while shooting. Lightweight folding design. Fits Mini-14 and MiniThirty, 181 series to present, does not fit Model 180. Drop in fit, no gunsmithing required. Not shown.



Pistol Grip



Ruger® Pistol Grip Stock

### Folding Stock Fit Information

Mossberg® 500®/590  
 Shell Carrier Folding Stock #FS-MOS  
 Blued Folding Stock #FS-MB  
 Shotgun Pistol Grip #24021

Remington® 870™  
 Shell Carrier Folding Stock #FS-REM  
 Blued Folding Stock #FS-RB  
 Shotgun Pistol Grip #24023

Winchester® 1200/1300  
 Shell Carrier Folding Stock #FS-WIN  
 Blued Folding Stock #FS-WB  
 Shotgun Pistol Grip #24022

Ruger M-14/30® Models\*  
 Pistol Grip Blued #PS14-B  
 Pistol Grip — Stainless #PS14-S

\* Fits Mini-14 or MiniThirty® 181 series to present, does not fit Model 180.

## NEW LULA All-In-One Magazine

### Speed Loader & Unloader

Protect your fingers and your mags! Simply attach the Butler Creek LULA loader on top of your magazine to easily load and unload rounds. Butler Creek has exclusive distribution rights in the United States for these, the World's #1 Loaders! LULA is a trademark of Maglula Ltd. and is used by permission. Made in Israel.

- #24215 Fits: M-16/AR-15
- #24216 Fits: AK-47/GALIL
- #24217 Fits: MP5
- #24218 Fits: Colt 9 SMG
- #24219 Fits: UZI
- #24220 Fits: M1A/M14/AR10
- #24221 Fits: FN FAL

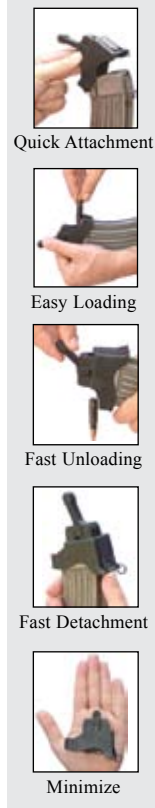

Quick Attachment

Easy Loading

Fast Unloading

Fast Detachment

Minimize



U.S. patent 6,810,616. International patents pending.

## NEW LULA BenchLoader™

If you're loading hundreds of mags each day, get the LULA BenchLoader and save yourself the time and the hassle of getting your rounds into a mag. It takes just seconds to drop 30 bullets from a box into a magazine. With this ingenious, patented system, you can examine and clean every round prior to loading.

- M16/AR15 USGI #24225
- H&K Metal SA80/M15/AR USGI #24226
- H&K XM8/G36 #24227
- GALIL #24228
- STEYR AUG & M16/AR15 USGI #24229





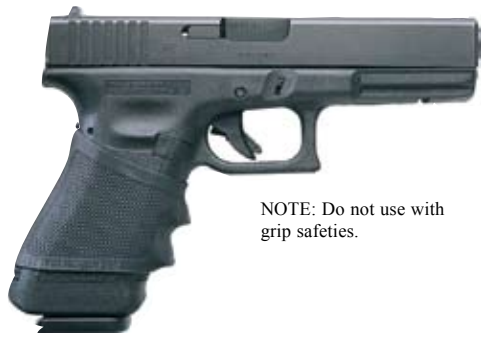

NOTE: Do not use with grip safeties.

### Slip-On Grips

Improve your control with virtually any pistol by slipping these grips onto the pistol stock. Medium and large size have finger grooves. Available in three sizes.

Small	Fits small and medium frame autos	#50541
Medium	Fits compact large frame autos	#50542
Large	Fits full size large frame autos	#50543

### Quick Carry™ Sling

Our Quick Carry Sling goes lightning fast from a carry position to a shooting sling. And one hand is all it takes to adjust! This versatile sling can be used in prone or marksman shooting positions and fits nearly everyone.

- Multiple carry positions — carry over shoulder or as a hasty sling.
- Installs quickly — no tools necessary. Includes Uncle Mike's famous locking swivels for safety and security.
- Fits everyone — adjusts from 27" to 36". Width is 1 1/4".
- **No carry fatigue** — thanks to a built-in thumb loop.

Black #80091

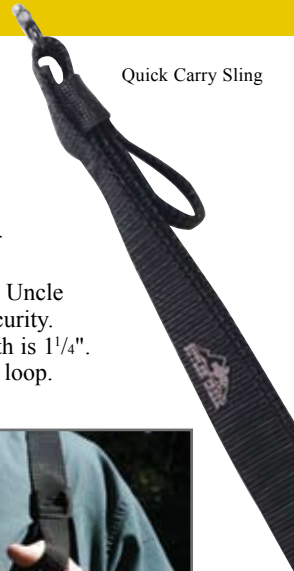

## The top choice of shooters for decades

### Flip-Open™ Scope Covers

Butler Creek's Flip-Open Scope Covers are custom fitted to your specific scope for maximum protection. Quiet opening lids flip open at the touch of your thumb and are virtually silent. The red button that opens the cover is ergonomically designed so that even the slightest pressure applied will open the lid allowing you to keep your eye on the target, without fumbling to open the scope cover.

Water-tight friction mounts anchor the covers to your scope while an airtight semi-o-ring keeps out dust and moisture that can damage and cloud your scope. In fact, our scope covers have been tested to perform from -40 degrees to 120 degrees.

- Design serves both right- and left-handed shooters.
- Weighs less than an ounce, but protects in the most extreme conditions.

See fit chart on Page 45.

For more fit information, please call customer service at (800) 845-2444.

### Flip-Open Spotting Scope Covers

The same easy flip-open technology and rugged durability of the standard scope covers that now fit spotting scopes as well. Just measure your spotter and order from the chart on Page 45.



Silent action hinge provides flawless performance in all weather

Inner o-ring provides an airtight seal to keep out dust and moisture

Ergonomic button design has a non-slip surface for one-touch action



Easily opens with the touch of a thumb for right and left-handed shooters

## **NEW** Protect your scope with these flexible fit scope covers

Butler Creek MultiFlex Flip-Open Scope Covers are spring-activated to give you the fast opening action you need. The tight, flexible collar prevents field of view blockage, eliminates accidental opening, and protects against snow, rain, dirt and dust.

Butler Creek MultiFlex Flip-Open Scope Covers are packed in dual kits containing perfectly sized eye and objective covers for most popular hunting scopes.

Measure both the outside diameter of the eye and objective ends of your scope and use the sizing information on page 45 to find the kit that works best for your scope.



# Get that shot! Bipods and monopods will steady your aim

## Telescoping Bipod

Maximize your ability to shoot accurately at any moment with the rigidity, steady support, versatility and portability you can only get from PoleCat® telescoping bipods. This bipod won't alter the gun's accuracy or damage the firearm like attached bipods can, thanks to a protective rubber over-molded yoke that protects your gun's finish.

Manufactured from high-strength, lightweight, tempered aluminum with a corrosion-resistant, satin black anodized finish. Legs quickly telescope up or down, then rigidly lock in place with a single half twist. Our exclusive Posi-Lock™ system guarantees a rock-steady hold and reliable, unlimited adjustments. Legs extend from 35" to 65". Weighs 18 oz.

Expedition Bipod #T2B65-BXX



## Telescoping Monopod

Our monopod may be the fastest way to set up a precise shot. Our PoleCat monopod is constructed of hard-tempered alloy aluminum and weighs only 11 oz.—but it's very strong and will give you years of durability. Plus, our patented Posi-Lock pole adjustment system is the strongest and most reliable locking system available.

The all-terrain carbide tip grips rock and ice and a removable rubber tip grips hard surfaces. Can be used standing or kneeling. Telescopes from 35" to 65".

Expedition Monopod #T2M65-VXX

## Folding Steady Stix II

Experience one-shot confidence when you shoot with rock-steady feather-light folding Steady Stix II. With Steady Stix, you get versatility on any terrain—a steady hold on a steep hillside or rooftop. More convenient, portable and versatile than attached bipods and won't change your point of impact.

To use, simply pull the tie cord that holds the Stix in a bundle. Legs automatically unfold and self assemble to their full height. Your sights level quickly, right on target, as you lay the forestock in the non-slip rubber V-yoke. Use sitting or kneeling. Three-section legs unfold from 14" to 39".

Steady Stix II #F3B39-R1X

To order Stoney Point Products  
Please call (507) 354-3360

**NEW**

## Rapid Pivot Bipod System

Introducing the quickest attaching bipod on the market today. The Rapid Pivot Bipod System snaps right onto your rifle stock, giving you instant set-up for an accurate shot.

This innovative bipod weighs less than more expensive and complex mechanical bipods, but it out-performs them with its pivoting action, flexibility and solid support. Use it in the prone, sitting, kneeling or standing positions.

- Quickly attach and detach from your forearm sling stud.
- Pivoting action allows you to follow target.
- Silent set-up.
- Accommodates prone, sitting, kneeling and standing positions.

Rapid Pivot Bipod Stock Attachment Hardware	#RPB-101
Rapid Pivot Bipod "Standing"	#T2B64-PXX
Rapid Pivot Bipod "Sitting/Kneeling"	#T2B43-PXX
Rapid Pivot Bipod "Prone/Bench"	#T2B13-PXX

Rapid Pivot Bipod  
Standing  
36" - 64" (91.44 - 162.56cm)  
Weighs 16 oz. (453g)

Rapid Pivot Bipod  
Sitting/Kneeling  
25" - 43" (63.5 - 109.22cm)  
Weighs 12 oz. (340g)

Rapid Pivot Bipod  
Prone/Bench  
10" - 13" (25.4 - 33.02cm)  
Weighs 8 oz. (227g)



The PoleCat Rapid Pivot Bipod System can pivot up to 360 degrees, allowing you to adjust your shot easily. The legs of the bipod move silently and independently, helping you accommodate any type of terrain.

**NEW**

### Rapid Pivot Monopod Attachment with Hardware

Hit those tough shots with the New PoleCat Rapid Pivot Monopod attachment that gives you extra flexibility and versatility when you need it. This attachment converts a hiking staff into a shooting rest, by clipping quickly on to your stock's swivel stud. The attachment allows you to immediately pivot your stock left or right, or make quick sighting adjustments by flexing up, down, left or right, and still allows you to use your sling. Includes all mounting hardware.

#RPM-102

**FYT**

The PoleCat Rapid Pivot Monopod Attachment turns a walking stick into a shooting rest by quickly attaching onto your swivel stud. It provides rock-solid support, but still gives you the flexibility to get tough shots.



The PoleCat Rapid Pivot Monopod Attachment gives you great flexibility, allowing you to pivot the stock left or right, up or down... all to get that important shot.



Get that shot — optimum versatility is what you get with the PoleCat Rapid Pivot Monopod Attachment.

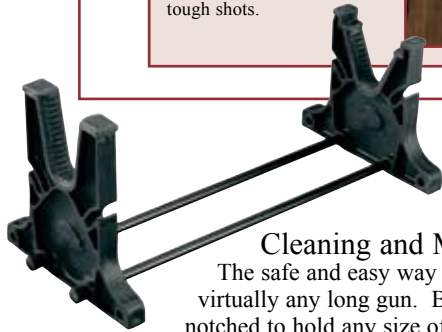

### Cleaning and Maintenance Cradle

The safe and easy way to clean, maintain or display virtually any long gun. Both sides of the cradle are notched to hold any size of cleaning rod. Adjusts for length and quickly disassembles without tools, for compact transport in your range bag or cleaning kit.

#CC-20

### Sight Lines Lens

This affordable, easy-to-use lens quickly determines scope alignment problems and makes scope installation faster, easier and more precise. Engraved lines on the lens allow the scope's vertical crosshair to be plumb with the bore as it squares the horizontal crosshair.

Simply place the lens directly on the opened bolt of the gun and slide it forward against the ocular lens. Hold in place with the furnished stretch cord. Plumb and square the scope with the lens, then secure the scope in place with the ring screws.

Lens fits bolt actions on Remington, Ruger, Savage, Winchester, Browning, Stolle, Mauser, Weatherby Vanguard and many others with .695"/700" bolts.

Sight Lines Lens #SL-12



Sight Lines Lens



Interchangeable Target Knobs

### Interchangeable Target Knobs

Stoney Point's Target Knobs thread-on in place of your scope's dust covers. They employ a stainless steel, spring-loaded, internal spindle, which has a screwdriver tip that mates with the scope's coin slot to provide fingertip control of the scope's internal adjustments.

Target Knobs install in minutes and are interchangeable with other scopes of the same manufacturer, all without disturbing your settings. Or, you can remove the Target Knobs and install your dust covers for "field-duty."

Leupold, pair #K-2L  
Tasco/Simmons/Sightron, pair #K-2T  
Burris, pair #K-2B

**NEW**

### Stoney Point Shooting Bags

Stoney Point Shooting Bags give you the extra support you need to make those long shots. New this year, these bags are constructed of durable 600 denier nylon and feature a non-skid bottom and a semi-smooth cradle that allows for gun recoil. All bags are available filled with polypropylene pellets to retard moisture buildup and molding.

Stoney Point Shooting Bags



1. Standard Rear Bag

#FSRB-10 Size: 7" l x 5.5" h x 5" w

Unfilled Bag: #USR-40

2. Standard Front Bag

#FSFB-25 Size: 7" l x 4.25" h x 5" w

Unfilled Bag: #USF-45

3. Compact Rear Bag

#FCRB-15 Size: 5.5" l x 4.5" h x 5.375" w

w

4. Bench Rest/Universal Front Bag

#FUFB-20 Size: 4.75" l x 2.5" h x 2" w

5. Stacker/Elbow Pad Bag

#FEPB-35 Size: 5" l x 4.5" h x 5" w

6. Marksman's Bench Rest - Non Skid Cradle

#FMBB-30 Size: 11.25" l x 10.75" h x 7.5" w



CALL US AT (800)845-2444 • VISIT US AT WWW.STONEYPOINT.COM

STONEY POINT® PRODUCTS



# HANDCUFF CASE FIT CHART

	SlimLine Cordura w/Flap	SlimLine Plain w/Flap	SlimLine Basketweave w/Flap	Cordura Single w/Flap	Plain Single w/Flap	Basketweave Single w/Flap	Cordura Double w/Flap	Basketweave Double w/Flap	Compact w/Flap	Open Top Belt Loop	Open Top Belt Clip
	8885-1	7458-1	7485-2	8878-1	7478-1	7478-2	8857-1	7457-2	8835-1	7792-1	8825-1
S&W #1 Chain	X	X	X						X		
S&W #100 Chain	X	X	X	X	X	X	X	X	X	X	X
S&W #300 Hinged	X	X	X	X	X	X	X	X	X	X	X
Peerless #700 Chain	X	X	X	X	X	X	X	X	X	X	X
Peerless #7030 Oversized Chain								X			
Peerless #801 Hinged	X	X	X	X	X	X	X	X	X	X	X
Hiatt #2020, 2015 Chain	X	X	X	X	X	X	X	X	X	X	X
Hiatt #2003, 2005 XL Chain				X	X	X	X	X	X	X	X
Hiatt #2050, 2075 Hinge	X	X	X	X	X	X	X	X			
Hiatt #2054, 2055, 3154, 3155 XL					X	X	X	X	X		
Hiatt Lightweight #3013, 3105 Chain	X	X	X	X	X	X	X	X			
ASP Cuff							X	X			

# LIGHT CASE FIT CHART

Finish Reference Guide		
Cordura	Mirage - Basketweave	Mirage - Plain
8818-1	7418-5	7418-1
8818-2	n/a	n/a
8818-3	7418-7	7418-3
8818-4	7418-9	7418-4
8815-1	7415-2	7415-1
8866-1	n/a	n/a
8867-1	7467-2	n/a
8863-1	7463-1	n/a
8862-1	7462-1	n/a



Type of Light	Model	Cordura								Mirage Basketweave				Mirage Plain									
		8818-1	8818-2	8818-3	8818-4	8815-1	8866-1	8867-1	8863-1	8862-1	7418-5	7418-7	7418-9	7415-2	7467-2	7463-1	7462-1	7418-1	7418-3	7418-4	7415-1		
Various	C cell								X														
Various	D cell									X													
Inova	T1	X									X										X		
Inova	T2		X																				
Inova	T3		X																				
Inova	T4					X					X	X										X	X
Inova	T5					X							X										X
Streamlight	3N	X									X										X		
Streamlight	Scorpion	X									X										X		
Streamlight	Strion	X									X										X		
Streamlight	NF2 LED	X									X										X		
Streamlight	TL2	X									X										X		
Streamlight	TL3		X																				
Streamlight	Jr. Lunox		X																				
Streamlight	Slinger			X					X		X	X		X							X		X
Streamlight	Poly-slinger				X	X					X	X		X							X	X	X
Streamlight	Slinger XT					X					X			X							X		X
Streamlight	Slinger XTHP					X					X			X							X		X
Streamlight	2AA Yellow		X								X			X									X
Streamlight	3C Yellow										X			X									X
Streamlight	4AA Yellow			X							X			X									X
Surefire	E2D	X									X										X		
Surefire	A2	X									X										X		
Surefire	22	X									X										X		
Surefire	6P	X									X										X		
Surefire	6R		X								X										X		
Surefire	8N0			X		X					X		X								X		X
Surefire	9N					X					X		X		X						X		X
Surefire	9P		X								X		X		X						X		X
Surefire	L7				X	X					X	X		X							X	X	X
Surefire	M2					X					X	X		X							X	X	X
Surefire	M3				X	X					X	X		X							X	X	X
Surefire	M3T					X					X	X		X							X	X	X
Surefire	M4					X					X	X		X							X	X	X
Pentagon	X2		X								X			X									
Pentagon	X3				X	X					X			X									
Pentagon	L2		X								X			X									
Pentagon	L3				X	X					X	X		X									
Pentagon	S2		X								X			X									

# BUTLER CREEK FLIP-OPEN SCOPE COVER FIT CHART

## Flip-Open Scope Cover Fit Specifications

MEASURE THE OUTSIDE DIAMETER OF THE EYE AND OBJECTIVE ENDS OF THE SCOPE.  
FIT RANGE IS .01 UNDER TO .025 OVER THESE MEASUREMENTS.

EYE PIECE				OBJECTIVE				OBJECTIVE			
SZ	INCHES	(MM)	PRODUCT#	SZ	INCHES	(MM)	PRODUCT#	SZ	INCHES	(MM)	PRODUCT#
02	1.225	31.1	20020	01	1.00	25.4	30010	26	1.820	46.2	30260
03A	1.300	33.0	20030	04	1.095	27.8	30040	27	1.840	46.7	30270
01	1.341	34.1	20010	02A	1.181	30.0	30025	28	1.890	48.0	30280
03	1.388	35.3	20035	02	1.221	31.0	30020	29	1.919	48.7	30290
05	1.432	36.4	20050	03A	1.300	33.0	30030	30	1.960	49.8	30300
07	1.457	37.0	20070	03	1.34	34.0	30035	31	1.998	50.7	30310
09	1.468	37.3	20090	05	1.387	35.2	30050	33	2.043	51.9	30330
09A	1.485	37.7	20095	07	1.429	36.3	30070	34	2.100	53.3	30340
10	1.516	38.5	20100	09	1.485	37.7	30090	39	2.220	56.4	30390
11	1.550	39.4	20110	10	1.500	38.1	30100	40	2.250	57.2	30400
13	1.570	39.9	20130	11	1.54x1.34	39.1x34.0	30110	43	2.310	58.7	30430
14	1.605	40.8	20140	12	1.76x1.53	44.7x38.9	30120	44	2.360	59.9	30440
15	1.66x1.45	42.2x36.8	20150	13	1.530	38.9	30130	45	2.410	61.2	30450
16	1.660	42.2	20160	15	1.558	39.6	30150	46	2.430	61.7	30460
17	1.675	42.5	20170	17	1.612	40.9	30170	47	2.461	62.5	30470
18	1.700	43.2	20180	19	1.646	41.8	30190	48	2.500	63.5	30480
19	1.730	43.9	20190	20	1.700	43.2	30200	51	2.575	65.4	30510
20	1.775	45.1	20200	21	1.735	44.1	30210	53	2.600	66.0	30530
21	1.70x1.42	43.2x36.1	20210	23	1.760	44.7	30230	53A	2.640	67.1	30535
				25	1.800	45.7	30250	54	2.725	69.2	30540

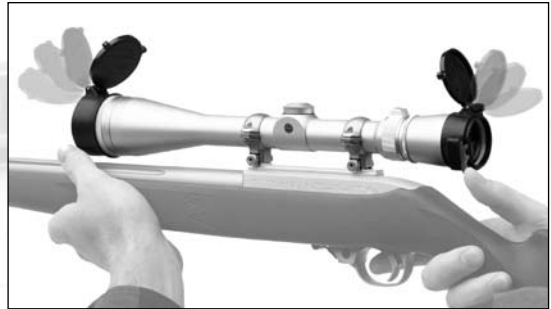

# BUTLER CREEK MULTIFLEX SCOPE COVER FIT CHART

MultiFlex Scope Covers				
If your EYE Outer Dimension measures	and your OBJECTIVE Outer Dimension measures	Set #	Black Set #	Silver
1.516"-1.550" (38.5-39.4mm)	1.530"-1.558" (38.9-39.6mm)		MF1013	MFS1013
1.516"-1.550" (38.5-39.4mm)	1.800"-1.840" (45.7-46.7mm)		MF1027	MFS1027
1.516"-1.550" (38.5-39.4mm)	1.960"-1.998" (49.8-50.7mm)		MF1030	—
1.516"-1.550" (38.5-39.4mm)	2.043"-2.100" (51.9-53.3mm)		MF1033	MFS1033
1.516"-1.550" (38.5-39.4mm)	2.310"-2.360" (58.7-59.9mm)		MF1043	MFS1043
1.570"-1.605" (39.9-40.8mm)	1.530"-1.558" (38.9-39.6mm)		MF1313	—
1.570"-1.605" (39.9-40.8mm)	1.800"-1.840" (45.7-46.7mm)		MF1325	MFS1325
1.570"-1.605" (39.9-40.8mm)	1.960"-1.998" (49.8-50.7mm)		MF1330	MFS1330
1.570"-1.605" (39.9-40.8mm)	2.310"-2.360" (58.7-59.9mm)		MF1343	MFS1343
1.660"-1.700" (42.2-43.2mm)	1.530"-1.558" (38.9-39.6mm)		MF1613	MFS1613
1.660"-1.700" (42.2-43.2mm)	1.800"-1.840" (45.7-46.7mm)		MF1625	—
1.660"-1.700" (42.2-43.2mm)	1.890"-1.919" (46.2-46.7mm)		MF1628	MFS1628

Also available in Silver!



# HOLSTER SELECTION GUIDE

		Gun Make and Model	Barrel Length	Holster Size														
				Ambidextrous Hip	Hip-Thumb Break	Paddle	Super Belt Slide	Pro-Pak® Horizontal	Pro-Pak® Vertical	Pro-Pak® Underover	PRO-3® Duty/Tactical	Dual Retention Duty/Tactical	Tactical/Flashlight/Laser	PRO-2® Jacket Slot	Inside-Pant Open	Ankle		
AMT	Autos	"Backup" "Backup" .45	2½"	—	1	1	—	—	—	—	—	—	—	—	—	—	10	10
		Skipper	3"	16	16	16	16	16	16	16	—	—	—	—	—	—	16	16
		Hardballer .45	4½"	—	19	19	19	19	15	15	15	—	—	—	—	19	15	—
ASTRA	Autos	A-70, A-75	3½"	16	16	16	16	16	1	16	—	—	—	—	—	—	16	—
		A-80, A-90, A-100	3¾"	15	15	15	15	15	1	15	—	—	—	—	—	—	15	—
AUTO ORDNANCE	Autos	Pitbull	3½"	16	16	16	16	16	1	16	—	—	—	—	—	—	16	16
		General	4½"	—	19	19	19	15	15	15	—	—	—	—	—	—	15	—
		1911 A1	5"	—	19	19	19	5	5	5	—	—	—	—	—	19	5	—
BAUER	Autos	.22, .25 Cal.	2"	—	—	—	—	—	—	10	—	—	—	—	—	—	10	10
BERETTA	Autos	20, 21, 950 Series, Bobcat, Jetfire, Minx	2½"	—	—	—	—	—	—	10	—	—	—	—	—	—	10	10
		Tomcat	2½"	10	—	—	—	—	—	—	—	—	—	—	—	—	10	10
		34, 70S, 70SP, 81, 82, 82B, 84, 84B, 84F, 85, 85B, 85F,	3½"-3¾"	1	1	1	1	1	1	1	—	—	—	—	—	—	1	1
		86, 87, 90, Puma, Jaguar	5"	5	5	5	5	5	5	5	20	20	5	20	5	—	—	—
		92, 92S, 92SB, 92D, 92F, 92G, 96, 96F, 92FS, Brigadier, 92FC	4½"	15	15	15	15	15	15	15	18	20	15	18	15	—	—	—
		92 Centurion, 96 Centurion, 92D Centurion, 96D Centurion	4½"	15	15	15	15	15	15	15	—	—	15	20	15	—	—	—
		92SBC, 92FM	4½"	15	16	15	5	15	5	5	—	—	20	—	20	5	—	—
		92 FS Vertec	4"	15	15	16	15	15	15	15	—	—	18	—	—	5	—	—
		PX-4 Storm	4"	15	15	16	15	15	15	15	—	—	18	—	—	5	—	—
		8000, 8040, 8045 Cougar, 9000	3½"	16	16	16	16	15	—	15	—	—	—	—	—	15	—	—
BERSA	Autos	Thunder 380, Series 95	3½"	1	1	—	1	1	1	1	—	—	—	—	—	1	—	—
BROWNING	Autos	BDA .380	3½"	1	1	1	1	1	1	1	—	—	—	—	—	1	1	—
		Hi-Power 9mm, .40	4½"	—	19	19	19	5	5	5	—	—	19	5	—	15	—	—
		BDM 9mm, BPM-D, BRM-DOA	4½"	15	15	15	15	15	15	15	—	—	22	15	—	15	—	—
		BDA 9mm .38 Super, .45 ACP	4½"	15	15	15	15	15	15	15	22	22	15	—	—	15	—	—
COLT	Autos	Mustang, Mustang Plus II, Mustang Pocketlite, Pony	2½"	1	—	—	1	1	—	1	—	—	—	—	—	10	10	—
		Officers ACP .45, Double Eagle Officers .45, 1991 A1 Compact	3½"	16	16	16	16	16	1	16	—	—	—	—	—	16	16	—
		380 Government Model, Gov't. Pocketlite, Pocket 9	3½"	1	1	1	1	1	1	1	—	—	—	—	—	1	1	—
		Commander, Combat Commander, Lightweight Commander,	4½"	—	19	19	19	15	15	15	—	—	19	15	—	15	—	—
		1991 A1 Commander	4½"	—	19	19	19	15	15	15	—	—	19	15	—	15	—	—
		Combat Elite, Delta Elite, Gov't. Model, Gold Cup,	5"	5	19	19	19	5	5	5	—	—	19	5	—	5	—	—
		Combat Target, 1991 A1, 1911	5"	5	19	19	19	5	5	5	—	—	19	5	—	5	—	—
	Revolvers	Agent, Cobra, Commando, Detective SPL, Lawman,	2"- 3"	—	0	0	0	0	—	0	—	—	—	—	—	0	—	—
		DSII/38 SPF VI	2"- 3"	—	0	0	0	0	—	0	—	—	—	—	—	0	—	—
		Commando, Lawman, Official Police, Marshall,	4"	2	2	2	2	2	2	2	—	2	—	—	2	—	—	—
		Metropolitan, King Cobra, Peacekeeper, Python,	4"	2	—	—	2	2	2	2	—	—	—	—	—	2	—	—
		Three-Five-Seven, Trooper, Mark III	4"	2	—	—	2	2	2	2	—	—	—	—	—	2	—	—
		Diamondback	4"	2	—	—	2	2	2	2	—	—	—	—	—	2	—	—
		Officers Model, King Cobra Peacekeeper, Official Police,	6"	—	3	—	—	—	—	—	—	—	—	—	—	—	—	—
		Python, Three-Five-Seven, Trooper, Mark III	6"	—	3	—	—	—	—	—	—	—	—	—	—	—	—	—
CZ	Autos	CZ83	3½"	1	1	1	1	1	1	1	—	—	—	—	—	1	1	—
		CZ75, CZ85	4½"	5	15	15	5	5	5	5	—	—	19	5	—	15	—	—
EUROPEAN	Autos	European .22, .380, .32	3.2"	1	1	1	1	1	1	1	—	—	—	—	—	1	1	—
AMERICAN		Witness Subcompact, FAB92	3.66"	16	16	16	16	16	1	16	—	—	—	15	—	16	16	—
ARMORY (EAA)		Witness, Witness Sport, Witness Combo, FAB92	4.7"	5	15	15	5	5	5	5	—	—	5	—	15	—	—	—
FN	Autos	49	4"	16	—	15	15	15	15	15	22	22	—	—	15	—	—	—
		5.7	5"	5	—	5	5	5	5	5	—	—	—	—	5	—	—	—
GLOCK	Autos	19, 23, 32	4"	16	21	21	16	16	15	16	21	21	15	21	16	16	16	—
		17, 22, 31	4½"	15	21	21	15	15	15	15	21	21	15	21	15	—	—	—
		20, 21	4½"	15	21	21	15	15	15	15	25	25	15	25	15	—	—	—
		29, 30	3¾"	16	21	16	16	16	15	16	25	25	—	25	16	—	—	—
		26, 27, 33, G28	3½"	1	—	16	12	16	—	16	—	—	21	—	—	12	12	—
		34, 35, 36	5½"	—	5	—	—	—	—	—	—	—	—	—	25	—	—	—
HK	Autos	P7, P7M8, P7M10, P7M13	4"	16	16	1	16	16	1	16	—	—	—	—	—	16	—	—
		P9S	4"	15	15	15	15	15	15	15	—	—	—	—	15	—	—	—
		P2000 V2	3½"	16	15	15	30	15	15	15	30	30	—	—	15	—	—	—
		USP 9mm, .40, .45, USP Compact	3½"-4½"	—	15	15	30	15	15	15	30	30	15	—	15	—	—	—
HI-POINT	Autos	9mm Compact, .380 Compact	3½"	16	16	16	16	15	15	15	—	—	15	—	16	16	—	—
		9mm, .40, .45	4½"	—	5	5	5	5	5	5	—	—	5	—	—	—	—	—
JENNINGS	Autos	J-22, J-25	2½"	—	—	—	—	—	—	—	—	—	—	—	—	10	10	—
		48, 9mm 13-Shot	3"- 4"	1	1	1	1	1	1	1	—	—	—	—	1	1	—	—
KAHR	Autos	K9,P9 9mm, K40	3½"	16	16	1	12	16	—	16	—	—	—	—	—	12	12	—
KBI	Autos	PMK .380, SMC .380	4"	1	1	1	1	1	1	1	—	—	—	—	1	1	—	—
		PJK-9HP	4½"	5	5	5	5	5	5	5	—	—	—	—	5	—	—	—
		PSP 25	2"	—	—	—	—	—	—	10	—	—	—	—	—	10	10	—
KEL-TEC	Autos	P-11 9mm, P-32, P-40	3.1"	16	16	16	12	16	15	16	—	—	—	—	12	12	—	—
KIMBER	Autos	Custom, Royal, Stainless, Gold Match, Stainless Gold Match,	5"	—	19	19	19	5	5	5	—	—	19	5	—	5	—	—
		Gold Combat, Gold Combat Stainless Steel, Super Match, Custom CDP	5"	—	19	19	19	5	5	5	—	—	19	5	—	5	—	—
		Compact, Compact Stainless Steel, Compact Aluminum Stainless Steel,	4"	—	19	19	19	15	15	15	—	—	19	15	—	15	—	—
		Pro Carry, Stainless Steel Pro Carry, Pro Carry HD, Compact CDP, Pro CDP	3"	16	16	16	16	16	1	16	—	—	—	—	16	16	—	—
		Ultra Carry, Stainless Steel Ultra Carry, Ultra CDP	5"	—	19	19	19	5	5	5	—	—	19	5	—	5	—	—
LES BAER	Autos	S.R.P.	5"	—	19	19	19	5	5	5	—	—	19	5	—	5	—	—
LLAMA	Autos	XV, XA, 111A, MiniMax, Plus Other Small Frame Autos	3"- 4"	1	1	1	1	1	1	1	—	—	—	—	1	1	—	—
		MiniMax, MiniMax II	3½"	16	16	16	16	16	1	16	—	—	—	—	16	16	—	—
		1XA, VIII, XI, Omni, Plus Other Large Frame Autos	4"- 5"	5	5	5	5	5	5	5	—	—	19	—	5	—	—	—
MAKAROV	Autos	Makarov 9x18mm	3.7"	1	1	1	1	16	1	16	—	—	—	—	1	—	—	—
PARA ORDNANCE	Autos	P12 .45, OPS, Companion	3½"	16	16	16	16	16	1	16	—	—	15	—	16	16	—	—
		P13 .45, LTC, Tac S	4½"	—	19	19	19	15	15	15	—	—	19	15	—	15	—	—
		P14 .45, P16, LDA, SSP	5"	—	19	19	19	5	5	5	—	—	19	5	—	5	—	—
PHOENIX ARMS	Autos	HP22, HP25	2½"	—	—	—	—	—										

How to use the UNCLE MIKE'S LAW ENFORCEMENT® Holster Selection Guide

- Just look up the brand of your handgun, then the particular model of gun, and the barrel length.
- Numbers listed under each style of holster indicate the SIZE of holster you should buy.
- Fit information for the following holsters can be found on earlier pages of this catalog.

Ambidextrous Hip	Hip-Thumb Break	Paddle	Super Belt Slide	Pro-Pak® Horizontal	Pro-Pak® Vertical	Pro-Pak® Undercover	PRO-3® Duty/Tactical	Dual Retention Duty/Tactical	Tactical/Flashlight/Laser	PRO-2® Jacket Slot	Inside-Pant Open	Ankle
------------------	-----------------	--------	------------------	---------------------	-------------------	---------------------	----------------------	------------------------------	---------------------------	--------------------	------------------	-------

Gun Make and Model			Barrel Length	Holster Size													
RAVEN	Autos	P-25	2½"	—	—	—	—	—	—	—	10	—	—	—	10		
		P85, P89, P90, P91, P93, P94, P95, KP90, KP93, KP94	4"- 4½"	15	15	15	15	15	15	15	15	23†	23	15	—	5	—
RUGER	Autos	KP97	4"- 4½"	15	15	15	15	15	15	15	15	23	23	—	—	15	—
		KP345PR	4"	15	15	15	15	15	15	15	—	—	—	—	—	15	—
		P345	4"	15	15	15	15	15	15	15	23	23	5	—	15	—	
	Revolvers	Security Six, Service Six, Speed Six, SP 101	2½"- 3"	—	0	0	0	0	—	—	—	—	—	—	—	0	—
		SP 101 (except spurless hammer)	2"	36	36	36	36	36	—	—	—	—	—	—	—	36	—
SIG/SAUER	Autos	Security Six, Service Six, Speed Six, GP 100	6"	—	3	—	—	—	—	—	—	—	—	—	—	—	—
		229R (DAK)	3¾"	16	16	15	15	15	15	15	—	—	22	—	22	16	—
		P220ST .45 Cal, P226R	4½"	16	16	15	15	15	15	15	22	22	—	22	15	—	
		P230, P232	3½"	1	1	1	1	1	1	1	1	—	—	—	—	1	1
		P220, P226	4½"	15	15	15	15	15	15	15	22	22	15	22	15	—	
		P225, P228, P229 SP2340, SP2009 9mm	3¾"	16	16	16	16	16	1	16	22	22	15	22	16	—	
		P239	3½"	16	16	16	16	16	—	16	—	—	—	—	16	16	
		P245	3¾"	15	15	15	15	15	1	15	—	—	15	22	15	15	
SMITH & WESSON	Autos	MP	4"	15	15	21	15	15	15	15	—	—	21	—	25	15	—
		469, 669, 908, 3913, 3914, 3953, 3954, 4013, 4013TSW, 4053, 5903SSV, 5943SSV, 6904, 6906, 6944, 6946	3½"	16	16	16	16	16	1	16	18	18	18	15	—	16	16
		39, 59, 410, 411, 439, 457, 457D, 459, 539, 559, 639, 659, 909, 910, 915, 3904, 3906, 4003, 4004, 4006, 4026, 4043, 4044, 4046, 4516, 4536, 4556, 5903, 5904, 5905, 5906, 5926, 5943, 5944, 5946, 5967, 9mm, .40, Subcompact .45	3¾"- 4"	15	15	15	15	15	15	15	18	18	15	18	15	—	
		1066, 1076, 1086, 4566, 4567, 4576, 4586	4½"	15	15	15	15	15	15	15	18	—	15	—	15	—	
		* All of the above applies to TSW variations															
		645, 745, 1006, 4506, 4526	5"	5	5	5	5	5	5	5	20	20	5	—	5	—	
		2213, 2214	3"	1	1	1	1	1	1	1	—	—	—	—	1	1	
		Sigma—Full Size 9mm, .40, SW9E, SW40E, SW40VE	4"- 4¼"	15	15	15	15	15	15	15	28	28	15	—	15	—	
		SW9VE	4"	15	16	16	15	15	15	16	28	21	—	25	16	—	
		Sigma—Compact 9mm, .40	4½"	15	15	15	15	16	15	16	28	28	15	—	16	—	
		Sigma—Compact .380	3"	1	1	1	1	1	1	1	28	—	—	—	1	1	
		52	5"	5	5	5	5	5	5	5	—	—	—	—	5	—	
		SW99	4"	15	15	15	30	15	15	15	29	30	—	—	15	—	
		SW 1911	5"	5	19	19	19	5	5	5	—	19	—	—	5	—	
	Revolvers	J Frames with hammer spur 31, 34, 36, 37, 60, 317, 317LS, 331, 337, 632, 634, 637	2"	36	36	36	36	36	—	—	36	—	—	—	36	0	
		J Frames with shrouded or concealed hammers, including: 38, 40, 42, 49, 332, 342, 442, 631, 638, 640, 642, 649, 940	2"- 2½"	—	—	—	40	—	—	—	—	—	—	—	36	—	
		J Frames with hammer spur: 30, 31, 32, 34, 36, 37, 60, 317, 650	3"	—	0	0	0	0	—	0	—	—	—	—	—	—	
		J Frames with concealed hammers, incl.: 242, 640, 940	3"	—	—	—	—	—	—	—	—	—	—	—	0	—	
		All K Frames, including: 10, 12, 13, 15, 19, 64, 65, 66, 547	2"- 3"	—	0	0	0	0	—	0	—	—	—	—	0	—	
		All K & L Frames, including: 10, 12, 13, 14, 15, 16, 17, 18, 19, 33, 48, 53, 64, 65, 66, 67, 547, 581, 586, 681, 686, 686+, L Frame (7 shot)	4"	2	2	2	2	2	2	2	—	2	—	2	—		
		All N Frames, including: 20, 21, 23, 24, 25, 27, 28, 29, 57, 58, 520, 625, 629, 657	3"- 4"	2	—	—	2	—	2	—	—	—	—	—	—	—	
		All K & L Frames, including: 10, 14, 16, 17, 19, 48, 53, 66, 586, 686	6"	—	3	—	—	—	—	—	—	—	—	—	—	—	
SPRINGFIELD ARMORY	Autos	Commander	4½"	—	19	19	19	16	1	16	—	19	15	—	16	—	
		1911 A1, Defender, Omega	5"	—	19	19	19	5	5	5	—	19	5	—	5	—	
		P9	4¾"	5	15	15	5	5	5	5	—	5	—	15	—		
		P9 Compact	3¾"	16	16	16	16	16	1	16	—	—	—	16	—		
		XD Compact	3"	16	16	16	15	—	—	—	—	—	—	0	—		
		XD-9, XD-40, XD357	4"	16	16	15	5	5	5	5	—	25	15	—	16	—	
		XD-9 Sub	3"	16	—	16	15	—	—	—	—	—	—	0	—		
		HS-2000	4"	16	16	15	15	5	5	5	28	30	—	—	5	—	
STAR	Autos	Ultrastar	2½"	16	16	16	16	16	1	16	—	—	—	—	16	16	
		30 PK, Firestar 9mm, .40, Firestar Plus 9mm	3½"- 3¾"	16	1	1	16	1	15	1	—	—	—	—	1	—	
		Firestar .45	4"	15	16	16	15	15	15	15	—	—	15	—	15	—	
STEYR	Autos	GB 9mm	5½"	5	5	5	5	5	5	5	—	—	—	—	5	—	
		M40, M9	4"	15	16	—	30	15	15	15	15	22	30	—	—	16	16
TAURUS	Autos	PT-22, PT-25	2½"	—	—	—	—	—	—	—	10	—	—	—	10	10	
		PT-908, PT-911, PT-938, PT-940, PT-957	3¾"	16	16	16	16	1	16	—	—	—	15	—	16	—	
		PT-400, PT-945	3.8"	15	15	15	15	15	15	—	—	—	—	15	—		
		PT-58	4"	15	15	15	15	16	15	16	—	20	15	—	16	—	
		PT-92C	4½"	15	15	15	15	15	15	15	—	20	15	—	15	—	
		PT-92, PT-99, PT-100, PT-101	5"	5	5	5	5	5	5	5	—	20	5	—	5	—	
		PT-111, PT-138, PT-140, PT-145, PT-157	3½"	16	16	16	12	16	15	16	—	—	—	—	12	12	
		247	4½"	15	15	15	15	15	15	15	22	22	—	—	15	—	
	Revolvers	85, 94, 941, 731	2"	36	36	36	36	36	—	36	—	—	—	—	36	0	
		85CH concealed hammer	2"	—	—	—	40	—	—	—	—	—	—	—	36	—	
		65, 66, 73, 74, 80, 82, 83, 415, 431, 441, 445, 605, 741, 817, 941	2"- 3"	—	0	0	0	0	—	0	—	—	—	—	0	—	
		65, 66, 80, 82, 83, 84, 94, 425, 431, 441, 607 .44 Mag., 608, 627, 669, 689, 741, 827, 941	4"	2	2	2	2	2	2	2	—	2	—	—	2	—	
		66, 86, 96, 441, M44, 607 .44 Mag., 608, 689, 761	6"- 6½"	—	3	—	—	—	—	—	—	—	—	—	—	—	
WALTHER	Autos	TPH22, TPH25	2½"	—	—	—	—	—	—	—	10	—	—	—	10	10	
		PP, PPK, PPK/S, PP Super	3¾"- 3¾"	1	1	1	1	1	1	1	1	—	—	—	1	1	
		P99	4"	15	16	16	30	15	15	15	30	30	—	—	15	—	
		P38, P38IV	4½"- 5"	5	5	5	5	5	5	5	—	—	—	—	5	—	
		P5	4½"	15	16	16	15	15	1	15	—	—	—	—	16	—	
		P22	3¾"	15	15	16	16	16	15	16	—	21	—	—	16	16	
		P22	5"	5	5	5	5	5	5	5	—	21	—	—	5	—	

† Available in PRO-3® Duty only

### MIRAGE® Basketweave Nylon PRO-2® Duty Rig

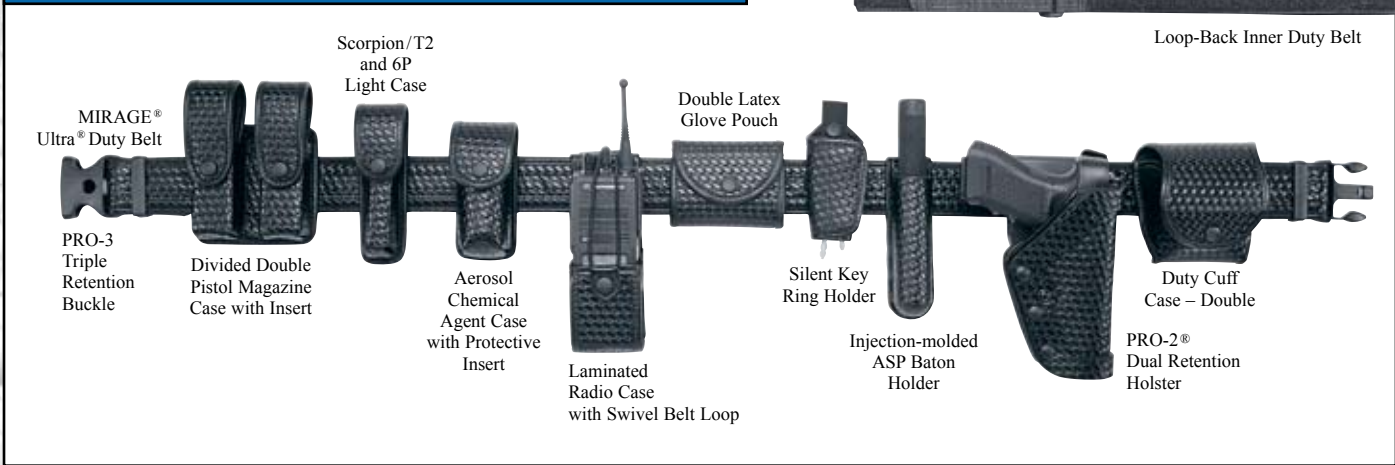

### Cordura® Nylon SlimLine™ PRO-3® Duty Rig



### Cordura® Nylon Tactical PRO-3® System



If you are unable to find any product locally, please contact us.  
Phone: (800) 845-2444 • [www.unclemikes.com](http://www.unclemikes.com) • e-mail: [info@unclemikes.com](mailto:info@unclemikes.com)