



РЕМОНТНЫЙ КОМПЛЕКТ
КАРБЮРАТОРА
 МОТОЦИКЛОВ

K68Y



РЕМОНТНЫЙ КОМПЛЕКТ
КАРБЮРАТОРА
 МОТОЦИКЛОВ

K68Y-1

Ural (Урал) - Днепр (Днепр)
Russian Motorcycle
Part 14: Carburetor
Repair / Re-Build Kits

Ernie Franke
eafranke@tampabay.rr.com
10 / 2012



Carburetor Repair / Re-Build Kits

- ***Make Sure Repair Kit Covers Both Left and Right Carbs***
 - ***Left and Right Carbs Identical***
 - ***K-62, K-63, K-65, Jikov 2928CE, VM-28 Mikuni, CVK32 Keihin***
 - ***Left and Right Carbs Different***
 - ***PZ-28D, K-68, K-301, K-302***
- ***Consider Whether It's from Original Manufacturing House***
 - ***Pekar Is the Most Popular Re-Build Kit***
- ***Kit Should Include:***
 - ***Float with Axle***
 - ***Two Jets: Idle and Main***
 - ***Throttle Valve Needle***
 - ***Idling Tube***
 - ***Idle Adjusting Screw***
 - ***Gaskets***
 - ***Throttle***
- ***Kits Known by Many Names***
 - ***Repair Kit, Overhaul Kit, Rebuild Kit***
- ***Availability***
 - ***Repair Parts for Modern Carbs (Mikuni and Keihin) are Available on the Web***
 - ***Haven't Seen as Many K-37 or K-38 Parts***
- ***Pricing***
 - ***List Prices in \$2012, not including shipping or V.A.T. (Value Added Tax)***

***Rebuilding a carburetor could invigorate bikes with new pep.
Carburetor repair kits are readily available over the internet.***

Suggested Websites for Russian Motorcycle Carb Kits

Vendor	Internet Address
<i>Old Timer Garage</i>	www.oldtimergarage.eu
<i>Russian Garage</i>	www.russiangularage.com/index.php
<i>Ural-Hamburg</i>	www.ural-hamburg.de
<i>Ural-Zentrale (Germany)</i>	www.ural-zentrale.de
<i>F2 Motorcycles Ltd</i>	www.f2motorcycles.ltd.uk
<i>Holopaw Corvette</i>	holopawcorvette.webpointusa.com
<i>Wagner's Cycle Shop</i>	www.wagnerscycle.com/
<i>Raceway Services</i>	www.racewayservices.com
<i>Oü Magnus Henriksson</i>	www.henriksson.ee
<i>Heindl Engineering</i>	www.heindlengineering.com
<i>Russian Spares</i>	www.russianspares.com
<i>Crawford Sales Company</i>	www.crawfordsales.info/
<i>Moto-Boxer</i>	www.moto-boxer.com/
Forums	Internet Address
<i>Russian Iron Board</i>	www.russianiron.com
<i>Soviet Steeds</i>	www.sovietsteeds.com
<i>Russian Bike</i>	www.russianbike.co.uk
<i>CossackPower (b-Cozz)</i>	www.bcozz.multiply.com

Repair Parts for PZ-28 / K-37 / K-38 Carbs



Repair Set for PZ-28
Vendor Part #: 00-05
List Price: 23.50€
(www.henriksson.ee)



Float for PZ-28 / K-37 / K-38 / K-301 / K-302
Vendor Part #: 37-37c
List: 9.00€
(www.henriksson.ee)



Rubber Protector Caps for K-37 / K-38 / PZ-28
Part #: 7215218
List Price: 4.00€
(www.henriksson.ee)



Set of Two Rubber Protector Caps for K-37 / K-38 Replicas.
Vendor Part #: 674
List Price: 11.80€
(www.moto-boxer.com)



Fiber Gasket for Lower Nut of K-38
Vendor Part #: 1784
List Price: 1.18€
(www.moto-boxer.com)



Set of Two Lower Nut Fiber Gaskets for K-37 / K-38 / K-301 / K-302
High Quality
Vendor Part #: 1785
List Price: 1.18€
(www.moto-boxer.com)



Set of Two Gaskets for K-37 / K-302
High Quality
Vendor Part #: 821
List Price: 2.95€
(www.moto-boxer.com)



Float Chamber Lid Gasket for K-37 / K-38 / K-301 / K-302
High Quality
Vendor Part #: 822
List Price: 1.00€
(www.moto-boxer.com)

Most of the parts that fit the PZ-28 carburetor also fit the K-37 / K-38 carburetors, used by the early M-72 and K-750 motorcycles.

Carburetor K-301 / K-302 Overhaul Kits



Vendor Part #: 144
List Price: 19.94€
(www.moto-boxer.com)

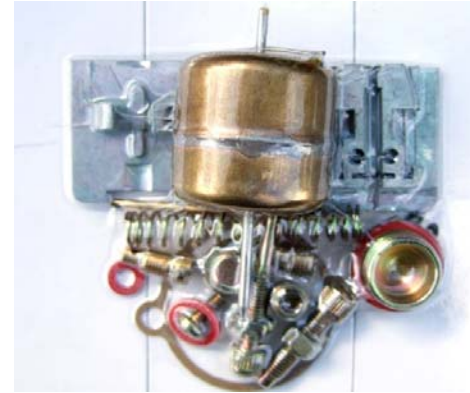

List Price: 14.00€
(www.ebay.co.uk) Made in China



List Price: 15.00€
(www.ural-hamburg.de)



w float: List Price: 34.00€,
w/o float: List Price: 27.00€
(www.henriksson.ee)

The K-301 / K-302 kits do not contain any side-specific (right-hand or left-hand) components.

Carburetor K-301 /K-302 Parts



Part #: 75015218
List Price: 9.98€
Vendor Part #: S393-FS
(www.ural-zentrale.de)

Part #: 75015218
List Price: 6.00€
(www.henriksson.ee)



Set of Two Rubber Protector Caps
Vendor Part #: 1960
List Price: 14.16€
(www.moto-boxer.com)



Replica Set of Two Rubber Protector Caps
Vendor Part #: 1509
List Price: 11.80€
(www.moto-boxer.com)

(www.ebay.co.uk)
List Price: 9.00€



Upper Cover
Vendor Part #: 2119
List Price: 11.80€
(www.moto-boxer.com)

Carb Repair Set for K-302 Carbs

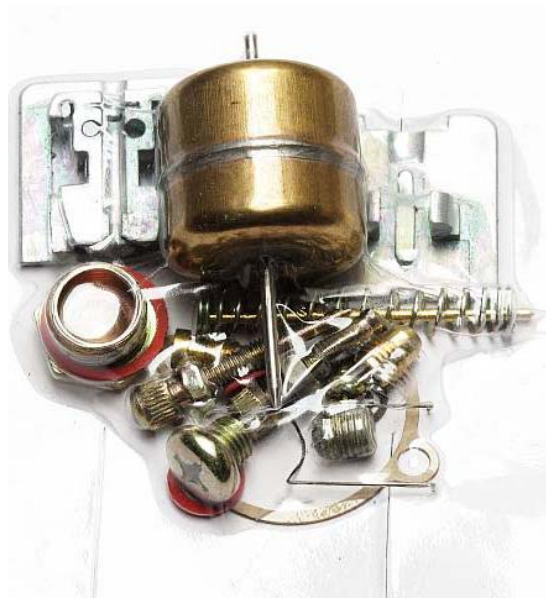

Vendor Part #: 003.083
List Price: 19.16€
(www.oldtimergarage.eu)



Includes Float and Flat-Slide Valve, Jets and Gaskets
Vendor Part #: S359-REP
List Price: 22.99€
(www.ural-zentrale.de)



Jet Kit K-302 / K-303
Vendor Part #: S359-DS List Price:
11.99€
(www.ural-zentrale.de)

K-63 / K-65 Overhaul Rebuild Kit

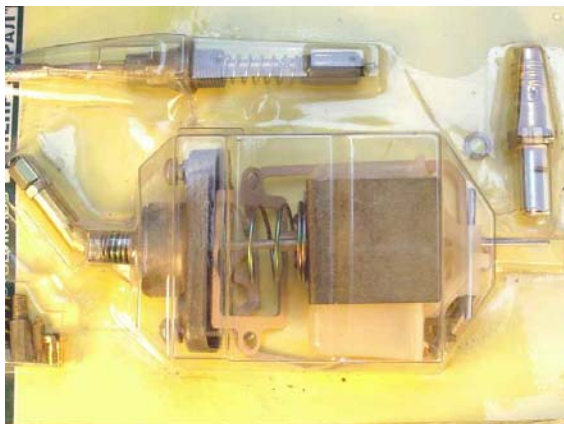

K65/K63T Carburetor Repair Set
Part #: 1107500
Vendor Part #: 000.377
List Price: 22.18€
(www.oldtimergarage.eu)



К-65Д Carburetor Repair Kit
List Price: 10€
(www.minskparts.com)



Vendor Part#: Carb Kit – K-63 / K-65: Includes Carb Top, Emulsion Tube and Jet Holder, and Complete Choke Plunger
Vendor Part #: F24010/K65 x1, List Price: £28.00
Vendor Part #: F24010/K65 x2, List Price: £50.00
(www.f2motorcycles.ltd.uk)

Because the left-hand and right-hand models of the K-63 and K-65 carburetors, one kit is need for each carburetor re-build. The parts for the K-62 carburetor are very similar to those of the K-65.

K-62 / K-63 / K-65 Flat-Slide Throttle Parts



Float Chamber Gasket
Part #: K62-1107053
Vendor Part #: 825
List Price: 1.36€
(www.moto-boxer.com)

Vendor Part #: S119
List Price: 1.49€
(www.ural-zentrale.de)

List Price: 2.05€
(www.ural-hamburg.de)



Idle Jet 0.7 mm
Vendor Part #: S119-D
Carburetor jet made from brass
For all Pekar K-63 / K-65 / K-68 Exact
Adjusting with Reamer is
Recommended.
List Price: 1.79€
(www.ural-zentrale.de)



K-63 / K-65 Mixing Chamber Top Gasket
Part #: K62-1107052
Vendor Part #: 826
List Price: 1.00€
(www.moto-boxer.com)

Vendor Part #: S2120
List Price: 0.99€
(www.ural-zentrale.de)

List Price: 1.02€
(www.ural-hamburg.de)



Set of 12 Jet Reamers with Holder
for Jets with Bores from 0.6 to 2 mm
Vendor Part #: S7005
Perfect for fine-tuning carburetors.
List Price: 19.99€
(www.ural-zentrale.de)

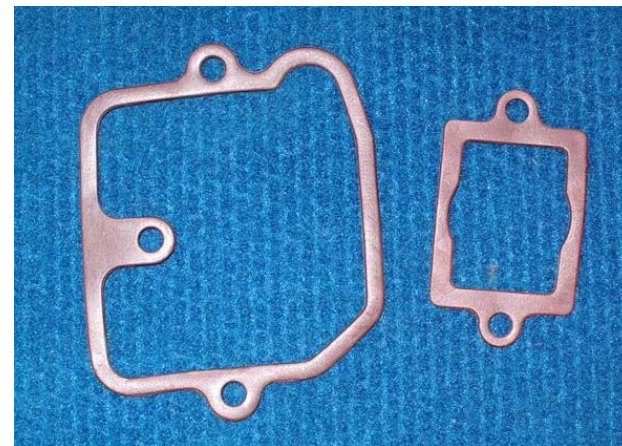

Gasket Set
Vendor Part #: 000.140/141
Vendor Part #: 813
List Price: 3.53€
(www.oldtimergarage.eu)



Carburetor K-63 / K-65 Throttle Jet Needle with Clip
Part #: K63U-1107895
Vendor Part #: 148
List Price: 2.95€
(www.moto-boxer.com)

The K-62 / K-63 / K-65 carburetor has two gaskets; the float chamber gasket and the mixing chamber gasket.

Carburetor K-63 / K-65 / K-68 Parts



Float Needle, with Seal
Part #: K62-1107675
Vendor Part #: 149
List Price: 1.89€
(www.moto-boxer.com)



Float Needle Seal
Part #: K126N-110733
Vendor Part #: 1994
List Price: 1.00€
(www.moto-boxer.com)



Set of 10 Float Needle Seals
Fits on needle valve of K-63 / K-65 / K-68
Vendor Part #: S388
List Price: 7.99€
(www.ural-zentrale.de)



Rubber Boot to Seal Throttle Cable for All Carbs
Length: 20 mm, diameter: 5 mm (elastic)
Vendor Part #: S4537
List Price: 0.99€
(www.ural-zentrale.de)



Rubber Boot
To Seal Throttle and Choke cable at Carb Cover
Size: 8 x 13 mm, length: 11 mm
Vendor Part #: S4538
List Price: 0.99€
(www.ural-zentrale.de)



Carburetor K-63 / K-65 / K-68 Rubber Protector Cap
Part #: K60-1107527
List Price: 3.07€
Vendor Part #: 671
(www.moto-boxer.com)

K-65T Overhaul Rebuild Kits



Two Repair Sets
List Price: \$25.00
Vendor Part #: 61
(www.russiagarage.com)



Includes all gaskets, jets, slide, cap and choke-device
List Price: 19.99€
(www.ural-zentrale.de)



Includes all gaskets, jets, slide, cap and choke-device
Two Repair Sets
Vendor Part #: 31
List Price: \$55.00
(www.russiagarage.com)



Vendor Part #: 1041
List Price: 17.44€
(www.ural-hamburg.de)

List Price: 19.00€
(www.ebay.co.uk)

Vendor Part #: 153
List Price: 17.70€
(moto-boxer.com)

Vendor Part #: 30
List Price: \$30.00
(www.russiagarage.com)

List Price: 9.99€
(www.ebay.co.uk)



Carburetor K-65D (D) Overhaul Kit
Vendor Part #: 151
List Price: 14.75€
(www.moto-boxer.com)

Vendor Part #: 1006
List Price: 9.00€
(www.ural-hamburg.de)

List Price: 5.90€
(www.ebay.co.uk)

Vendor Part #: 154
List Price: 9.44€
(www.moto-boxer.com)

Vendor Part #: 60
List Price: \$15.00
(www.russiagarage.com)

Vendor Part #: 01.53
List Price: 16.50€
(www.henriksson.ee)

Includes all jets and slide repair set K-65 small
List Price: 8.89€
Vendor Part #: S117-KI
(www.ural-zentrale.de)

Each kit includes; float with axle, two jets, idling tube, idling adjust screw, two gaskets, throttle's needle and throttle. The least expensive kits do not include the choke and cap.

Carburetor K-65 Parts

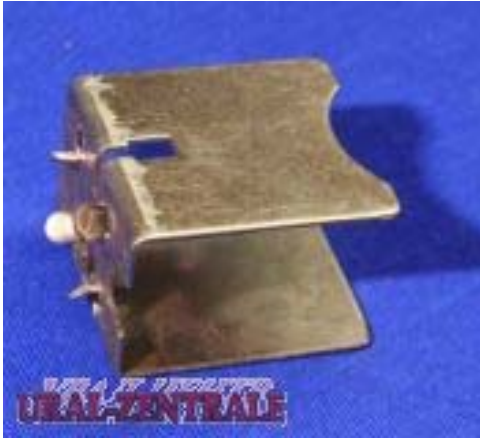

Flat-Slide Throttle Valve
Vendor Part #: S2155
List Price: 1.99€
(www.ural-zentrale.de)



Flat-Slide Throttle Valve
List Price: 1.99€
(www.ebay.co.uk)



K-65 Float
Vendor Part #: S2156
List Price: 3.99€
(www.ural-zentrale.de)



K-63 / K-65 Float
Part #: K62-1107640
Vendor Part #: 150
List Price: 2.36€
(www.moto-boxer.com)

Carburetor K-68 Repair Kits



K-68U (Y) (left)



K-68U (Y) (right)

Vendor Part #: 157
List Price: 10.62€
(www.moto-boxer.com)

Vendor Part #: 000.391
List Price: 15.12€
(www.oldtimergarage.eu)

List Price: 17.50EUR
(www.ural-hamburg.de)

Vendor Part #: S4083
List Price: 17.50€
(www.ural-zentrale.de)

Vendor Part #: 00-07-2
List Price: 16.50€
(www.henriksson.ee)

Vendor Part #: 155
List Price: 10.62€
(www.moto-boxer.com)

Vendor Part #: 00-07-1
List Price: 16.50€
(www.henriksson.ee)

Vendor Part #: S4084
List Price: 17.50€
www.ural-zentrale.de

List Price: 12.00€
(www.ebay.co.uk)



**K-68U (Y) Pair
 (right and left)**

Vendor Part #: 199
List Price: \$35.00
(www.russiangerage.com)



Carb Kit – K-68. The K-68 carburetors are right-handed and left-handed, so the kits are only supplied in pairs.
Vendor Part #: F24010/K68 pair
List Price: £36.00
(www.f2motorcycles.ltd.uk)

Each Pekar set includes; a float assembly with axle, two jets, valve needle assembly, idling tube, idle adjust screw, two gaskets, spring, throttle needle assy, and throttle assy)

Carburetor K-68 Parts



K-68 Float
List Price: €3.00
(www.ebay.co.uk)



K-68 Float Assembly
Vendor Part #: S118
List Price: 9.90€
(www.ural-zentrale.de)

VM-28-49 28 mm Round-Slide Carburetor

(See Also Part 11A: VM 28mm Mikuni, : VM Mikuni Carb Manual)

- VM28-49 in 1998 Ural Manual
- Main Jet: 4/042 #200
- Pilot Jet: VM22/210 #60
- Needle Jet: N-8 #169
- Jet Needle: 5F21
- Throttle Valve: VM28-56 2.5
- Main Air Jet: BS30/97 0.5
- Needle Valve: VM26/26 2.5
- Dimensions:

- A: 35 mm
- B: 33 mm
- C: 10 mm
- D: 4 mm
- E: 49 mm
- F: 44 mm
- G: 7 mm
- H: 6 mm
- I: 44 mm
- J: 72 mm
- K: 66 mm
- L: 54 mm
- Total Width: 72 mm
- Throttle Adjuster: Left
- Air Screw: Right
- Weight: 0.55 kg
- Material: Aluminum
- Float Height: 15-17 mm (0.59-0.66")

- VM28-49 Manufacture Discontinued

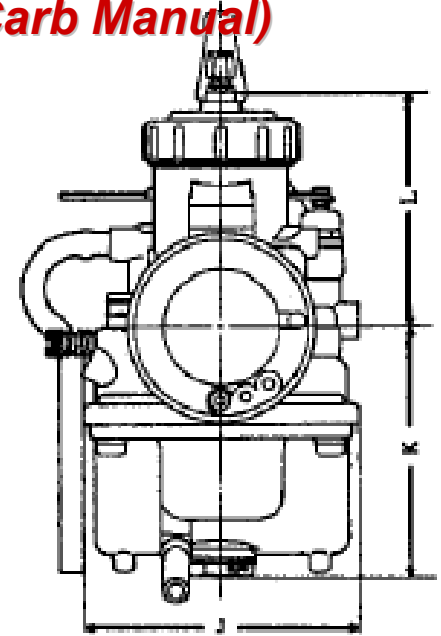
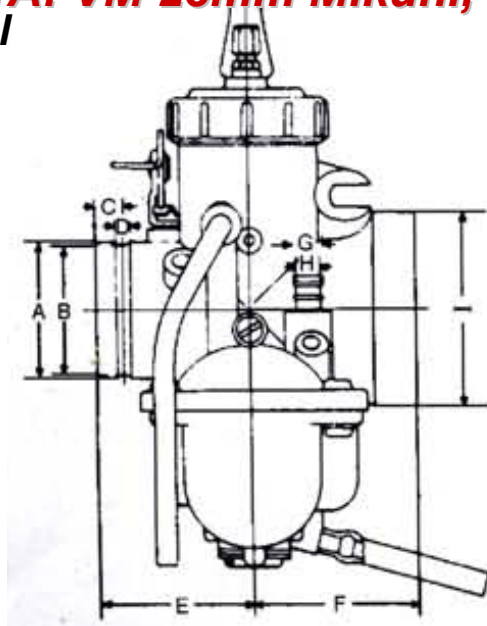

SUDCO is the U. S. importer for Mikuni. (<http://www.sudco.com/mikuni.html>)
Sudco International, 2410 South Sequoia Drive, Compton, CA 90220 Phone: (310) 63- 8330

VM-28 Components (www.sudco.com)



Jet Needles



Needle Positioning Clips
Needle Jet and Jet Needles



Needle Jets



14 mm

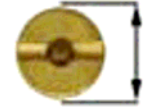

4 mm

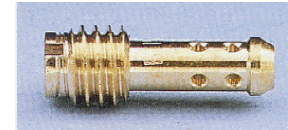

Pilot Jets

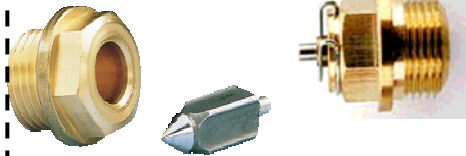

Needle Valves



**Lever Type
Starter System**

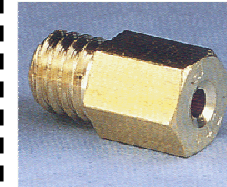

Main Jets (Large Hex)

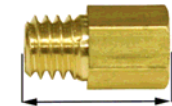

12 mm

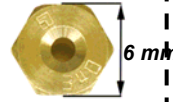

6 mm

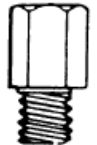

Throttle Valve (Round-Slide)



8 mm

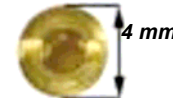

4 mm



Air Jets

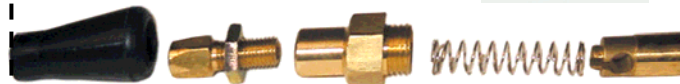

Even though the VM28-49 carburetor is no longer manufactured, parts are still readily available on the internet.

VM Spigot-Mount Exploded View (1998 Manual)

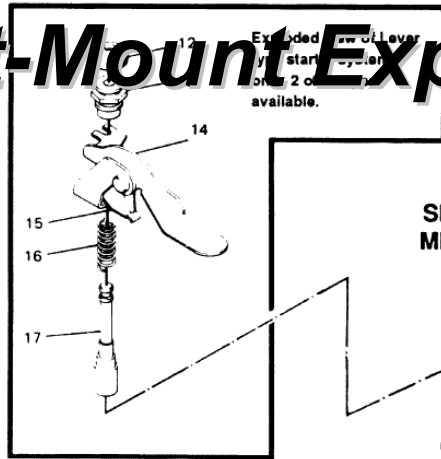
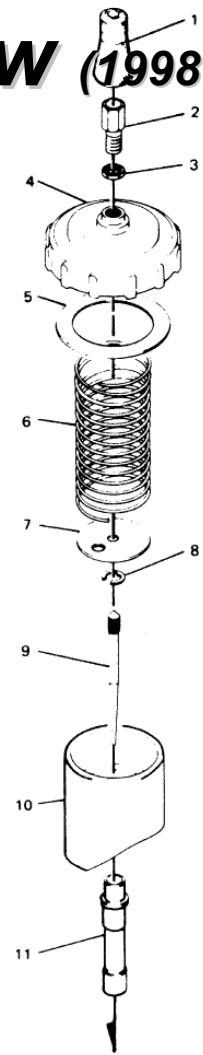
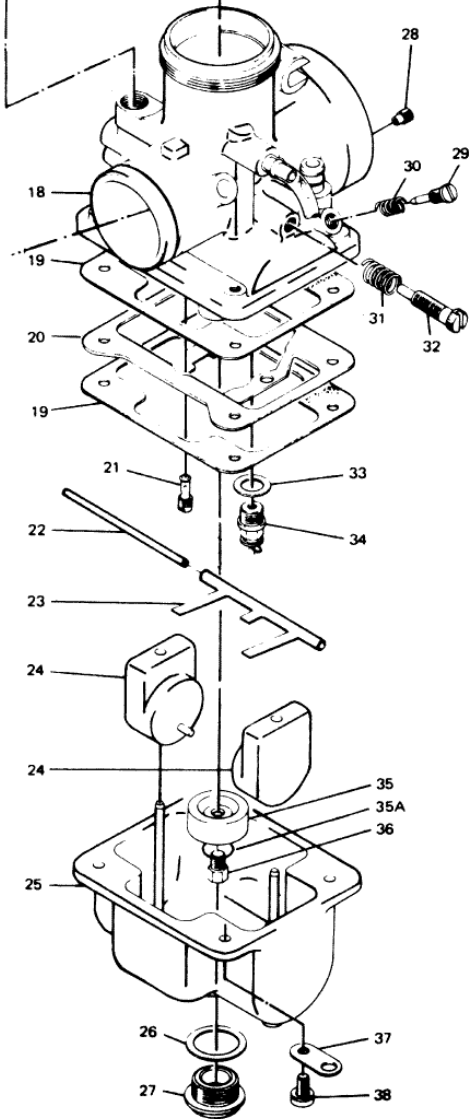
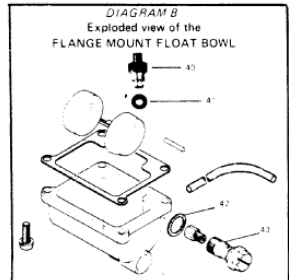

DIAGRAM A
Exploded view of a
SPIGOT MOUNT TYPE
MIKUNI CARBURETOR



Exploded View

(not all parts listed are available)



VM28 Spigot (<http://www.sudco.com/Carburetor/SudcoMikuniCatalog.pdf>)

<i>Description</i>	<i>Mikuni Part #</i>
1. Rubber Cap, Throttle Cable	VM26/46
2. "A" Cable Adjuster (7mm)	VM28/256
3. Locknut, Cable Adjuster	B30/247
4. Top, Mixing Chamber	VM26/56
5. Gasket, Mixing Top	Gasket comes with each VM Mixing Chamber Top
6. Spring, Throttle Valve	VM28/58
7. Plate, Spring Seat	VM28/132
8. Needle Positioning Clip	VM20/369
9. Jet Needle	#5 Series (5DP7, 5F21, 5F3, 5L1)
10. Throttle Valve (Slide) Pg.131-132	VM28/56
11. Needle Jet	#169 Series
12. Rubber, Starter Plunger	VM20/455
13. Fitting, Starter Plunger	VM26/116
14. Lever, Starter	VM28/124
15. Spring Plate, Starter Lever	VM32/17
16. Starter Plunger Spring	VM16/42
17. Starter Plunger	Not Used
18. Mixing Chamber Body	Not Available Separately
19. Float Bowl Gasket	VM28/129
20. Float Bowl Baffle Plate	VM34/72
21. Pilot Jet	VM22/210
22. Float Arm Hinge Pin	BV26/22
23. Float Arm	VM28/166
24. Float (Independent, Type A)	VM28/164
25. Float Bowl	Not Available Separately
26. Main Jet Plug Washer	VM28/134
27. Main Jet Plug (Drain Plug)	VM28/133
28. Air Jet	BS30/97
29. Air Adjusting Screw	VM20/214
30. Air Adjusting Screw Spring	M12F/46A
31. Idle Adjusting Screw Spring	M20/221
32. Idle Adjusting Screw	VM24/224
33. Needle Valve Washer	VM26/25
34. Needle Valve Set (Needle Valve & Seat Assembly)	VM26/26 All Needle Valve seats for VM series are thread-in type. See Chart
35. Main Jet Ring	VM28/228
35A. Main Jet Washer	VM15/80A
36. Main Jet	4/042 Series
37. Vent Tube Anchor Plate	VM15/164
38. Float Bowl Screw (4x16mm)	VM20/416
39. Main Jet Extender	Not Used
40. Needle Jet Setter	VM32/04
41. Needle Jet Setter O-Ring	VM26/124
42. Banjo Bolt Washer	VM15/80A
43. Banjo Bolt	Not Used
<i>Mikuni Rubber Mounting Flanges, See Page 142</i>	VM28/200

Carb Repair Kit - Keihin.

(see also Part 13: Keihin Carbs, 13A: CVK32 Carburetor Clinic, 13B: Keihin CVK32 Disassembly , 13C: Re-Jetting Keihin Carbs and 13D: Keihin Manual in German)



Vendor Part #: F24010/KEIHIN x1 Price - £12.00
Vendor Part #: F24010/KEIHIN x2 Price - £20.00
(www.f2motorcycles.ltd.uk)

Simple kit for the Keihin CVK carburetor fitted to Ural Tourist, Dalesman, Wolf, etc. The float needle should cure the minor leaks associated with wear in the viton tip. The replacement slow running needle complete with o-ring will help to cure the tick over setting problems associated with worn or damaged needle taper.

Miscellaneous Parts for Keihin Carbs



Ural Keihin Carb Jet Kit
Kit includes 2 #42 & 2 #45 pilot jets;
2 #128 & 2 #130 main jets; and 8
Allen Head Float Bowl Screws.
Other Jet Sizes Available and Can
Be Substituted.
List Price: \$45.00
(uralnwco.ipower.com)



Pilot Jets for Keihin Carbs
Includes 2 Pilot Jets.
Please Specify Size: #42, #45,
#40, #38
List Price: \$12.00
(uralnwco.ipower.com)



Main Jets for Keihin Carbs
Includes 2 Main Jets
Please specify size: #122.5,
#125, #128, #130, #138
List Price: \$12.00
(uralnwco.ipower.com)



Float Bowl Allen Head Screws
Includes 8 Allen Head Float Bowl
Screws for Keihin Carbs
List Price: \$7.99
(uralnwco.ipower.com)

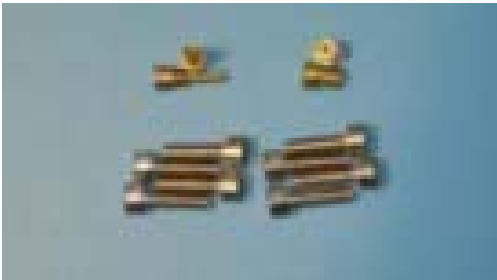

Carburetor Jets and S/S Allen Cap Screws
2- 130 Main Jets
2- 45 Idle Jets
8- S/S Allen Cap Screws (Bowls)
List Price: \$24.95
(holopawcorvette.webpointusa.com)