

KitchenAid® PASTA MAKER



**This attachment has been approved for use with
all KitchenAid® household stand mixers**

*Pasta Maker Plates (Model SNPA) are available to convert a Model FGA Food Grinder to a Pasta Maker.



IMPORTANT SAFEGUARDS

When using electrical appliances, basic safety precautions should always be followed including the following:

1. Read all instructions.
2. To protect against risk of electrical shock, do not put mixer in water or other liquid.
3. Close supervision is necessary when any appliance is used near children.
4. Unplug from outlet when not in use, before putting on or taking off parts, and before cleaning.
5. Avoid contacting moving parts. Keep fingers out of discharge opening.
6. Do not operate the mixer with a damaged cord or plug or after the mixer malfunctions, or is dropped or damaged in any manner. Return the mixer to the nearest Authorized Service Center for examination, repair or electrical or mechanical adjustment.
7. The use of attachments not recommended or sold by KitchenAid may cause fire, electric shock or injury.
8. Do not use the mixer outdoors.
9. Do not let the cord hang over the edge of table or counter.
10. Never feed dough by hand. Always use food pusher.
11. This product is designed for household use only.

SAVE THESE INSTRUCTIONS

Your safety and the safety of others is very important.

We have provided many important safety messages in this manual and on your appliance. Always read and obey all safety messages.



This is the safety alert symbol.

This symbol alerts you to hazards that can kill or hurt you and others.

All safety messages will be preceded by the safety alert symbol and the word "DANGER" or "WARNING." These words mean:

 **DANGER**

You will be killed or seriously injured if you don't follow instructions.

 **WARNING**

You can be killed or seriously injured if you don't follow instructions.

All safety messages will identify the hazard, tell you how to reduce the chance of injury, and tell you what can happen if the instructions are not followed.



TO ASSEMBLE:

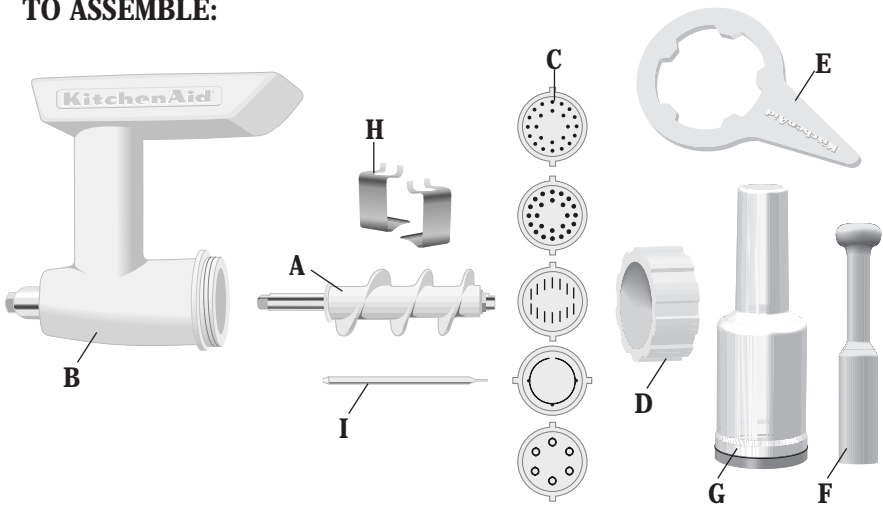

Insert the grind worm (A) into the grinder body (B). Place one of the pasta plates (C) over the exposed end of the grind worm, matching the tabs of the plate with the notches in the grinder body. Place ring (D) onto grinder body, turning by hand until finger tight but not overtightened. Wooden food pusher (F). A storage case (G) is provided to store pasta plates, bowl clips (H) and cleaning tool (I).

Note: Do not use wrench (E) to tighten ring.

TO ATTACH:

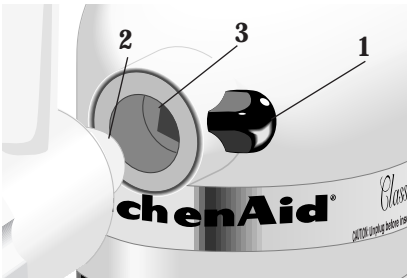

Before attaching accessory, turn off and unplug unit.

Loosen attachment knob (1) by turning it counterclockwise. Remove attachment hub cover. Insert attachment shaft housing (2) into attachment hub (3) making certain that attachment power shaft fits into square hub socket. Rotate attachment back and forth if necessary. When attachment is in proper position, the pin on the attachment will fit into the notch on

the hub. Tighten attachment knob until attachment is completely secured to mixer.

FOR 5 QUART MODELS**

Two, small, metal clips (H) have been packed with this attachment. These clips are to be used only when making the pasta dough recipes.



To use clips

Once bowl has been attached to the mixer, place the clips over the locating pins. These clips help keep the bowl stationary during mixing.

**5 Quart models include K5SS, KSM5, KSM50P.



TO USE:

! WARNING	
	<p>Rotating Blade Hazard Always use food pusher. Keep fingers out of openings. Keep away from children. Failure to do so can result in cuts or other injury.</p>

Turn mixer to Speed 10. Slowly feed walnut-size pieces of dough into the hopper; dough should self-feed. The grind worm should be visible before adding the next piece of dough. Use food pusher only if dough becomes caught in hopper and no longer self-feeds.

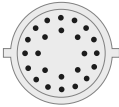

THIN SPAGHETTI (PLATE 1)

Extrusion Length — 24 cm; stop mixer and gently pull noodles away from plate.

Separation — Lay on flat surface and separate immediately. Dry on a towel in a single layer.

Storage — Use immediately or thoroughly air dry and store in a plastic bag.



THICK SPAGHETTI (PLATE 2)

Extrusion Length — 24 cm; stop mixer and gently pull noodles away from plate.

Separation — Lay on flat surface and separate immediately. Dry on a towel in a single layer.

Storage — Use immediately or thoroughly air dry and store in a plastic bag.

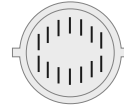

FLAT NOODLE (PLATE 3)

Extrusion Length — 24 cm; stop mixer and gently pull noodles away from plate.

Separation — Lay on flat surface and separate immediately. Dry on a towel in a single layer.

Storage — Use immediately or thoroughly air dry and store in a plastic bag.

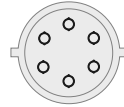

MACARONI (PLATE 4)

Extrusion Length - 15 to 20 cm; stop mixer and gently pull noodles away from plate.

Separation - Lay on flat surface and separate immediately. Partially dry on a towel in a single layer. When fairly firm, crack by hand or cut with a knife into smaller macaroni noodles.

Storage - Cook within 4 hours after extrusion.

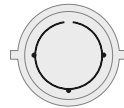

LASAGNA (PLATE 5)

Extrusion Length - 28 to 30 cm; stop mixer and gently pull or cut strip with knife away from plate.

Separation - Partially dry on a towel in a single layer.

Storage - Cook within 4 hours or freeze in aluminum foil.

Note: Pasta Maker Plates (Model SNPA) are available to convert a Model FGA Food Grinder to a Pasta Maker.



TO CHANGE THE PLATES:

Whenever you wish to change plates, the unit must be completely disassembled, the dough cleaned out of the grinder body, and the unit reassembled as stated on page 3.

Note: Pasta Maker Plates (Model SNPA) are available to convert a Model FGA Food Grinder to a Pasta Maker.

TO LOOSEN THE RING:

If ring is too tight to remove by hand, slip the wrench over the grooves. Turn wrench handle counterclockwise.

Note: Never use wrench to attach ring to grinder body. Damage to the attachment may result.

TO CLEAN:

Completely disassemble unit. Use cleaning tool to remove excess dough from plates. Grinder body, grind worm, pasta plates, ring, wrench and storage stomper are dishwasher safe. Wash wooden food pusher in warm sudsy water.

ABOUT PASTA

- Learning to make homemade pasta is simply a matter of practice. If you have never made pasta, you may have to prepare several batches of dough before you feel comfortable. We recommend experimenting with the Basic Egg Noodle Recipe.
- The ratio of liquid to flour in pasta doughs is small, making them firm and leathery, but still pliable. It is extremely important to have the correct proportion of ingredients for proper dough consistency, as doughs which are too moist or too dry will be difficult to work with. To help you achieve consistent results, the pasta recipe in this booklet specifies sifted flour. To sift flour, follow this procedure:
Place dry ingredient measuring cup on a large piece of waxed paper and

hold sifter directly above and close to cup. Scoop flour into sifter and sift until flour exceeds top of cup. Using the flat edge of a spatula, remove excess flour from measuring cup.

Note: Mixer must rest at least 1 hour after extruding 2 consecutive pasta dough recipes.

- Occasionally, there may be unmixed pieces of dough in the bowl after initial mixing with the flat beater. These pieces will be sufficiently incorporated by mixer kneading followed by hand kneading which firms and smoothes the texture of the dough. After kneading, the dough should be allowed to rest, wrapped in a dry towel, for 15 minutes before extrusion.
- Experience has shown that very humid conditions can cause the dough to become sticky and difficult to extrude. To help compensate for this problem, start the initial mixing process with only the sifted flour and eggs. Check the dough for proper consistency and then add water if necessary.
- Spaghetti, flat noodles and macaroni tend to curl in different directions as they extrude through the plate. The first 10 inches of curled noodles may be pulled off and returned to the hopper to be extruded again. Pasta will extrude slowly at first, then faster as more dough is extruded.
- Separate pasta immediately after extrusion. Lay a group of noodles on a flat surface and pull apart from drier ends of strands. Dry on a towel in a single layer.
- Homemade pasta behaves differently than store purchased. Spaghetti and flat noodles bend as they dry and are more fragile, thus requiring careful handling before cooking.



BASIC EGG NOODLE PASTA

3 large eggs
2 tablespoons water
2 $\frac{3}{4}$ cups sifted all-purpose
flour

Break eggs into a glass measuring cup. Add water. Carefully check to see that the total liquid amount is $\frac{3}{4}$ cup. If less than $\frac{3}{4}$ cup, add additional water 1 teaspoon at a time until that amount is reached.

Place flour in bowl. Attach bowl and flat beater. Turn to Speed 2 and gradually add eggs and water. Mix for 30 seconds. Stop mixer and exchange dough hook for flat beater. Turn to Speed 2 and knead for 2 minutes.

Remove mixture from bowl and hand knead for 30 seconds to 1 minute. Cover with plastic wrap and let dough rest for 15 minutes before extruding through Pasta Maker.

Yield: about 1 pound dough

Per serving: About 184 cal, 7 g pro, 33 g carb, 2 g fat, 80 mg chol, 25 mg sod.

TO COOK PASTA

Add 1 tablespoon salt and 1 tablespoon oil to 6 quarts boiling water. Gradually add pasta and continue boiling until pasta is tender. (Pasta floats on top of water as it cooks, so stir occasionally to keep it cooking evenly.) Drain pasta in colander.

For spaghetti, flat noodles, and macaroni, cook entire recipe as directed. For lasagna noodles, cook half of recipe at a time.

Tip: Pasta dough or fresh noodles can be stored in plastic bags in refrigerator up to three days or in freezer up to one month. Cooked noodles can be stored in plastic bags in refrigerator up to three days. Toss noodles with 1 tablespoon oil before placing in bags.



CONFETTI PASTA SALAD

Salad

- 4 cups broccoli florets
- ½ recipe Basic Egg Noodle Pasta macaroni, cooked and drained
- 1 medium red bell pepper, coarsely chopped
- 1 medium yellow summer squash, cut into thin strips
- ¼ cup chopped green onions
- 1 can (15½ oz.) kidney beans, drained and rinsed

Dressing

- ¼ cup olive oil
- ¼ cup red wine vinegar
- 2 teaspoons lemon juice
- 1 teaspoon sugar
- ½ teaspoon salt
- ½ teaspoon dried basil leaves

Cook broccoli in boiling water about 2 minutes; drain.

Combine all Salad ingredients in large bowl.

Combine all Dressing ingredients in small bowl; mix well. Add to Salad. Toss to coat. Refrigerate until serving time.

Yield: 8 servings.

Per serving: About 248 cal, 9 g pro, 35 g carb, 9 g fat, 53 mg chol, 420 mg sod.

SPINACH LASAGNA ROLL-UPS

- 2 teaspoons margarine or butter
- ½ cup finely chopped onion
- ½ cup finely chopped red bell pepper
- ¼ cup fat-free egg substitute or 1 egg
- 1 cup reduced-fat ricotta cheese
- 1 package (10 oz.) frozen spinach, thawed and squeezed dry
- ¼ cup shredded Parmesan cheese
- ½ recipe Basic Egg Noodle Pasta lasagna noodles, cooked and drained
- 1 jar (28 oz.) pasta sauce
- 1 cup shredded part-skim mozzarella cheese

Melt margarine in medium skillet over medium-high heat. Add onion and bell pepper. Cook and stir until softened. Cool slightly.

Place egg substitute and ricotta cheese in mixer bowl. Attach bowl and flat beater to mixer. Turn to Speed 2 and mix about 1 minute. Stop and scrape bowl. Add spinach, Parmesan cheese, and onion mixture. Turn to Speed 2 and mix about 1 minute.

Spread about ¼ cup cheese mixture on each lasagna noodle. Roll up tightly. Spoon about 1 cup pasta sauce over bottom of 13x9x2-inch baking pan. Place lasagna rolls, seam side down, on sauce. Spoon remaining sauce over rolls. Cover with foil. Bake at 350°F for 40 to 45 minutes, or until hot and bubbly. Remove foil. Sprinkle with mozzarella cheese. Bake 5 minutes longer, or until cheese is melted.

Yield: 8 servings.

Per serving: About 312 cal, 17 g pro, 39 g carb, 10 g fat, 75 mg chol, 733 mg sod.

TOTAL REPLACEMENT WARRANTY

We're so confident the quality of our products meets the exacting standards of KitchenAid that, if your attachment/accessory should fail within the first year of ownership, KitchenAid will arrange to deliver a replacement attachment/accessory to your door free of charge and arrange to have your "failed" attachment/accessory returned to us. Your replacement unit is covered by our one year full warranty. Please follow these instructions to receive this quality service.

If you reside in the United States and your KitchenAid attachment/accessory

should fail within the first year of ownership, simply call our toll-free Customer Satisfaction Center at **1-800-541-6390**.

Give the consultant your complete shipping address. (No P.O. Box Numbers, please.)

KitchenAid will arrange to deliver a replacement attachment/accessory and have your "failed" attachment/accessory returned to us.

Put your "failed" attachment/accessory in the original shipping carton along with a sheet of paper with your name and address on it, and proof of purchase (register receipt, credit card charge slip, etc.)

WARRANTY

Length of Warranty:	KitchenAid Will Pay For:	KitchenAid Will Not Pay For:
<p>One Year Full warranty from date of purchase.</p>	<p>Replacement parts and repair labor costs to correct defects in materials or workmanship. Service must be provided by an Authorized KitchenAid Service Center. OR Total Replacement Warranty.</p> <div style="text-align: center;">  </div>	<p>A. Repairs when attachment/accessory is used in other than normal home use. B. Damage resulting from accident, alteration, misuse or abuse. C. Any incidental shipping or handling costs to deliver your attachment/accessory to an Authorized KitchenAid Service Center. D. Replacement parts or repair labor costs for attachments/accessories operated outside the United States.</p>
<p>Missing a part? Call 1-800-541-6390 for immediate handling of your problem.</p>		

KITCHENAID DOES NOT ASSUME ANY RESPONSIBILITY FOR INCIDENTAL OR CONSEQUENTIAL DAMAGES. Some states do not allow the exclusion or limitation of incidental or consequential damages, so this exclusion or limitation may not apply to you. This warranty gives you specific legal rights and you may also have other rights which vary from state to state.

HOW TO ARRANGE FOR SERVICE

To arrange for service, call the KitchenAid Customer Satisfaction Center, toll-free at 1-800-541-6390.

KitchenAid®

St. Joseph, Michigan 49085 U.S.A