

Kelvinator 

Refrigeration

Use & Care



Congratulations

Congratulations and thank you for choosing our refrigerator. We are sure you will find your new refrigerator a pleasure to use. Before you use the refrigerator, we recommend that you read through the entire user manual, which provides the description of the refrigerator and its functions.

To avoid the risks that are always present when you use an electric appliance, it is important that the refrigerator is installed correctly and that you read the safety instructions carefully to avoid misuse and hazards.

We recommend that you keep this instruction booklet for future reference and pass it on to any future owners.

After unpacking the refrigerator please check it is not damaged. If in doubt, do not use the refrigerator but contact your local Electrolux Customer Care Centre.



environmental tip

Information on disposal for users

- Most of the packing materials are recyclable. Please dispose of those materials through your local recycling depot or by placing them in appropriate collection containers.
- If you wish to discard this refrigerator, please contact your local authorities and ask for the correct method of disposal.

Kelvinator quick start guide

1. Ensure appliance is on a flat surface.
2. Leave standing in stable upright position for half an hour prior to turning 'on'.
3. Plug into power socket and turn on.
4. Temperature controls are pre-set to 'mid' adjust as required.
5. Leave run for 2 – 3 hours before storing food.

For optimum usage, safety information and handy hints please read full document.

Contents

Important safety instructions	3
Installing your new refrigerator	4
Side by Side model features	6
Top and Bottom Mount model features	7
Refrigerator & freezer operation	8
Controlling the temperature	8
Using your refrigerator	10
Changing the light bulb	10
Cleaning your refrigerator	11
Energy consumption	11
Safety	12
Helpful hints	12
Troubleshooting	13
Notes	14
Warranty	15



appliancesonline
com.au

Australia's largest online appliance retailer

Important safety instructions

Please read the user manual carefully and store in a handy place for later reference.

The symbols you will see in this booklet have these meanings:

warning

This symbol indicates information concerning your personal safety

caution

This symbol indicates information on how to avoid damaging the appliance

tips and information

This symbol indicates tips and information about use of the appliance

environmental tip

This symbol indicates tips and information about economical and ecological use of the appliance

Meanings of symbols used in this manual are shown below:

 This symbol indicates never to do this

 This symbol indicates always do this

warning

- If pressurised aerosol containers bear the word 'flammable' and/or a small flame symbol, do not store them inside any refrigerator or freezer. If you do so you may cause an explosion. 
- This appliance is not intended for use by persons (including children) with reduced physical, sensory or mental capabilities, or lack of experience and knowledge, unless they have been given supervision or instruction concerning use of the appliance by a person responsible for their safety.
- Children should be supervised to ensure that they do not play with the appliance.
- When you dispose of your old refrigerators and freezers, remove any doors. Children can suffocate if they get trapped inside.
- This appliance contains insulation formed with flammable blowing gases. Avoid safety hazards by carefully disposing of this appliance.

warning

- ✓ The appliance must be plugged into its own dedicated 220-240V, 50Hz AC electrical outlet.
- ✓ Ensure that the electric outlet is properly earthed to ground. Consult a qualified electrician if you are unsure.
- ⊘ Do not use an extension cord or adapter plug.
- ✓ If the power cord is damaged, it should be replaced by a service technician or a qualified person.
- ✓ Unplug the appliance before cleaning and before changing the light bulb to avoid electric shock.
- ⊘ Never unplug the appliance by pulling on the power cord. Always grip the plug firmly, and pull straight out of the receptacle to prevent damaging the power cord.
- ✓ Choose a location that is not too cold – the temperature should be above 10°C.
- ✓ Put the appliance in a dry place, avoiding areas of high moisture or humidity.
- ⊘ Don't put the appliance in frosty or unprotected areas, for example in a garage or on a verandah.
- ⊘ Don't put the appliance in direct sunlight.
- ⊘ Don't put the appliance near stoves, fires or heaters.

When correctly installed, your appliance should:

- have adequate clearance to the back and sides for air circulation (refer to page 4).
- be aligned to the surrounding cupboards.
- have doors that will self-close from a partially open position.

warning

- Have the stability foot in place (see diagrams on pages 4 and 5) to prevent the appliance falling forward when a door with heavy food load is opened.

Installing your new refrigerator

Clearance around your Side by Side refrigerator

Your Side by Side Refrigerator can be installed between cupboards or fixtures but you must allow for the following spaces around the cabinet.

1. allow a minimum of 5mm clearance on both sides.
2. allow 10mm clearance at the back of the refrigerator.
3. allow a minimum of 10mm clearance above hinge covers.
4. If you do not have a cupboard with a rear gap, the recommended clearance area on top increases from 50mm to 90mm (x) and from 32mm to 72mm (y).

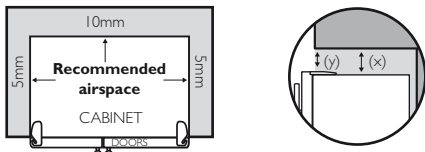

5. allow a 250 or 300mm clearance on the hinge side of the doors, if you place the refrigerator next to the wall. This will make cleaning easier.

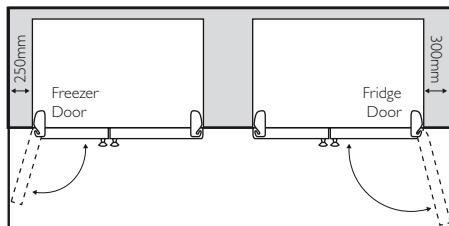

6. make sure that cupboards or fixtures do not stick out further than the refrigerator cabinet.

Clearance around your Top and Bottom Mount refrigerator

1. allow a minimum of 5mm clearance on both sides.
2. allow 10mm clearance at the back of the refrigerator.
3. allow a minimum of 10mm clearance above hinge covers.
4. If you do not have a cupboard with a rear gap, the recommended clearance area on top increases from 50mm to 90mm.
5. When positioned in a corner area, spacing of at least 350mm on the hinge side will allow the doors to open enough to enable the removal of bins and shelves.

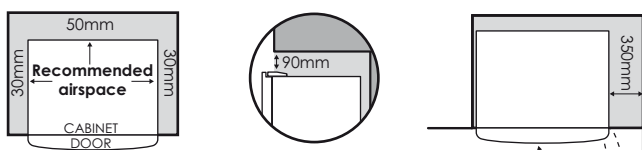

Note: Doors on all models are designed to sit proud of cabinetry (not flush). The refrigerator should be placed against a wall and the gap between the rear of the refrigerator and the wall should be no greater than 75mm.

Installing your refrigerator

The appliance should arrive with the front adjustable rollers wound down to tilt the top of the refrigerator backwards by about 10-15mm from upright.

The stability foot should also be wound fully up so it will not interfere with the operation of the rollers (see diagram in Step 3 below).

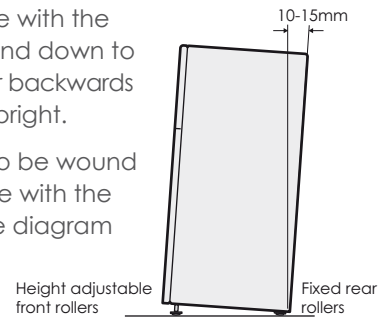

caution

The rollers are designed for forward or backward movement only. They are not castors. Moving the refrigerator sideways may damage your floor and the rollers.

1. Roll the refrigerator into its final position.
2. The top of the refrigerator should be tilted back by approximately 10-15mm. This will allow the doors to self-close providing a consistent door seal.
3. If the refrigerator is not tilted back, you can adjust the two front rollers by turning the large, plastic roller nut (see diagram below). This will increase the height of the rollers. One turn of the nut will tilt the refrigerator back approximately 10mm. If you have difficulty turning the roller nut you can have someone tilt the refrigerator back, so that you have better access. Alternatively, you can access the rollers from the side, using a flat screwdriver to help you turn the nut (see diagram below).

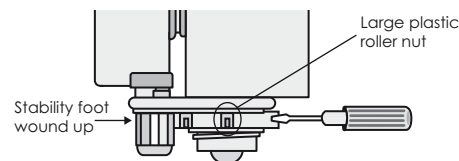

4. Check the alignment of the refrigerator to the surrounding cupboards. The top of the refrigerator should be level from side to side (see diagram below). If you need to adjust the level, use the adjustable rollers as discussed in Step 3.

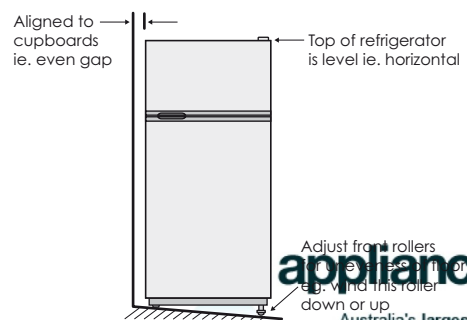

appliancesonline.com.au
Australia's largest online appliance retailer

- If the refrigerator now rocks from one corner to the opposite rear corner, this means that the floor is uneven; you will need to put some packing under one of the rear rollers. You could use thin pieces of solid material, such as thin board, vinyl floor tiles or laminate. Place the packing so that it will sit under one of the rear rollers when the refrigerator is rolled into position.
- You may now need to fine-tune the installation by repeating Steps 3, 4 and 5.
- When you have the appliance in its final position, it needs to be stabilised. Wind the stability foot down to the floor until it just makes contact with the floor. Lift the front of the appliance to take the weight off the stability foot, then turn it $\frac{1}{4}$ turn further to ensure firm contact with the floor. Whenever you need to move the appliance, be sure to wind the foot back up so that the appliance can roll freely and be sure to reset it when reinstalling.

Whenever you need to move the refrigerator, be sure to wind the foot back up so that the refrigerator can roll freely.

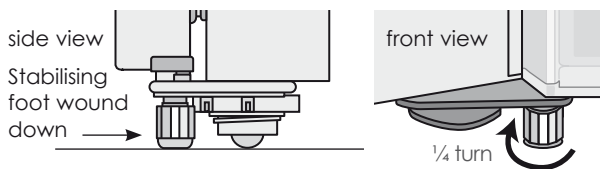

- Clean your refrigerator thoroughly following the instructions on page 11 and wipe off any dust that has accumulated during shipping.
- Plug the refrigerator into the power point. Don't use a double adaptor. **If you need to roll the refrigerator out to get at the power point, remember to raise the stability foot before you do so.**
- We recommend that you let your refrigerator run for two to three hours before you put any food in it. This will allow you to check that it is operating properly.

Congratulations! You have successfully installed your new refrigerator.



caution

Keep ventilation openings, in the appliance enclosure or in the built-in structure clear of obstruction.

Adjusting door alignment – Side by Side refrigerator only

Each door is independently adjustable in the vertical direction by turning the adjustable bolts under the hinges using a spanner.

The doors can be adjusted up or down. Depending on the amount of adjustment required it may be sufficient to adjust only one door. (see Diagrams below)

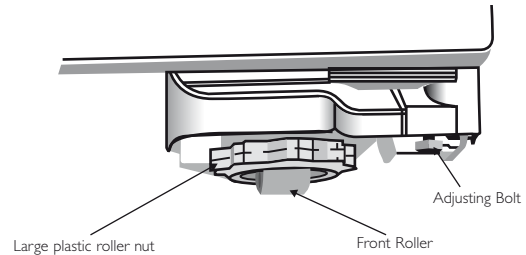

Note: When the height of the rollers and adjusting bolts are correctly adjusted the refrigerator will stand firmly on the floor then adjust door alignment as required.

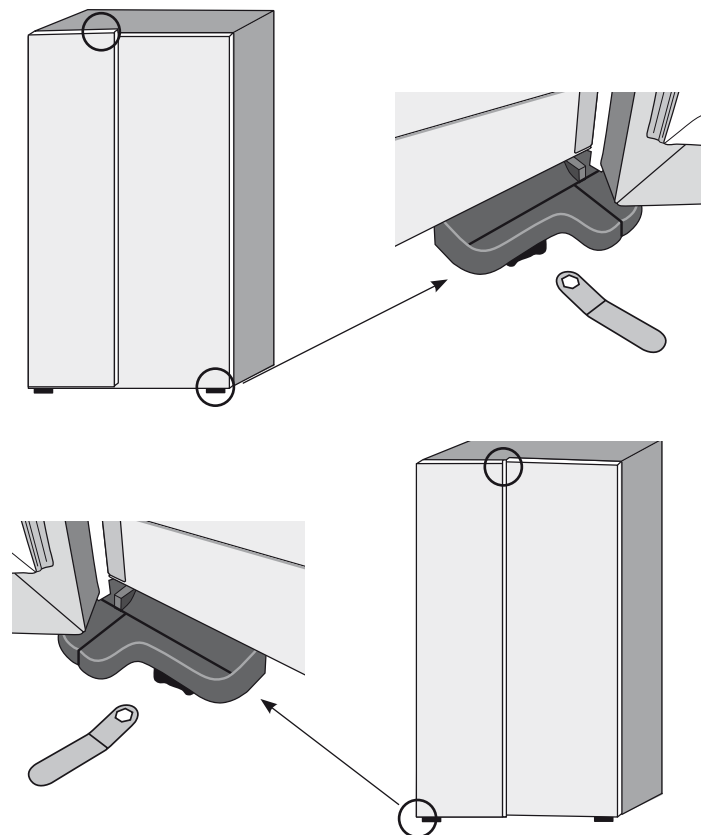

Side by Side model features

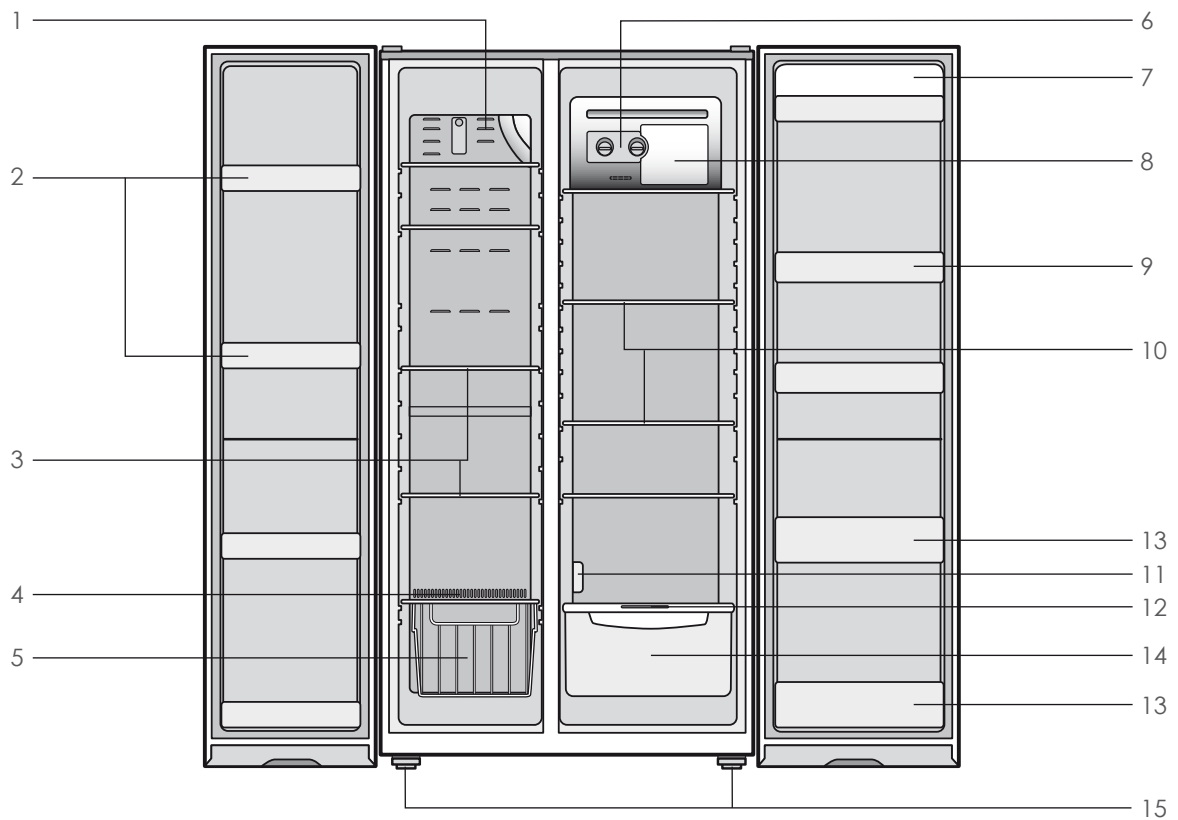

Side by Side model

Note: Product illustrations demonstrate various features but may not be completely in line with current products.

- | | |
|---|--|
| 1 Freezer air outlets | 10 Adjustable spill safe slide-out glass shelves |
| 2 Adjustable freezer door bins | 11 Fridge air return vent |
| 3 Adjustable spill safe slide-out glass shelves | 12 Crisper humidity control |
| 4 Freezer air returns | 13 Bottle bins |
| 5 Freezer roll out basket | 14 Crisper |
| 6 Temperature controls | 15 Adjustable rollers |
| 7 Dairy bin | |
| 8 Fridge light | |
| 9 Adjustable fridge door bins | |

Top and Bottom Mount model features

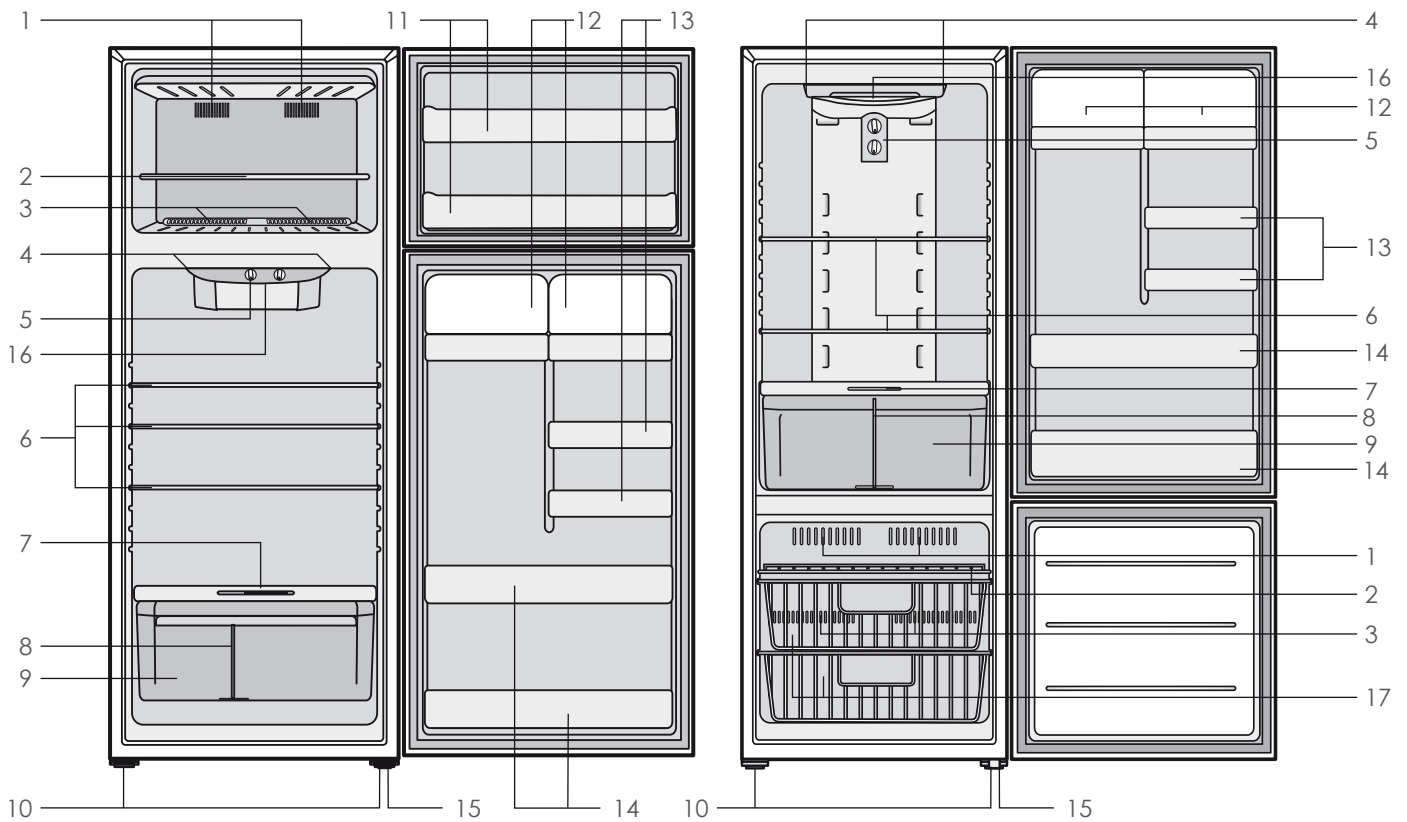

Top Mount model

Bottom Mount model

Note: Product illustrations demonstrate various features but may not be completely in line with current products.

- 1 Freezer air outlets
- 2 Wire shelves
- 3 Freezer air returns
- 4 Fridge air outlets
- 5 Temperature controls
- 6 Glass shelves
- 7 Crisper humidity control
- 8 Crisper divider (where fitted)
- 9 Full width crisper (where fitted)

- 10 Adjustable rollers
- 11 Full width freezer door bins
- 12 Dairy compartment
- 13 Half width door bins
- 14 Full width door bins
(two bins on selected models only)
- 15 Stabilising foot
- 16 Fridge light

Bottom Mount model additional features

- 17 Freezer basket

Refrigerator and freezer operation

The refrigerator transfers heat from food placed inside the appliance to the outside air.

This process makes the rear, the sides and the area adjacent to the doors, particularly at initial start up, feel warm. This is normal.

There is a cooling coil located behind the rear wall of the cabinet. This coil cools and removes moisture from the air. A fan then circulates cold, dry air throughout the cabinet.

This air circulation means that foods are refrigerated far more quickly than in refrigerators where the air remains relatively static.

Avoid placing food against air outlets as this will affect air circulation.

A light frosting will occasionally occur on the cold interior of the freezer when the door is opened frequently. This is normal and will disappear after a few days in most climates.

Make sure you fully close the freezer door after you load or remove food. If the door is left partly open, a heavy frost will coat the inside of the freezer. If a frost develops, remove it. Take care to properly close the door and the frost will not reoccur. If the food is placed forward of the ribs on the bottom of the freezer, it will keep the door open. Ensure that all food is stored behind the ribs.

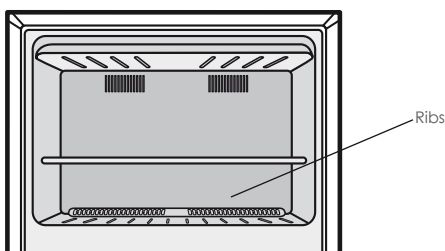

Your new energy efficient appliance uses a high-speed compressor and other energy efficient components that may produce different noises to your old appliance.

These sounds are normal and include:

- compressor running noise.
- air movement noise from the small fan motor.
- occasional gurgling, similar to water boiling.
- a popping noise, heard during automatic defrosting.
- a clicking noise, just prior to the compressor starting up.

These noises are normal and not cause for alarm.

Further details can be found on page 13.

Controlling the temperature

Set the temperature by using the main temperature controls at the rear of the refrigerator compartment. When you first start your refrigerator, set both refrigerator and freezer controls to MID. The refrigerator temperature control is affected by altitude and it is recommended that it be set warmer to compensate. e.g. at 1000 metres above sea level set the refrigerator temperature control to one setting warmer than MID.

i tips and information

A good indication of optimal freezer temperature is ice cream that is frozen, but still soft enough for easy scooping.

For the fridge compartment, we recommend using drinking water and simply adjusting the fridge controls until the water is at your ideal temperature.

To change settings. When you change temperature settings, make small adjustments and wait 24 hours before assessing whether you need to make any further changes.

Side by Side temperature control

Adjusting the refrigerator temperature – side by side model

1. Select the refrigerator control (right knob).
2. Rotate the knob clockwise to set colder.
3. Rotate the knob anti-clockwise to set less cold.

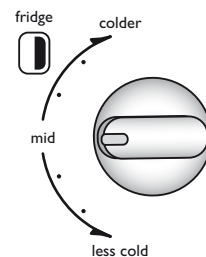

Adjusting the freezer temperature – Side by Side model

1. Select the freezer control (left knob).
2. Rotate the knob clockwise to set colder.
3. Rotate the knob anti-clockwise to set less cold.

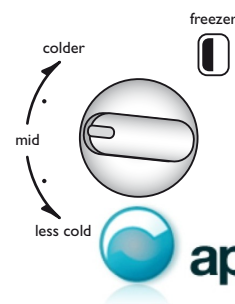

Top Mount temperature control

Adjusting the refrigerator temperature – Top Mount freezer (TM) model

1. Select the refrigerator control (bottom knob).
2. Rotate the knob clockwise to set colder.
3. Rotate the knob anti-clockwise to set less cold.

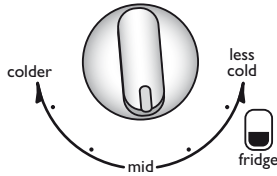

Adjusting the freezer temperature – Top Mount freezer (TM) model

1. Select the freezer control (top knob).
2. Rotate the knob clockwise to set colder.
3. Rotate the knob anti-clockwise to set less cold.

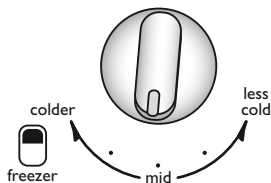

Bottom Mount temperature control

Adjusting the refrigerator temperature – Bottom Mount freezer (BM) model

1. Select the refrigerator control (top knob).
2. Rotate the knob clockwise to set colder.
3. Rotate the knob anti-clockwise to set less cold.

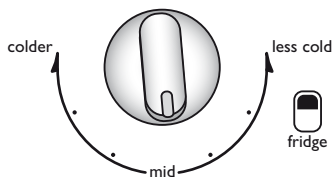

Adjusting the freezer temperature – Bottom Mount freezer (BM) model

1. Select the freezer control (bottom knob).
2. Rotate the knob clockwise to set colder.
3. Rotate the knob anti-clockwise to set less cold.

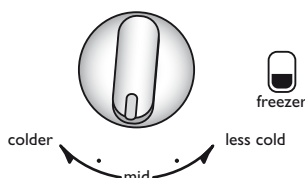

The refrigerator temperature control is affected by altitude and is recommended that it be set warmer to compensate. e.g. at 1000 metres above sea level set the refrigerator temperature control to one half setting warmer than MID.

Wait 24 hours after changing settings: When you change temperature settings, make small adjustments and wait 24 hours before assessing whether you need to make any further changes.

NB: Testing ice cream is a good way to check the freezer temperature. Testing drinking water is a good way to check the refrigerator compartment temperature.

i tips and information

- Coldest freezer setting is not recommended in normal and very hot climates as this will limit the cooling to the refrigerator section.
- In very cold climates (where temperatures are below 10°C) the freezer may need to be set colder.
- Adjustment of the fridge compartment temperature may cause a small movement in freezer temperature.

Chill Channel – Side by Side model only

The chill channel allows air to circulate through your refrigerator. For optimum cooling, keep the channel behind your shelves clear.

Try to avoid storing plates, trays or any object that may extend beyond the back edge of your shelves. Doing so may block the cold air flow from the vents located in the control housing, causing uneven temperatures in your refrigerator. This may also freeze items stored on the top shelf.

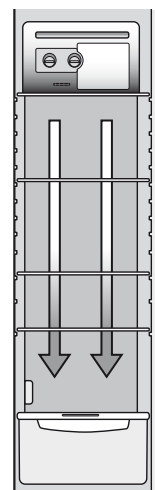

Using your refrigerator

This section tells you how to make the most of the many useful features and how to clean them.

Door storage bins

Both refrigerator and freezer are fitted with door storage bins. You can adjust the refrigerator bins to meet different storage needs. All the door bins are completely removable for cleaning. If you want to remove or adjust a bin, lift it over the support lugs on the inner door panel. To replace, push the bin down over the support lugs to lock it in place.

Crisper bin

You can use the crisper bin to store vegetables, fruit or smallgoods. You can change the humidity inside the bin by sliding the humidity control.

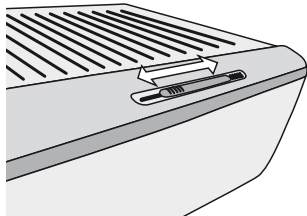

- **Storing vegetables**

You should store vegetables in the crisper bin remembering to set the humidity control to more humid (closed).

- **Storing fruit & smallgoods**

You can also store fruit & smallgoods in the crisper bin remembering to set the humidity control to less humid (open).

Changing the light bulb

Changing the light bulb – Side by Side fridge

1. Switch off the power at the power point and remove the refrigerator's power cord from the power point.
2. Carefully unclip the light cover. You do this by inserting your fingers behind the top of the light cover and pulling it out while at the same time pushing it up at the bottom.

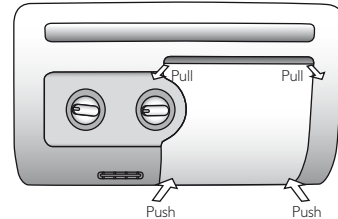

3. Pull the cover out until it is clear of the housing.
4. Unscrew the light bulb and replace it with a bulb that is the same as the original.
5. Replace the cover by inserting the tab back into place and pushing in the cover with both hands at the top.
6. Wait 5 minutes to ensure pressures in the refrigeration system are equalized. Then reconnect and turn the refrigerator on at the power point.

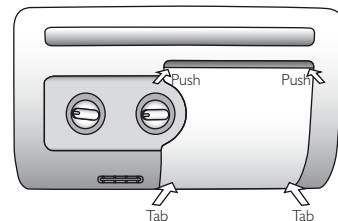

Changing the light bulb – Top and Bottom Mount fridge

1. Switch off the power at the power point and remove the refrigerator's power cord from the power point.
2. Carefully unclip the light cover. You do this by pushing the light cover tabs at the front towards the back of the cabinet, then lowering the cover down.

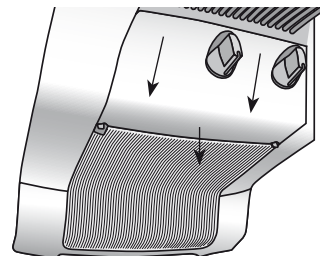

3. Unscrew the light bulb and replace it with a bulb that is the same as the original, as specified on the rating plate behind the cover.
4. Replace the light cover by hooking the light cover lugs into the rear of the housing and pressing the front of the cover until it clips in.

5. Wait 5 minutes to ensure pressures in the refrigeration system are equalized. Then reconnect and turn the refrigerator on at the power point.

Cleaning your refrigerator



warning

Before cleaning: Turn appliance off at the power point, then remove power cord from socket. This will make sure there is no chance of getting an electric shock.

Doors and exterior

You should only clean the doors with lukewarm soapy water and a soft cloth, rinsing with clean water and then wipe the surface with clean water and a soft clean cloth to remove soap residue.



caution

Do not use stainless steel cleaners, abrasive pads or other cleaners as they are likely to scratch the surface. Damage to this product after delivery is not covered by your warranty.

Interior

You should clean the appliance interior regularly. It will be easiest to clean when the food supply is low. Wash the interior with a soft cloth and use an unscented mild soap with lukewarm water. Thoroughly dry all surfaces and removable parts. Avoid getting water on appliance controls. If you have taken out any removable parts, replace them and switch the power on before re-stocking the appliance with food. Naturally, you should keep the interior of your appliance hygienic by promptly and thoroughly wiping up any food spills.

Door seals

Take care to keep door seals clean. Sticky food and drink can cause seals to stick to the cabinet and tear when you open the door. Wash seal with a mild detergent and warm water. Rinse thoroughly and dry.



warning

Never use hot water, solvents, commercial kitchen cleaners, aerosol cleaners, metal polishes, caustic or abrasive cleaners, or scourers to clean this appliance, as they will damage it. Many commercially available cleaning products and detergents contain solvents that will damage your refrigerator. When cleaning, use only a soft cloth with an unscented mild soap and lukewarm water.

Energy consumption

(electricity costs)

The following guide will help you reduce the running cost of your new refrigerator. This will save you money and help conserve our valuable energy resources.

1. If you keep your old refrigerator, save power by switching it off when not in use.
2. Do not set your freezer temperature too low. After 24 hours, ice cream should be firm but able to be scooped out with a spoon without bending the handle. If ice cream is firmer than this (or too soft), adjust the freezer temperature controls (see 'Temperature control', page 8).
3. Ensure that the refrigerator doors seal properly as you close them.
4. Before you open the refrigerator doors, decide what you want to put in or take out. This will minimize the time you have the doors open.
5. It is best to have the refrigerator in a place that is out of direct sunlight and away from heating appliances of any kind. For example, do not place the refrigerator next to a cooker, stove or dishwasher.
6. Allow hot foods to cool to room temperature before you put them in your freezer.
7. Thaw frozen food in the refrigerator section.
8. If you keep the freezer compartment filled to capacity, your food mass will help maintain the freezer temperature when you open the door.
9. Do not block air vents. Doing so may cause the refrigerator to run longer and use more energy.

Turning off the refrigerator

If you are leaving for a short holiday, there is no need to turn off your refrigerator .

If you are going on a long holiday and want to turn the refrigerator off, follow the steps below.

1. Take all the food out of the refrigerator and freezer compartments.
2. Switch off the refrigerator and remove the electric cord from the power point.
3. Clean the inside.
4. Leave the doors open. This prevents bacteria from growing and causing smells in the refrigerator.

Power failure

If there is a power failure in your area, keep the door to the freezer closed. Most foods in your freezer will stay frozen for 24 hours.

Safety

It is important to use your appliance safely. This means you need to supervise young children and infirm persons when they use it. You need to make sure that young children do not play with the appliance. Follow the tips below.

Always do this

- ✓ Check the power point is properly grounded – if you are not sure get an electrician to check it.
- ✓ Switch off the appliance at the power point before you clean or move it.
- ✓ If the supply cord is damaged you should have it replaced by the manufacturer, it's service agent or similarly qualified person. This will prevent a safety hazard.

Never do this

- ⊘ Never let children play with the appliance.
- ⊘ Never store spray cans, explosive liquids or flammable liquids in the refrigerator.
- ⊘ Never store fizzy drinks in the freezer compartment.
- ⊘ Never lick icy foods when they first come out of the freezer. This can freeze burn your lips and mouth.
- ⊘ Never try to repair the appliance yourself.
- ⊘ Never use electric heaters or dryers to defrost the freezer because you can receive an electric shock.
- ⊘ Never use electrical appliances inside the food storage areas.
- ⊘ This appliance contains insulation formed with flammable blowing gases. For safety reasons, take care when you dispose of it.
- ⊘ Do not damage the appliance circuit.



warning

When you dispose of your old refrigerator or freezer, remove any doors. Children can suffocate if they get trapped inside.

Helpful hints

Helpful hints for storing food

Always do this

- ✓ Buy the freshest, best quality food and put it in the refrigerator as soon as possible.
- ✓ Cover food with plastic wrap or foil to stop it drying out and to help prevent bad smells.
- ✓ Rinse and wrap fish and poultry before you put them in the refrigerator.
- ✓ Minimise bacteria by removing stuffing from poultry before you put it in the refrigerator.
- ✓ When you store eggs in the refrigerator compartment, store them with the pointed end down.

Never do this

- ⊘ Store bananas, avocados or mangoes in the refrigerator. This can cause them to go black or to go soft.
- ⊘ Put hot or warm food in the refrigerator. Allow it to cool first.

Helpful hints for freezing food

You can use the freezer to store food which you buy in bulk when prices are low. You can also cook extra food and freeze it for later use.

Always do this

- ✓ Buy the freshest, best quality food and put it in the freezer as soon as possible.
- ✓ Place food in plastic bags or plastic wrap before you put it in the freezer.
- ✓ Squeeze the air out of plastic bags as this prevents frost.
- ✓ When you buy frozen foods in the supermarket, keep them in their packaging when you store them.
- ✓ Defrost food, especially chicken and fish, in the refrigerator compartment. This stops bacteria from growing.
- ✓ Leave food in its wrapping while it defrosts.
- ✓ Use defrosted food immediately.

Never do this

- ⊘ Never refreeze defrosted food.

Troubleshooting

If you think something may be wrong with your refrigerator, you can carry out some easy checks before calling for service. You may locate the problem, sparing yourself from inconvenience and saving time and money.

Problem	Solution
When your appliance is not operating	<ul style="list-style-type: none"> • Check that the power cord is plugged into the power outlet properly and that the outlet is switched 'ON'. • Try running another appliance from the power outlet. If no power is coming from the outlet you may have blown a fuse or tripped a circuit of your household power supply. • Try adjusting the temperature control to a slightly "colder" position. • It is normal for the freezer fan NOT to operate during the automatic defrost cycle, or for a short time after the appliance is switched on.
When there is refrigerator/freezer noise	<p>Modern refrigerators/freezers with increased storage capacity use high speed compressors. These can provide a seemingly high level of sound which is quite normal. Normal operational sounds include:</p> <ul style="list-style-type: none"> • Occasional gurgling, similar to water boiling. • Air flow noise (air circulates because of a small fan). • A popping noise heard during automatic defrost. <p>Other strange sounds may mean that you need to check and take action. For example, noises may mean that:</p> <ul style="list-style-type: none"> • The cabinet is not level. • The floor is uneven or weak. • Bottles are badly placed and rattling. • There are vibrations from an object on top of or behind or beside the refrigerator. • The back of the refrigerator cabinet is touching the wall. <p>Remember it is quite normal for noise to seem louder just after the refrigerator starts operating.</p>
If there are odours inside the appliance	<ul style="list-style-type: none"> • The interior may need cleaning. • Some foods produce odours. • Some containers and wrapping can cause odours. • Ask yourself if the odour started about the same time you started storing something unusual.
When the motor seems to run more than expected	<p>Your new appliance provides you with large capacities in both the refrigerator section and the separate freezer. It is normal for the motor to operate frequently. However, to keep operation to a minimum, check the following:</p> <ul style="list-style-type: none"> • Are doors kept open too long or too often? • Are controls set too cold? Refer to page 8 "Temperature control". • Have large amounts of warm food just recently been stored? Summer, festive seasons and holidays usually mean a lot more work for your appliance. <ul style="list-style-type: none"> • If the day is hot or the room is very warm, the appliance will need to run more than normal. • The appliance will run more than normal just after you install it or when it has been turned off for a long time.
If the temperature in the refrigerator is too warm	<ul style="list-style-type: none"> • Check that the appliance has enough clearance at the sides, back and top. Refer to page 4 "Installing your new refrigerator". • Refer to page 8 "Temperature control". • You may have kept the door open too long or too frequently. • Food containers or packaging may be holding a door open.
If the temperature in the refrigerator is too cold	<ul style="list-style-type: none"> • Refer to page 8 "Temperature control". • Increase the temperature to avoid high energy consumption.
If heavy frosting occurs in the freezer	<p>Make sure you fully close the freezer and fridge doors. If the doors are left partly open a heavy frost will coat the inside of the freezer. If a frost develops, remove it. Take care to properly close the doors and the frost will not reoccur.</p>
If water drips on the floor	<p>The defrost water tray, (located on the compressor at the back of the cabinet), may not be properly positioned, or the drain tube may not be properly positioned to direct water into this tray. You may need to pull the refrigerator away from the wall to check the tray and tube.</p>

If you still require service

If you have a problem, and the problem persists after you have made the checks mentioned above, contact your nearest Electrolux approved Service Centre or the dealer you bought the refrigerator from. Be ready to quote the model number, 9-digit PNC and 8-digit serial number, which is stated on the label inside the refrigerator compartment.



Electrolux Warranty

FOR SALES IN AUSTRALIA AND NEW ZEALAND
APPLIANCE: KELVINATOR SIDE BY SIDE, TOP AND BOTTOM MOUNT FRIDGE FREEZER

This document sets out the terms and conditions of product warranties for Electrolux branded appliances. It is an important document. Please keep it with your proof of purchase documents in a safe place for future reference should you require service for your Electrolux appliance.

General Terms and Conditions

- In this warranty
 - 'Electrolux' means Electrolux Home Products Pty Ltd ABN 51 004 762 341 in respect of Appliances purchased in Australia and Electrolux (NZ) Limited in respect of Appliances purchased in New Zealand;
 - 'Appliance' means any Electrolux product purchased by you accompanied by this document;
 - 'Warranty Period' means
 - where you use the Appliance for personal, domestic or household purposes in Australia the period of '24' months and in New Zealand the period of '24' months;
 - where you use the Appliance for commercial purposes, in Australia the period of '3' months and in New Zealand the period of '3' months, (if the period stated is 0 months you are not covered by this product warranty) following the date of original purchase of the Appliance;
 - 'you' means the purchaser of the Appliance not having purchased the appliance for re-sale, and 'your' has a corresponding meaning.
- This warranty only applies to Appliances purchased and used in Australia or New Zealand and is in addition to (and does not exclude, restrict, or modify in any way) any non-excludable statutory warranties in Australia or New Zealand.
- Electrolux warrants that, when dispatched from an Electrolux warehouse, the Appliance is free from defects in materials and workmanship for the Warranty Period.
- During the Warranty Period Electrolux or its Authorised Service Centre will, at no extra charge if your appliance is readily accessible without special equipment, and subject to these terms and conditions, repair or replace any parts which it considers to be defective. Electrolux or its ASC may use reconditioned parts to repair your appliance. You agree that any replaced Appliances or parts become the property of Electrolux. This warranty does not apply to light globes, batteries, filters or similar perishable parts.
- Parts and Appliances not supplied by Electrolux are not covered by this warranty.
- Where you are within an Electrolux service area, this warranty covers the cost of transport of the Appliance to and from Authorised Service Centres of Electrolux and travelling costs for representatives of the Authorised Service Centre to and from your home or business. If you are outside an Electrolux service area, you will bear these costs. For information about whether you are within an Electrolux service area, please phone 13 13 49 in Australia, or 0800 10 66 10 in New Zealand.
- Proof of purchase is required before you can make a claim under this warranty.
- You may not make a claim under this warranty unless the defect claimed is due to faulty or defective parts or workmanship. Electrolux is not liable in the following situations (which are not exhaustive):
 - The Appliance is damaged by:
 - accident
 - misuse or abuse, including failure to properly maintain or service
 - normal wear and tear
 - power surges, electrical storm damage or incorrect power supply
 - incomplete or improper installation
 - incorrect, improper or inappropriate operation
 - insect or vermin infestation.
 - The Appliance is modified without authority from Electrolux in writing.
 - The Appliance's serial number or warranty seal has been removed or defaced.
 - The Appliance was serviced or repaired by anyone other than Electrolux or its Authorised Service Centres.
- This warranty, the contract to which it relates and the relationship between you and Electrolux are governed by the law applicable in the Australian State where the Appliance was purchased or the law applicable in

New Zealand if the Appliance was purchased in New Zealand. Where the Appliance was purchased in New Zealand for business purposes the Consumer Guarantee Act does not apply.

Limitation of Liability

- To the extent permitted by law:
 - Electrolux excludes all warranties other than as contained in this document;
 - Electrolux shall not be liable for any loss or damage whether direct or indirect or consequential arising from your purchase, use or non-use of the Appliance.
- Provisions of the Trade Practices Act and State consumer legislation in Australia, and the Consumer Guarantees Act, the Sale of Goods Act and the Fair Trading Act in New Zealand, imply warranties or conditions, or impose obligations, upon Electrolux which cannot be excluded, restricted or modified. To the extent permitted by law, the liability of Electrolux (if any) arising out of or in relation to the Appliance or any services supplied by Electrolux shall be limited (where it is fair and reasonable to do so):
 - in the case of Appliances, at its option, to the replacement or repair of the Appliances or the supply of equivalent products or the payment of the cost of replacing the Appliances or having the Appliances repaired or of acquiring equivalent Appliances. Upon being replaced, parts and Appliances become the property of Electrolux; or
 - in the case of services, at its option, to the supply of the services again or the payment of the cost of having the services re-supplied; and in the case of Appliances or services supplied in New Zealand, loss or damage whether direct or indirect or consequential that is reasonably foreseeable.

Privacy

You acknowledge that in the event that you make a warranty claim it will be necessary for Electrolux and its Authorised Service Centres to exchange information in relation to you to enable Electrolux to meet its obligations under this warranty.

EXTENDED WARRANTIES AND INDEMNITY

Sealed Refrigeration System Warranty

For a further period of three years following the expiry of the Warranty period, Electrolux or its agent will supply replacements for, or at the sole option of Electrolux, repair, all parts it finds defective in the Sealed Refrigeration System which comprises: compressor, condenser, evaporator, dryer and tubing. During this three year period you will pay for the costs of labour (including any call out or service fees), and freight if necessary in replacing defective parts in the Sealed Refrigeration System. You will pay for the costs of transport of the Appliance if further service is required and the costs of parts or repairs to parts other than those included in the Sealed Refrigeration System

Frozen Food indemnity

Subject to the following exclusions, Electrolux will indemnify you for a period of 24 months from the date of purchase of the Appliance against any loss or damage to frozen foodstuffs due to a Sealed Refrigeration System breakdown. This indemnity will be limited to:

- in the case of freezers with a capacity of less than 400 litres – AU\$150
- in the case of freezers with a capacity of 400 litres or more – AU\$300

This indemnity does not cover loss or damage to frozen foodstuffs occasioned by:

- failure to plug in the freezer to a properly connected power supply or failure to switch on the power point
- accidental removal of the plug from the power point or switching off the power supply;
- failure to keep the door or lid of the freezer closed
- the introduction of abnormal heat loads to the freezer;
- failure to observe the operating and installation instructions supplied with the freezer; and
- failure to defrost the freezer at recommended intervals on chest freezers or non frost free models

Important Notice

Before Calling a Service Technician please check carefully the operating instructions, service booklet and the warranty terms and conditions.

<p>FOR SERVICE or to find the address of your nearest state service centre in Australia PLEASE CALL 13 13 49 For the cost of a local call (Australia only)</p>	<p>SERVICE AUSTRALIA  ELECTROLUX HOME PRODUCTS www.electrolux.com.au</p>	<p>FOR SPARE PARTS or to find the address of your nearest state spare parts centre in Australia PLEASE CALL 13 13 50 For the cost of a local call (Australia only)</p>
<p>FOR SERVICE or to find the address of your nearest authorised service centre in New Zealand FREE CALL 0800 10 66 10 (New Zealand only)</p>	<p>SERVICE NEW ZEALAND  ELECTROLUX HOME PRODUCTS www.electrolux.co.nz</p>	<p>FOR SPARE PARTS or to find the address of your nearest state spare parts centre in New Zealand FREE CALL 0800 10 66 20 (New Zealand only)</p> <p> Australia's largest online appliance retailer</p>

If you'd like further information about Kelvinator appliances, please visit your retailer, phone or email our Customer Care team or visit our website.

Phone: 1300 363 640

Fax: 1800 350 067

Email: customercare@electrolux.com.au

Web: www.kelvinator.com.au