

## TRANSPORTATION RESEARCH SYNTHESIS

Minnesota Department of Transportation  
Office of Transportation System Management  
Research Services & Library  
651-366-3780  
[www.mndot.gov/research](http://www.mndot.gov/research)

TRS 1809

December 2018

# USE OF CONTINUOUS GREEN T-INTERSECTIONS

*Prepared by CTC & Associates LLC*

**Intersections within roadway systems** create points of conflict for motorists and nonmotorized users who turn onto or cross another path of traffic. While intersections make up only a small part of the highway system, they are the points at which more than 50 percent of urban crashes and over 30 percent of rural crashes occur, according to a 2004 report by the National Cooperative Highway Research Program. Signalized intersections are designed to separate and control conflict for all modes of transportation, including vehicles, pedestrians and bicycle traffic. Yet 30 percent of fatal crashes at intersections occur at signalized intersections. To address this safety issue and to improve traffic flow, some highway designers have replaced conventional intersections with low-cost alternative strategies, including the Continuous Green T-Intersection (CGT).



The MnDOT Office of Project Management & Technical Support sought information about the state of the practice among state departments of transportation (DOTs) concerning the extent of CGT use and DOT experiences with CGT implementation, maintenance, design guidance and use. This Transportation Research Synthesis includes the results of a survey of highway design and roadway geometry professionals regarding their knowledge and use of CGTs. State-level design standards and technical guidance were also requested and are included.

## **Technical Advisory Panel**

**Douglas Carter**, P.E., MnDOT State Geometrics Engineer, Technical Liaison  
MnDOT Office of Project Management & Technical Support

**Sharon M. Van Sluijs**, Principal Investigator  
CTC & Associates LLC

**Mark Linsenmayer**, Principal Investigator  
CTC & Associates LLC

**Dan Warzala**, Project Coordinator  
MnDOT Research Services & Library

**Matthew Schleusner**, Panelist  
MnDOT Office of Project Management & Technical Support

*The purpose of this TRS is to serve as a synthesis of pertinent completed research to be used for further study and evaluation by MnDOT. This TRS does not represent the conclusions of either the authors or MnDOT.*

# Use of Continuous Green T-Intersections

## Introduction

The Federal Highway Administration (FHWA) and National Cooperative Highway Research Program (NCHRP), among others, have reported on the safety risks inherent in at-grade highway and street intersections. While intersections physically represent a small portion of roadway systems in the United States, approximately 50 percent of urban crashes and 30 percent of rural crashes occur at the meeting or crossing of roadways. Intersections are a dangerous conflict point for motorists and nonmotorized users within roadway systems.

To address this safety issue, highway designers have developed low-cost alternative geometric strategies to improve traffic flow and safety at intersections. Among the many alternative intersection designs in use today is the Continuous Green T-Intersection (CGT). A 2016 FHWA study (see **Related Research**) showed that the safety of CGTs compares favorably with that of conventional T-intersections.

The MnDOT Office of Project Management & Technical Support sought information from other state departments of transportation (DOTs) about their use of CGTs. This Transportation Research Synthesis includes the results of a survey of highway designers and roadway geometry professionals about their knowledge and use of CGTs. Design standards and guidance documents were requested and are included when available.

## Summary of Findings

This Transportation Research Synthesis is divided into two sections:

- Survey of Practice.
- Related Research.

## Survey of Practice

An online survey was distributed to members of the AASHTO Subcommittee on Design and the AASHTO Technical Committee on Geometric Design. Seventeen state DOTs responded to the survey; seven DOTs (Arizona, California, Illinois, Iowa, North Carolina, Pennsylvania and Virginia) indicated their state's use of CGTs, and one DOT (Indiana) reported no current CGTs but that future construction was likely. Below is an overview of survey results in the following topic areas:

- Use of CGTs.
- Design guidance and considerations.
- CGT assessment.

## **Use of Continuous Green T-Intersections**

Respondents from all seven state DOTs using CGTs reported that their state has one to three CGTs in use. Three respondents were also aware of CGTs that had been constructed by city or county agencies.

## Design Guidance and Considerations

### Design Guidance

DOT respondents provided a limited number of national and state resources used in CGT design and construction. The 2018 American Association of State Highway and Transportation Officials (AASHTO) manual, A Policy on Geometric Design of Highways and Streets (the AASHTO Green Book), was mentioned specifically by three respondents, while two others cited Federal Highway Administration (FHWA) guidance. Another DOT uses state policy in combination with FHWA guidance. One respondent cited the state’s highway design manual and the state Manual of Unified Traffic Control Devices.

### Factors Considered When Choosing a CGT

Respondents were asked to rank the importance of five considerations relevant to converting an intersection to a CGT: safety, traffic flow, cost benefit, cost of conversion and environment. Safety and traffic flow were chosen as very important factors by most respondents. Cost benefit was chosen as a moderate concern followed by cost of conversion and environment. The chart below illustrates the ranking of considerations by respondents:

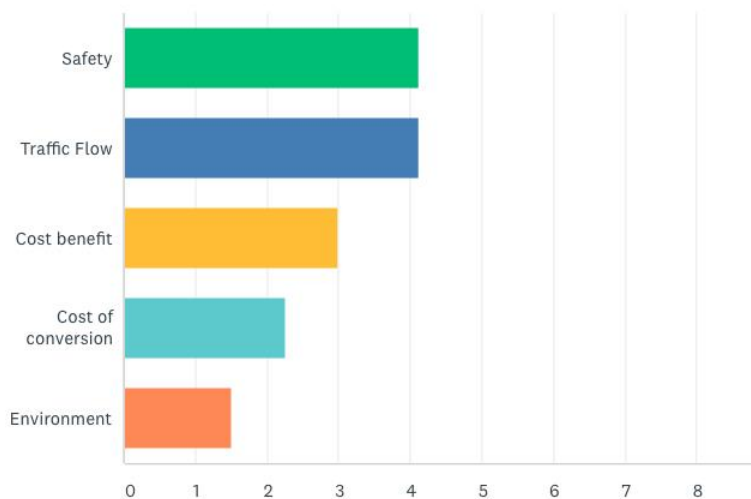

\*Results include rankings from Indiana DOT, which is considering constructing CGTs.

### DOT Priorities for Converting to CGTs

#### Traffic Control Features

When asked to indicate which traffic control features their CGTs employ, seven of eight respondents reported using signalized control. Four respondents reported also using stop signs, while one noted that stop signs, yield signs and signalized control were all used.

#### Use of Annual Average Daily Traffic Data

None of the respondents reported using annual average daily traffic (AADT) data to determine an intersection’s candidacy for conversion to a CGT.

### ***Geometric Transitions***

Respondents were asked to describe practices used to make geometric transitions (two-lane to four-lane) and to design acceleration lanes. Among the practices reported were using lane taper criteria, medians, a bypass lane for free flow traffic, and a channelized left turn entrance and exit lane. Respondents reported using national and state guidance for constructing these features, including the AASHTO Green Book.

### **Continuous Green T-Intersection Assessment**

Among the operational or safety concerns with CGTs was the need for a long acceleration lane, a raised median or other physical separation without access or side friction. Other concerns included truck acceleration, pedestrian crossings, driver confusion, traffic control devices and driveways. Four respondents reported they were not aware of any operational or safety concerns with CGTs.

Survey respondents listed many advantages and disadvantages of continuous green T-intersections. Advantages included time savings and safety, as well as improved traffic flow. The ability to construct a signalized intersection in a location where one would otherwise not be allowed was also reported along with the ability to address stopping sight distance concerns. Disadvantages included right-of-way and access control concerns, driver unfamiliarity or confusion with CGTs, pedestrian crossings, truck acceleration and traffic control devices. One respondent stated that roundabouts and restricted crossing U-turns (RCUTs) are safer than CGTs for some four-lane or two-lane intersections.

### **Related Research**

Manuals, guidance and other national and state resources provided by survey respondents or related to their responses are provided along with the results of a limited literature search. Among the national guidance are citations to the AASHTO Green Book and several FHWA studies, including a 2010 case study that examines the effectiveness of CGTs and a 2016 statistical safety evaluation that compares two sets of CGT conversions with traditional T-intersections. Other studies examine possible methods of design guidance, a computer model that demonstrated improved traffic flow using CGT constructs, and a tool to more clearly address complex highway design problems. State guidance from Virginia DOT provides clear and instructive information for drivers about using the state's CGTs and other innovative intersections.

### **Next Steps**

Going forward, MnDOT may wish to consider:

- Following up with the survey respondents to learn more about considerations regarding CGT conversions in their states, particularly with the respondents from Virginia and North Carolina DOTs. The North Carolina DOT respondent indicated a deeper knowledge and experience with other intersection geometries such as RCUTs and roundabouts.
- Contacting the respondent from Arizona DOT about geometric design standards used for the acceleration lanes associated with CGTs in the state.
- Reviewing the 2016 FHWA safety report on CGTs.

## Detailed Findings

### Survey of Practice

#### Survey Approach

An online survey was distributed to members of the AASHTO Subcommittee on Design and the AASHTO Technical Committee on Geometric Design who were thought to have experience in the use of Continuous Green T-Intersections (CGTs). Respondents from 17 states participated in the survey:

- Arizona.
- California.
- Delaware.
- Idaho.
- Illinois.
- Indiana.
- Iowa.
- Kansas.
- Michigan.
- Mississippi.
- North Carolina.
- Oregon.
- Pennsylvania.
- South Carolina.
- Virginia.
- Wisconsin.
- Wyoming.

Of these 17 respondents, seven indicated that there were existing CGTs in their state and/or their agency had recently constructed a CGT. Respondents from the following seven states with existing CGTs completed the survey:

- Arizona.
- California.
- Illinois.
- Iowa.
- North Carolina.
- Pennsylvania.
- Virginia.

Respondents from two states—Indiana and Wisconsin—reported that their state did not have CGTs at this time, but were considering them. The Indiana DOT respondent noted that the agency is identifying locations for CGTs. Both respondents provided feedback to portions of the survey; that feedback is included when available.

Survey questions are provided in [Appendix A](#). The full text of survey responses is provided in a supplement to this report. [Appendix B](#) provides the contact information for survey respondents.

#### Summary of Survey Results

Below is a discussion of survey results in the following topic areas:

- Use of CGTs.
- Design guidance and considerations.
- CGT assessment.
- Related resources.

## Use of Continuous Green T-Intersections

Respondents from all seven state DOTs reported that their agency has constructed one to three CGTs. Five respondents offered more information about their CGTs:

- **Arizona:** The respondent provided the locations of the two CGTs on state highways:
  - US 60/Mountain View Road, Apache Junction.
  - State Route 189/La Quinta Road, Nogales.

The respondent added that other CGTs may be under consideration or in design.

- **Iowa:** According to the respondent, the state has only one CGT.
- **North Carolina:** The respondent reported that two CGTs that had been in place for years were removed 10 to 15 years ago. However, he said that “[w]e are building three more.” He also noted that restricted crossing U-turn (RCUT) intersections and roundabouts are “superior intersection treatments.”
- **Pennsylvania:** The respondent noted that the state may have more than one to three CGTs. Since these intersections were not commonly used in the state, there was very little specific information to reference. He added that the agency anticipates issuing an intersection evaluation control policy in the near future that includes CGTs. So the state should have more of these intersections in a few years.
- **Virginia:** The respondent provided the locations of the three CGTs in the state:
  - Route 7 and Route 660 in Frederick County.
  - Interstate 64, Exit 94, in Stuarts Draft.
  - US 15/US 29 in Warrenton.

New CGTs have been proposed in Virginia, but the designs have not yet begun.

Indiana DOT’s respondent reported no CGTs in the state, but that locations are being considered for construction in the future.

Three respondents (Arizona, Illinois and Virginia) were also aware of CGTs that had been constructed by city or county agencies:

- **Arizona:** The DOT respondent noted that there are several known versions in Pima County and likely more on local arterials.
- **Illinois:** City and county agencies have constructed only one or two CGTs.
- **Virginia:** The respondent noted that Hanover County is constructing a CGT (see *Related Resource* below for project information).

In Wisconsin, which currently doesn’t have CGTs but is considering them, the respondent noted that one municipality has an intersection that functions very closely to a CGT.

## *Related Resource*

**Hanover County to Get VDOT's First "Green T" Intersection at Busy School Crossover**, The Community Idea Stations, August 27, 2018.

<https://ideastations.org/radio/news/hanover-county-get-vdots-first-green-t-intersection-busy-school-crossover>

This web page briefly describes the CGT project in Hanover County.

## **Design Guidance and Considerations**

### ***Design Guidance***

Agency respondents provided a limited number of national and state resources when asked to provide standard plans or guidance they used in CGT design. The primary national resources were AASHTO and Federal Highway Administration (FHWA) guidance:

- Arizona DOT uses standard AASHTO design criteria.
- North Carolina and Pennsylvania DOTs use the AASHTO Green Book.

In Virginia, FHWA is a source of design and guidance. Two state resources are used in California: the California Highway Design Manual and the California Manual on Uniform Traffic Control Devices (MUTCD). In Illinois, both national research and Illinois DOT policy are used. Iowa DOT's CGT was created 20 years ago from a special design. Available manuals and guidance cited by respondents are provided in **Related Resources**.

### ***Factors Considered When Choosing a CGT***

Respondents were asked to rank the importance of five considerations relevant to converting an intersection to a CGT: safety, traffic flow, cost benefit, cost of conversion and environment. Eight state DOT respondents provided feedback: the seven respondents with CGTs in their state plus the Indiana DOT respondent who noted that construction of CGTs is being considered. Ranking factors on a scale of 1 to 5 (where 1 = least important and 5 = most important), respondents ranked both safety and traffic flow highest, followed by cost benefit, cost of conversion and environment. Figure 1 summarizes the participants' responses; Table 1 presents the rankings of individual state DOTs.



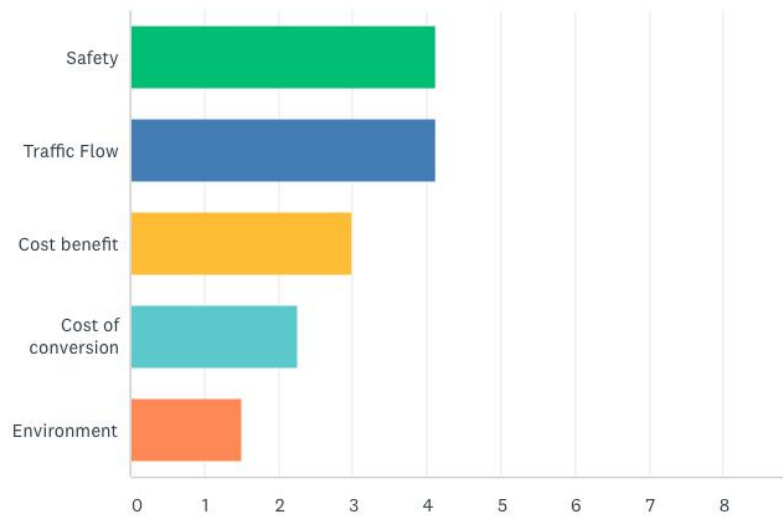

\*Results include rankings from Indiana DOT, which is considering the construction of CGTs.

**Figure 1. DOT Priorities for Converting to CGTs**

**Table 1. Considerations in Converting to CGTs**

State	Safety	Traffic Flow	Cost Benefit	Cost of Conversion	Environment
Arizona	2	1	3	5	4
California	1	2	3	4	5
Illinois	4	5	3	1	2
Indiana*	2	1	3	4	5
Iowa	1	2	3	4	5
North Carolina	2	1	3	4	5
Pennsylvania	2	1	3	4	5
Virginia	1	2	3	4	5

\*The Indiana DOT respondent, while reporting no CGTs currently in the state, offered a ranking of considerations.

**Traffic Control Features at CGTs**

Respondents were asked to indicate which of the following traffic control features their agency used at CGTs:

- Stop signs.
- Yield signs.
- Signalized control.
- Other control features.

North Carolina DOT uses all three of the traffic control features: stop signs, yield signs and signalized control. Pennsylvania and Virginia DOTs use both stop signs and signalized control. Three other state DOTs (Arizona, California and Illinois) use signalized control only, and one other state DOT (Iowa) uses stop signs only. The Indiana DOT respondent noted that future CGTs would be installed at signalized intersections. Figure 2 illustrates the traffic control features used by respondents.

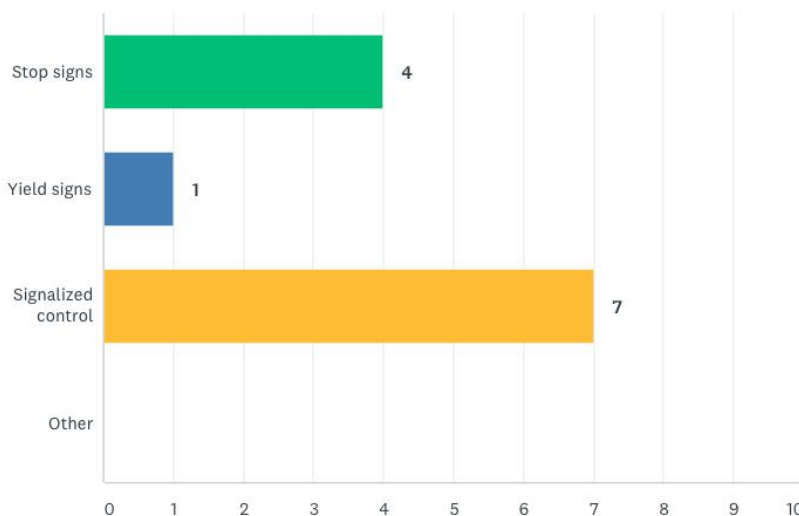

\*Results include rankings from Indiana DOT, which is considering the construction of CGTs.

**Figure 2. Traffic Control Features Used at CGTs**

**Annual Average Daily Traffic Threshold Value**

None of the respondents for states with CGTs could name annual average daily traffic (AADT) threshold values that determine or limit the use of CGTs in their state. The Arizona DOT respondent noted that CGTs are typically used at higher-volume, higher-speed T-intersections. The North Carolina DOT respondent said each possible conversion site was “analyzed individually.” Similarly, none of the states include AADT information in state guidance.

**Lane Transitions**

Respondents were asked to describe how a two-lane section of road transitioned geometrically into a CGT design. Respondents from Arizona, Illinois and North Carolina reported that all of their CGTs are associated with four-lane (multilane) roadways. The Arizona DOT respondent said one CGT uses “taper lengths to widen” and one takes advantage of a wide median. CGTs in Illinois are also installed on multilane locations with a median (with no transition). The North Carolina respondent noted that the state would never use a CGT on a two-lane major street, adding that a roundabout would be a more appropriate application. The Pennsylvania DOT respondent didn’t know how the state’s CGTs were specifically designed, but noted that treatment would depend upon the application. He added that turn lane taper criteria could be used for noncontinuous lanes. In Virginia, when a median is narrow, the agency has constructed a bypass lane for the free flow traffic and a channelized left turn entrance and exit lane. Virginia follows national and state guidance for constructing these features (see **Related Resources**).

**Acceleration Lane Design Standards**

When asked what geometric design standards were used for acceleration lanes associated with CGTs, the respondents from North Carolina and Virginia DOTs mentioned the AASHTO Green Book. The Virginia DOT respondent specifically noted that the agency uses the acceleration lane design criteria in Chapter 10 of the AASHTO Green Book (see **Related Resources**). The state Highway Design Manual is used in California and, state guidance is used in Illinois. The Pennsylvania DOT respondent, who was unaware of any high-speed CGTs in the state, said lane drop or add criteria would be applicable for lower speed CGTs. The Arizona DOT respondent was unaware of any design standards for acceleration lanes but was willing to research the issue if MnDOT was interested in more information.

**Continuous Green T-Intersection Assessment**

**Operational or Safety Concerns**

Respondents were asked about operational or safety concerns with CGTs. Four respondents (Illinois, Iowa, Pennsylvania and Virginia) reported that there were no safety concerns or that they were unaware of any. Only the respondents from Arizona and North Carolina DOTs listed concerns, which are summarized below:

- **Arizona:** Noting that both CGTs in the state are in rural or semirural areas, the primary operational concern is access management. A long acceleration lane and raised median or other physical separation without access or side friction is needed. The safety concern is the higher-speed merge from the left side. He added that before and after crash data has not been compared to quantify this concern.
- **North Carolina:** Truck acceleration, pedestrian crossing, driver confusion, traffic control devices and driveways are safety issues.

**Advantages and Disadvantages of Continuous Green T-Intersections**

In a related question, respondents described the advantages and disadvantages associated with CGTs. Among the key advantages were improved traffic flow, safety and cost-effectiveness. Disadvantages cited included driver confusion from lack of familiarity along with right of way and access control concerns. The North Carolina respondent commented that CGTs are not nearly as safe as RCUTs for four-lane major streets or roundabouts for two-lane major streets. Table 2 summarizes the advantages of CGTs; Tables 3 summarizes the disadvantages.

**Table 2. Advantages of CGTs**

Advantage	State	Description
<b>Cost-Effectiveness</b>	Indiana*	Maximizes throughput, primarily by improving signal efficiency (the use of green time).
<b>Safety</b>	Arizona, Iowa, Virginia	<b>Arizona:</b> Provides physical separation and a safer and quicker left-turn from a side street.
<b>Stopping Sight Distance</b>	California	—
<b>Traffic Control Features</b>	Illinois, North Carolina	<ul style="list-style-type: none"> <li>• <b>Illinois:</b> Allows installation of a signalized intersection at locations that otherwise couldn't have one, such as intersections that are too close to one another.</li> <li>• <b>North Carolina:</b> Uses a half-signal. No extra distance driven.</li> </ul>
<b>Traffic Flow</b>	Arizona, Iowa, Pennsylvania, Virginia	<b>Arizona:</b> Allows one lane of traffic to not stop.

\*While the state currently does not have CGTs, Indiana DOT is considering their use.

**Table 3. Disadvantages of CGTs**

Disadvantage	State	Description
<b>Driver Confusion</b>	Arizona, North Carolina	<b>Arizona:</b> Lack of driver familiarity and use due to few installations.
<b>Right of Way and Access Control</b>	Arizona, California	<b>California:</b> Left-side merge is a major concern.
<b>Other Safety Issues</b>	North Carolina	<ul style="list-style-type: none"> <li>• Truck acceleration.</li> <li>• Pedestrian crossing.</li> <li>• Traffic control devices.</li> <li>• Driveways.</li> </ul>

### Related Resources

This section includes manuals, guidance and other resources provided by survey respondents or related to their responses. Resources are provided in two categories:

- National resources
- State resources

#### **National Resources**

**A Policy on Geometric Design of Highways and Streets** (AASHTO Green Book), 7<sup>th</sup> Edition, American Association of State Highway and Transportation Officials, 2018.

<https://store.transportation.org/item/collectiondetail/180>

Several respondents referred to the AASHTO Green Book as a resource for the design and construction of intersection conversions. According to the Virginia DOT respondent, the state agency uses Chapter 10 for acceleration lane design. *From the abstract:*

A Policy on Geometric Design of Highways and Streets, 7th Edition, 2018, commonly referred to as the Green Book, contains the current design research and practices for highway and street geometric design. This edition presents an updated framework for geometric design that is more flexible, multimodal, and performance-based than in the past. The document provides guidance to engineers and designers who strive to make unique design solutions that meet the needs of all highway and street users on a project-by-project basis. Not only are the traditional functional classifications for roadways (local roads and streets, collectors, arterials, and freeways) presented, but also an expanded set of context classifications (rural, rural town, suburban, urban, and urban core) to guide geometric design. The completely rewritten Chapter 1: A New Framework for Geometric Design, introduces the updated approach to design, with specific design guidance throughout each chapter.

**Manual on Uniform Traffic Control Devices (MUTCD)**, Federal Highway Administration, May 2012.

[https://mutcd.fhwa.dot.gov/kno\\_2009r1r2.htm](https://mutcd.fhwa.dot.gov/kno_2009r1r2.htm)

*From the FHWA description:* The Manual on Uniform Traffic Control Devices for Streets and Highways, or MUTCD defines the standards used by road managers nationwide to install and maintain traffic control devices on all public streets, highways, bikeways, and private roads open to public travel. The MUTCD is

published by the Federal Highway Administration (FHWA) under 23 Code of Federal Regulations (CFR), Part 655, Subpart F. The MUTCD, which has been administered by the FHWA since 1971, is a compilation of national standards for all traffic control devices, including road markings, highway signs, and traffic signals. It is updated periodically to accommodate the nation's changing transportation needs and address new safety technologies, traffic control tools, and traffic management techniques.

### **Roundabouts and Restricted Crossing U-turns (RCUTs)**

The North Carolina respondent, Joe Hummer, recommended restricted crossing U-turns (RCUTs) and roundabouts as intersection treatments superior to CGTs. Below are links to FHWA presentations on roundabouts and RCUTs.

**Roundabouts**, Federal Highway Association, October 2017.

<https://safety.fhwa.dot.gov/provencountermeasures/roundabouts/>

**Roundabouts and Mini Roundabouts**, Federal Highway Association, undated.

<https://safety.fhwa.dot.gov/intersection/innovative/roundabouts/>

**Restricted Crossing U-Turn Informational Guide**, Joe Hummer, Brian Ray, Andy Daleiden, Pete Jenior, Julia Knudsen, Office of Safety, Federal Highway Administration, August 2014.

[https://safety.fhwa.dot.gov/intersection/alter\\_design/pdf/fhwas14070\\_rcut\\_infoguide.pdf](https://safety.fhwa.dot.gov/intersection/alter_design/pdf/fhwas14070_rcut_infoguide.pdf)

*From the abstract:* This document provides information and guidance on Restricted Crossing U-Turn (RCUT) intersections. To the extent possible, the guide addresses a variety of conditions found in the United States, to achieve designs suitable for a wide array of potential users. This guide provides general information, planning techniques, evaluation procedures for assessing safety and operational performance, design guidelines, and principles to be considered for selecting and designing RCUT intersections.

### ***State Resources***

#### **California**

**Highway Design Manual**, 6<sup>th</sup> Edition, California Department of Transportation, 2018.

<http://www.dot.ca.gov/design/manuals/hdm.html>

The 2018 edition includes a new Chapter 10, Division of Design. *From the foreword:*

This manual was prepared for the California Department of Transportation (Department) by the Division of Design for use on the California State highway system. This manual establishes uniform policies and procedures to carry out the State highway design functions of the Department. It is neither intended as, nor does it establish, a legal standard for these functions.

**California Manual on Uniform Traffic Control Devices**, California Department of Transportation, 2014.

<http://www.dot.ca.gov/trafficops/camutcd/>

*From the foreword:* This update to the CA MUTCD aims to improve safety and mobility for all travelers in California by providing guidance to transportation practitioners that strives to balance safety and convenience for everyone in traffic—drivers, pedestrians, and bicyclists. Significantly, the CA MUTCD integrates multimodal policies for safer crossings, work zones, and intersections.

## **Illinois**

**Bureau of Local Roads and Streets Manual**, Illinois Department of Transportation June 2018.

<http://www.idot.illinois.gov/Assets/uploads/files/Doing-Business/Manuals-Guides-&-Handbooks/Highways/Local-Roads-and-Streets/Local%20Roads%20and%20Streets%20Manual.pdf>

Part IV of this manual, Project Design, addresses design standards and issue.

## **Virginia**

**Section A-3: Innovative Intersection and Interchange Design Guidelines**, Appendix A, Road Design Manual, Virginia Department of Transportation, July 2018.

See [Appendix C](#).

This section addresses innovative intersection and interchange design guidelines that Virginia DOT considers effective traffic control treatments.

**Innovative Intersections and Interchanges**, Virginia Department of Transportation, undated.

[http://www.virginiadot.org/info/alternative\\_intersection\\_informational\\_design\\_guides.asp](http://www.virginiadot.org/info/alternative_intersection_informational_design_guides.asp)

This web page provides links to Virginia DOT's intersection designs, including CGTs.

### *Related Resource:*

**Continuous Green-T (CGT)**, Innovative Intersections and Interchanges, Virginia Department of Transportation, undated.

Brochure: [http://www.virginiadot.org/info/innovative\\_intersections\\_and\\_interchanges/cgt.asp](http://www.virginiadot.org/info/innovative_intersections_and_interchanges/cgt.asp)

Video: <https://www.youtube.com/watch?v=Tp9cXTAg1o&feature=youtu.be>

These resources describe the CGT and explain how drivers can navigate it.

## **Related Research**

Below are citations from a limited literature search for recent research evaluating CGTs.

**Safety Evaluation of Continuous Green T Intersections**, Eric Donnell, Jonathan Wood, Kimberly Eccles, Federal Highway Administration, April 2016.

<https://www.fhwa.dot.gov/publications/research/safety/16036/index.cfm>

*From the abstract:* The present study overcomes past safety research evaluations by using a propensity scores-potential outcomes framework to compare the safety performance of the CGT with conventional signalized T intersections using 30 treatment and 38 comparison sites from Florida and 16 treatment and 21 comparison sites from South Carolina. The results showed that the expected total, fatal and injury, and target crash (rear-end, angle, and sideswipe) frequencies were lower at the CGT intersection relative to the conventional signalized T intersection (CMFs of 0.958 (95 percent confidence interval (CI) = 0.772–1.189), 0.846 (95 percent CI = 0.651–1.099), and 0.920 (95 percent CI = 0.714–1.185), respectively). Further, the benefit-cost analysis indicated that the CGT intersection is a cost-effective alternative to the traditional, signalized T intersection. The results of the safety evaluation were not statistically significant, likely due to a small sample of treatments. When considered in combination with the operational and environmental benefits, the CGT intersection appears to be a viable alternative intersection form, although anecdotal feedback from South Carolina and Florida indicate that some non-motorized users (pedestrians and bicyclists) find it challenging to cross the continuous flow through lanes on the major street approach when traffic volumes limit the number or size of available gaps.

**“Using Decision Trees in Order to Determine Intersection Design Rules,”** Erwin M. Bezembinder, Luc J. J. Wismans, Eric C. Van Berkum, in *TRB 94th Annual Meeting Compendium of Papers*, Paper #15-0544, 2015.

<https://trid.trb.org/view/1336679>

*From the abstract:* In this paper the authors examine the possibilities to determine intersection design rules by Decision Tree (DT) methods [that] are trained with data generated by Highway Capacity Manual (HCM) 2010 intersection modeling. The models consider 24 intersection designs varying the main type (all-way stop controlled, two-way stop controlled, signalized and roundabout) and the number and configuration of the entering and exiting lanes. Traffic demand patterns are randomly generated for various sizes of the dataset (5,000 – 5,000,000 cases) represented by 38 (independent) demand variables. Different DT methods (Chi-squared Automatic Interaction Detector (CHAID), Classification and Regression Trees (CRT) and Quick, Unbiased, Efficient, Statistical Tree (QUEST)), options (splitting criteria, tree depth) and datasets are tested for their predictive accuracy. The DT models provide accuracy rates between 76% and 96%. The CRT methods seem the most promising, and a further analysis was made concerning the independent variable importance and the possibilities for reducing the trees complexity. An example is shown of a DT [that] provides straightforward design rules and a predictive accuracy of 85.5%.

**Investigating Operation at Geometrically Unconventional Intersections**, Anuj Sharma, Sunil Gwayali and Laurence Rilett, Nebraska Department of Roads, 2014.

<https://dot.nebraska.gov/media/5751/final-report-m328.pdf>

Chapter 2.3, The Operation and Safety Performance Related to Continuous Flow Intersections (CFI) (beginning on page 41 of the report, page 60 of the PDF) covers aspects of the CGT. *From the abstract:* This report documents the development of decision assistance curves (DAC) for unconventional intersections, particularly median U-turns (MUT), continuous flow intersections (CFI), and jughandles. The operational measure of effectiveness such as delay, fuel consumption, and emissions were computed. An economic analysis was performed to compute the net present value (NPV) of benefits of operation and benefit to cost ratio (B/C) by

estimating user's cost, non-user's cost, construction cost, and operation and maintenance cost for the life cycle period. The DAC classified the region of optimal performance of rural unconventional intersections comprising of four-lane major streets and two-lane minor streets. DAC indicated that MUT is applicable for almost all levels of volume combinations of major and minor street approach volumes under the presence of low left turning traffic. For medium to high left turning traffic, jughandle and CFI performed optimally on high major street approach volumes. Furthermore, it was also observed that for a case with medium to high left turning volumes, the use of CFI would be optimal for high major street approach volumes and high minor street approach volumes at an unbalanced condition. The use of a jughandle would be optimal for high major street approach volumes and its performance got better with increasing minor street approach volume at a balanced condition. However, the jughandle performed better at high major street approach volume and low minor street approach volume at an unbalanced condition. The study developed a spreadsheet tool called SILCC to estimate the operational measure of effectiveness, as well as to perform a life cycle cost analysis. A sample case study performed on a 24-hour rural pattern volume indicated high NPV of operational benefits and high B/C related to MUT compared to all other intersections for new construction. Though the MUT-retrofit had the highest NPV, since the construction cost of MUT-retrofit is high, a jughandle-retrofit was found to have the highest B/C.

**Evaluation of Continuous Green T-Intersections on Isolated Undersaturated Four-Lane Highways**, Stephen Litsas and Hesham Rakha, *Transportation Research Record 2348*, pages 19–29, 2013.

<http://dx.doi.org/10.3141/2348-03>.

*From the abstract:* The research presented in this paper analyzes the merging version of the continuous green T-intersection (CGT), an alternative intersection design–control that allows certain lanes along the main street to bypass three-way intersections, with side street traffic merging onto the main road. A comprehensive model encompassing 2,445 unique combinations of intersection conditions was run to compare the merging CGT with the standard three-way signalized intersection. The study demonstrated significant intersection improvements over conventional traffic signal timing. Specifically, significant benefits were observed for the merging CGT in total delay, fuel usage, and emissions of hydrocarbons, carbon monoxide, oxides of nitrogen, and carbon dioxide. In addition, an economic analysis showed significant user savings associated with CGT control. Because of higher traffic volumes on the main road than the side street, savings for vehicles on the main street outweighed any costs associated with side street traffic merging into the main street flow. These findings strongly support the decision to implement the merging CGT over standard three-way signalized intersection control.

**Alternative Intersections/Interchanges: Informational Report (AIIR)**, Warren Hughes, Ram Jagannathan, Dibbu Sengupta and Joe Hummer, Federal Highway Administration, April 2010.

<https://www.fhwa.dot.gov/publications/research/safety/09060/09060.pdf>

*From the abstract:*

This report covers four intersection designs and two interchange designs that may offer additional benefits compared to conventional at-grade intersections and grade-separated diamond interchanges. The six alternative treatments covered in this report are displaced left-turn (DLT) intersections, restricted crossing U-turn (RCUT) intersections, median U-turn (MUT) intersections, quadrant roadway (QR) intersections, double crossover diamond (DCD) interchanges, and DLT interchanges. The information presented in this report provides knowledge of each of the six alternative treatments including salient geometric design features, operational and safety issues, access management issues, costs, and construction sequencing and applicability.



Chapter 6.3.5, Continuous Green T-Intersection (page 212 of the report, page 230 of the PDF), briefly describes the differences between a continuous green T-intersection and a normal signalized T-intersection.

**Continuous Green T-Intersections**, Federal Highway Administration, February 2010.

[https://safety.fhwa.dot.gov/intersection/other\\_topics/fhwasa09027/resources/Technical%20Report%20Continuous%20Green%20T-Intersections.pdf](https://safety.fhwa.dot.gov/intersection/other_topics/fhwasa09027/resources/Technical%20Report%20Continuous%20Green%20T-Intersections.pdf)

*From the introduction:* Angle crashes are among the most severe crashes that occur in intersections, including T-intersections. In some cases, substandard sight distance can contribute to this problem. Several States including Colorado, Florida, Maryland, North Carolina, and South Carolina have converted from fully signalized to continuous green T-intersections (CGT) to improve safety.

**Objective:** The following case study showcases two rural intersections in Colorado where the signal-controlled through lane on the flat side (top) of a T-intersection was converted to a CGT. The treatment was implemented to reduce angle crashes due to left-turning traffic on the stem, turning in front of the through movement on the top of the T.

**Treatment Summary:** Both of the intersections complied with minimum Manual on Uniform Traffic Control Devices (MUTCD) requirements before improvements. The CDOT converted both of these [fully signalized] intersections to CGTs. The CGT design allows main line through traffic to pass through a signalized intersection without stopping (the top side of the “T”), while also eliminating conflicting vehicular movement. With a CGT, the through movement on the main line approach to the intersection is denoted by a steady green arrow traffic signal as well as by pavement markings or other lane delineation devices, so left-turning traffic stays in its respective lane (CDOT implemented advance warning signs to inform drivers of the special lane configuration). Engineers should only consider the CGT at intersections with three approaches, moderate-to-low left-turn volumes from the cross street, and high arterial through volumes.

**NCHRP Report 500: A Guide for Reducing Collisions at Signalized Intersections**, Nicholas D. Antonucci, Kelly Kennedy Hardy, Kevin L. Slack, Ronald Pfefer and Timothy R. Neuman, 2004.

<https://www.nap.edu/catalog/23423/a-guide-for-reducing-collisions-at-signalized-intersections>

*From page 49, Objective 17.2 B—Reduce Frequency and Severity of Intersection Conflicts through Geometric Improvements:* Geometric improvements can provide both operational and safety benefits at signalized intersections. Improvements to turning movements, through channelization or even physically preventing turns, can result in reductions in certain types of crashes. Geometric changes can also improve safety for pedestrians and bicyclists. Higher-cost, longer-term improvements, such as redesign of the intersection, can also improve safety and are briefly discussed in this section.

## Appendix A

### Use of Continuous Green T-Intersections: Survey Questions

The following survey was distributed to members of the AASHTO Subcommittee on Design and the AASHTO Technical Committee on Geometric Design.

#### ***Use of Continuous Green T-Intersections***

1. Has your agency constructed continuous green T-intersections (CGTs) in your state?
2. How many CGTs have been constructed in your state?
  - 1 to 3.
  - 4 to 6.
  - 7 to 10.
  - More than 10.
3. Have city or county agencies constructed CGTs in your state?

#### ***Design Considerations and Guidance***

1. Which standard plans or guidance documents does your agency use to aid in the design of CGTs?
2. Which aspects does your agency consider when deciding to convert an intersection to a CGT? Please rank them.
  - Safety.
  - Traffic flow.
  - Cost benefit.
  - Cost of conversion.
  - Environment.
3. What traffic control features does your agency use at CGTs?
  - Stop signs.
  - Yield signs.
  - Signalized control.
  - Other control features.
4. What average annual daily traffic (AADT) threshold value determines or limits the use of CGTs for your agency? Please note if your state guidance includes this information.
5. Describe how your agency transitions geometrically from a standard two-lane section into a CGT design. Please note if your state guidance includes this information.

6. Which geometric design standards does your agency use for acceleration lanes associated with CGTs?  
Please note if your state guidance includes this information.

#### **CGT Assessment**

1. What operational or safety concerns has your agency encountered with CGTs?
2. Please describe the advantages and/or disadvantages associated with CGTs.

#### **Wrap-Up**

1. Please include URL links to standard plans or designs your agency uses. Please send documents unavailable online to [sharon.vansluijs@ctcandassociates.com](mailto:sharon.vansluijs@ctcandassociates.com).
2. Please use this space to provide any comments or additional information about your answers.

## Appendix B

### Use of Continuous Green T-Intersections: Contact Information

Below is the contact information for the individuals responding to the survey for this report.

#### Arizona

Scott Beck  
TSM&O Assistant State Engineer  
Arizona Department of Transportation  
520-262-1097, [sbeck@azdot.gov](mailto:sbeck@azdot.gov)

#### California

Duper Tong  
Division of Traffic Operations  
California Department of Transportation  
916-654-5176, [duper.tong@dot.ca.gov](mailto:duper.tong@dot.ca.gov)

#### Illinois

Michael Brand  
Highways – Policy  
Illinois Department of Transportation  
217-782-7651, [michael.brand@illinois.gov](mailto:michael.brand@illinois.gov)

#### Indiana

Brad Steckler  
Director of Traffic Engineering  
Indiana Department of Transportation  
317-232-5137, [bsteckler@indot.in.gov](mailto:bsteckler@indot.in.gov)

#### Iowa

Steve Gent  
Traffic and Safety  
Iowa Department of Transportation  
515-239-1129, [steve.gent@iowadot.us](mailto:steve.gent@iowadot.us)

#### North Carolina

Joe Hummer  
State Traffic Management Engineer  
North Carolina Department of Transportation  
919-814-5040, [j.hummer@ncdot.gov](mailto:j.hummer@ncdot.gov)

#### Pennsylvania

Jeff Bucher  
Project Development Engineer  
Pennsylvania Department of Transportation  
717-783-4586, [jebucher@pa.gov](mailto:jebucher@pa.gov)

#### Virginia

Susan Keen  
State Location and Design Engineer  
Virginia Department of Transportation  
804-786-2507, [susan.keen@vdot.virginia.gov](mailto:susan.keen@vdot.virginia.gov)

#### Wisconsin

David Stertz  
Chief Design Oversight and Standards Engineer  
Wisconsin Department of Transportation  
608-267-9641, [david.stertz@dot.wi.gov](mailto:david.stertz@dot.wi.gov)

## **SECTION A-3- INNOVATIVE INTERSECTION AND INTERCHANGE DESIGN GUIDELINES**

Below are examples of Innovative Intersection and Interchange Control Types that VDOT currently recognizes as effective traffic control treatments: \*

### **CURRENT VDOT INNOVATIVE INTERSECTION AND INTERCHANGE CONTROL TYPES**

#### **Intersections**

- Displaced Left-Turn (DLT)
- Median U-Turn (MUT)
- Restricted Crossing U-Turn (RCUT)
- Continuous Green-T (CGT)
- Quadrant Roadway (QR)
- Jug-handle
- Roundabouts

#### **Interchanges**

- Diverging Diamond Interchange (DDI)
- Single Point Urban Interchange
- Double Roundabout Interchange

Other Innovative Intersection and interchange designs may be developed in the future and will be listed in this Appendix.

For more information on the above mentioned Innovative Intersection Designs see:

[http://www.virginiadot.org/info/alternative\\_intersection\\_informational\\_design\\_guides.asp](http://www.virginiadot.org/info/alternative_intersection_informational_design_guides.asp)  
[https://safety.fhwa.dot.gov/intersection/alter\\_design/](https://safety.fhwa.dot.gov/intersection/alter_design/)

---

\* Added 7/17

## INNOVATIVE INTERSECTION DESIGN GUIDELINES\*

### DISPLACED LEFT-TURN INTERSECTION (DLT) – (Also known as Continuous Flow Intersection (CFI), Crossover Displaced Left-Turn Intersection)

Any intersection form relocating one or more left-turn movements on an approach to the other side of the opposing traffic flow.

- Allows left-turn movements to proceed simultaneously with the through movement.
- Eliminates the left turn phase for this approach.
- Reduces the number of traffic signal phases and conflict points (locations where user paths cross).
- Can result in improvements in traffic operations and safety performance
- Green time can be reallocated to facilitate pedestrian crossings

For more information on the above mentioned Innovative Intersection Designs see:

[http://www.virginiadot.org/FHWA-SA-14-041DLTInformationalBrochure\\_1.pdf](http://www.virginiadot.org/FHWA-SA-14-041DLTInformationalBrochure_1.pdf)

<http://www.virginiadot.org/FHWA-SA-14-068DLTInformationalGuide.pdf>

## Overview: Displaced Left-Turn Intersection

- Four-legged DLT with displaced lefts on a major street

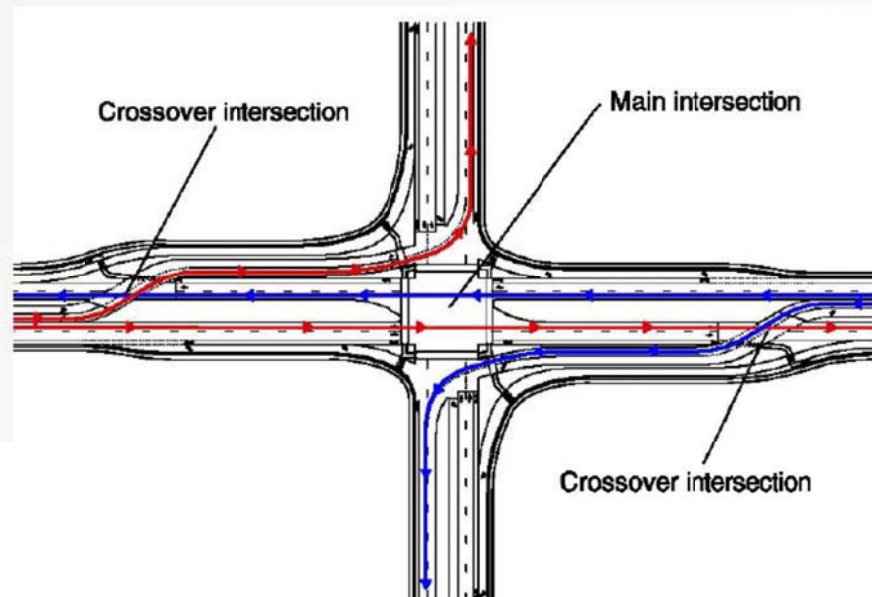

\* Added 7/17

**MEDIAN U-TURN INTERSECTION (MUT)** – (Also Known as Median U-Turn Crossover, Boulevard Turnaround, Michigan Loon and ThrU-Turn Intersection).\*

- Replaces all direct left turns at an intersection with indirect left turns using a U-turn movement in a wide median.
- Eliminates left turns on both intersecting side streets and the major street.
- Reduce the number of traffic signal phases and conflict points - May result in improved intersection operations and safety.
- Can also utilize unsignalized median U-turns.
- Distance of the secondary intersections from the main intersection should provide adequate taper and storage length for vehicles, signing, and sight distance. Recommend spacing the secondary intersections  $\pm 660$  feet from the main intersection.

For more information on the above mentioned Innovative Intersection Designs see:

[http://www.virginiadot.org/FHWA-SA-14-042\\_MUT\\_Informational\\_Brochure.pdf](http://www.virginiadot.org/FHWA-SA-14-042_MUT_Informational_Brochure.pdf)  
[http://www.virginiadot.org/FHWA-SA-14-069\\_MUT\\_Informational\\_Guide.pdf](http://www.virginiadot.org/FHWA-SA-14-069_MUT_Informational_Guide.pdf)

## Median U-Turn Intersection

- MUT with signals at the main intersection and two crossover locations
- MUT may also have signals at the main intersection but unsignalized crossovers

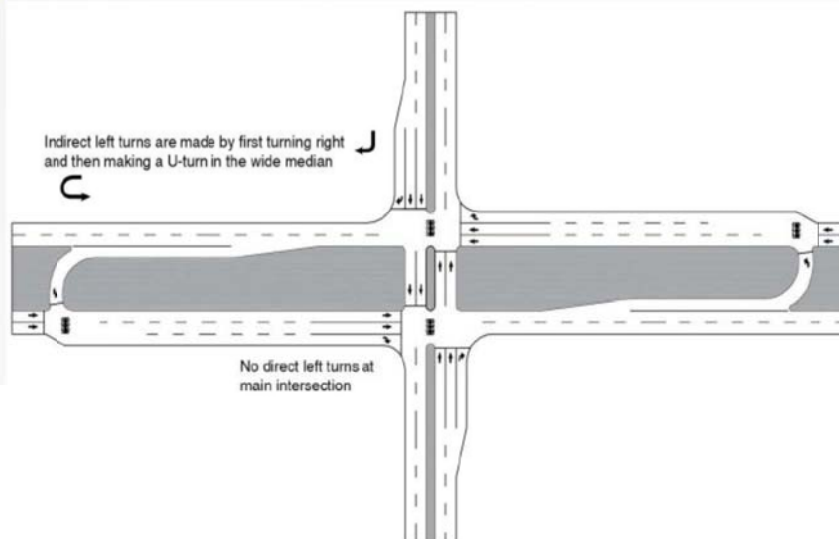

\* Added 7/17

## RESTRICTED CROSSING U-TURN INTERSECTION (RCUT) – (Also known as Superstreet Intersection, J-Turn Intersection and Synchronized Street Intersection)\*

- Replaces side street direct left turns at an intersection with indirect left turns using a U-turn movement in a wide median.
- Eliminates left turns on both intersecting side streets. Left turns are provided on the major street.
- Can be signalized or unsignalized.
- Reduce the number of traffic signal phases and conflict points. When implemented as a corridor treatment, almost perfect signal progression is possible as the main intersection can be operated as two separate signals with the two major street direction phases operating independently of each other.
- Will usually result in improved intersection operations and safety.
- Distance of the secondary intersections from the main intersection should provide adequate taper and storage length for vehicles, signing, and sight distance. Recommend spacing the secondary intersections  $\pm 660$  feet from the main intersection.

For more information on the above mentioned Innovative Intersection Designs see:  
[http://www.virginiadot.org/FHWA-SA-14-040\\_RCUT\\_Informational\\_Brochure.pdf](http://www.virginiadot.org/FHWA-SA-14-040_RCUT_Informational_Brochure.pdf)  
[http://www.virginiadot.org/info/alternative\\_intersection\\_informational\\_design\\_guides.asp](http://www.virginiadot.org/info/alternative_intersection_informational_design_guides.asp)  
[https://safety.fhwa.dot.gov/intersection/alter\\_design/](https://safety.fhwa.dot.gov/intersection/alter_design/)

### Restricted Crossing U-Turn Intersection

- Three types of RCUT intersections
  - Signalized (shown below)
  - Stop-controlled
  - Merge- or yield-controlled

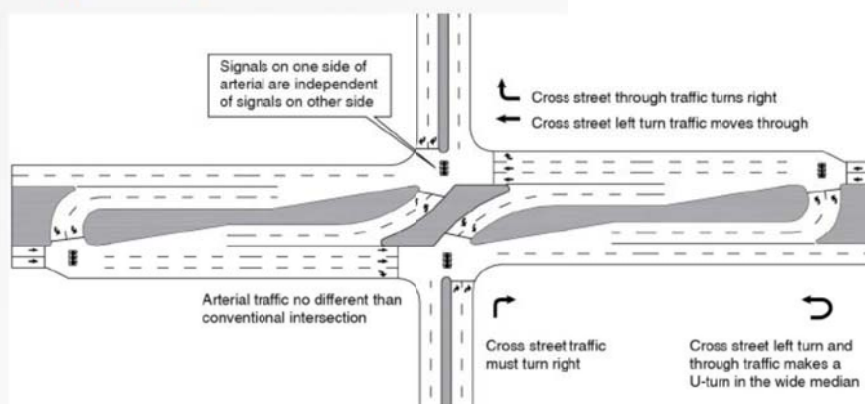

\* Added 7/17



## **CONTINUOUS GREEN-T (CGT)\***

The design provides free-flow operations in one direction on the major street and can reduce the number of approach movements that need to stop to three by using free-flow right turn lanes on the arterial and cross streets and acceleration/merge lanes for left turn movements from the cross street. Physical separation or barrier is typically required between the acceleration/merge lanes and the mainline free flow movement.

For more information on the above mentioned Innovative Intersection Designs see:

<https://www.fhwa.dot.gov/publications/research/safety/16036/16036.pdf>

<https://safety.fhwa.dot.gov/intersection/innovative/others/casestudies/fhwasa09016/fhwasa09016.pdf>

[https://attap.gitbooks.io/muid/content/at-grade & signalized/continunous green-t.html](https://attap.gitbooks.io/muid/content/at-grade-&-signalized/continunous-green-t.html)

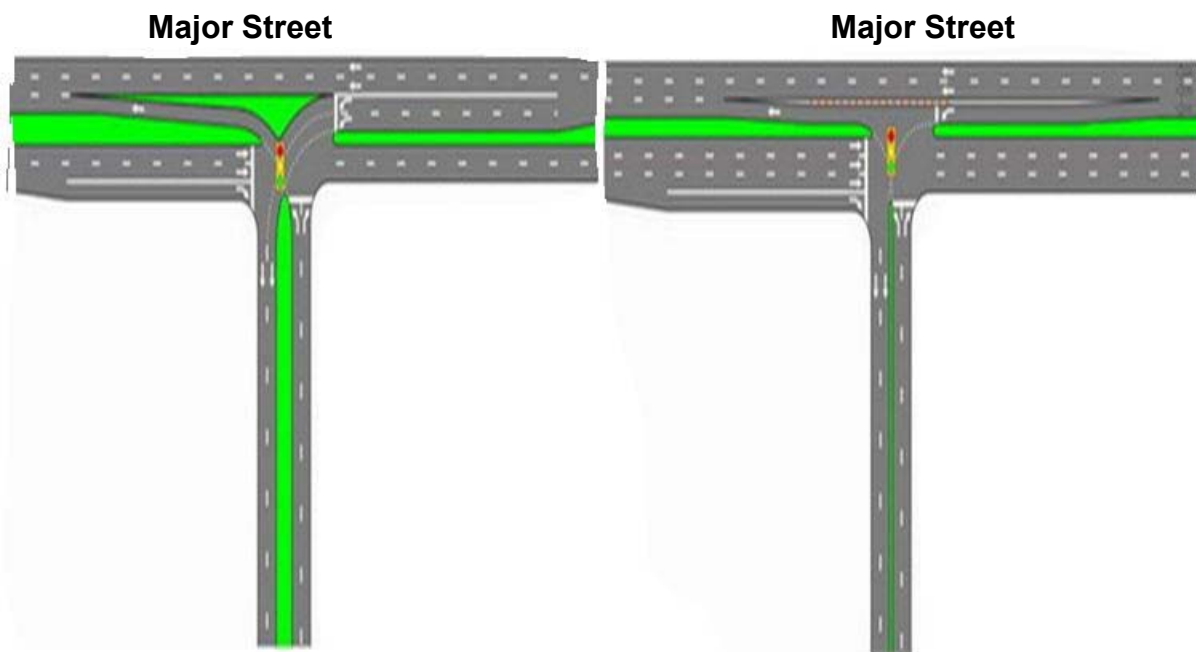

---

\* Added 7/17

## QUADRANT ROADWAY INTERSECTION (QR)\*

### Geometric Design

The primary design considerations of the QR intersection are as follows:

- Left turns are not permitted at the main intersection.
- The location of the connector road should be primarily determined by the left-turn volume at the intersection.

U-turns are not permitted at the main intersection and are rerouted similar to left turns.

- Distance of the secondary intersections from the main intersection should provide adequate taper and storage for vehicles, signing, and sight distance. Recommend spacing the secondary intersections  $\pm 660$  feet from the main intersection.
- If permitted, driveways from the connecting road to the parcel inside the connecting road may be placed in the curve of the connecting road or near one of the secondary intersections. If driveways are not permitted, then the parcel inside the connecting roadway can be accessed via driveways off one or both of the intersecting streets.

At a QR intersection, some pedestrians will need to cross an extra street; however, others who follow the curved connection roadway or the main intersection crosswalks will have shorter walking distances. Also, the shorter cycle lengths at QR intersections benefit pedestrians.

A QR with more than one connection road can be implemented if right-of-way is available and if left-turn volumes justify it. Geometric principles remain largely the same for QRs with one or more connection roadways.

### Applicability

They are most applicable where the following exists:

- A roadway in the road network can be used as a connection roadway.
- There are heavy left turns and through volumes on the major and minor roads.
- The minor road total volume to total intersection volume ratio is typically less than or equal to 0.35.

---

\* Added 7/17

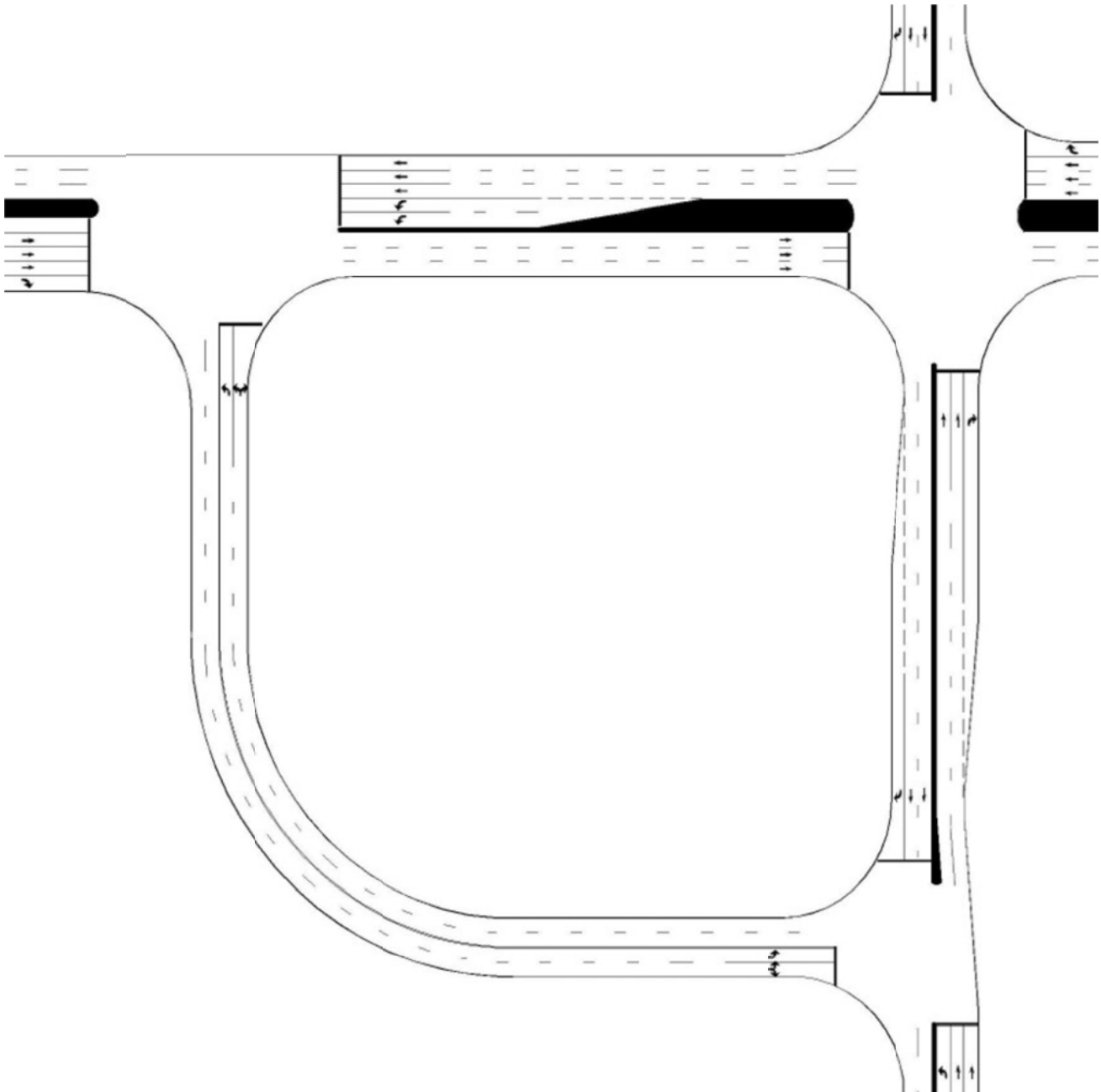
**QUADRANT ROADWAY INTERSECTION\***

For more information on the above mentioned Innovative Intersection Designs see:  
<https://www.fhwa.dot.gov/publications/research/safety/09058/09058.pdf>  
<https://www.fhwa.dot.gov/publications/research/safety/09058/>

---

\* Added 7/17

**JUG-HANDLE\***

A jug-handle is a type of ramp or slip road that changes the way traffic turns left at an at-grade intersection. Instead of a standard left turn being made at the intersection from the left lane, left-turning traffic uses a ramp or slip road on the right side of the road.

Jug-handles are common in many states including New Jersey, Connecticut, Delaware, Oregon, and Pennsylvania.

Drivers wishing to turn left exit the major roadway at a ramp or slip road on the right, and turn left onto the minor road at a terminus separated from the main intersection.

For more information on the above mentioned Innovative Intersection Designs see:

<https://www.fhwa.dot.gov/publications/research/safety/07032/>

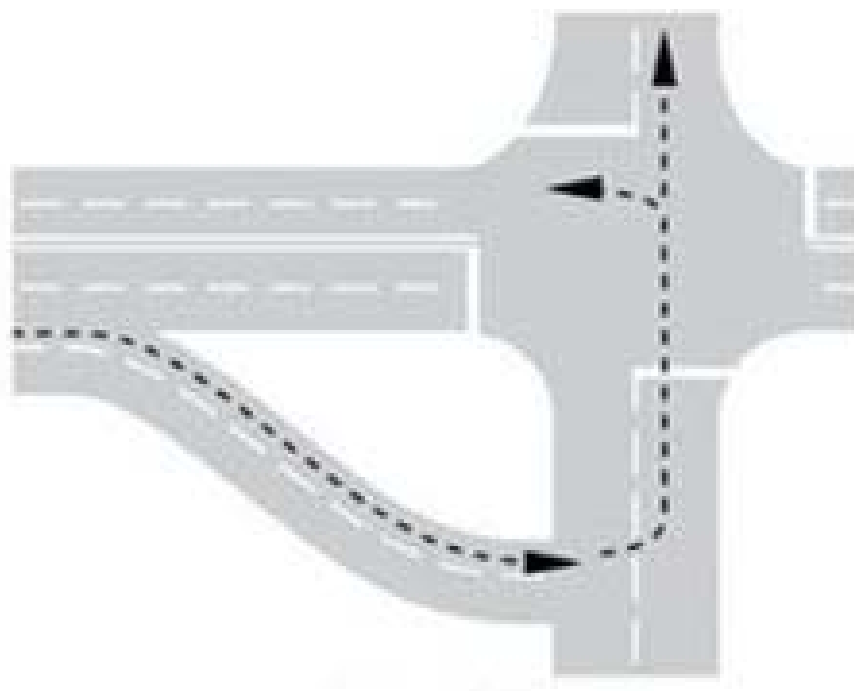

---

\* Added 7/17

## ROUNDBABOUTS

Roundabouts are circular intersections with specific design and traffic control features. These include yield control of all entering traffic (circulating vehicles have the right-of-way), channelized approaches, and geometric curvature to ensure that travel speeds are typically less than 30 mph (single-lane 20-25 mph; two-lane 25-30 mph).

Roundabouts are generally safer than other types of intersections for low and medium traffic conditions. These safety benefits are achieved by eliminating vehicle crossing movements through the conversion of all movements to right turns and by requiring lower speeds as motorists proceed into and through the roundabout. The potential for right angle and left turn head-on crashes is eliminated with single lane roundabouts. Roundabouts treat all vehicle movements equally, each approach is required to yield to circulating traffic. Roundabouts typically handle higher volumes with lower vehicle delays (queue) than traditional intersections at capacity.

While roundabouts usually require more right-of-way at an intersection compared to a traffic signal, they require less right-of-way on the upstream approaches and downstream exits. At new intersection sites that will require turn lanes, a roundabout can be a less expensive intersection alternative. Operating and maintenance costs are less than signalized intersections since there is no signal equipment. The roundabout has aesthetic advantages over other intersection types particularly when the central island is landscaped.

VDOT has adopted the NCHRP Report 672 Roundabouts: An Informational Guide, 2<sup>nd</sup> Edition as our design guide. However, design criteria mentioned in this Manual takes precedence over NCHRP Report 672.\*

---

\* Rev. 1/18

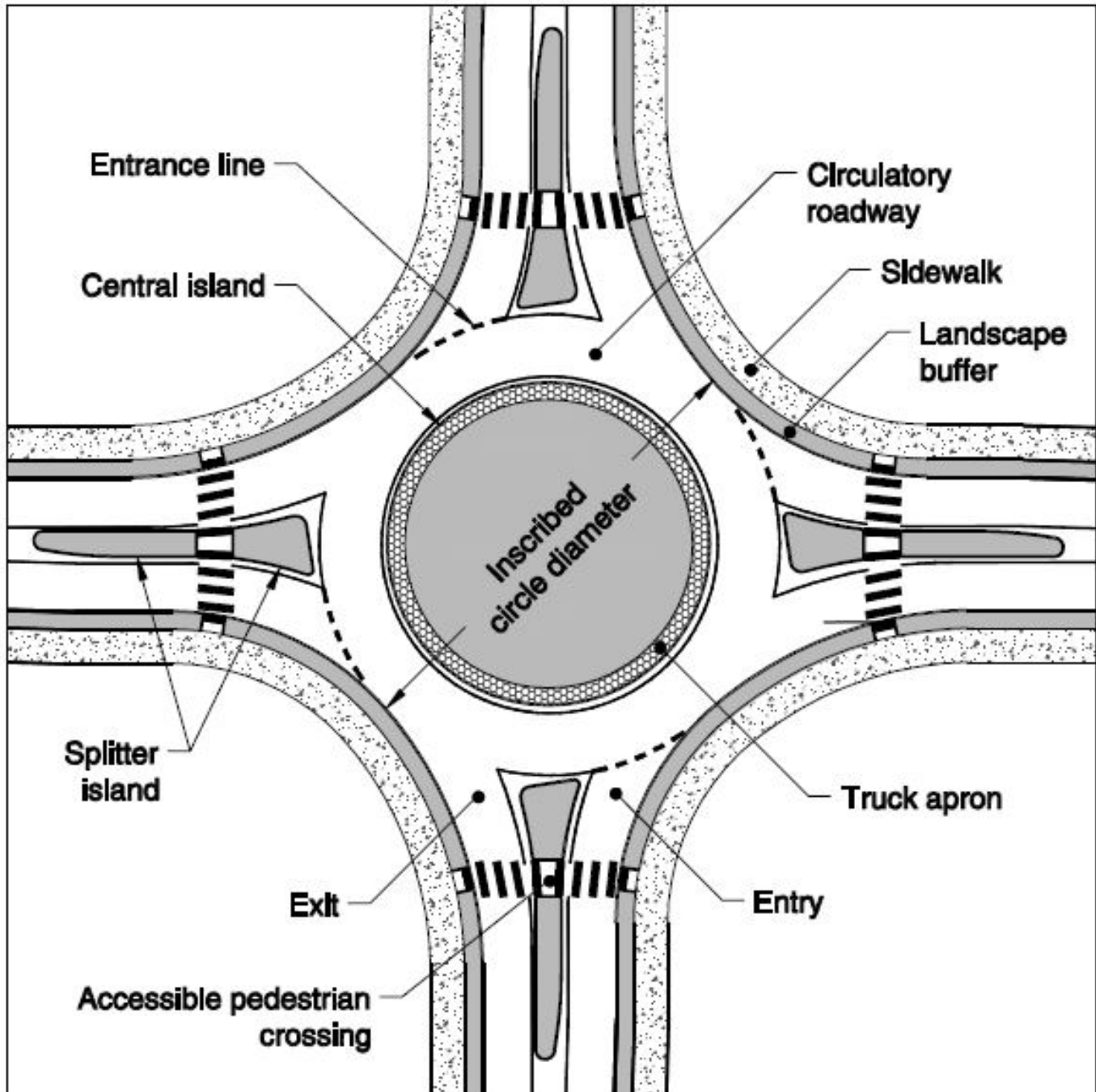

**FIGURE A-3-1 ROUNDABOUT DESIGN ELEMENTS**

Source: [NCHRP Report 672 Roundabouts: An Informational Guide, Second Edition](#).\*

For Truck Apron Curb use cell Mod. CG-3 found in the cell library.\*

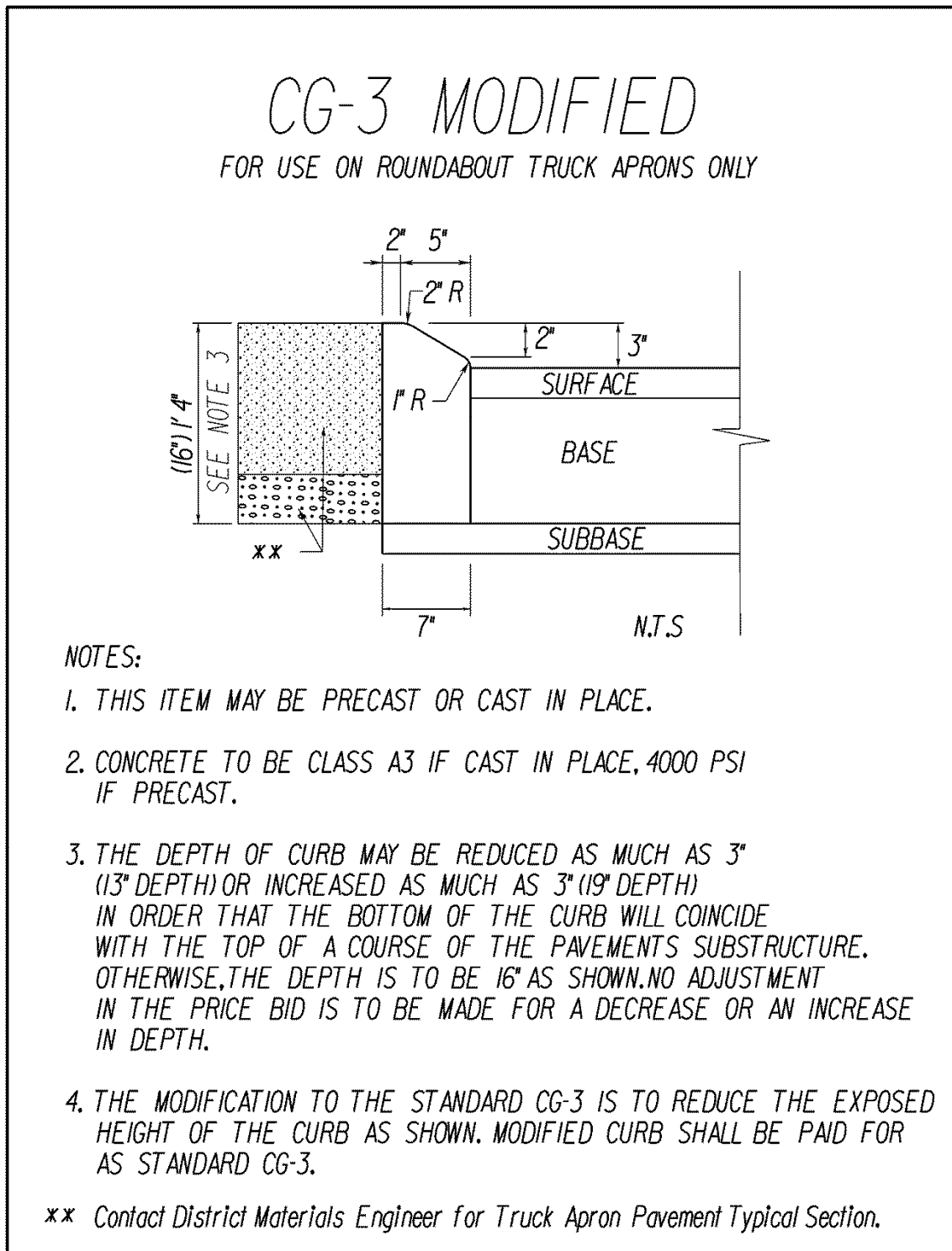

**FIGURE A-3-2 ROUNDABOUT TRUCK APRON CURB DETAIL**

There are three basic categories of roundabouts based on size and number of lanes: mini-roundabouts, single-lane roundabouts and multi-lane roundabouts.

## MINI-ROUNDBABOUTS

Mini-Roundabouts are applicable in urban environments with speeds less than or equal to 30 mph. They adapt to existing boundaries by providing a fully traversable central island, a mini-roundabout can be a low-cost solution for improving intersection capacity and safety without the need for acquiring additional right of way. The suitability of a mini-roundabout depends on:

- 1) Traffic Volumes (comparable ADT from each approach roadway)
- 2) Truck Volumes < 5%
- 3) Frequency of School Bus use

Mini-Roundabouts should meet the following geometric design criteria:

- 1) Central island of 25 to 50 feet, which is fully mountable
- 2) Central island curb height is less than 2 inches high and is often flush and painted
- 3) Central island should be domed using 5% - 6% cross slope, with maximum height of 5 inches\*
- 4) Circular roadway width of 12 feet (may be wider for intersections with acute angles)
- 5) Approach lanes 10 to 11 feet (to reduce speeds)

Mini-Roundabouts are designed with painted “splitter islands” in each quadrant to guide traffic. The majority of traffic (usually estimated at 97%) should be able to pass through the mini-roundabout while staying within the circular roadway. The traversable central island and splitter islands allow larger vehicles to pass through. Mini-Roundabouts can conservatively handle 1,600 VPH (all approaches) while providing an adequate level of service.

Sources: ITE Journal, November 2012, Article by Lochrane, Zhang and Bared;  
Public Roads Magazine, Nov. /Dec. 2012, “They’re Small But Powerful” at:  
[NCHRP Report 672, Roundabouts: An Informational Guide](#), Second Edition,  
Chapter 6, Section 6.6

---

\* Rev. 7/18



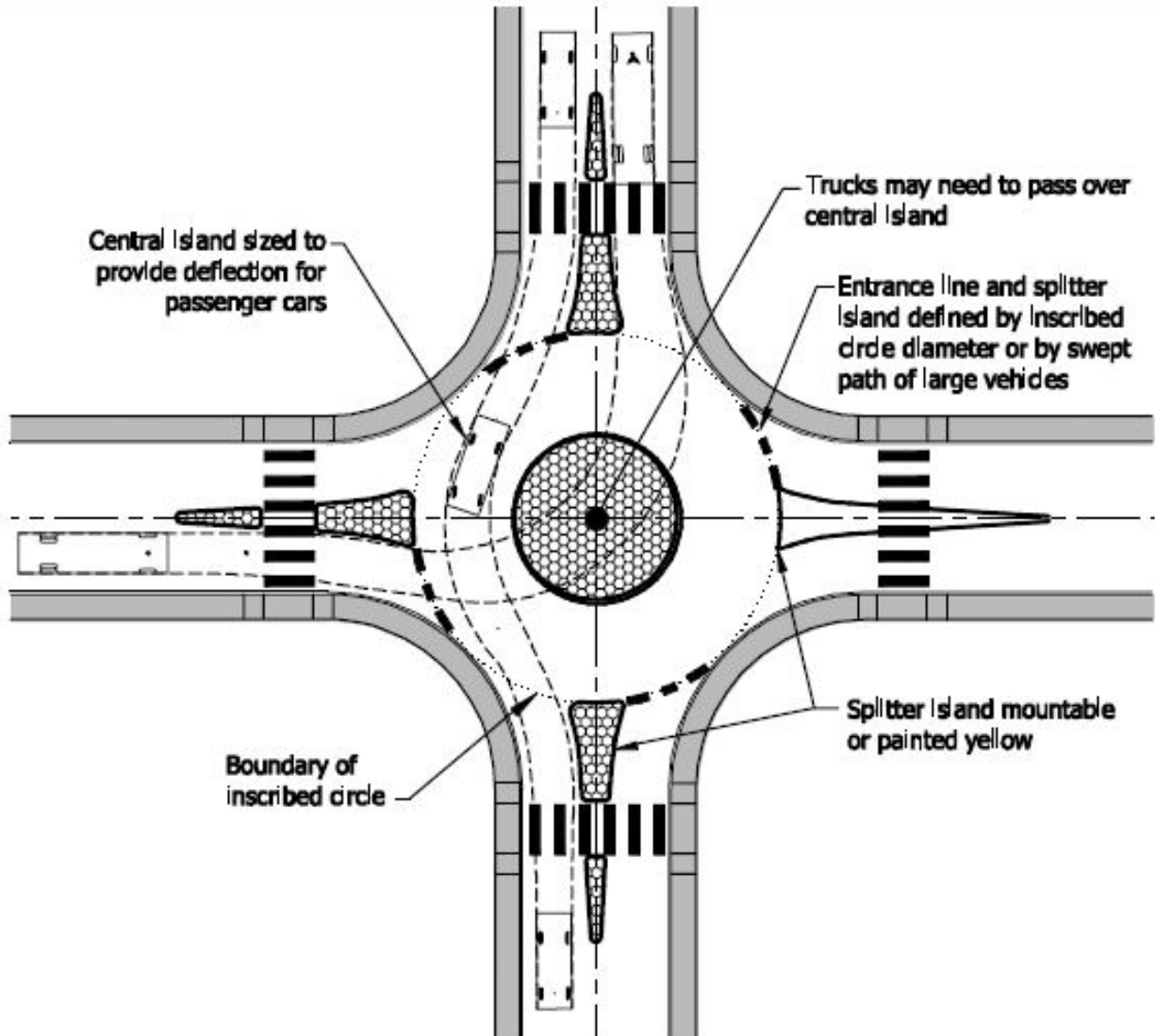

Features of a Typical Mini-Roundabout\*

Source: [NCHRP Report 672 Roundabouts: An Informational Guide, Second Edition.](#)

\* Rev. 7/17

## SINGLE-LANE ROUNDABOUTS\*

- Single-Lane Roundabouts have single-lane entry at all legs and one circulating lane. They are distinguished from mini-roundabouts by their larger inscribed circle diameter and non-traversable central island. The geometric design features include: raised splitter islands with appropriate entry path deflection, a raised non-traversable central island, crosswalks, and a truck apron vertically separated by a VDOT CG-3 Modified curb from the circulatory roadway.
- The maximum daily service volume of a single-lane roundabout varies between 20,000 and 26,000 vehicles per day (2,000 - 2,600 peak hour volume), depending on the left turn percentages and the distribution of traffic between the major and minor roads.

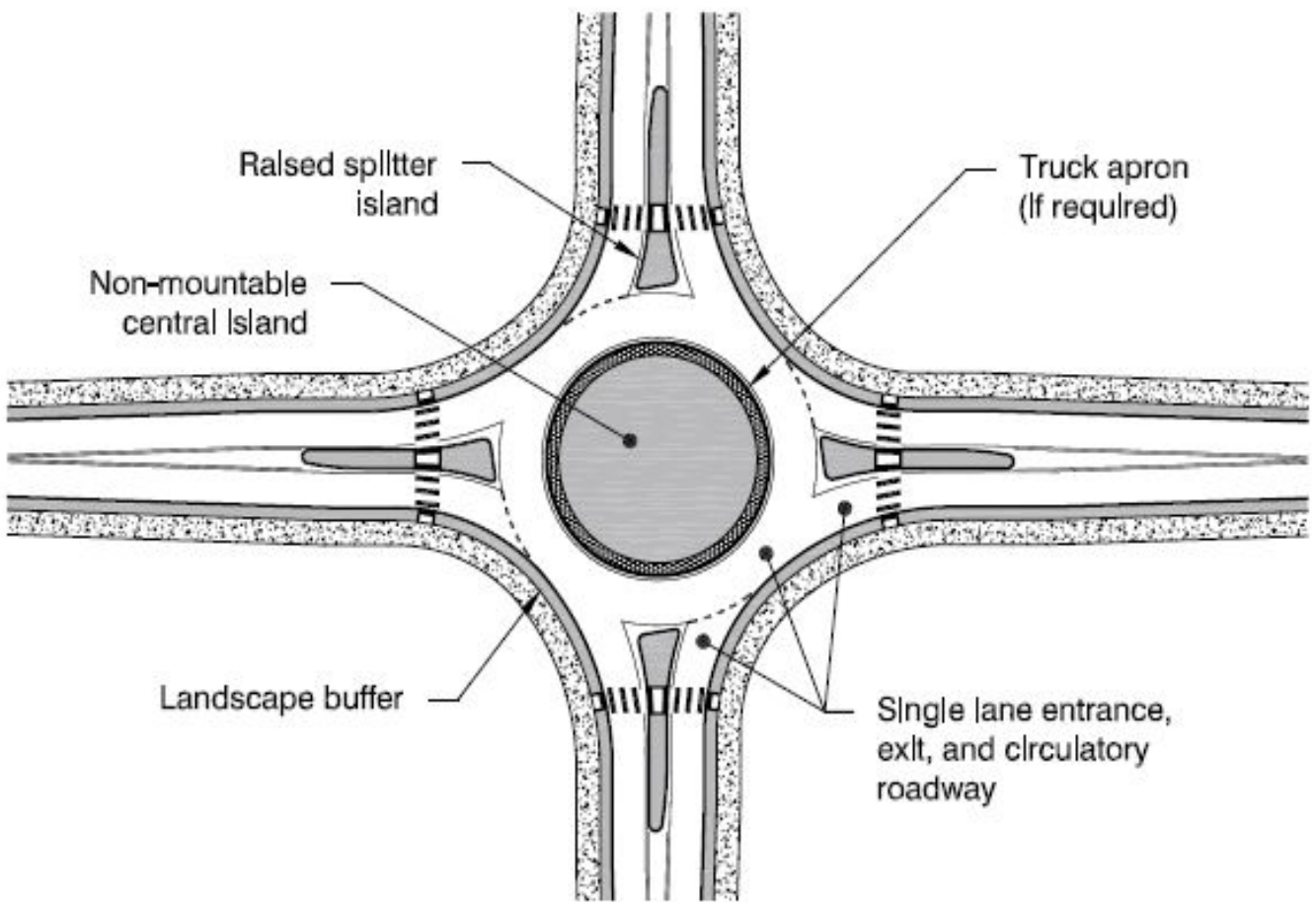

Features of a Typical Single-Lane Roundabout

Source: [NCHRP Report 672 Roundabouts: An Informational Guide, Second Edition.](#)

\* Rev. 7/17

## MULTI-LANE ROUNDABOUTS\*

- Multi-Lane Roundabouts have at least one entry with two or more circulating lanes. In some cases, the roundabout may have a different number of lanes on one or more approaches (e.g., two-lane entries on the major street and one-lane entries on the minor street). They may have entries on one or more approaches that flare from one to two or more lanes. They also require wider circulating roadways to accommodate more than one vehicle traveling side by side. The geometric design features include: raised splitter islands with appropriate entry path deflection, a raised non-traversable central island, crosswalks, and a truck apron separated by a VDOT CG-3 Modified curb from the circulatory roadway. Driver decisions are more complex for multi-lane roundabouts. These decisions include: proper lane when entering, lateral positioning while circulating and proper lane for exiting.
- If a Multi-Lane Roundabout design is warranted in the long term, it should be designed as a Multi-Lane Roundabout, but striped and signed as a Single-Lane Roundabout when initially opened to traffic.

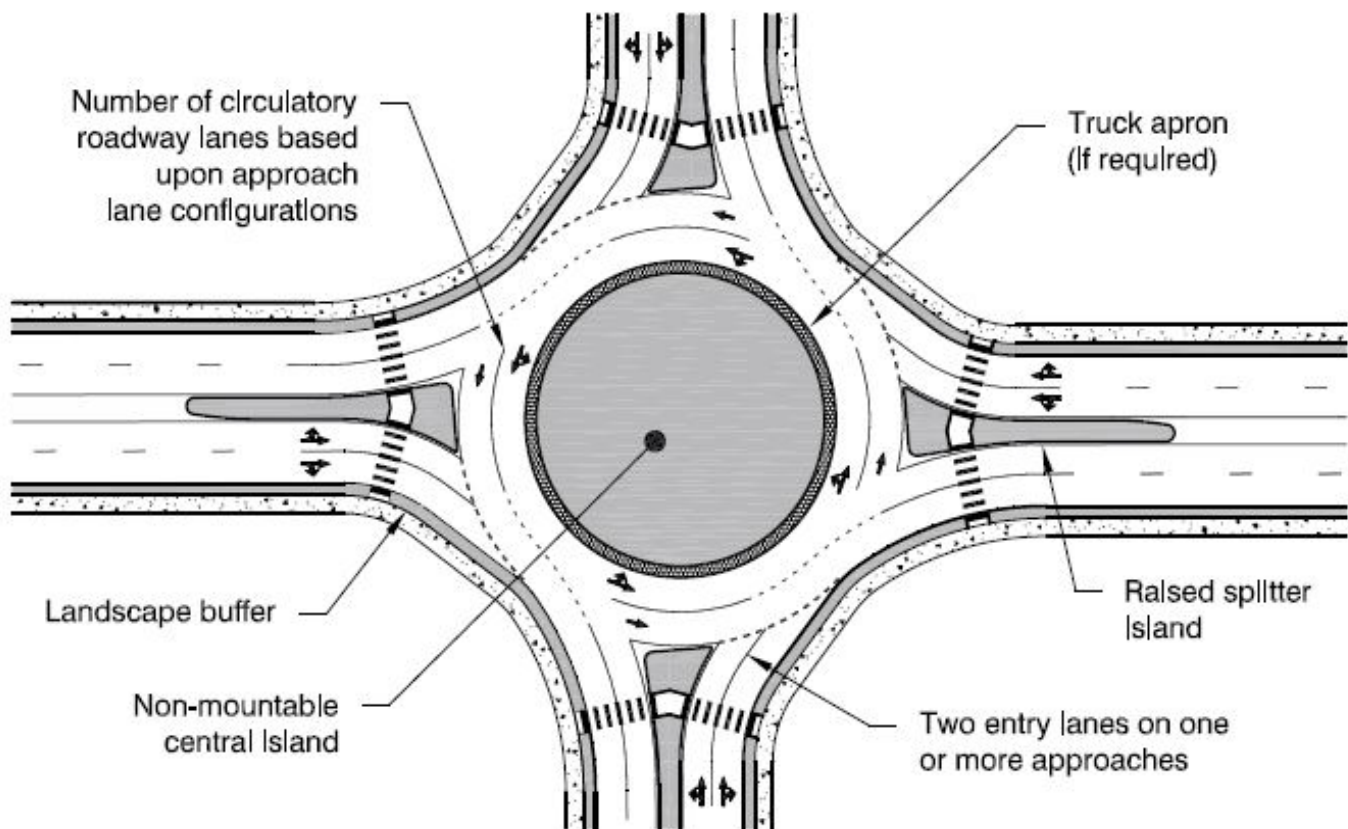

Features of a Typical Multi-Lane Roundabout

Source: [NCHRP Report 672 Roundabouts; An Informational Guide, Second Edition.](#)

\* Rev. 7/17

## GEOMETRIC DESIGN CRITERIA FOR SINGLE-LANE AND MULTI-LANE ROUNDABOUTS

- Central Island, **shall be raised** (non-mountable) and sloped outward away from the center. The island is typically landscaped for aesthetic reasons and to enhance driver recognition for the roundabout upon approach. The truck apron is also considered to be a portion of the central island, but is traversable.
- Truck Aprons shall be designed such that they are traversable to trucks but discourage passenger vehicles from using them. Truck apron width shall be determined by the tracking of the **appropriate project\*** design vehicle using AutoTurn. They shall be 4 feet to 15 feet wide and have a cross slope of 1% to 2% outward away from the central island.

If the percentage of trucks anticipated to use the road exceeds 5%, that radius should be sufficient to serve those vehicles. The outer edge of the truck apron shall include a CG-3 Modified Curb (See Figure 2-15 Roundabout Truck Apron Curb Detail), to vertically separate the truck apron from circulatory roadway surface. The truck apron shall also be constructed of a different material to differentiate it from the circulatory roadway. The truck apron shall also be a different color and texture.

- Circulatory Roadway shall be sloped 2% outward away from the central island. The outward cross-slope design means drivers making through and left-turn movements must negotiate the roundabout at negative superelevation. Sloping the circulatory roadway outward away from the central island is required for the following reasons:
  - It promotes safety by raising the elevation of the central island and improves visibility,
  - It promotes lower circulating speeds due to the adverse superelevation,
  - It minimizes breaks in the cross slopes of the entrance and exit lanes, and
  - It allows surface water to drain to the outside of the roundabout.
- Curb and/ or Curb and Gutter shall be provided on the outside of the circulatory roadway and on all approaches a minimum distance equal to the length of the splitter island to help approaching drivers recognize the need to reduce their speed, prevent corner-cutting, and to confine vehicles to the intended design path.
- Inscribed Circle diameter is the distance measured across the circle inscribed by the face of the outer curb or front edge of the gutter pan of the circulatory roadway. See Figure 2-14.

---

\* Rev. 7/18

- Entry and Exit Design\*

The entry curb radius is an important factor in determining the operation of a roundabout because it affects both capacity and safety. The entry curb radius, in conjunction with the entry width, the circulatory roadway width, and the central island geometry, controls the amount of deflection imposed on a vehicle's entry path and speed. See NCHRP Report 672, Chapter 6, Section 6.4.5.

- Entry angle,  $\Phi$ , is not discussed in NCHRP Report 672, but additional information can be found in the Wisconsin Department of Transportation Facilities Development Manual, Chapter 11, Roundabouts Section 26-30.5.23. This angle is not a controlling design parameter, but instead a gauge of sight to the left and ease of entry to the right. This affects both capacity and safety at the intersection.

The exit curb radii are usually larger than the entry radii in order to minimize the likelihood of congestion and crashes at the exits. This, however, is balanced by the need to maintain slow speeds through the pedestrian crossing on exit. The exit design is also influenced by the design environment (urban vs. rural), pedestrian demand, the design vehicle, and physical constraints. See NCHRP Report 672, Chapter 6, Section 6.4.6.

- Profiles – The vertical design shall begin with the development of the approach roadway and the central island. Each profile shall be designed to the point where the approach baseline intersects with the central island. A profile for the central island is then developed that passes through these four points (in the case of a four-legged roundabout). The approach roadway profiles shall be refined as necessary to meet the central island profile. For examples see, Chapter 6 of the [NCHRP Report 672 Roundabouts; An Informational Guide, Second Edition](#). In addition to the approach and central island profiles, creating an additional profile around the inscribed circle of the roundabout and / or outer curbs are also beneficial. The combination of the central island, inscribed circle, and curb profiles allows for quick verification of cross slopes and drainage and provides additional information to contractors for staking out the roundabout.

---

\* Rev. 1/18

- Example Plan Sheets, Typical Section, Profile Sheets for a Typical Single-Lane Roundabouts can be accessed at: <http://www.virginiadot.org/info/faq-roundabouts.asp> as well as in [NCHRP Report 672 Roundabouts; An Informational Guide, Second Edition.](#), page 6-82.

<b>Design Element</b>	<b>Mini-Roundabout</b>	<b>Single-Lane Roundabout</b>	<b>Multi-lane Roundabout</b>
Desirable maximum entry design speed	15 to 20 mph	20 to 25 mph	25 mph to 30 mph
Maximum number of entering lanes per approach	1	1	2+
Typical inscribed circle diameter	45 to 90 ft.	90 to 180 ft.	150 to 220 ft. (two-lanes)
Central island treatment	Fully traversable	Raised (w/ traversable apron)	Raised (w/ traversable apron)
Typical daily service volumes on 4-leg roundabout below which may be expected to operate without requiring a detailed capacity analysis (veh/day)*	Up to approximately 15,000	Up to Approximately 25,000	Up to Approximately 45,000 for two-lane roundabout
*Operational analysis needed to verify upper limit for specific applications or for roundabouts with more than two lanes or four legs.			

### Roundabout Category Comparison

## BICYCLE AND PEDESTRIAN ACCOMMODATIONS

Bicycle and Pedestrian accommodations should be considered when designing roundabouts.

For pedestrians, the risk of being involved in a severe collision is lower at roundabouts than at other forms of intersections due to the slower vehicle speeds (20-30 mph). Likewise, the number of conflict points at roundabouts is also lower and thus can lower the frequency of crashes. For pedestrian design consideration, see Chapter 6 of the *NCHRP Report 672, Roundabouts: An Informational Guide, Second Edition* at [http://onlinepubs.trb.org/onlinepubs/nchrp/nchrp\\_rpt\\_672.pdf](http://onlinepubs.trb.org/onlinepubs/nchrp/nchrp_rpt_672.pdf).

For bicyclists, safety and usability of roundabouts depends upon the roundabout design. Since typical on-road bicyclists travel is between 12 and 20 mph, roundabouts that are designed to constrain vehicle speeds to similar values will minimize the relative speeds between bicyclists and motorists, and thereby improve the safety and usability for bicyclists.\*

Single-lane roundabouts are much easier for bicyclists than multi-lane roundabouts since they do not require bicyclists to change lanes to make left-turn movements or otherwise select the appropriate lane for their direction of travel.

In addition, at single-lane roundabouts, motorists are less likely to cut off bicyclists when exiting the roundabout. Therefore, it is important not to select a multi-lane roundabout over a Single-lane roundabout in the short term, even when long term traffic volumes and LOS suggest a multi-lane roundabout. However, if a multi-lane roundabout design is selected for the long term, it should be striped and signed as a single-lane roundabout initially.

For roundabout intersection spacing standards and other intersection spacing standards, see [Appendix F, Table 2-2 MINIMUM SPACING STANDARDS FOR COMMERCIAL ENTRANCES, INTERSECTIONS AND MEDIAN CROSSOVERS](#).

---

\* Rev. 7/17

## DESIGN RESOURCES

For Roundabout Consideration & Alternative Selection Guidance Tool, see Roundabouts in Virginia @ <http://www.virginiadot.org/info/faq-roundabouts.asp>.

Additional information can be found in [\*NCHRP Report 672, Roundabouts: An Informational Guide, Second Edition\*](#). See the following link:  
[http://onlinepubs.trb.org/onlinepubs/nchrp/nchrp\\_rpt\\_672.pdf](http://onlinepubs.trb.org/onlinepubs/nchrp/nchrp_rpt_672.pdf).

Additional information can also be found in VDOT's Roundabout Brochure at <http://www.virginiadot.org/info/resources/Roundabouts.pdf> and on VDOT's roundabout web site at Roundabouts in Virginia.

## THE REVIEW AND APPROVAL PROCESS FOR ROUNDABOUTS

Existing and Proposed Subdivisions - The District Location & Design Engineer shall review and approve roundabouts in subdivisions if VDOT owns and maintains the roadway or if it is the desire of the developer / locality for VDOT to accept the roadway into the State Highway System.

Secondary System – The District shall approve roundabouts up to a traffic design volume of 10,000 VPD. Roundabout designs in which the traffic volume exceeds 10,000 VPD shall be submitted to the Innovative Intersection Committee\* at the preliminary field inspection, public hearing/design approval and right of way stages and for review and comments. The committee will make recommendations to the State Location and Design Engineer for approval or disapproval. Appeals of the State Location and Design Engineer's decision will go to the Chief Engineer for resolution.

When a District receives a request for a roundabout from an outside entity, and the design volume is below 10,000 VPD but requests the Innovative Intersection Committees review and comments, the submittal shall be sent to the State Location and Design Engineer. It will be reviewed and comments and/or recommendations will be returned in a timely manner.

Primary or Urban System - The District Location & Design Engineer shall submit roundabout designs to the Innovative Intersection Committee at the preliminary field inspection, public hearing/design approval and right of way stages for review and comments. The approval and appeals will be the same as mentioned above.

The process mentioned above applies to:

- Roundabouts proposed through six year construction program.
- Roundabouts proposed during road safety improvements and/or upgrades.
- Roundabouts proposed by Counties, Localities, Consultants and Developers

---

\* Rev. 7/18



The plan submittal shall contain and depict the following criteria:

- Design speed & fastest theoretical path
- Design vehicle for Circulatory Roadway (S-BUS-36)
- Appropriate project\* design vehicle for Truck Apron
- Approach Grades/sight triangles/sight distances
- Inscribed outer diameter of circulatory roadway
- Apron composition, width, slope and curb standard
- Circulatory lane width
- Approach lane width/Deflection/radii
- Departure lane width/Deflection/radii
- Splitter island lengths/raised/flush
- Pedestrian crossing locations/width, composition, raised/flush, markings.
- Bicycle lane/approach & termination point.
- Pavement markings (directional arrows, yield lines, edge lines, etc.)
- Signing
- Roadway Lighting (preferred)
- Location of nearest entrances to outer inscribed diameter and nature of land use
- Present & design year volumes, % trucks & turning movements on all approaches
- AASIDRA analysis on all approaches/peak hrs. LOS/queue lengths in design year
- AUTO-TURN results of Design Vehicle for all turning movements
- Planting scheme/landscaping for mounded central island and splitter islands.
- Proximity of roundabout to nearest traffic signal.

If for some reason, the District does not have capability to run the subject computer programs, the Central Office Roundabout Review Committee can provide assistance upon request.

---

\* Rev. 7/18

## INNOVATIVE INTERCHANGE DESIGN GUIDELINES\*

### DIVERGING DIAMOND INTERCHANGE (DDI) - Also known as Double Crossover Diamond (DCD)

- An alternative to the conventional diamond interchange or other Innovative Interchange forms.
- A DDI is different from a conventional diamond interchange
  - Directional crossovers on either side of the interchange eliminate the need for left turning vehicles to cross the paths of approaching through vehicles.
- Improves the operations of turning movements to and from the freeway facility
  - Reduces the number and severity of vehicle to vehicle conflict points
- Ramp terminal intersections operate with two-phase signals for increased efficiency

## Diverging Diamond Interchange Schematic

- Overview of interchange features

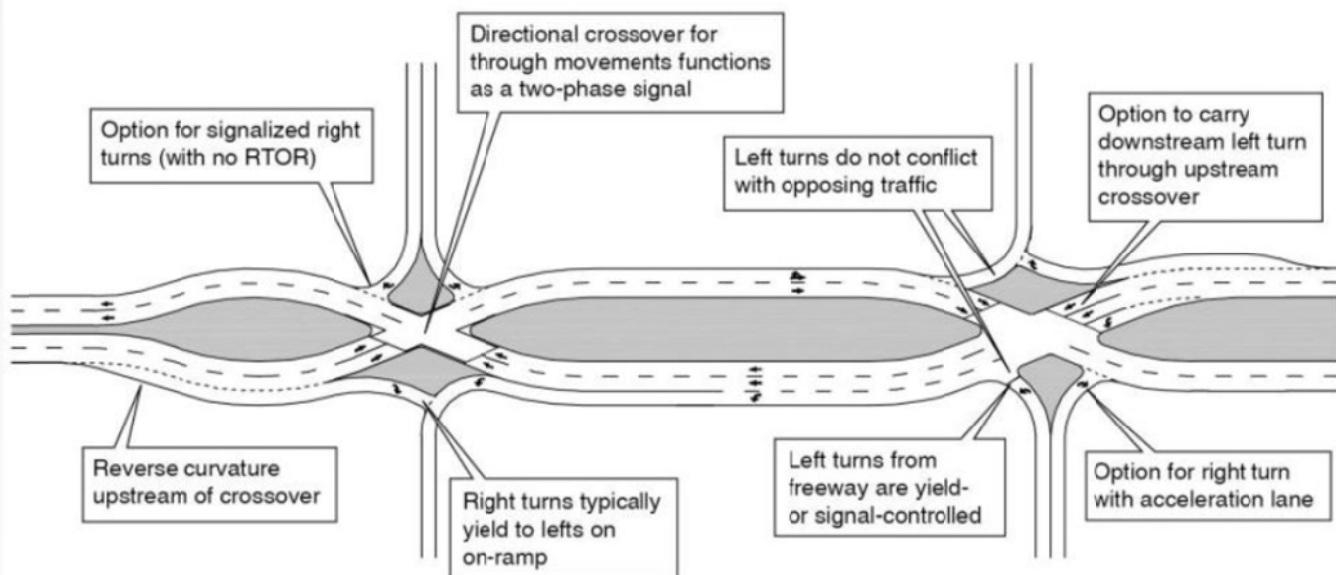

For more information on the above mentioned Innovative Intersection Designs see:  
[http://www.virginiadot.org/info/alternative\\_intersection\\_informational\\_design\\_guides.asp](http://www.virginiadot.org/info/alternative_intersection_informational_design_guides.asp)  
[https://safety.fhwa.dot.gov/intersection/alter\\_design/](https://safety.fhwa.dot.gov/intersection/alter_design/)

\* Rev. 7/17

### **Diverging Diamond Interchange (DDI)\***

A diverging diamond interchange (DDI), sometimes referred to as a double crossover diamond (DCD), is a diamond interchange that facilitates heavy left-turn movements. The upstream area consists of distance for travel during a perception-reaction time, travel for maneuvering and deceleration, and queue storage. The downstream area includes the length of road downstream from the intersection needed to reduce conflicts between through traffic and vehicles entering and exiting a property (See Figure A-3-3 for layout.) Refer to Appendix F, Figure 4-2A for Physical and Functional Areas of Intersection and Figure 4-3 to determine Functional Area of Intersection along the minor roadway. The Access Management Manual published by the Transportation Research Board notes that “Stopping sight distance is one method of establishing the downstream functional areas of an intersection.” When calculating downstream functional area with this method, traffic control at the intersection is not a factor.

While the ramp configuration is similar to a traditional diamond interchange, traffic on the cross route moves to the left side of the roadway for the segment between signalized ramp intersections. By moving traffic to the left, left-turning vehicles can enter from the ramp to the major roadway without the need for a left-turn signal phase at the signalized ramp intersections. In addition, a DDI reduces conflict points of a traditional diamond interchange from 30 to 18 based on fewer crossing points. (See Table 3-1). This includes merge and diverge points on the major road, not at the ramp terminals.

This reduction in conflict points should represent significant improvement in safety.

Some of the situations where a DDI may be suitable are listed as follows:

- Heavy left turns from ramps onto major roadway
- Moderate or unbalanced through volumes on the crossroad approaches
- Moderate to very heavy left-turn volumes from the major roadway off-ramps
- Limited bridge deck width
- Expected remaining life of the bridge should be evaluated when considering the DDI design when the project involves converting an existing diamond interchange to a DDI without widening the existing bridges.

<b>TYPE</b>	<b>Diamond</b>	<b>SPUI</b>	<b>DDI</b>
Diverging	10	8	8
Merging	10	8	8
Crossing	10	8	2
<b>Total</b>	<b>30</b>	<b>24</b>	<b>18</b>

**TABLE 3-1 CONFLICT POINTS**

---

\* Rev.7/17

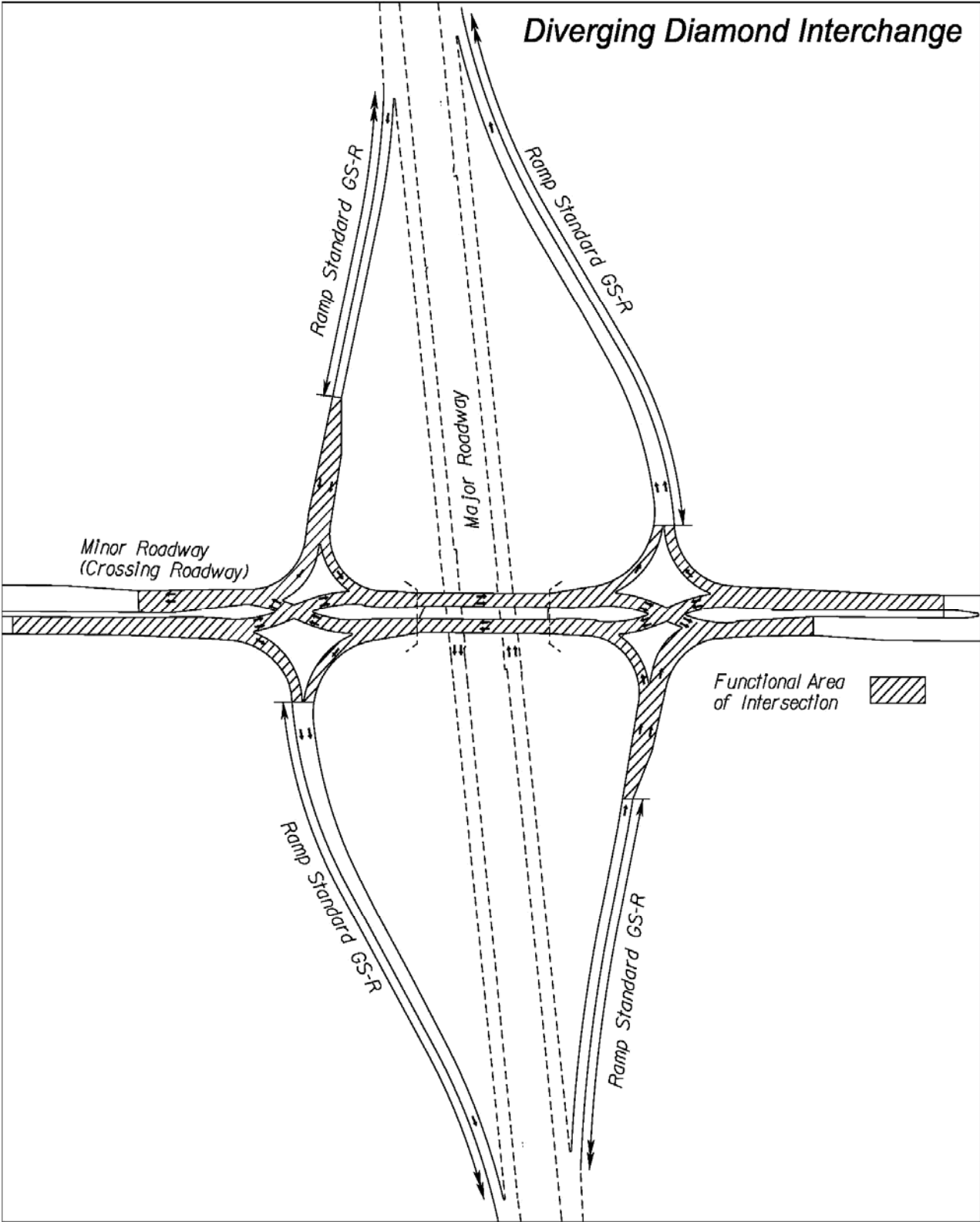

**FIGURE A-3-3 DIVERGING DIAMOND LAYOUT\***

\* Rev. 7/17

**Advantages of This Type of Interchange\***

- The DDI interchange offers benefits over conventional interchange designs with its efficient two-phase signal operation, narrower bridge structure width, lower costs, fewer conflict points, expected increase in throughput, reduced vehicular delay, opportunities for reducing pedestrian / vehicle conflicts and reduced environmental impact.
- A DDI has a higher capacity for all signalized movements when compared to the conventional diamond interchange. The capacity of left-turn movements is approximately twice that of the corresponding capacity of left-turn movements of the conventional diamond interchange. Exclusive left-turn lanes on the cross route are not necessary for the DDI. The ability to accommodate a high number of left turns improves the efficiency and, thereby, the capacity of the interchange.
- To be comparable to a 4-lane DDI, a conventional diamond interchange would require 6 lanes to provide the same capacity. When additional future capacity is needed, it could be advantageous to convert a conventional diamond interchange to a DDI instead of pursuing the more costly option of widening the major and minor roadways in the interchange (including widening the bridge) and adding additional lanes to the ramps. Any conversions and capacity/efficiency benefit however should be analyzed using the appropriate traffic analysis tools.
- The application of a DDI may reduce project costs by allowing the use of existing structures and right of way or, at least, requiring the narrowest or shortest bridge and right of way template possible. This is mainly due to the reduction of required left-turn lanes. Under appropriate traffic conditions, there may be a possibility that designated left-turn lanes can be eliminated in one or both directions on the cross route. The appropriate lane geometry of a DDI should be however analyzed and modeled ahead for traffic operational behavior.
- The DDI's advantage is to make the movement from the cross route to the major roadway more efficient. The left turn from the cross-ramp onto the on-ramp should not be signalized unless necessary to address the potential for pedestrian conflicts.

---

\* Rev. 7/17

## Disadvantages of This Type of Interchange

While the advantages of the DDI make it an attractive solution for a variety of traffic conditions, it is not applicable everywhere. As with any solution, there are disadvantages to consider.

- When current or projected cross route through volumes are high, the drivers inconvenienced the most by the installation of a DDI are those going through on the cross route because they must crossover to the left side of the road and then back again to reach their destination.
- Problematic for high-speed arterials. Reverse curves of crossovers based on 35 mph or slower.
- Through movements must be controlled and cannot be free-flow. If current or projected through traffic volumes on the crossing route are high, other interchange configurations should be considered at the conceptual stage.
- Off-ramp traffic may not directly re-enter an on-ramp. However this design does allow for U-turns from one direction of the major route to the other.
- In areas with HOV lanes located in the median, future HOV connections to the overpass structure may not be feasible with a DDI configuration.
- If there is a high volume of pedestrians, additional signals may be needed and must be timed for adequate pedestrian crossing times, thus, potentially influencing the effectiveness of the interchange.
- Geometry and traffic control device design must be very carefully thought out to minimize any possibility of drivers and/or bicyclists entering the wrong direction between the crossovers. More overhead sign structures with larger guide signs may be needed at a DDI as compared to a traditional diamond interchange
- There are no U-turns at the intersections of a DDI at the ramp.
- Closely spaced intersections to the DDI could heavily influence traffic demand to/from the DDI, potentially limiting the operational effectiveness of the DDI for vehicular traffic
- Generally, a DDI is limited to one of two operational strategies: emphasized coordination to the off-ramp left turn movement or emphasized coordination of the through traffic movement across the interchange. If both movements are heavy, the overlap of queues can be difficult to overcome during peak periods without sufficient capacity.
- Future traffic growth should be figured into the design including the modification for additional capacity.\*

---

\* Rev. 7/17

## **Crossovers (See Figures A-3-4 & A-3-5) \***

The horizontal crossover geometrics consist of three main interacting elements: 1) crossing angle; 2) tangent length approaching and following the crossover; and 3) superelevation and curve radii approaching and following the crossover. Placement of the two crossovers is largely dependent upon the spacing and location of the ramps. The space needed for vehicular storage between the crossovers must also be considered. When there is room, there is a fair degree of flexibility in the placement of the crossovers. If more length is needed than the distance between ramp termini provides, the crossovers may be located farther apart. As a result, the ramp entrances and exits will need to be configured to merge or diverge with the cross route by either extending or shortening them. For practical design application, the center of each crossover can be slightly skewed from the crossroad centerline and/or offset, as shown in Figure A-3-4.

### **Crossing Angle**

The crossing angle is the acute angle between lanes of opposing traffic within the crossover with optimum crossing angles ranging from 40-50°. The approach angle for cross-over intersections of a DDI should be 30° or greater. A recommended approach is to use the largest crossing angle possible while balancing each of the horizontal geometric crossover aspects. However care should be exercised in choosing a larger crossing angle, which could cause drivers to perceive it as a “normal” intersection.

Larger crossing angles in combination with sharper reverse curves can increase potential for overturning and excessive driver discomfort due to centrifugal forces acting on the driver. Cargo may also shift back and forth depending on speed. Another crossing angle factor that compounds driver discomfort is when the length of roadway between crossovers and/or approaching crossovers is limited. The appropriate geometry of a DDI should be analyzed and modeled ahead for traffic operational behavior

### **Superelevation Design / Curve Radii**

The curves approaching and following the crossover should allow the design vehicle to navigate the interchange at the design speed as well as accommodate the turning movements to and from the ramps. In most instances, an urban low speed design ( $\leq 45$  mph) should be used on the roadway containing the DDI and adhere to VDOT's TC-5.11ULS superelevation criteria. The design vehicle, a WB-67 as shown in 2011 AASHTO Green book Figure 2-15, should be able to operate through the DDI at 20 mph and make all turning movements to and from the ramps. A vehicle classification count should be done to determine the vehicle composition in the area and AutoTurn should be used to make sure the angles proposed are negotiable by the most restrictive vehicle. In addition, the urban low speed design should encompass the footprint (See RDM [Appendix F, Figures 4-2A and 4-3](#)) of the intersecting ramps.

---

\* Rev. 7/17

The remaining entrance ramp and exit ramp design (Standard GS-R) should continue with VDOT's TC-5.11 rural superelevation between the major roadway and the functional area limits of the minor crossroad (See Figure A-3-3).\*

Urban design criteria shall be used within the DDI. For entrance ramps to the major roadway, the urban designation ends at the gore area (See Figure A-3-3).

Each curve along the minor roadway should transition to and from the tangents of the crossover. Curve radii used along the crossroad in DDI designs generally range from 150-400 feet depending on chosen design speed.

### **Tangent Length**

The most valuable aspect of adding tangent length before and after a crossover is the propensity to align vehicles to the correct receiving lane as they approach the crossover.

When tangent length beyond the intersection is used, a length of 15-20 feet along the inner edge of pavement is recommended before the crossover. This distance should be provided measuring from behind the stop bar when possible, but may be provided from the crossover itself when space is limited. Since cars do not experience stopping after the crossover, a shorter length of about 10-15 feet along the inner edge of pavement is encouraged. Figure A-3-4 shows the recommended minimum lengths.

### **Lane Width**

The crossover lane width is a function of the layout and horizontal geometrics in conjunction with modeling the off tracking of a WB-67. A recommended approach is to begin the design using the minimum lane widths of 15 feet and widen them based on the off-tracking modeling until optimum lane width is achieved. Such might be the case if the crossroad has a wide median. All approach lanes on the crossroad should be tapered following the lane width transition as shown in Figure 3-23 in Appendix F of the RDM. The lanes should be tapered to meet the crossover lane width before entering the curve approaching the crossover and maintained through the curve after the crossover. Between the crossovers, lane widths may need to be tapered if existing conditions constrain the roadway. Existing structures can limit lane width between crossovers. Right-of-way can affect lane width approaching a crossover.

Pedestrian and bicycle accommodation can influence lane widths before, after and between the crossovers. The ramp spacing and distance between the crossovers are additional considerations. The lane width between the crossovers should meet standard lane width where possible but shall not exceed the lane width of the crossover.

---

\* Rev. 7/17



## Shoulders\*

If the cross route has shoulders and there is space, they should be continued through the interchange. For a relatively short segment in a DDI, the left shoulder becomes the outside shoulder and the right shoulder becomes the inside shoulder. For this reason, some alterations to the shoulders may need to be considered.

Under normal circumstances, when a vehicle needs to pull over and stop, the driver expectation is to use the right shoulder. In addition, the left lanes between the crossovers will be heavily used for left-turn movements and potentially experience more weaving. While it is not desirable to have vehicles stop and pull over between the crossovers, the design should account for that possibility when feasible. The right shoulder is considered the safer place, which, in this case, is the inside shoulder. In addition, bicyclists riding on the right shoulder would expect to be able to continue using the same shoulder through the interchange.

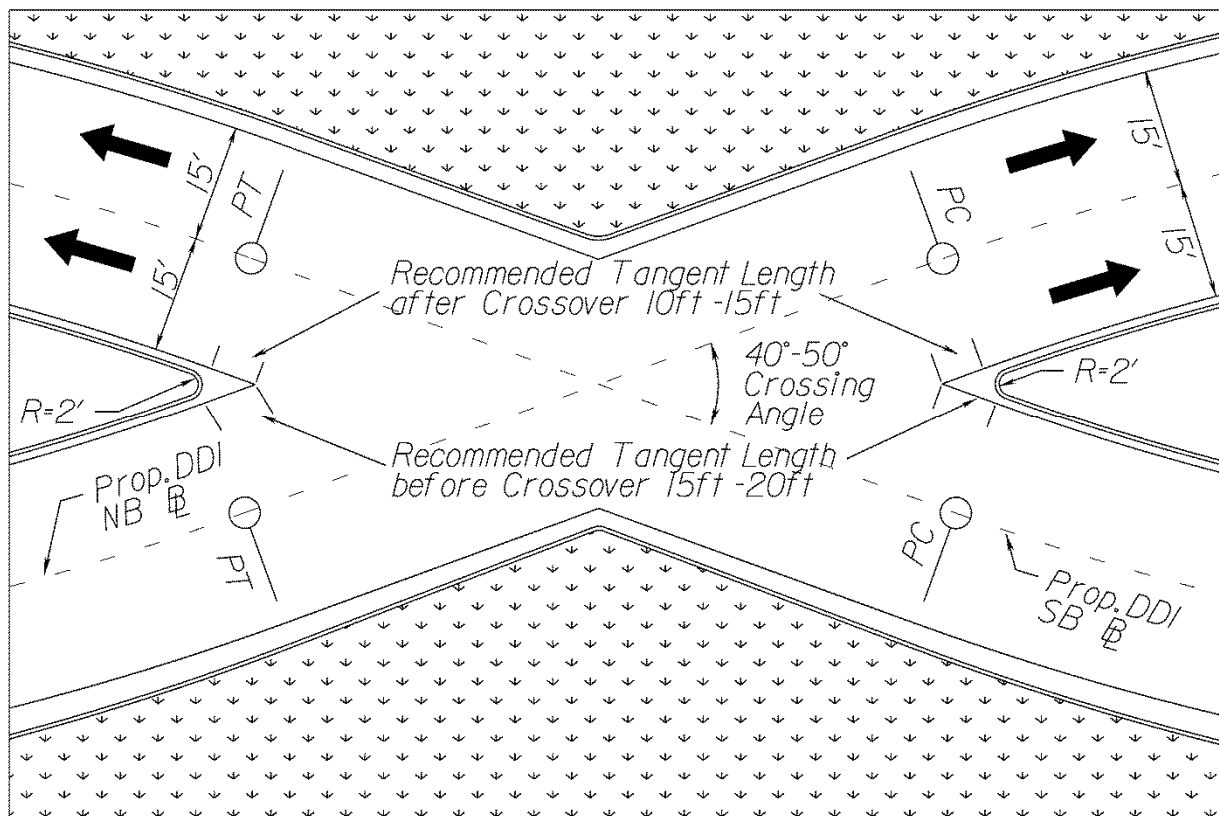

**FIGURE A-3-4 CROSSOVER GEOMETRICS**

\* Rev.7/17

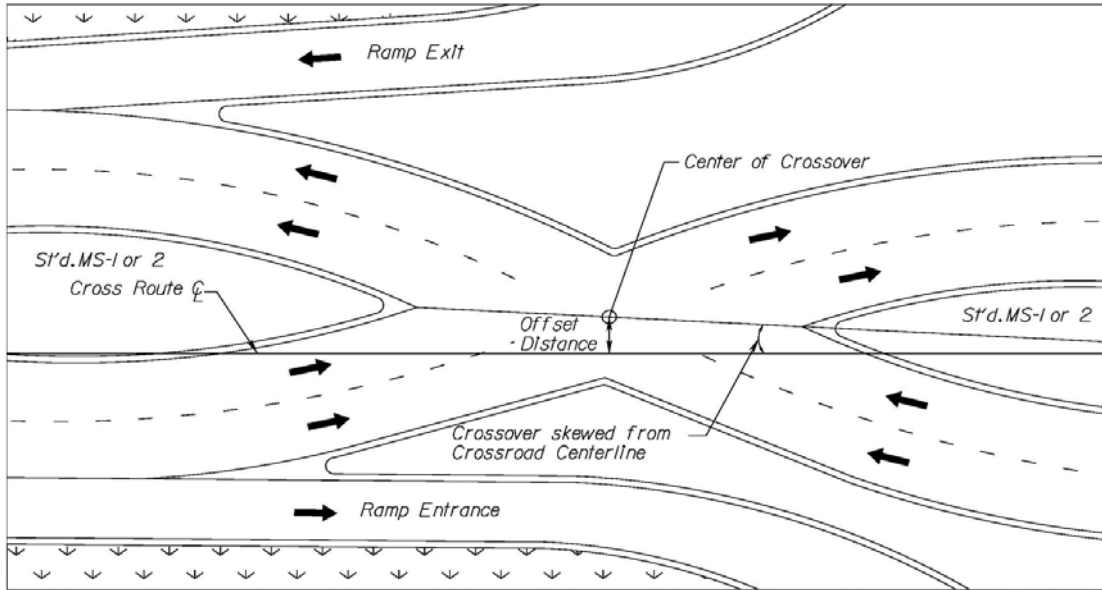

**FIGURE A-3-5 OFFSET DISTANCE FOR INTERSECTION**

Current design practices that had shoulders on the cross route kept the right and the left shoulder widths constant through the interchange, as shown in Figure A-3-6. However, it may be advantageous to narrow the left shoulder approaching and between the crossovers to discourage drivers from stopping. Cross routes passing over the major roadway on existing structures may require both shoulders to be narrowed similarly to a traditional diamond interchange.\*

Shoulder design requires more right of way or more bridge span length when the crossing roadway is under the bridge. Shoulders may not be feasible for a DDI located under a bridge.

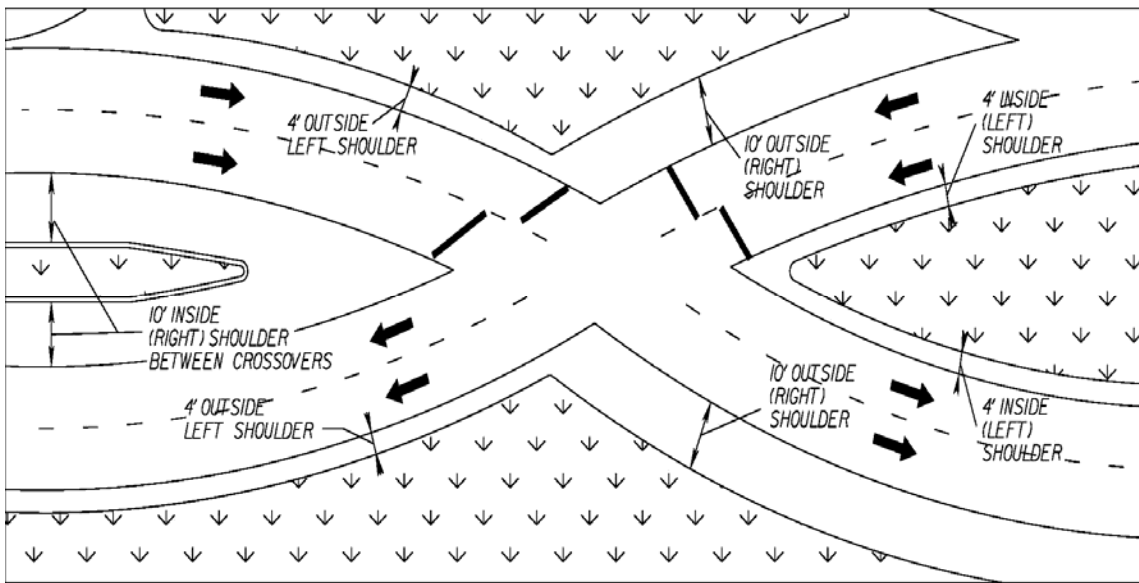

\* Rev. 7/17

**FIGURE A-3-6 SHOULDER DESIGN FOR DDI****Sight Distance\***

Two areas of specific importance to a DDI are sight distance for vehicles making crossover movements and vehicles exiting from the major roadway. The driver of a vehicle approaching or departing from an intersection should have an unobstructed view of the intersection, including any traffic control devices, and sufficient length along the cross route to permit the driver to anticipate and avoid potential collisions. The same sight distance principles, as described in the AASHTO Green Book, should be followed when designing a DDI.

Particular attention should be paid to the sight lines of vehicles turning from an exit ramp under yield control; this is true for either single- or multiple-turn lanes. For the driver making a right turn from the exit ramp of a DDI, their expectation is that traffic will be moving from the nearest lanes on their left. However, the traffic is actually approaching from the far left lanes since the direction of traffic is switched, as shown in Figure A-3-7.

If there is room, a possible way to minimize this issue is by moving the right turn further from the crossover to increase the amount of sight distance available to these right-turners as well as give them more time to realize where oncoming traffic is coming from. The approach angle should be such that drivers in the turning lane should be able to see the oncoming traffic without difficulty for yield control condition.

For a signal controlled condition, sight triangles between the left turns and right turns to and from the ramps should not be large. This means the island between the left and right turn lanes from the ramp should be designed accordingly. Smaller sight triangles will also shorten all the red times to clear traffic leaving the crossover intersections and also clear the next conflict point.

Another consideration is to channelize the right turn coming off the ramp more so when drivers turn to view the oncoming traffic, it more likely falls in their natural line of sight. The right turn lanes could be extended so that traffic is parallel and vehicles can merge further from the crossover.

---

\* Rev. 7/17

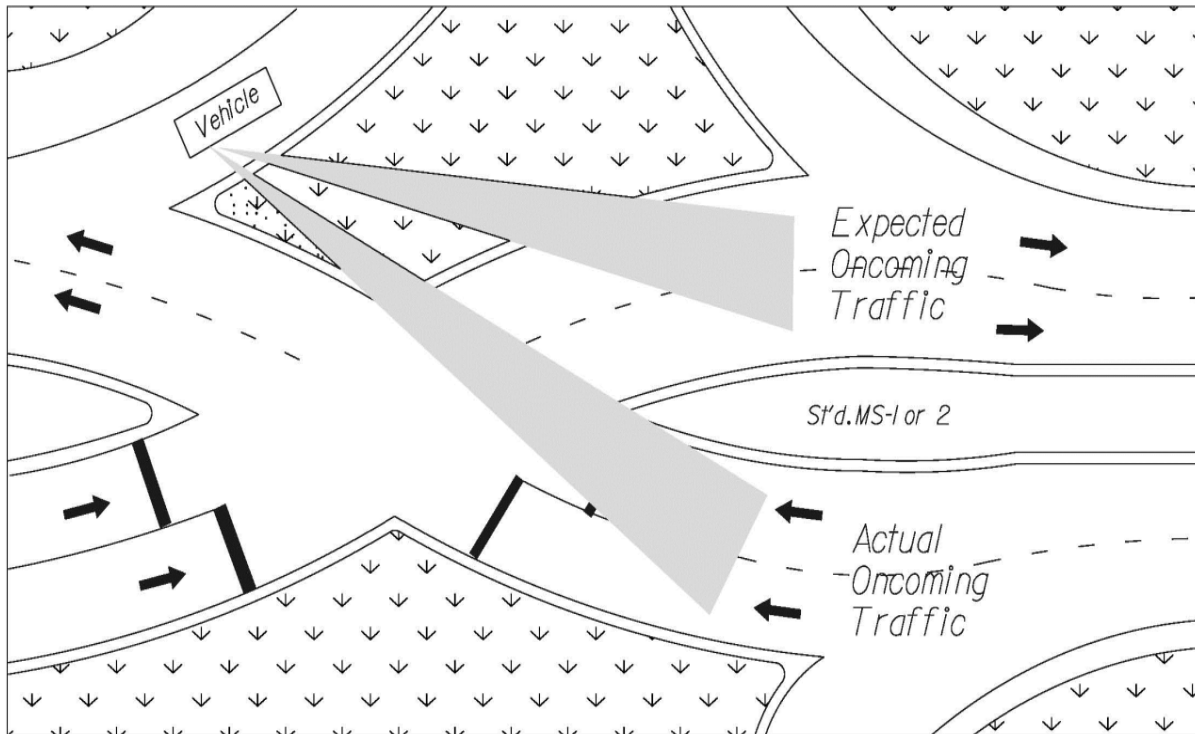

**FIGURE A-3-7 DIAGRAM OF EXPECTED ONCOMING TRAFFIC VERSUS ACTUAL ONCOMING TRAFFIC**

### **Clear Zones\***

Clear zones are to be provided on all ramps and the minor roadway. See RDM Appendix A, Section A-2 for more guidance on clear zone.

### **Lateral Offset**

The minimum lateral offset of 1.5 feet is to be provided on the minor roadway when using curb and gutter design. See RDM Appendix A, Section A-2 for more guidance on lateral offset.

### **Ramps**

Traffic capacities for ramp design are subject to variation and are limited by the geometric features of the ramp itself, the ramp termini, the weaving sections, the volume of through and turning traffic and intersection spacing within the functional area of the interchange. Because the ramp through-movement is physically prohibited, accommodations for this movement downstream of the interchange on the cross route should be considered. These accommodations should be considered when applying access management principles and evaluating capacity.

\* Rev. 7/17

Traffic operational analysis of the existing conditions at the interchange, as well as for the proposed DDI shall be performed to determine the appropriate DDI geometry and quantify the operational benefit in terms of delay (sec), queue lengths (feet), etc. The analyses shall be conducted for the existing traffic volumes for existing geometric conditions and DDI, and projected future traffic for existing geometric conditions and DDI, the projected year of analysis shall be discussed and determined with the VDOT project manager, it shall include any major change in traffic volume patterns anticipated due to land use, etc., this is necessary as the efficiency of a DDI is dependent on the traffic volume patterns.\*

The analyses shall be based on the guidelines in VDOT's latest version of the Traffic Operations Analysis Tools Guidebook and in consultation with the VDOT project manager/traffic engineer within a mutually agreed upon impact area. The traffic impact area shall contain at a minimum, the interchange being considered including the full length of all ramps proposed and the merging area of the on-ramp with the interchange/ main roadway; and any median accesses within ½ mile on either direction of the cross road. The traffic analysis shall at a minimum include all the proposed signal coordination plans within impact area, the controller configurations (single/multiple) and also include left turn on red analysis. In addition, engineering judgment should be used to determine the various aspects of the geometry and signal configuration proposed; all suggested geometry and signal configurations shall be evaluated as described above.

Ramp design for a DDI should take into consideration the need of separate lanes for left-and right-turning traffic especially when either movement is signalized. While traditional ramp designs allow for shared lane usage, exit ramp design for a DDI should provide separate left- and right-turn lanes prior to the ramp terminal. This is because the phasing for the signalized left turn and right turn typically does not occur simultaneously. The storage lengths of these lanes are dependent upon projected volumes and potential queuing.

### **Access Control / Spacing of Intersections**

Nearby signalized intersections may reduce the effectiveness of a DDI. The two-phased signal phasing of the DDI typically allows for shorter cycles lengths which may impact the coordinated operations of nearby traffic signals. When evaluating a DDI, the traffic analysis should consider whether the entire interchange should be operated with a single signal controller or if multiple controllers should be used for the two separate intersections.

As with any interchange type, the minimum intersection spacing shown in the RDM [Appendix F, Table 2-3](#) and [Figure 2-9](#) shall be used. VDOT's access control standards shall be followed. However in developed areas, it may be difficult to achieve the standards. If these standards are not met, an Access Management Exception (AM-E) or an Access Management Waiver (AM-W) shall be required.

---

\* Rev. 7/17

Special consideration must be given in evaluating a DDI when the nearest full access intersection is less than the minimum distance shown in Appendix F. The DDI typically operates essentially as a two-phase signal with only one direction of travel on the cross route allowed through the interchange at a time. When there is a signalized intersection in close proximity to the DDI, it may not be possible to coordinate both directions of travel along the cross route with the adjacent signal resulting in one direction of travel queuing in the small space between the intersections. When considering a DDI with a signalized intersection close to the interchange functional area, other interchange types should also be considered.\*

Traffic projections require additional attention when evaluating the use of a DDI in a closely spaced signal system. When this is the case, a sensitivity analysis should be performed. A sensitivity analysis evaluates how changes in the traffic projections affect the results of the operational analysis (LOS or capacity). The sensitivity analysis will show if the proposed improvements only work under a limited number of traffic conditions or if the proposed improvements are flexible enough to satisfy a variety of future traffic conditions.

At this time, it does not appear that closely spaced right-in, right-out access or left-in accesses pose a greater challenge for DDIs compared to other interchange types. When evaluating non-signalized access points, additional care should be given so the access does not interfere with the operations of the right turns either onto or off the ramps. Spacing between the two crossover intersections should be sufficient enough to accommodate the through queue for the design year. As a rule of thumb, spacing between the crossovers should be a minimum of 800 feet. Maximum queues based on microsimulation modeling should be used to verify the spacing between two crossover intersections.

## **Pedestrians**

There are two basic ways to accommodate pedestrians at a DDI. They can be placed in the middle of the cross route between the crossovers (Figure A-3-8) or kept on the outside perimeter (Figure A-3-9). This decision can influence the number of signals and the capacity of the interchange. If pedestrians are kept to the outside perimeter as shown in Figure A-3-9, then they do not have the ability to cross from one side of the street to the other.

Pedestrian crossings for a DDI may involve crosswalks and signal pedestrian control features at the junctions of the interchange. Depending on the pedestrian network in the vicinity of the interchange, it may not be necessary to have pedestrian walkways on both sides. Since the crossover junctions in a DDI operate on a two-phase signal control, pedestrians are directed to cross the minor roadway in two stages. Adequate pedestrian refuge should be provided between all stages of the crossing. Depending on the configuration, pedestrians may have higher or lower numbers of controlled and uncontrolled crossing locations at a DDI as compared to a traditional diamond interchange.

---

\* Rev. 7/17

Any pedestrian crossings of free-flow movements should be carefully reviewed to ensure adequate sight distance for drivers approaching the crosswalk. In the case of a DDI where the cross route passes underneath the major road, the structure may also impact sight distance.\*

The DDI design involves multiple-stage crossings with islands acting as refuges. In addition, the design of crossovers at the nodes of the interchange typically results in flares and large central islands. Barriers help prevent pedestrians from attempting to cross at undesirable locations. Barriers should be rigid with appropriate end treatment. Alternatively, guardrail systems that pose a lesser hazard to motorists (i.e., spearing hazard) can be used to channelize pedestrians. Barrier separation from traffic should be used when pedestrians are placed down the center of the cross route. If bicycles will be present, a barrier height of 54 inches is required. Minimum standard sight distance shall be provided when barrier is present.

All sidewalks and crosswalks shall be in compliance with VDOT standards. (See [IIM-LD-55](#) and RDM Appendix A)

Pedestrian facilities located along the outside of the interchange may also cause pedestrians to make more conflicting movements, walk a longer distance, and cross at an unsignalized left-turn. Most pedestrians are not accustomed to crossing at the unsignalized left-turn of a DDI.

When pedestrian facilities are present, the left or right turn to and from the ramps may require signalization and negatively influence the interchange's operation. The negative impact may be minimized depending upon geometrics and other design choices. Some at-grade pedestrian crossings can be located where oncoming traffic approaches from an unfamiliar direction. Since pedestrians are typically conditioned to look "left-right-left" before crossing the street, there is potential for pedestrian confusion at these locations.

When the crossroad passes under the limited access highway, structural obstacles may restrict sight distance at free left turns approaching pedestrian crossings.

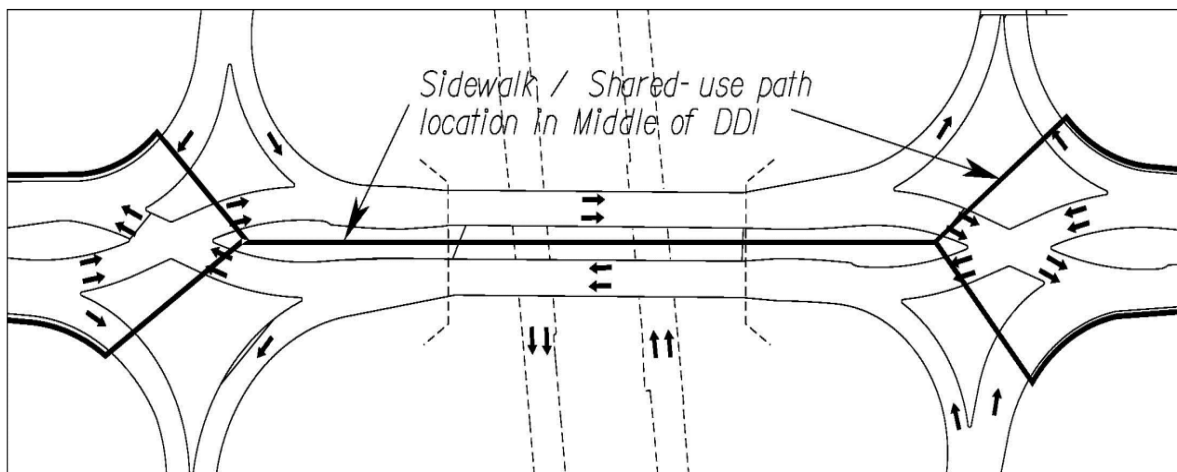

**FIGURE A-3-8 PEDESTRIANS LOCATED TO MIDDLE OF CROSSROAD BETWEEN CROSSOVER**

\* Rev. 7/17

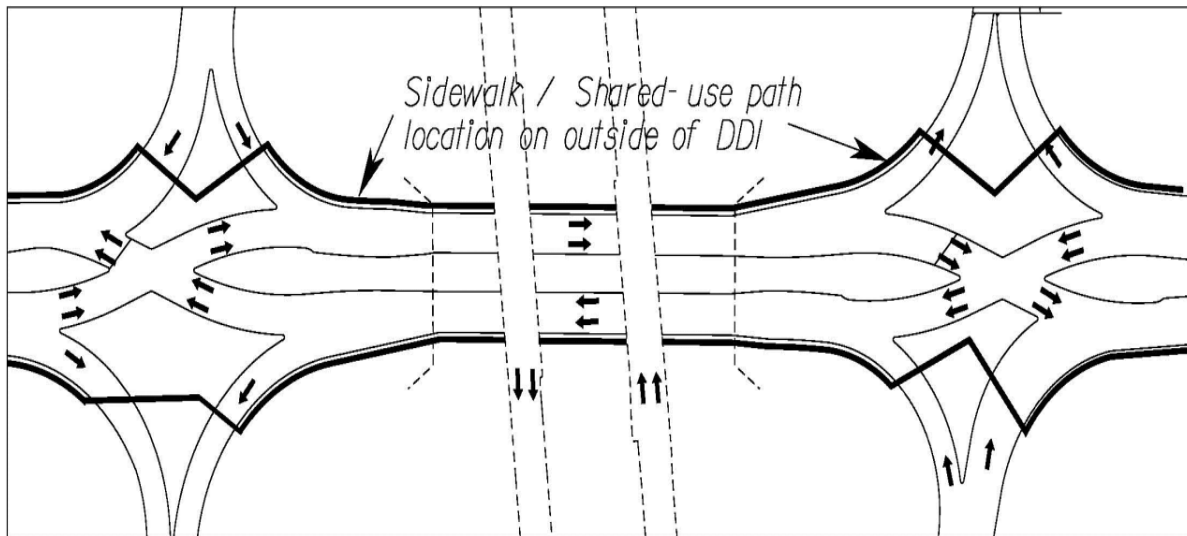

**FIGURE A-3-9 PEDESTRIANS LOCATED TO OUTSIDE**

### **Bicycles\***

Bicycle accommodations should be considered on all DDI designs and, whenever possible, existing bike accommodations should continue through the interchange. Bicycles operating along the minor roadway through a DDI can be accommodated with the use of bicycle lanes or shared-use paths. If bike lanes or shoulders cannot be carried through the interchange due to space constraints, they should be terminated far enough in advance to encourage cyclists to mix with vehicle traffic. Bicycles are encouraged to stay in the right side of the right lane through a DDI. If a high volume of bicyclists is expected and a sidewalk is proposed, it should be widened and constructed using Shared Use Path design criteria as shown in RDM Appendix A and as given in AASHTO's "Guide for the Development of Bicycle Facilities." If bicycle lanes are carried through the interchange, bicyclists should be directed to stay to the right of traffic (on the inside) between the crossovers. Careful consideration needs to be given to the potential for bicycle-vehicle conflict and also to provide proper guidance for bicyclists so they do not attempt to ride on the wrong side between the crossovers.

### **Standards and Criteria**

- Urban Low Speed criteria shall be followed along minor roadway of the DDI. A Design Exception is not required for Design Speed within the functional area of a DDI that does not meet the corridor design speed. (See Figure A-3-3)
- Left-turn and through movements are relocated to the opposite side of the road on the bridge structure.
- The minimum spacing between crossovers should be 800 ft.
- The crossing angle of intersection should be between 30° and 50° (See Figure A-3-4).

\* Rev. 7/17



- The minimum design speed for the minor roadway shall be 25 mph.
- The minimum design speed where the ramps meet the crossroad shall be 25 mph (every attempt is to be made to use a design speed greater than minimum).\*
- Turning radii used at the crossover junction are typically in the 150 to 400 ft range and shall be determined by design vehicle.
- Curb and gutter design is preferred along the crossing roadway.
- The appropriate GS standard shall be used based on the functional classification of the crossing roadway.
- Standard MS-1 is preferred along the cross road due to less maintenance requirements.
- Lane width through the crossover shall be a minimum of 15 ft.
- Design shall accommodate WB-67 trucks so that one truck in each lane of the design can make the required movements without encroaching into the adjacent lane (if there is one). Autoturn® should be run to determine the off-tracking of the design vehicles and lane width should be adjusted upward to accommodate. Please see 2011 AASHTO Green book Tables 3-26b and 3-27.
- For channelization and safety reasons, a physical barrier should be provided between the crossovers to separate opposing directions of traffic. Either a barrier or a raised median shall be designed to physically separate opposing traffic between the crossovers.
- Adequate lighting should be provided. VDOT requires all roadway lighting designs to meet the lighting criteria as discussed in the current IESNA publication, *Recommended Practices for Roadway Lighting (RP-8)*. See VDOT's [Traffic Engineering Design Manual](#), Chapter 2 for more information.
- DDI interchange designs may only be appropriate where there are high-turning volumes.
- Median width is increased to allow for the flaring required for reverse curves on the interchange approaches.
- The noses of the median island should extend beyond the off-ramp terminals to improve channelization and prevent erroneous maneuvers.
- Median openings may be placed upstream of the interchange to allow U-turn movements on the minor roadway. There will be no U-turns allowed within the DDI functional area.
- Left- and right-turn lanes should not be shared and should be designed assuming that they will run under separate signal phases.

---

\* Rev. 7/17

## **Traffic Signal Considerations\***

A DDI interchange typically has two signalized junctions or nodes at the points of left-turn crossovers. The signals operate with just two phases, with each phase dedicated to the alternative opposing movements.

While every movement within a DDI can be signalized, they are not necessarily required to be. Turning movements should be signalized after considering factors such as the volume of conflicting pedestrians, the nature of the lane merge (yield or free-flow), the volume of the turning movements as well as the through traffic on being processed through the crossovers, and the number of turning lanes. Signalization of all movements should be considered on a case-by-case basis.

Signal warrant analysis and the need for pedestrian control features for the DDI shall follow the guidelines provided in the [MUTCD](#), the Virginia Supplement to the [MUTCD](#), and engineering judgment.

When signalizing the off-ramp left-turn, the distance between the crossover intersection and the off-ramp left-turn should be minimized. The longer the distance for the through movement to clear the intersection the longer the duration of the all-red clearance interval. Increase in the clearance interval may reduce the effective green time for the signal and the efficiency of the signal. The need for the long red clearance interval may not be readily apparent to many drivers and public expectations may need to be addressed.

Since left turning movements do not conflict with the opposing through movement in the DDI, left turn on red can be considered from the ramp. Due to the unique curvature and geometry of a DDI, special attention should be given to signal face placement. The primary consideration in the placement of signal faces is to optimize the visibility of signal indications to approaching traffic. Road users approaching the intersections are to be given a clear and unmistakable indication of their right-of-way assignment. All signal face placement, aiming, adjustment and positioning shall be in accordance with the [MUTCD](#) and/or [Virginia Supplement to the MUTCD](#).

Special attention should also be given to signal structure/mast arm and luminaire placement to ensure structures do not block the view of other traffic control devices. Straight-through green arrow signals, may be appropriate to discourage wrong-way turns, however the [MUTCD](#) expressly prohibits use of upward yellow arrow and upward red arrow signal indications.

Supplemental near-side traffic signal indications may be appropriate to provide optimal visibility for the movement to be controlled. It may also be appropriate to consider signal visors, signal louvers, or other means to minimize an approaching road user's view of signal indications controlling movements on other approaches.

Refer to Chapter 4D of the [MUTCD](#) and/or [Virginia Supplement to the MUTCD](#).

Consideration should be made for yield control vs. signal control for the DDI off-ramp left turns. One advantage to signalizing the DDI off-ramp left turn movement is it removes the weaving between those drivers and drivers on the cross street intending to turn left onto the downstream on-ramp.

---

\* Rev. 7/17

## Signing and Pavement Markings\*

Signing and pavement marking for the DDI shall follow the [MUTCD](#) and the Virginia Supplement to the [MUTCD](#). Since the DDI is a newer design, placement of markings, wrong-way signs, approach signing, overhead approach signage and wrong-way arrows/directional arrows to emphasize the correct direction of travel is critical. In addition, advance guide signs for drivers to stay in appropriate lane are equally important. Consideration should also be given to minimizing the amount of “sign clutter” that could cause driver delay or confusion.

Stop bars, yield bars and arrow lane markings are all standard applications. Dotted lane-line extensions are typically used to help guide motorists through the crossovers.

The potential for wrong way traffic movements in a DDI can be minimized with geometrics, signing, pavement marking, signals and lighting.

Although a DDI’s geometrics requires traffic on the cross route to move the left side of the roadway for the segment between signalized ramp intersections, the pavement marking used is similar to other interchanges. The yellow stripe shall be used on left of traffic and white on the right between crossovers.

6” wide lane and edgelines should be used through the DDI to improve driver recognition. Wider markings may be transitioned to normal markings downstream of the DDI at logical termini.

Snow-plowable reflective pavement markers (with red reflectors for the wrong-way movement) should be considered for use within the DDI for lane lines, wrong-way arrows and where appropriate on edge lines. Structure & Bridge Division approval may be required prior to installing raised pavement markers on bridge decks.

Guide signing is essential to proper operation of the DDI. Given the complex nature of the interchange, consideration should be given to mounting the guide signs for the cross street on overhead (butterfly, cantilever, or full-span) structures to safely guide drivers through the interchange and minimize the potential for confusion that results in drivers entering the wrong side of the DDI. If cantilever and/or full-span sign structures are used, they shall not exceed the maximum span lengths specified in the current version of [IIM-S&B-89](#).

Raised reflective markers should not be used on or adjacent to edgelines in areas where bicycles might be expected to exit or enter the shoulder across the edgeline.

Additional regulatory and warning signage may be necessary to guide users through the DDI. Examples of signs that should be considered are R4-8 series “Keep Left” signs and W24-1L series reverse curve warning signs. However excessive signing should be avoided to avoid distracting drivers with a “forest of signs” effect.

---

\* Rev.7/17

**\*Resources:**

1. FHWA DDI Informational Guide  
[http://www.virginiadot.org/FHWA-SA-14-067\\_DDI\\_Informational\\_Guide.pdf](http://www.virginiadot.org/FHWA-SA-14-067_DDI_Informational_Guide.pdf)  
FHWA DDI Brochure  
[http://www.virginiadot.org/FHWA-SA-14-039\\_DDI\\_Informational\\_Brochure.pdf](http://www.virginiadot.org/FHWA-SA-14-039_DDI_Informational_Brochure.pdf)
2. “Engineering Policy Guide, Chapter 234.6: Diverging Diamond Interchanges”, Missouri Department of Transportation 2014. Online:  
[http://epg.modot.org/index.php?title=Main\\_Page](http://epg.modot.org/index.php?title=Main_Page)
3. “Tech Brief: Double Crossover Diamond Interchange.” Federal Highway Administration. 2009. Online:  
<http://www.fhwa.dot.gov/publications/research/safety/09054/09054.pdf>
4. “Tech Brief: Drivers’ Evaluation of the Diverging Diamond Interchange.” Federal Highway Administration 2008. Online:  
<http://www.tfrc.gov/safety/pubs/07048/07048.pdf>
5. “Innovative Diamond Interchange Designs: How to Increase Capacity and Minimize Cost.” David Stanek. Institute of Transportation Engineers. 2007. Online:  
<http://tinyurl.com/y9yum2o>
6. “Traffic and Operational Comparison of Single-Point and Diverging Diamond Interchanges.” Praveen K. Edara. Transportation Research Board. 2009.
7. “Alternative Intersections/Interchanges: Informational Report”, Federal Highway Administration, 2010. Online:  
<http://www.fhwa.dot.gov/publications/research/safety/09060/>

## **SINGLE POINT URBAN INTERCHANGE (SPUI)\***

The SPUI, another variant of the compressed diamond interchange, was developed in 1970 to improve traffic capacity and operations while requiring less right-of-way than the diamond interchange. The turning movements of the major road ramps and all the movements of the minor road are executed in one central area that is either on the overpass or underpass.

Some of the key design characteristics that need to be considered when designing a SPUI are skew angle; number of through, left-, and right-turn lanes; median width; and islands. Generally, the bridge of a SPUI has a span length from 160 to 280 ft. depending on various geometrics of the crossing. The bridge structure of a SPUI has a large deck and is more expensive to construct in comparison to a TUDI, which is relatively easy to design and construct.

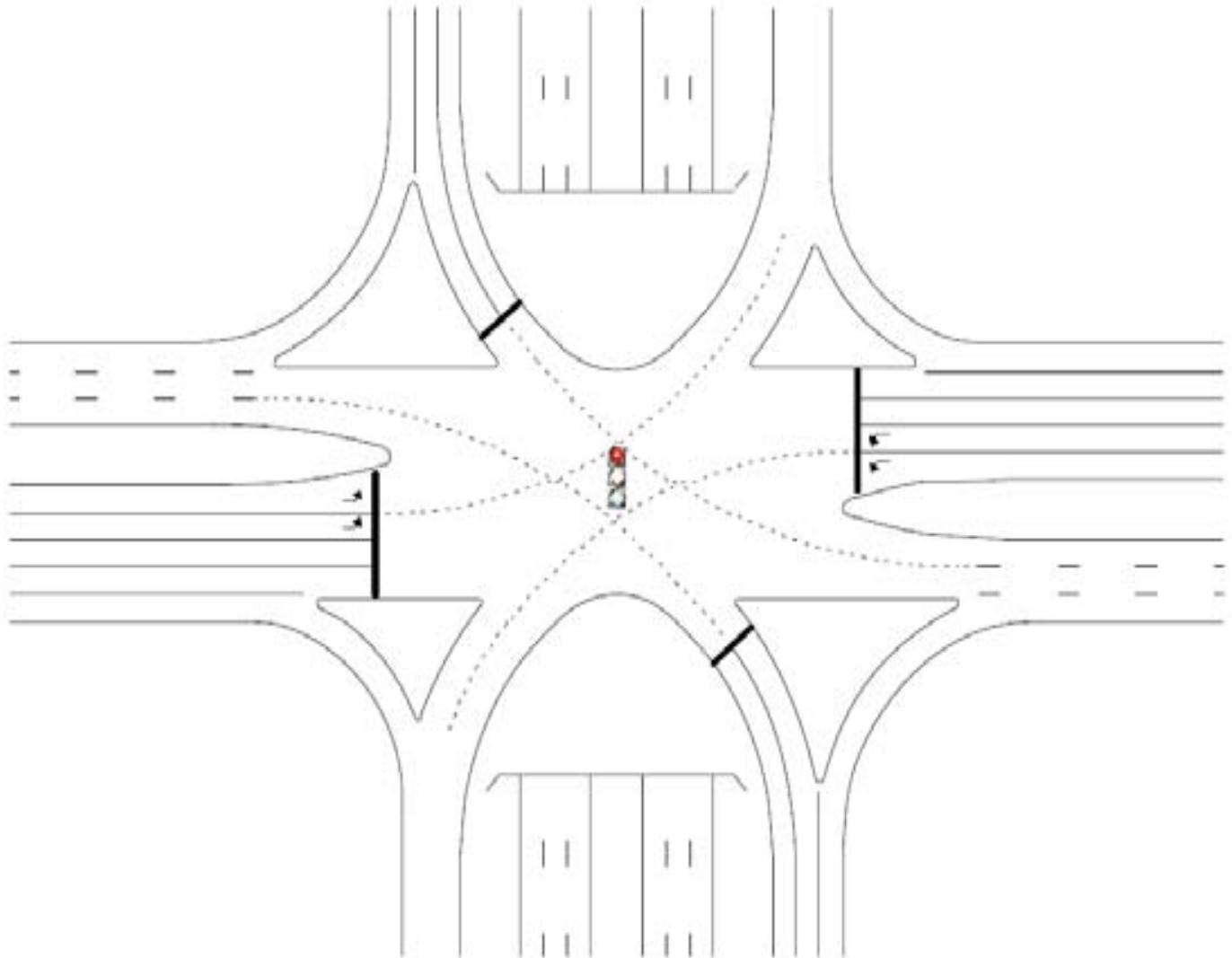

---

\* Added 7/17

## DOUBLE ROUNDABOUT INTERCHANGE\*

The Double Roundabout Interchange, alternatively referred to as a roundabout interchange, uses the concept of roundabouts at the grade-separated interchange. In effect, the minor street through movements navigate through roundabouts. There can be two types of roundabout interchanges—double and single. The double roundabout version uses two roundabouts at the ramp terminals. The single roundabout type has a single large roundabout designed over the arterial and serves as the overpass for the turning movements

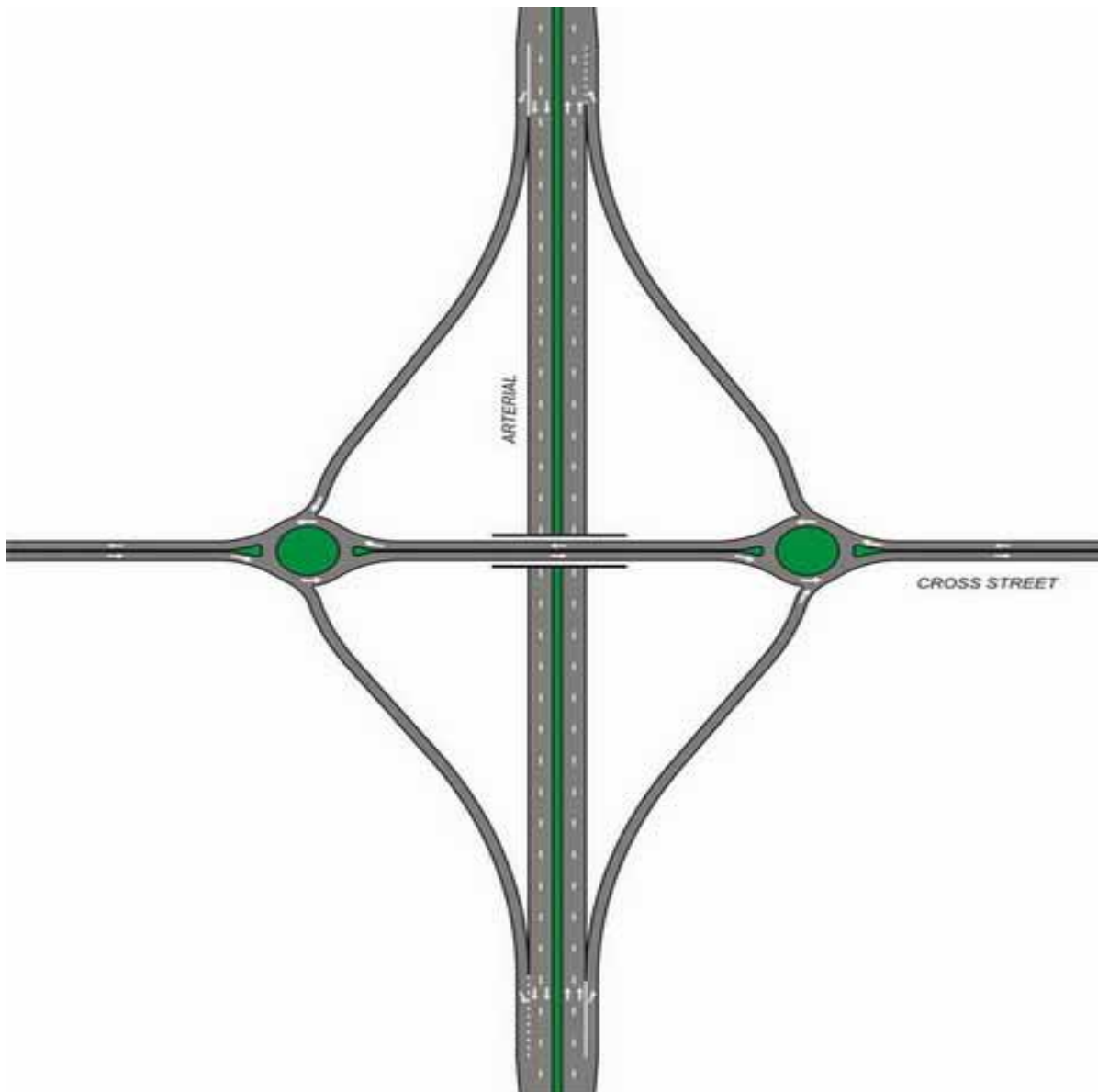

For more information on the above mentioned Innovative Interchange Designs see: [https://safety.fhwa.dot.gov/intersection/alter\\_design/](https://safety.fhwa.dot.gov/intersection/alter_design/)

---

\* Added 7/17