











# ***User and Installer Handbook***

Tapworks Softener Models Ultra 9, AD11 & Infinity  
With Easy Fit all-in-one kit

For technical support call Tapworks Water Softeners: 01494 480 621

Please retain this handbook for future reference.

# Identifying major parts of your water softener

	Description	Quantity	Part No.
	All in one by pass with check valve with pre-fitted lubricated O rings	1	73502
	Adaptor Clips	1 pair	7116713
	Inlet/outlet push fit hoses (500mm) with 22mm connections	2	73502H
	Silicone Grease	1	n/a
	Drain and Overflow Tubing	1	10069
	Overflow Elbow Overflow Grommet	1 1	7331258
	Drain & Overflow hose clips	2	n/a
	Transformer	1	7323679
	Hard Water Test Kit	1	800005
	Spares-Adaptor 'O' Rings	2	
	Adaptor elbows - not required when fitting the All in one by pass		

You may need reducers or spigot elbows to fix to your existing plumbing.

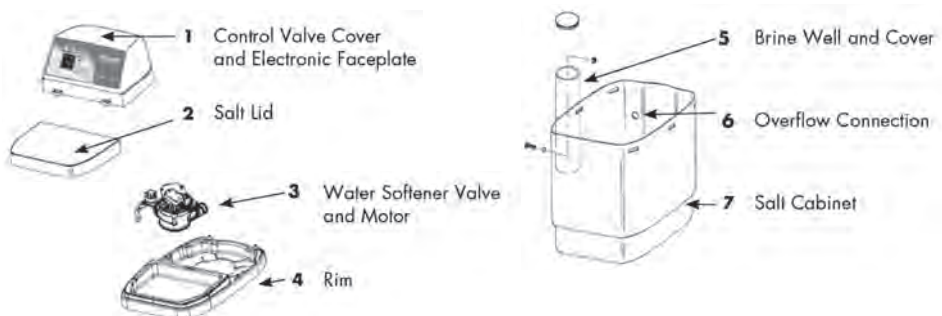

## Note

Model number and serial number are required for registration of warranty (located under salt lid).

**Please Remember** – Only use tablet or pellet salt in your softener!

# Installation of your water softener

---

**WARNING: FAILURE TO MEET THE FOLLOWING REQUIREMENTS CAN CAUSE DAMAGE TO THE WATER SOFTENER, OR RESTRICT ITS OPERATION.**

We recommend your water softener is professionally installed. Your installation must conform to water and electrical regulations and local plumbing codes.

## SPECIFICATION

- Maximum water temperature 49°C
- Maximum daytime working pressure 5 Bar
- Minimum working pressure 1.3 Bar
- Minimum system flow 0.06m<sup>3</sup>/hr
- Maximum system flow 3.18m<sup>3</sup>/hr

## PRESSURE

Night time pressure will be much higher than day time pressure.

If day time pressure exceeds 5 bar, a pressure reducing valve should be fitted. The water softener is tested to a maximum day time static pressure of 8.5 bar, therefore the pressure reducing valve can be adjusted to a maximum of 6 bar static pressure.

## GRAVITY FED PLUMBING SYSTEMS

If the water flow is less than 1 litre per minute, for the water softener to operate as originally designed we recommend a delayed action ball valve is fitted within your storage tank.

## UNVENTED OR COMBINATION BOILERS

The water softener and 22mm installation kit is compatible with unvented or combination systems.

## ELECTRICAL REQUIREMENTS

The water softener requires a 240 volt 50 hz electrical supply taken off a power supply, not a lighting circuit. Power is supplied via a 24 volt 50 Hz transformer. You must use the transformer supplied with the softener.

## HARDWATER TAP

Fitting a separate hard water drinking water tap is currently recommended by the UK Dept of Health and the UKWTA. Fitment of a separate hard water drinking tap is only required in exceptionally hard water areas (above 400 mg/l) where sodium content of the treated water (increased due to the softening process) exceeds the level laid down in the Water Supply (Water Quality) Regulations 2000. Drinking softened water is not recommended for people on a low sodium diet or babies on formula feed.

## CENTRAL HEATING SYSTEMS

Central heating systems should always be treated with a suitable corrosion inhibitor regardless of being filled with softened or hard water.

## RECOMMENDATION FOR SITING THE WATER SOFTENER

- Install close to the rising main
- Keep drain point as short as possible
- Keep overflow to outside wall as short as possible with a constant fall
- Allow for any required hard water draw off points
- Place on a sound base
- Allow space above the valve cover lid for servicing (recommended 75mm)
- Protect the softener and all associated pipework against freezing, as this could cause flooding
- Protect against condensation in enclosed areas

## LEAD PIPEWORK

Where lead pipework exists downstream of the proposed location of the water softener, we advise you to ask the local water authority for advice on the replacement of lead pipework. Water softeners should not be used with lead pipework.

**Please Remember** – Only use tablet or pellet salt in your softener!

# Installation of your water softener

## DRAIN HOSE

- With pressure of 3 bar, the maximum drain run is 3m with a constant fall before entering an air gap
- The maximum height above the softener should be not more than 2m
- The drain hose must enter the regulation air gap to prevent back fill.
- It is not recommended to discharge the waste into a pumped drain.

## OVERFLOW

The overflow needs to pass through an outside wall so that it can be seen. In accommodation without a suitable outside wall, it may be appropriate to use a suitable tundish with the existing overflow provision.

## INLET/OUTLET HOSES

Refer to the Water Softener Kit Installation Guide (single sheet) included with the installation kit.

The hoses are 500mm length with 22mm push fit connections.

You may need reducers or spigot elbows to fix to your existing plumbing.

## FITTING THE SOFTENER

The following instructions are recommendations. You may need to adapt the order for particular siting and plumbing systems.

## DO NOT INVERT THE INTEGRATED BYPASS

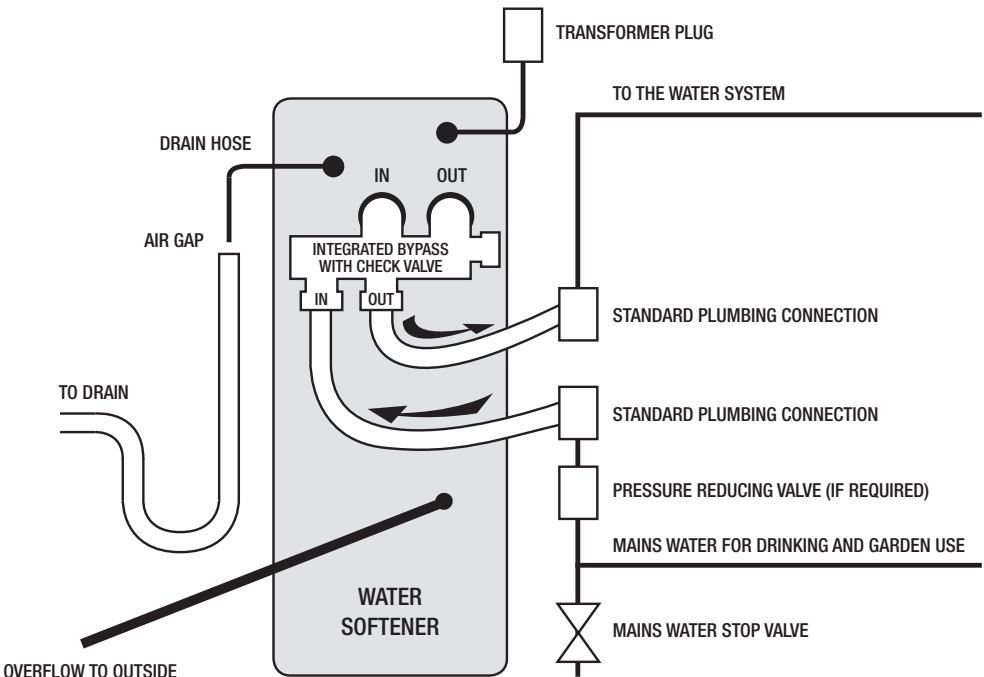

**Please Remember** – Only use tablet or pellet salt in your softener!

## WATER SOFTENER PLUMBING CONNECTIONS



**Please Remember** – Only use tablet or pellet salt in your softener!

# Connecting the water softener to the home's plumbing

**MAKE SURE THE INLET AND OUTLET HOSES ARE CONNECTED CORRECTLY TO THE PLUMBING AND TO THE INLET OUTLET POINTS OF THE BY-PASS.**

**FAILURE TO FIT THE HOSES CORRECTLY CAN DAMAGE THE WATER SOFTENER.**

**Note:** If you need to remove the valve cover for ease of installation, remove salt lid, then simply release the two catches behind the valve cover and tilt top end towards you slowly, taking care not to pull off the wire connections. **Please note** that the valve cover is connected to the valve motor, so cannot be removed fully.

## PLUMBING

Turn off the water supply at the incoming mains.

Note: The non-return-valve is already fitted in the integrated by-pass.

## FITTING THE HOSES TO THE BYPASS AND PLUMBING

The hoses come with a standard push-fit. Unlock the screws on by-pass and fully push the hoses into the inlet and outlet points of the bypass. To secure twist nut until gap is closed to secure hose in position.



You may want to connect hoses to plumbing first before securing hoses in position.

## FITTING THE BYPASS TO THE WATER SOFTENER

Fit the bypass into the water softener's inlet and outlet points. **ONLY FIT WITH HOSE INLET/ OUTLET FACING DOWN.**

Secure the bypass with the two large adaptor clips, from the top down. Be sure they snap firmly into place so that the bypass will not pull out. Pull on the bypass to ensure a tight fit has been achieved.

**It is important to fit correctly otherwise the water softener can be damaged.**

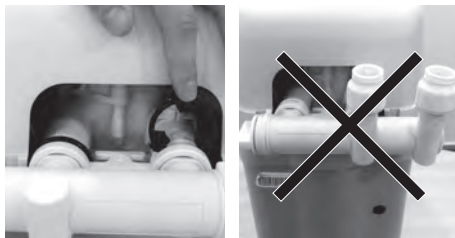

## CONNECT HOSES TO THE PLUMBING

Connect hoses to the plumbing using standard plumbing connections.

On the by-pass, if not already done, secure hoses by twisting nut until gap has closed.

Make sure the by-pass is open to allow water into the house while finishing installation. ('Hard' is the top position on the by-pass - see page 8)

Turn on mains water.

**Please Remember** – Only use tablet or pellet salt in your softener!

# All-In-One By-Pass

---

**Turn the handle to open or close the by-pass  
The handle turns 180°**



**FOR SOFT WATER (IN SERVICE)**

The water will pass through the water softener, when SOFT is at the top.

**The upper surface of the handle will feel smooth.**



**FOR HARD WATER (IN BY-PASS)**

The water will by-pass the water softener, when HARD is at the top.

**The upper surface of the handle will feel rough.**

**Please Remember** – Only use tablet or pellet salt in your softener!

# Fitting drain and overflow hoses

---

## **DRAIN OUTLET/OVERFLOW CONNECTION**

**See page 5 on drain and overflow before fitting.**

**Cut tubing for drain and overflow to the required lengths.**

### **Fitting overflow hose**

Insert the rubber grommet into the overflow socket situated 2/3 of the way up the rear of the water softener cabinet, using the silicone grease provided. Insert the overflow elbow. Fit hose onto the overflow elbow and secure with metal clamp. Pass the overflow through an outside wall so that the end can be seen.

### **Fitting drain hose**

Turn the drain line adaptor so that a straight connection can be made. Secure with supplied metal clamp. The drain hose may be connected directly into an open drain or via the waste outlet similar to a washing machine. When connecting to a drain the regulation air gap is required to prevent backflow. Make sure the hose is not kinked as this will stop the operation of the softener.



# Connecting to electricis

## ELECTRICAL INSTALLATION

The water softener works on a 24 volt, 50Hz electric power supply. You must use the transformer supplied into a 240 volt outlet only. Be sure that the electrical outlet you plug the transformer into is inside, as the transformer is not designed for outdoor use.

To connect the transformer to the controller board, push the female end plugs on to the male connectors as indicated below.

Should the faceplate fail to display or indicate an error code, please check that the connections are as per the diagram below, you will need to remove the valve cover to do this.

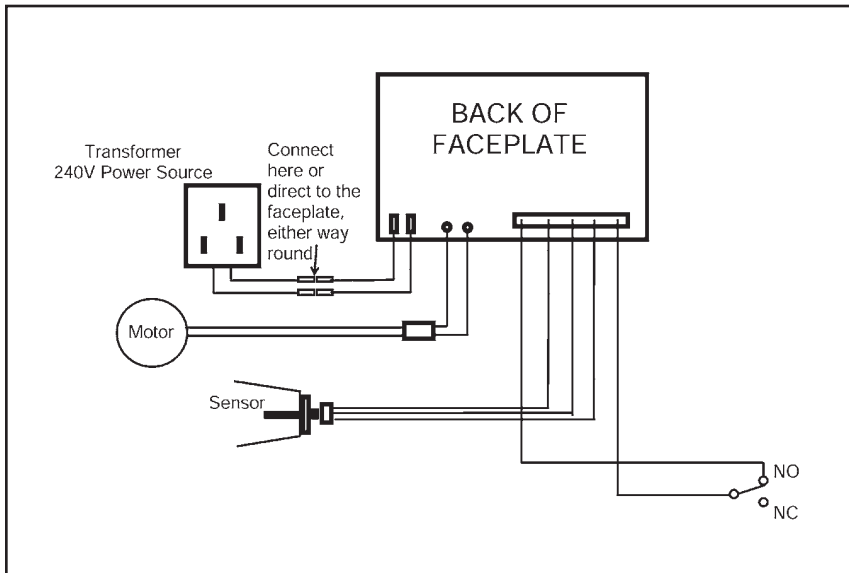

**Please Remember** – Only use tablet or pellet salt in your softener!

# Programming Faceplate



You will need to programme the faceplate with the time and hardness of the water.

When the transformer is first plugged in, the display will flash 12.00am.

**Note:** Each time you press a button on the fascia panel display, a beeper sounds. One beep signals that a change is accepted. If the beeper sounds continually then a different button is required to affect the operation.

## SET THE PRESENT TIME

The display will continue to flash and the time can be advanced or moved backwards using the ▲ or ▼ buttons.



Holding down the buttons advances the time at a faster rate.

If the time requires resetting during normal operation, press the **SELECT** button once. The display will flash and indicate present time. You may use the ▲ or ▼ buttons as described above to alter the time. Once the required time is displayed the time may be set by pushing the **SELECT** button once more.

## SET THE WATER HARDNESS

The display will flash '25 hardness' (this is a pre-set factory setting). Hardness varies from one location to another. Use the kit provided to determine your water hardness in ppm. If necessary change to the unit setting indicated in the table below.

## USING THE HARD WATER TEST KIT

Fill the vial with 10ml of water. Add a drop at a time of the blue solution and mix each time. It will react with hard water and turn pink. Count each drop until the water turns blue. Multiply the number of drops by 20 for the PPM. **Use the table to convert to unit setting.**

To increase or decrease the displayed number to your required setting use the ▲ or ▼ buttons.

Once the required setting is displayed it may be set by pushing the **SELECT** button once more.

WATER HARDNESS	
ppm	Unit Setting
(170)	10
(190)	11
(200)	12
(220)	13
(240)	14
(255)	15
(270)	16
(290)	17
(300)	18
(325)	19
(340)	20
(360)	21
(380)	22
(400)	23
(420)	24
(440)	25
(460)	30
(480)	30
(500)	35

**Please Remember** – Only use tablet or pellet salt in your softener!

# Programming Faceplate (cont)

---

## SET THE RECHARGE TIME

The display will flash 02.00 recharge time, which is the pre-set factory setting. If you wish to change this time then proceed as follows: (if not, press **SELECT**. Programming is complete).

**Note:** 2.00am is chosen because any household water used during recharge will be replaced with hard water. Consequently a time is required when very little, if any, water will be used. To select a different recharge time use the ▲ or ▼ buttons, to adjust one hour at a time. Once the required setting is displayed it may be set by pressing the **SELECT** button once more. Recharge will last for approximately 1 hour.



**Please Remember** – Only use tablet or pellet salt in your softener!

# Finishing installation

---

Your unit should now be fully plumbed and ready to use.

Having programmed your unit you will wish to ensure that the unit is functioning properly before you leave the site.

## NOTES TO THE INSTALLER – BEFORE YOU LEAVE

- 1 Close the all-in-one bypass so that SOFT is at the top.
- 2 Check that all the plumbing connections are secure and that there are no leaks
- 3 Check that the time of day is correct
- 4 **Fill with salt** - you will require a 25kg bag of tablet or pellet salt. **DO NOT USE GRANULAR SALT.** Make sure that the brine well cover is in place and secure as salt must not be allowed to enter the brine well. Do not fill salt above the brine well cover (See diagram page 3)
- 5 Initiate a recharge by holding down the **TOUCH/HOLD** button for about 3 seconds until **RECHARGE** flashes in the display. After a few minutes a small amount of water will enter the salt cabinet. This part of the recharge will take approximately 4-8 minutes

- 6 The complete recharge process will take about 1 hour. As the recharge finishes water will run to drain. Check your drain connections
  - 7 Softened water will gradually replace the hard water in the storage tank over a period of normally 7 days. However, this can take longer in larger houses.
- Please leave this handbook for the water softener owner
  - Please complete the enclosed Guarantee Registration Card
  - Remember reward points are available to plumbers who are members of the Team Tapworks Rewards Scheme.

## COMMON INSTALLATION FAULTS

- Crossed inlet-outlet hoses
- Kinked drain hose
- By-pass left in HARD position
- Failure to secure all in one by pass with adaptor clips

**IMPORTANT - TAPWORKS WATER SOFTENERS HAVE 12 MONTHS PARTS AND LABOUR WARRANTY. YOU CAN EXTEND THIS TO 2 YEARS BY RETURNING THE GUARANTEE REGISTRATION CARD.**

(Terms and conditions apply)

**Thank you for choosing Tapworks.**

**Please Remember** – Only use tablet or pellet salt in your softener!

# User information

---

Now your Tapworks water softener is plumbed in, it will be monitoring your water use.

Your water softener is programmed with the time and hardness of the water. This will allow the water softener to calculate when it needs to recharge.

Your unit features:

- An lcd display and user friendly buttons
- An extended power back up (48 hours). The memory retains all settings for extended periods during any power loss and beyond that only the time needs resetting.
- Recharge based on patterns established for volumes of water used, giving you the maximum conservation of water and salt usage.

**Note:** To alter settings during normal operation press **SELECT** until desired function is reached.

All you need to do is to keep the softener topped up with tablet salt in the salt cabinet.



**Please Remember** – Only use tablet or pellet salt in your softener!

# User information

---

## AFTER INSTALLATION

Now your Tapworks water softener is installed, you can start to enjoy the benefits of soft water. Your Tapworks water softener is automatic, there is nothing you need to do but keep it topped up with tablet/pellet salt. **DO NOT USE GRANULAR OR BLOCK SALT.** (See Salt below.)

Softened water will gradually replace the hard water in the storage tank over a period of normally 7 days. However, this can take longer in larger houses.

## TESTING YOUR WATER

You can test the water hardness from the softened supply using the test kit supplied. If within one or two drops the sample remains a blue colour this indicates soft water.

## WARRANTY CERTIFICATE

Please complete the customer warranty certificate or register on line for your 2 year parts and labour warranty. **[www.tapworks.co.uk](http://www.tapworks.co.uk)**

## HELP LINE

Call 01494 480 621 during normal working hours if you have any queries about your water softener.

## THE USE OF SOFTENED WATER

**Washing machines** – you will need much less soap powder. In most washes one tablespoon will be sufficient. Too much lather and clothes will not rinse properly.

**Dishwashers** – you will no longer need to fill your unit with salt, as this was used to soften the water in the dishwasher.

**Cleaning sinks, baths and basins** – you will find that your cleaning chores are reduced, and you will use less cleaning product, as cleaning becomes a quick wipe around. Occasionally 'spotting' may result but this is easily rinsed off and nothing to worry about.

**Hard water** – one household tap and any garden taps should be left on a hard water supply. Softened water contains a small amount of sodium. In four pints of softened water the sodium content is about the same as in  $\frac{1}{4}$  pint of milk. Drinking softened water is not recommended for people on low sodium diets or babies on formula feed.

**Steam irons/car batteries** – only use distilled or deionised water, not softened water.

**Copper staining** – this can be caused by new pipe-work and should disappear after a short time, simply wipe away any deposit. If this persists, poor earthing may be allowing electrolytic corrosion - contact an electrical engineer.

# User information (cont)

---

## HOW YOUR WATER SOFTENER WORKS

When you use water it passes through a vessel of resin beads inside your water softener. The resin beads extract the hard minerals making your water soft. This process is not visible and happens within the softener. The salt cabinet (page 3) is where you load the softener with tablet salt. You may see 1 or 2 inches of water at the bottom of the salt cabinet this is normal, otherwise when the cabinet is full of tablet salt it will appear dry. The water softener uses tablet salt for its cleaning process. The cleaning process flushes to drain the hard minerals that have collected inside the resin vessel and refreshes the resin beads so they are ready to make more soft water. This is automatic all you need to do is keep the softener topped up with tablet salt.

## TOPPING UP WITH TABLET SALT

Tablet salt is used as the cleansing agent for your water softener's resin bed. The salt cabinet will need to be refilled. Do not fill the salt above the brine well cover (see on page 14).

**IT IS ESSENTIAL THAT APPROXIMATELY 12CM OF SALT IS MAINTAINED AS A MINIMUM TO ENSURE OPERATING EFFICIENCY.**

Failure to replenish salt will prevent the unit from cleansing itself on its recharge cycle and consequently it will be unable to soften water.

Pour the salt slowly into the cabinet. Ensure that the brine well cap is secure, as no salt should be allowed to enter here. **DO NOT** use granular salt. **ONLY USE TABLET OR PELLET SALT.**

Your local water softener stockist will stock salt.

## SALT USAGE

Because your automatic demand water softener uses proportional brining, more frequent recharges are not at the expense of high salt usage. If you are a household with low water usage you will find after a few months that your water softener will become increasingly efficient, as it adapts to suit your water usage.

## HOLIDAYS

We recommend that you by-pass your water softener if you are away from your home for long periods of time. See page 8 on how to by-pass your water softener.

## CLEANING

Your unit may be cleaned with a damp cloth and detergent. Do not use bleaches, solvents or spirits as this may cause damage.

## BUILDING A HISTORY

Because it has no historical data to base its logic on, your water softener will recharge quite frequently when first used to ensure continuous softened water. Within a few months, it will settle into a more regular pattern.

## LARGE INFLUXES OF GUESTS

If you have people to stay and use more water than normal, you will find that your automatic demand water softener recharges more frequently. As your household water usage returns to normal, so too will the recharge frequency.

**Please Remember** – Only use tablet or pellet salt in your softener!

# User information (cont)

---

## POWER CUTS

If the electrical power to the water softener is interrupted, the time display will be blank, but the 'memory' built into the electronics will keep the correct time for up to 48 hours.

The water softener will not recharge but will pass softened water. In the case of a power cut, your demand for water will be less as most appliances will not work, so a recharge should not be necessary. When electrical power is returned, one of two things will happen:

1. Power off up to 48 hours

The display returns and is steady, no operation is necessary.

2. Power off over 48 hours

The display returns and flashes, only the time requires re-setting. The hardness and recharge time will not have been lost as they are stored. Even if the time is incorrect, the water softener will continue to work but will recharge at what it believes the time to be.

## RE-SETTING THE TIME

Re-set the time as described in the programming section (see page 11)

## SHOULD AN ERROR CODE APPEAR

Check electrical connections are as per configuration on page 10.



- Unplug transformer
- Check direct connections
- Replug transformer
- Wait for 6 minutes, if the error is rectified, the error code will not appear.

The softener may recharge immediately following a cleared error code.



# Manual recharge

---

The water softener will automatically recharge when it needs to. The factory setting for the recharge is 2am. There may be occasions when you need to do a manual recharge, for example more people staying in the home than usual.

**TO RECHARGE NOW** – simply press the **TOUCH/HOLD BUTTON** and hold it down for approximately 3 seconds, until a beep sounds. Recharge will flash on the display. The process will take a few minutes to begin and lasts approximately 1 hour. It cannot be cancelled once started.



**TO RECHARGE TONIGHT** – the unit can be programmed to recharge at the next pre-programmed time, regardless of its remaining capacity. Simply press the **TOUCH/HOLD** button once. Recharge tonight will flash on the display.

To cancel recharge tonight, press the **TOUCH/HOLD** button once and immediately release. The display will return to the time display.



NOTE: Use as little water as possible during a recharge as hard water will bypass the water softener. Once the recharge is complete the recharge display will disappear.

**Please Remember** – Only use tablet or pellet salt in your softener!

# Problem solving

If you are experiencing poor water flow, please check all plumbing first, as it is extremely rare for a softener to cause flow rate problems.

**Save money by ensuring an engineer is not called out unnecessarily. However, if the solution to the problem is not successful, please call for service and advise us what you have tried. Call our Direct Service Line on: 01628 914 333**

Checklist	Solution	Page No.
<b>PROBLEM: Hard Water or, Intermittently Hard Water</b>		
1. Is there a minimum of 12 cm of salt in the cabinet?	1. Fill the cabinet with salt.	14 & 16
2. Is the bypass open?	2. Close the bypass.	8
3. Is the hardness setting correct?	3. Reset the unit setting as per table open the inlet and outlet valves.	11
<b>Important Notes:</b> If any of the above requires action, add 4 litres of clean water to the salt and initiate a 'recharge now'.		
<b>PROBLEM: No Water</b>		
1. Is the water mains open?	1. Open water mains.	
<b>PROBLEM: Unit recharges at incorrect time of Day</b>		
1. Is the present time correct?	1. Reset the present time.	11
2. Is the recharge time correct?	2. Reset the recharge time.	12
3. Has there been a power cut?	3. See 1 and 2 above.	
<b>PROBLEM: No Recharge occurring or, little or no salt usage</b>		
1. Is the water soft?	1. If yes, no action is required.	15
2. Is the water level in the salt cabinet high?	2. If yes, check the drain line is not frozen or blocked. Initiate an immediate recharge.	18

**Please Remember** – Only use tablet or pellet salt in your softener!

# Problem solving (cont)

Checklist	Solution	Page No.
<b>PROBLEM: Excessive Salt Usage</b>		
1. Check the hardness.	1. Reduce the unit setting if incorrect.	11
<b>PROBLEM: No Water in Cabinet or Very Low</b>		
1. This is quite normal. Unlike conventional water softeners only a few inches of water is at the bottom of the cabinet.	1. No action necessary.	
<b>PROBLEM: High Water Level in Cabinet</b>		
1. Is the water level in the salt cabinet high?	1. Initiate an immediate recharge. If the problem does not return, there is nothing wrong.	18
<b>PROBLEM: Water Running Down the Overflow</b>		
1. Is the unit in recharge mode?	1. If yes, no action is required.	
<b>PROBLEM: Water Running Down the Drain Line Constantly</b>		
1. Is the unit in recharge mode?	1. If yes, wait until it finishes, check the present time and recharge time settings and adjust if incorrect.	11
2. Does an error code appear, eg 'ERR 01'?	2. Check all electrical connections are secure. Turn the power off for ten seconds, and then switch back on.	10
<b>PROBLEM: Electronic Faceplate</b>		
1. Is the Faceplate blank?	1. Check the power is turned on and all connections are secure.	10
2. Is the display stuck on one function?	2. Turn the power off for ten seconds and then switch back on.	
3. Does an error code appear, eg 'ERR 03'?	3. Check all connections are secure. Turn the power off for ten seconds, and then switch back on.	10

**Please Remember** – Only use tablet or pellet salt in your softener!

# Warranty Terms and Conditions

## General Information

---

All Tapworks Domestic Water Softeners are fully covered by one year parts and labour warranty against manufacturing defects from the date of installation. \*Proof of purchase may be required. No maintenance visit will be provided during this period unless it is the result of an operation fault.

### **This warranty does not affect the statutory rights of the consumer.**

We undertake that within 12 months of the date of installation\* of the Tapworks Domestic water softener if it is proved to be defective by reason only of faulty materials or manufacturing defects, we will at our discretion repair or replace the same free of any charge for labour, materials or carriage on condition that:

- The unit is properly sized, and purchased through an authorised Tapworks agent.
- The unit has been correctly installed in accordance with the manufacturer's installation instructions and operating specification including water pressure and water flow.
- The unit has been used for normal domestic purposes only using municipal water.
- The unit has been maintained in accordance with instructions.
- The unit has not been serviced, maintained, repaired, taken apart or tampered with by any person not authorised by us.
- All service work under this guarantee must be undertaken by an authorised service centre.
- Any unit or defective part replaced shall become the Company's property.

### **DATA PROTECTION INFORMATION**

We want to ensure that we keep the details we hold about you up to date and communicate with you fully in accordance with your wishes. Your data will be used for customer service and to make our services available to you. This information will only be used within this company or passed to an authorised service agent. Our communication and marketing activities are by post, e-mail, telephone, or text message, unless you indicate otherwise. If at any time your details change or you wish to add to or remove from the list of communications sent to you then please contact us.

### **The guarantee does not cover:**

- Damage resulting from transportation, improper use or neglect, including not being filled with tablet salt, using the incorrect salt.
- Any defect or damage occasioned by fire, lightning, power surge, explosion, flood, storm, tempest, impact or other extraneous causes.
- Units not installed in accordance with local regulations.
- Units installed in such a way that access for service is restricted.
- Resetting the programmer in the event of: power failure or incorrect programming, or when the influent water hardness or number of people in the household changes.
- Units which are improperly installed, faulty plumbing or faulty electrics.
- Units installed outside UK mainland.
- Units installed in commercial premises.

### **Any faults which are not attributable to the water softener but to faulty installation or operation will be chargeable.**

\*The guarantee period will commence from date of installation, unless the installation is made more than six months from the date on which the product was purchased, in which case the guarantee period will commence six months from the date of purchase.

The guarantee provided is applicable to the country in which the product was purchased. If the product is taken abroad the guarantee may be invalidated.

**Please Remember** – Only use tablet or pellet salt in your softener!

Tapworks Water Softeners  
Solar House  
Mercury Park  
Wooburn Green  
HP10 0HH  
01494 480 621  
info@tapworks.co.uk  
www.tapworks.co.uk

Tapworks Water Systems, a trading division of The Marmon Group Limited.

# DON'T MISS OUT

**TO RECEIVE YOUR 2 YEAR FREE WARRANTY\*  
YOU MUST REGISTER WITHIN 3 MONTHS OF INSTALLATION\*\***

Registering your warranty means we will have all the information we need to help you quickly, if you ever need us.

**RETURN YOUR REGISTRATION CARD TO:**

**Tapworks Water Softeners, Solar House, Mercury Park,  
Wooburn Green, Buckinghamshire, HP10 0HH**

*(stamp required)*

**OR**

**You can register on-line:**

**[www.tapworks.co.uk/warranty-registration](http://www.tapworks.co.uk/warranty-registration)**

**\*This is in addition to your statutory rights**

\*\*The guarantee period will commence from date of installation, unless the installation is made more than six months from the date on which the product was purchased, in which case the guarantee period will commence six months from the date of purchase.

# WARRANTY REGISTRATION FORM

(or complete on-line at [www.tapworks.co.uk/warranty-registration](http://www.tapworks.co.uk/warranty-registration))

## **TO RECEIVE YOUR FREE 2 YEAR WARRANTY**

**YOU MUST REGISTER WITHIN 3 MONTHS OF INSTALLATION**

Terms and conditions apply

### Installation details

Date of installation:	
Customer's name:	
Address:	
City/Town:	Post Code:
Tel:	
Mobile:	
Email:	
Tapworks model*	
Serial no:*	

*\*This information can be found under your water softener salt lid.*

Tapworks will use this information for customer services and administration. We may keep this information for a reasonable time for these purposes. We may contact you by mail, telephone, email or other electronic messaging services with offers of our services or information that may be of interest to you. By providing your telephone number or email address you consent to being contacted by these methods.

Please tick this box if you do not wish to receive information by these methods.

### Installer's details

Trading name:
Team Tapworks No: (if known)
Address:
City/Town:
Post Code:
Tel:
Email:
Unit purchased from:

Terms and conditions apply

#### **RETURN TO:**

**Tapworks Water Softeners, Solar House, Mercury Park,  
Wooburn Green, Buckinghamshire, HP10 0HH**

*(stamp required)*