

User and Service Manual

Model 173



TABLE OF CONTENTS

I	INTRODUCTION.....	4
II	INSTALLATION.....	5
2.1	COMPONENTS OF THE MACHINE	5
2.2	UNLOADING THE VENDING MACHINE.....	6
2.3	ASSEMBLE THE UNITS.....	6
III	SETTING FOR SALES	10
3.1	LOAD SNACK PRODUCTS	10
3.2	LOAD FOOD PRODUCTS.....	11
3.3	LOAD DRINK PRODUCTS.....	11
3.4	OPTIONAL ENERGY DRINK SHIM FOR D0, D5	13
3.5	DISPLAYING DRINKS BEHIND WINDOW	15
3.6	LOADING COINS INTO COIN CHANGER.....	15
3.7	SETTING PRICES.....	15
IV	SERVICE MODE.....	17
V	SERVICE AND MAINTENANCE	19
5.1	ELECTRONIC MONEY CONTROL	19
5.2	COIN CHANGER	20
5.3	BILL VALIDATOR.....	20
5.4	VENDING MOTOR	20
5.5	REFRIGERATION UNIT	21
5.6	ELECTRICAL SCHEMATIC.....	23
5.7	COMMON QUESTIONS AND TROUBLE SHOOTING	25

Copyright 2009,

Please record the Model Number and Serial Number of your vending machine below. They are necessary to obtain quick service and parts information for your machine.

Model No: _____

Serial No: _____

I INTRODUCTION

Congratulations on the purchase of your new vending machine(s). In this manual you will find simple yet useful information on how to install and maintain your vending machine.

Specifications:	Snack	Drink	Food
Model No.	17367	17378	17389
Weight:	145 lbs	350 lbs	100 lbs
Size:	32"W x 25"H x 27"D	D32"W x 41H x 28"D	D32"W x 71"H x28"D
Capacity:	72 snacks	154 drinks	77 entrees
Selections:	8 chips, 8 candies	2 bottles, 6 cans	14
Refrigeration:	R134A CFC-Free		
Operating Temperature:	32F to 90F Indoor only		
Power:	120 VAC 60 Hz		

**For service or questions contact:
Genesis Manufacturing Inc.
7E Terminal Road
West Hempstead, NY 11552
Tel: 516-483-2222
Fax.: 516-483-2168
Email: services@genesismanufacturing.com**

The whole package includes:

1. Vending machine in 3 cartons
2. This manual
3. Two keys for each machine. One key is located in the vend chute door of each machine. The other key is bundled together and located at snack machine's coin return area. Please note once we ship out the vending machine(s) we do not have copies of keys. It is strongly recommended to make copies of your keys just in case it is lost.
4. A set of price decals to insert for display, screws, 4 spacers, one back cover, connect bars and 2 set of shims.

II INSTALLATION

2.1 Components of the machine

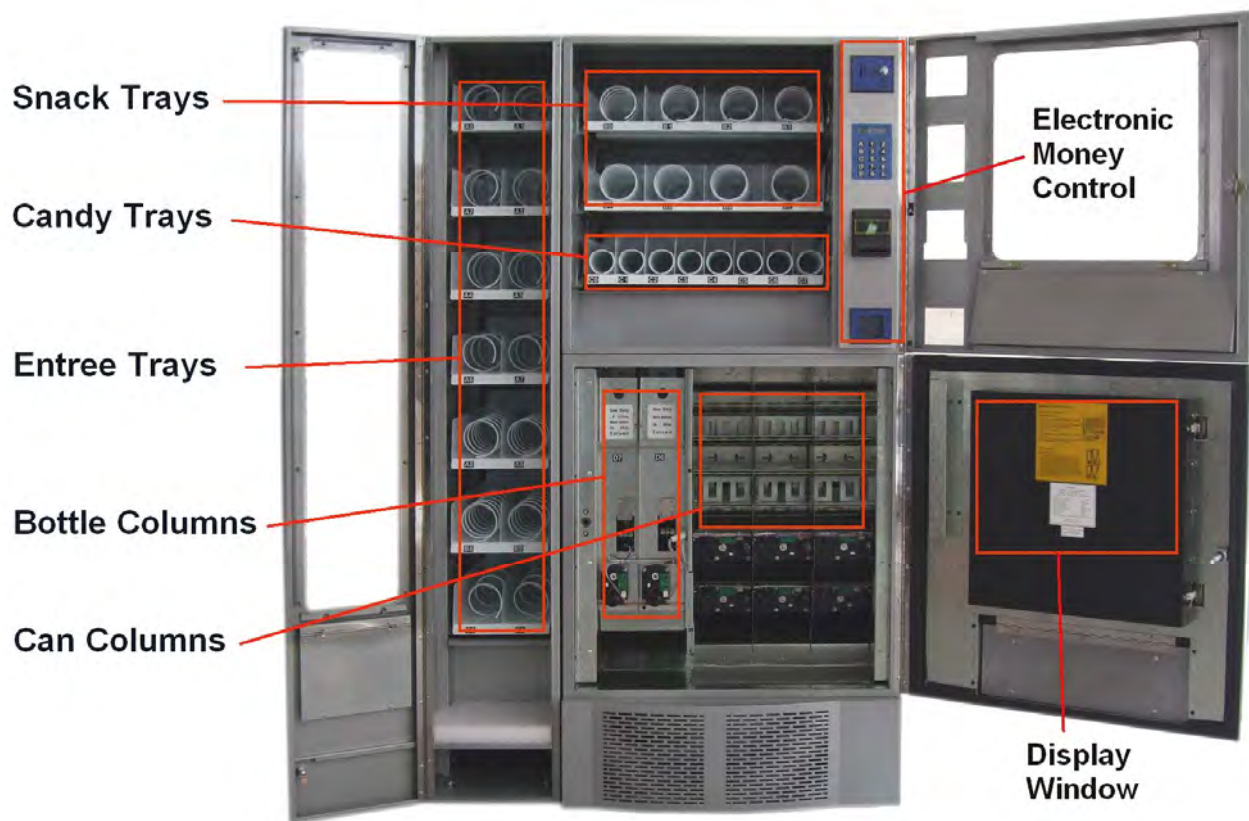

2.2 Unloading the vending machine

Warning:

You must have two persons to perform the unloading.

This machine must be transported at an upward position. Not doing so will damage the refrigeration unit and VOID WARRANTY. If you need to transport the machine lying down, please remove refrigeration unit temporarily, refer to chapter 5 for instructions.

- Remove the machines from the wooden skid; you need two persons to perform the unloading.
- Remove the cardboard box around the vending machines. Do not use a razor.

2.3 Assemble the units

- Put the snack unit on top of drink unit.
- Open the snack unit's door by inserting the key (marked door key) and turn clockwise, the handle will pop out. Turn the handle counter clockwise until door opens.
- Insert two screws (large) into the two pre- threaded holes and tighten.

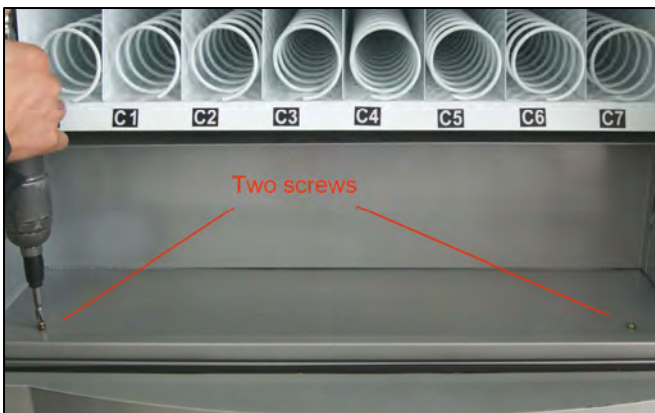

- Put the food unit on the left side of the snack / drink unit.
- Open the food unit's door by opening the top and bottom locks.
- Insert two screws (large) into the two pre- threaded holes and tighten.

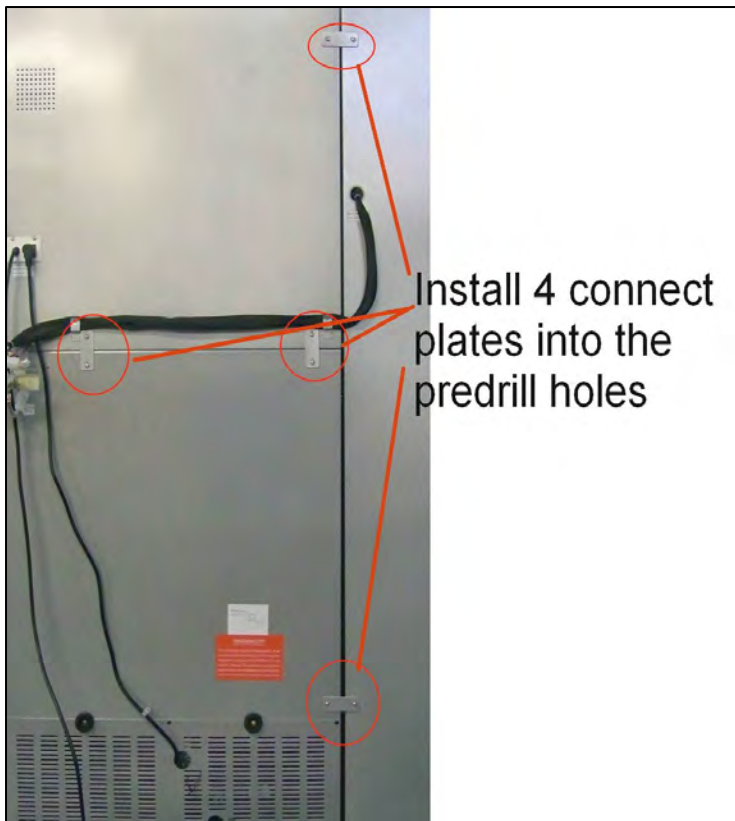

- Install the connect plates on the predrill holes on the back of machine. Two from snack to drink. One from snack to food and one from drink to food.

- Remove the shipping covers on the back on drink and snack machine. Discard the covers.
- Connect the five connectors at the back. The connectors from the back of snack machine come in two bundles. The first bundle has three connectors which are used to connect to the deli machine. The second bundle has two connectors which are for the drink machine.

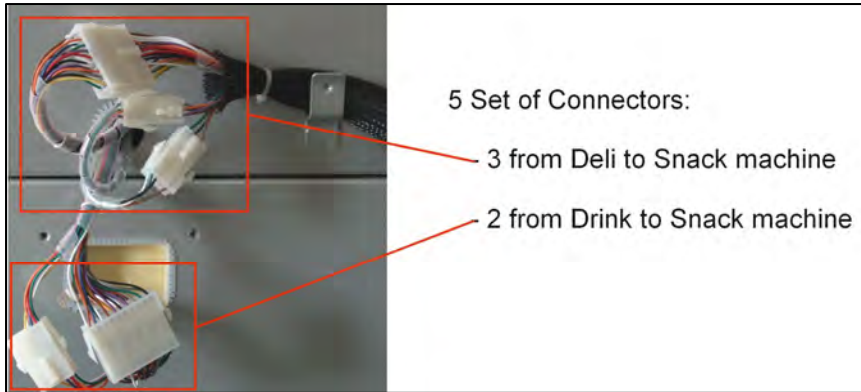

- Secure the protect cover over the cables with two screws.

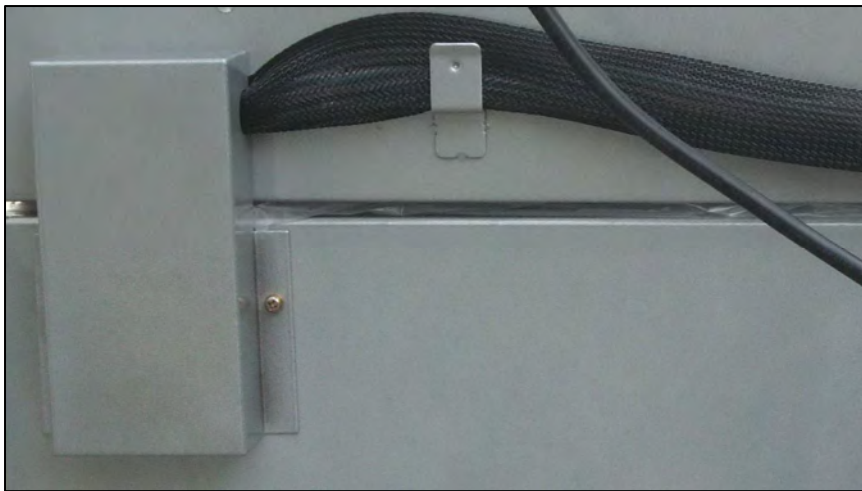

2.4 Leveling, Power and Location

- ◆ Make sure the bottom of the machine is leveled. If not, the machine will not function properly.
- ◆ You can level the machine by adjusting the front four feet of the Drink and Food machine.

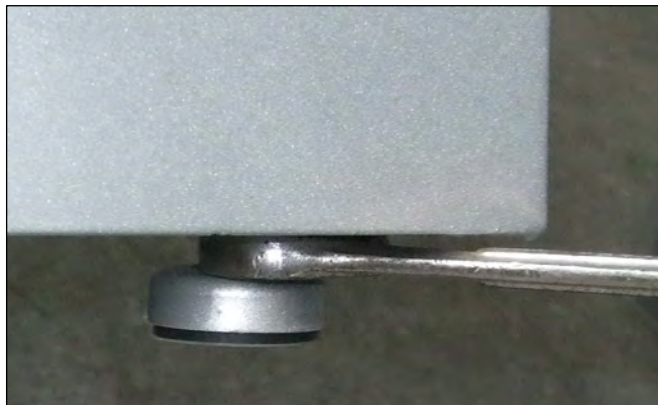

Caution:

If the machine is tilted more than 45 degrees during installation, you must let it rest for 12 hours before plugging in the power. Not doing so could damage the refrigerator unit and void warranty.

- ◆ Plug the drink machine power cord in the snack unit's outlet. DO NOT PLUG the drink machine's cord into any wall outlet.

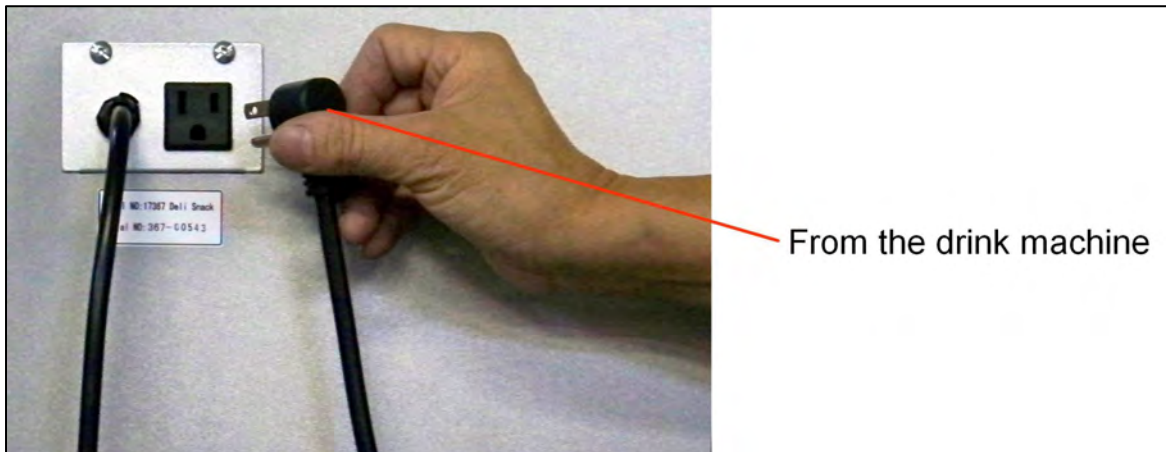

- ◆ Plug the snack machine's power cord into a 120 VAC outlet.
- ◆ It is recommended NOT to use an extension cord. If it must be used, the extension cord must be a 16 gauge three wire type.
- ◆ Depending on your local climate; it will take about 24 hours for the machine to reach operating temperature of 38°-45° F.
- ◆ Please note this machine is intended for indoor use only.
- ◆ Choose an area where it is close to an electrical outlet.
- ◆ The machine will power on and the refrigeration system will start running. It is ready to be set up for sales.

III SETTING FOR SALES

In order to get the machine ready for sales, you need to do the following:

- 1) Load products.
- 2) Display drinks in product window.
- 3) Set prices and add price decals.

3.1 Load Snack Products

- ◆ Rows B0-B3, B4-B7 can hold 8 snacks in each row. (8 snacks x 8 rows=64 snacks)
- ◆ Rows C0-C3 can hold 11 candies, C4-C7 hold 14 candies. (11x4 + 14x4 = 108 candies)
- ◆ Pull the product tray out (one at a time), by holding the lever down. The tray automatically tilts downward for easy operation.
- ◆ Load products in between the coil with products sitting on the tray. Always load products between the coils, NOT on the coil.
- ◆ After products are loaded, tilt the shelf upwards and push it back to its original position.

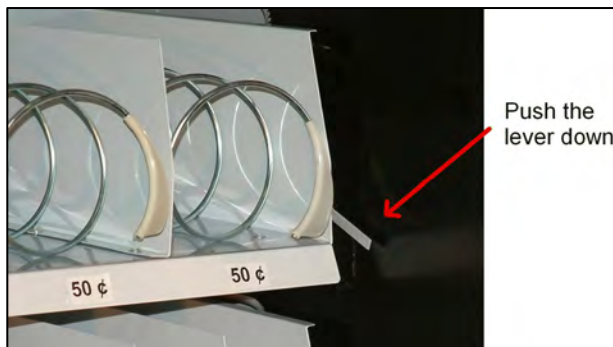

3.2 Load Food Products

- ◆ There are 14 selections, A0-A9, B8-B9, C8-C9, collectively they hold 77 food items.
- ◆ Pull the product tray out (one at a time), by holding the lever down. The tray automatically tilts downward for easy operation.
- ◆ Different products have different sizes and shapes. The appropriate loading procedure is obviously dependent on the type of product you will be vending. The figure on the left represents the number of spaces of each coil. Use it to plan your product mix.

Note: To present your product in as attractive and professional manner as possible, do not load damaged items, and make sure that the items are facing forward for easy identification by your customer. The size of the item being vended must be larger than the Helix Coil, but smaller than the column, to vend correctly. Never force an oversized item into the helix Coil or Column, nor attempt to vend an item that is smaller than the Helix Coil as this will create problems and deter customers.

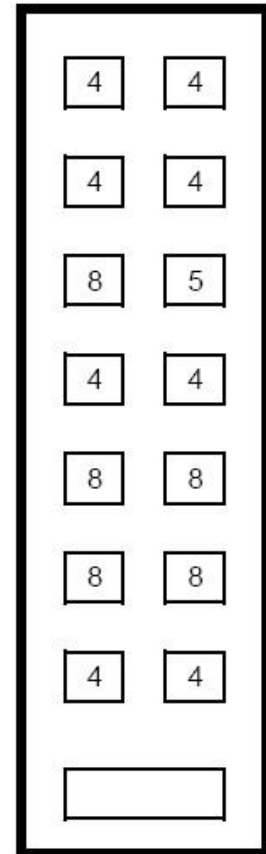

3.3 Load Drink Products

Open the drink unit's door by inserting the key and turn counter clockwise until door opens. There are 6 cans columns and 2 bottle columns. D0-D2 each holds 25 cans; D3-D5 holds 19 cans. D6 and D7 each hold 11 bottles. When the product is sold out, there will be 2 cans left at the can slot, 1 or 2 bottles left on the bottles slot (depends on the initial load position).

Serpentine Vend (Can) System

Selections D0, D1, and D2,

1. There are two chutes for these selections, chute #1 and #2.
2. Load the top chute #1 (green line) until completely full.
3. Then load the bottom chute #2 (red line).

Selections D3, D4, and D5

4. There are two chutes for these selections, chute #3 and #4.
5. Load the top chute #3 (green line) until completely full.
6. Then load the bottom chute #4 (red line).

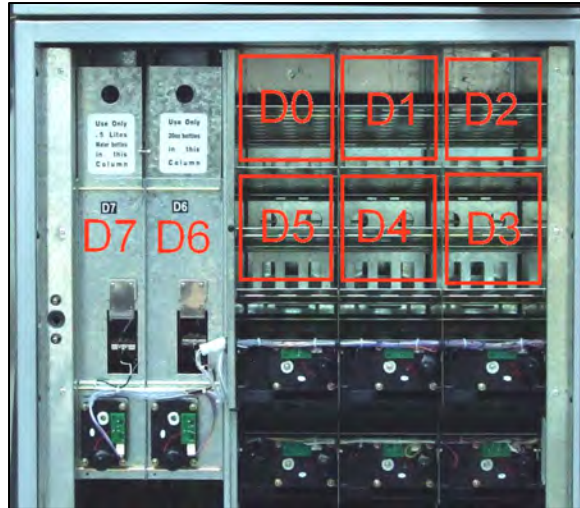
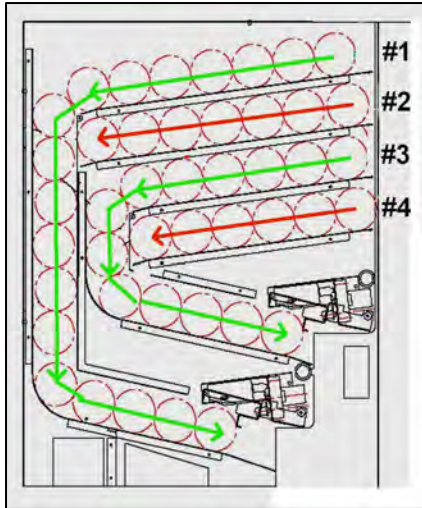

Vertical Vend System

Selections D6 and D7

1. To load bottled drinks, keep in mind there are two sections. You must load the back section first by pulling the metal shield down. After, close the metal shield and load the bottled drinks on the front section. We recommend you alternate the direction of the bottles, bottle cap facing in and bottle cap facing out.
2. The column can also be used to vend 8.5 oz energy cans, to do that; a spacer must be used to ensure the fit of the 8.5 oz. cans in the column.

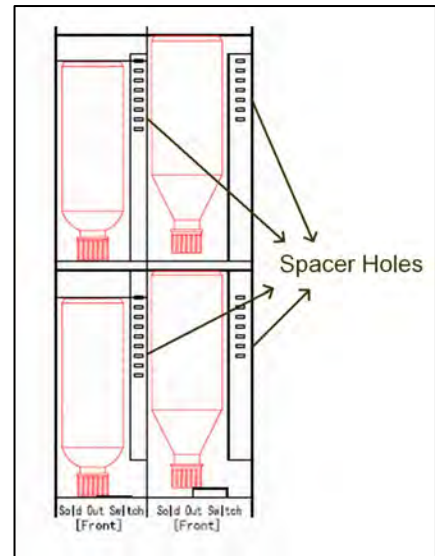

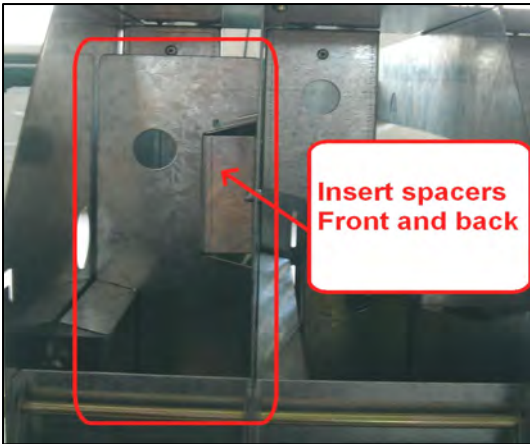

3.4 Optional energy drink shim for D0, D5

D0, D5 are equipped with two sets of shims so one can vend 8.4 oz energy cans (such as Red Bull). Follow below instructions to install shim onto the Teeter Totter:

1. Remove the two thumb screws on both end of the Teeter Totter.
2. Slide out the Teeter Totter to have more access.
3. Unplug the connector off the motor.
4. Turn the teeter totter to its side.
5. Align the "L" shaped bracket to the "flat" bracket and secure with screws and hex nuts.
6. Place the "right angle" bracket underneath towards backside and secure with screws from the top.
7. Make sure it matches our final installation.
8. When loading 8.5 oz can, load cans only into chute #1 and #3. DO NOT LOAD chute #2 and #4 chute, leave it empty, otherwise it could cause a jam in dispensing.

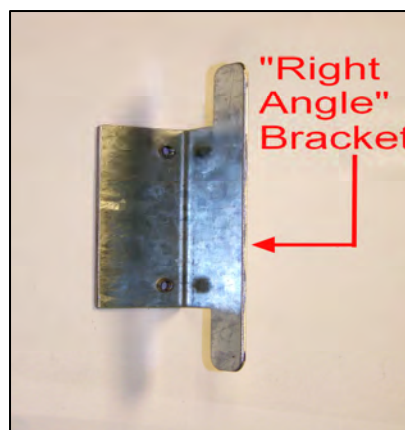
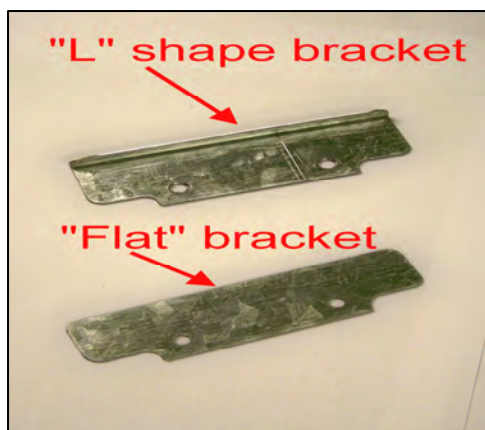

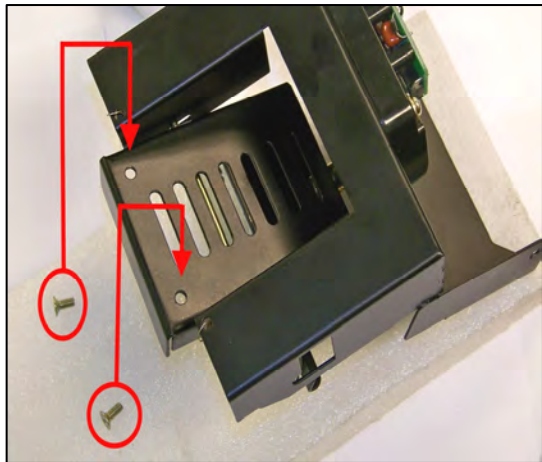
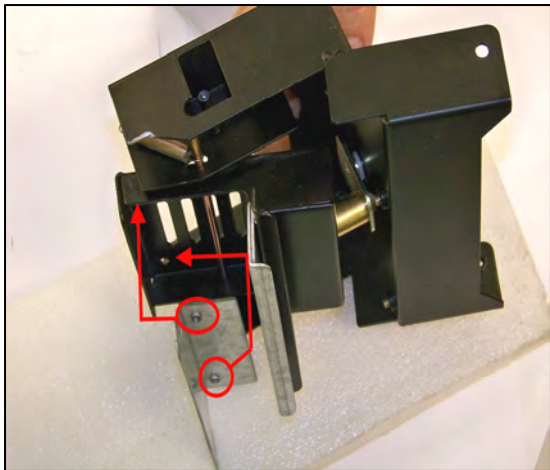
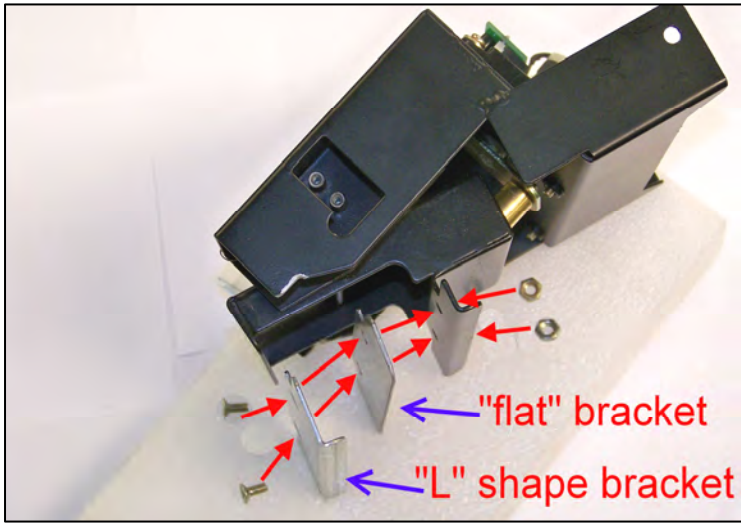
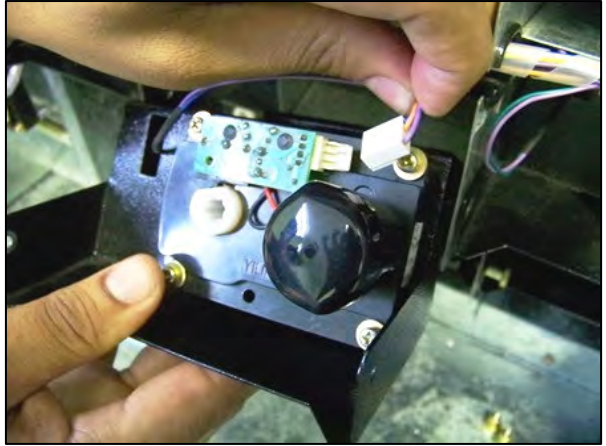
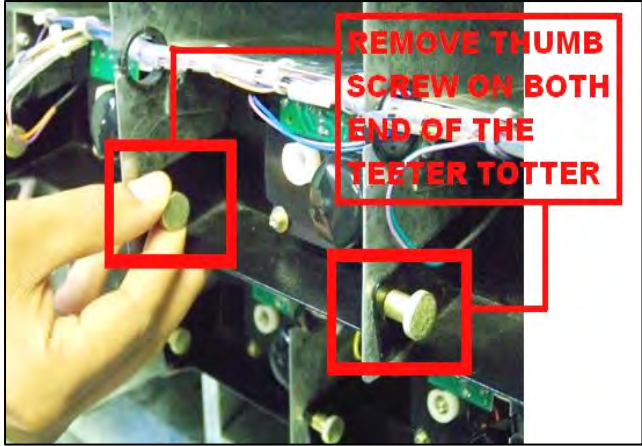

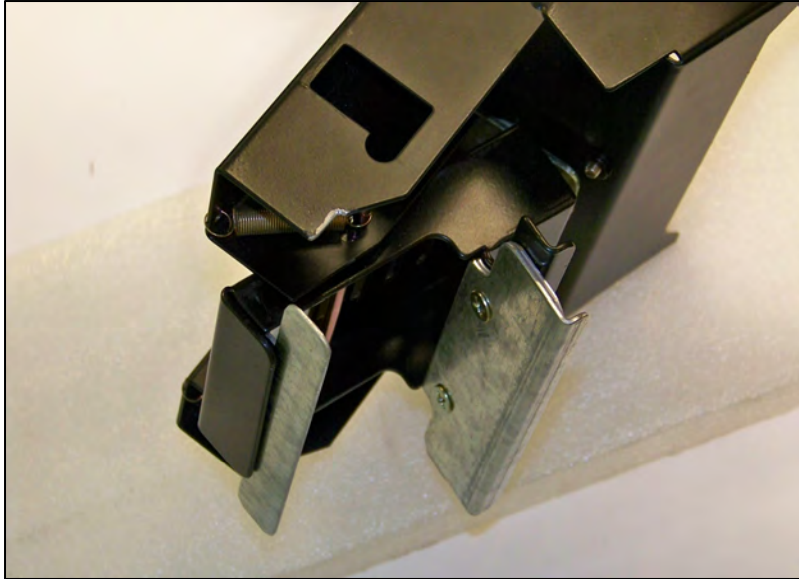

3.5 Displaying drinks behind window

- ◆ Open the top and bottom lock clips of the display window.
- ◆ Place price decals and drinks as corresponding to D0, D1...D5.
- ◆ Close the display window and lock.

3.6 Loading coins into coin changer

Before setting prices you must load coins into the money changer first. It is recommended to fill up the coins at least half full in order for the machine to have sufficient coins to work effectively. To load coins, please refer to the coin changer manual.

3.7 Setting Prices

The last step is to set each item on the Money Control Unit. (Please also review Chapter IV for full function of service mode)

- a) Push the service mode button for 5 seconds.
- b) You should be able to see *Service Mode V x.x* on the LCD panel.
- c) Scroll down to *Price Setting* function. Use the arrow keys (keys “9” and “0”) as indicated.

- d) You are now able to set your prices for each product starting with A0 all the way to D7.
- e) Please note the prices increase and decrease from increments of 5 cents. For example, if you want to set the price for A3, you can simply press A3 on the keypad and press the arrow facing up to increase the price or press the arrow facing down to decrease the price. Once you've changed the price you can move on to the next item by pressing the desired item number.
- f) If all the items have been set up, all you need to do is press the red service mode button once and you're done.

Note: It is highly recommended to test every item (at least 2 times each) to make sure the products are vending properly as well as the prices are set as desired.

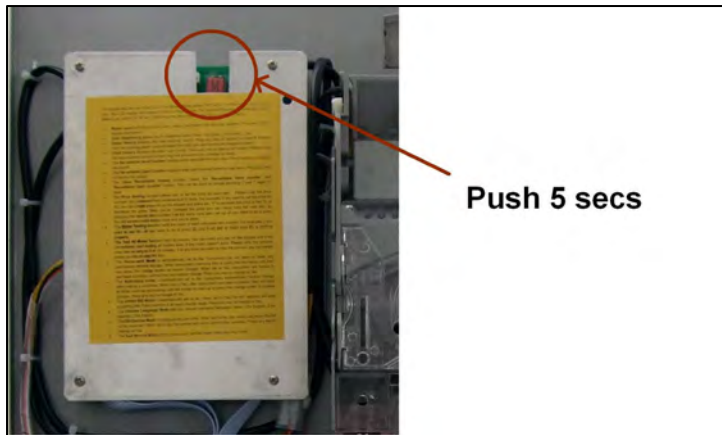

IV SERVICE MODE

In this section you will find the functions of each service mode. There are three main uses for the service modes. The first one is the ability to test each individual function. The second usage is the ability to set options such as prices. The third function of the service mode provides sales history and cash history.

To activate the service mode, push the service mode button on the control board for 5 seconds. The LCD display will change *Service Mode Vx.x.* . (Note: The service mode will automatically exit if there is no activity for 60 sec.) Use the arrow keys (key "9" and "0") to scroll the menu.

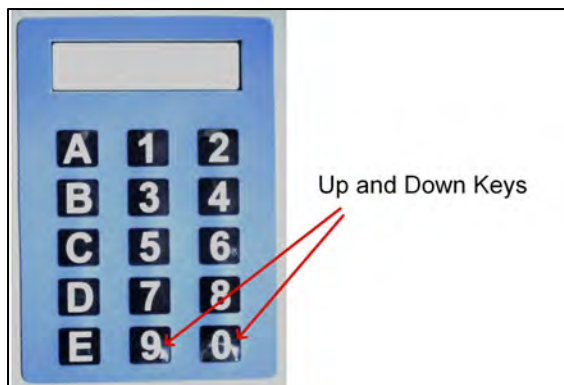

- ◆ Motor count will tally up how many motors you have in the vending machine. Press any key to display the record.
- ◆ Coin Dispensing allows you to dispense coins. Press 1 for tube 1, 2 for tube 2...etc.
- ◆ Sales History displays the total vending counts. Press any key to display the record. Please note the vending count is accumulated from day one and cannot be changed or reset.
- ◆ Cash History displays the total cash counts. Press any key to display the record. Please note the accumulated amount is from day one and cannot be changed or reset.
- ◆ The Re-settable Vend Counter displays total vend after the last clear. Press any key to display the record.
- ◆ The Re-settable Cash Counter displays total cash received after the last clear. Press any Key to display the record.
- ◆ The Clear Re-settable History function clears the "Re-settable Vend counter" and "Re-settable Cash Counter" history. This can be done by simply pressing C and C again to clear.

- ◆ The Price Setting function allows you to set the price for each item. Please note the price increase and decrease from increments of 5 cents. For example, if you want to set the price for A3, you can simply press A3 on the keypad and press key “9” to increase the price or key “0” to decrease the price. Once you’ve changed the price you can move onto the next item by pressing the desired item number if all the items have been set up, all you need to do is press the red service mode button once and you’re done.
- ◆ The Motor Testing function tests the motor of each individual item number. For example, if you want to test B5, all you have to do is press B5 and it will test to make sure B5 is working properly.
- ◆ The Test All Motor function tests all motors. You can press any key on the keypad and it will immediately start testing all motors even if the motor doesn’t exist. Please note this process may take as long as 5 to 10 minutes. If at any time you want to stop the process you can simply press any key to stop the test. The Test All Motor function should Not be used when products are loaded and the doors are closed. All Selections will vend in sequence and serious product jams will occur.
- ◆ The Force-vend Mode is automatically set to No. Consumers do not need to make any purchase to receive change. When consumers insert any bills or coins into the money unit they can press the change button to receive change. When set to Yes, consumers are forced to purchase a product before they can receive change. Press any key to change to Yes.
- ◆ The Multi-Vend mode is automatically set to No. When consumers purchase a product they will have to either continue purchasing until the money is used up or press the return change button to receive change. When set to No, consumers automatically receive change after making a purchase. Press any key to change to No.
- ◆ The Inhibit Bill Mode is automatically set to No. When set to Yes, the bill validator will stop accepting bills if the machine is at exact change stage. Press any key to change to Yes.
- ◆ The Choose Language Mode lets you choose operation language, press 1 for English, 2 for Spanish, 3 for French.
- ◆ The Bill Escrow Mode is automatically set to No. When set to Yes, the vendor will return the bill to the customer. When set to No, the vendor will return coins to the customer. Press any key to change to Yes.
- ◆ The ManuallyAddCoins Mode is automatically set to Off. When set to On, one can add coins through the coin insert without credit being display on LCD. This is useful for the coin changer to know exactly how many coins are added in the tubes.
- ◆ The Exit Service Mode simply means exit service mode press any key to exit.

V SERVICE and MAINTENANCE

5.1 Electronic Money Control

The Electronic Money Control (EMC) controls the machine. It receives money through the bill or coin changer, accepts inputs from the keypad, instructs the machine to vend products and give changes through coin changer. There's also an AC to DC power supply located inside the compartment. All EMC components sit on a tray and can be serviced when it slides out. It consists of the following components.

LCD display:	Display Information
Keypad:	Accept selection
Bill Validator:	Accept bills
Coin Changer:	Validate, store and give coins
Control Board:	The computer that control the machine
Connector Board:	Wiring board to various motors

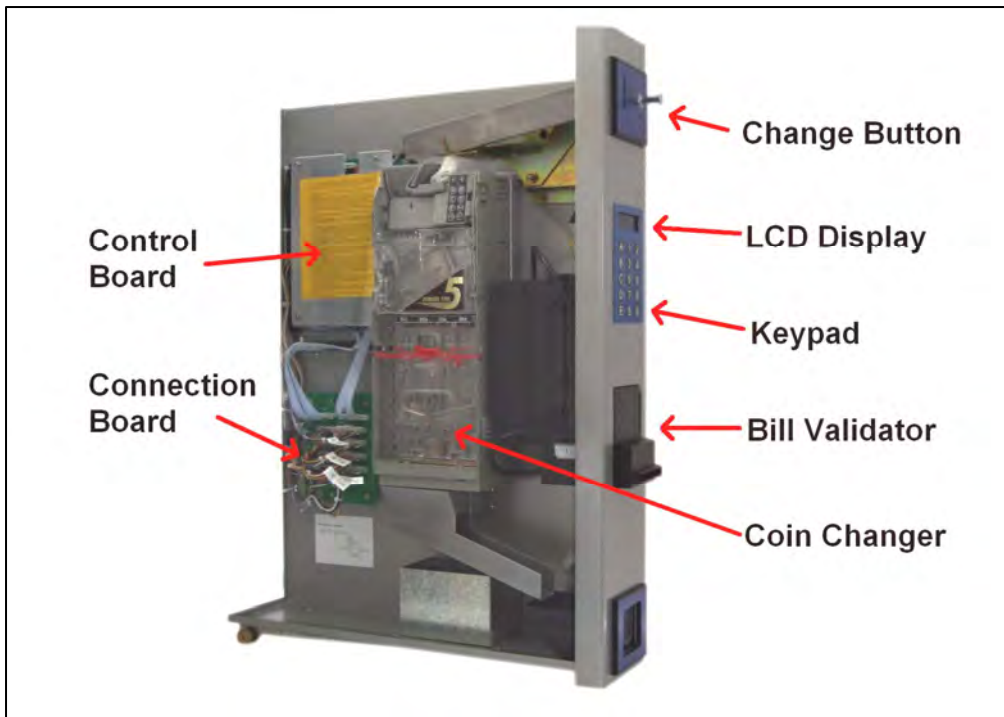

5.2 Coin Changer

The coin changer is locked down for shipping, follow below figures to remove the coin changer for service. Please refer to the coin changer manual for service.

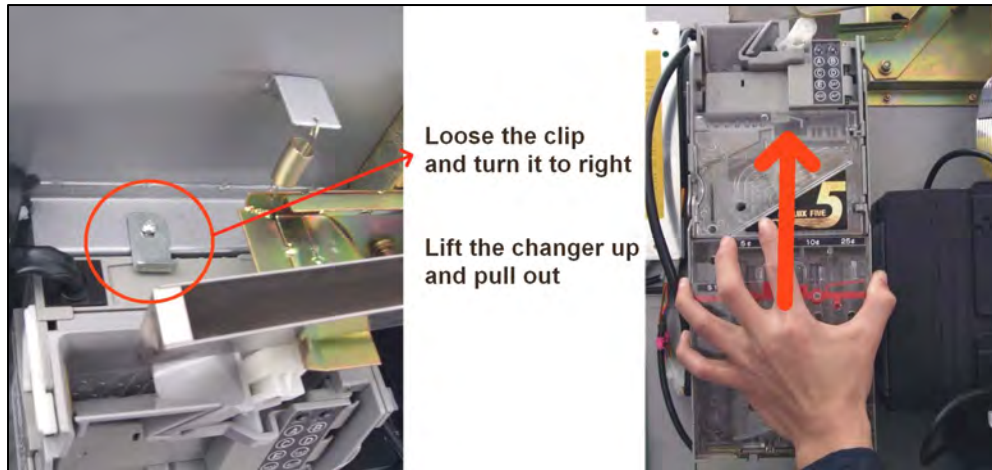

5.3 Bill Validator

The Bill Validator allows your customers to pay for their purchase with paper currency. Your Bill Validator is installed at the factory, and is set to validate \$1 and \$5 bills. The bill storage box will hold approximately 300 bills. Please refer the bill validator for service.

5.4 Vending Motor

The machine vends products by using a gear motor connected to a spiral. On the snack and food machine, the motors are behind the product tray.

To remove snack/candy motor:

1. Unplug the tray wire harness from the control board. Caution: The tray is heavy, you may need two people.
2. Pull the tray fully forward, keeping it leveled.
3. Lift the tray to release from the track. Now it can be pulled forward and lifted out.
4. Set the tray on a table; carefully disconnect the harness connector from the motor.

5. Remove the spiral from the motor by lifting the front end of the spiral up.
6. Remove the motor by loosening the four mounting screws.

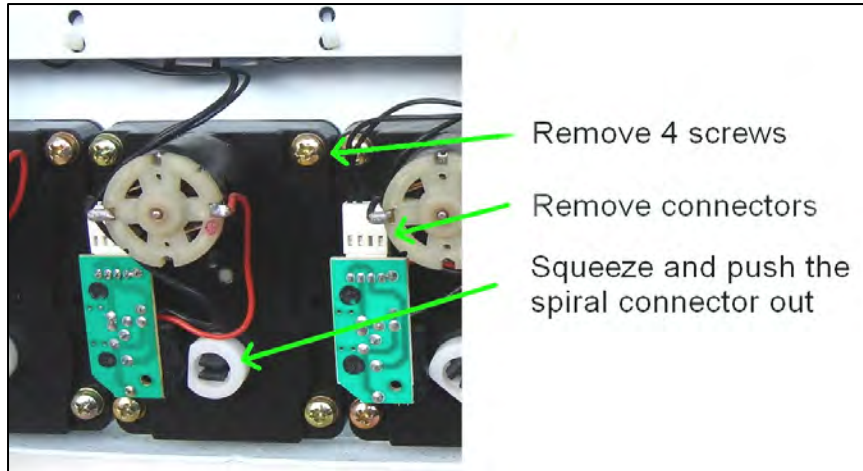

To remove a drink motor:

1. Unplug the harness connector.
2. Remove the motor by loosening the four mounting screws.

5.5 Refrigeration unit

To lower your electric costs and minimize service, it is very important to clean the condenser monthly. The condenser is located at the front of the machine behind the cover. You can use compressed air or vacuum to clean the condenser. A stiff brush may also help.



The refrigeration unit is located at the lower back of the machine. It is completely self-contained

with a 1/4 hp hermetically sealed compressor. You can adjust the machine's temperature by turning the temperature control clockwise (1/8" at a time) for a colder setting. If there is a service problem, follow instructions below to remove the unit from the machine:

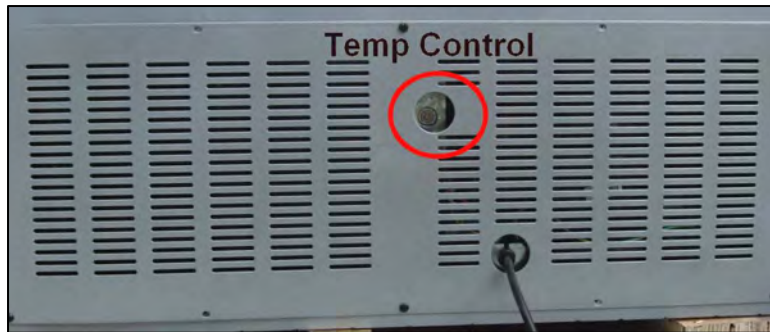

1. Unplug the power cord.
2. Remove the protection grid plate.
3. Remove the 3 mounting screws.
4. Remove the ground cable screws.
5. Pull the unit out by gripping the two handles and wiggle.

Notice:

If the refrigeration unit after extended use needs to be serviced, we recommend sliding a **DULL** thin blade over the cooling chamber. That will break the seal between the rubber gasket and metal surface and allow the unit to slide out easier.

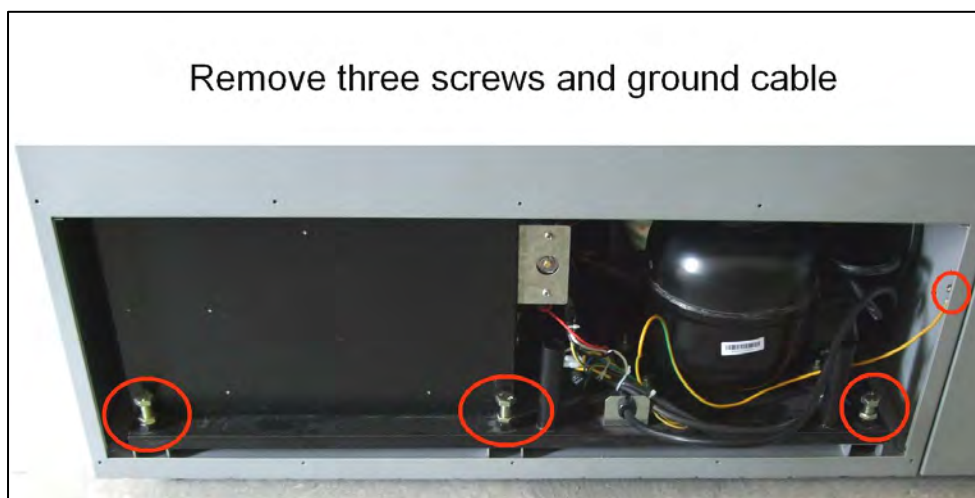

5.6 Electrical Schematic

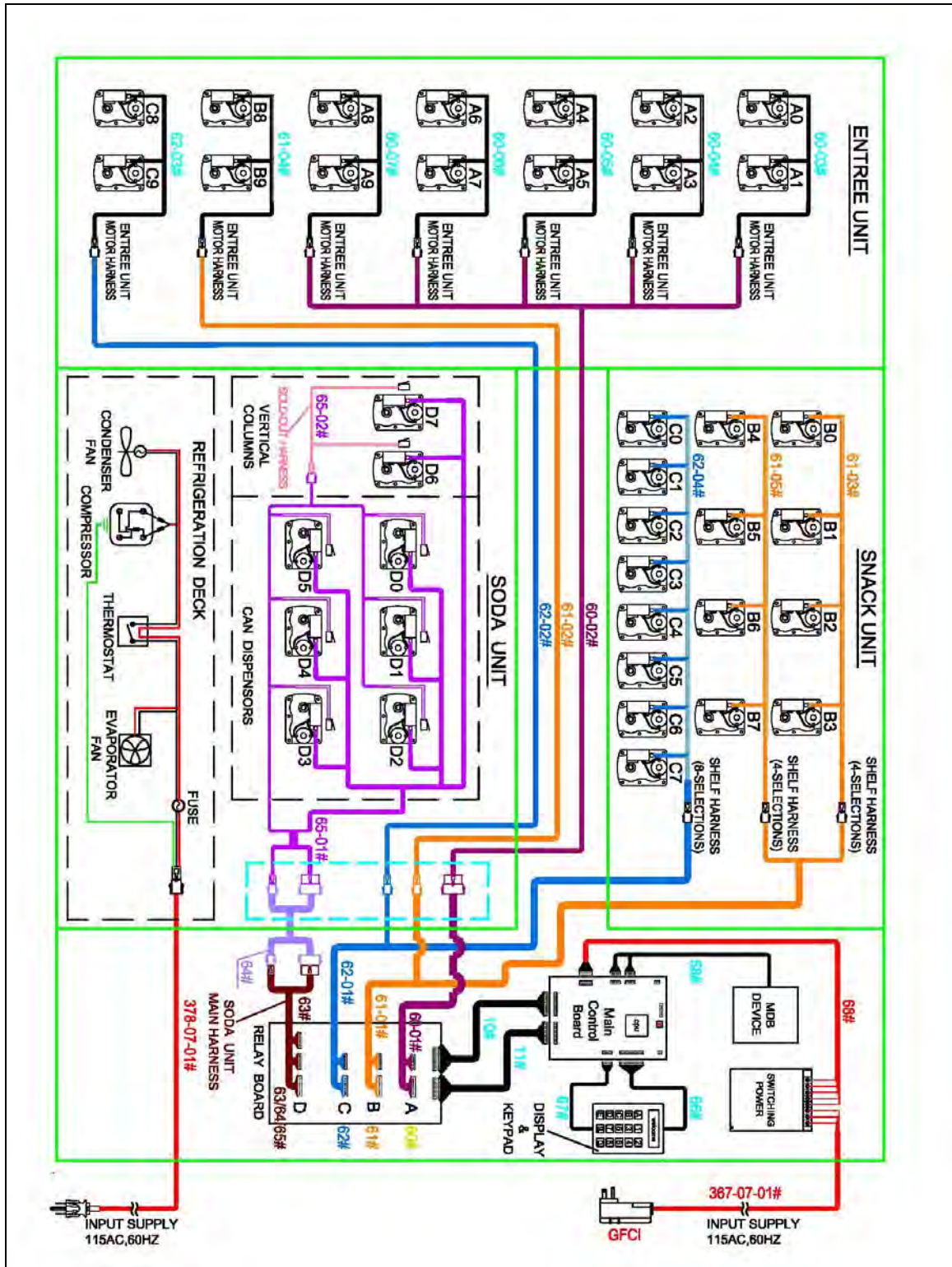

17378 Electrical Schematic :

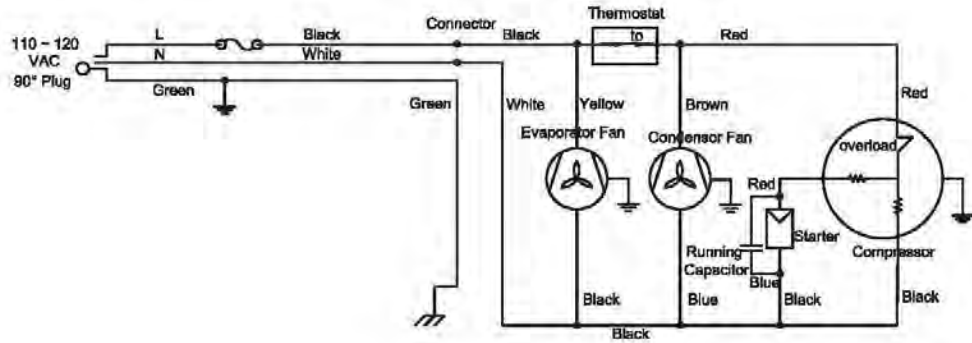

17367 Electrical Schematic :

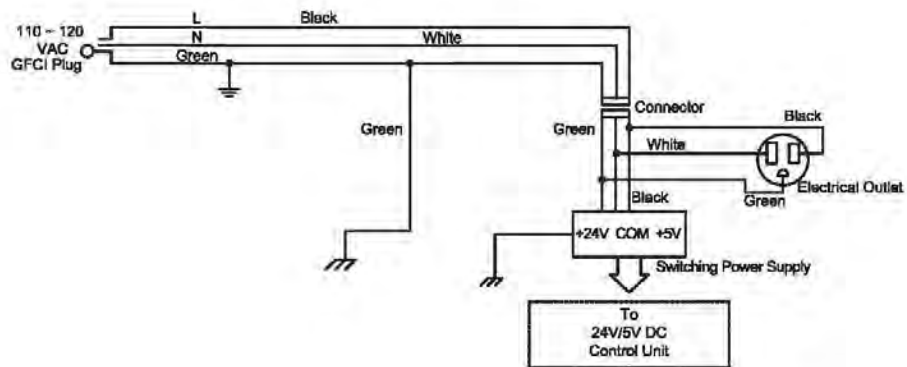

5.7 Common Questions and Trouble Shooting

Q: How high can I set my prices?

- Each selection can be individually priced up to \$95.95.

Q: My machines are plugged into an outlet, I have tested the outlet, but my machines have no power.

- Check the fuses inside the refrigeration compartment and behind the EMC tray.

Q: Motor does not cycle or gives an “error” code on the LCD display or jammed

- Check the Wire Harness on the motor for a loose connection and use “Motor Test” under Service mode to reset the motor.

Q: When I make a selection, the LCD display “error”.

- Perform the "Motor Test" under Service mode to reset the motor.

Q: Motor cycles but will not drop product.

- Make sure products are loaded correctly.
- Check to see if the machine is leveled.
- Check the product for damage, and make sure it is the proper size.
- Make sure the coil is connected to the motor through the spiral connector.

Q: Coin Validator will not accept coins.

- Check to see if there are any foreign objects in the coin validator.
- Coins may be damaged or worn.
- Coin Validator may not have power.

Q: Bill Validator will not accept bills.

- The Validator is not completely close.
- Dirt in the validator, clean with compress can air or alcohol pad.
- Too much money inserted, the bill validator will stop accepting bills if the credit exceeds 2 times the highest sales price
- Is the “Inhibit Bill Mode” set to Yes? (Chapter 4, Service mode).

Q. Do not give change or incorrect changes

- Not enough coins in the changer
- Is the “Force Vend Mode” and “Mutli-Vend Mode” set to what you desire (Chapter 4, Service mode).
- Coins inside the tube may be damaged or worn.
- Is the product price set to the same as displayed?
- Is the changer lined up correctly in the machine?

Q: Cans or bottles do not drop.

- Is the product jammed in the chute?
- Check the product for damages and make sure it is the proper size.
- There are 2 cans and 1 bottle left after the sold out light is lit.

Q: The Compressor is running, but the vendor is too warm.

- Turn the temperature control clockwise (1/8" at a time) to a colder temperature.
- Make sure the seal on the drink compartment door is not worn out.

MANUFACTURER'S WARRANTY

What is covered:

Manufacturer warrants TO THE ORIGINAL PURCHASER ONLY that each vendor is free from defects in material and workmanship under normal use and service. Manufacturer's obligation under this warranty shall be limited to repair or replacement, at our plant, of any parts of the vendor which shall, within three months of the date of shipment to the original purchaser, be demonstrated to be defective. The original purchaser may obtain repair or replacement of the vendor under this warranty by returning the defective item or entire vendor to the Manufacturer, freight prepaid. . In addition, Manufacturer will provide nine months warranty in parts.

What is Not covered:

Manufacturer's warranty obligations DO NOT EXTEND TO OR INCLUDE installation expenses or difficulties resulting from failure to operate vendor in accordance with Manufacturer's instructions under competent supervision.

SPECIAL NOTE: Manufacturer is not responsible for any loss of income due to a machine being out of service due to a warrantable item.

This warranty is in lieu of all other warranties, expressed or implied, including the warranty of merchantability and fitness or use, and of all other obligations or liabilities on Manufacturer's part. Manufacturer neither assumes, nor authorizes any other person to assume for it, any other liability in connection with the sale of equipment manufactured by itself. This warranty shall not apply to equipment manufactured or any part thereof which is subject to accident, negligence, alteration, abuse, misuse or damage in shipment. The term "original purchaser," as used in this warranty, shall be deemed to mean that person for whom the equipment is originally installed.

Manufacturer is not liable for any incidental, consequential or other damages of any kind whatsoever, directly or indirectly, arising from the use of the equipment whether based upon theories of contract, negligence or tort.

Removal of the serial number voids the warranty.