



BYPASS DISTRIBUTION MODULE

XBDM

USER & INSTALLATION MANUAL

Table of Contents

IMPORTANT SAFETY INSTRUCTIONS:	4
INTRODUCTION	6
PRODUCT DESCRIPTION	6
Bypass Distribution Description	6
SYSTEM CONFIGURATION	8
LED Description	9
HARDWARE INSTALLATION GUIDE	10
Installation	10
Horizontal Installation (1U).....	10
Vertical Installation (0U)	11
CONNECTING	12
Initial Connection and Startup Sequence	12
USER'S OPERATIONS	15
Normal Operation	16
Bypass Operation	16
SPECIFICATIONS	19
SHIPPING LIST	20
OBTAINING SERVICE	21
XTREME POWER CONVERSION® (XPC) CORPORATION LIMITED WARRANTY	22

Thank you for selecting this bypass distribution module. It is designed to work in conjunction with a UPS to provide you with protection for connected equipment. **Please read this manual** before installing the XBDM-Series models XBDM-1015LV, XBDM-1020LV, XBDM-1030LV, and XBDM-1020HV as it provides important information that should be followed during installation allowing you to correctly set up your

system for the maximum safety and performance. Included is information on customer support and service. If you experience a problem with the XBDM, please contact technical support.

WARNING: Incorrect installation, operation, and/or modifications made to the XBDM will void the manufactures warranty. Xtreme Power Conversion is not liable for personnel or equipment damages as a result.

IMPORTANT SAFETY INSTRUCTIONS:**(SAVE THESE INSTRUCTIONS)**

CAUTION! Two sources of power are present in the XBDM: UPS power and Utility power

CAUTION! (UPS has Internal Batteries): Risk of electrical shock – Hazardous live parts inside the UPS are energized from the battery supply even when the input AC power is disconnected.

CAUTION! (No User serviceable Parts): Risk of electrical shock, do not remove cover. No user serviceable parts inside. Refer servicing to qualified service personnel.

WARNING! Unit intended for installation in a controlled environment per installation instructions.

CAUTION! If flammable substances such as gases or fumes are present, or if the room is airtight, a hazardous situation may exist in which no electrical equipment should be operated.

**WARNING!**

It is strongly recommended that the XBDM not be opened as components have very high voltage and touching those components may be fatal. Only a qualified technician or authorized agent may service the unit.

The XBDM unit's output receptacles can carry live voltage even when not connected to an input voltage source. The UPS has its own internal energy source.



CAUTION

The unit has a dangerous amount of voltage. If either the UPS or BYPASS indicator is on, the unit's outlets may have a dangerous amount of voltage even when not plugged into the wall outlet because the battery from the UPS may continue to supply power.

Care should be taken to undertake installation indoors, free from electrically-conductive particles which are under temperature and humidity control, in order to reduce the risk of electric shock.

It is best to disconnect the device using the power supply cord. Ensure that the equipment is placed in a position near the outlet where easily accessible.

All servicing on this equipment must be carried out by qualified service personnel.

The Xtreme Bypass Distribution Module (XBDM) is intended to allow replacement of the UPS connected without having to shut down the equipment connected to the load circuits on the XBDM. Caution should be observed as the XBDM is always supplied with power by either the UPS or UTILITY.

Environment

Ensure that all environmental concerns and requirements are met according to specifications listed in this document, otherwise the safety of installation personnel cannot be guaranteed, and the unit may malfunction.

Ensure that you remember the following when locating the XBDM:

- Avoid extremes of temperature and humidity.
 - Operating temperature: 0°C to +50°C (+32° to +122° F)
 - Operating elevation: 0 to 3000m (0-10,000 ft)
 - Relative humidity: 0-90%, non-condensing
 - Storage temperature: 0-65° C (+32 to +149° F)
 - Storage elevation: 0 to 15,000m (0 to +50,000 ft)
- Provide protection for the equipment from moisture.
- Space and ventilation requirements must be met.

INTRODUCTION

The information provided in this manual covers single phase 15A, 20A, and 30A bypass distribution modules, their basic functions, operating procedures, options available and emergency situations. It also includes information on how to ship, store, handle, and install the equipment. Only detailed requirements of the XBDM units are described herein, and installation must be carried out in accordance with this manual. Refer to the associated UPS manual for UPS operating instructions. Electrical installation must also carefully follow local legislation and regulations. Only qualified personnel should conduct these installations as failure to acknowledge electrical hazards could prove to be fatal.

PRODUCT DESCRIPTION

Many different kinds of sensitive electrical equipment can be protected by an Uninterruptible Power Supply (UPS) including computers, workstations, process control systems, telecommunications systems, sales terminals, other critical instrumentation, etc. The purpose of the XBDM is to provide an extra level of protection in allowing for the replacement of a UPS without powering down the loads connected. The XBDM can work with most single phase topologies. It will not work with topologies that have a phase shift between input and output (like ferro of UPS with an isolation transformer) .

Electrical interference exists in many forms, causing problems in AC power, from lightning, power company accidents and radio transmission motors, air conditioners, and vending machines. Protection of sensitive electrical equipment is vital to protect against power outages, low or high voltage conditions, slow voltage fluctuations, frequency variations, differential and common-mode noise, transients, etc.

To prevent power line problems from reaching critical systems causing damage to software, hardware, and equipment malfunctions, the UPS maintains constant voltage, isolating critical load output and cleaning the utility AC power. When a UPS fails or needs maintenance, many times it is necessary to turn off the UPS and disconnect it from incoming electrical circuits. With the XBDM installed between the incoming Utility and the UPS, you can replace the UPS and/or Batteries without dropping the load. You simply switch the XBDM from UPS power to Utility power and remove the UPS while the load connected to the XBDM continues to operate temporarily from Utility power.

Bypass Distribution Description

The Xtreme Bypass Distribution Module (XBDM) is designed to operate with a single-phase UPS up to 30Amps in output capacity. The XBDM allows you to:

- Replace or upgrade the UPS without losing power to the protected equipment
- Provide surge protection if the UPS is not present
- Provide extra surge protection when the UPS is present

As shown in fig. 1 block diagram:

- Under normal operation, the UTILITY INPUT flows through the XBDM to the UPS and then out to the CONNECTED LOADS.

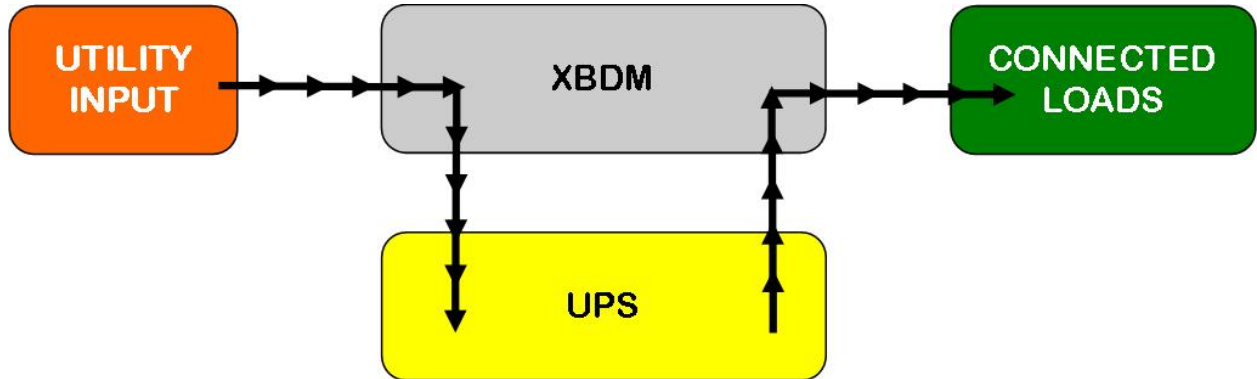

Figure 1 – Block Diagram with UPS

As shown in fig. 2 block diagram:

- Under maintenance operation, the UTILITY INPUT flows through the XBDM to the CONNECTED LOADS – the UPS is not in the circuit.

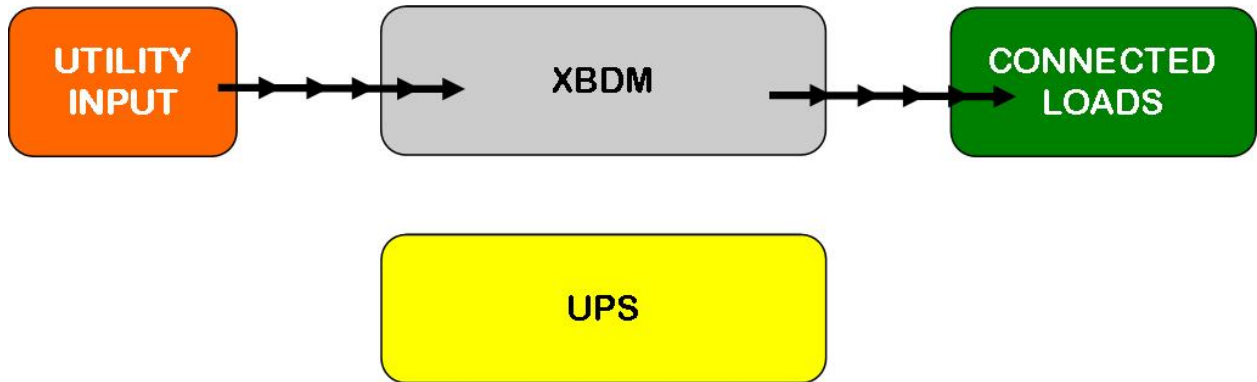

Figure 2 – Block Diagram without UPS

SYSTEM CONFIGURATION

The diagrams shown give front, top and rear view of the XBDM

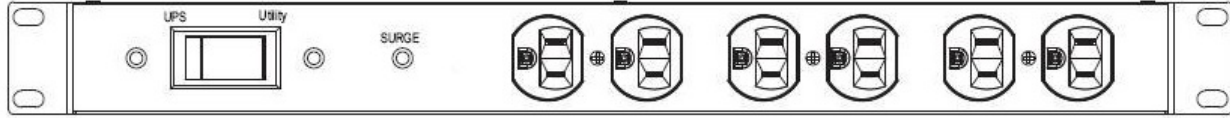

Figure 3 – XBDM-1015LV Front View

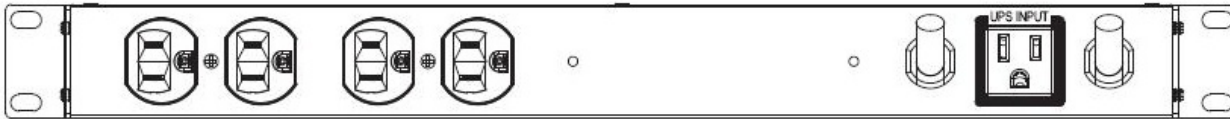

Figure 4 – XBDM-1015LV Rear View

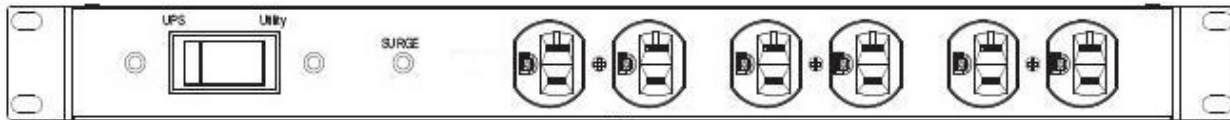

Figure 5 – XBDM-1020LV Front View



Figure 6 – XBDM-1020LV Rear View

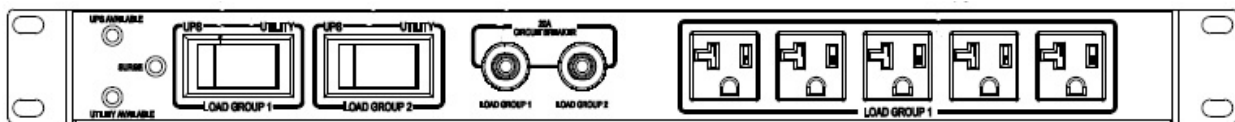

Figure 7 – XBDM-1030LV Front View

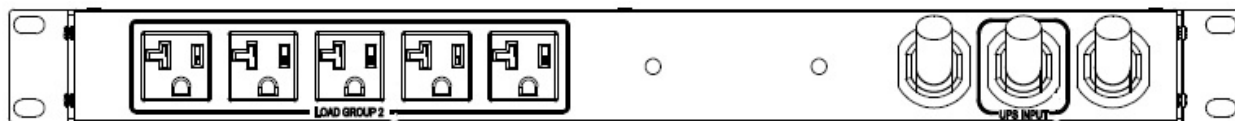

Figure 8 – XBDM-1030LV Rear View



Figure 9 – XBDM-1020HV Front View



Figure 10 – XBDM-1020HV Rear View

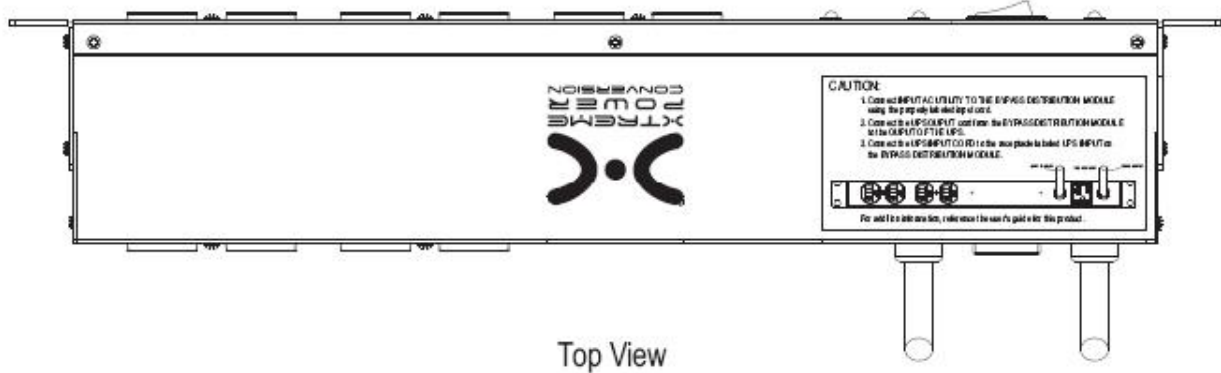

Figure 11 – XBDM-1015LV Top View

LED Description

The XBDM has three LED's on the front control panel. These LED's allow the user to quickly understand the status of the unit.

Red LED = UPS power is available

Orange LED = Utility is available for Bypass operation

Green LED = Surge Protection is available.

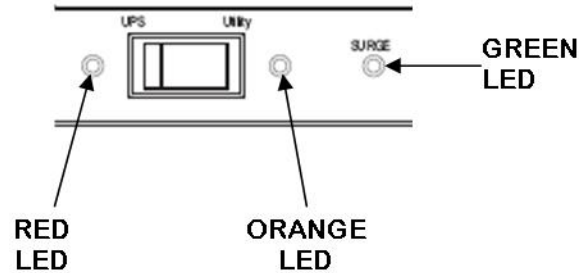

Figure 12 – XBDM Front Panel LED's

CAUTION: The Orange LED must be illuminated before transferring to BYPASS power.

The Red LED must be illuminated before transferring to UPS power.

HARDWARE INSTALLATION GUIDE

Inspect the XBDM upon receipt. The packaging is recyclable; keep it for reuse or dispose of properly.

Installation

The XBDM supports horizontal 1U rack mount and vertical rack mount installation.

Horizontal Installation (1U)

1. Attach the two (2) XBDM horizontal mounting brackets (included) on each end of the XBDM using four (4) retaining screws (included) see Figure 1.

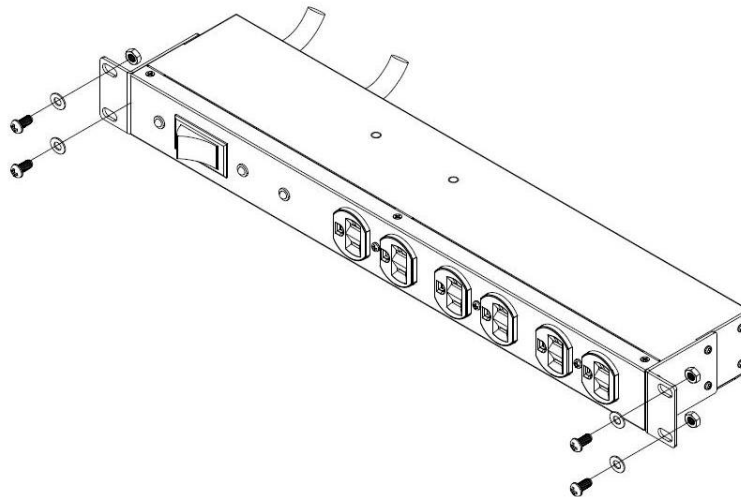

Figure 13 – XBDM Horizontal Mounting

2. Install the XBDM in a suitable horizontal location in the rack rail using four (4) user-provided mounting screws.

Vertical Installation (0U)

1. Attach the two (2) XBDM horizontal mounting brackets (included) on each end of the XBDM using four (4) retaining screws (included) see Figure 2.

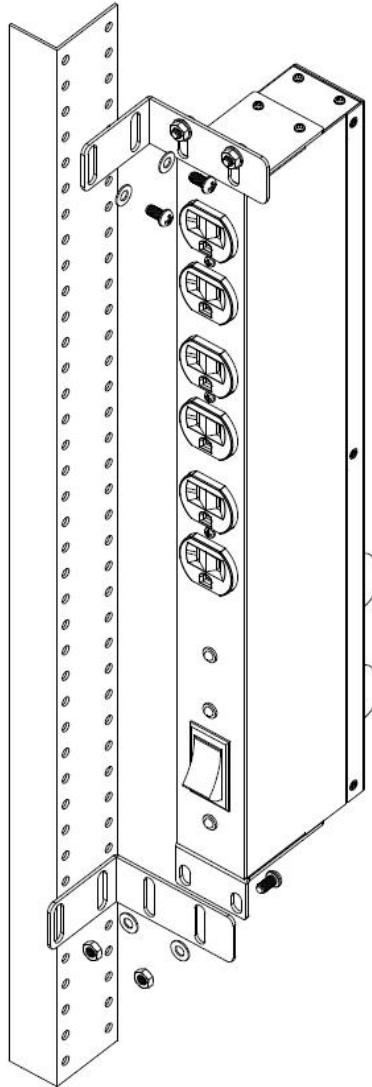

Figure 14 – XBDM Vertical Mounting

2. Attach the two vertical mounting brackets (included) to the horizontal rack mounting brackets on each end of the XBDM using four (4) retaining screws (included) see Figure 2.
3. Install the XBDM in a suitable vertical location on the side of the rack rail with four (4) user provided mounting screws.

CONNECTING

Initial Connection and Startup Sequence

1. If the UPS is already installed and operating, continue to Step 3.
2. Install the UPS and any optional Extended Battery Packs or Modules according to UPS manufacturers' documentation. Do not connect loads to the UPS (Proceed to step 5)
3. Prepare your equipment for shutdown.
4. Turn the UPS OFF in accordance with UPS manufacturers' documentation.
5. Unplug the UPS. Depending on the model of UPS it may take a few seconds for the UPS to completely shut down. All indicators on the UPS front panel should shutdown.
6. Disconnect the protected equipment power cord(s) from the UPS.
7. Verify that the BYPASS switch on the XBDM is in the UPS position.

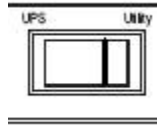

Figure 15 – XBDM Bypass Switch – UPS Position

8. Plug the XBDM into a properly wired utility outlet.

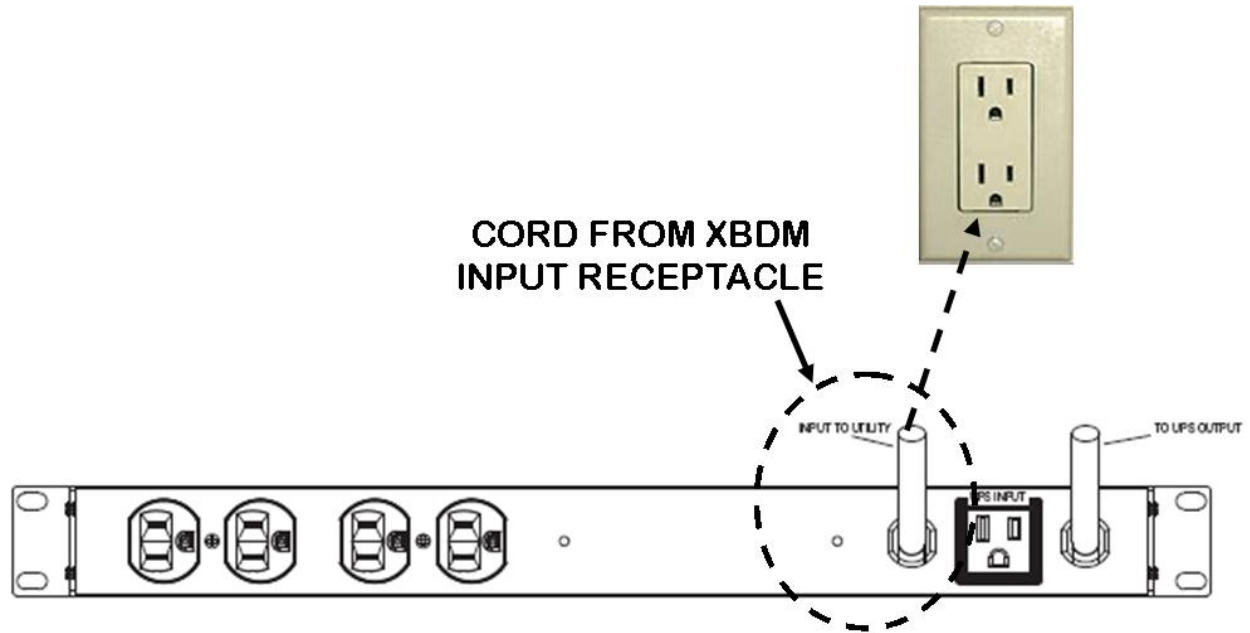

Figure 16 – XBDM to AC Input Receptacle

The orange bypass available light should illuminate on the Bypass Distribution Module.

9. Plug the UPS OUTPUT cord from the XBDM into an OUTPUT RECEPTACLE on the UPS.

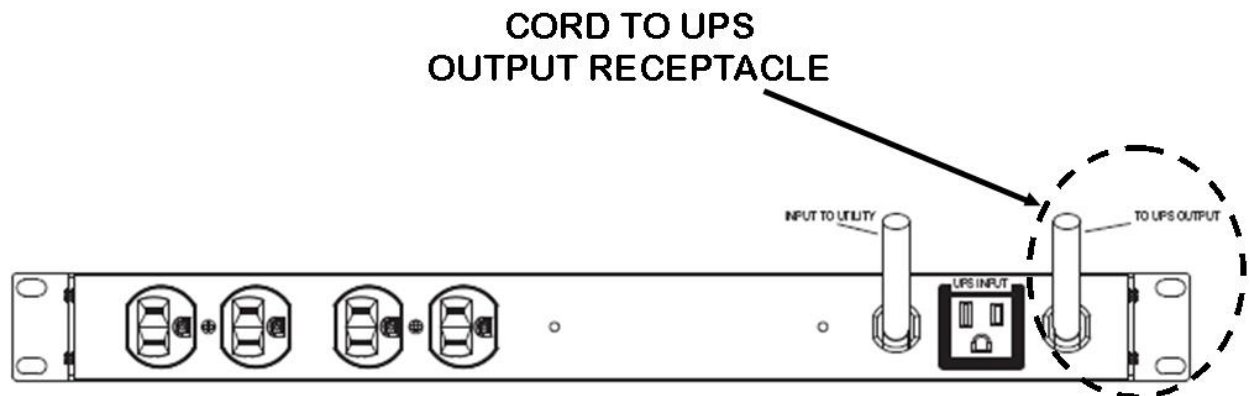

Figure 17 – XBDM Cord to UPS Output Receptacle

- Plug the equipment to be protected into the appropriate XBDM output receptacles.
Note: XBDM-1030LV has two LOAD GROUPS. If you have a combination of loads greater than 20A, split the loads by plugging some cords into LOAD GROUP 1 and the others into LOAD GROUP 2.

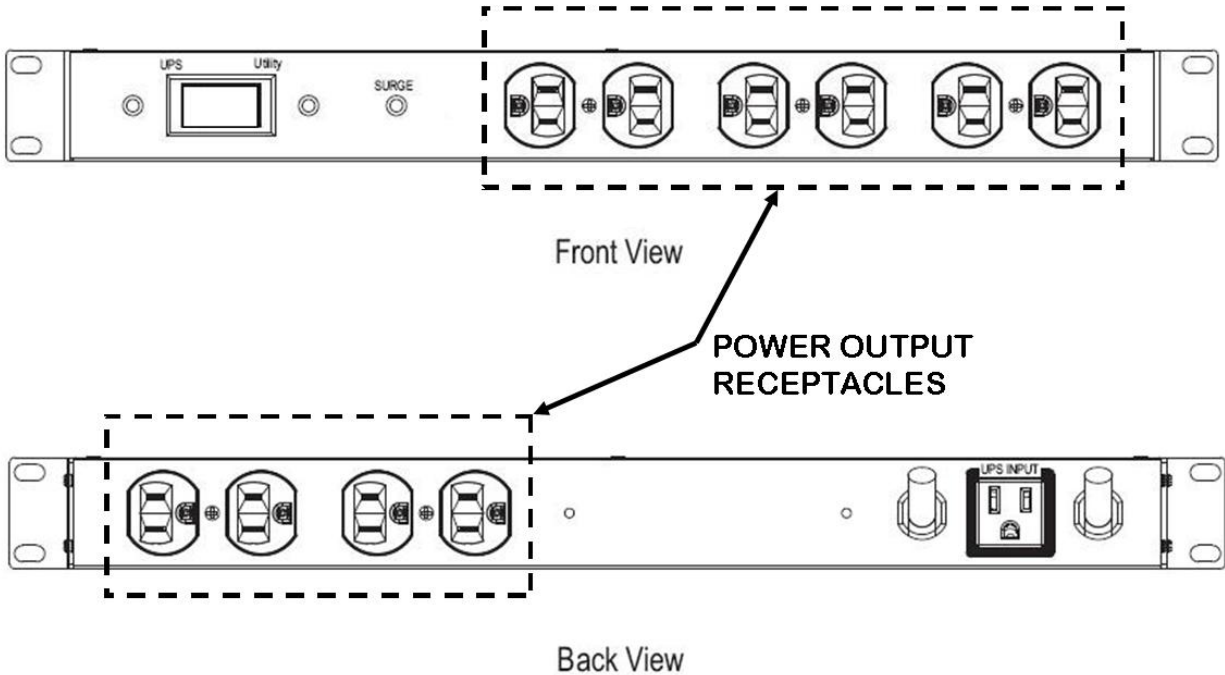

Figure 18 – XBDM-1015/1020LV Output Receptacles

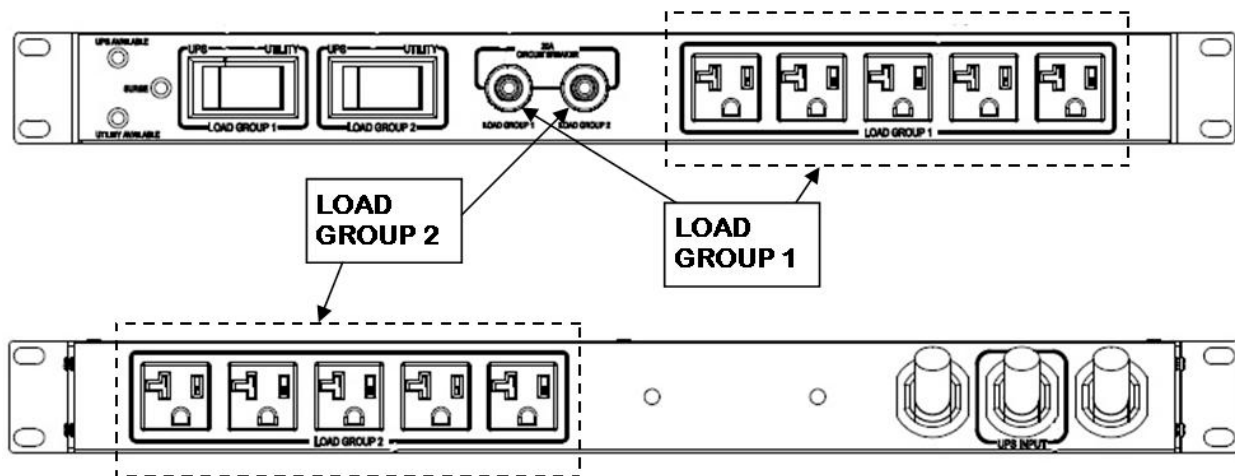

Figure 19 – XBDM-1030LV Output Receptacles

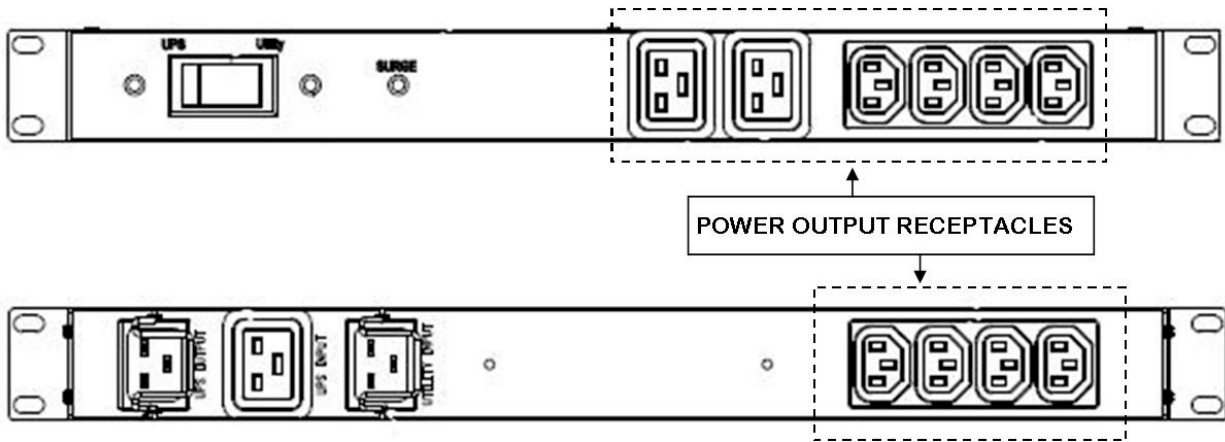

Figure 20 – XBDM-1020HV Output Receptacles

11. Plug the UPS INPUT power cord into the UPS INPUT RECEPTACLE on the XBDM. Depending upon the UPS operation, once the XBDM is connected to AC INPUT, the UPS may begin its startup procedure.

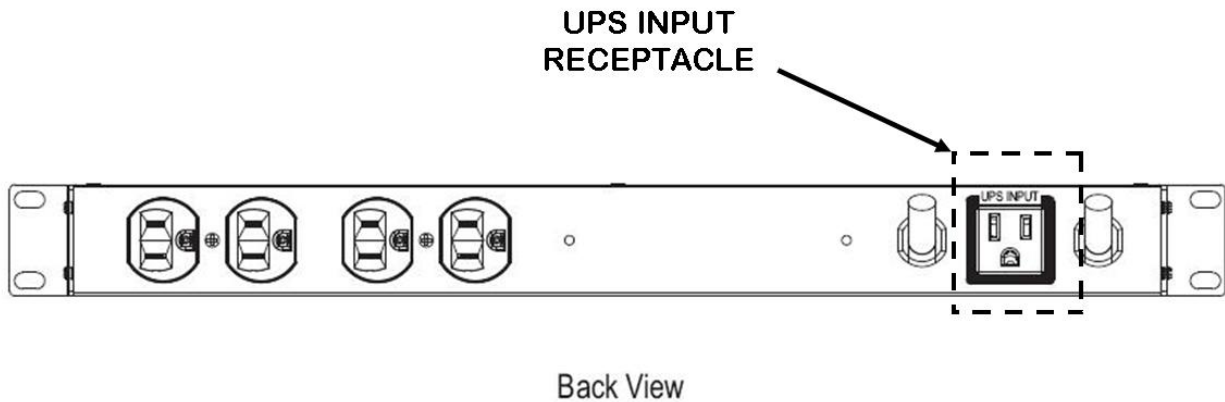

Figure 21 – XBDM UPS Input Receptacle

12. Press the ON BUTTON on the UPS. All indicators on the UPS should operate normally and output power should be provided to LOADs connected to the XBDM OUTPUT. The red UPS available light should illuminate on the Bypass Distribution Module.

USER'S OPERATIONS

The purpose of this BYPASS DISTRIBUTION MODULE is to allow servicing of the UPS so as not to affect the LOADs connected and protected. To transfer between UPS and utility sources, swiftly actuate the

bypass switch to the opposite position. Both the UPS, and Utility lights available must be illuminated to prevent transferring to a non-powered source.

Normal Operation

When operating in NORMAL mode the switch on the front of the XBDM will be in the UPS position

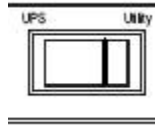

Figure 22 – XBDM Bypass Switch – UPS

CAUTION: The red LED on the bypass module must be illuminated before transferring to the UPS position.

Bypass Operation

To transfer your equipment to Maintenance Bypass (AC Line operation) and remove the UPS:

1. Toggle the Bypass Switch on the XBDM to UTILITY position. The XBDM is now powering your equipment from Utility power.

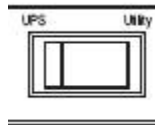

Figure 23 – XBDM Bypass Switch - UTILITY

CAUTION: The Orange LED must be illuminated before transferring to BYPASS operation.

CAUTION: When the XBDM is operating in UTILITY MODE, the LOAD connected is not protected from power outages.

2. Press the OFF BUTTON on the UPS per the UPS manufacturers' documentation.
3. If any optional Extended Battery Packs or Modules are connected to the UPS, turn off the circuit breaker on the battery pack or module (if applicable), and disconnect the cable from the battery pack or module to the UPS.
4. Disconnect the UPS output cord from the XBDM to the UPS output receptacle.
5. Disconnect the UPS INPUT CORD from the UPS INPUT RECEPTACLE on the XBDM.
6. Remove the UPS.

To reinstall the UPS and transfer your equipment from Maintenance Bypass (AC Line operation) to the UPS:

1. If optional Extended Battery Packs or Modules are installed, reconnect the cable from the battery pack or module to the UPS, and turn on the circuit breaker on the battery back or module (if applicable) per the UPS manufacturers' documentation.
2. Connect the UPS output cord from the XBDM to a UPS output receptacle
3. Plug the UPS INPUT POWER CORD into the XBDM UPS INPUT RECEPTACLE.
4. Start the UPS per the manufactures instructions. The red UPS available light should illuminate on the Bypass Distribution Module.
5. Toggle the Bypass Switch on the XBDM to UPS position. The XBDM is now powering your equipment from UPS power.

Note: XBDM-1030LV has two BYPASS SWITCHES each controlling a separate group of receptacles. Please assure you have operated both BYPASS SWITCHES prior to removing the UPS from the XBDM.

A label is placed on the top of each XBDM to highlight the proper connectivity of the INPUT and OUTPUT of the XBDM and UPS.

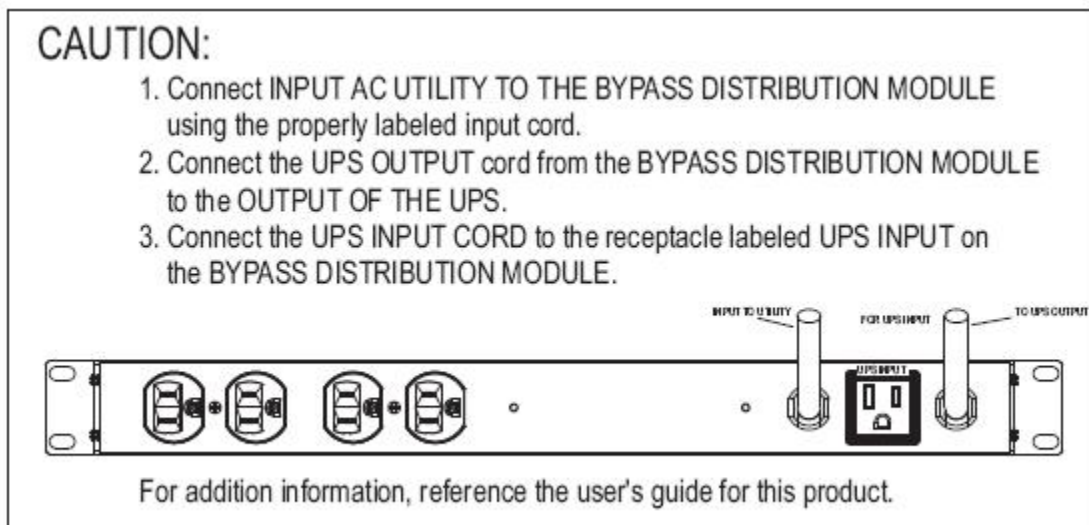

Figure 24 – XBDM-1015/1020LV Top Unit Label

CAUTION:

1. Connect **INPUT AC UTILITY TO THE BYPASS DISTRIBUTION MODULE** using the properly labeled input cord.
2. Connect the **UPS OUTPUT** cord from the **BYPASS DISTRIBUTION MODULE to the OUTPUT OF THE UPS.**
3. Connect the **UPS INPUT CORD** to the receptacle labeled **UPS INPUT** on the **BYPASS DISTRIBUTION MODULE.**



For addition information, reference the user's guide for this product.

Figure 25 – XBDM-1030LV Top Unit Label

CAUTION:

1. Connect **INPUT AC UTILITY TO THE BYPASS DISTRIBUTION MODULE** using the properly labeled input cord.
2. Connect the **UPS OUTPUT** cord from the **BYPASS DISTRIBUTION MODULE to the OUTPUT OF THE UPS.**
3. Connect the **UPS INPUT CORD** to the receptacle labeled **UPS INPUT** on the **BYPASS DISTRIBUTION MODULE.**



For addition information, reference the user's guide for this product.

Figure 26 – XBDM-1020HV Top Unit Label

SPECIFICATIONS

XBDM MODEL	XBDM-1015LV	XBDM-1020LV	XBDM-1030LV	XBDM-1020HV*
POWER RATING	15A / 120VAC	20A / 120VAC	30 A / 120VAC	20A / 230VAC
UTILITY INPUT	5-15P 12FT	5-20P 12FT	L5-30P 6FT	IEC C20
AC FREQUENCY	50 / 60 HZ			
MAXIMUM OUTPUT	12A	16A	24A	16A
RECEPTACLES				
FRONT OUTPUT	(6) 5-15R	(6) 5-20R	(5) 5-20R	(2) IEC C19 + (4) IEC C13
REAR OUTPUT	(4) 5-15R	(4) 5-20R	(5) 5-20R	(4) IEC C13
REAR UPS INPUT	(1) 5-15R	(1) 5-20R	(1)L 5-30R	(1)IEC C19
UPS OUTPUT	5-15P 3FT	5-20P 3FT	L5-30P 3FT	IEC C20
TRANSFER SWITCH BREAK BEFORE MAKE TWO-POLE (MAX 8ms TRANSFER TIME)	(1) 15A	(1) 20A	(2) 20A	(1) 20A
AC SURGE				
MAX SPIKE CURRENT	6500A			
ENERGY DISSIPATION	114 Joules			220 Joules
MAX CLAMPING VOLTAGE	330V			775V
INDICATORS				
UPS AVAILABLE	RED LED			
UTILITY AVAILABLE	ORANGE LED			
SURGE PROTECTION	GREEN LED			
PHYSICAL				
SIZE (1U)	(W x D x H) 17" x 3.5" x 1.75"			
WEIGHT	3.5 LBS			

*Note: XBDM-1020HV has two different part #'s. Please see Shipping List on next page.

SHIPPING LIST

1. (1) XBDM
2. Standard 19" rack mounting hardware
3. User's Manual
4. For XBDM-1020HV:
 - A. FOR USE WITH NXRTi-1000 (XBDM1020HV1):
 - I. (1) IEC C19 to SCHUKO
 - II. (1) IEC C13 to C20
 - III. (1) IEC C14 to C19
 - B. FOR USE WITH NXRTi-2000/3000 (XBDM1020HV2):
 - I. (2) IEC C19 to C20
 - II. (1) IEC C19 to SCHUKO

OBTAINING SERVICE

If the XBDM requires Service:

1. Use the TROUBLESHOOTING section in this manual to eliminate obvious causes.
2. Verify there are no circuit breakers tripped.
3. Call your dealer for assistance. If you cannot reach your dealer, or if they cannot resolve the problem, call Xtreme Power Conversion Corp Technical Support at 800.582.4524 or +1.720.292.1217. Technical support inquiries can also be made at support@xpcc.com. Please have the following information available BEFORE calling the Technical Support Department:
 - a. Your name and address.
 - b. The serial number of the unit.
 - c. Where and when the unit was purchased.
 - d. All of the model information about your UPS.
 - e. Any information on the failure, including LED's that may or may not be illuminated.
 - f. A description of the protected equipment, including model numbers if possible.

A technician will ask you for the above information and, if possible, help solve your problem over the phone. In the event that the unit requires factory service, the technician will issue you a Return Material Authorization number (RMA).

If you are returning the XBDM to Xtreme Power for service, please follow these procedures:

1. Pack the XBDM in its original packaging. If the original packaging is no longer available, as the Technical Support Technician about obtaining a replacement set of packaging material. It is important to pack the XBDM properly in order to avoid damage in transit. Never use Styrofoam beads for a packing material.
2. Include a letter with your name, address, daytime phone number, RMA number, a copy of your original sales receipt, and a brief description of the problem.
3. Mark the RMA number on the outside of all packages. Xtreme Power cannot accept any package without the RMA number marked on the outside of the boxes.
4. Return the XBDM by insured, prepaid carrier to the address provided by the Technician.

Refer to the Warranty statements in this manual for additional details on what is covered.

XTREME POWER CONVERSION® (XPC) CORPORATION LIMITED WARRANTY

Xtreme Power Conversion (XPC) Corporation warrants Xtreme Power Conversion equipment, when properly applied and operated within specified conditions, against faulty materials or workmanship (excluding batteries) for a period of **three years for XBDM-Series products** from the date of purchase. For equipment sites within the United States and Canada, this warranty covers repair or replacement, at the sole discretion of XPC Corporation. The customer is responsible for the costs of shipping the defective product to XPC Corporation. XPC Corporation will pay for ground shipment of the repaired or replacement product. This warranty applies only to the original purchaser.

If equipment provided by XPC Corporation is found to be **Dead-on-Arrival (DOA)**, XPC Corporation will be responsible for the costs of shipping product to and returning equipment from the customer in a timely manner as agreed to with the customer, once the customer has requested and received a **Return Material Authorization (RMA)** number. DOA equipment is defined as equipment that does not properly function according to user documentation when initially received and connected in conjunction with proper procedures as shown in the user documentation or via support provided by XPC Corporation personnel or authorized agents.

This warranty shall be void if (a) the equipment is repaired or modified by anyone other than XPC Corporation or a XPC Corporation approved third party; (b) the equipment is damaged by the customer, is improperly used or stored, is subjected to an adverse operating environment, or is operated outside the limits of its electrical specifications; or (c) the equipment has been used or stored in a manner contrary to the equipment's operating manual, intended use or other written instructions. Any technical advice furnished by XPC Corporation or a XPC Corporation authorized representative before or after delivery with regard to the use or application of Xtreme Power Conversion equipment is furnished on the basis that it represents XPC Corporations best judgment under the situation and circumstances, but it is used at the recipient's sole risk.

EXCEPT AS STATED ABOVE, XPC Corporation DISCLAIMS ALL WARRANTIES, EXPRESSED OR IMPLIED, INCLUDING WARRANTIES OF MERCHANTABILITY AND FITNESS FOR A PARTICULAR PURPOSE.

EXCEPT AS STATED ABOVE, IN NO EVENT WILL XPC Corporation BE LIABLE FOR DIRECT, INDIRECT, SPECIAL, INCIDENTAL, OR CONSEQUENTIAL DAMAGES ARISING OUT OF THE USE OF Xtreme Power Conversion EQUIPMENT, including but not limited to, any costs, lost profits or revenue, loss of equipment, loss of use of equipment, loss of software, loss of data, cost of substitutes, or claims by third parties..Purchaser's sole and exclusive remedy for breach of any warranty, expressed or implied, concerning Xtreme Power Conversion equipment, and the only obligation of XPC Corporation under this warranty, shall be the repair or replacement of defective equipment, components, or parts; or, at XPC Corporations sole discretion, refund of the purchase price or substitution of an equivalent replacement product.