



USER MANUAL

Please carefully check the unit and make sure there is no damage when you open the carton.

QUESTIONS, PROBLEMS, OR MISSING PARTS?
Please Contact Customer Service Before Returning to Store

 www.soupro.com

 servicespi@sourceproinc.com

 +1-844-455-4621

If parts are damaged or missing please call customer service for replacements.
DO NOT RETURN THIS PRODUCT TO THE RETAILER.

Keep this manual for future reference

Table of Contents

- **GENERAL INFORMATION**
 - Package Contents _____ 2
 - Safety Instructions _____ 3
 - Warranty _____ 4
- **FIREBOX OPERATIONS**
 - FCC/IC Information _____ 5
 - Safety Information _____ 6
 - Operating Instructions _____ 7
 - Care And Maintenance _____ 8
 - Troubleshooting _____ 9

Package Contents

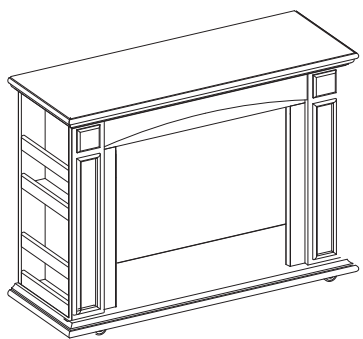

Fireplace Mantel
SP2094

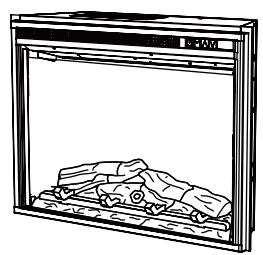

Firebox
SP2320-IR-FGPB

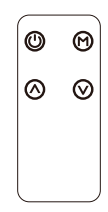

Remote Control







Safety Instructions



Please read and understand this entire manual before attempting to assemble, operate or install the product.

IMPORTANT NOTICE

When using electrical appliances, basic precautions should always be followed to reduce the risk of fire, electric shock and injury to persons, including the following:

-  **WARNING:** Place this unit in a location that avoids direct sunlight and high temperatures.
-  **WARNING:** Plastic bags, nails, etc. should be kept out of reach of children.
-  **WARNING:** This appliance is hot when in use. To avoid burns, DO NOT let bare skin touch hot surfaces. Keep combustible material, such as furniture, pillows, bedding, papers, clothes and curtains, at least 3 feet from the front of the heater and keep them away from the side and rear.
-  **WARNING:** Extreme caution is necessary when any heater is used by or near children or individuals with disabilities and whenever the fireplace is left operating and unattended.
-  **WARNING:** DO NOT run cord under carpeting. DO NOT cover cord with throw rugs, runners, or similar covering. Do not route cord under furniture or appliances. Arrange cord away from traffic areas and where it will not be tripped over.
-  **WARNING:** DO NOT insert or allow foreign objects to enter any ventilation or exhaust opening as this may cause an electric shock or fire, or damage the appliance.
-  **WARNING:** This appliance has hot and arcing or sparking parts inside. DO NOT use it in areas where gasoline, paint or flammable vapors or liquids are used or stored. This fireplace should not be used as a drying rack for clothing. Christmas stockings or decorations should not be hung in the area of it.

Warranty

1-YEAR LIMITED WARRANTY



Source Pro Industries Ltd. (hereinafter referred to collectively as “the Company”) warrants that your new **HearthPo** Electric Fireplace is free from manufacturing and materials defects for a period of one (1) year from date of purchase. Subject to the following conditions and limitations:

1. The electric fireplace must be installed and operated at all times in accordance with the installation and operating instructions furnished with the product. Any unauthorized repair, alteration, willful abuse, accident, or misuse of the product shall nullify this warranty.
2. This warranty is non-transferable, and is made to the original owner, provided that the purchase was made through an authorized supplier of the Company.
3. The warranty is limited to the repair or replacement of part(s) found to be defective in material or workmanship – provided that such part(s) have been subjected to normal conditions of use and service – after said defect is confirmed by the Company’s inspection. All replacement parts or products will be new, remanufactured, or refurbished.
4. The Company may, at its discretion, require that any defective part(s) be returned in exchange for the replacement part(s).
5. The Company may, at its discretion, fully discharge all obligations with respect to this warranty by refunding the wholesale price of the defective part(s).
6. This warranty does not cover the LED light bar included with the electric fireplace.
7. Any installation, labor, construction, transportation, or other related costs/expenses arising from defective part(s), repair, replacement, or otherwise of same, will not be covered by this warranty, nor shall the Company assume responsibility for the same.
8. The owner/user assumes all other risks – if any – including but not limited to the risk of any direct, indirect or consequential loss or damage arising out of the use, or inability to use the product, except as provided by law.
9. All other warranties – express or implied – with respect to the unit, its components and accessories, or any obligations/liabilities on the part of the Company are hereby expressly excluded.
10. The Company neither assumes, nor authorizes any third party to assume on its behalf, any other liabilities with respect to the sale of the unit.
11. The warranties as outlined within this document do not apply to non-accessories used in conjunction with the installation of this product.
12. This warranty gives you specific legal rights, and you may also have other rights which vary from state to state.

This warranty is void if:

- (a) The fireplace is subjected to prolonged periods of dampness or condensation.
- (b) Any unauthorized alteration, willful abuse, accident, or misuse of the product.
- (c) You do not have the original purchase receipt.

IF WARRANTY SERVICE IS NEEDED Please Contact Customer Service

 www.soupro.com  servicespi@sourceproinc.com  +1-844-455-4621

 Make sure you have the following information ready:

- Warranty
- Sales Receipt
- Product Model/Serial Number
- Date of Purchase
- Location of Purchase

Firebox Model

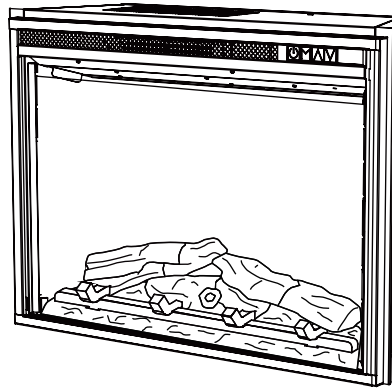

SP2320-IR-FGPB



ATTENTION:

- Find a location for the firebox that is protected from direct sunlight.
- Failure to read all instructions may result in a possible electric shock, fire hazard and/or injury and will void the warranty.



WARNING:

- If the information in this manual is not followed exactly, an electric shock or fire may result causing property damage, personal injury or loss of life.
- Do not store or use gasoline or other flammable vapors or liquids in the vicinity of this appliance.

FCC / IC Information

This equipment has been tested and found to comply with the limits for Class B digital devices, pursuant to part 15 of the FCC rules. These limits are designed to provide reasonable protection against harmful interference in a residential installation. The equipment generates, uses and can radiate radio frequency energy and, if not installed and used in accordance with the instructions, may cause harmful interference to radio or television reception, which can be determined by turning the equipment off and on. The user is encouraged to try and correct the interference by one or more of the following measures:

- (a) Reorient or relocate the receiving antenna
- (b) Increase the separation between the equipment and the receiver
- (c) Connect the equipment into an outlet on a circuit different from that to which the receiver is connected.
- (d) Consult the dealer or an experienced radio/TV technician for help.

This device complies with Part 15 of the FCC rules. Operation is subject to the following two conditions:

- (a) This device may not cause harmful interference, and
- (b) This device must accept any interference received, including interference that may cause undesired operation.

Modifications not approved by the party responsible for compliance could void user's authority to operate the equipment.

This Class B digital apparatus complies with Canadian ICES-003.

Safety Information



Use this firebox only as described in the manual. Any other use is NOT recommended by the manufacturer and may cause fire, electric shock or injury to persons.

CAUTION:

- If possible, ALWAYS unplug this firebox when not in use.
- DO NOT operate any firebox with a damaged cord or plug or after the heater malfunctions.
- DO NOT operate any firebox if it has been dropped or damaged in any manner. Disconnect power at service panel and have firebox inspected by a reputable electrician before reusing.
- Any repairs to this unit should be carried out by appropriately qualified service personnel.
- Under no circumstances should this unit be modified. Parts having to be removed for servicing must be replaced prior to operating this unit again.
- DO NOT use outdoors.
- This unit is not intended for use in bathrooms, laundry areas and similar indoor locations. NEVER place heater where it may fall into a bathtub or other water container.
- To disconnect this unit, turn all controls to the OFF position, then remove plug from outlet.
- ONLY connect to properly grounded outlets.
- This appliance, when installed, must be electrically grounded in accordance with local codes, with the current CSA C22.1 Canadian Electrical Code or, for USA installations, follow the National Electrical Code, ANSI/NFPA NO.70.
- To prevent a possible fire, DO NOT block any air intakes or exhaust in any manner. DO NOT use on soft surfaces, like a bed, where opening may become blocked.
- ALWAYS plug this unit directly into a wall outlet/receptacle. NEVER use with an extension cord or relocatable power tap (outlet/power strip).
- This heater includes an automatic protection system that will shut off the unit to prevent overheating. If the unit is at risk of overheating, the front panel will display "E1" and a thermal cut out will shut off the heater to prevent damage or risk of fire.
- DO NOT slide firebox on top of wood to avoid scratching wood surface.
- DO NOT place any objects on top of firebox and top air intake vents as this will cause the unit to overheat and can cause a fire.

ELECTRICAL CONNECTION:

- A 15-amp, 120-volt, 60 Hz circuit with a properly grounded outlet is required. Preferably, the fireplace will be on a dedicated circuit as other appliances on the same circuit may cause the circuit breaker to trip or the fuse to blow when the heater is in operation. The unit comes standard with 6-ft. three-wire cord, exiting from the rear of the fireplace. DO NOT exceed the current rating of the current tap. ALWAYS plug this unit directly into a wall outlet/receptacle. NEVER use with an extension cord or relocatable power tap (outlet/power strip).
- This firebox is for use on 120 volts. The cord has a plug as shown below. See illustration for grounding instruction. An adapter as shown at C is available for connecting three-blade grounding type plugs to two-slot receptacles. The green grounding lug extending from the adapter must be connected to a permanent ground such as a properly grounded outlet box. The adapter should not be used if a three-slot grounded receptacle is available.

ELECTRICAL SPECIFICATIONS

Voltage:	120 VAC, 60 Hz
Amps:	12.5 Amps
Watts:	1500 Watts

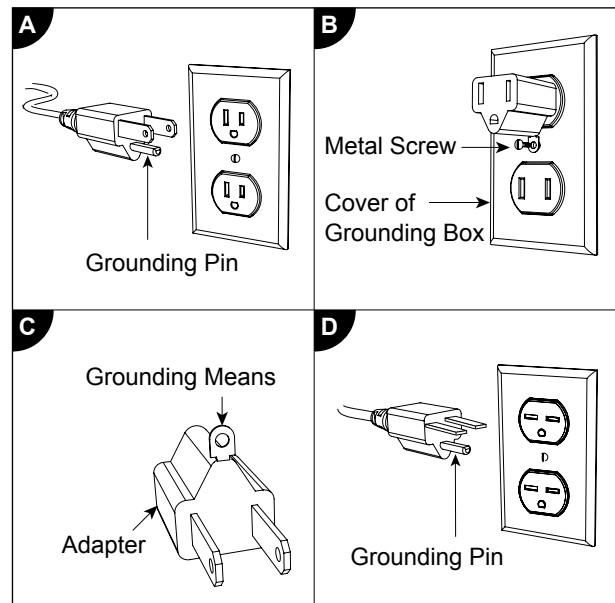

Operating Instructions //

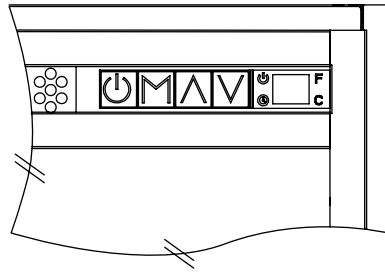

Power Button

- Press the POWER button to turn ON or OFF the unit.
- When the unit is in ON mode, the power icon indicator light will be shown green.
- When the unit is in OFF mode, the power icon indicator light will be shown red. When power OFF, unit will be stopped, if heater is working before power OFF the unit, fan will have 20 seconds delay to ensure heat will not be trapped inside the unit.

 Each time the firebox is plugged in, a 5-second fan and heater will turn on for internal check program.

The unit has a memory function with last settings for heating level and flame brightness effect, unless the main power to the unit has been interrupted.

Mode Button

- Press the MODE button to cycle through the different functions. Each time the MODE button is pressed, the mode will enter the next function – Temperature, Timer or Flame Brightness.

Temperature Mode

- The Temperature Mode controls the heater's thermostat setting.
- Press UP arrow button or DOWN arrow button to scroll through temperature settings: 59°F – 86°F (15°C – 30°C), ON, OF (OFF).
- Hold the MODE button for 3 seconds; this toggles the temperature unit between °C or °F.

 This function is only available if using the control panel.

- When the ambient temperature is higher than the set temperature, heater will turn off automatically.

Timer Mode

- The Timer Mode sets the fireplace to automatically shutoff.
- Press UP arrow button or DOWN arrow button to adjust the timer setting from 0 hour (OFF) to 9 hours with 0.5 hour intervals.

Flame Brightness Mode

- The Flame Brightness Mode sets the flame brightness.
- Use UP arrow button or DOWN arrow button to scroll through the flame brightness settings: F0 (no flame), F1, F2, F3, F4, F5 (brightest).

Up Arrow Button

- Use UP arrow button to increase the setting of the selected function.

Down Arrow Button

- Use DOWN arrow button to decrease the setting of the selected function.

Child Lock

Activate Child Lock

- When the unit is ON, hold the POWER button for 10 seconds to activate the Child Lock function. "E3" will be displayed and a "beep" will sound 3 times to indicate the Child Lock function is activated. Then, all function keys are locked. When pressing any button, "E3" will be displayed to indicate the Child Lock function has been activated.

Deactivate Child Lock

- To deactivate the Child Lock function, hold the POWER button for 10 seconds. Then, all functions keys are unlocked.

 Child Lock function is only available if using the control panel.

Care And Maintenance //

CLEANING INFORMATION:

- Make sure the unit is turned off, unplugged and the heating elements of heater are cool whenever you are cleaning the heater.
- Clean the metal trim using a water-dampened, soft, and clean cloth. DO NOT use brass polish or household cleaners as these products will damage the metal trim.
- The motors used on the fan and the flame generator assembly are pre-lubricated for extended bearing life and require no further lubrication. However, periodic cleaning/vacuuming of the fan/heater and air intake/output vents is recommended.

 **WARNING:** Make sure the power is turned off before proceeding. Any electrical repairs or rewiring of this unit should be carried out by a licensed electrician in accordance with national and local codes.

If repairing or replacing an electrical component or wiring, the original wire routing, color coding and securing locations must be followed.

 **WARNING:** Electrical outlet wiring must comply with local building codes and other applicable regulations to reduce the risk of fire, electrical shock and injury to persons.

 **WARNING:** Do not use this fireplace if any part of it has been under water. Immediately call a qualified service technician to inspect the fireplace and replace any part of the electrical system.

 **WARNING:** Disconnect the power before attempting any maintenance or cleaning to reduce the risk of fire, electrical shock or personal injury.

 **WARNING:** During any service of this appliance, the power to the unit must be turned off. First turn the main power switch to the "OFF" position. Then remove the electrical plug from the wall outlet.

 **NOTE:** When the heater is not in use, it should be stored in a dry location, away from possible damage. The power cord should be stored properly to avoid contact with hot or sharp objects.

REPLACING THE REMOTE CONTROL BATTERY:

When the remote control stops operating or its range seems reduced, it is time to replace the batteries.

 **NOTE:** The batteries should be removed if the product is to be left unused for a long time.

CAUTION:

Non-rechargeable battery is not to be recharged. Exhausted battery is to be removed from the product:

1. The battery compartment is located on the back end of the remote control.
2. Press the small tab inward as you slide the battery door open and remove the old battery.
3. Insert a new CR2025 lithium battery (not included), ensuring the polarities of the battery match the inside of the battery compartment.
4. Re-insert the battery door.

WARNING - KEEP BATTERIES OUT OF REACH OF CHILDREN

1. Swallowing may lead to serious injury in as little as 2 hours or death, due to chemical burns and potential perforation of the oesophagus.
2. If you suspect your child has swallowed or inserted a button battery, immediately seek urgent medical assistance.
3. Examine devices and make sure the battery compartment is correctly secured, e.g that the screw or other mechanical fastener is tightened. Do not use if compartment is not secure.
4. Dispose of used button batteries immediately and safely. Flat batteries can still be dangerous.
5. Tell others about the risk associated with button batteries and how to keep their children safe.



Care And Maintenance //

DISPOSAL OF USED BATTERY:

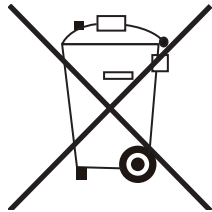

A battery may contain hazardous substances that could be endangering to the environment and human health.

- This symbol marked on the battery and/or packaging indicates that used battery shall not be treated as municipal waste. Instead it shall be left at the appropriate collection point for recycling.
- By ensuring the used battery is disposed of correctly, you will help prevent potential negative consequences for the environment and human health. The recycling of materials will help to conserve natural resources.

For more information about collection and recycling of used batteries, please contact your local municipality, your waste disposal service or the point of sale where you purchased this item.

Troubleshooting //

Problems	Possible Causes	Solutions
1. No power, logs do not glow.	1. The unit does not have power.	1. Check that unit is plugged into a standard 120 volt outlet. Then make sure power is set at "ON" position.
2. "E1" is displayed on control panel.	2. The overheat protection device has been engaged.	2. Unplug unit, wait 5-10 minutes, then the sensor will reset itself. Plug the unit back in and turn on the heater. If the problem persists, call customer service.
3. "E2" is displayed on control panel.	3. The ambient temperature sensor is broken or not working correctly.	3. Unplug unit, wait 5-10 minutes, then the sensor will reset itself. Plug the unit back in and turn on the heater. If the problem persists, call customer service.
4. "E3" is displayed on control panel.	4. Child Lock function is activated.	4. To inactivate the Child Lock function, hold the POWER button for 10 seconds.
5. Fan motor continues to blow after unit is powered off.	5. Normal operation.	5. This is a standard feature; the blower runs for an additional 20 seconds to ensure heat will not be trapped inside the unit.
6. Power cord gets warm to the touch.	6. Normal operation.	6. This is normal for a heater appliance as it requires more current to operate. Check the connections of the appliance cord and the outlet. Make sure the plug fits tightly into the outlet. During use, check the plug and outlet frequently to determine if it is HOT; if so, discontinue use of the appliance and consult with a qualified electrician to check or change the overheating outlet(s).



QUESTIONS, PROBLEMS, OR MISSING PARTS?
Please Contact Customer Service Before Returning to Store

 www.soupro.com  servicespi@sourceproinc.com  +1-844-455-4621