

NEKSIA

ESSILOR TRACER-CENTERER-BLOCKER



User Manual

CONTENTS

INTRODUCTION	7
I. FIRST STEPS WITH NEKSIA	9
1. Descriptive diagrams	10
2. Connection to an edger	11
3. Using the tracer-centerer-blocker	12
a. Turn on and turn off the tracer-centerer-blocker	12
b. Using the touch screen and keypads	12
c. Work screen	14
II. TRACING	15
1. The tracing environment	16
a. Menu screen	16
b. Jobs and working modes	18
c. Displaying the binocular view	20
2. Shape management and storage	22
a. Menu screen	22
b. Job list	24
c. Creating a job	24
d. Working in current job mode (job A)	25
3. Tracing a rimmed frame	26
4. Tracing a high-base frame (option)	27
5. Tracing a pattern, demo lens or recut lens	30
a. Optical tracing (option)	30
b. Mechanical tracing	32
c. Inputting the curve and the frame base after monocular tracing	35
III. CENTERING	39
1. Centering environment	40
a. Menu screen	40
b. Call a shape (if the connection to Tess is activated)	42
c. Using the tripods	43
d. Centering modes	43
e. Centering help	44
2. Centering a single vision lens	44
3. Centering a progressive lens	47
a. Centering a progressive lens using re-marked micro-engravings	47
b. Centering a lens using manufacturer markings	50
4. Centering bifocal / trifocal lenses	52
5. Centering an executive lens	54
6. Centering a mid-distance lens	56
a. Centering a lens using re-marked micro-engravings	57
b. Centering a lens using manufacturer markings	59
7. Centering for a high-base frame	61
8. Blocking a lens	61
a. Preparing blocking	62

b. Block the lens	63
IV. MODIFYING THE LENS SHAPE	65
1. Menu screen	66
2. Modifying a shape	67
a. Enlarging, reducing or rotating a shape	67
b. Free-form modification	70
c. Retouching a shape	71
3. Archiving / saving a shape	72
V. PREPARING A DRILLED JOB	73
1. Legend screen	75
2. Configuring a drilling point	78
a. Creating a drilling point	78
b. Delete one drilling point	79
c. Dimensioning a drilling point	79
d. Adjusting the position of a drilling point	80
3. Drilling models	83
a. Importing a model	83
b. Saving a model	84
VI. PREPARING LENS EDGING	87
1. Menu screen	88
2. Edging configuration	90
VII. TRACER-CENTERER-BLOCKER CONFIGURATION	91
1. Configure the tracer-centerer-blocker	92
a. Time, date and language	92
b. Options	93
c. Connections	94
d. Screensaver and brightness of the work area	95
2. Customize the tracer-centerer-blocker,	96
a. Working modes and display precision	97
b. Decentration mode	98
c. Action bar	99
d. Brightness	101
3. Restoring the factory settings	102
VIII. MAINTENANCE & SERVICING	103
1. Carrying out the autotests	104
2. Check and calibrate (remote lens edging option)	105
a. Check and calibrate the tracing table (option)	105
b. Check and calibrate the blocking arm	108
c. Calibrate the touch screen	110
3. Make a backup of the jobs and display configuration	110
4. Statistics and technical history	113
a. Tracer-centerer-blocker statistics	113
b. Technical log and errors	114
5. Maintain and clean the tracer-centerer-blocker	115
a. Precautions required	115
b. Cleaning the centering chamber glass	115

TECHNICAL DATA	117
1. Tracer-centerer-blocker	118
2. Environment	119
GENERAL INFORMATION	121
1. Symbols	122
2. Modifications	122
3. Declaration of conformity	122
4. Copyright	123
5. Materials and products	123
6. Safety instructions:	123
7. Electromagnetic waves	124
GLOSSARY	125

INTRODUCTION

To take full advantage of the functions of your tracer-centerer-blocker, documentation is available in:

- the introduction guide provided at the time of installation
- the user manual, present on the CD-ROM

The screens may vary according to the edger connected to the tracer-centerer-blocker. This documentation was produced with a connection to the Neksia edger.

I. FIRST STEPS WITH NEKSIA

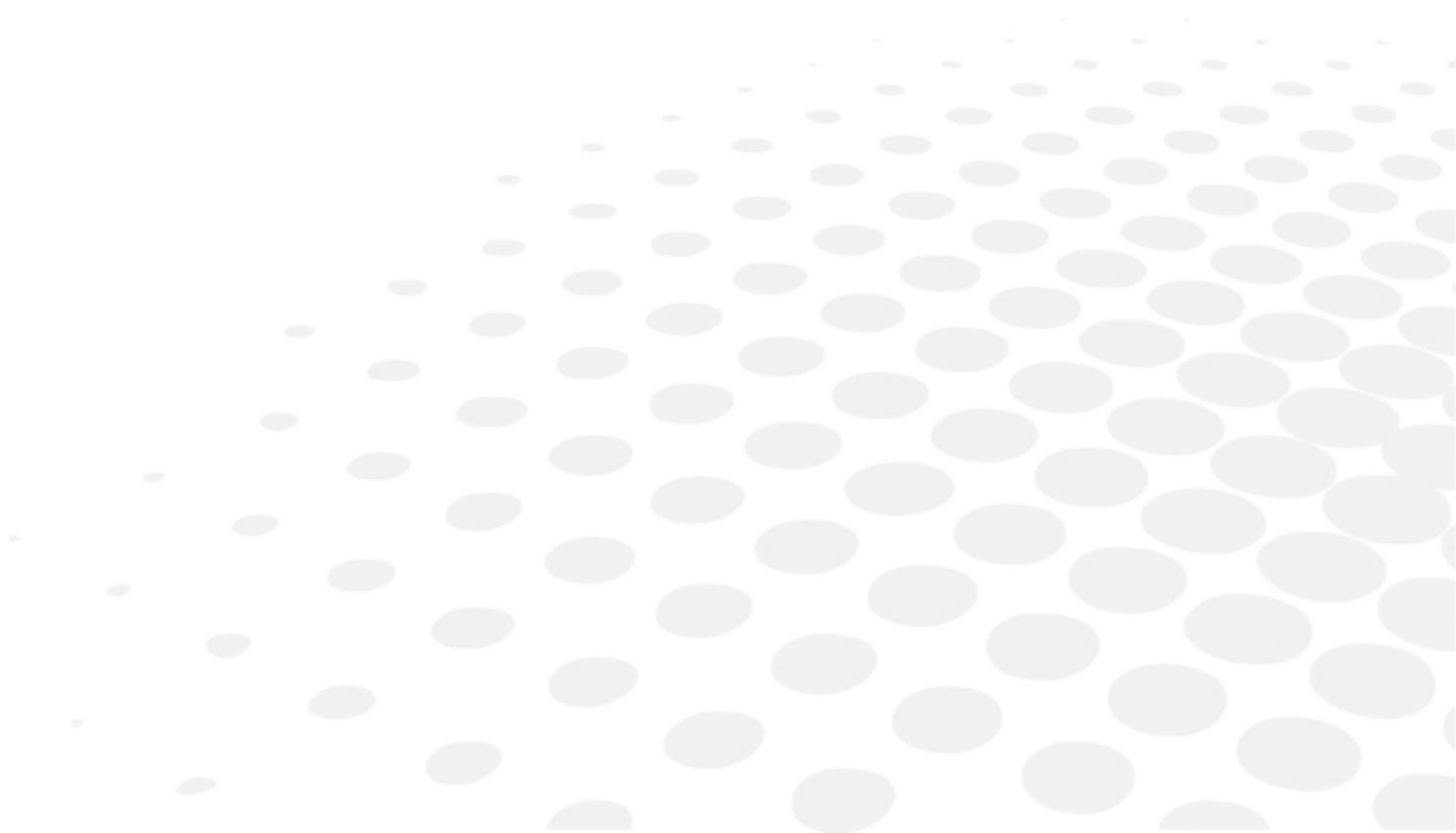

This chapter contains all the information concerning a first use of the tracer-centerer-blocker:

- description of the tracer-centerer-blocker (☞ p.10)
- connection to an edger (☞ p.11)
- using the device (☞ p.12)

1. DESCRIPTIVE DIAGRAMS

This section contains the descriptions and list of accessories of the tracer-centerer-blocker:

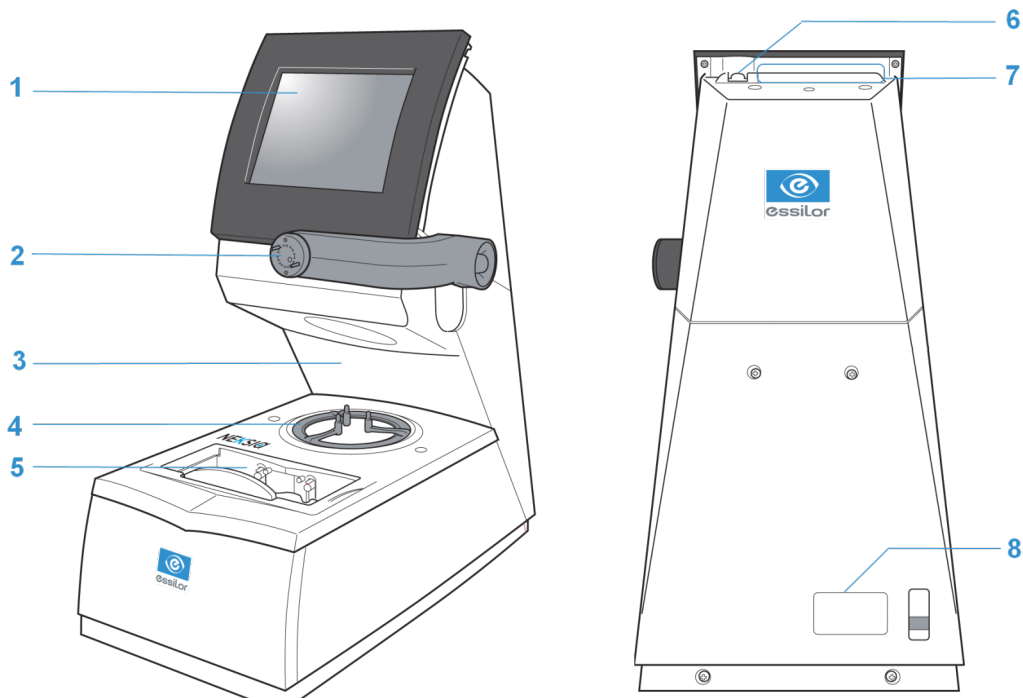

1. Screen
2. Blocking arm
3. Centering chamber
4. Tripod
5. Tracing table
6. ON/OFF button
7. Connectors
8. Manufacturer plate

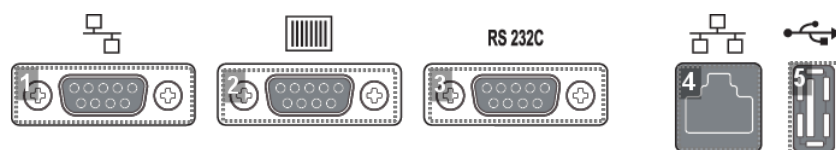

1. RS232 (edger) port
2. Barcode reader port

3. RS232 (PC) port



4. RJ45 Ethernet port

5. USB port

Accessories

Transport wedges to be kept

Use accessories

- Tripod 
- Recut lens tripod 
- Stylus
- White felt tip marker
- Staedler permanent felt-tip pen
- Bag of 22 mm posiblocks
- Bag of 18x14 mm posiblocks
- Roll of 22 mm pads
- Roll of 18x14 mm pads

Tracing table accessories

- Pattern holder
- Pattern holder tip and holding screw
- Set of 2 small B-dimension wedges

Options

- Barcode reader
- Roll of barcode labels
- Table calibration pack

Connection accessories

- 220 V power cable
- RJ45 cable for the tracer-edger connection

2. CONNECTION TO AN EDGER

To connect the tracer-centerer-blocker to an edger, use the RJ45 cable (Neksia/Mr Orange edgers) or RS232 cable (Jess/Jessie /JessD/Kappa edgers) provided with the edger.

For the RS232 cable, refer to the labels indicating the direction of connection.

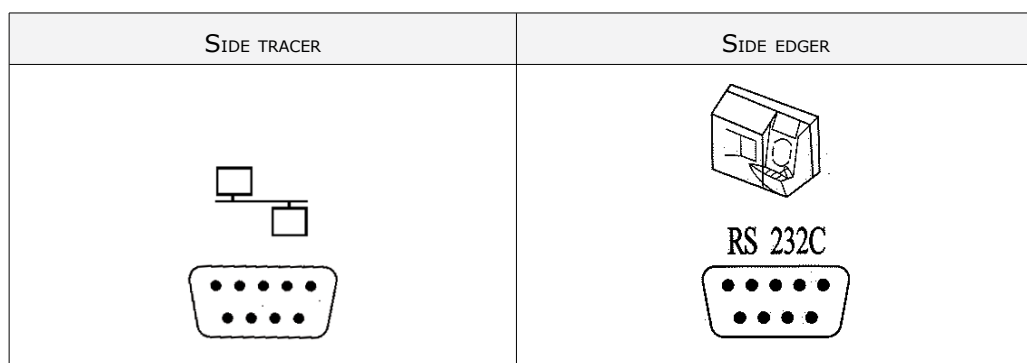

3. USING THE TRACER-CENTERER-BLOCKER

In this section, you will find all the information concerning the following:

- turning the tracer-centerer-blocker on and off, ([p.12](#))
- use of the touch screen and keyboards ([p.12](#)),
- description of the work screen ([p.14](#)).

a. Turn on and turn off the tracer-centerer-blocker

Switching on



1 Press the ON/OFF button located at the top right on top of the screen.

- > The tracer-centerer-blocker is initialized.
- > A beep indicates that initialization was successful.

The tracer-centerer-blocker is ready to be used when the initial screen is displayed.

Switching off

1 Press:

- briefly on the ON/OFF button, located at the top right at the top of the screen or
- on  > , from the work screen.



Do not press on the ON/OFF button for several seconds. This would result in shut-down of the machine and an error message would be displayed at the next switch-on.

- > A confirmation message is displayed.

2 Select  to confirm.

- > The tracer-centerer-blocker is switched off.



Extended period of non-use

During a prolonged period of non-use (several days), it is preferable to turn off the tracer-centerer-blocker by unplugging the mains power supply.

b. Using the touch screen and keypads

Using the touch screen

Use the stylus on the touch screen.

You can also touch the screen with your finger.

- If the response area does not correspond to the position of the key, you need to calibrate the touch screen. For further information, refer to the section Maintenance and servicing > Check and calibrate > Calibrate the touch screen (☞ p.110).



- Never press hard on the screen as this could break it.
- Never press on the screen with sharp objects such as pens, scissors, clamps, etc.
- Screen breakage is not covered by the guarantee.





On each screen, press the icon-buttons to access the desired menus and functions.

Using the keypads



When you need to input or modify data, two types of keypads are automatically displayed, according to the information to be input.

- The numeric keypad is displayed for the input of values.



-  Reset the fields
-  Back
-  Confirm
-  Cancel and go back to the work screen
- The alphanumeric keyboard is displayed for storing, calling and searching for jobs.



-  Job ID 
-  Job reference (alphanumeric characters)

c. Work screen

At the end of initialization of the tracer-centerer-blocker, the following screen is displayed:

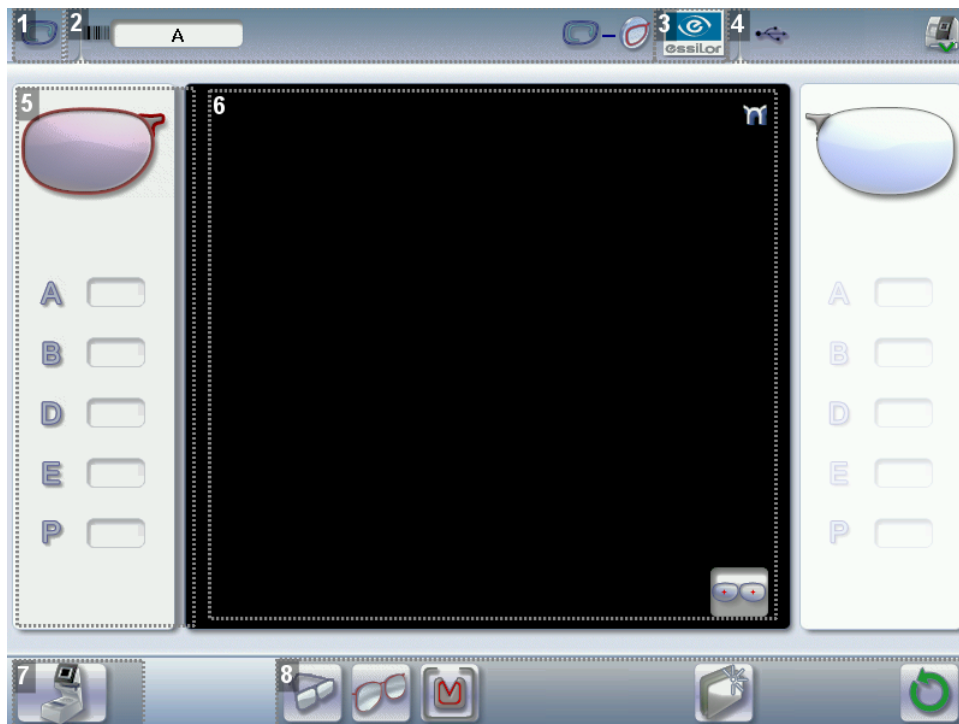

1. Work screen indicator
2. Job information
3. Settings
4. Devices connected
5. Active eye and information on the shape
6. Work area
7. Function buttons
8. Actions available for the current screen



Detailed functions

For more information, consult the section Perform a trace > Tracing environment > Captioned screen.

(☞ p.40)

II. TRACING

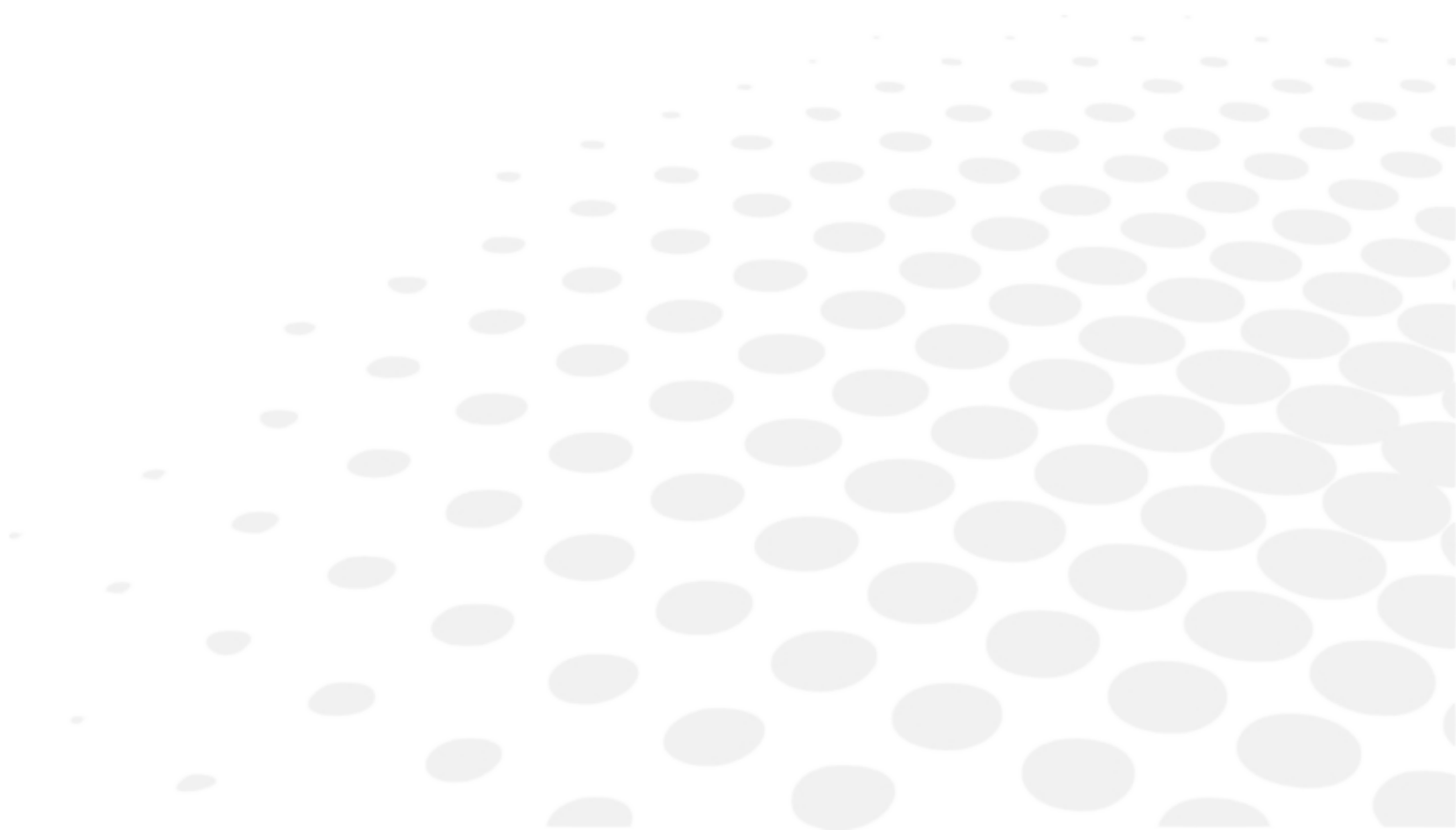

This chapter describes the procedures for the tracing of all types of frames, patterns, demo lenses and recut lenses:

- Description of the tracing environment (☞ p.16)
- Manage and store shapes, (☞ p.22)
- Trace a rimmed frame (☞ p.26) (including high-base frame)
- Trace a high-base frame (☞ p.27)
- Trace a pattern, demo lens or recut lens (☞ p.30).

1. THE TRACING ENVIRONMENT

This section describes the tracing screen and explains how to manage the jobs:

- description of the tracing screen, (☞ p.16)
- jobs and working modes (☞ p.18)
- displaying the tracing completed in binocular mode (☞ p.20)

a. Menu screen

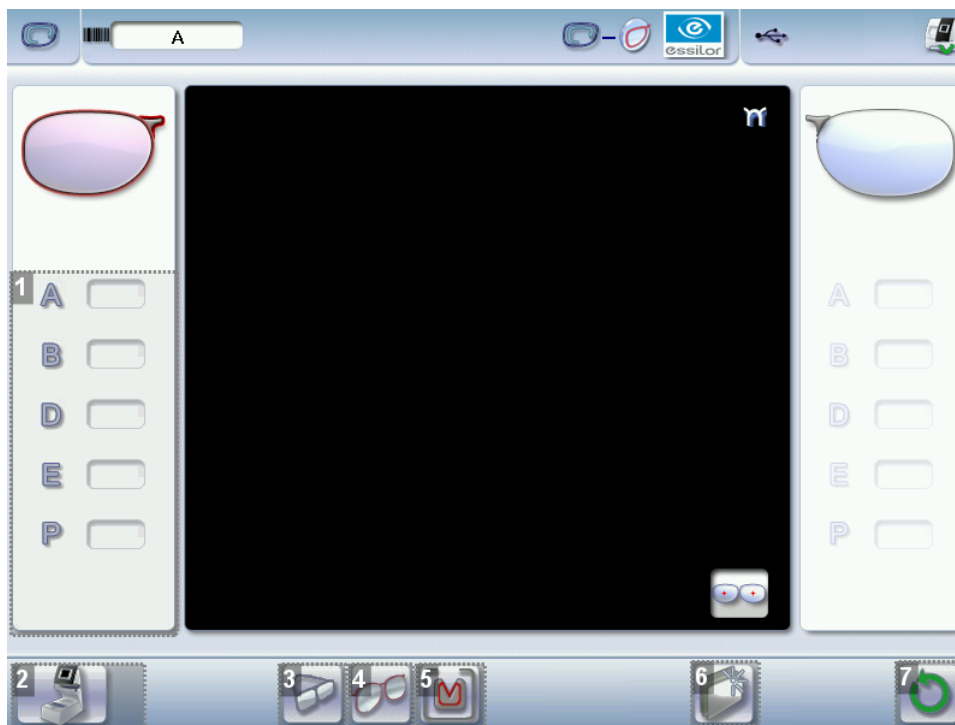



1. Dimensions display



- A: A-dimension
- B: B-dimension
- D: D-dimension
- E: Greater radius from the boxing center
- P: Perimeter

2. Function buttons









-  Tracing
-  Centering

-  Edging preparation
-  Shape management
-  Machine shutdown

3. Tracing mode



-  Rimmed frame (including high-base frame)
-  High-base frame (option)
-  Optical tracing (option) (patterns, demo lenses or recut lenses)

4. Type of tracing



-  Symmetric binocular tracing 
-  Asymmetric binocular tracing 
-  Right-eye monocular tracing
-  Left-eye monocular tracing
-  Single monocular tracing of the right eye (blocking and possible edging of the right eye only)
-  Single monocular tracing of the left eye (blocking and possible edging of the left eye only)

5. Frame material or optical tracing type

For mechanical tracing:

-  Metal frame: high-precision tracing, with feeling of the groove cross-section
-  Plastic frame
-  Optyl frame, for particularly flexible frames

For optical tracing (option):

-  Demo lens / Recut lens
-  Pattern

For mechanical tracing of demo lenses, recut lenses or patterns, the tracer automatically detects the pattern holder inserted in the tracing table.

6. New Job

For more information on jobs , refer to the section Tracing > Shape management and storage ( p.22).

7. Tracing cycle initialization

|

 Always browse from left to right: depending on your selection, certain menus will be available while others will not.

 You can activate or deactivate types of tracing in the configuration screen.

b. Jobs and working modes

Jobs

A 'job' incorporates all the necessary actions for assembling a pair of glasses. It can be managed in two ways:

- saving: allocate an ID and a reference to the job to save it and re-use it later.
 - Automatic job archiving
 - Mandatory in the tracing - tracing work mode
- without saving: working in current mode (job identification by the letter A) makes it possible to process a job quickly without saving it. It is necessary to complete the treatment cycle of the current job before starting a new one.

Working modes

There are four working modes for managing your jobs:

- tracing - centering - preparing edging mode
- tracing - preparing edging - centering mode (by default)
- tracing - tracing - centering - preparing edging mode
- tracing - tracing - preparing edging - centering mode

The selected work mode is shown in the information bar, to the left of the Essilor logo. You can change it in the tracer settings.

Working in tracing - centering - preparing edging mode

 At the end of a tracing, the tracer-centerer-blocker displays the centering screen automatically then the edging preparation screen.

You can fully process a job before proceeding to the following:

1. tracing or retrieving a job from the database
2. changing the shape and drilling position if necessary
3. centering
4. lens blocking
5. edging preparation

To activate this working mode, select the following parameters in the configuration screen: ( p.97)

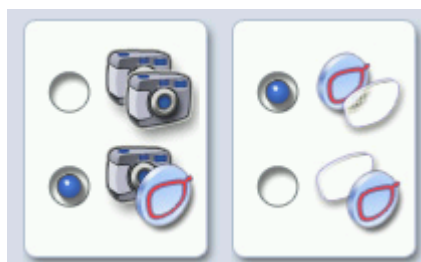

Work in tracing - preparing edging - centering mode

 At the end of tracing preparation, the tracer-centerer-blocker automatically displays the edging preparation screen then the centering screen and proposes the posiblock adapted to the prepared edging.

1. Tracing or recovering a job from the database
2. Edging preparation
3. Changing the shape and drilling position if necessary
4. Centering
5. Lens blocking

To activate this working mode, select the following parameters in the configuration screen ([p.97](#)):

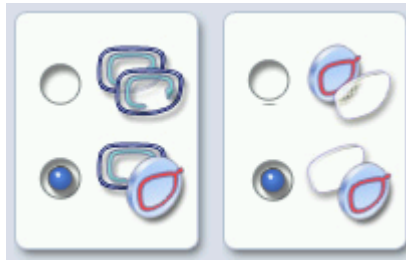

Work in tracing - tracing - centering - preparing edging mode

 At the end of a tracing, the tracer-centerer-blocker displays the tracing screen.

- You can perform several tracings in succession.
- The tracings are saved under the job number that you have assigned to them.
- Shape modification, centering, blocking and edging preparation are processed later.
- All jobs must be saved.
- After a job call the centering screen appears automatically, followed by the edging preparation screen.
- You can access the centering screen at any moment to centre the lens that corresponds to the active shape:

> select  then .

To activate this working mode, select the following parameters in the configuration screen: ([p.97](#))

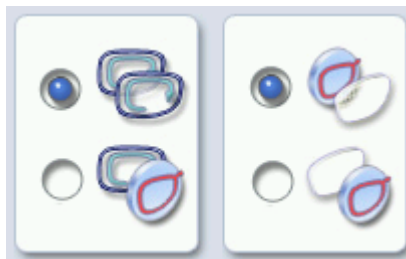

Work in tracing - tracing - preparing edging - centering mode

 At the end of a tracing, the tracer-centerer-blocker displays the tracing screen.

- You can perform several tracings in succession.
- The tracings are saved under the job number that you have assigned to them.
- Shape modification, edging preparation, centering and blocking are processed later.
- All jobs must be saved.

- After a job call the edging preparation screen appears automatically, followed by the centering screen.
- You can access the edging preparation screen at any time:

> select  then .



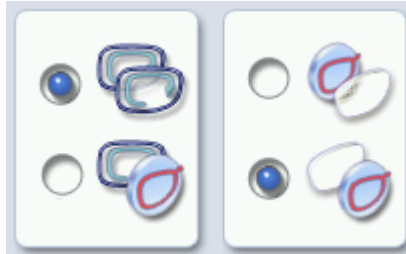

To activate this working mode, select the following parameters in the configuration screen: ( p.97)



c. Displaying the binocular view

Once the tracing is finished, you can display a binocular representation of the job on a 1:1 scale, in order to check the frame shape and centering.

Three values are displayed above the image:

-  the frame base 
-  the curve angle 
-  the frame thickness

The  indicator symbolizes the wearer side view.

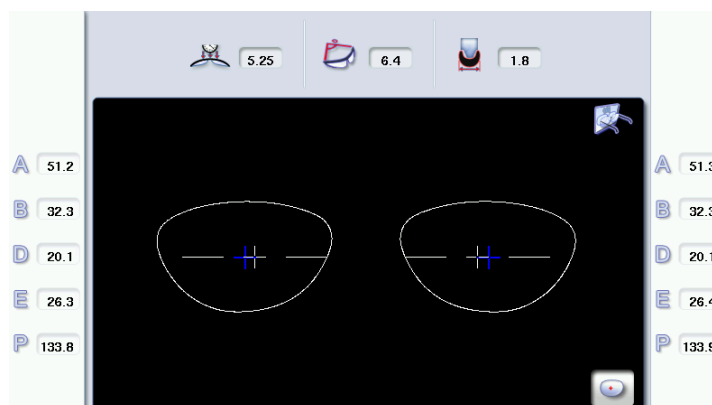

In tracing - centering mode, the centering screen is displayed at the end of the tracing:

1 Select  then  to access the tracing screen.



 The monocular view is displayed by default.

2 Press  to display the binocular view.

> The binocular view is displayed.

3 Position the frame in front of the screen, against the faceplate to check its shape and centering.



4 Press  to return to the monocular screen.

5 Select  then  to go back to the centering screen.



Tracing - tracing mode

The centering screen is displayed again once tracing is complete:

1. Press  to display the binocular view.
> The binocular view is displayed.
2. Position the frame in front of the screen, against the faceplate to check its shape and centering.
3. Press  to return to the monocular screen.

2. SHAPE MANAGEMENT AND STORAGE

This section explains how to manage the job list to store your shapes.





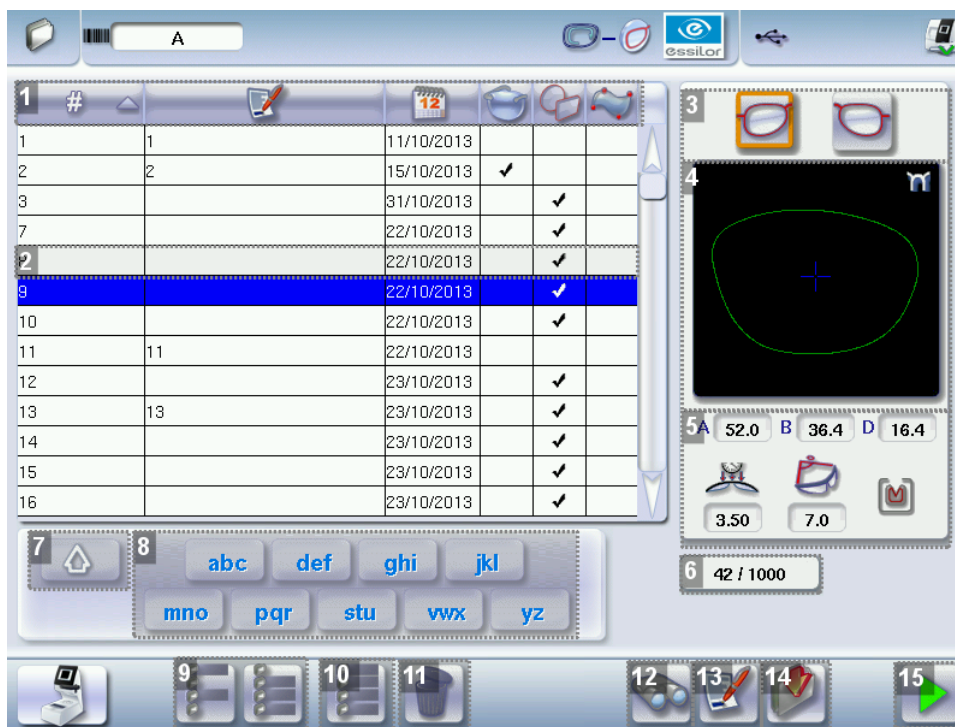

- Description of the shape storage screen (☞ p.22)
- Job list (☞ p.24)
- Creating a job (☞ p.24)
- Working in current job mode (job A) (☞ p.25)

a. Menu screen

From the tracing screen or centering screen, press  then  to access the shape storage screen.



1. Sort the jobs

-  ID
-  Reference
-  Date
- Types of jobs:
 -  Drilled
 -  Asymmetric tracings
 -  Creative shapes

2. Selected job

3. Select the eye to be displayed in the preview

4. Shape preview

5. Information concerning the lens shape and frame

- A, B and D dimensions
- Frame base
- Curve angle
- Material of the frame / pattern / demo lens or recut lens

6. Jobs counter



7. Return to the default display

8. Display all jobs starting with the selected letter

To display the all jobs starting with the selected letter:

- Press once if it is in the first position on the button,
- Press twice in succession if it is in the second position,
- Press three times in succession if it is in the third position.

Example:

- Press 3 times on the  button to display all jobs starting with the letter R.
 - > The R goes into upper case: .
 - > The jobs starting with the letter R are displayed.

9. Select several jobs

- Press  to select several non-consecutive jobs in the list.

Example: Press on the button then select jobs #1, #5, #7.

> Only jobs #1, #5 and #7 are selected.

- Press  to select a group of consecutive jobs in the list, then select the first and the last of the group.

Example: Press on the button then select jobs #1 and #10.

> All jobs from #1 to #10 are selected.

10. Select all jobs

Press  to select all jobs for the search in progress.

11. Delete the selected job(s)

Press  to delete the selected job(s). A confirmation message is displayed.

12. Search for a job by ID or by reference

13. Rename the selected job

14. Duplicate the selected job

15. Call the selected shape to the work area

b. Job list

The job list enables you to save jobs on a daily basis. It can store up to 1,000 jobs.

c. Creating a job

There are several ways of creating a job:

- Scan the barcode corresponding to the desired ID using the barcode reader (optional): the job is saved to the job list.
- To create a job, use the alphanumeric keypad and follow the procedure below.

1 From the tracing screen, press  in the action bar to create a new job.

> The alphanumeric keypad is displayed.



For more information on entry and use of the keyboard, refer to the section First steps > Using the tracer-centerer-blocker > Using the touchscreen and keypads ([p.12](#)).

2 Press  to enter the new job ID.

The ID is automatically allocated by the tracer-centerer-blocker (first free place in the selected list). You can modify it: the ID can consist of alphanumeric characters.

3 Press  to enter the reference of the new job.



The reference may consist of alphanumeric characters. It can contain the information of your choice:

- Customer's name
- Frame brand or reference
- Manufacturer, etc.

4 Press on  to confirm.

> The tracing screen is displayed, the allocated ID appears in the information bar.



5 The tracer-centerer-blocker is ready for tracing. For further information, refer to the section concerning your job type.



- > The  symbol is displayed at the bottom right of the job ID while the job is being modified. It disappears once the job has been saved.

If you don't want to save the job, you can work in current job mode. For more information, refer to the section Tracing > Shape management and storage > Working in current job mode (job A) ([☞ p.25](#)).

Successive tracings and saving.

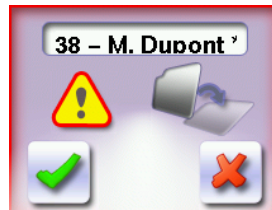
If you start a new tracing while a job is still active on the tracing screen, a message is displayed:



-  Replacement of the active shape: the tracing you have just started replaces the former one under the current ID.
-  Creation of a new job: the alphanumeric keypad is displayed, you can create a new job for the tracing you have just started (new ID). The two jobs are thus saved.

To cancel, press  again.

d. Working in current job mode (job A)

- As soon as the tracer is initialised, you can work in current job mode: the letter A is displayed by default in the information bar. The job is not saved.
- If you want to save job A, see the job creation procedure ([☞ p.24](#)).
- If you want to go back to job A after working on a saved job:
 - scan barcode A using the barcode reader (option),
 - use the numeric keypad and follow the procedure below.

1 From the tracing screen, press  in the action bar to create a new job.

- > The alphanumeric keypad is displayed.



For more information on entry and use of the keyboard, refer to the section First steps > Using the tracer-centerer-blocker > Using the touchscreen and keypads ([☞ p.12](#)).

2 Press  to select the ID field.

3 Press  to delete the ID.

4 Press on  to confirm.

> The letter A  is displayed in the information bar.

5 The tracer is ready for tracing.

For further information, refer to the section concerning your type of job.



3. TRACING A RIMMED FRAME

 Prerequisite:

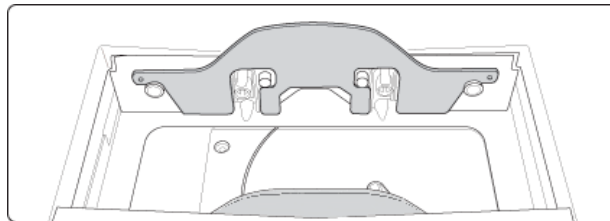
- For correct tracing of the shape, the frame to be traced must not be deformed and its hinges must be closed.
- For a small frame, place the two wedges between the tracing table clamps:



This section describes the procedure to follow for tracing rimmed frames including high-base frames:

- symmetric binocular  mechanical tracing of a rimmed frame
- asymmetric binocular  tracing of a rimmed frame
- monocular tracing of a rimmed frame
- monocular tracing to cut only one lens of a rimmed frame

1 Place the frame in the tracing table, between the two clamps located opposite you.

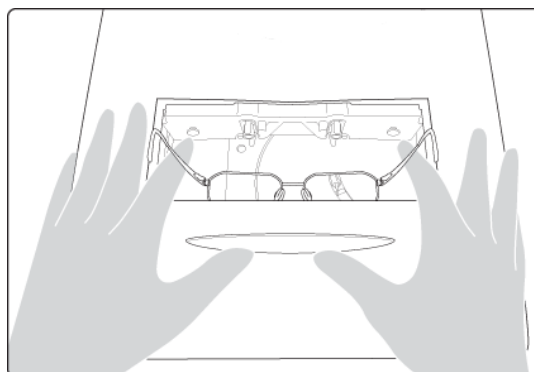

2 Gently close the jaw to hold the frame.



Optyl frames: take care not to flatten the frame by closing the jaws.

3

Press  to select the type of rimmed frame.

4

Select the required type of tracing.

5

Select the frame material.

6

Press on  to start the tracing cycle.



To interrupt tracing at any time, press .

- > If you selected a monocular tracing, the numeric keypad is displayed. Enter the value of the D-dimension, then press  to confirm.
- > The tracing result is displayed in the centering screen, in monocular format on a 1:1.6 scale.



Tracing - tracing mode

In tracing - tracing mode, the result of the tracing is displayed in the work area of the tracing screen. For more information on working modes, consult the section Perform a trace > Tracing environment > Jobs and working modes ([p.18](#)).

Before Centering

If you want to add drilling points to your lenses, refer to the section Preparing a drilled job ([p.87](#)).

4. TRACING A HIGH-BASE FRAME (OPTION)

This specific procedure enables you to trace a high-base frame, if the standard rimmed frame tracing fails.

Tracing of a high-base frame is done in two stages:

- The frame is placed in the tracing table and mechanical tracing is done for each eye individually.
- The curve angle is measured and the tracing is completed.



Put the frame in place and start the tracing

1

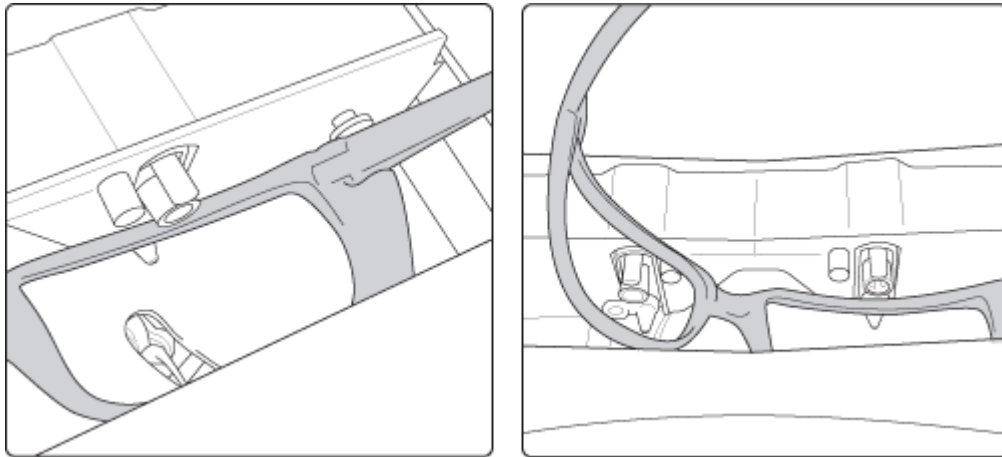
When you place the frame in the tracing table, position the eye as flat as possible: the black grips which hold the eye to be traced must be in the middle of the circle.





2 Gently close the jaw to hold the frame.

3 Press  to select the high-base frame type. .

4 Press  to select the first eye to be traced.

5 Select the frame material.

6 Press on  to start the tracing cycle.

 To interrupt tracing at any time, press .

> The numeric keypad is displayed.

7 Enter the value of the D-dimension, then press  to confirm.

> Once the tracing of the first eye is finished, a message is displayed:



8 Position the frame to trace the second eye.

9 Press  to start tracing the second eye.

> The following screen is displayed:

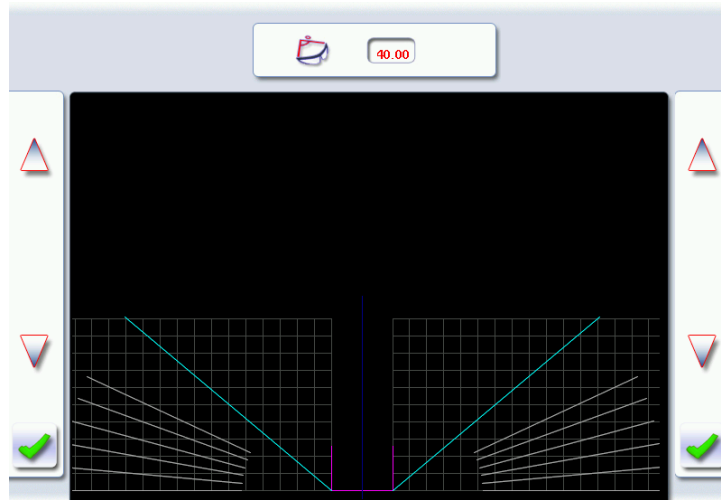



Measuring the curve angle and completing the tracing.

This screen enables you to measure the curve angle which cannot be captured in a monocular tracing.

1 Place the frame on the screen:

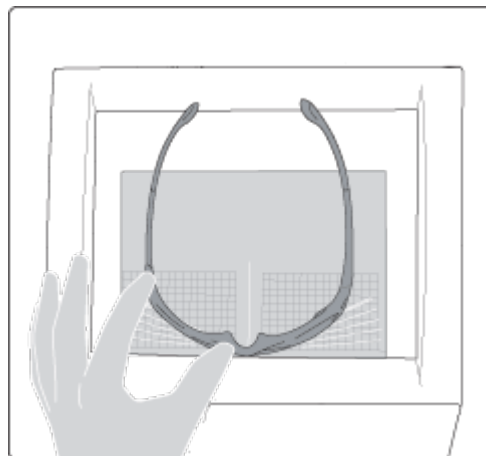
- the vertical line at the center of the frame,
- the bridge of the frame superimposed on the base line.



2 Use the  and  buttons to align the light blue lines with the nasal and temporal ends of the rims.

 You can also press for a few seconds on the value and change it using the numeric keypad.

> The value of the curve angle is modified.

3 Press on  to confirm.

> The tracing result is displayed in the centering screen, in monocular format on a 1:1.6 scale.



Tracing - tracing mode

In tracing - tracing mode, the result of the tracing is displayed in the work area of the tracing screen. For more information on working modes, consult the section Perform a trace > Tracing environment > Jobs and working modes ([p.18](#)).

Before Centering

If you want to add drilling points to your lenses, refer to the section Preparing a drilled job ([p.87](#)).

5. TRACING A PATTERN, DEMO LENS OR RECUT LENS

Two types of tracing are available for patterns, demo lenses and recut lenses: optical tracing and mechanical tracing. This section also presents the operations to be carried out to enter the curve angle and frame base which cannot be captured in this type of tracing.

- Optical tracing ([p.30](#))
- Mechanical tracing ([p.32](#))
- Inputting the curve and the frame base after monocular tracing ([p.35](#))

a. Optical tracing (option)

Preparing optical tracing of demo or recut lens

This type of tracing makes it possible to retrieve the existing shape and drilling data of a lens.



 Prerequisite: for the tracer to correctly detect the horizontality of the lens, the lens must be clean and marked using the permanent felt tip marker with:

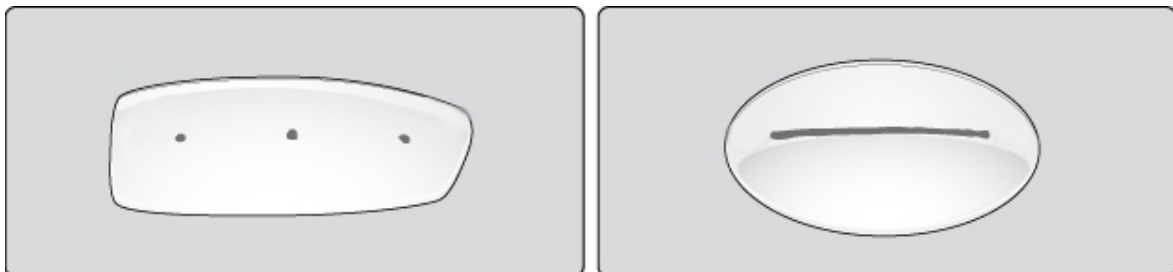

- either three focimeter dots,
- or a horizontal line which must not touch the edges of the lens (a space of at least 5 mm is required)





Tracing

1 Place the pattern or demo lens in the center of the centering chamber.

2 Press  to select optical tracing .

 The  icon appears: it is not clickable and indicates that you are in optical tracing.

3 Press  to indicate the eye to trace.

4 Press  to select the pattern or press  to select the demo or recut lens.

5 Press on  to start the tracing cycle.

> If the tracer does not detect either the focimer dots or the line on the lens an error message will be displayed: check and / or mark the lens again with the focimer dots or the line. If the tracing fails after the check, do a mechanical tracing using the pattern holder.

> The numeric keypad is displayed.

6 Enter the D-dimension value, then press  to confirm.

> The drilling screen is displayed.

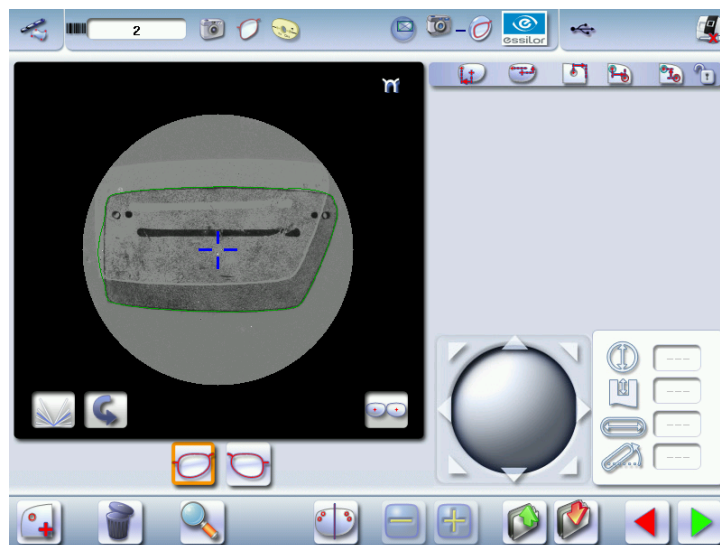

7 Configure the drilling settings if necessary.

For more information, refer to the section *Preparing a drilled job* (☞ p.73).

8 Press  to go to the centering screen.



Tracing - tracing mode

In tracing - tracing mode, the result of the tracing is displayed in the work area of the tracing screen.
For more information on working modes, consult the section *Perform a trace > Tracing environment > Jobs and working modes* (☞ p.18).

Before Centering

Once tracing has been carried out, you can:

- enter the curve angle and the frame base, for optimal centering precision
- add drilling to the shape. For more information, refer to the section *Preparing a drilled job* (☞ p.73).

b. Mechanical tracing

Detailed view of the pattern holder

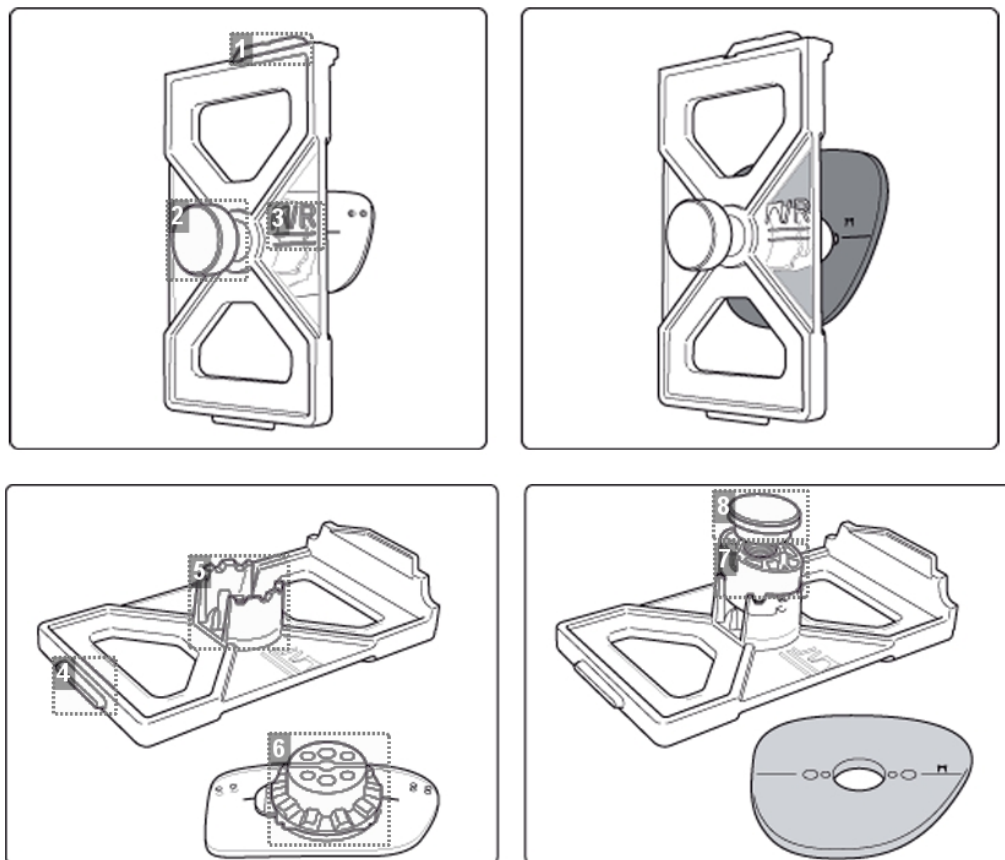

1. Front tab

2. *Knurled knob to screw*
3. *"Right nose" inscription*
4. *Back tab*
5. *Posiblock clamp*
6. *18x14 mm posiblock*
7. *Pattern-holder tip*
8. *Holding screw*

Attaching a recut lens or demo lens to the pattern holder

- 1 Block the lens in the boxing center, making sure it is properly centered.
- 2 Insert the blocked lens in the posiblock clamp, holding it in position with your index finger.
- 3 Press on the knurled button, screwing, until the blocked lens is immobilized.
 - > The lens is clamped.



As the feeling pressure on the lens is low, it is unnecessary to screw down the knurled button excessively.

Attaching a pattern to the pattern holder

- 1 Unscrew the screw holding the pattern-holder tip.
- 2 Fix the pattern on the pattern-holder tip:
 - nose to the right for a right lens, and to the left for a left lens
 - pattern-holder tip positioner towards the bottom of the pattern.
- 3 Align the marking $\overline{\text{TV/R}}$ (right nose) or $\overline{\text{TV/L}}$ (left nose) of the pattern holder with that of the pattern:
 - nose to the right for a right lens, and to the left for a left lens
 - pattern-holder posiblock positioner towards the bottom of the pattern
- 4 Press on the knurled knob, screwing it, until the pattern is immobilized (as for fixing a lens).
 - > The pattern is clamped.



Screwing of the knurled knob inside the tip posiblock has no functional impact on the latter.

Place the pattern holder in the tracing table

- 1 Insert the front tab of the support between the white cylindrical studs of the tracing table.

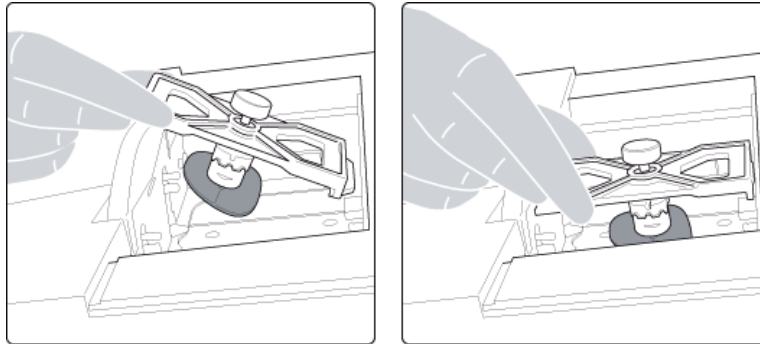

- 2 Block the back tab of the support.



Adjust the jaws of the tracing table so as to block the pattern holder.

- 3 Start the cycle.

- 4 Release the pressure on the white circles so the rear tab goes into the slit located opposite the cylindrical white pins (next to you - see illustration below).

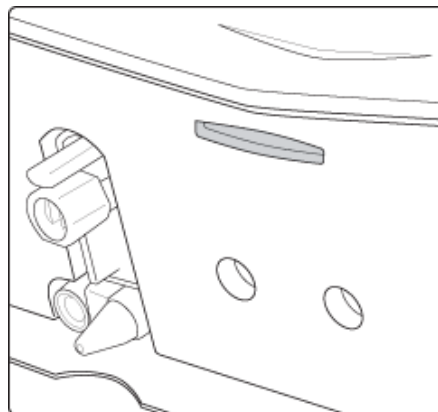

- 5 Check that the pattern holder does not move in the table.

Tracing

- 1 Press  to start mechanical tracing.



To interrupt tracing at any time, press .

> The tracer automatically detects the pattern holder.

> The buttons , ,  and  are displayed.

2 Select the eye to be traced.

> The numeric keypad is displayed.

3 Enter the D-dimension value, then press  to confirm.

> The tracing result is displayed in the centering screen, in monocular format on a 1:1.6 scale.



Tracing - tracing mode

In tracing - tracing mode, the result of the tracing is displayed in the work area of the tracing screen. For more information on working modes, consult the section Perform a trace > Tracing environment > Jobs and working modes ([☞ p.18](#)).

Before Centering

Once tracing has been carried out, you can:

- enter the curve angle and the frame base, for optimal centering precision
- add drilling to the shape. For more information, refer to the section Preparing a drilled job ([☞ p.73](#)).

c. Inputting the curve and the frame base after monocular tracing

In a monocular tracing, the curve angle and frame base cannot be measured. For optimal centering precision, we recommend that you enter those values after the optical or mechanical tracing of a pattern, recut lens or demo lens.



Prerequisite: before entering the curve angle and frame base, one of the following operations must be performed:

- Optical tracing of a pattern, a demo lens or a recut lens ([☞ p.30](#))
- Mechanical tracing of a pattern, demo lens or recut lens ([☞ p.32](#))

Input the curve angle and the frame base.

1 Press the  button.

> The following screen is displayed:

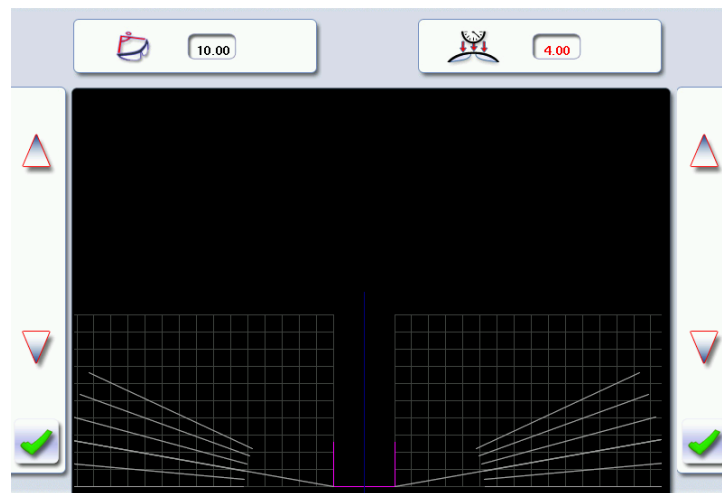



2 Select the curve angle value  to modify it.

> The value is displayed in red.

3 Place the frame on the screen:

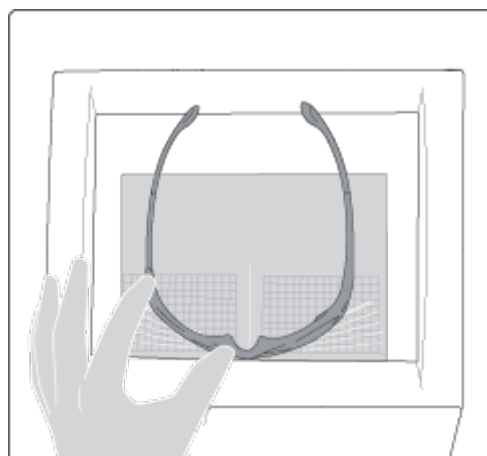
- the vertical blue line at the centre of the frame
- the bridge of the frame superimposed on the base line.



4 Use the  and  buttons to align the light blue lines with the nasal and temporal ends of the circles.





You can also press for a few seconds on the value and change it using the digital keyboard.

- > The curve angle value is changed.

5 Select the of frame base value  to modify it.

- > The value is displayed in red.

6 Use the  and  buttons to modify the frame base value.



You can also press for a few seconds on the value and change it using the digital keyboard.

7 Press on  to confirm.

III. CENTERING

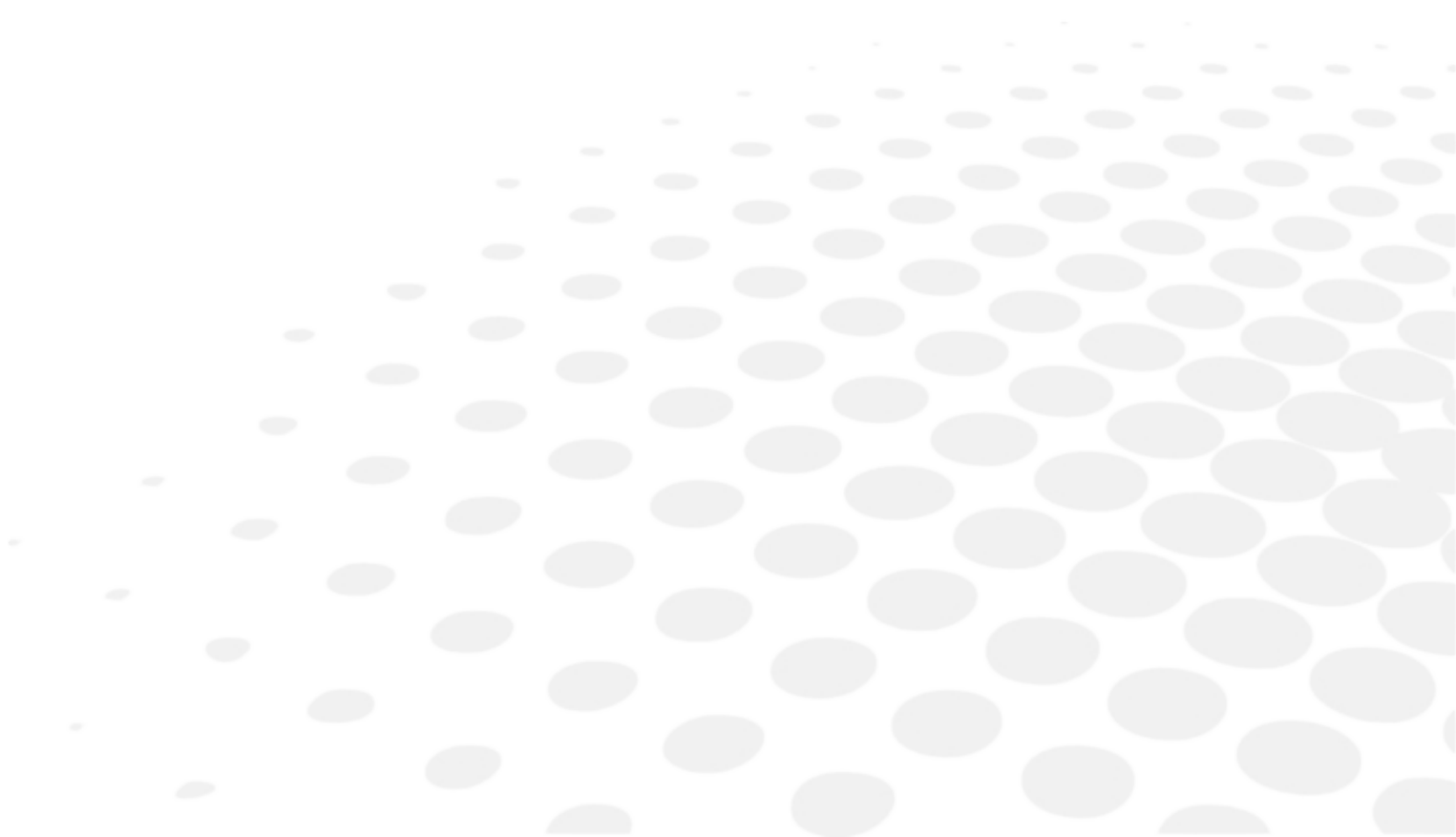

This chapter describes the lens centering procedures according to the type of lens.

- Description of the centering environment (☞ p.40)
- Centering a single vision lens (☞ p.44)
- Centering a progressive lens (☞ p.47)
- Centering a bifocal lens (☞ p.52)
- Centering an executive lens (☞ p.54)
- Centering a mid-distance lens (☞ p.56)
- Centering a lens for a high-base frame (☞ p.61)

This chapter also describes the lens blocking procedure.

1. CENTERING ENVIRONMENT

This section describes the centering screen and the various centering modes available:

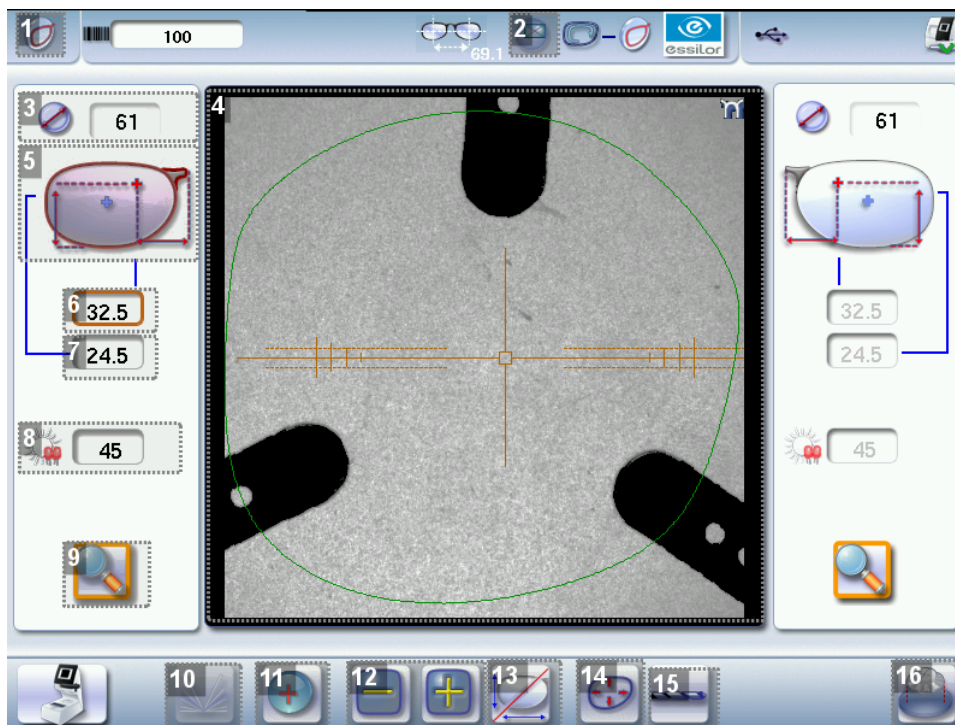

- Legend screen (☞ p.40)
- Job call (☞ p.42)
- Using the tripods (☞ p.43)
- Centering modes (☞ p.43)
- Centering help (☞ p.44)

a. Menu screen



1. Centering screen indicator





2. Blocking mode

-  Blocking in the boxing center
-  Blocking in the optical center

For further information, refer to the section Lens Centering > Blocking a lens > Preparing blocking (☞ p.62).

3. Minimal diameter of the lens to be used

4. Work area

-  : Nasal side indicator
-  (green) or  (cyan): Lens shape
-  (orange): Centering target according to the type of lens
-  (blue): Boxing center of the shape

5. Active eye and type of display of PD and pupillary height

Four modes available:

- Boxing mode
- Datum mode
- ΔY mode
- $\Delta X + \Delta Y$ mode

For more information on the type of display, consult the section Configuring the digital system > Customising the centerer-blocker > Decentration mode (☞ p.98).

6. Half PD

7. Pupillary height

8. Brightness adjustment

Enables you to improve the legibility of the lens markings, in particular for tinted lenses.

9. Zoom / scale 1:1

Enables you to go from the zoom mode display to the 1:1 scale.

The zoom is activated by default for a more precise centering.

To activate the display on the 1:1 scale by default, consult the section Configuring the centerer-blocker > Customising > Working modes and display precision (☞ p.97).

10. Entering the curve angle and frame base

11. Lens type selection

-  Single vision lens 
-  Progressive lens 
-  Bifocal lens 
-  Executive lens 
-  Mid-distance lens 

12. Value modification

Enables you to reduce or increase the previously selected value.

13. Toggle between the PD and pupillary height

14. Modification of the shape

Provides access to the shape modification screen. For more information, consult the following chapter Modifying the lens shape (☞ p.67).

15. Drilling preparation (option)

Provides access to the drilling screen. For more information, consult the chapter Preparing a drilled job (☞ p.73).

16. Blocking



- Automatic blocking (option): to start automatic lens blocking.
- Displays the type of posiblock to be used depending on the job.

For further information, refer to the section Lens Centering > Blocking a lens > Preparing blocking (☞ p.62).

b. Call a shape (if the connection to Tess is activated)

From the list of jobs (if the connection to the tracer is not activated)

There are two ways of calling a shape in the job list:





- Calling a shape via a barcode:
 - > scan the barcode using the barcode reader (optional).
- Call a shape by selecting it in the job list:
 - > From the tracing screen or the centering screen, press on the menu  then  to access the shape storage screen.
 - > You can then look for a job by ID, reference, date, job type (drilled, asymmetric tracings, creative shapes). For more information, consult the section Perform a trace > Management and storage of shapes>Legend screen (☞ p.22).



To activate the connection to Tess, consult the section Parameters > Connections. (☞ p.94)

On the tracer (if the connection to the tracer is activated)

There are 3 ways to call a traced job on a tracer and to carry out a job:

- Calling the current job:
 - > Press  to display the shape being processed on the tracer.
 - Job called saved on the tracer:
 - Press for a few seconds to  open the numeric keypad.
 - > You can then call a job by the ID  which was allotted to it.
 - Calling a shape via a barcode:
 - > scan the barcode using the barcode reader (optional).
- > A warning message is displayed.
- Press  to replace the job displayed by the job called.
 - Press  to cancel: the job is not transmitted to the tracer.

> The shape is displayed in the centering screen.

c. Using the tripods

Lens centering requires the use of a tripod¹.

Typical cases: if the standard tripod does not ensure an optimal stability of the lens, a recut lens tripod¹ equipped with adjustable studs is available.

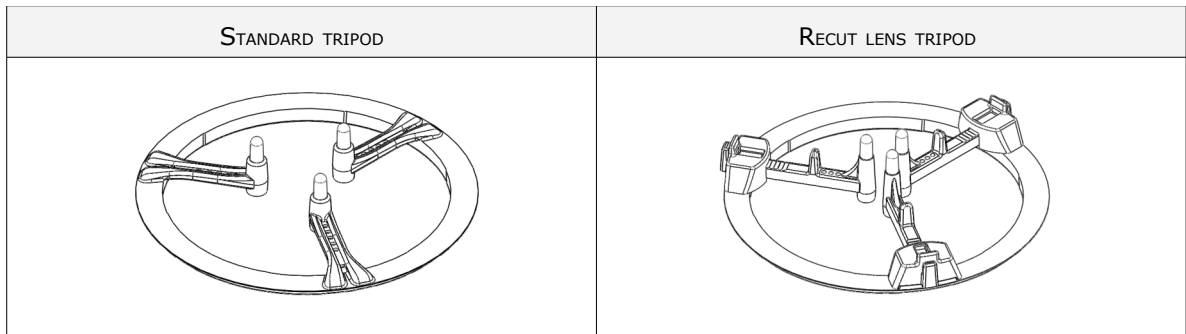

You can turn the tripod to move the studs if they obscure the markings when it comes to centering.

Using the recut lens tripod

You can adjust the spacing of the studs to ensure better lens stability.

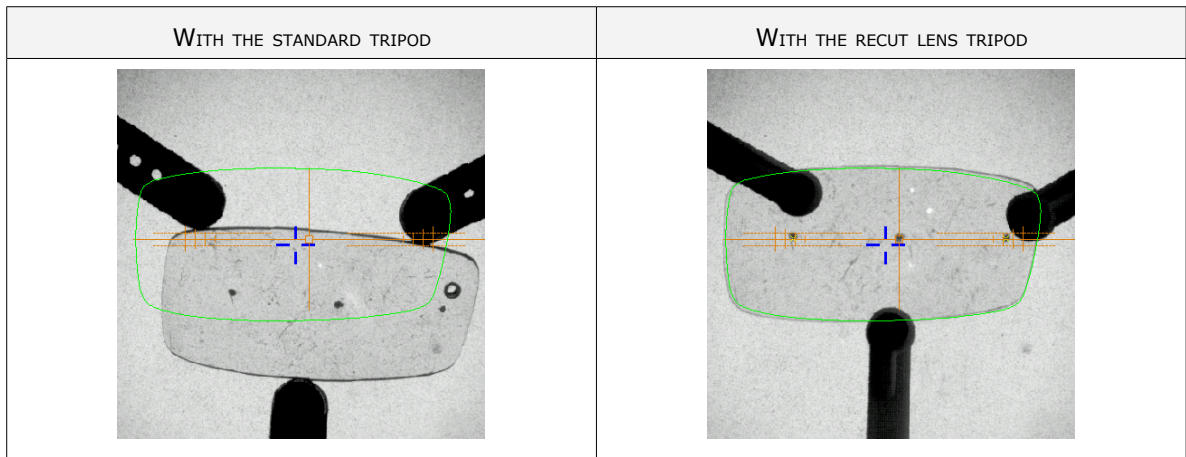

d. Centering modes

The centering modes available depend on the type of lens selected.

Always refer to the specific procedure for your type of lens.

e. Centering help

Centering help is used to detect the centering marks of the lenses according to the centering mode selected.

The centering marks detected on the lens are highlighted:

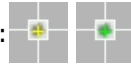

Centering help and micro-engravings

To use centering help with re-marked micro-engravings: erase any circles around the micro-engravings before re-marking them so as not to affect detection.



Essiclean™

You are recommended to use a water-alcohol solution such as Essiclean™ to erase the existing markings.

2. CENTERING A SINGLE VISION LENS



Prerequisite: before carrying out lens centering, a shape must be displayed on the centering screen.

If necessary, we recommend the following prior operations:

- Modifying or retouching the traced shape (☞ p.65)
- Preparing the drilling points to be created (option) (☞ p.73)
- Place the stickers recommended by the manufacturer on hydrophobic lenses.

This section describes the procedures for centering a single vision lens[☞]:

- centering using three focimeter dots
- centering using re-marked micro-engravings



Prerequisite: The lens must be marked with the focimeter.

The three focimeter dots must be:

- Lined up
- At the same distance from the central dot
- 0.5 to 1.5 mm in diameter



Prerequisite: micro-engravings must be re-marked with the felt-tip pen. The diameter of the dots must be between 0.5 and 1.5 mm.



We advise you to use the white felt tip marker supplied with the tracer-centerer-blocker to mark the lens.

Description of the centering target

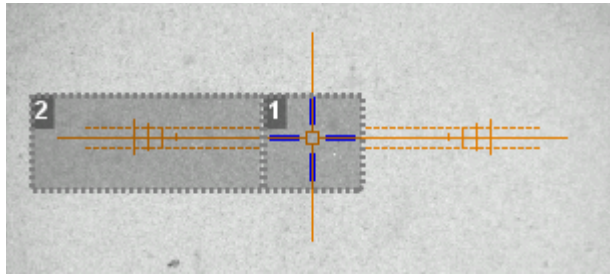

1. Optical center of the lens (orange cross) and boxing center of the shape (blue cross)

2. Centering marks

Centering the lens

1 Press  to select the type of single vision lens.

> The centering target is displayed:

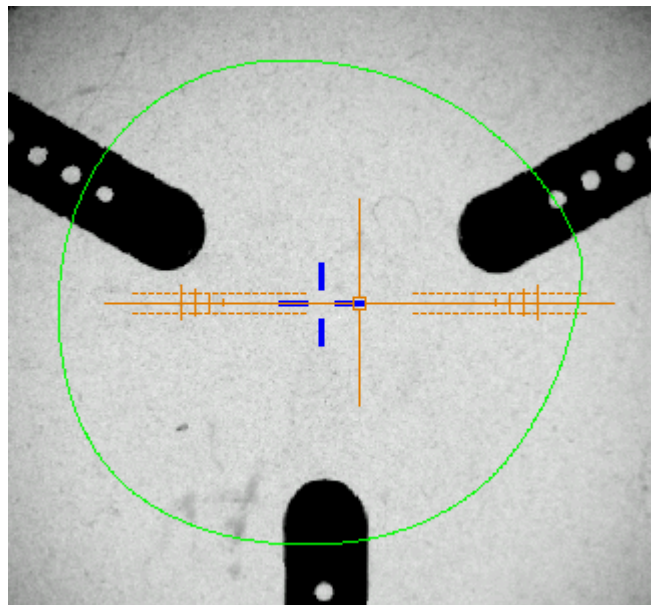

2 Enter the half PD and pupillary height.

> The target moves.

3 Ensure that the tripod is within the centering chamber.



Use the recut lens tripod (option) for a high base lens, a recut lens or a decentered lens (option).

4 Position the lens on the tripod.

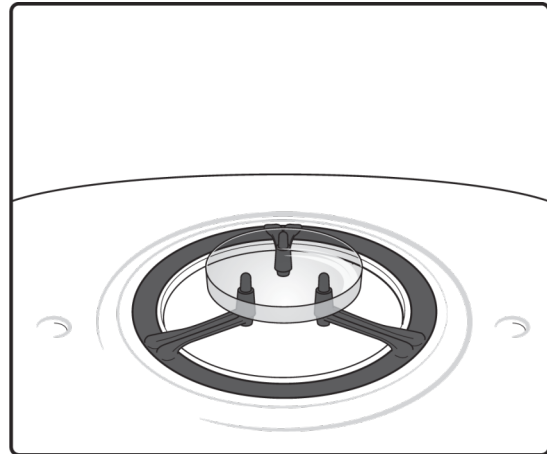
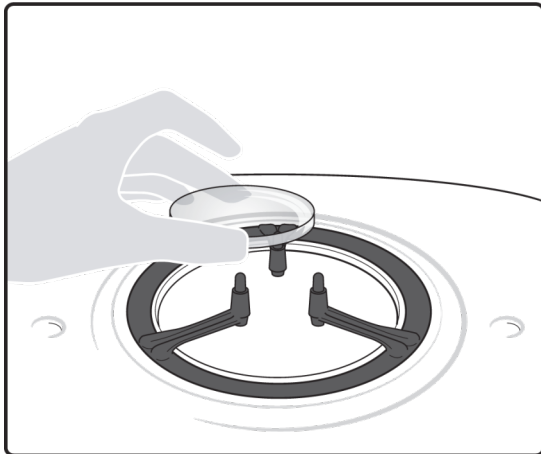

5 In the case of focimeter dots: Slowly move the lens until the **three focimeter dots** are perfectly aligned on the test card.

In the case of micro-engravings: Slowly move the lens until the **micro-engravings** are perfectly aligned on the test card.

Yellow indicators are displayed when the focimeter dots or micro-engravings are detected.

For the three focimeter dots:

- place the central point in the square ,
- place the two external points between the two dotted lines, as close as possible to the central line.

- > The indicators are displayed in green.
- > The lens is centered and ready to be blocked.

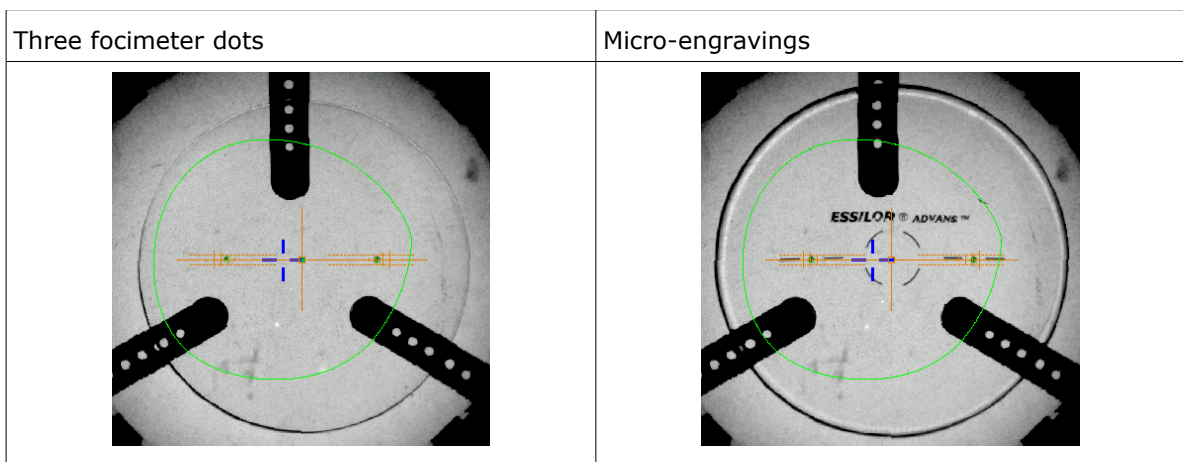

To carry out lens blocking, refer to the section Lens Centring > Blocking a lens ( p.61).

3. CENTERING A PROGRESSIVE LENS

- ✔ Prerequisite: before carrying out lens centering, a shape must be displayed on the centering screen.

If necessary, we recommend the following prior operations:

- Modifying or retouching the traced shape (☞ p.65)
- Preparing the drilling points to be created (option) (☞ p.73)
- Place the stickers recommended by the manufacturer on hydrophobic lenses.

This section describes the procedures for centering a progressive lens☞:

- using re-marked micro-engravings mode (☞ p.47)
- using manufacturer markings mode (☞ p.50)

Description of the centering target

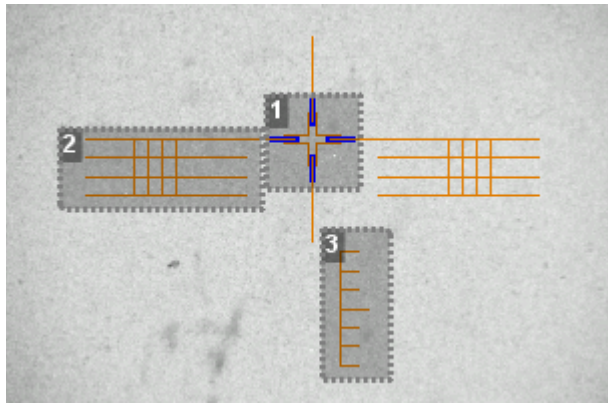

1. Centering cross (orange cross) and boxing center of the shape (blue cross)

2. Centering graduated marks

The horizontal lines are spaced 2mm apart enabling you to measure the PRP distance.

3. Near vision mark

a. Centering a progressive lens using re-marked micro-engravings

- ✔ Prerequisite

- Remove all the original markings.
- Remark the micro-engravings with the marker; the points must have a diameter ranging between 0.5 and 1.5 mm.



We advise you to use the white felt tip marker supplied with the tracer-centerer-blocker to mark the lens.



Centering the lens

1 Press  to select the type of progressive lens.

> The centering target is displayed:

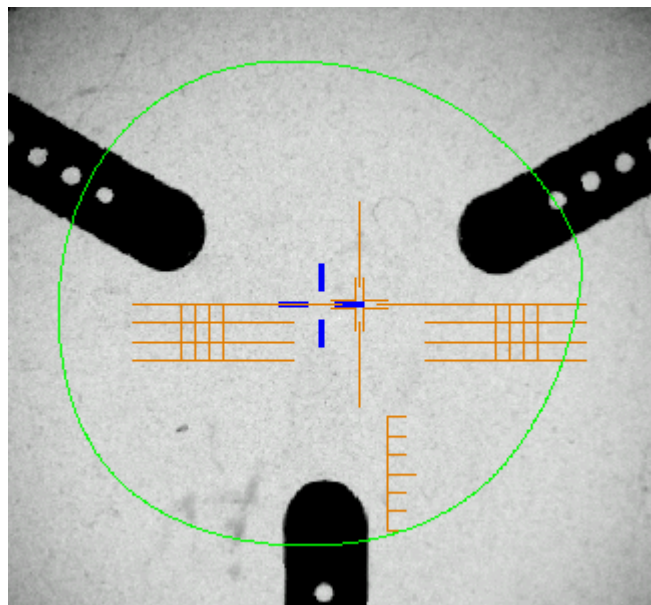

2 Enter the half PD and pupillary height.

> The target moves.

3 Ensure that the tripod is within the centering chamber.



Use the recut lens tripod (option) for a high base lens, a recut lens or a decentered lens (option).

4 Position the lens on the tripod.

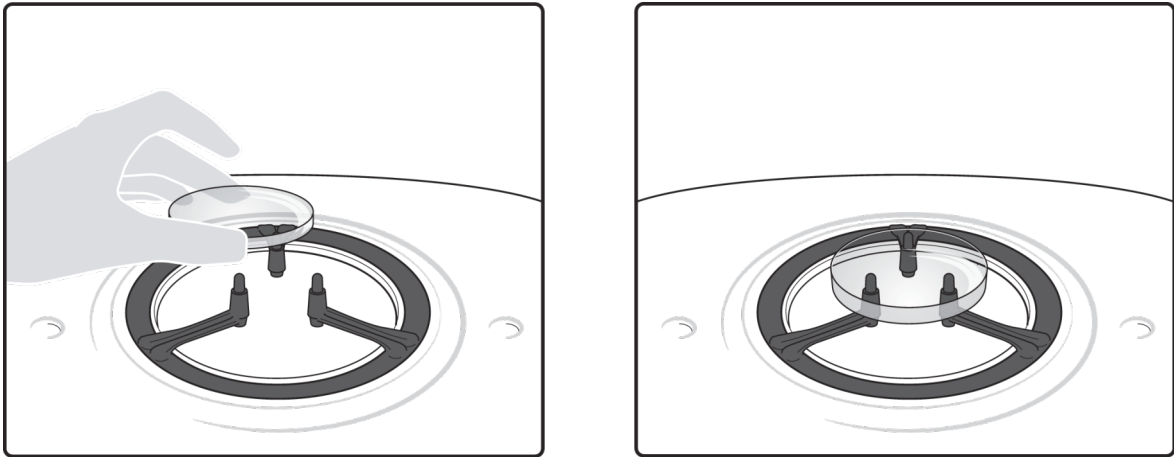

5 Move the lens slowly until the micro-engravings are:

- symmetrical in relation to the graduations,
- aligned on the line corresponding to the PRP of the lens.



The PRP value of Essilor progressive lenses is 4 mm. This may vary depending on the manufacturer of the lenses.

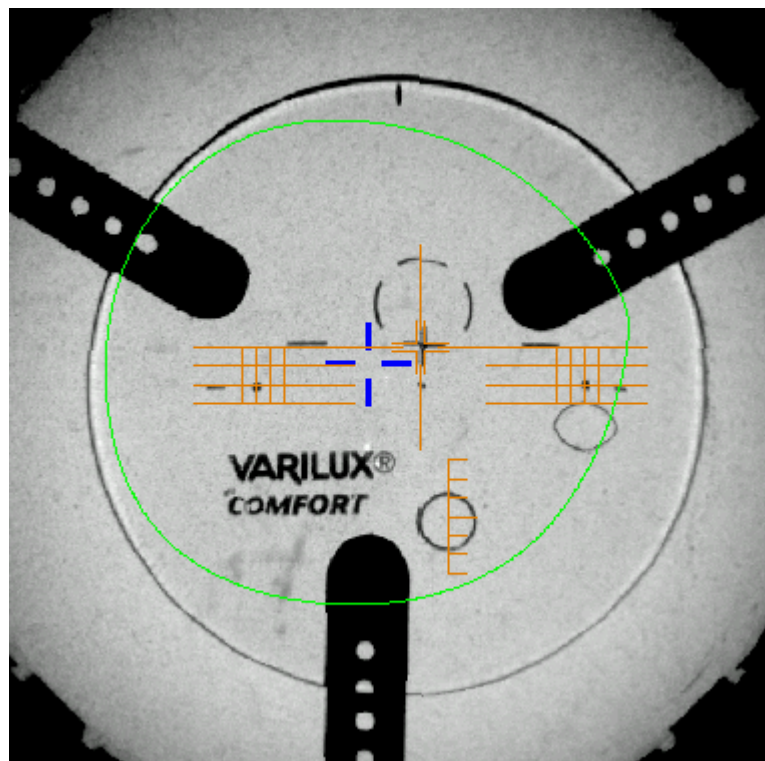

> The lens is centered and ready to be blocked.

To carry out lens blocking, refer to the section Lens Centring > Blocking a lens (p.61).

b. Centering a lens using manufacturer markings

✓ Prerequisite

- The markings must be clear.
- The lens must at least have the following markings:

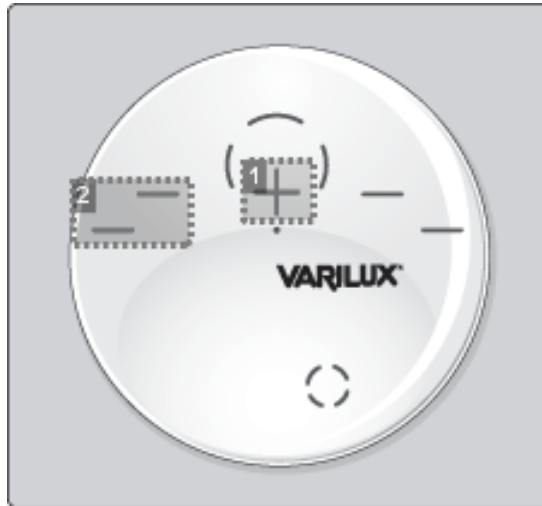

1. Far vision mark

2. Centering marks

Centering the lens

1 Press  to select the type of progressive lens.

> The centering target is displayed:

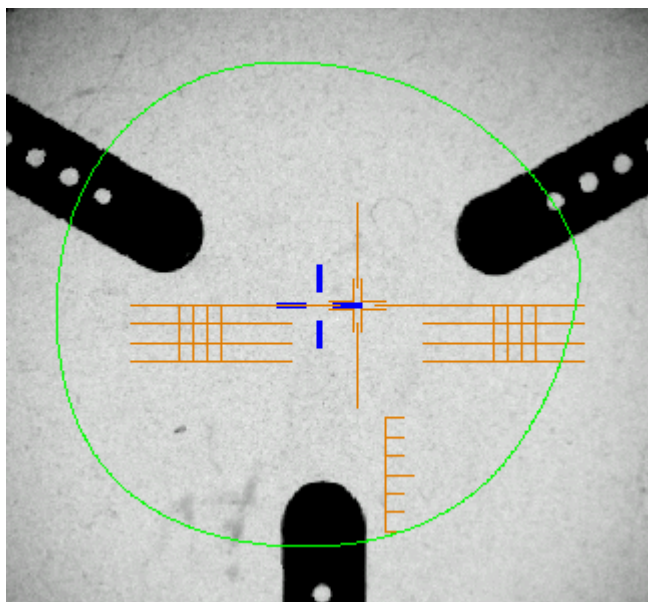

2 Enter the half PD and pupillary height.

> The target moves.

3 Ensure that the tripod is within the centering chamber.



Use the recut lens tripod (option) for a high base lens, a recut lens or a decentered lens (option).

4 Position the lens on the tripod.

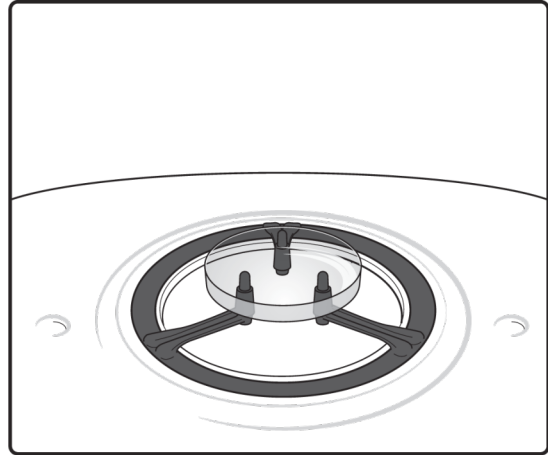
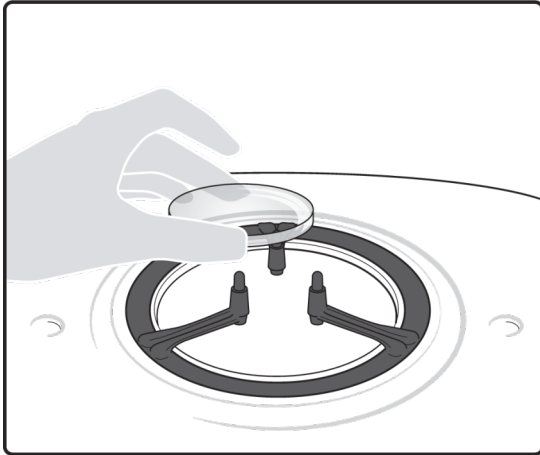

5 Slowly move the lens until manufacturer markings are:

- Perfectly centered in the centering cross,
- Parallel with the horizontal lines.

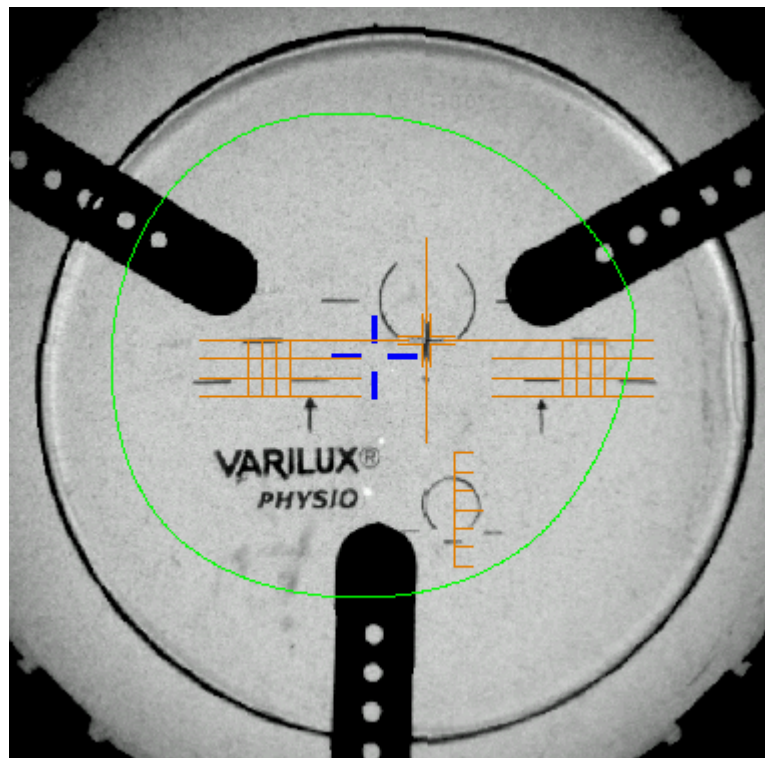

> The lens is now centered and ready for blocking.

To carry out lens blocking, refer to the section Lens Centring > Blocking a lens (☞ p.61).

4. CENTERING BIFOCAL / TRIFOCAL LENSES

 Prerequisite: before carrying out lens centering, a shape must be displayed on the centering screen.

If necessary, we recommend the following prior operations:

- Modifying or retouching the traced shape ([☞ p.65](#))
- Preparing the drilling points to be created (option) ([☞ p.73](#))
- Place the stickers recommended by the manufacturer on hydrophobic lenses.

This section describes the centering procedure for a bifocal or trifocal  lens with a straight, curved or round segment.

Description of the centering target

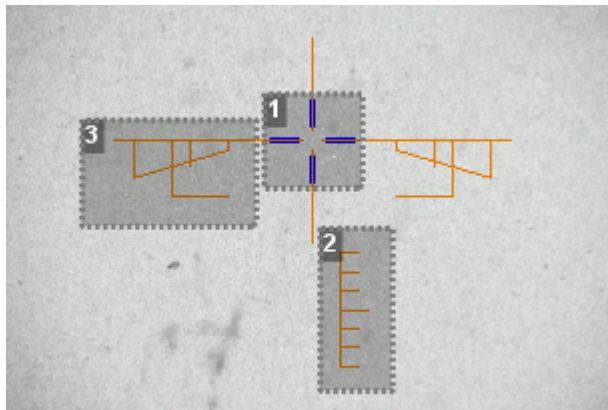

1. Centering cross (orange cross) and the boxing center of the shape (blue cross)
2. Near vision mark
3. Centering marks

Centering the lens

1 Press  to select the type of bifocal lens.

> The centering target is displayed:

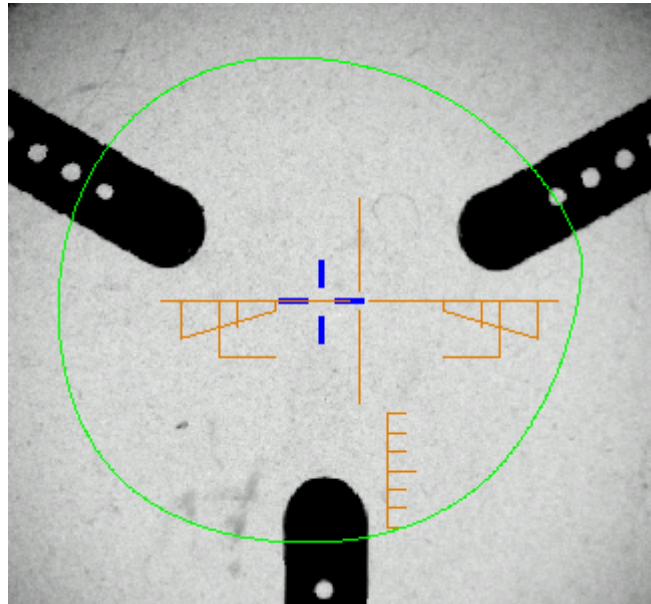

2 Enter the half PD for near vision and the frame height.

> The target moves.

3 Ensure that the tripod is within the centering chamber.



Use the recut lens tripod (option) for a high base lens, a recut lens or a decentered lens (option).

4 Position the lens on the tripod.

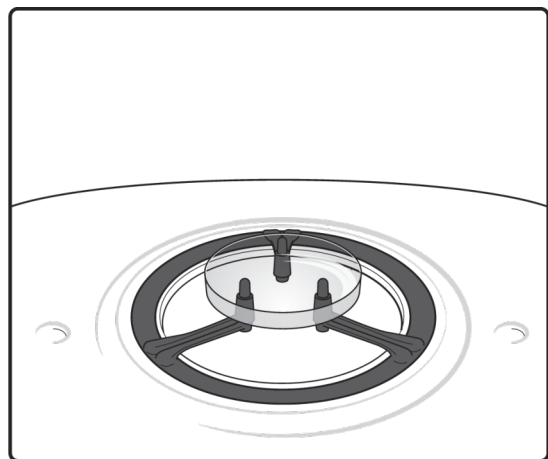
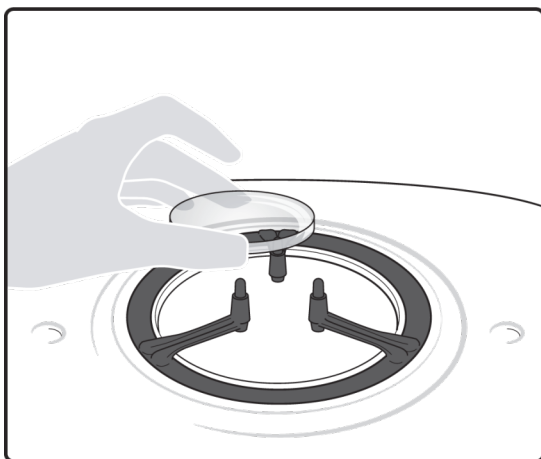

- 5 Move the lens slowly until the top of the segment is in the center of the target.

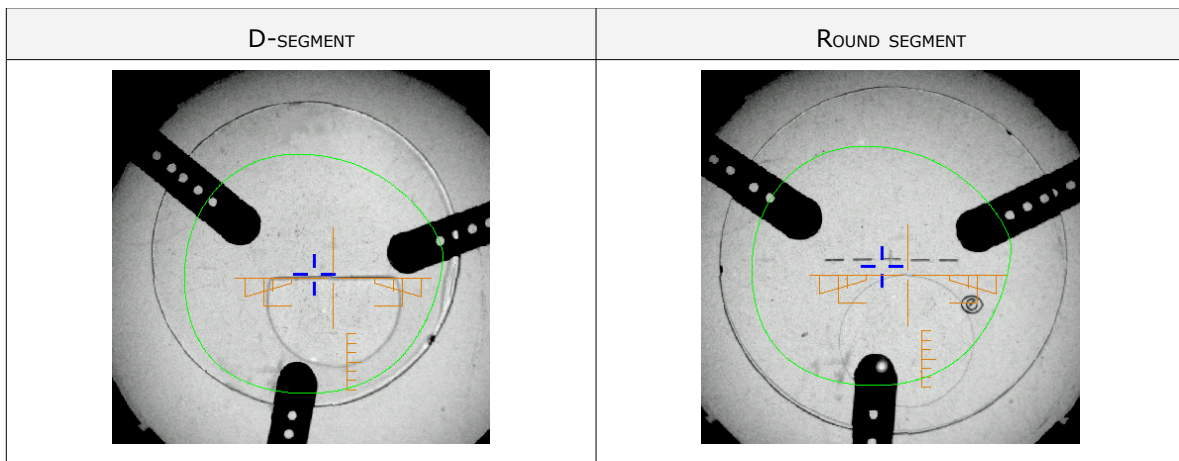

- > The lens is centered and ready to be blocked.

To carry out lens blocking, refer to the section Lens Centring > Blocking a lens (☞ p.61).

5. CENTERING AN EXECUTIVE LENS

- ✓ Prerequisite: before carrying out lens centering, a shape must be displayed on the centering screen.

If necessary, we recommend the following prior operations:

- Modifying or retouching the traced shape (☞ p.65)
- Preparing the drilling points to be created (option) (☞ p.73)
- Place the stickers recommended by the manufacturer on hydrophobic lenses.

This section describes the procedure for centering an executive lens[☞].

- ✓ Prerequisite: the lens must be marked using a focimeter.

The three focimeter dots must be:

- aligned,
- at the same distance from the central dot,
- 0.5 to 1.5 mm in diameter.

Description of the centering target

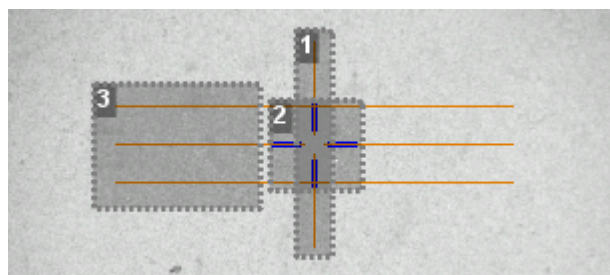

1. Centering mark

2. Boxing center of the shape (blue cross)

3. Centering mark

Centering the lens

1 Press  to select the type of executive lens.

> The centering target is displayed:

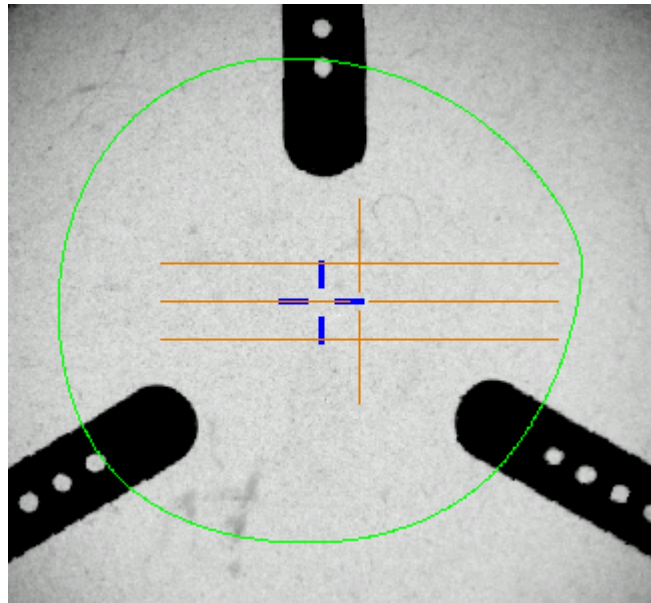

2 Enter the half PD (for near vision or far vision) and the frame height.

> The target moves.

3 Ensure that the tripod is within the centering chamber.



Use the recut lens tripod (option) for a high base lens, a recut lens or a decentered lens (option).

4 Position the lens on the tripod.

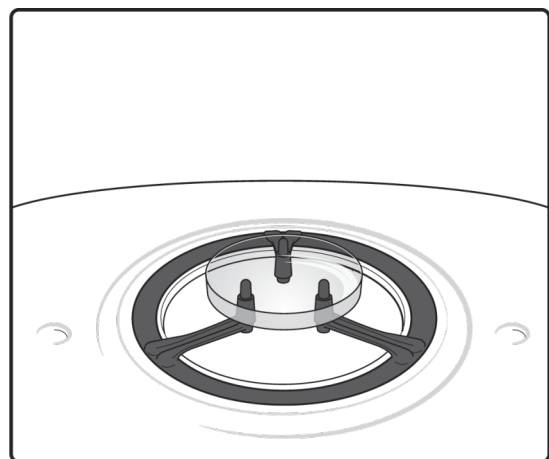
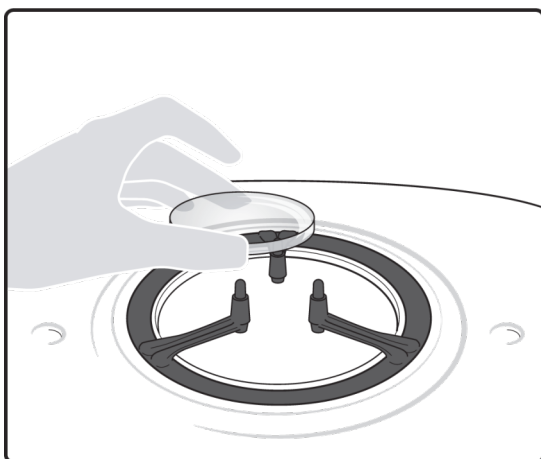

5 Move the lens slowly until it is perfectly centered:

- line up the transition segment between near vision and far vision with the horizontal mark in the center
- position the central focimeter dot on the vertical axis of the target

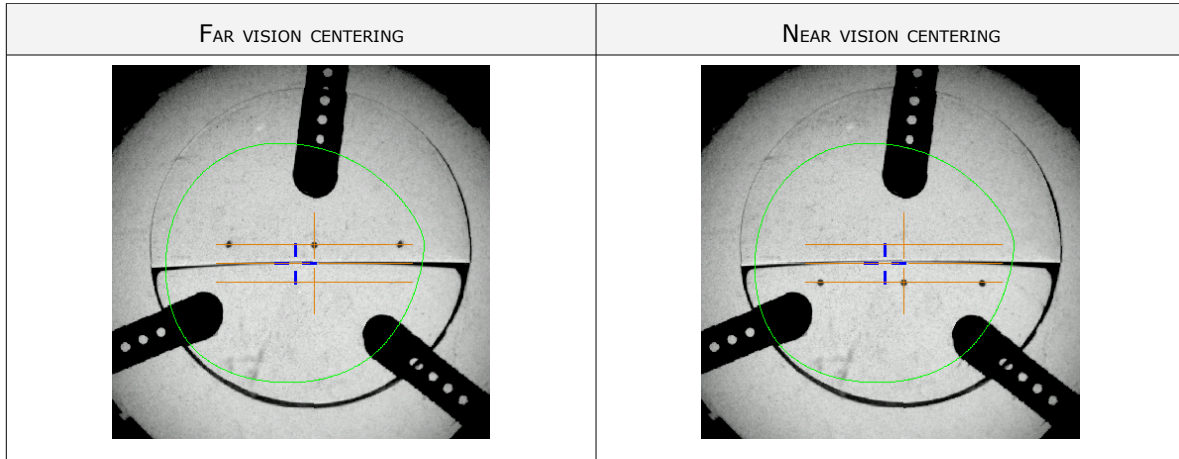

> The lens is centered and ready to be blocked.

To carry out lens blocking, refer to the section Lens Centring > Blocking a lens (☞ p.61).

6. CENTERING A MID-DISTANCE LENS



Prerequisite: before carrying out lens centering, a shape must be displayed on the centering screen.

If necessary, we recommend the following prior operations:

- Modifying or retouching the traced shape (☞ p.65)
- Preparing the drilling points to be created (option) (☞ p.73)
- Place the stickers recommended by the manufacturer on hydrophobic lenses.

This section describes the procedures for the centering a mid-distance lens☞:

- using re-marked micro-engravings mode (☞ p.57)
- using manufacturer markings mode (☞ p.59)

Description of the centering target

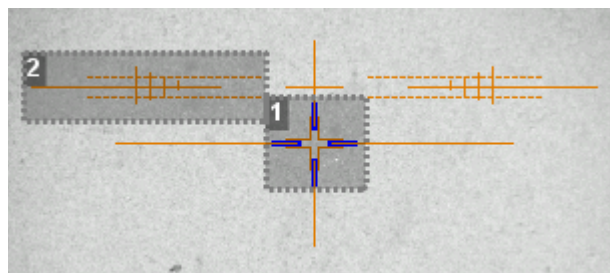

1. Centering cross (orange cross) and boxing center of the shape (blue cross)
2. Centering graduated marks

The horizontal line is situated at 6mm enabling you to measure the PRP distance.

a. Centering a lens using re-marked micro-engravings

✓ Prerequisite

- Remove all the original markings.
- Remark the micro-engravings with the marker; the points must have a diameter ranging between 0.5 and 1.5 mm.



You are recommended to use the white felt tip marker supplied with the tracer to mark the lens.

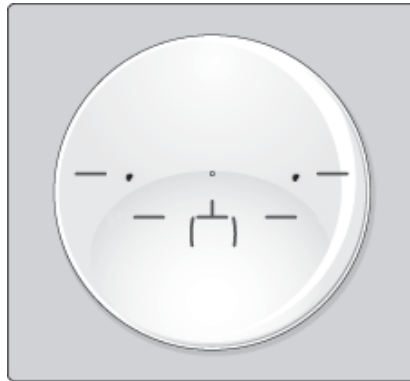

Centering the lens

1 Press  to select the type of mid-distance lens.

> The centering target is displayed:

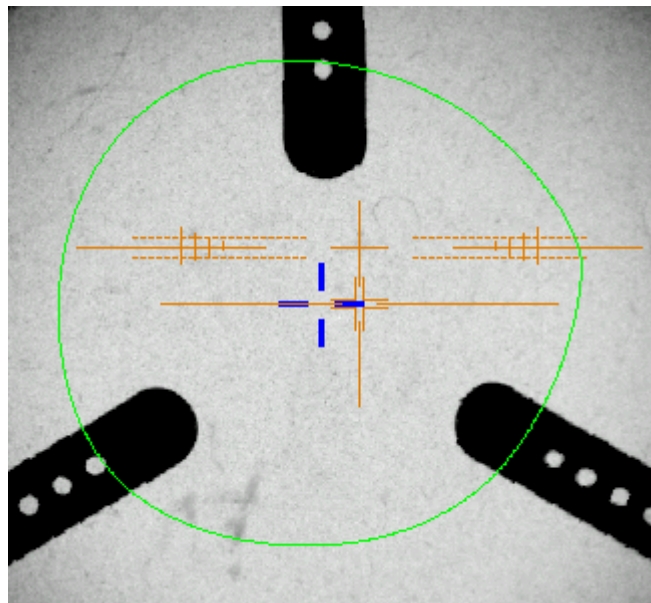

2 Enter the half PD and the frame height.

> The target moves.

3 Ensure that the tripod is within the centering chamber.



Use the recut lens tripod (option) for a high base lens, a recut lens or a decentered lens (option).

4 Position the lens on the tripod.

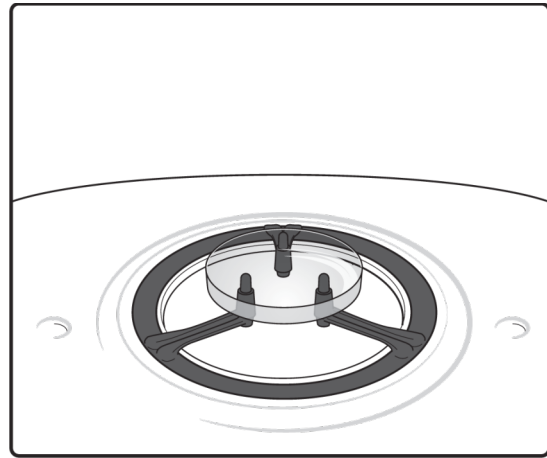
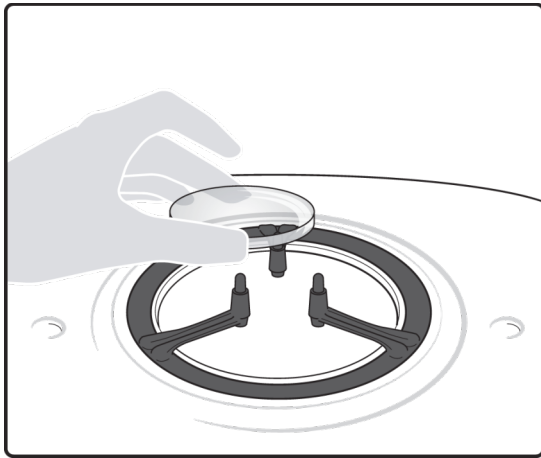

5 Move the lens slowly until the micro-engravings are:

- symmetrical in relation to the graduations,
- aligned on the line corresponding to the PRP of the lens.



The PRP value of Essilor mid-distance lenses is 6 mm. This may vary depending on the manufacturer of the lenses.

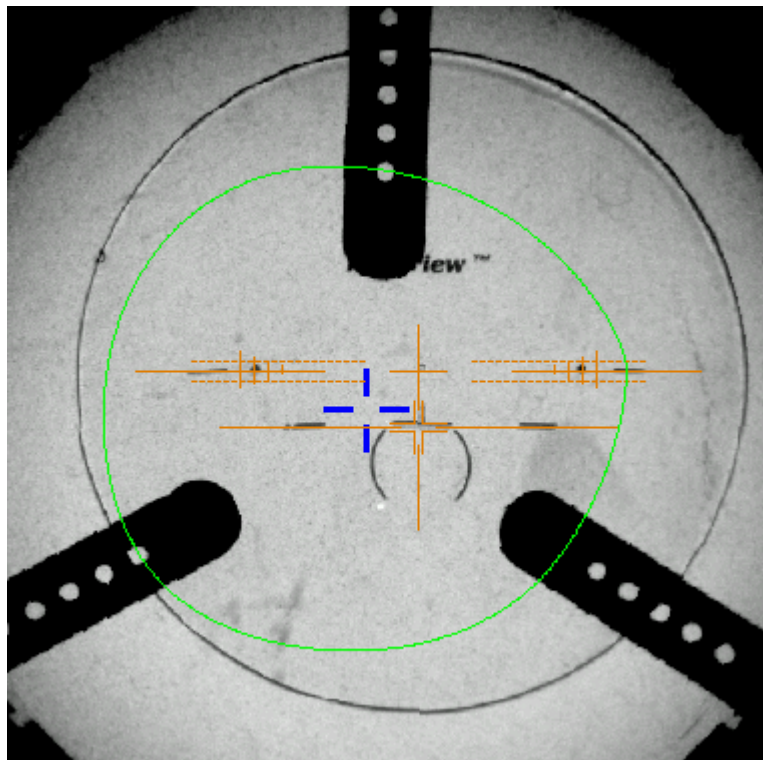

> The lens is centered and ready to be blocked.

To carry out lens blocking, refer to the section Lens Centring > Blocking a lens (☞ p.61).

b. Centering a lens using manufacturer markings

✓ Prerequisite

- The markings must be clear
- The lens must at least have the following markings:

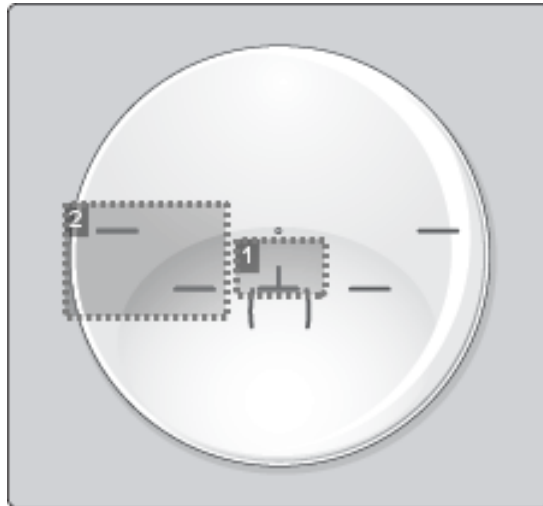

1. Centering cross

2. Centering marks

Centering the lens

1 Press  to select the type of mid-distance lens.

> The centering target is displayed:

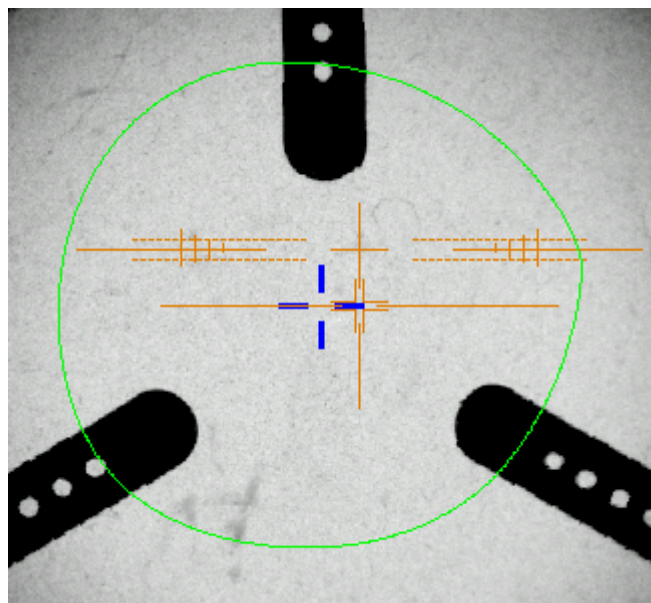

2 Enter the half PD and the frame height.

> The target moves.

3 Ensure that the tripod is within the centering chamber.



Use the recut lens tripod (option) for a high base lens, a recut lens or a decentered lens (option).

4 Position the lens on the tripod.

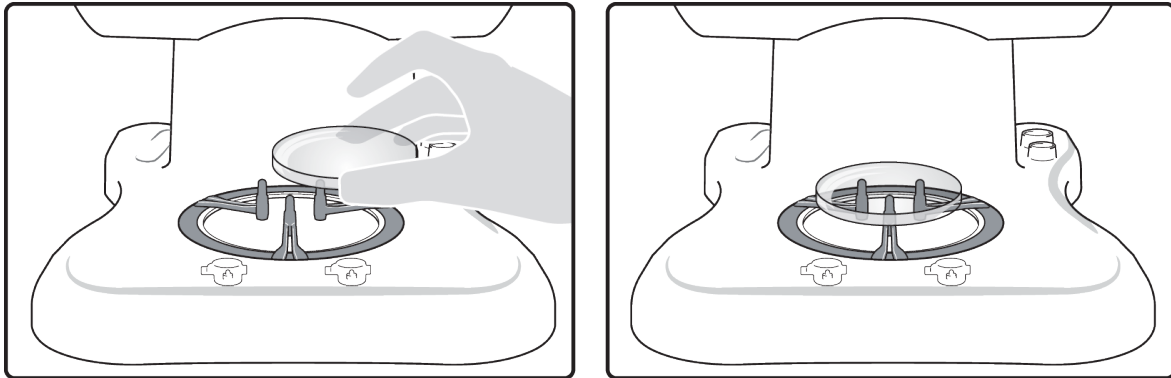

5 Slowly move the lens until the manufacturer markings are:

- Perfectly centered in the centering cross,
- Parallel with the horizontal lines.

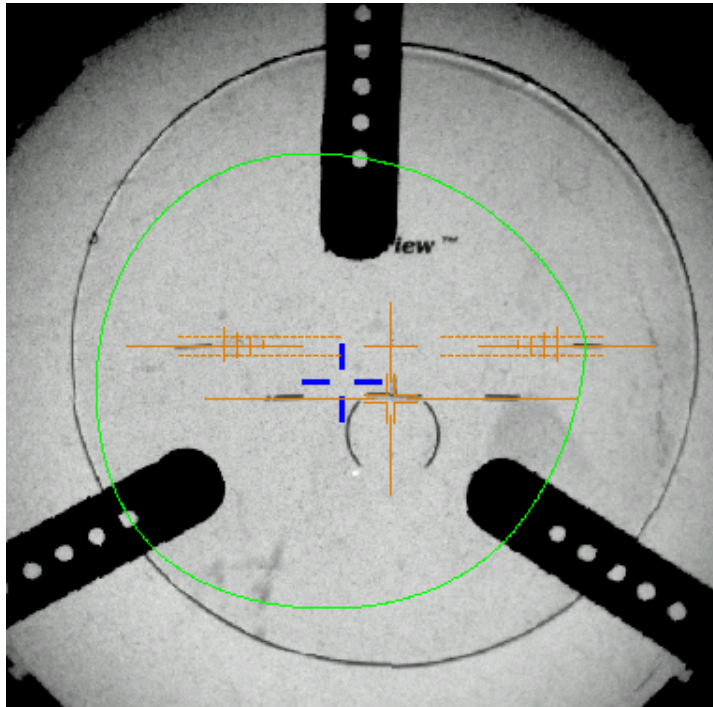

> The lens is now centered and ready for blocking.

To carry out lens blocking, refer to the section Lens Centring > Blocking a lens (☞ p.61).

7. CENTERING FOR A HIGH-BASE FRAME

At the end of a tracing, if a frame is considered to be high-base, the  indicator is displayed in the information bar.

3D compensation

The PD and pupillary height measurements as well as the lens centering are done in two dimensions. Yet, the frame is treated in three dimensions:

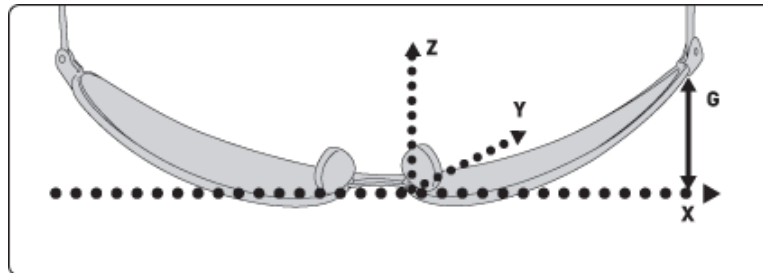

3D compensation takes into account all frame characteristics (x, y, z, curve, pantoscopic tilt, etc.) to ensure that the center of the wearer's pupil is at the optical center of the lens. For an optimal job, the on-screen positioning of the centering indicators always takes account of 3D compensation.



Match between frame base and lens base

To do a job involving a high-base frame, use lenses whose base matches that of the frame (maximum difference of 0.7 D).

For greater ease, you can use the recut lens tripod (option) to center a high-base lens.

Refer to the centering procedure for the particular type of lens:

- Centering a single vision lens ([☞ p.44](#))
- Centering a progressive lens ([☞ p.47](#))
- Centering a bifocal lens ([☞ p.52](#))
- Centering an executive lens ([☞ p.54](#))
- Centering a mid-distance lens ([☞ p.56](#))

8. BLOCKING A LENS

This section describes the procedures for lens blocking depending on the selected option:

- Blocking preparation ([☞ p.62](#))
- Blocking with the automatic arm ([☞ p.63](#))

a. Preparing blocking

Two accessories are available for the blocking operation:

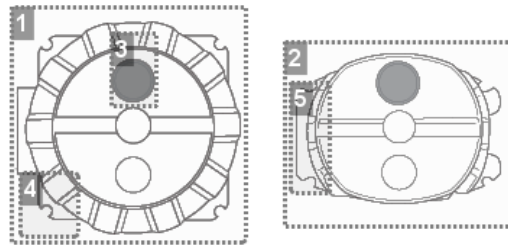

1. 22 mm posiblock
2. 18x14 mm posiblock
3. Magnet
4. Fin
5. Tab

The posiblocks and their corresponding pads are supplied with the edger.



- Always use Essilor pads: they are specially designed to ensure the performance of your machine for quality jobs.
- The pads are non re-usable.
- Do not stick pads on posiblocks in advance as they may loose some of their holding power.
- The posiblock must never be placed on the rear (inner) surface of the lens.

Blocking in the boxing center or the optical center



Depending on your working practice, you can choose to block the lenses:

- in the boxing center of the shape,
- in the optical center.

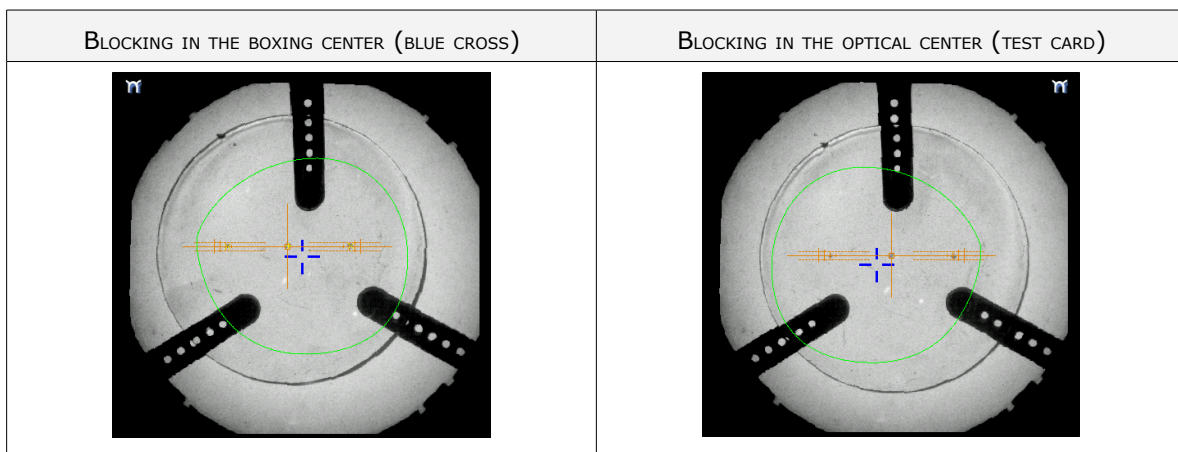
In the event of blocking in the optical center, the posiblock can be decentered on the shape.



The selected blocking mode is displayed in the information bar:



-  Blocking in the boxing center
-  Blocking in the optical center

By default, the tracer-centerer-blocker blocks the lenses in the boxing center.

To choose a different blocking mode, consult the section [Configuring the centerer-blocker > Customising > Working modes and display precision](#) ([☞ p.97](#)).

b. Block the lens

Prerequisite

- The lens must be centered.
- Take the posiblock adapted to the shape, indicated at the bottom right of the screen:  or .

1 Position the posiblock in the blocking head.

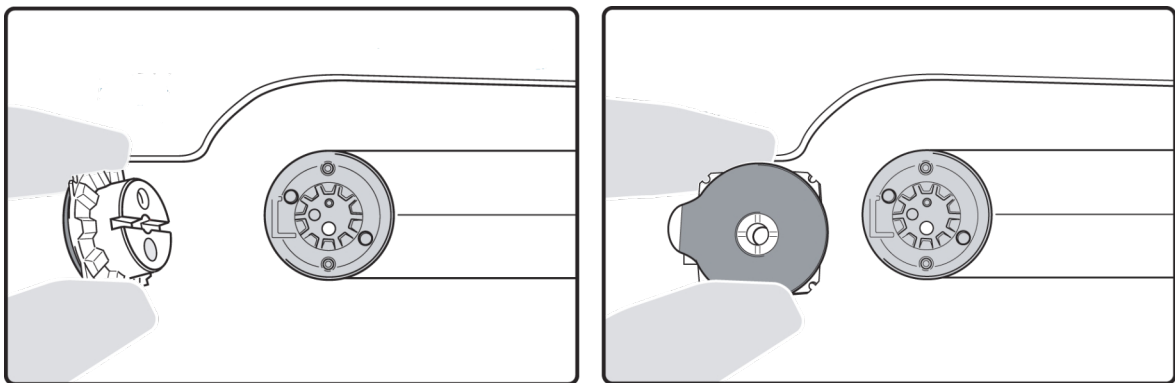

2 According to the display, press or to start blocking.

- > The blocking arm places the posiblock on the lens at the shape Boxing center or at the optical center.
- > The lens is blocked.



For a hydrophobic lens, press with your fingers on the posiblock so that it adheres to the lens properly.

- > The centering screen for the second lens is displayed.

The adjustments made to the PD, pupillary height, type of lens and type of centering are displayed by default for the second lens.

3 Center and block the second lens.

- > The edging preparation screen is displayed automatically.

Consult the chapter [Preparing lens edging](#) ([☞ p.87](#)).

IV. MODIFYING THE LENS SHAPE

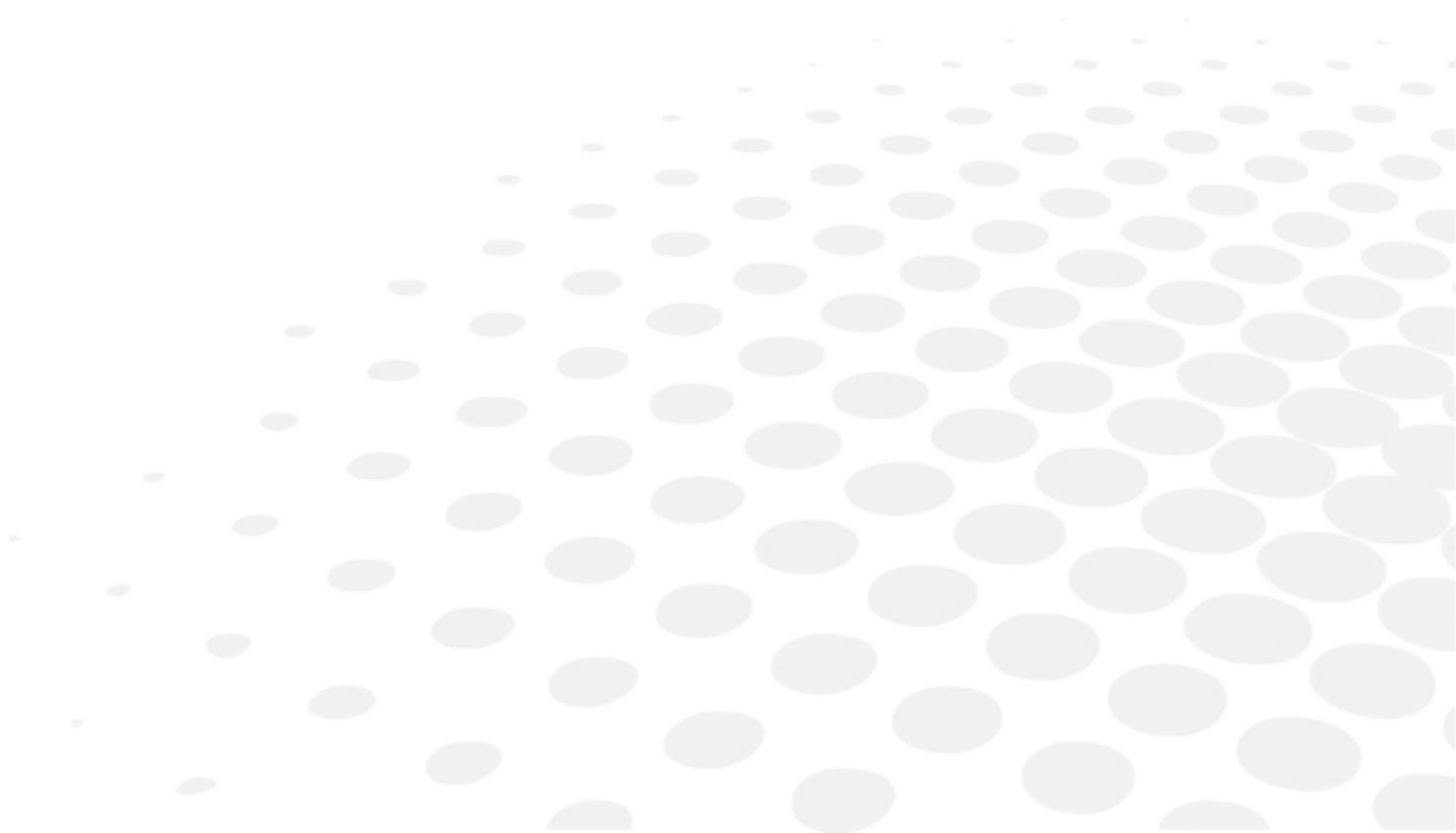

This chapter describes the lens shape modification procedures:

- Description of the shape modification screen (☞ p.66)
- Modifying the lens shape (☞ p.67)
- Archiving shapes (☞ p.72)

1. MENU SCREEN





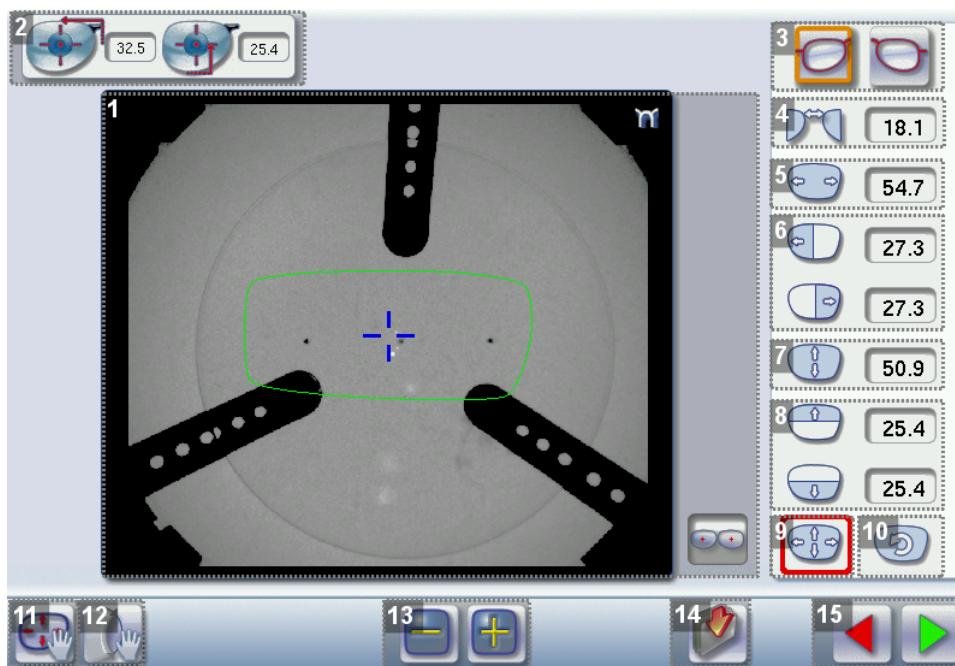

From the centering screen, press  to access the shape modification screen.

The following screen is displayed:



1. Work area

Colours which may appear on screen:

-  (green) Current shape (from the shape traced) and associated drilling points
-  (cyan) Current shape (obtained by symmetry with the shape traced) and associated drilling points
-  (light red) Shape before modification
-  (grey) Part of the shape not selected for the current modification
-  (yellow) Limit of the drilling zone
-  (red) Non-machinable shape
-  (blue) Reference drilling points

 Binocular view

2. Half PD and pupillary height

3. Active eye

The selected eye has an orange frame around it.

4. D-dimension modification

5. A-dimension modification

6. Modification of half A-dimensions (temporal / nasal)

7. B-dimension modification

8. Modification of half B-dimensions (upper / lower)



9. Modification of the overall size of the shape

Scaling in relation to boxing center

10. Shape rotation around the boxing center

11. Free-form modification

12. Shape retouch



-  Retouch to create a straight line.
-  Retouch to create a curve.
-  Retouch to create an angle.

13. Modify the selected value

The modification is carried out in 0.5 mm or 1 mm steps depending on the precision setting ([☞ p.97](#)).

14. Create a new job based on the job displayed

15. Back to the centering screen

- Press  to save the changes and go back to the centering screen.
- Press  to return to the centering screen without saving the changes.

2. MODIFYING A SHAPE

The shape modification screen gives you access to several functions:

- Simple modifications ([☞ p.67](#)): D-dimension, boxing dimensions[□], modification of size and rotation of the shape
- Free modification ([☞ p.70](#)), within the constraints pertaining to lens edging
- The retouching of a shape ([☞ p.71](#)) in the event of possible tracing defects

Shape modifications and retouches are only applied if all the dimensions and half-dimensions limits are included.

If a portion of the shape is not included within the machinable limits, it is displayed in red.



Both lenses are modified simultaneously.

a. Enlarging, reducing or rotating a shape

The side panel on the right of the screen enables you to:



- Modifying each dimension or half-dimension separately
- Modifier the size of a shape as a whole

- Rotating a shape around the boxing center

Modifying each dimension or half-dimension separately

1 Select the icon representing the part of the shape which you wish to reduce or increase.

- > A red rectangle is displayed around the icon.

2 Use the  or  buttons to decrease or increase the corresponding value and view the modification in real time.



You can also press for a few seconds on the corresponding value to display the numeric keypad:
enter a new value and press  to confirm.

- > The shape is modified.
- > The original shape is displayed in light red.

Example of an A-dimension reduction:

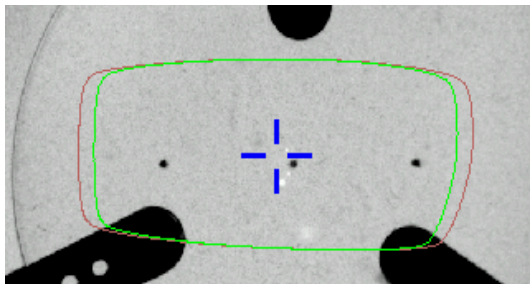

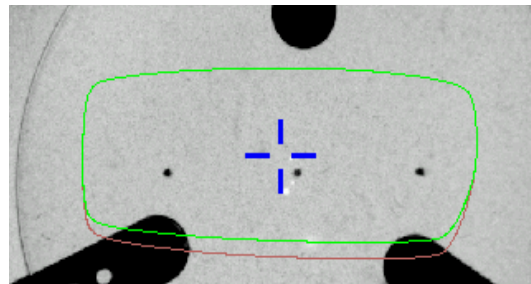

Example of a half B-dimension reduction:



Modify the overall size of the shape

1 Press  to select modification by scaling.

- > A red rectangle is displayed around the icon.

2 Use the  or  buttons to decrease or increase the shape and view the modification in real time.



You can also press for a few seconds on the corresponding value to display the numeric keypad:
enter a new value and press  to confirm.

- > The shape is modified.
- > The original shape is displayed in light red.

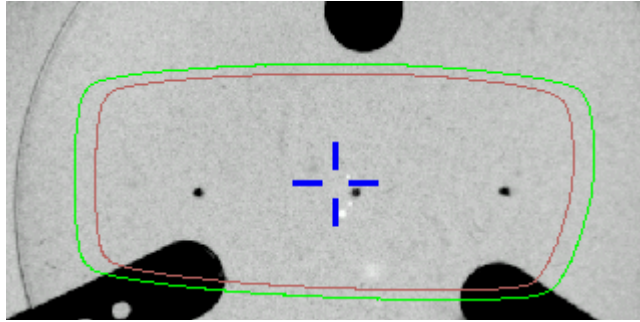

Example of a total enlargement of the shape:



Rotating a shape around the boxing center

1 Press  to select modification by rotation.

> A red rectangle is displayed around the icon.



2 Use the  or  buttons to rotate the shape clockwise or anti-clockwise by 1° and view the modification in real time.

> The shape swivels: the rotation is applied.

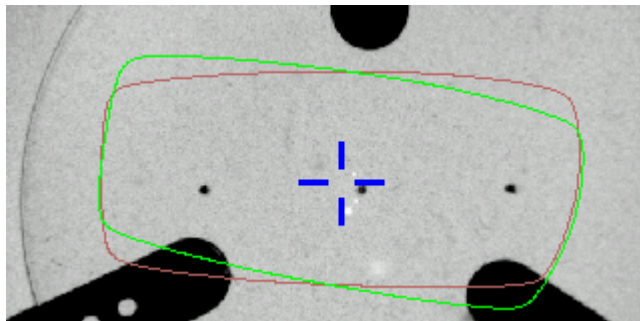
> The original shape is displayed in light red.



Cancelling a modification



- Press  once to cancel the last modification made to the shape.
- Press  twice consecutively to return to the original shape.

Once the shape is modified, press  to save and go back to the centering screen.

b. Free-form modification

This function enables you to freely modify the shape of the lens.

1 Select  > .

- > The selection zone is defined by two cursors  and .
- > The area not affected by the modification is displayed in grey.

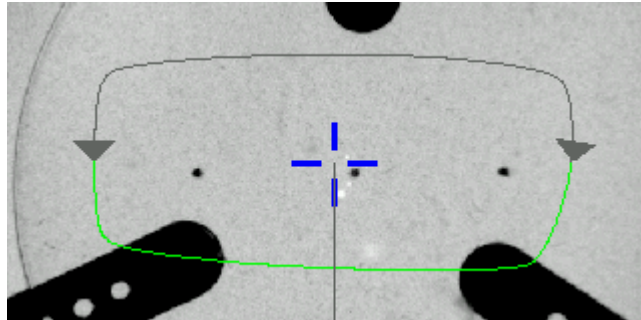

2 Drag the cursors  and  to define the selection zone.



3 Move the line starting at the boxing center to orient the modification.

4 Use the buttons  or  to reduce or enlarge the shape.

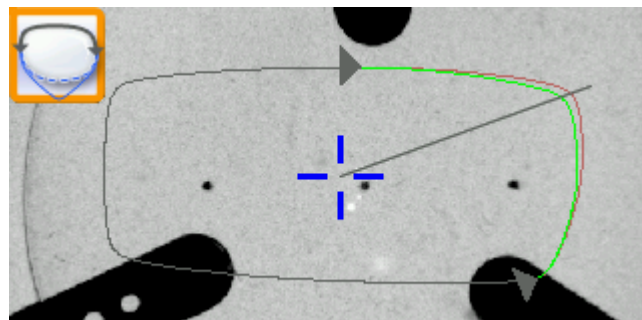
- > The shape is modified.
- > The original shape is displayed in light red.



Cancelling a modification



- Press  once to cancel the last modification made to the shape.
- Press  twice consecutively to return to the original shape.

Once the shape is modified, press  to save and go back to the centering screen.

c. Retouching a shape

This function enables you to retouch the shape of the lens.

1 Select .

- > The selection area is delimited by two cursors  and .
- > The area not affected by the modification is displayed in grey.

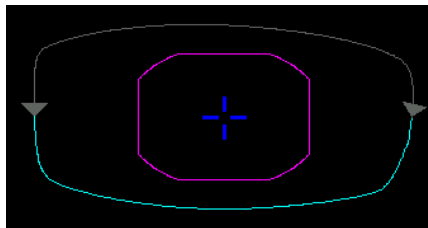

2 Drag the cursors  and  to delimit the selection area.



3 Select the type of retouch.





The types of retouch available vary according to the size of the selected area.

-  Retouch to create a straight line.
-  Retouch to create a curve.
-  Retouch to create an angle.

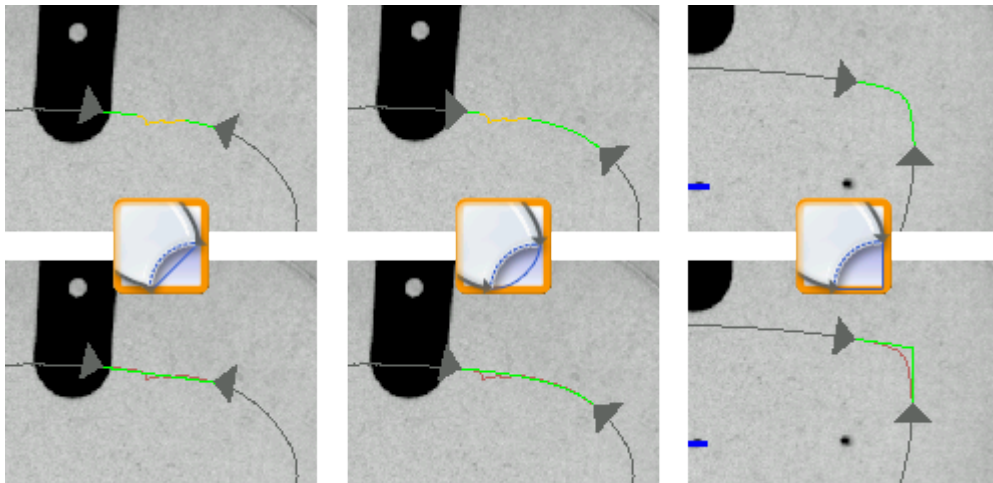
- > The selected area is retouched.
- > The original shape is displayed in light red.



Cancelling a modification

- Press  once to cancel the last modification made to the shape.
- Press  twice consecutively to return to the original shape.

Once the shape is modified, press  to save and go back to the centering screen.

3. ARCHIVING / SAVING A SHAPE

This function enables you to save a modified shape to a new job with a new ID while keeping the original job.

1 Press .

- > The job-creation alphanumeric keypad is displayed.
- > A new ID is allocated (first free slot in the list).

You can also give it a different ID.

2 Enter a reference for the shape to be saved.

3 Press on  to confirm.

- > The shape is archived in a new job with a new ID and is displayed in the shape modification screen.

V. PREPARING A DRILLED JOB

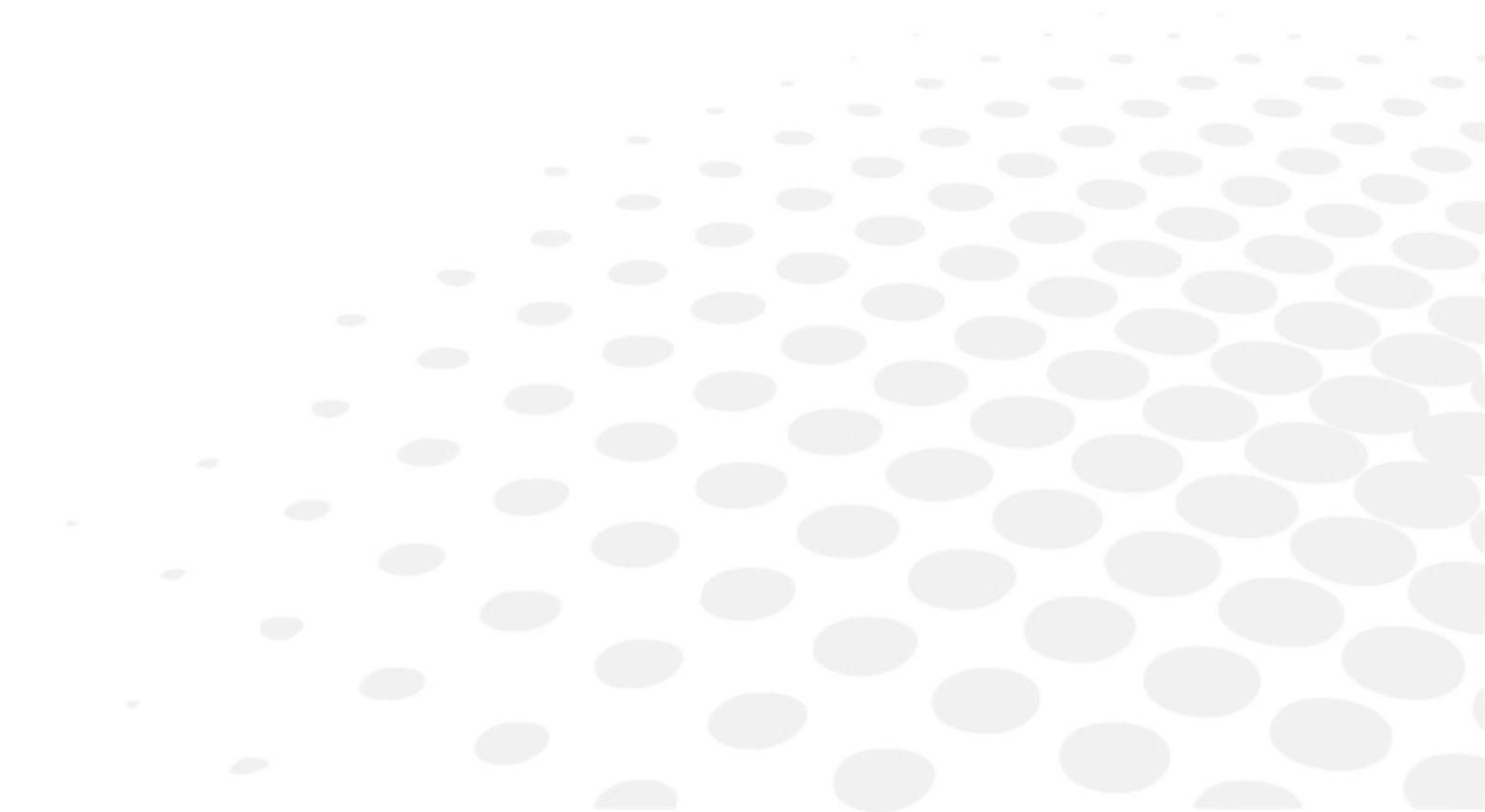

This chapter describes the procedure for the positioning of drilling points (drill-holes, slots, notches) on a lens.

- Description of the drilling screen ([☞ p.75](#))
- Configuring drilling settings ([☞ p.78](#))
- Drilling models ([☞ p.83](#))

Once the drilling parameters have been set, you can go on to the centering of the lens.

 Prerequisite: you must already have carried out lens tracing.



Glass lenses

The drilling function is not available for glass lenses.



Optical tracing (option)

If you trace a demo lens or a pattern using the optical tracing function, then the drilling screen is displayed automatically once the tracing is complete.

The drilling screen is accessible on the tracer according to the edger to which it is connected:

- Neksia Classic
- Neksia RC
- **Neksia Drill (with drilling function).**

Photo mode

To prepare a drilled job from a mechanically traced shape, proceed as follows:

- 1 On the centering screen, position the demo lens within the centering chamber so that the shape and the demo lens coincide as far as possible.

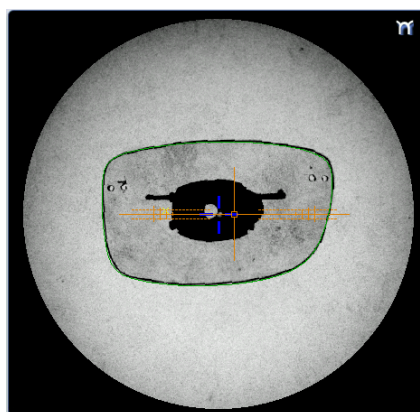

- 2 Press  to access the drilling screen.

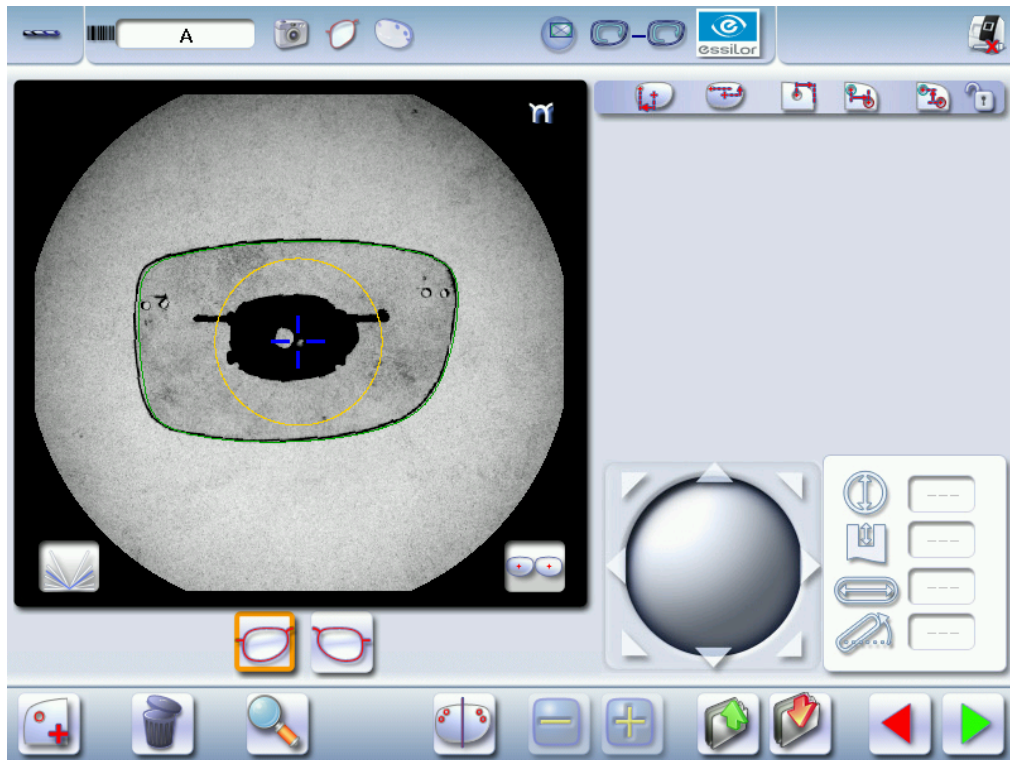



- 3 Add the drill-holes manually.

For more information on drilling settings, consult the section [Preparing a drilling job > Configuring a drilling point](#) (p.78).

1. LEGEND SCREEN

The drilling screen is accessible:





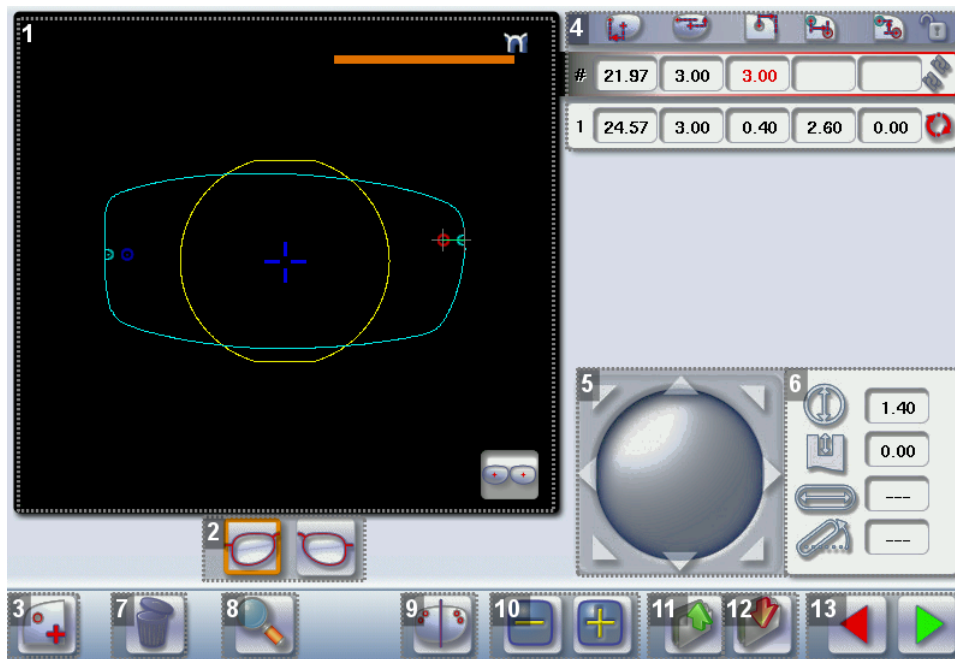

- from the centering screen (press briefly on ) ,
- from the edging settings screen (long press on ).

The following screen is displayed:



1. Work area

Colours which may appear on screen:



-  (green) Current shape (from the shape traced) and associated drilling points
-  (cyan) Current shape (obtained by symmetry with the shape traced) and associated drilling points
-  (yellow) Limit of the no-drill area
-  (orange) Nasal or temporal side indicator
-  (red) Selected drilling point
-  (blue) Reference drilling point (by default, the first one created on each side – nasal and temporal)
- A drilling point with a colour infill indicates non-through drilling

 Binocular view





2. Active eye

The selected eye has an orange frame around it.

3. Type of drilling

-  Drill-hole
-  Slot
-  Notch

4. Drilling coordinates





-  X and Y coordinates in relation to the boxing  center of the shape.
-  Distance between the center of the drill-hole entrance point and the edge of the lens.
-  X and Y coordinates in relation to the reference drilling point.

-  Freezing of the distance between the drilling point and the edge of the lens.



5. Virtual mouse

Slide the stylus in this area to move the selected drilling points.

6. Drilling point dimensioning

-  Diameter in mm
 - default value: 1.40mm
-  Drilling depth in mm in the case of non-through drilling
 - default value: 0 (through-drilling)
-  Length of slot or notch in mm
 - default value of slot: 3.40mm
-  Angle of slot or notch in °
 - default value for right eye: 0° on nasal side, 180° on temporal side
 - default value for left eye: 180° on nasal side, 0° on temporal side

7. Delete one or all drilling points

-  Delete one drilling point
-  Delete all drilling points

8. Zoom



9. Symmetrically transfer the drilling points from the nasal to the temporal side or vice versa

10. Modify the selected value

11. Import a drilling model from the shape management screen

12. Archive the shape and create a new job based on the job displayed

13. Back to the centering screen

- Press  to save the changes and return to the centering screen.
- Press  to return to the centering screen without saving the changes.

2. CONFIGURING A DRILLING POINT

This section describes the procedures for the creation and positioning of a drilling point:

- Creating a drilling point (☞ p.78)
- Delete one drilling point (☞ p.79)
- Dimensioning a drilling point (☞ p.79)
- Adjusting the position of a drilling point (☞ p.80)



The positions of the various drilling points must be set before the centering of the lens.



Both lenses are configured simultaneously.

On tracers not equipped with the optical tracing option to position a drilling on a shape traced following a mechanical tracing of a pattern or a demo lens:

a. Creating a drilling point

1 Press  to create a new drilling point.

2 Select the type of drilling (drill-hole, slot or notch).

3 Press on the shape at the spot where you want to position the drilling point.

> The drilling point created is displayed in red in the shape:

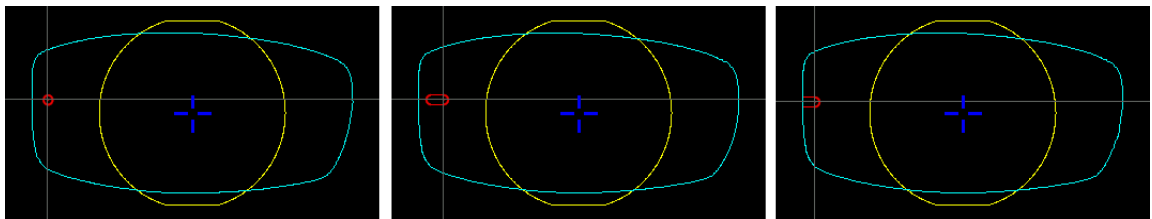

> The drilling coordinates are displayed on the right of the work screen;



Press  to copy the drilling points from the nasal area to the temporal area and vice-versa.

On the tracer-centerer-blocker, you can configure up to 6 drilling points per side (nasal and temporal) of a shape.

b. Delete one drilling point



1 Select the drilling point to be deleted.





If you want to delete all drilling points from the shape, select any of them.

> The drilling point is displayed in red.

2 Press  .

> Two buttons are displayed:   .

3 Press:

-  to delete the selected drilling point, or
-  to delete all drilling points from the shape.

> The selected drilling point or all drilling points are deleted from the shape.





c. Dimensioning a drilling point

You can define a setting for each existing drilling point.

1 Press on the drill-hole, slot or notch to select it.



> The drilling point is displayed in red in the shape.

2 Press a few seconds on the setting to be modified:

-  Diameter
-  Depth (for non-through holes)
-  Length of slot or notch
-  Angle of slot or notch

> The numeric keypad is displayed.



You can also use the  or  buttons to decrease or increase the selected value.

3 Enter the new value of the parameter and press  to confirm.



> The drilling point has been modified.







Grouping the drilling points

If you need to modify several drilling points simultaneously, you can group them together provided they are on the same side of the shape (nasal side / temporal side).

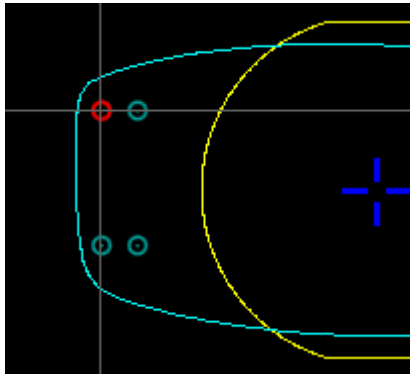
By default, the  symbol is displayed: each drilling point can be modified individually.

- Press  .
- >  is displayed. All future modifications will be applied to all drilling points in the same way:
 - only the reference drilling point is modifiable,
 - the coordinates of the other drilling points are greyed out.





#	-22.95	6.68	1.85			
1	-19.95	6.68	4.85	3.00	0.00	
2	-22.95	-4.52	1.61	0.00	-11.20	
3	-19.95	-4.52	4.61	3.00	-11.20	

- To un-group the drilling points, press  again.

d. Adjusting the position of a drilling point

You have three options for adjusting the position of a drilling point on a shape:



- use the virtual mouse,
- use the  or  buttons to decrease or increase the selected value,
- enter the exact coordinates of the drilling point directly.

The drilling coordinates are those of its entrance drill-hole.

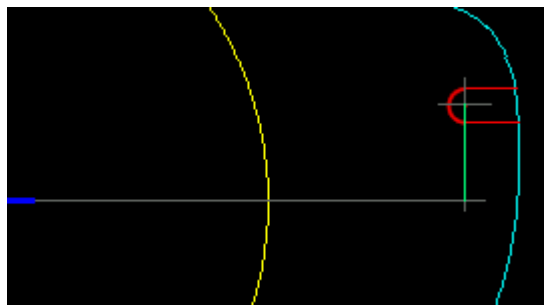
- For a drill-hole, it is the center.
- For a slot and a notch, the entrance point is always on the side which is furthest away from the edge of the lens:







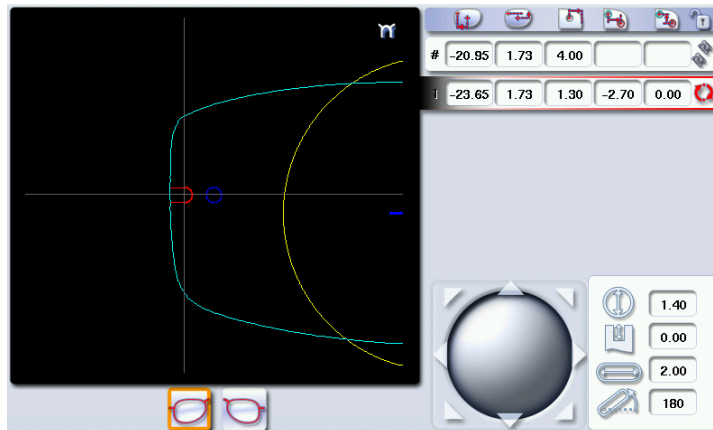

For greater precision, when you use the virtual mouse or the  and  buttons, press  to zoom in on the selected drilling point: the displacement step is 0.01mm (0.1mm for normal display).



1 Press on the drill-hole, slot or notch to select it.

> The drilling point is displayed in red.

2 Press a few seconds on the value corresponding to the coordinates to be modified:

-  X coordinates
-  Y coordinates
-  Distance in relation to the edge of the lens.
-  X coordinates in relation to the reference drilling point
-  Y coordinates in relation to the reference drilling point



Lock  the distance in relation to the edge of the lens to adjust only the Y position of the drilling point.

> The numeric keypad is displayed.

3 Enter the new value and press  to confirm.



> The drilling coordinates are modified.







Grouping the drilling points

If you need to modify several drilling points simultaneously, you can group them together provided they are on the same side of the shape (nasal side / temporal side).

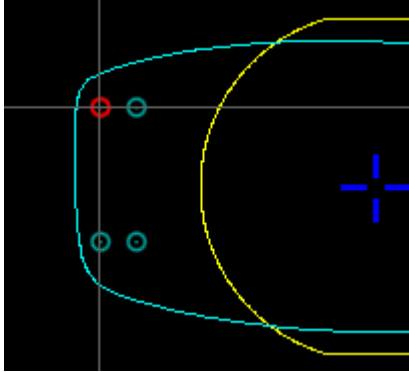
By default, the  symbol is displayed: each drilling point can be modified individually.

- Press  .
- >  is displayed. All future modifications will be applied to all drilling points in the same way:
 - only the reference drilling point is modifiable,
 - the coordinates of the other drilling points are greyed out.



#	-22.95	6.68	1.85			
1	-19.95	6.68	4.85	3.00	0.00	
2	-22.95	-4.52	1.61	0.00	-11.20	
3	-19.95	-4.52	4.61	3.00	-11.20	

- To un-group the drilling points, press  again.

Reference drilling point

The first drilling point you create on a shape automatically becomes the 'reference drilling point' in relation to which the others are positioned:

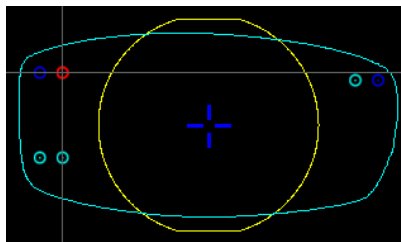

- Each side (nasal and temporal) has its reference drilling point, identified by its dark blue colour .



- It is identified by the symbol # on the left of its coordinates.

#	-22.36	7.00	2.38			
1	-19.36	7.00	5.38	3.00	0.00	
2	-22.36	-4.20	2.25	0.00	-11.20	
3	-19.36	-4.20	5.25	3.00	-11.20	

You can position each drilling point in relation to the reference drilling point by modifying the values in the columns:

-  X coordinates in relation to the reference drilling point
-  Y coordinates in relation to the reference drilling point

To select another drilling point as the reference drilling point:

1 Select the drilling point you want to use as the reference drilling point

2 Press  to the right of its coordinates.

- > The selected drilling point is displayed at the top of the list:
 - The symbol # is displayed on the left of its coordinates
 - The drilling point is displayed in dark blue  in the work area.
- > The coordinates of the other drilling points are also updated.

3. DRILLING MODELS

A drilling model consists of all the drilling points configured and positioned on a shape. You can retrieve a model in order to re-use it.

This section describes the following:

- Importing a model on a job ([☞ p.83](#))
- Saving a model ([☞ p.84](#))

a. Importing a model

This function enables you to re-use the drilling points of a job in the shape management screen in the current job.

Importing a drilling model enables you to retrieve:

- The settings of the drilling points (diameter, depth, length, angle)
- The height of the drilling points in relation to the center of the shape (Y coordinates)
- The distance between the reference drilling point and the edge of the lens

1 From the drilling positioning screen, press  to access the list of drilled jobs saved in the shape management screen.

2 Select the desired list.

- > The drilled jobs in the selected list are displayed.

3 Select the desired job as a drilling model.

- > The model is displayed in the preview.

4 Press  to confirm import of the model.

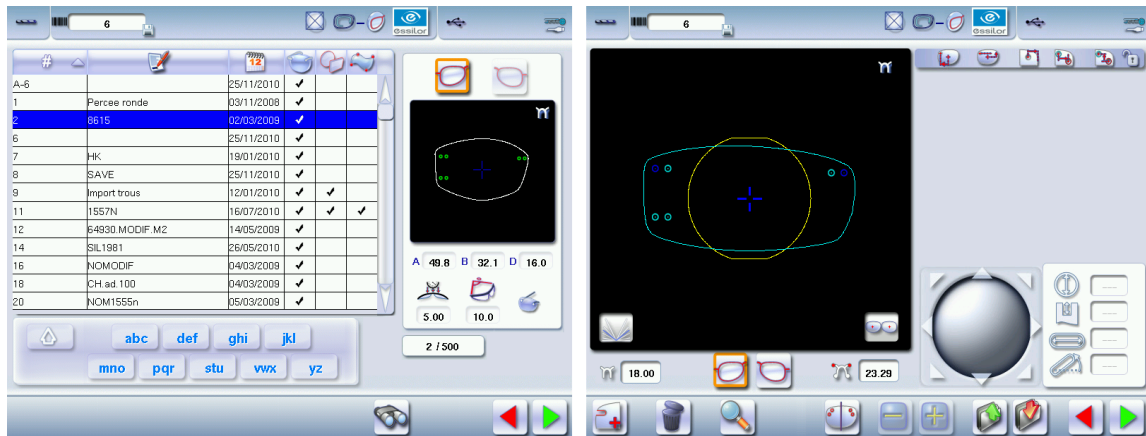

> The drilling screen is displayed:



> The drilling points are positioned in keeping with:

- The settings of each drilling point in the model
- The Y coordinates of each drilling point in relation to the boxing center of the model shape
- The distance between the reference drilling point and the edge of the lens

> Two values are displayed under the work area

-  **18.00** The D-dimension (in mm) you have entered for the tracing
-  **23.29** The separation (in mm) between the two reference drilling points on the nasal side (right lens and left lens)



Once the model has been imported, you can move the drilling points if you wish. For more information, consult the section Preparing a drilling job > configuring a drilling point (p.78).

b. Saving a model

This function makes it possible to memorize a shape and its drilling points in a new job with a new ID whilst saving the original job.

Saving a model enables you to save in a new job:

- The traced shape
- The value of the D-dimension
- The drilling settings
- The drilling heights in relation to the boxing center of the shape (coordinated in Y)
- The distance from reference drilling points in relation to the edge of the lens (other drillings, in relation to reference drilling)

1

Press  to save the job and its drilling points.

> The job-creation alphanumeric keypad is displayed.

- > A new ID is allocated (first free slot in the list).

You can also give it a different ID.

2 Enter a reference for your model.

3 Press on  to confirm.

- > The model is saved in a new job.

- > The new job with the new ID is displayed on the drilling screen.

4 Press  to return to the centering screen.



You can go back to the previous job via the shape management screen if it has an ID.

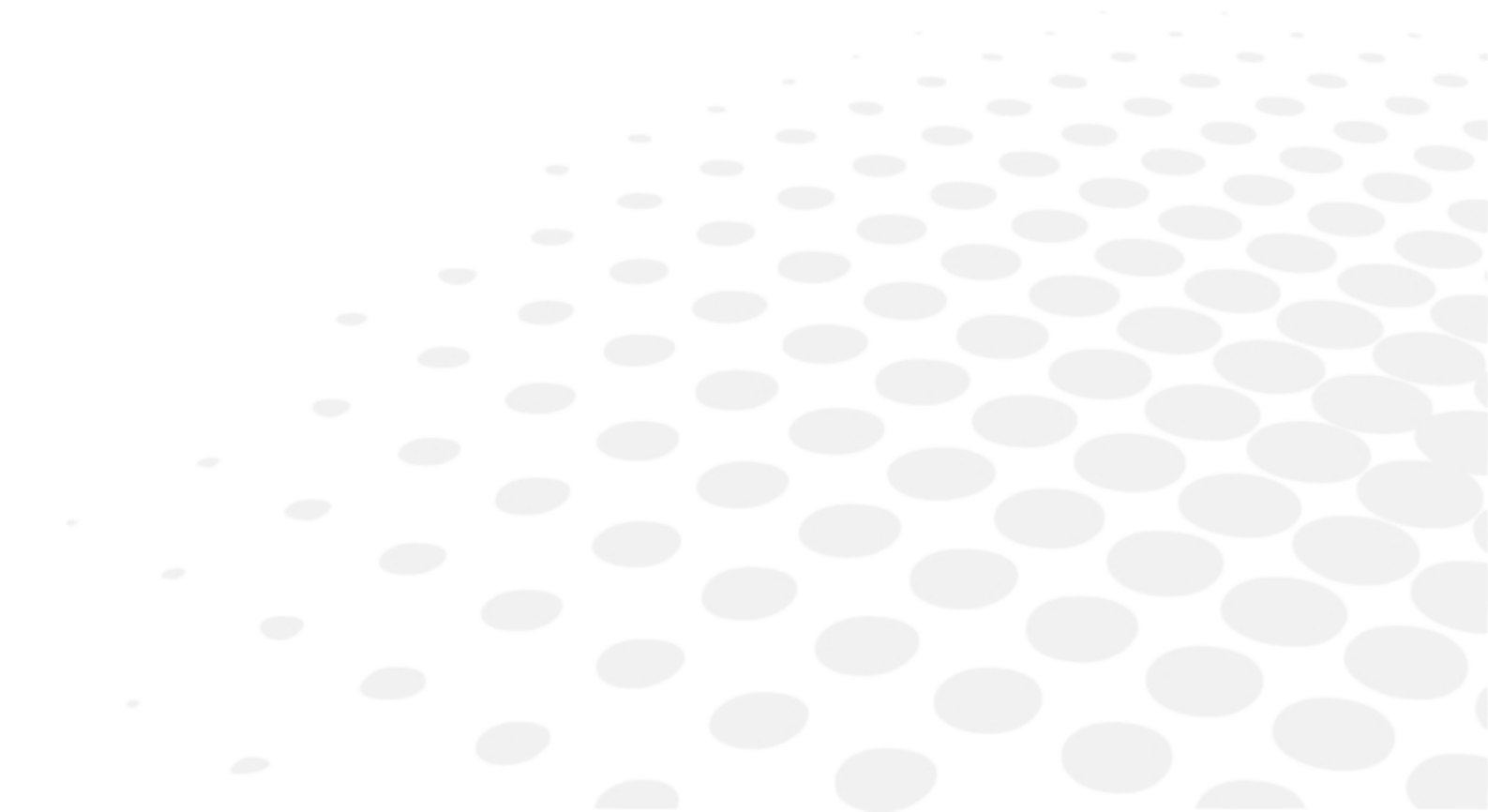

VI. PREPARING LENS EDGING



This chapter describes the procedure for preparing lens edging using the tracer-centerer-blocker, before calling the shape from the edger.

- Description of the edging preparation screen (☞ p.88)
- Edging settings (☞ p.90)

1. MENU SCREEN





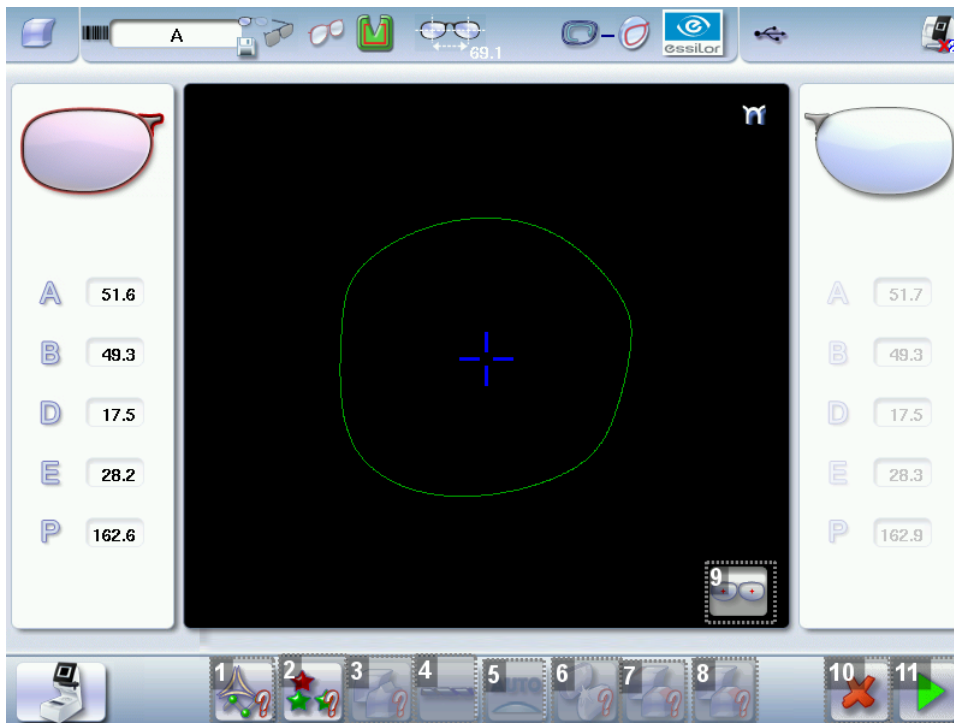

Press  >  to access the edging preparation screen.

 The screen changes according to the edger to which it is connected.

The following screen is displayed:





1. Lens material





-  Plastic lens - index 1.5⁰⁰
-  Polycarbonate lens
-  Medium/High index plastic lens - index > 1.5
-  Trivex lens™
-  Glass lens
-  Lens material to be defined on the edger

The configuration of the edging cycles depends on the type of material. An incorrect choice may result in material damage.

2. Cycle type



-  Standard cycle
For all types of materials.
-  EAS™
For all types of materials. This cycle offers a more sophisticated edging mode than the standard cycle, specifically for thin or small lenses, and hydrophobic lenses.
-  Type of cycle to be defined on the edger.

3. Type of finish

-  Bevel
-  Groove
-  Flat-edge
-  Finish to be defined on the edger



4. Accessing the drilling preparation screen

5. Edging mode





- 
- 

The edging mode is defined automatically according to the settings previously selected.



6. Polishing

-  Polished lens
-  Non-polished lens
-  Polishing to be defined on the edger

7. Front surface chamfering

-  Thin chamfer front surface
-  Thick chamfer front surface
-  No chamfering
-  Chamfer to be defined on the edger

8. Rear surface chamfering

-  Thin chamfer front surface
-  Thick chamfer front surface
-  No chamfering

-  Chamfer to be defined on the edger

9. *Displaying the binocular view*

10. *Cancel the settings / Restore the default settings*

11. *Save the settings / Return to the centering screen*

2. EDGING CONFIGURATION

You can enter the edging parameters prior to calling a job on the edger.

 Both lenses are configured simultaneously.

1 Press  to select the lens material.

 The configuration of the edging cycles depends on the type of material. An incorrect choice may result in material damage.

2 Press  to select the type of cycle.

3 Press  to select the type of finish.

4 Press  to activate/deactivate polishing.

5 Press  to select chamfering (option).

 The other buttons become accessible.

6 Press  to memorize the parameter setting and go back to the centering screen or the tracing screen, if the option is activated.

> When you call the shape from the edger, its edging settings will be automatically recovered.

VII. TRACER-CENTERER-BLOCKER CONFIGURATION

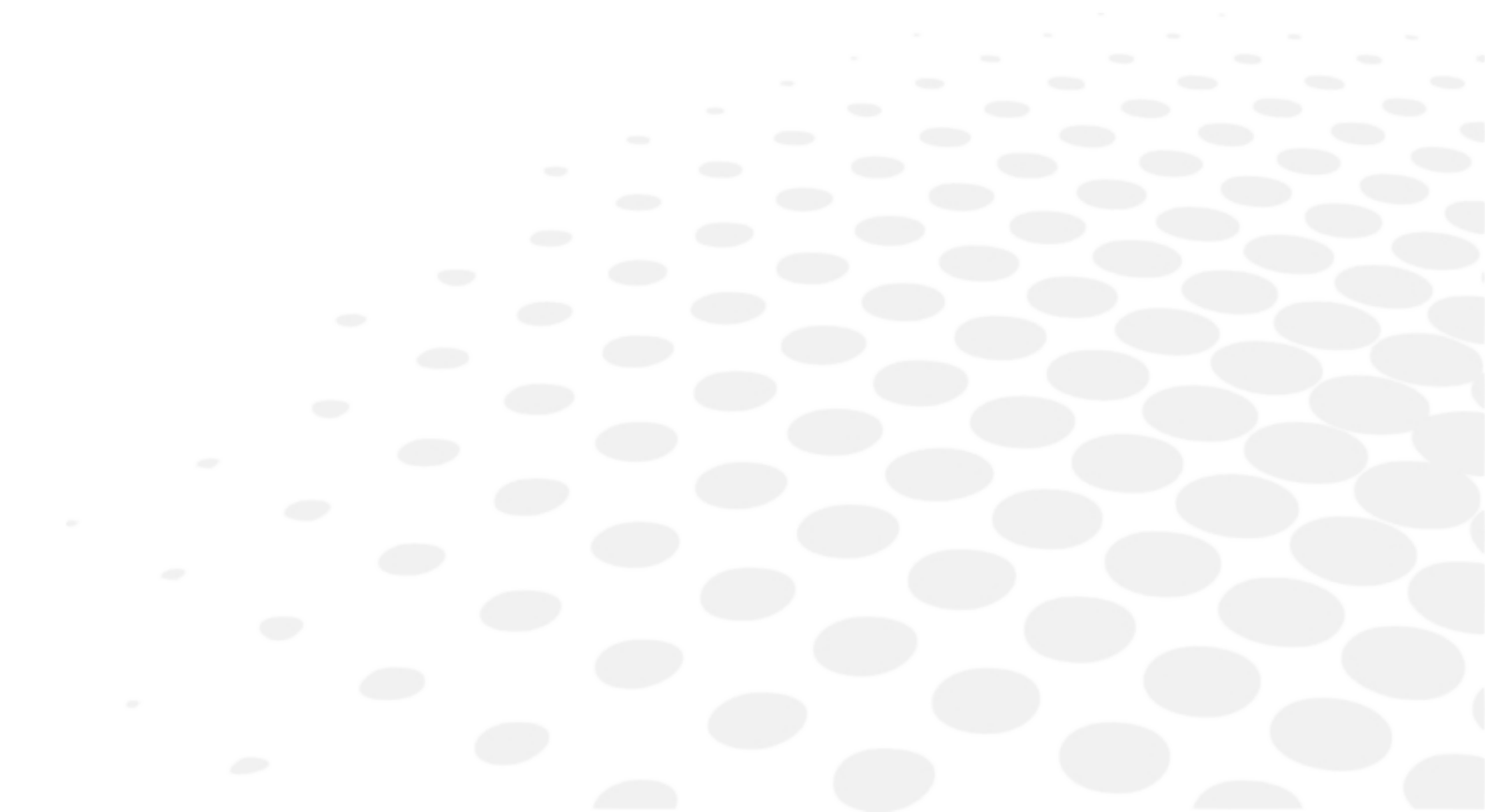

This chapter explains how to configure the tracer according to your requirements. You can:



- configure the tracer-centerer-blocker (☞ p.92) (time, date, language, connections, screensaver),
- customize the tracer-centerer-blocker (☞ p.96),
- restore the factory settings (☞ p.102).

1. CONFIGURE THE TRACER-CENTERER-BLOCKER

This section describes the procedures to:

- set the time, date and language (☞ p.92)
- access the connections and the network (☞ p.94)
- configure a screensaver (☞ p.95).

a. Time, date and language

To access this menu from your work screen, select  >  > .

The following screen is displayed:



1. Time

Use the  and  arrows to set the time.

2. Date

Use the  and  arrows to set the date.

3. Type of date display

Select the type of display out of the available formats.

4. Language

Select the flag corresponding to your language.

5. Other languages

Press  to display the other languages.

6. Confirm



Press  to save the time.

Once the settings are complete, press  to save the language and go back to the work screen.

b. Options

Four options are available on the tracer-centerer-blocker:

- optical tracing
- job memory
- connection to the Mr. Orange edger
- high-base tracing

To access the options menu, press  > .

Screen example:



1. Optical tracing activated

 not activated by default.

DEMO option available until the date indicated

2. Job memory activated

 activated by default.

3. Connection to Mr Orange activated

 not activated by default.

4. High-base tracing and remote lens edging not activated

 not activated by default.

DEMO option available until the date indicated

5. Serial number of the machine

6. Mac (Media Access Control) addresses of the machine

 To activate these options, contact your support technician. You will be given an activation key.

1 From this page, press .

- > If the tracer-centerer-blocker is connected to Essibox, the options are activated automatically via Essibox.
- > If the tracer-centerer-blocker is not connected to Essibox, the following screen is displayed:

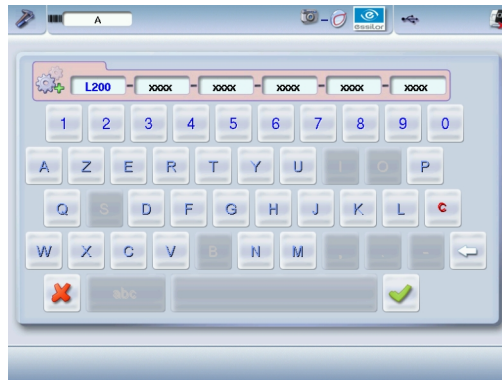

2 Enter the activation key supplied by your technician.

c. Connections

The connection to the edger or the Tess tracer is configured from the tracer-centerer-blocker.

 If necessary, first activate the connection to the Tess tracer via the customization screen. To do this, refer to the section Configuring the tracer > Customizing the tracer-centerer-blocker > Work modes and display precision ([p.97](#)).

To access the configuration menu for the connection from the work screen of your tracer-centerer-blocker,

select  >  > .

The following screen is displayed:



1. Selection of the mode of detection of devices connected to the tracer-centerer-blocker
 - In automatic mode, all the products detected are connected to the tracer-centerer-blocker.
 - In manual mode, check the products you want to connect to the tracer-centerer-blocker.

2. List of devices connected to the tracer-centerer-blocker

3. Settings linked to the configuration of the Ethernet port

4. Settings linked to the configuration of the RS232 port (PC)



5. Settings related to configuration of the RS232 port (edger)

6. Reinitialization of communication ports

Once the change has been made, press  to return to the work screen.

d. Screensaver and brightness of the work area



This menu is used to configure a screensaver and the brightness of the work area.

To access this menu from your work screen, select  >  > .

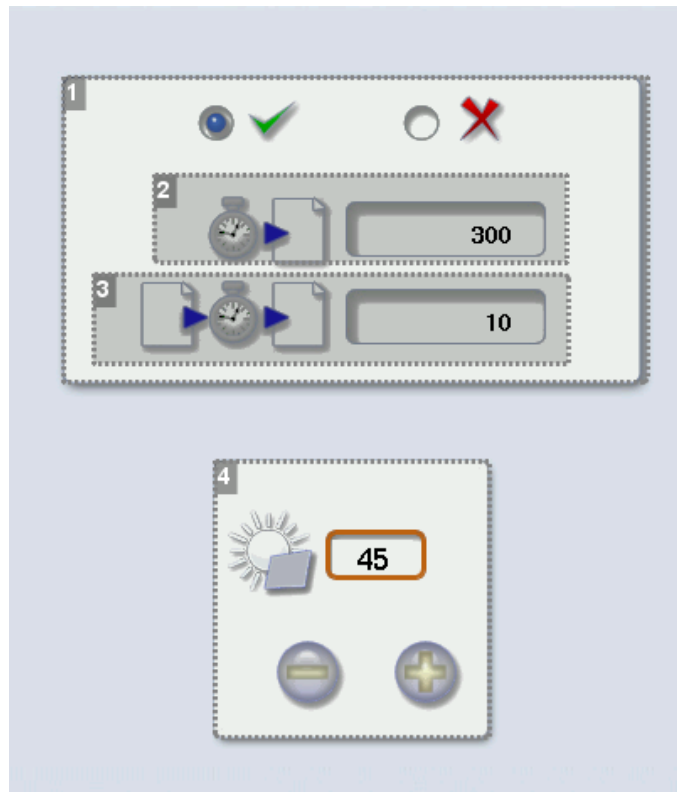
The following screen is displayed:



1. Screensaver display

Activate  or deactivate  the screensaver.

2. Triggering

Set the waiting time before the display of the screensaver (in seconds).

3. Transition

Set the transition time between each image (in seconds).

4. Adjusting the default brightness of the touch screen

Once the change has been made, press  to return to the work screen.

2. CUSTOMIZE THE TRACER-CENTERER-BLOCKER,



This section will enable you to customize the tracer according to your requirements:

- Customising the working modes and display precision ([p.97](#))
- Choosing a decentration mode ([p.98](#))
- Customising the action bar ([p.99](#))
- Adjusting the brightness ([p.101](#))

a. Working modes and display precision

This menu is used to customize the tracer-centerer-blocker to suit your work preferences:

- the working mode
- the display of the precision measurements,
- the zoom on the centering page,
- the blocking mode in the boxing center or optical center.

To access this menu from your work screen, select  >  > .

The following screen is displayed:

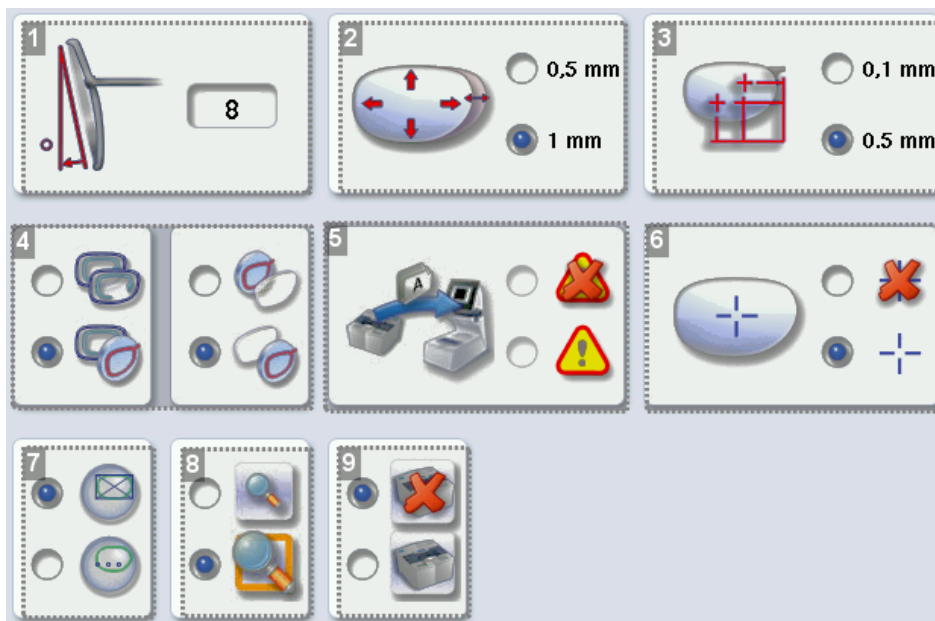

1. Pantoscopic tilt

- Press on the tilt value to modify it.
> The numeric keypad is displayed.
- Enter the angle (between -5° and $+25^\circ$).
- Press on  to confirm.

2. Shape modification

Select the desired step for the shape modification.





3. PD and pupillary height

Select the desired step for input of the PD and pupillary height.

4. Working mode

Select the default working mode:



-  +  Tracing-tracing
-  +  Tracing - centering

-  +  Centering - preparing edging
-  +  Preparing edging - centering

5. Warning message on import of a current Tess job (if the Tess connection is activated)



-  Activated
-  Deactivated

6. Boxing cross in the centering screen



-  Displayed
-  Not displayed

7. Lens blocking

Select the lens blocking mode:

-  in the boxing center
-  in the optical center

8. Zoom

-  The work area is scale 1:1 by default in the centering screen.
-  The work area is in zoom mode by default on the centering screen.



9. Activation or deactivation of Tess tracer connection

Connection deactivated by default

Once the change has been made, press  to return to the work screen.

b. Decentration mode

This menu enables you to select a default input mode for decentration data.

To access this menu from your work screen, select  >  > .

The following screen is displayed:

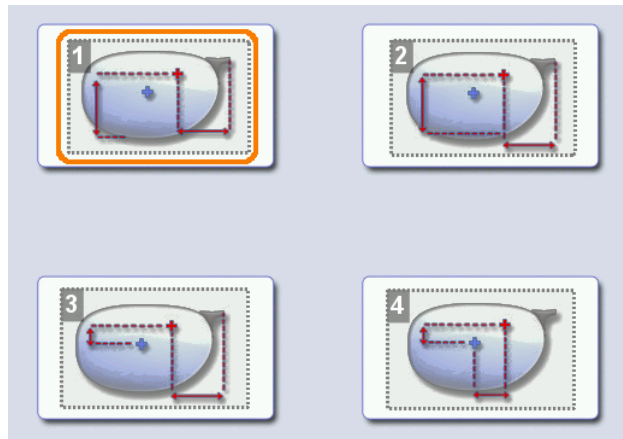

1. Boxing mode ($\frac{1}{2} PD + \text{Boxing Height}$)

The wearer's pupillary height is calculated in relation to the lowest point on the frame.

2. Datum mode ($\frac{1}{2} PD + \text{Datum Height}$)

The wearer's pupillary height is calculated in relation to the point of intersection with the frame.

3. ΔY mode ($\frac{1}{2} PD + \Delta Y$)

ΔY : This value corresponds to the difference in height between the boxing center of the shape and the center of the wearer's pupil.

4. $\Delta X + \Delta Y$ mode

ΔX : This value corresponds to the horizontal distance between the boxing center of the shape and the center of the wearer's pupil.



ΔY : This value corresponds to the difference in height between the boxing center of the shape and the center of the wearer's pupil.

Once the change has been made, press  to return to the work screen.

c. Action bar

This menu enables you to customize the action bar according to your requirements. You can:







- enable default options so that they are displayed first in the job options,
- disable options you do not require so they are no longer displayed in the job options.

To access the customization menu of the action bar from your work screen, select  >  > .

The following screen is displayed:







1. Type of tracing



-  Symmetrical binocular
-  Asymmetric binocular
-  Right eye monocular
-  Left eye monocular
-  Monocular right eye only
-  Monocular right eye only

2. Type of frame

Four choices are possible.

-  Metal frame
-  Plastic frame
-  Optyl frame, for particularly flexible frames
-  Automatic detection

3. Tracing mode

-  Pattern
-  Demo lens / Recut lens

4. Type of lens

-  Single vision lens
-  Progressive lens
-  Bifocal lens

-  Executive lens
-  Mid-distance lens

5. Press to move to the next page

6. Press to go back to the first page



7. Edger(s) selection page

In automatic mode, the tracer detects the edger to which it is directly connected.

In manual mode, you can select the edger to which the tracer should connect.

Customizing the action bar



Press an option button several times to change its status in the tracing or centering screen:

-  Option enabled: the option can be selected in the action bar drop-down menus.
-  Option disabled: the option is no longer displayed in the action bar.
-  Option circled in orange: the option is displayed and selected by default in the action bar.

Once the change has been made, press  to return to the work screen.

d. Brightness

You can adjust the default brightness of the work area and/or the touch screen in order to improve your view of the lens to be centered.

To access the brightness customization menu from your work screen, select  >  > .

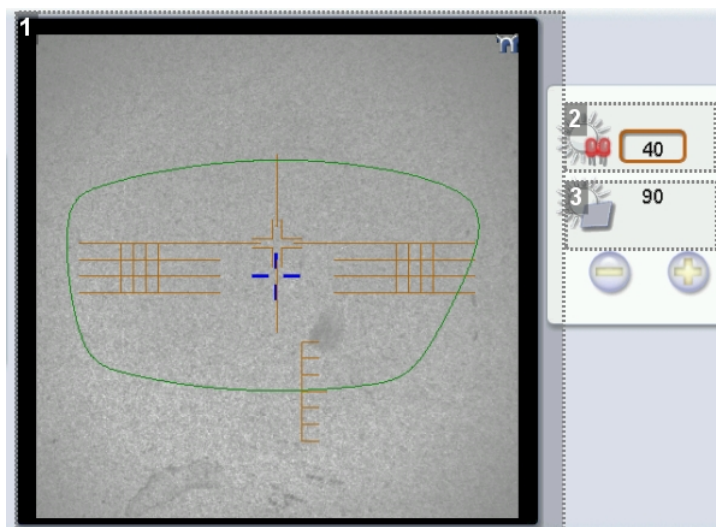

The following screen is displayed:



1. Overview of the work area

2. Adjusting the default brightness of the work area

3. Adjusting the default brightness of the touch screen



Press  or  to decrease or increase brightness.

Once the modification is made, press  to return to the work screen.

3. RESTORING THE FACTORY SETTINGS

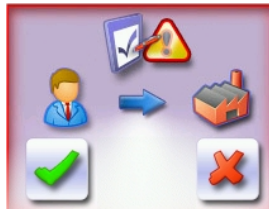
At the bottom right of certain settings screens of the tracer-centerer-blocker, the  button can be used to restore the factory parameters of the page.



- Press  to cancel and go back to the settings screen.
- Press  to confirm reinitialization.

VIII. MAINTENANCE & SERVICING

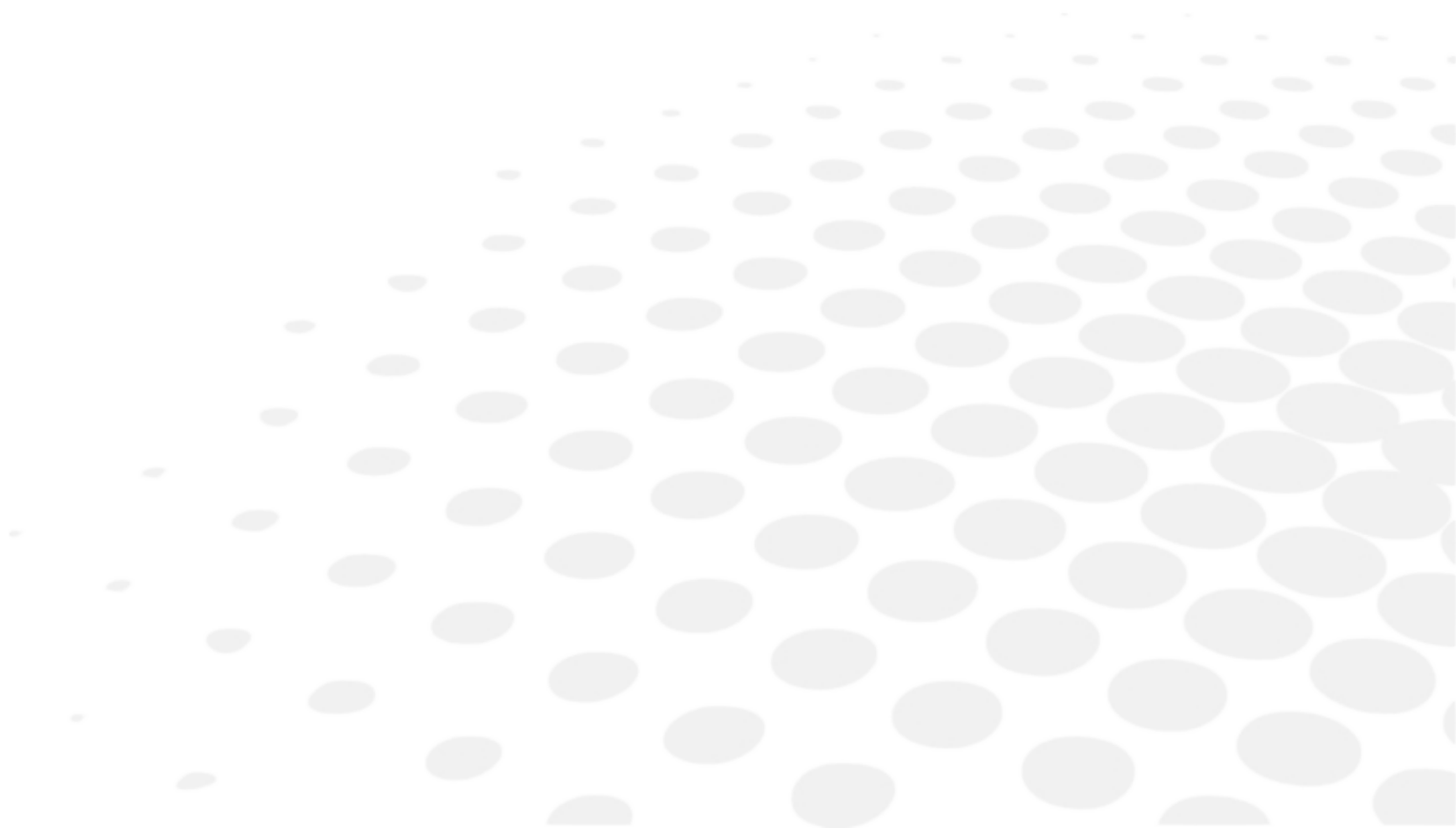

This chapter describes the maintenance procedures you can carry out on the tracer centerer-blocker without the help of a technician.

- Carry out autotests (☞ p.104)
- Checking and calibrating the tracer (☞ p.105)
- Viewing the statistics and technical history (jobs and actions carried out) (☞ p.113)
- Maintain and clean the tracer (☞ p.115)

1. CARRYING OUT THE AUTOTESTS

This menu is used for auto-diagnosis of the tracer-centerer-blocker functions and to test the operation of the blocking arm and the tracing table.

Blocking arm

Select  >  from the work screen.



1. *Blocking arm movements*

2. *Optical tests*



1 Select the autotest to be carried out.

2 Press  to start the test cycle.



> A warning message is displayed.

3 Remove any objects from within the centering chamber.

4 Press on  to confirm.

 You can press  to stop the auto-test cycle on the arm at any time.

> The result is displayed on the right of the icon of the autotest carried out:

-  The equipment is operational.
-  A malfunction has been detected, a description is shown in the message box at the bottom of the screen.

Tracing table

To test the operation of the tracing table, select  >  >  from your work screen.

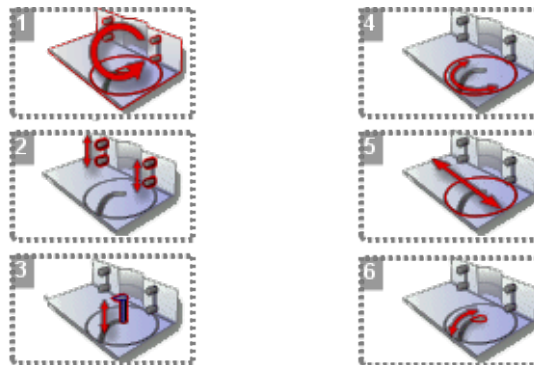

1. Tracing table autotests

2. Clamps

3. Vertical movement of the feeler

4. Rotation of tracing table core

5. Displacement of tracing table core

6. Feeler movement

1. Select the autotest to be carried out.
2. Press  to start the test cycle.

To interrupt the cycle at any time, press .

> The result is displayed on the right of the icon of the autotest carried out:

-  The equipment is operational.
-  A malfunction has been detected, a description is displayed in the message box on the right.



2. CHECK AND CALIBRATE (REMOTE LENS EDGING OPTION)

This section describes the procedures to follow if you note mounting problems that may be due to tracing or centering operations.

- Check the tracing table then calibrate it if required ([☞ p.105](#))
- Check the tracer-centerer-blocker then calibrate it if necessary ([☞ p.108](#))
- Calibrate the touch screen ([☞ p.110](#))

a. Check and calibrate the tracing table (option)

If you encounter mounting problems, you can check the calibration of the tracing table.

From the work screen of your tracer, select  >  > 

The following screen is displayed:

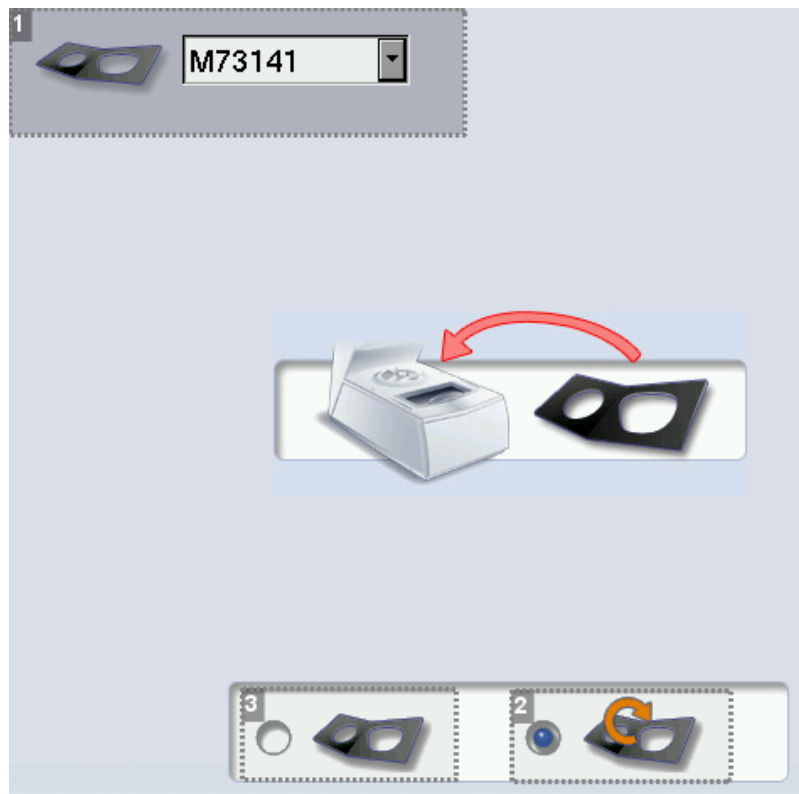

1. *Frame gauge reference*
2. *Calibration check*
3. *Calibration*

Checking the calibration of the tracing table.

 Before you start the calibration test, make sure that the reference of the frame gauge displayed on the screen is the same as that marked on the gauge.

- If it is not identical, press  to display the drop-down list: select the reference corresponding to the gauge.
- If none of the references match that marked on the gauge, contact the technical department.



1 Select .

2 Insert the pattern gauge in the tracing table.

3 Press  to start the test.

4 Wait: a timer  is displayed for a few minutes.

> The test is finished:

-  The check is successful: press  to go back to the work screen.
-  The test has failed: run a calibration cycle.

Calibrating the tracing table

This procedure must be followed if the above calibration check has failed.

1 Select  to start the cycle.

> The image of the pattern holder is displayed:





2 Attach the pattern gauge to the pattern holder then insert it into the tracing table.



The pattern gauge is considered as a left lens. For more information on fixing the gauge on the pattern holder, refer to the section Tracing > Tracing a pattern, a demo or recut lens > Mechanical tracing (☞ p.32).

3 Select  to start the cycle.

4 Wait: a timer  is displayed for a few minutes.

>  : The first calibration phase is finished.

> The image of the frame gauge is displayed:





5 Insert the frame gauge in the tracing table.

6 Close the jaws.

7 Select  to start the cycle.

8 Wait: a timer  is displayed for several minutes.

>  : The calibration is finished.

Calibration finished, you can restart the control cycle  to check.



 If the calibration fails, restart the cycle. If it fails again, contact the technical department.

Press  to go back to the work screen.

b. Check and calibrate the blocking arm

If you encounter problems with centering or blocking, you can check the calibration of the centering chamber and blocking arm.

 If the device has been moved, it is recommended to check the arm calibration.

From the work screen, select  >  > .

The following screen is displayed:

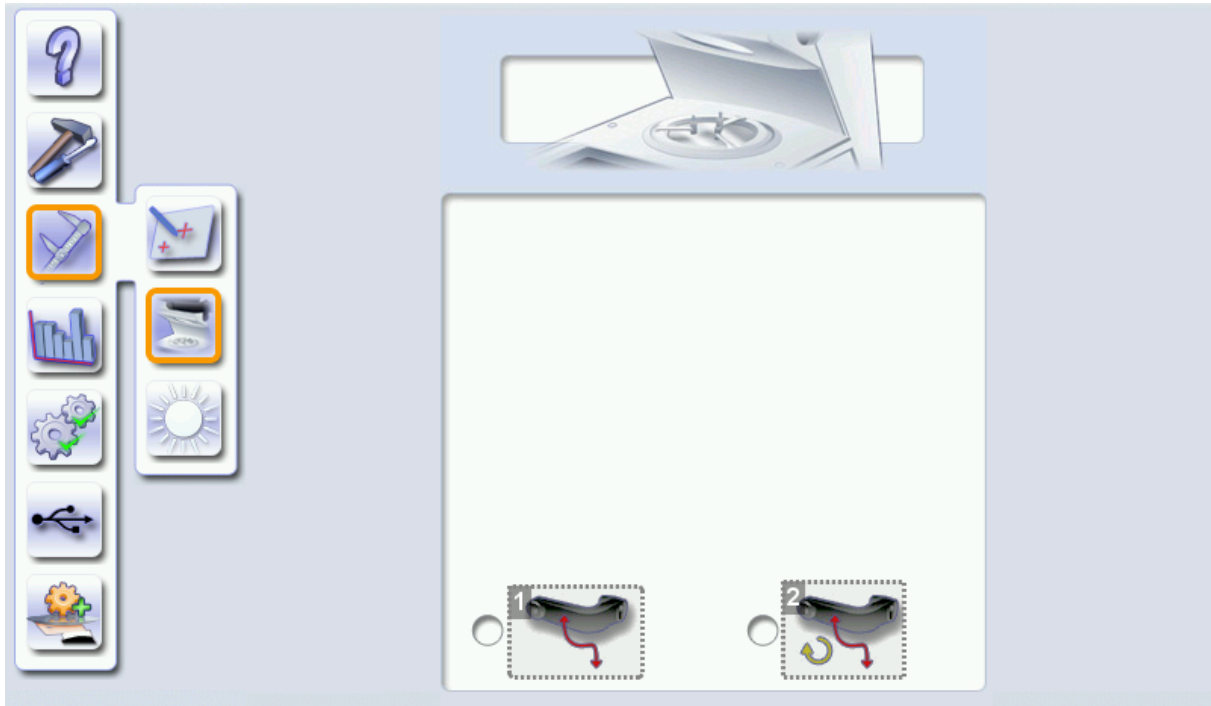

1. Blocking arm calibration

Only calibrate the blocking arm if the check fails.

During calibration, the centerer-blocker detects the placement of the arm in blocking position, in order to guarantee its precision.

2. Checking the calibration of the blocking arm

If the check fails, calibrate the blocking arm.

Checking or calibrating the centerer-blocker

 Prerequisite: Make sure the blocking head is empty before starting the check or calibration.

1 Select the desired option.

2 Press  to start the cycle.

> A warning message is displayed.

3 Remove any objects from within the centering chamber.

4 Press on  to confirm.

>  The procedure was successful

 The procedure failed

- If the check fails, calibrate.
- If the calibration fails, restart the cycle. If it fails again, contact the technical department.

c. Calibrate the touch screen

Calibrate the touch screen if your operations have become difficult due to lack of precision.





Touch screen malfunction

You can access the calibration screen directly without going through the settings menu. To do this, press on the centering screen for 5 seconds.

Calibrating the touch screen

1 Select  >  >  from the work screen.

> A confirmation message is displayed:

- Press  to start calibration.
- Press  to cancel and return to the menu



2 Point precisely on each cross as they are displayed, holding the stylus perpendicular to the screen so as not to alter the calibration.

> The settings menu is displayed automatically once the calibration is finished.

3 Press  to return to the work screen.

3. MAKE A BACKUP OF THE JOBS AND DISPLAY CONFIGURATION

1 Connect the backup USB key to the tracer.

2 From the work screen, select  > .

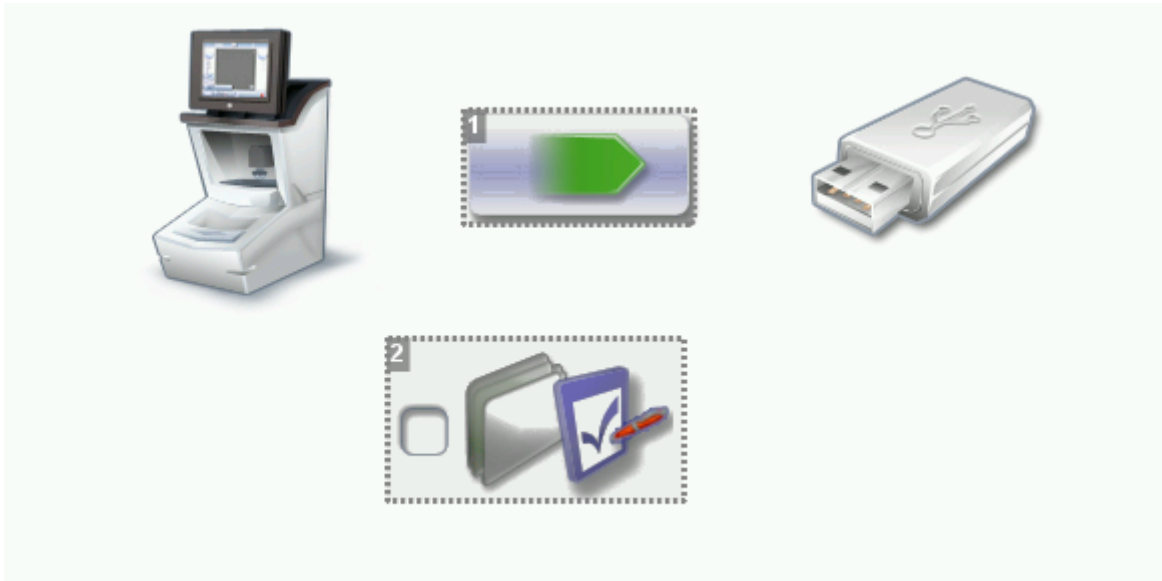

> The following screen is displayed:



1. *import/export data*

2. *Customisation of the display*

3 Press  to select the action to perform.

-  : perform a backup
-  : import a backup.



On the data import screen, it is possible to import the calibration gauge data of the tracing table

(option):  .

4 Click to backup the jobs and tracer customization: .

5 Press  to start the operation.

> Once the backup is performed, a file is created on the backup key:

Product number L20XXX - Product serial number XXXXXX- Optician- Date "XX/XX/XXXX"-Time "XXhXXmXXs"



Example:  L20011-103108-Optician-07-01-2014_17h43m51s





It is advisable to backup your jobs regularly.

To import on the tracer:

- a previously created backup
- the jobs and configuration of the tracer or another Neksia tracer,
- calibration data of the tracing table calibration gauge (option).

1 Connect the backup USB key to the tracer.



2 From your work screen select  > .

> The backup screen is displayed.

3 Press  to import the data present on the backup key.



4 Choose:

-  to import the jobs and display configuration
-  to import calibration gauge data (option).



If several backups are present on the key, take care to choose the one you want to restore.

Check the product serial number and the date and time of backup.

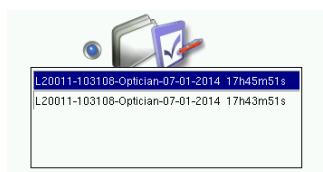

5 Press  to start the operation.

> A message is displayed asking you to remove the USB key.

6 Remove the USB key.



- > The product restarts with the selected configuration.

4. STATISTICS AND TECHNICAL HISTORY

This menu enables you to visualize the number of cycles carried out by the tracer-centerer-blocker. It also gives you access to the technical history.

- Tracer-centerer-blocker statistics (📄 p.113)
- Technical history and errors (📄 p.114)







a. Tracer-centerer-blocker statistics

From the work screen, select  >  >  to view the number of cycles carried out by the tracer-centerer-blocker.



The following screen is displayed:



1. Tracings carried out with the tracer connected to the tracer-centerer-blocker

-  Total number of tracings
-  Asymmetric binocular tracing
-  Symmetric binocular tracing
-  Right-eye monocular tracing
-  Left-eye monocular tracing
-  High-base frame tracing (option)
-  Mechanical tracing (patterns, demo lenses or recut lenses)

2. Traced frame materials

-  Metal frame: high-precision tracing, with feeling of the groove
-  Plastic frame

3. Optical tracings

4. Tracing table tests and calibrations

5. Next page / Previous page

6. Centering operations

7. Blocking operations

8. Blocking arm calibration and calibration checks

9. Partial counter

Number of actions performed since the last reset to zero.

10. Total counter

Total number of actions performed.

11. Reset

You can reset a partial counter to zero:

- a. Select the cycle counter to reset to zero.
- b. Press  to reset it to zero.

b. Technical log and errors

From the work screen, select  >  >  to access the list of error messages.

The following screen is displayed:

#	1	2
3 4502	17	17
1028	15	15
6200	15	15
6526	10	10
6005	7	7
8600	7	7
6004	4	4
6006	4	4
6201	3	3
6002	2	2
6041	2	2
6042	2	2
6557	2	2

4 1/2

5 041 – Tracing defect: symmetric tracing cycle unsuited to this type of frame. Please restart the tracing in unsymmetric binocular mode.

1. Partial counter

Number of error messages displayed since the last reset to zero.

2. Total counter

3. Error message codes

Classed by display frequency.

4. Error message pages

5. Description of selected error

Use the scroll box on the right of the message box to scroll through the text.

Press  to return to the work screen.

5. MAINTAIN AND CLEAN THE TRACER-CENTERER-BLOCKER

This section describes the tracer-centerer-blocker maintenance and cleaning procedures:

- Precautions required ([☞ p.115](#))
- Cleaning the centering chamber glass ([☞ p.115](#))

a. Precautions required



To avoid any incidents, unplug the device before all cleaning operation.

- Clean the cover of the tracer-centerer-blocker regularly: use a neutral detergent (e.g.: dishwashing liquid) diluted with water on a soft cloth.
- Clean the window of the centering chamber and the touch screen regularly with a soft dry cloth: it must never come into contact with liquids (e.g.: water, alcohol, window cleaner).



- Never touch the components of the optical block, located at the top of the centering chamber, as this could affect the performance of the centering device.
- Never clean the apparatus with chemical products (e.g.: petrols, thinners, solvents).

b. Cleaning the centering chamber glass

A dirty or scratched glass may cause tracing and centering faults. It must be replaced by a technician.

Take care of it and clean it regularly using a soft, dry cloth.



Never pour liquid on the glass pane of the centering chamber.

TECHNICAL DATA

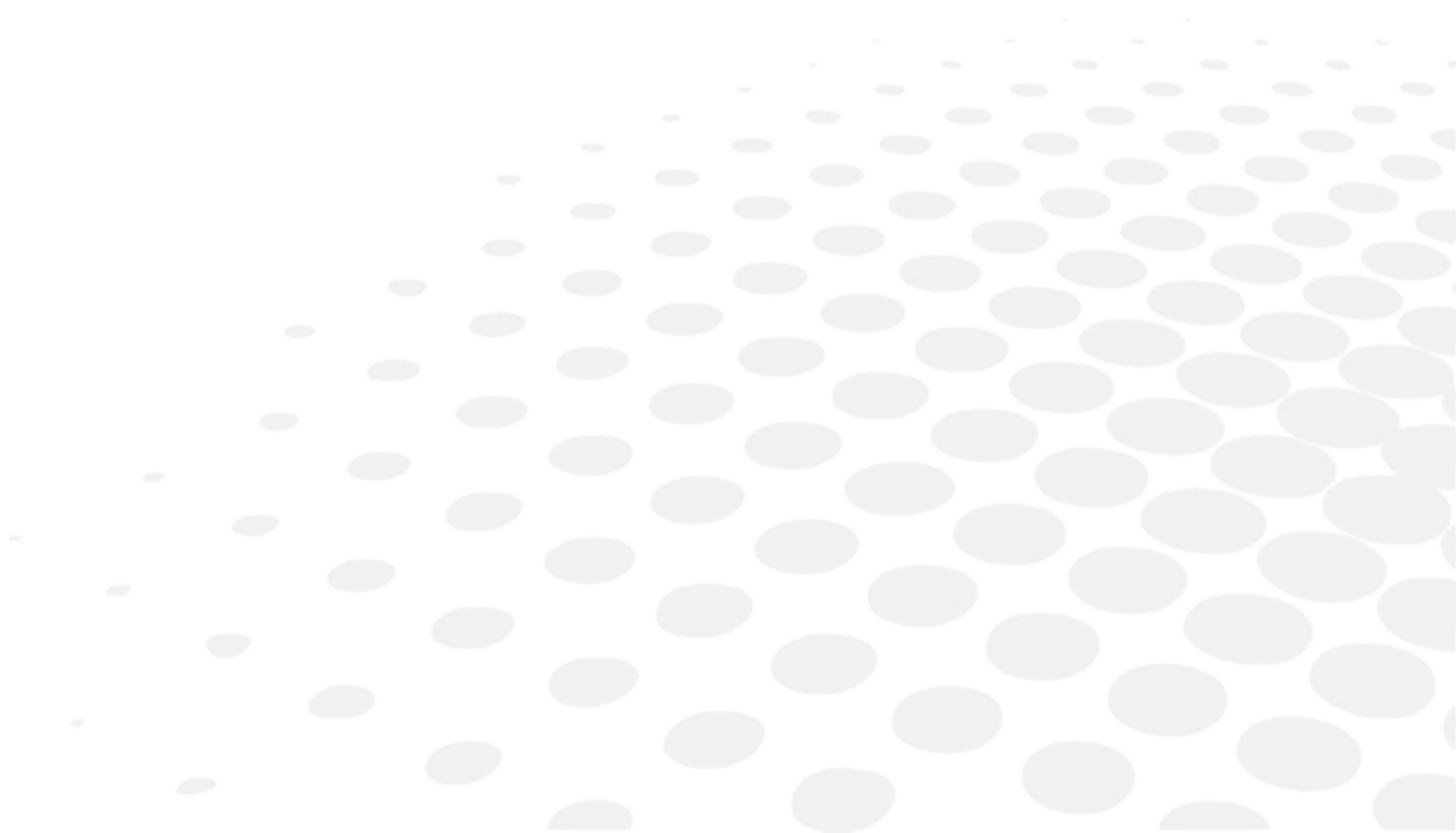

- Tracer-centerer-blocker (*☞ p.118*)
- Environment (*☞ p.119*)

1. TRACER-CENTERER-BLOCKER

The motorized tracer-centerer-blocker allows a frame, pattern or demo lens to be traced and a lens to be centered and blocked.

Centering-blocking mode: boxing center (default); optical center

Automatic initialization

Optical tracing (option):

- Tracing of tinted lenses
- Tracing of patterns, demo lenses and recut lenses in 2 dimensions
- Automatic tracing of patterns, demo lenses and recut lenses
- Pre-positioning of the drill-holes and their settings on a demo lens or a recut lens
- Recut lens: equivalent sphere [- 4D; +4D]

Manual centering:

- Single vision lenses: using focimeter dots or re-marked micro-engravings
- Progressive lenses: using re-marked micro-engravings or manufacturer markings
- Bifocal and trifocal lenses
- Executive lenses
- Mid-distance lenses: using re-marked micro-engravings or manufacturer markings

Centering in boxing center or optical center.

Centering help:

- Single vision lenses: partial or total detection of the focimeter dots

Specific centering target for each type of lens: single vision, bifocal/trifocal, progressive, executive, mid-distance

2-track optical video system: without parallax

Magnification: x1 or x1.82

Input of job distances:

- PD: 1/2 PD, ΔX
- Boxing height, Datum height, ΔY
- Modification by steps of 0.1 mm or 0.5 mm

Pantoscopic tilt: from -5° to $+25^\circ$

Shape modification:

- Scaling, A-dimension, B-dimension, $\frac{1}{2}$ A-dimension, $\frac{1}{2}$ B-dimension, D-dimension, modification in one point, rotation
- Retouch
- Modification by steps of 1 mm or 0.5 mm

Electronic blocking command with pressure control

Display of Precal dimensions

Toolbar customization

Networking possibility:

- Essilor tracer-centerer-blockers
- Essilor edgers
- PC
- Essibox

RS232C, RJ45 and RS485 ports

Communication protocol: OMA (ISO 16284)

Integrated auto-maintenance functions (self-calibration, autotests)

Dimensions: L 280 mm, P 520 mm, H 610 mm

Size of colour touch screen: 8.4 inches

Weight: 18.2 kg

External power supply: 100-240 V - 50-60 Hz,

- input: 1.3 A
- output: 12 V - 3.3 A

Power supply voltage produced: 12 V continuous - 3.3 A

Power consumption: 40 W



Due to constant improvements, these specifications may be modified without prior notice.

2. ENVIRONMENT

Your machine should preferably be installed on a perfectly flat and stable work surface of suitable height (about 70 cm), free from shocks and vibrations, to benefit from the high accuracy of your tracer-centerer-blocker. Your tracer may be installed on the right or left of your edger. The tracer may be installed up to 5 m away from the edger (a 5 m cable is supplied with the edger). Longer cables are also available on an optional basis.

The temperature and humidity of the room where you use your machine must be within the following ranges:

Operation:

- temperature between +10 °C and +40 °C
- Humidity: between 30% and 75%

Storage:

- temperature between -5 °C and 50 °C
- Humidity: between 25% and 95%

Altitude: < 2,000 m

Level of pollution: 2

Avoid sudden changes in temperature and humidity and install your system:

- in an area not directly exposed to sunlight
- away from all heat sources
- away from all strong magnetic fields
- away from all chemical products, corrosive vapours and liquids

Take care not to block the vents and to leave enough space above the device. Do not place any object on the device. Avoid exposing the device to vibrations or shocks.



The back of your machine must be at least 20 cm away from a wall.



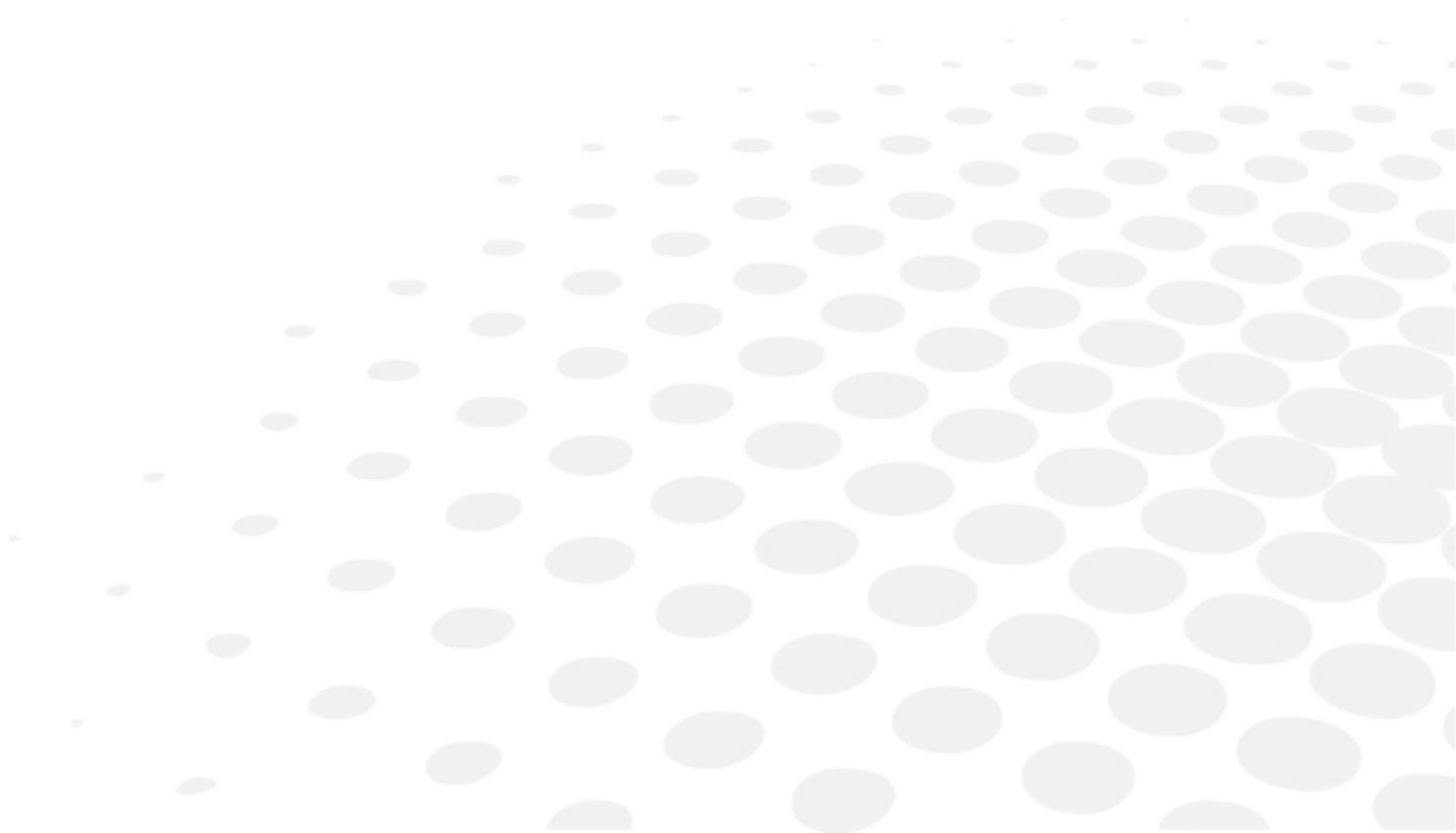

This machine is neither adapted nor intended to operate in an environment where there is a risk of explosion.







GENERAL INFORMATION



- Description of the symbols (☞ p.122)
- Modifications (☞ p.122)
- Compliance (☞ p.122)
- Copyright (☞ p.123)
- Materials and products (☞ p.123)
- Security (☞ p.123)
- Electromagnetic waves (☞ p.124)

1. SYMBOLS

SYMBOLS PRESENT ON THE DIGITAL SYSTEM	
O	Off (power)
I	On (power)
— — —	D.C. current speed
	Polarity
	Caution: risk of electric shock
	Caution: danger, refer to the user manual
	Disposal of this electrical and electronic equipment

SYMBOLS PRESENT IN THE DOCUMENT	
	Danger: risk of injury
	Caution: risk of damage for the machine or the lens
	Note: additional information
	Tip: practical advice for use
	Glossary: indicates a word defined in the glossary
	See also: indicates the page number to consult for further information

2. MODIFICATIONS

The information contained in this document is non-contractual and provided as a guide. It is subject to change without prior notice. Errors or omissions may occur in this type of document, although the greatest care has been taken to ensure the accuracy of the information provided. Essilor cannot be held responsible for any malfunction or loss of data resulting from such errors or omissions.

3. DECLARATION OF CONFORMITY

Complies with marking: 

Complies with standards ISO 16284, IEC 61010-1 and IEC 61326-1 and with directives 2014/30/EU and 2014/35/EU.

This equipment complies with the limits imposed by Part 15 of the FCC rule. Its use meets the following conditions: (1) this device must not cause interference and (2) must accept interference from external sources, notably that liable to cause malfunctions.

In accordance with the requirements of FCC rules, any modification made to this equipment which is not expressly approved by ESSILOR INTERNATIONAL would nullify the user's right to use this device.

This equipment has been tested and is deemed compliant with the limits imposed for Class-B digital devices according to Part 15 of the FCC rule. Those limits are set so as to ensure reasonable protection against interference in a residential environment. This equipment generates, uses and may emit radiofrequency energy liable to interfere with radio communications if the device is not installed and used in strict compliance with manufacturer instructions. However, nothing guarantees the absence of interference under particular conditions. If this equipment is the source of interference with radio or television reception (this can be confirmed by switching off the device then turning it back on), the user may be able to eliminate this interference through one or more of the following measures:

- Swivel or move the affected receiver or its receiving antenna;
- Move the device away from the affected receiver;
- Connect the device to a different circuit to that powering the affected receiver;
- Request help from the retailer or a qualified radio / television technician.

4. COPYRIGHT

Copyright © 2013 Essilor - Translated from the original manual

All rights reserved. Any reproduction of the content of this document, whether in part or as a whole, for the purpose of its publication or dissemination by any means and in any format whatsoever, even free of charge, is strictly prohibited without prior written consent from Essilor.

5. MATERIALS AND PRODUCTS

Do not place this machine in a dusty environment, in a room where the temperature is too high or too low or in a damp place.

This product notably has a joint on/off button and a hazard label that it contains Bis (2-éthylhexyle) Phthalate (DEHP).

6. SAFETY INSTRUCTIONS:

All mechanical or electronic adjustments and electrical maintenance must be carried out by a customer service technician approved by Essilor.

The use of an accessory or a cable other than those recommended in this manual can be dangerous for users.

Check the power cable regularly; if damaged, have it replaced by an approved repairer.

Do not use your system in any way other than described in this document. Otherwise, the protection provided by the device could be compromised.

Never try to modify or dismantle this product yourself. In addition to the fact that you are likely to damage the instrument, you can also injure yourself.

Your tracer must be carefully maintained, in accordance with the instructions detailed in this document.

Your system is an electrical appliance compliant with the applicable safety standards. In the event of malfunction, repairs must be carried out by qualified personnel approved by Essilor. Otherwise, user safety is likely to be compromised.

In the event of a long period of non-use and before maintenance and/or replacement of certain accessories, you must unplug your system from the mains.

The equipment must be plugged into an earthed power supply. The earthing must comply with public standards and be checked by a technician. Avoid using extension cables or adaptors which could create a poor contact.

Never pull on the cables to unplug them from the power socket.

Before plugging your tracer into the mains, check that the switch is set to OFF or 0.

If the switch no longer operates ON/OFF (0/I) you must stop using your tracer. Defective switches must be replaced by an approved repairer.

Your system is a professional tool which must only be used by specialized, responsible operators. It should not be used by anyone else.

This machine is neither adapted nor intended to operate in an environment where there is a risk of explosion. Do not use this system in the presence of liquids or flammable gases.

Make sure that the equipment is connected to a mains supply which complies with standard NFC 15-100. In addition, make sure that the plug type is 3-pin 10/16 A (earthed) protected by a high sensitivity differential circuit-breaker, maximum 30 mA, and that the wall outlet is easy to access.

LEDs used by the tracer:

Radiation emitted by the LEDs.

Do not look directly at the light when you use optical instruments.

Class 1M LED device

Maximum power emitted: 1.3 MW; 107 mJ

Wavelength: 400-800 nm

Name of the standard and publication date (IEC 60825-1:1993 / A2:2001).

7. ELECTROMAGNETIC WAVES

Electromagnetic waves emitted by television sets or radios, mobile phones, radio transmitters, etc. are liable to cause malfunctions in the instrument. This instrument is also liable to interfere with radio or television sets, mobile phones, radio transmitters, etc. Avoid installing or positioning devices which may create interference near the instrument. Likewise, never place the instrument on or near this type of device. This could generate malfunctions or faults in the instrument.

Interference and micro-outages

The products have been designed to withstand interference and operate despite its presence and the possibility of micro-outages on the network. However, if these malfunctions are too serious and abnormal, the machine cannot be guaranteed to operate normally.

GLOSSARY

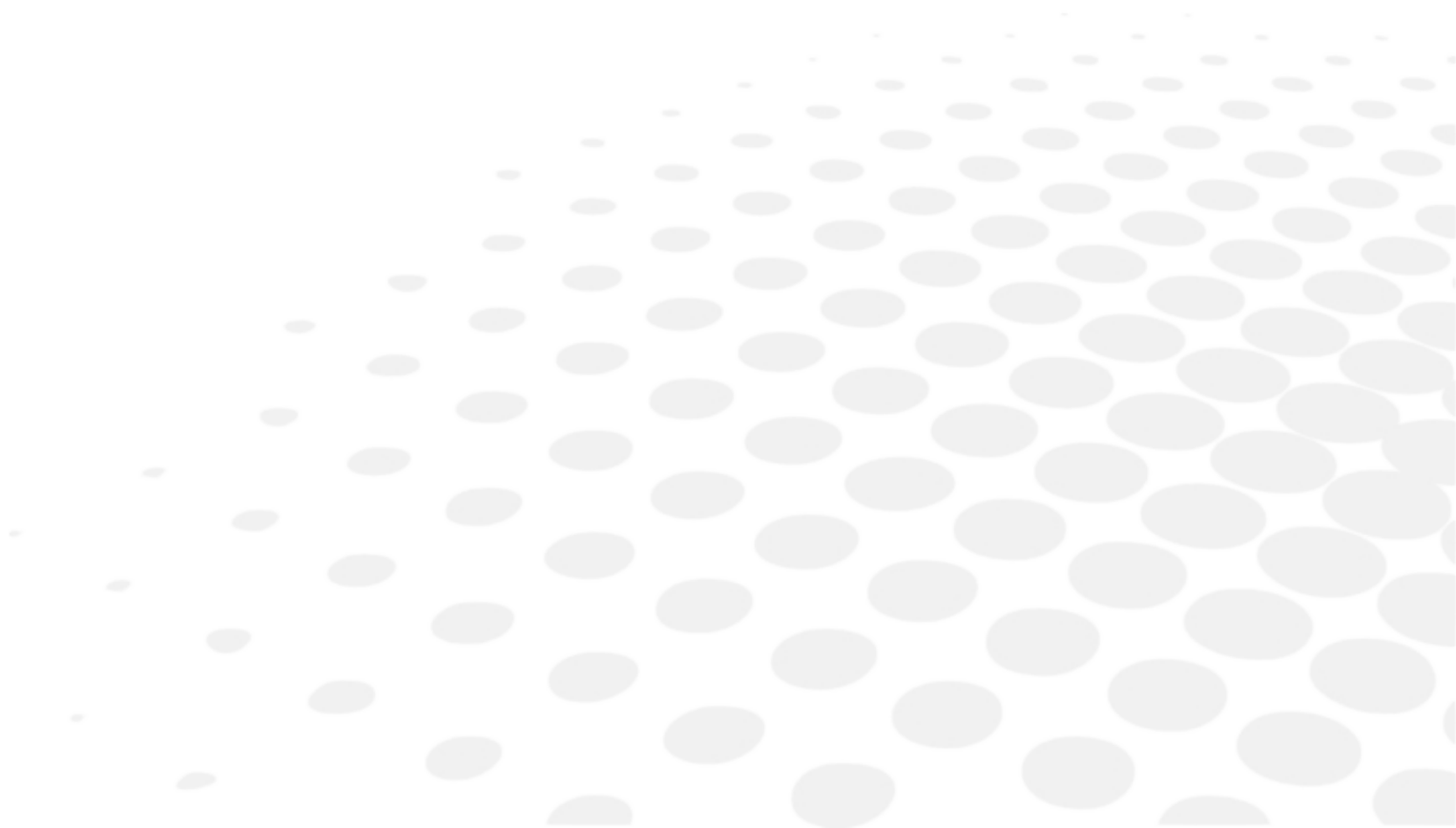

ASYMMETRIC BINOCULAR TRACING

The two rims are traced as if they have different shapes; the perimeters and the shapes are kept.

BOXING DIMENSIONS

The boxing system is a standard method for indicating the dimensions of frame contours (or gauges). This operation consists of fitting the frame into a rectangle whose dimensions are indicated.

- Boxing center: geometric center of the rectangle
- Boxing axis: horizontal axis of the frame passing through the boxing center
- A-dimension: length of the rectangle
- B-dimension: height of the rectangle
- E-dimension: the longest radius starting from the boxing center
- Boxing height: calculated from the tangent line at the bottom of the frame

CURVE ANGLE AND FRAME BASE

1. Curve angle: relative parameter formed between the median plane of each frame rim and the general plane of the frame. It is used to compute the decentration necessary for curved corrective lenses. The curve angle is expressed in degrees.
2. Frame base: parameter corresponding to the radius of the sphere going through the maximum number of points traced on the circle. It allows a better correspondence between lens bases (bevel) and the frame. The frame base is expressed in diopters.

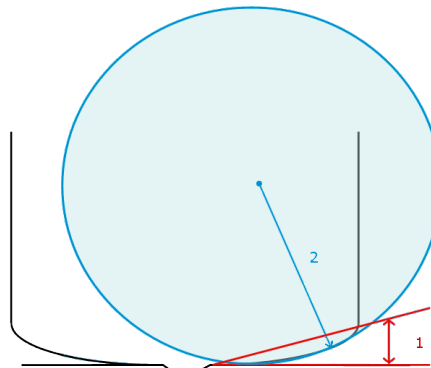

EXECUTIVE LENS

Type of bifocal lens with two full fields: one which corrects far vision defects and one which corrects near vision defects. They are available in two models:

- separation line present on the front surface of the lens
- separation line present on the rear surface of the lens
- Example of lenses of this type: Telex lenses™

ID

The job identifier, or ID, consists of alphanumeric characters. It is unique.

JOB

All the actions to be carried out on the tracer, centerer-blocker and edger in order to produce a pair of glasses. It is possible to memorize it in the shape management screen under an identifier (ID).

MID-DISTANCE LENS

Type of lens intended for near vision but with a greater depth of field (e.g. Interview lenses TM).

OPTYL

High flexibility plastic material used for certain frames.

PROGRESSIVE LENS

Type of lens whose power varies progressively from far vision on the upper part of the lens to near vision on the lower part, without any optical break or unsightly line.

RECUT LENS TRIPOD

Specific tripod for centering a recut lens or a small lens.

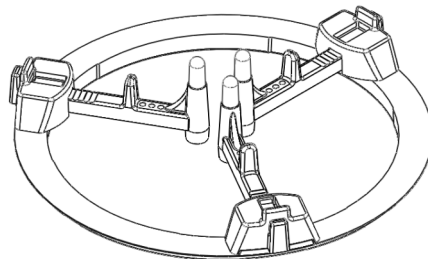

REFRACTIVE INDEX

Characterizes the refractive power of a transparent optical material.

The indices vary according to the materials used for the lenses:

- Plastic lens: 1.5
- Polycarbonate lens: 1.59
- Medium or High Index lens: > 1.5
- TrivexTM lens: 1.5 to 1.6
- Glass lens: 1.5 to 1.9

SINGLE VISION LENS

Type of single vision lens correcting ametropia. The lens power is the same throughout its surface.

SYMMETRIC BINOCULAR TRACING

The shape of the right rim is applied symmetrically to the left rim; the perimeters traced are kept.

TRIFOCAL/ BIFOCAL LENSES

Type of lens with distinct correction areas:

- the upper part of the lens is used for far vision.
- the lower part of the lens is used for near vision.

TRIPOD

Tripod to be used for centering all types of lens, except recut lenses.

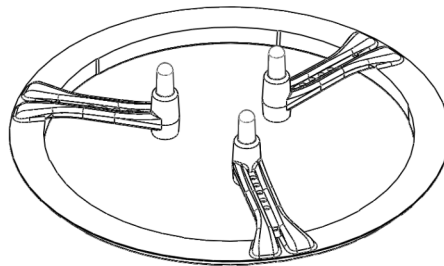



Essilor Instruments USA
8600 W. Catalpa Avenue, Suite 703
Chicago, IL 60656
Phone: 855.393.4647
Email: info@essilorinstrumentsusa.com
www.essilorinstrumentsusa.com