



## GE-Digital Camera

G Series | G2



A Series | A735  
A835



E Series | E840s/E1035  
E1235





# WARNING

To prevent fire or shock hazard, do not expose the unit to rain or moisture.

## For customers in the U.S.A.

**Tested To Comply  
With FCC Standards  
FOR HOME OR OFFICE USE**

### FCC Statement

This device complies with part 15 of the FCC Rules. Operation is subject to the following two conditions:

(1) This device may not cause harmful interference, and (2) this device must accept any interference received, including interference that may cause undesired operation.

### For customers in Europe



"CE" mark indicates that this product complies with the European requirements for safety, health, environment and customer protection. "CE" mark cameras are intended for sales in Europe.



This symbol [crossed-out wheeled bin WEEE Annex IV] indicates separate collection of waste electrical and electronic equipment in the EU countries. Please do not throw the equipment into the domestic refuse. Please use the return and collection systems available in your country for the disposal of this product.

### Declaration of Conformity

Model Name : G2/A735/A835/  
E840s/E1035/E1235  
Trade Name : GE  
Responsible Party : General Imaging Co.  
Address : 2158 W.190th Street,  
Torrance, CA 90504, USA  
Telephone Number : 1-800-730-6597

Conforms to the following Standards:

EMC: EN 55022:1998/A1:2000/A2:2003 Class B  
EN 55024:1998/A1:2001/A2:2003  
EN 61000-3-2:2000/A1:2001  
EN 61000-3-3:1995/A1:2001

following the provision of the EMC Directive  
(89/336/EEC,2004/108/EEC)

# SAFETY PRECAUTIONS

## Camera notes:

- ❗ Do not store or use the camera in the following types of locations:
  - In the rain, very humid and dusty places.
  - In a place where the camera can be exposed directly to the sunlight or subject to high temperature, e.g. Inside a closed car in summer.
  - In a place where the camera is subject to a high magnetic field, e.g. near motors, transformers or magnets.
- ❗ Do not place the camera on a wet surface or places where dripping water or sand may come in contact with the camera, which may cause irreparable faults.
- ❗ If the camera will not be used for a long period of time, we suggest you remove the battery and the memory card.
- ❗ If you carry the camera suddenly from a cold location to a warm place, moisture may condense inside the camera. We suggest you wait for a while before turning on the camera.
- ❗ No compensation for loss of recordings. Loss of recordings cannot be compensated for if a malfunction of your camera or recording media, etc, makes the playback of recordings not possible.

## Battery notes:

- ❗ Incorrect use of the batteries may cause them to leak, become hot, ignite or burst. Always observe the precautions given below.
  - Do not expose the batteries to water, and take particular care to keep the terminals dry.
  - Do not heat the batteries or throw them into a fire.
  - Do not attempt to deform, disassemble or modify the batteries.
  - Use GE charger in the package to charge the lithium battery only (for G and E series).
- ❗ Keep the batteries out of reach of babies and small children.
- ❗ In cold locations, battery performance deteriorates and the time for which they can be used shortens markedly.

## Memory card notes:

- ❗ When using a new memory card, or a memory card has been initialized by a PC, be sure to format the card with your digital camera before using it.
- ❗ To edit image data, copy the image data to the PC's hard disk and then format memory card if upgrade the firmware.
- ❗ Do not change or delete the directory names, or file names in the memory card from your PC, as this may make it impossible to use the card in your camera.

# BEFORE YOU START

## Preface

Thank you for purchasing GE digital cameras. Please read this manual carefully and keep it in a safe place for future reference.

### Copyright

© Copyright 2007 General Imaging Company All rights reserved.

No part of this publication may be reproduced, transmitted, transcribed, stored in a retrieval system, or translated into any language or computer language, in any form, by any means, without the prior written permission of General Imaging Company.

### Trademarks

All trademarks mentioned in this manual are used for identification purposes only and may be properties of their respective owners.

## Safety information

Please read the following important information carefully before using the product.

- Do not take apart or attempt to service the camera yourself.
- Do not drop or knock the camera. Improper handling may damage the product.
- Turn off the camera before inserting or removing the battery and memory card.
- Use only the type of battery and charger that came with your camera. Using other types of batteries or chargers may damage the camera and invalidate the warranty.
- When using Li-ion batteries in this product, ensure that they are inserted correctly. Inserting the batteries upside down can cause damage to the camera and possibly start a fire.
- Do not touch the camera lens.

- Do not expose the camera to moisture, or extreme temperatures. Extreme environments may shorten the life of your camera or damage the batteries.
- Do not use or store the camera in dusty, dirty, or sandy areas, as its components may be damaged.
- Do not expose the lens to direct sunlight for extended periods.
- Download all pictures and remove the batteries from the camera if you are going to store the camera for long periods.
- Do not use abrasive cleansers, alcohol-based, or solvent-based cleaners to clean the camera. Wipe the camera with a slightly damp soft cloth.

## About this manual

This manual provides you with instructions on how to use your GE digital camera. Every effort has been made to ensure that the contents of this manual are accurate, but General Imaging Company reserves the right to make changes without notice.

### Symbols used in this manual

Throughout this manual, the following symbols are used to help you locate information quickly and easily.



Indicates the useful information to know.



Indicates the precautions to be taken while operating the camera.

# CONTENTS

WARNING	
SAFETY PRECAUTIONS	
BEFORE YOU START .....	1
Preface .....	1
Copyright.....	1
Trademarks.....	1
Safety information.....	1
About this manual .....	2
Symbols used in this manual .....	2
CONTENTS.....	3
GETTING READY .....	7
Unpacking .....	7
Camera Views: G2 .....	8
: A735/A835 .....	10
: E840s.....	12
: E1035/E1235 .....	16
Charging the battery .....	18
Inserting the battery.....	19
Inserting an optional SD/SDHC card .....	22
Turning on and off .....	23
Using the Mode Dial .....	24
Setting display language, date, and time	
Setting the Date and Time.....	25
Setting the Language .....	26
About the LCD screen.....	27
BASIC OPERATION .....	28
Shooting in Auto mode .....	28
Using the zoom function .....	28
Using the flash.....	29
Using the self-timer.....	29
Using Macro mode.....	30
Exposure compensation.....	30
Advanced function menu .....	31
WB (White Balance).....	31
ISO.....	32

Quality.....	33	Landscape.....	43
Size.....	34	Night landscape.....	43
Color.....	35	Night portrait.....	43
<b>USING THE MODES.....</b>	<b>38</b>	Return to the scene mode palette....	44
LCD Screen display.....	38	Panorama mode.....	44
Still shooting mode display.....	38	Image stabilization mode.....	46
Video shooting mode display.....	40	Face detection.....	47
Playback mode display.....	41	<b>PLAYBACK.....</b>	<b>48</b>
Scene mode.....	42	Viewing photos and videos.....	48
Sport.....	42	Editing video.....	50
Children.....	42	Thumbnail view.....	53
Indoor.....	42	Using zoom playback	
Leaf.....	42	(for still pictures only).....	52
Snow.....	43	Using the delete button.....	53
Sunset.....	43	<b>USING THE MENUS.....</b>	<b>54</b>
Fireworks.....	43	Still menu.....	54
Glass.....	43	AF mode (Auto-Focus mode).....	55
Museum.....	43	AF-assist beam.....	55



Expo Metering (Exposure Metering)..56	Slide show .....67
Cont.Shot (Continuous shot) .....57	Red-eye removal.....68
Grid .....57	Setup menu .....69
Quick Review .....58	Format Memory .....69
Digital Zoom .....58	Beep.....70
Histogram .....59	LCD Brightness.....71
Slow shutter.....59	Power Saver .....71
Date Imprint .....59	Date/Time .....72
Movie menu.....60	World time .....72
Expo Metering (Exposure Metering)..61	File Numbering.....73
Stabilization.....61	Language.....73
Playback menu.....62	Video system .....73
Protect .....62	Copy to Card (Copy internal memory to memory card) .....74
Delete .....63	Reset Settings.....75
DPOF (Digital Print Order Format) ....64	FW Ver. (Firmware version).....75
Info. Box (Information Box) .....65	<b>CONNECTIONS .....76</b>
Trim.....65	Connecting to a TV .....76
Resize .....66	
Rotate.....66	

Connecting to a PC .....	77	Appendices .....	86
Setting the USB mode.....	78	Specifications:	
Transferring files to your PC .....	78	G2.....	86
Connecting to a PictBridge compatible		A735/A835 .....	90
printer .....	79	E840s/E1035/E1235 .....	94
Setting the USB mode.....	80	Error messages .....	100
Using the PictBridge menu.....	82	Troubleshooting.....	102
Print with date .....	82	Firmware upgrade instructions.....	104
Print without date .....	83		
Print index.....	84		
Print DPOF.....	85		
Exit .....	85		

# GETTING READY

## Unpacking

Your package should contain the camera model you purchased along with the following items. If anything is missing or appears to be damaged, please contact your vendor. (The accessories will vary based on model purchased and are noted below.)



Rechargeable  
Lithium-ion battery  
(except A735/A835)

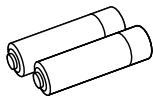

AA-size alkaline  
batteries X2  
(A735/A835 only)



User Manual



Quick start guide



Wrist strap

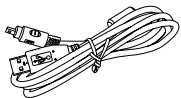

USB cable

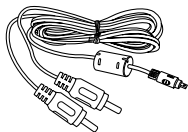

AV cable

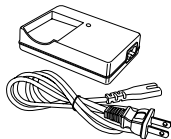

Battery charger  
(except A735/A835)

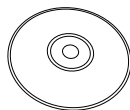

CD-ROM



Warranty card

## Camera views : G2

### Front View

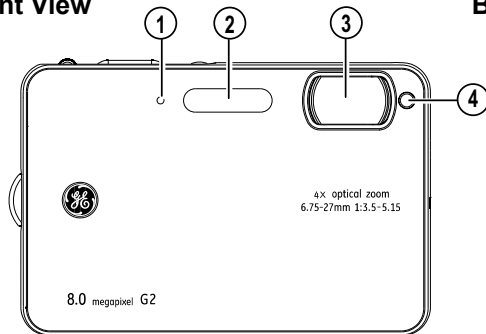

### Back View

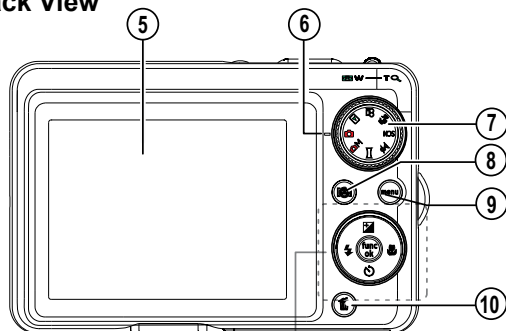

### Right View

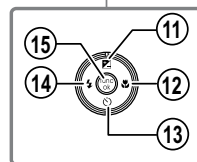
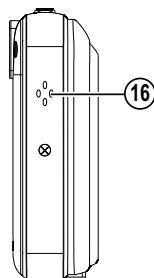

## Top View

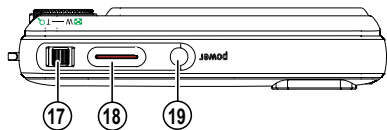

## Bottom View

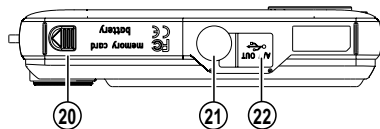

## Left View

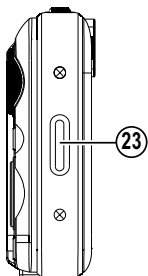

1	Mic	13	Self-timer/ Down button
2	Flash	14	Flash mode/ Left button
3	Lens	15	Func/ok button
4	AF assist beam/Timer indicator	16	Speaker
5	LCD screen	17	Zoom scroll wheel
6	Status LED	18	Shutter button
7	Mode dial	19	Power button
8	Face detection AF button	20	Memory card/ Battery compartment
9	Menu button	21	Tripod mount point
10	Erase button	22	USB/ AV port
11	Exposure compensation/ Up button	23	Wrist strap mount
12	Macro mode/ Right button		

## Camera views : A735/A835

### Front View

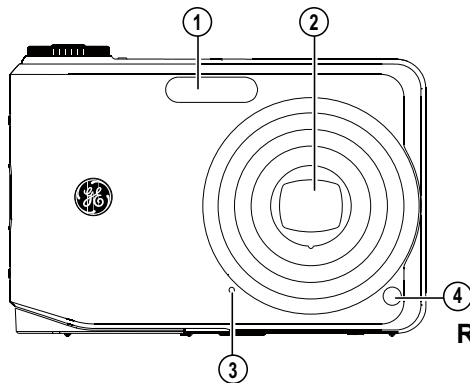

### Back View

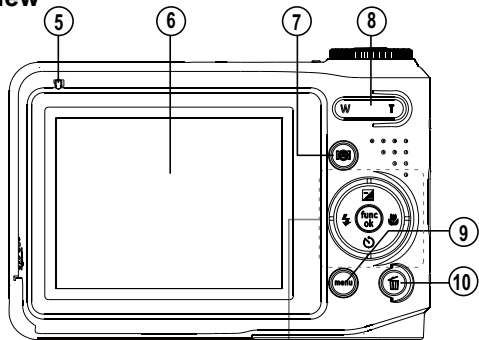

### Right View

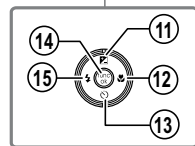
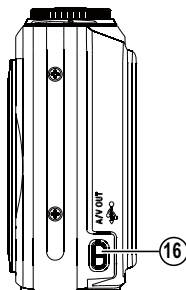

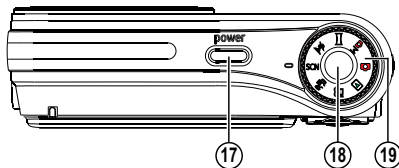
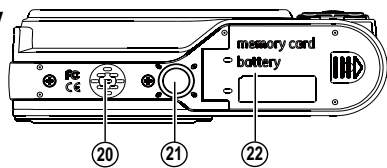
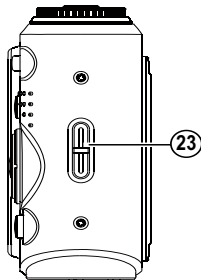
**Top View****Bottom View****Left View**

1	Flash	13	Self-timer/ Down button
2	Lens	14	Func/ok button
3	Mic	15	Flash mode/ Left button
4	AF assist beam/Timer indicator	16	USB/ AV port
5	Status LED	17	Power button
6	LCD screen	18	Shutter button
7	Face detection AF button	19	Mode dial
8	T&W button	20	Speaker
9	Menu button	21	Tripod mount point
10	Erase button	22	Memory card / Battery compartment
11	Exposure compensation/ Up button	23	Wrist strap mount
12	Macro mode/ Right button		

## Camera views : E840s

### Front View

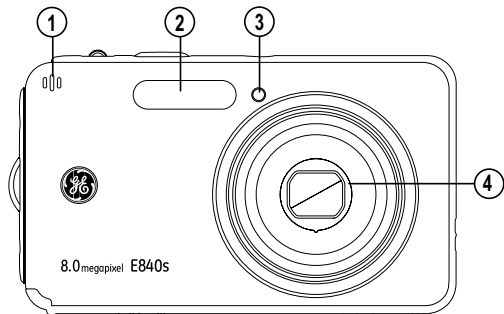

### Back View

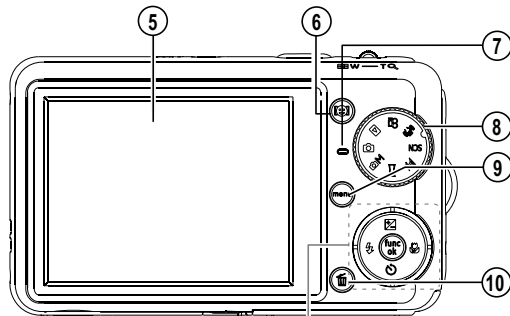

### Right View

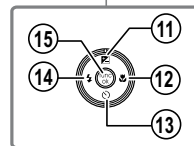
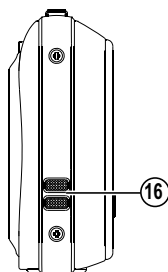



## Top View

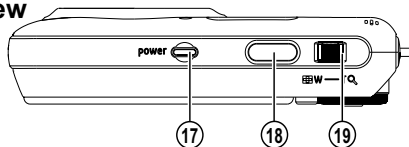

## Bottom View

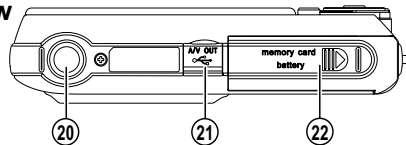

## Left View

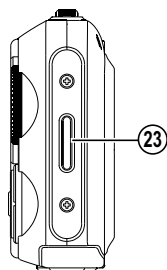

1	Mic	13	Self-timer/ Down button
2	Flash	14	Flash mode/ Left button
3	AF assist beam/Timer indicator	15	Func/ok button
4	Lens	16	Speaker
5	LCD screen	17	Power button
6	Face detection AF button	18	Shutter button
7	Status LED	19	Zoom scroll wheel
8	Mode dial	20	Tripod mount point
9	Menu button	21	USB/ AV port
10	Erase button	22	Memory card / Battery compartment
11	Exposure compensation/Up button	23	Wrist strap mount
12	Macro mode/ Right button		

## Camera views : E1035/E1235

### Front View

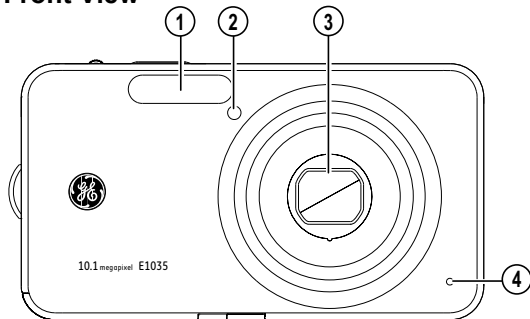

### Back View

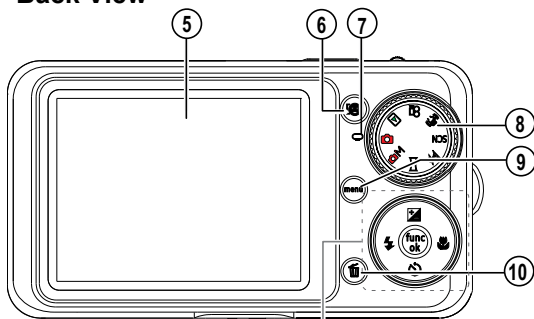

### Right View

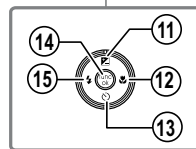
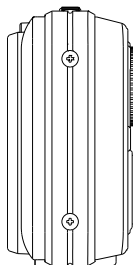

**Top View**

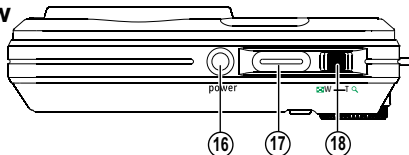

**Bottom View**

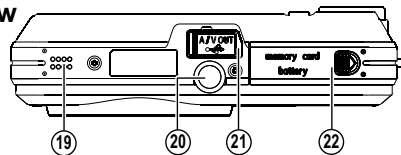

**Left View**

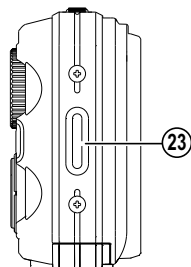



1	Flash	13	Self-timer/ Down button
2	AF assist beam/Timer indicator	14	Func/ok button
3	Lens	15	Flash mode/ Left button
4	Mic	16	Power button
5	LCD screen	17	Shutter button
6	Face detection AF button	18	Zoom scroll wheel
7	Status LED	19	Speaker
8	Mode dial	20	Tripod mount point
9	Menu button	21	USB/ AV port
10	Erase button	22	Memory card / Battery compartment
11	Exposure compensation/Up button	23	Wrist strap mount
12	Macro mode/ Right button		

## Charging the battery (except A735/835)

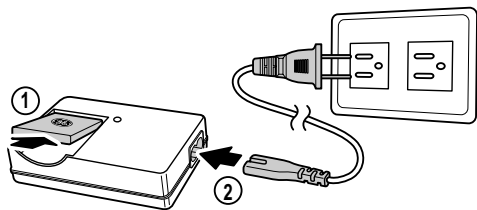
1. Place the battery into the charger as shown.
2. Plug one end of the connecting cable into the charger base.
3. Plug the other end of the connecting cable into a wall outlet.



-  Leave the battery to charge until the charger light goes green.  
(To maximize battery life, the first charge should be at least 4 hours)

-  Throughout the rest of the manual, the following illustrations show the E1035 model as an example.  
(G2, A735, A835, E840s, and E1235 operate similarly.)

## Inserting the battery

1. Open the battery compartment.

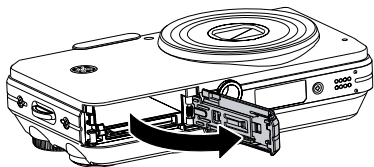
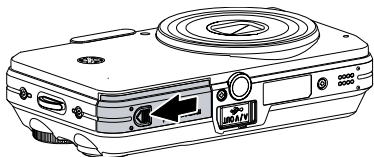

2. Insert the battery while observing the correct polarity. Use the side of the battery to press down the stopper as shown, allowing the battery to be inserted properly.

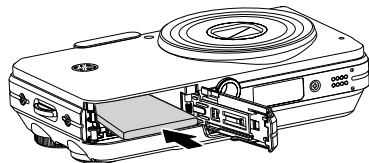
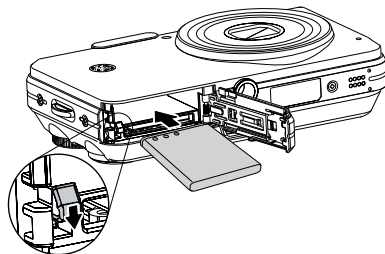

3. Close the battery compartment.

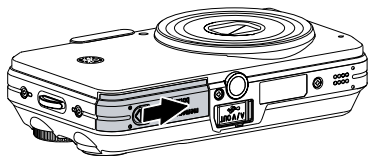
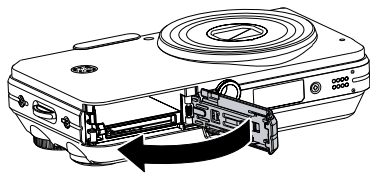

 Battery capacity decreases with usage.

Inserting the battery (A735/A835)

1. Open the battery compartment.

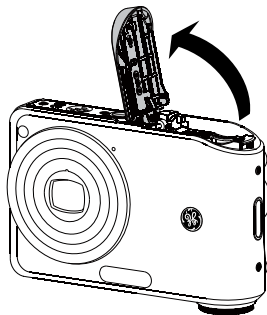
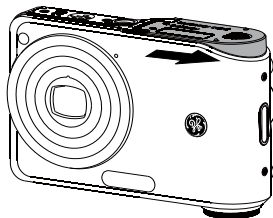

2. Insert the battery while observing the correct polarity. Use the side of battery to press down the stopper as shown, allowing the battery to be inserted properly.

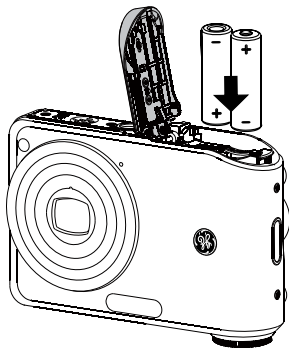

3. Close the battery compartment.

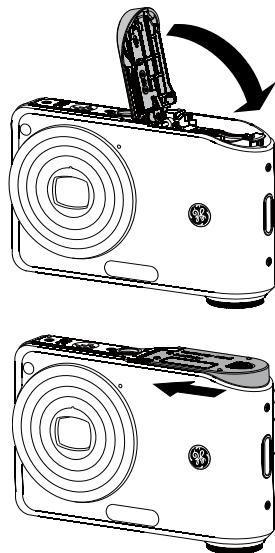

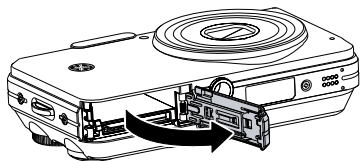
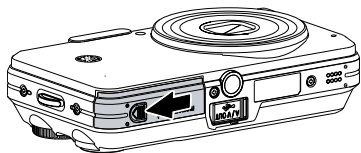

## Inserting an optional SD/SDHC card

1. Open the battery compartment.

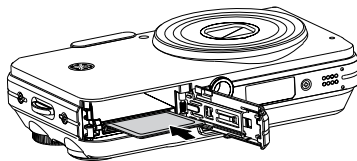
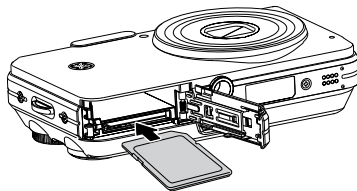

2. Insert an optional SD/SDHC card into the memory card slot as shown.



 Optional SD/SDHC cards are not included. The use of 64MB to 4GB memory cards from recognized manufacturers such as SanDisk, Panasonic and Toshiba is recommended for reliable data storage.



3. Close the battery compartment.

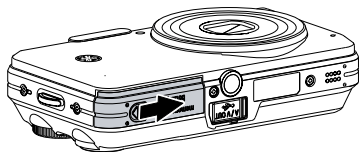
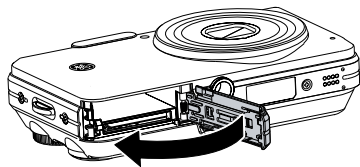

To remove the SD/SDHC card, open the battery compartment and gently push the card to release it. Pull the card carefully.

## Turning on and off



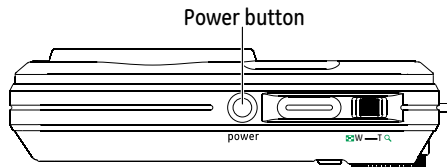



Press the **Power** button to turn the camera on. To turn off the camera, press the **Power** button again.



When turned on, the camera will enter the mode according to the mode dial setting. You can also turn the mode dial to change the modes after the camera is turned on.

## Using the Mode Dial

The GE camera provides a convenient mode dial that allows you to switch between different modes with ease. All the available modes are listed as follows.

Mode Name	Icon	Description
Auto		Switch to take still pictures. (The camera uses the default programmed automatic settings.)
Playback		Switch to view the pictures/videos stored in the memory card and internal memory.
Movie		Switch to record videos.
Image Stabilization		Switch to use Image Stabilization when taking still pictures.
Scene	SCN	Switch to use a preset scene mode for taking still pictures. There are 12 scenes in total.
Portrait		Switch to portrait mode when taking close-up portrait photos.
Panorama		Switch to capture a sequence of shots and stitch them together into a panoramic photo.
Manual		Switch to take still pictures in manual mode, where many camera settings can be configured. (Recommended for advanced users only)

## Setting date/time and language

To set the language, date, and time, the following settings need to be configured in the **Setup** menu.

- Date / Time
- Display language

To access the **Setup** menu, do the following:

1. Press **Power** to turn the camera on.
2. Press the  button and use **Up/Down/Left/Right** to select the **Setup** menu.

### Setting the Date and Time

1. Use the **Up/Down** to select **Date/Time**. Then press the **Right** to enter the setting.

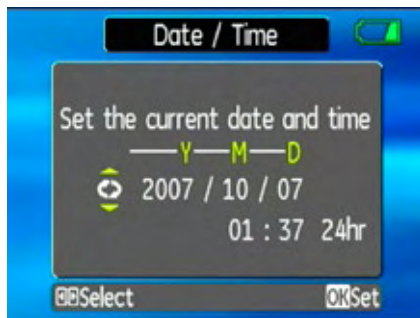



2. Press the **Left/Right** to highlight each field and use the **Up/Down** to adjust the value.
3. Press the  button to confirm the setting.

## Setting the Language

1. Use the **Up/Down** to select **Language**. Then press the **Right** to enter the setting.



2. Use the navigation buttons to select the desired language.
  3. Press the  button to confirm the setting.
-  The Set date/time and language screen will automatically appear when the camera is turned on the first time.

## About the LCD screen

When you turn the camera on, various icons are shown on the LCD screen to indicate the current camera settings and status. To learn more about the displayed icons, see “**LCD Screen display**” on page 36.

### **LCD Screen notes:**

Extremely high-precision technology had been used to manufacture the LCD screen so that most of the pixels are operational for use. However, there may be some minute points (black, white, red, blue or green) that constantly appear on the LCD screen. These points are normal in the manufacturing process and the recording is not affected in any way.



If the LCD monitor is damaged, take particular care with the liquid crystal in the monitor. If any of the following situations arise, take the urgent action indicated.

- If liquid crystal comes in contact with your skin, wipe the area with a cloth and then wash thoroughly with soap and running water.
- If liquid crystal gets into your eye, flush the affected eye with clean water for at least 15 minutes and then seek medical assistance.
- If liquid crystal is swallowed, flush your mouth thoroughly with water. Drink large quantities of water and induce vomiting. Then seek medical assistance.

# BASIC OPERATION

## Shooting in Auto mode

**Auto** mode is the easiest mode to take photos. While operating in this mode, the camera automatically optimizes your photos for best results.

To start shooting, do the following:

1. Set the mode dial to **Auto** mode (  ).
2. Press **Power** to turn the camera on.
3. Compose your picture on the LCD screen and press the shutter button halfway to focus on the subject.
4. When the subject is in focus, the green colored focus frame appears on the center of the LCD screen.
5. Press **Shutter** fully to capture the image.

## Using the zoom function

Your camera is equipped with two types of zoom: optical zoom and digital zoom. Use the **Zoom scroll wheel** on the top of the camera to zoom in or out on your subject while taking pictures.

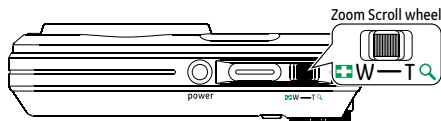







Zoom indicator  
(See "Digital Zoom"  
on page 58)

When the optical zoom factor reaches its maximum value, it stops momentarily. Keep the (Tele) zoom button depressed and zoom will switch over to digital zoom automatically.



## Using the flash

There are six flash modes. Press the **Left/Flash** to cycle through the following flash modes.

-  **Auto flash**  
Camera flash fires automatically based on existing light conditions.
-  **Red-eye reduction flash**  
The camera fires a brief flash before the picture is taken to reduce red-eye effects.
-  **Forced flash**  
Flash always fires.
-  **Flash off**  
Flash is turned off.
-  **Slow Synchro**  
This allows you to take pictures of people at night that clearly show both your subjects and the night time backdrop.
-  **Red-Eye Reduction+Slow Synchro**  
Use this mode for slow synchro shots with red-eye reduction.

## Using the self-timer/Multiple shots

To enable the self-timer function, press the **Down/Self-timer** to select 2-second timer delay, 10-second timer delay, or a continuous shot.

-  **2-second timer delay**  
A single picture is shot 2 seconds after the shutter button is pressed.
-  **10-second timer delay**  
A single picture is shot 10 seconds after the shutter button is pressed.
-  **Continuous shot**  
Pictures are shot continuously when the shutter button is pressed based on the Continuous Shot settings in the menu. (See “Continuous Shot” on page 56).

## Using Macro mode

In **Macro** mode, you can capture tiny details of the subject at a very close range. Press the **Right/Macro** to take close-up shots.

-  Macro  
Select this to focus on subjects 5cm from the lens.

## Exposure compensation

The exposure compensation allows you to adjust the background brightness to produce the best result of photos. To change the exposure values, do the following:

1. When taking a picture, press the Up/Exposure button to activate the set exposure screen.



2. Use the **Left/Right** to adjust the exposure value for the picture. The range is from EV -2.0 to EV+2.0 (steps of 0.3).



## Advanced function menu (quick menu setup)

### WB (White Balance)

The white balance allows the user to adjust the color temperature under different light source to ensure faithful color reproduction.





(The WB setting is only available when the camera is in the **Manual** mode).

To set the white balance, do the following:

1. Press the  button to enter the **Function** menu. Make sure the **WB** function is selected.



2. Use **Up/Down** navigation buttons to select the setting you want. The following options are available:

-  **AUTO** Auto
-  Daylight
-  Cloudy
-  Fluorescent
-  Fluorescent CWF
-  Incandescent
-  Manual WB adjustment (press the menu button to set)

3. Use the **Left/Right** buttons to select other options, or press the  button once to confirm your selection and exit the current menu.

## ISO

The ISO function allows you to set the camera sensor sensitivity to light. To improve the performance in darker environments, a higher ISO value is required. On the other hand, a lower ISO value is needed when in bright conditions.

(The ISO setting is only available when the camera is in the **Manual** mode).



To set the ISO value, do the following:

1. Press the  button to enter the **Function** menu.
2. Use the **Left/Right** navigation buttons to highlight the **ISO** function.

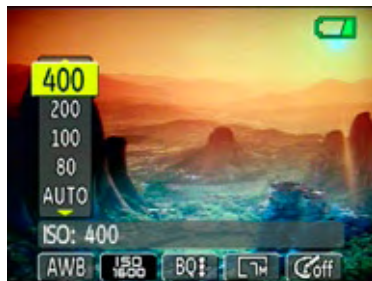

Higher ISO pictures will naturally have more noise than lower ISO pictures.



3. Use the **Up/Down** navigation buttons to select the desired ISO value from **Auto, 64, 80, 100, 200, 400, 800, or 1600**.
4. Press the  button to confirm your setting.
5. Use the **Left/Right** buttons to select other options, or press the  button once to confirm your selection and exit the current menu.





## Quality

The quality setting adjusts the compression ratio of the images. Higher quality settings give better photos, but will take up more memory space.

To set the image quality, do the following:

1. Press the  button to enter the **Function** menu.
2. Use the **Left/Right** navigation buttons to highlight the **Quality** function.



3. Use the **Up/Down** navigation buttons to select a desired setting. Three options are available.
  -  : Best quality (Standard compression)
  -  : Fine quality (High compression)
  -  : Normal quality (Maximum compression)
4. Press the  button to confirm your setting.
5. The number of available shots remaining is displayed on the LCD.
6. Use the Left/Right buttons to select other options, or press the  button once to confirm your selection and exit the current menu.

## Size

The size setting refers to the image resolution in pixels. A higher image resolution allows you to print that image in larger sizes without degrading the image.

To set the image size, do the following:

1. Press the  button to enter the **Function** menu.
2. Use the **Left/Right** navigation buttons to highlight the **Size** function.

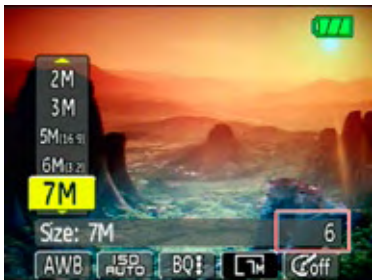

3. Use the **Up/Down** navigation buttons to select a resolution.
4. Press the  button to confirm your setting.
5. The number of available shots is displayed on the screen.

 The bigger the number of recorded pixels is, the better the image quality becomes. As the number of recorded pixels becomes smaller, you will be able to record more frames on a memory card.







 Please refer to page 34 for a list of image sizes that are available to the various GE digital camera models

## Color

The color setting allows you to add artistic effects directly when taking shots. You can try different color tones to alter the mood of your pictures.







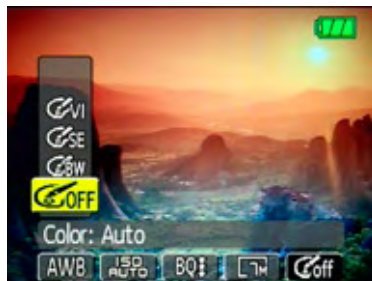

(The Color setting is only available when the camera is in the **AM Manual** mode).









To set the image color, do the following:

1. Press the  button to enter the **Function** menu.
2. Use the **Left/Right** navigation buttons to highlight the **Color** function.
3. Use **Up/Down** to select an option.  
The following options are available:
  -  Auto
  -  Black & White
  -  Sepia
  -  Vivid
4. Press the  button to confirm your setting.



- Size settings in shooting mode. (•: available)

Icon	File size (Pixels)	Model name :					
		G2	A735	A835	E840s	E1035	E1235
	0.3M: 640×480	•	•	•	•	•	•
	1M: 1024×768	•	•	•	•	•	•
	2M: 1600×1200	•	•	•	•	•	•
	3M: 2048×1536	•	•	•	•	•	•
	5M: 2560×1920	•		•	•	•	
	5M(16:9): 3072×1728		•				
	6M: 2816×2112						•
	6M(3:2): 3072×2048		•				
	6M(16:9): 3264×1836	•		•	•		

Icon	File size (Pixels)	Model name :					
		G2	A735	A835	E840s	E1035	E1235
	7M: 3072×2304		•				
	7M(3:2): 3264×2176	•		•	•		
	7M(16:9): 3648×2052					•	
	8M: 3264×2448	•		•	•		
	9M(3:2): 3648×2432					•	
	9M(16:9): 4032×2268						•
	10M: 3648×2736					•	
	10M(3:2): 4032×2688						•
	12M: 4032×3024						•

# USING THE MODES

## LCD Screen display

### Still shooting mode display

Mode: SCN

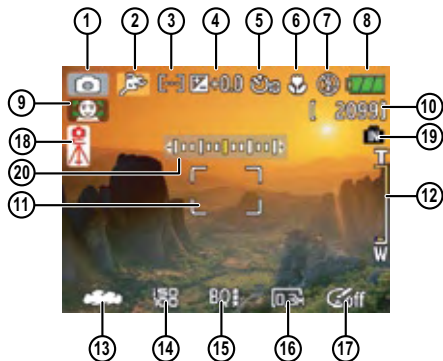

#### 1 Shooting mode icon



#### 2 Scene icon (only available for **Scene** mode)



#### 3 Light metering method

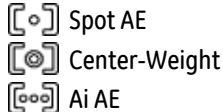

#### 4 EV indicator

#### 5 Self-timer indicator

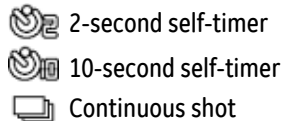



6 Macro mode indicator



Macro mode

7 Flash mode indicator



Auto flash



Red-eye reduction flash



Forced flash



Flash off



Slow Synchro



Red-Eye Reduction+Slow Synchro

8 Battery status

9 Face detection “on” indicator

10 Remaining number of photos that can be taken.

11 Focus frame

12 Zoom indicator

13 White balance (only available for **Manual** mode)

14 ISO (only available for **AM Manual** mode)

15 Image quality

16 Image size

17 Image color (only available for **AM Manual** mode)

18 Slow shutter warning indicator



19 Memory card/internal memory indicator

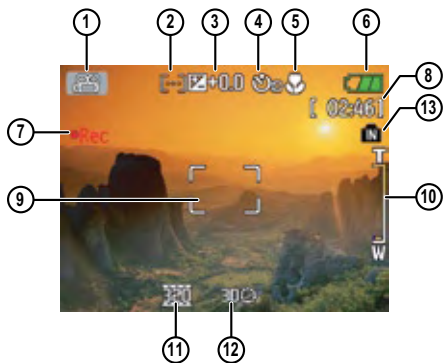

20 EV adjustment slider

## Video shooting mode display

Mode: 



- 1 Shooting mode icon
- 2 Light metering method
  -  Spot AE
  -  Center-Weight
  -  Ai AE

- 3 EV indicator
- 4 Self-timer indicator
  -  10-second self-timer
- 5 Macro mode indicator
  -  Macro mode
- 6 Battery status
- 7 Movie recording "on" indicator
- 8 Remaining time for videos that can be taken.
- 9 Focus frame
- 10 Zoom indicator
- 11 Video resolution
- 12 Video quality
- 13 Memory card/built-in memory indicator



 For best movie results, the use of SD cards is recommended. Movie recordings using internal memory are subject to quality degradations.

 While movie recording is in progress, optical zoom will stay fixed, but up to 1.5X digital zoom will remain available.

## Playback mode display

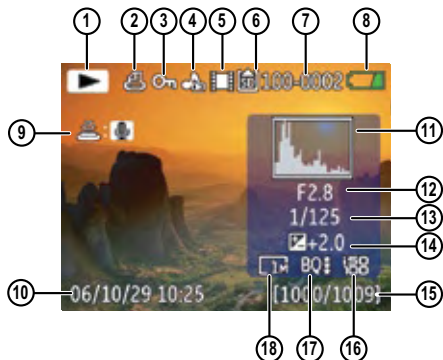
Mode: 



- 1 Playback mode icon
- 2 DPOF file icon
- 3 File protection icon
- 4 Audio file icon
- 5 Video file icon
- 6 Memory card/internal memory indicator
- 7 Picture ID
- 8 Battery status
- 9 Photo audio status  
  
(Press the shutter button to record sound)
- 10 Recording date and time  
  
(Press the shutter button to play sound)
- 11 Histogram
- 12 Aperture value
- 13 Shutter speed
- 14 Exposure value
- 15 Memory capacity (current picture/ total picture number)
- 16 ISO value
- 17 Image quality
- 18 Image size  
(See page 63 to get this info box to appear).

## Scene mode (SCN)

In **Scene** mode, you can select from a total of 12 scene types to match your needs. You just need to select the right scene for the occasion and the camera will automatically adjust to the optimal settings for you.

To enter the scene mode, turn the mode dial to **Scene** mode. The scene mode palette appears.



Use **Up/Down/Left/Right** to select a scene, and press the  button.

### **Sport**

For shooting fast-moving objects. Bring lively pictures to life.

### **Children**

Suitable for photographing children and pets. The flash shuts off automatically in order not to disturb the subject being photographed.

### **Indoor**

For shooting people indoors. Clearly show background and atmosphere.

### **Leaf**

For shooting plants. Vivid reproduction of green.

## **Snow**

Suitable for snowy landscape. Camera automatically adjusts and corrects exposure value (EV).

## **Sunset**

For shooting sunsets. Vivid reproduction of red and yellow.

## **Fireworks**

For shooting at night and fireworks. Shutter-speed is slower than normal.(Use of tripod is recommended)

## **Glass**

Suitable for photographing objects behind glass or window.

## **Museum**

For shooting in museums or places where flash is not allowed.

## **Landscape**

For shooting landscapes. Vivid reproduction of green and blue.

## **Night landscape**



For shooting night scenes. Use of tripod is recommended.

## **Night portrait**

For shooting portraits with night scenes as background.

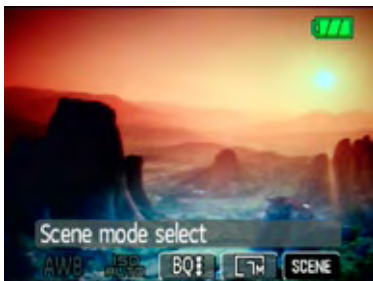
## Returning to the Scene selection menu



1. In **Scene** mode, press the  button to activate the main function menu.
2. Select the "SCENE" menu option and then press the  button to return to the Scene selection menu.

The main function menu also allows you to configure image quality and image size. Please refer to the "**Advanced Functions Menu**" section on pages 33 and 34 for detailed instructions.

## Panorama mode

Panorama mode allows you to create a panoramic picture. The camera will automatically compose a panoramic picture using the individual shots that you take.



Follow these steps to create a panoramic picture:

1. Set the mode dial to **Panorama** mode (.



2. Use the **Left/Right** buttons to specify the direction of picture taking, and then in 2 seconds the panoramic sequence will commence automatically.
3. Compose your first view on the LCD screen and press the shutter button.
4. The frame record icon will display under the focus frame to indicate the number of photos you have taken.
5. Using the same steps for the first shot, take the second and the third shots. Compose your shots so that the edges of the pictures overlap. The numeric indicators on the LCD inform you which shot is being taken.
6. The camera will then stitch the pictures into a panorama automatically.
7. Turn the mode dial to playback mode to view the panoramic picture.





- For best results the use of a tripod is recommended.
- While in panorama mode, press the  button to save images and exit panorama shooting. Press the  button to discard images and exit.

## Image Stabilization mode





The Image Stabilization mode combats the effect of hand shake and allows you to take pictures that would otherwise be blurred.



1. Switch the mode dial to (  ) mode.
2. Press **Shutter** halfway to focus on the subject.
3. Press **Shutter** fully to capture the image.





Setting the Image Stabilization function under (  ) mode.

(Stabilization during Movie mode is only available when the Frame Rate is set to 15 fps)

1. Switch the mode dial to (  ) mode.
2. Press the (  ) button to enter the **Function** menu.
3. Use the **Left/Right** navigation buttons to highlight the **Quality** function.
4. Use the **Up/Down** navigation buttons to select 15fps, and press the (  ) button to confirm your settings.
5. Press the **Menu** button, and use **Up/Down** to select the Image Stabilization settings.
6. Use **Up/Down** to select **Off** or **On**. Then press the (  ) button to confirm.





The stabilizer function is used for less blur picture caused by hand shake under a dark environment, the camera would increase the ISO level under the mode to have a higher shutter speed.

-  This function may not help to take a clear picture of a fast moving target, such as a car passing by, etc.
-  This function may not help to stabilize photos if you are in a moving vehicle (car, boat, etc.). It is best used when taking normal shots.
-  Increasing the ISO level may cause heavier noise on the photo.
-  Use of a tripod is always best to get the clearest picture.

## Face Detection

The Face Detection mode will detect faces of persons in a photo so that the faces will be as clear as possible.

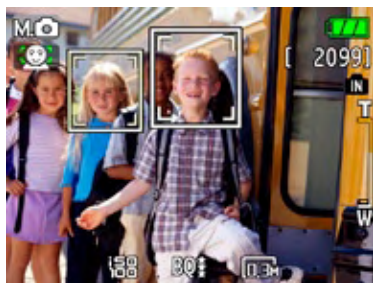

1. While in photography mode, press the  button to activate Face Detection. The  indicator appears on the LCD.
2. Hold the camera securely, and point the camera towards the subject to start the face detection process. When the camera detects a face, a white rectangular frame will be drawn around the face. (Note: For best results, the face of the subject should be relatively large on the LCD screen, and the subject should be facing the camera as front on as possible.)
3. Press **Shutter** halfway to focus on the subject.
4. Press **Shutter** fully to capture the image.



5. Press the  button again to deactivate face detection.

## Viewing photos and videos

To view the captured photos and video clips on the LCD screen:

1. Turn your camera to **Playback** mode.  
The last recorded photo or video clip is displayed.
2. Use the **Left/Right** navigation buttons to scroll through the photos or video clips stored in the internal memory or memory card.
3. To play a selected video clip, press the  button to enter the movie playback mode.
4. Use the **Left/Right** navigation buttons to select a program button and press the  button to confirm the selection. The function of each button is described in the following.



- |   |             |   |                |
|---|-------------|---|----------------|
| 1 | Exit        | 5 | Previous frame |
| 2 | Play        | 6 | Next frame     |
| 3 | Slow motion | 7 | Edit Movie     |
| 4 | First frame |   |                |

During the video playback, an operation guide appears on the screen. You can use the navigation pad to perform the functions accordingly.



During the video playback, you can use the **Up/Down** navigation buttons to adjust the volume of playback.

During the slow motion playback, you can use the **Left/Right** navigation buttons to adjust the speed of playback.





Volume will be muted when using the slow motion playback.

## Editing video

Press the **Edit**  program button to enter the following screen and use the buttons on the left side to edit the playback. Use the **Up/Down** navigation buttons to select a button.



1. Select the  **1st** button and use the **Left/Right** navigation buttons to specify the new beginning of the playback.
2. Select the  **2nd** button and use the **Left/Right** navigation buttons to specify the new end of the playback.



3. To save the file, select the  button and press the  button.

4. Use the **Up/Down** navigation buttons to select an option.



- **New file:** Save as a new file.
  - **Overwrite:** Overwrite the original file.
  - **Back:** Do not save the file and return to the Edit screen.
5. Press the  button to confirm your setting.





To exit the Edit screen, select the  button and press the  button.

-  Edited video must be at least 1 second long.
-  With sufficient battery and at least 1GB available memory, up to 30 minutes of footage can be recorded per movie.

## Thumbnail view

When in **Playback** mode, move the zoom scroll wheel to the Wide position ( W) once to display the thumbnail of photos and video clips on the screen.

1. Use the zoom scroll wheel to switch between the **2x2**, **3x3**, and **4x4** thumbnail display.
2. Use **Up/Down/Left/Right** to select a photo or video clip to view.

-  If the  indicator appears on the LCD, then a movie file is currently being displayed.
-  Press the  button to restore a preview icon to its original image size.

## Using zoom playback (for still pictures only)

The zoom scroll wheel can also be used during playback. This allows you to magnify photos up to 8X.

1. Turn your camera to **Playback** mode.
2. Use the **Left/Right** navigation buttons to select a photo to magnify.
3. Move the zoom scroll wheel to the Tele position ( T Q ) once.
4. Use the zoom scroll wheel to zoom in and out. The zoom indicator and pan box appear on the screen.

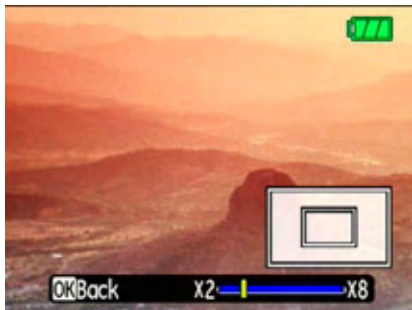

5. Use the navigation buttons to pan across the image.
6. Press the  button to return the image to its original scale.



Movie images cannot be enlarged.

## Using the Delete button



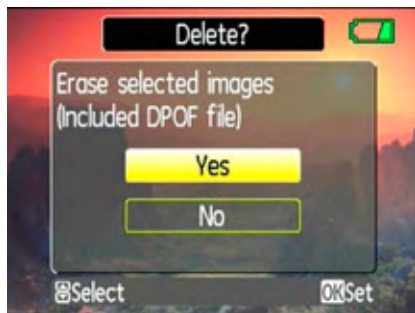

The camera is equipped with a quick **Delete** button  for you to delete photos or video-clips without entering the **Playback** menu.

To delete a photo or video:

1. Turn your camera to **Playback** mode.
2. Use the navigation buttons to select the photo/video clip you want to delete.
3. Press the  button. The Delete screen appears.



4. Press the **Up/Down** navigation buttons to select **Yes** or **No**. Then press the  button to confirm.

-  Erased photos/video clips cannot be recovered.
-  Please refer to page 64 for instructions on the delete menu options.
-  The  indicator appears if the picture has a sound file attached. You can choose to delete the attached sound file alone or to delete both the picture and the sound file.



# USING THE MENUS

## Still menu

Mode: SCN M

In still shooting modes, press the button to enter the **Still** menu.

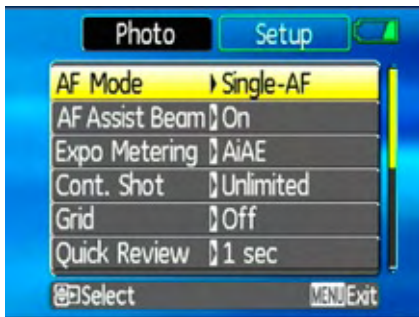

To configure the settings:

1. Use the **Up/Down** navigation buttons to scroll through the menu items.
2. Press the **Right** navigation button to enter the submenu.

3. Use the **Up/Down** navigation buttons to select an option.
4. Press the button to confirm the setting and exit the menu.

Refer to the following sections for more detailed information on each setting.



## AF mode (Auto-Focus mode)

Use this setting to control the auto-focus mechanism while taking pictures.



Two options are available:

- **Single-AF:** The focus frame appears on the center of the LCD screen to focus on the subject.
- **Multi-AF:** The camera automatically focuses the subject in a wide area to find the focus point.

## AF-assist beam

Use this setting to aid focus in dark conditions. Select **On** to turn on the AF assist beam, or **Off** to disable the function.

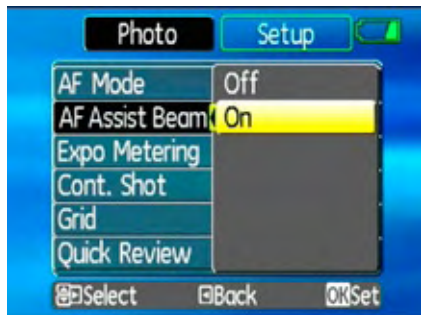

## Expo Metering (Exposure Metering)

Use this setting to select an area for the exposure to be obtained.

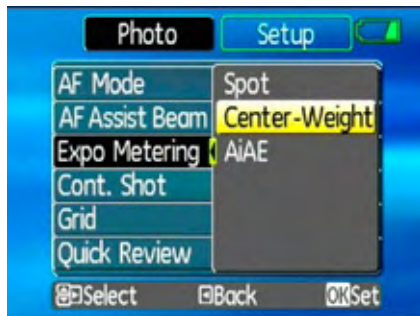

Three options are available:

- **Spot AE (Spot Auto Exposure)**
- **Center-Weight**
- **AiAE (Artificial Intelligence AE)**

## Cont. Shot (Continuous shot)

Use this setting to perform continuous shooting. Once in this mode, you must continuously hold the shutter button to use this function.

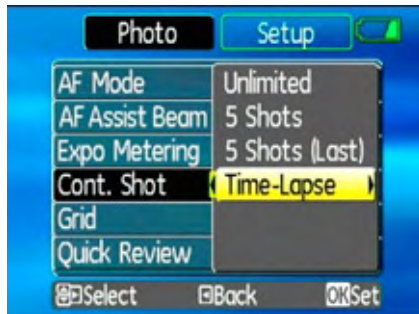

Four options are available:

- **Off:** Capture a single shot only.
- **5 shot:** Capture up to 5 consecutive pictures.
- **Last 5 shots:** Capture pictures continuously until the shutter button is released but only the last 5 shots are recorded.

- **Time-Lapse** : Automatically capture pictures in at predefined intervals.

- ① The flash is designed not to work in this mode in order to enable quick succession of shots.
- ① To activate this mode, the camera must have the self-timer for multiple shots already turned on (as described on page 27)

## Grid

Use this setting to turn on or off the framing grids when taking photos. This may help you position the subject in your composition.



## Quick Review

This setting refers to the quick photo review immediately after taking a picture. The picture stays on the LCD screen for an adjustable period of time.



Four options are available:

- **Off**
- **1 sec**
- **2 sec**
- **3 sec**

## Digital Zoom

Use this setting to enable or disable the digital zoom function. When disabled, only the optical zoom is enabled.



Digital Zoom indicator

- **Off:** gray color.
- **On:** reddish color.

## Histogram

The histogram is used for checking the exposure while taking pictures. Use this setting to enable or disable the histogram display on the LCD screen.



- **Off**
- **On**

## Slow Shutter

In Slow shutter mode, the shutter will remain open as long as the shutter button is pressed. This gives you complete control over the duration of exposure. (The slow shutter mode is available only in M manual mode.)



- **Manual:** To set a long exposure time between 2~30 sec.



The use of tripod is recommended for prolonged exposure.

## Date Imprint

Include a date/time stamp in the photo image.



- **Off:**
- **Date**
- **Date and time**

## Movie menu

Mode: 

In movie shooting mode, press the  button to enter the **Movie** menu.



To configure the settings:

1. Use the **Up/Down** buttons to scroll through menu items.
2. Press the **Right** navigation button to enter the submenu.

3. Use the **Up/Down** navigation buttons to select an option.
4. Press the  button to confirm the setting and exit the menu.

Refer to the following sections for more detailed information on each setting.

## Expo Metering (Exposure Metering)

Set metering mode for various lighting conditions.



Three options are available:

- Spot metering
- Center-weighted average metering
- Artificial intelligence automatic exposure (Ai AE)

## Stabilization

Please refer to page 44 for instructions on image stabilization.

While in Movie mode, image stabilization can be activated and de-activated via the recording menu.





## Playback menu

Mode: 

In playback mode, press the  button to enter the **Playback** menu.

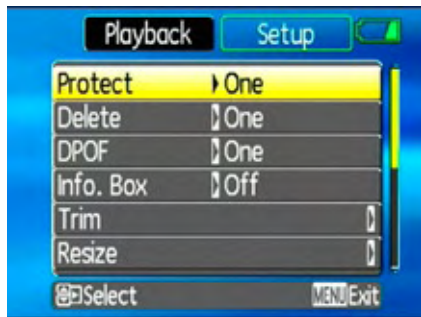

Please refer to the following sections for detailed instructions on the various menu options.



### Protect

To prevent pictures or videos being erased accidentally, you can use this setting to lock one or all files.



To protect/unprotect a picture or video:

1. Switch to playback mode using the mode dial. Use the **Left/Right** buttons to locate and display the photo or movie that you want to protect.

2. Select the **Protect** setting from the **Playback** menu as described previously.
3. Use the **Up/Down** navigation buttons to select **One** to protect this picture/video, or select **All** to protect all pictures/videos in the internal memory or memory card. Then press the **Right** navigation button.
4. Use the  button to select **Yes** to lock the displayed picture/video or **Unlock** to unlock it, and use the **Up/Down** navigation buttons to select **Back** to return to the **Playback** menu.
5. A key (  ) icon will appear on the top of the screen to indicate that the picture/video is protected.
6. Select **reset** to cancel protection for all files that have been placed in the protected mode.

## Delete

There are three ways to delete files: (please note that a file cannot be recovered once it is deleted.)

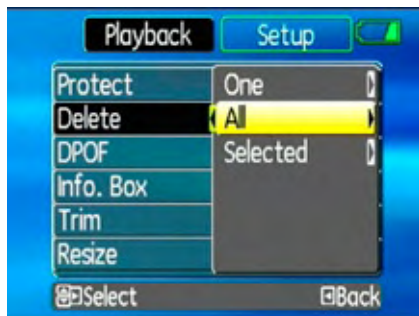

### •Delete One:

1. On the Delete menu, select **Delete One** and then press the **Right** button.
2. Using the **Left/Right** buttons, locate the photo or movie file to be deleted. Select **Yes** (to delete file) or **No** (to return to

the previous menu) using the **Up/Down** buttons, then press the  button to confirm.

•**Delete All:**



1. On the Delete menu, select **Delete All** and then press the **Right** button.
2. Using the **Left/Right** buttons, select **Yes** (to delete all files) or **No** (to cancel and return to the previous menu).

•**Delete Selected:**

1. On the Delete menu, select **Delete Selected** Files and then press the **Right** button.
2. Use the **Up/Down/Left/Right** buttons to locate each file to be deleted, and then press the  button to mark the file for deletion. An indicator will appear for each file that is marked for deletion. (Use the Zoom button to re-size image icons for easy

viewing.)

3. Press the  button to delete the selected files. Choose **Yes** to confirm file deletion or **No** to return to the previous menu.

-  The “” indicator means a file is protected. File protection must be removed first before a file can be deleted.
-  Deleting files will cause DPOF settings to be reset.



## DPOF (Digital Print Order Format)

DPOF allows you to record your selection of pictures that you would like to print, and will save your selection in the memory card, so that you can simply hand your memory card to a photo kiosk without having to tell them in person which photos you would like to print.

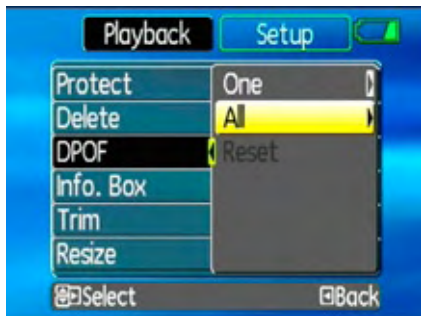

## Info. Box (Information Box)

Use this setting to enable or disable the text display for taking pictures. The following information will be displayed on the screen: histogram display, aperture value, shutter speed, exposure value, image size, image quality, and ISO value. (Please refer to page 39 for information on the menu options shown).

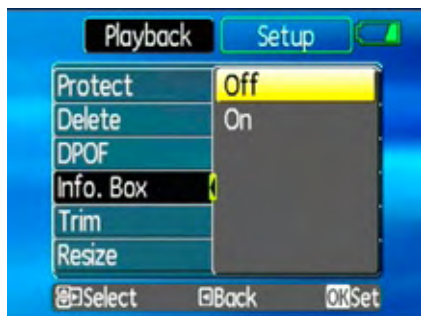

## Trim

The trim setting allows you select an area of the photo you want to keep and then save it as a new photo.

To trim a picture:

1. Select the **Trim** setting from the **Playback** menu as described previously.
2. Using the **Left/Right** buttons, locate the photo that you want to crop and have it displayed on the LCD.
3. Use the zoom scroll wheel and navigation buttons to adjust the trimming box to fit the location and size of the new picture.

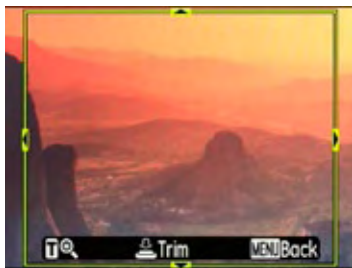

4. Press the **Shutter** button to save what you see on the LCD screen as a new picture, or the **menu** button to cancel and return to the **Playback** menu.

## Resize

This setting allows you to resize picture to a specified resolution, and save it as a new picture.

1. Select the **Resize** setting from the **Playback** menu as described previously.



2. Use the **Left/Right** navigation buttons to select a picture to resize.
3. Use the **Up/Down** navigation buttons to select a resolution (**1024X768** or **640X480**) to resize the image or **back** to cancel and return to the **Playback** menu.
4. Press the  button to confirm the setting.

 Resizing an image creates a new file that contains the image in the size you select. The file with the original image also remains in memory.

 If the message “The image cannot be

edited.” appears, it means that the current image cannot be resized.

## Rotate

You can use this setting to change the picture orientation of the picture.

1. Select the **Rotate** setting from the **Playback** menu as described previously.
2. Use the **Left/Right** navigation buttons to select a picture to rotate.

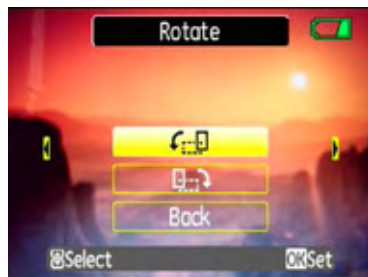

3. Use the **Up/Down** navigation buttons to select the direction for rotation or **Back** to

cancel and return to the **Playback** menu.

4. Press the  button to confirm the setting.

 The rotated image will be saved as a new file, and the original image will remain intact in memory.

## Slide show

This setting allows you to view all the stored pictures as a slideshow.

1. Select the **Slide show** setting from the **Playback** menu as described previously.
2. Use the **Up/Down** navigation buttons to select Effect, Interval time, or Repeat and use the **Left/Right** navigation buttons to adjust the setting.

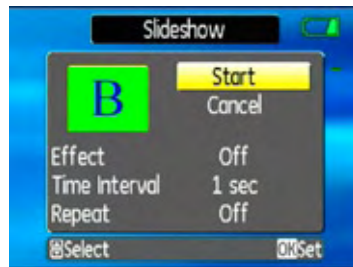

3. Use the **Up/Down** navigation buttons to select **Start** to run the slideshow or **Cancel** to return to the **Playback** menu.
4. Press the  button to confirm the setting.

## Red-eye removal

Use this setting to remove red-eye effect in your photos.

1. Select the **Red-eye removal** setting from the **Playback** menu as described previously.

## Setup menu

Mode: SCN

The **Setup** menu is available in all modes. Press the button in any modes, then use the navigation buttons to select the **Setup** menu.



To configure the settings:

1. Use the **Up/Down** navigation buttons to scroll through the menu items.

2. Press the **Right** navigation button to enter the setting.

Refer to the following sections for more detailed information on each setting.

### Format Memory

Please note: formatting enables you to delete all contents in the memory card and built-in memory, including protected photo and movie files.

To use this setting:

1. Select the **Format Memory** setting from the **Setup** menu as described previously.
2. Use the **Left/Right** navigation buttons to select **Yes** or **No**, and press the button to confirm.





3. The current media is formatted.

## Beep

Use this setting to adjust the volume of beep when buttons are pressed and change the tones for shutter, buttons, self-timer, and power-on/power-off.

To change this setting:

1. Select the **Beep** setting from the **Setup**

menu as described previously.

2. Use the **Up/Down** navigation buttons to switch between volume, shutter tone, key tone, self-timer tone, and power tone fields.



3. Use the **Left/Right** navigation buttons to adjust the volume and change each tone style. Then press the  button to confirm.

## LCD Brightness

Use this setting to adjust the brightness of your LCD screen.

1. Select the **LCD Brightness** setting from the **Setup** menu as described previously.
2. Use the **Up/Down** buttons to select to **Auto** or **Manual** brightness adjustment, and then press  to confirm your election.



3. For manual adjustment, use the **Left/Right** buttons to adjust the brightness.

## Power Saver

This setting allows you to save power and get the maximum possible running time for your battery. Follow the steps below to turn off the LCD screen and camera automatically after a period of inactivity.

1. Select the **Power Save** setting from the **Setup** menu as described previously.
2. Use the **Up/Down** navigation buttons to switch between LCD power and Camera power fields.



3. Use the **Left/Right** navigation buttons

to specify the idle period before automatic power-off. The level bars correspond to the following idle periods.

- LCD off:  
30 seconds, 1 minute, 2 minutes, and Always on.
- Camera off:  
3 minutes, 5 minutes, 10 minutes, and Always on.

4. Press the  button to confirm.



## Date/Time

See “**Setting the Date and Time**” section on page 25.

## World time

The world time setting is a useful function on your overseas trips. This feature enables you to display the local time on the LCD screen

while you are overseas.

1. Select the **World time** setting from the **Setup** menu as described previously. The world time screen appears.
2. Use the **Up/Down** navigation buttons to switch between the hometown () and travel destination () fields.
3. Use the **Left/Right** navigation buttons to select a city close to the desired time zone. Then press the  button to confirm.



## File Numbering

After capturing photos or videos, the camera will automatically save the file with a numeric suffix.



Select this setting:	Serial number is derived and assigned to a new file as follows:
Continue	whether the number should continue on from the last photo you have taken
Reset	reset the counter to 1 and save files in a new folder in the memory card.

## Language

See “**Setting the Language**” section on page 26.

## Video system

Use this setting to determine your video system in the current area.

1. Select the **Video system** setting from the **Setup** menu as described previously.
2. Use the **Up/Down** navigation buttons to select **NTSC** or **PAL**. Then press the  button to confirm.

The video output signal can be switched to NTSC or PAL to accommodate different regional standards. The appropriate setting will vary between regions.

**NTSC:** USA, Canada, Taiwan, Japan, etc.

**PAL** : Europe, Asia (excluding Taiwan),  
Oceania, etc.

Note: The TV output will not display properly if an incorrect video system is selected.



## Copy to Card (Copy internal memory to memory card)

Use this setting to copy the files stored in the internal memory to the memory card.

1. Select the **Copy to memory card** setting from the **Setup** menu as described previously.
2. Use the **Up/Down** navigation buttons to select **Yes** or **No**. Then press the  button to confirm.



## Reset Settings

Use this setting to restore the camera to its default settings.

1. Select the **Reset** setting from the **Setup** menu as described previously.
2. Use the **Up/Down** navigation buttons to select **Yes** or **No**. Then press the  button to confirm.



## FW Ver. (Firmware version)

Use this setting to view the current camera firmware version.

1. Select the **FW Ver.** setting from the **Setup** menu as described previously.
2. If SD card contains a new version of firmware, please upgrade accordingly as necessary.



# CONNECTIONS

## Connecting to a TV

You can connect your camera to your television, computer, or printer to view picture you have taken.

By using the AV cable, you can view the captured images on a TV. Follow the steps below to connect the supplied AV cable to a TV.

1. Choose **[NTSC]** or **[PAL]** to match your TV video standard (see page 73) and then turn off the camera.
2. Connect one end of the AV cable to the USB/AV OUT port on your camera.
3. Connect the plugs on the other end of the cable to the audio and video input ports on the TV.
4. Turn on the camera and the TV on.

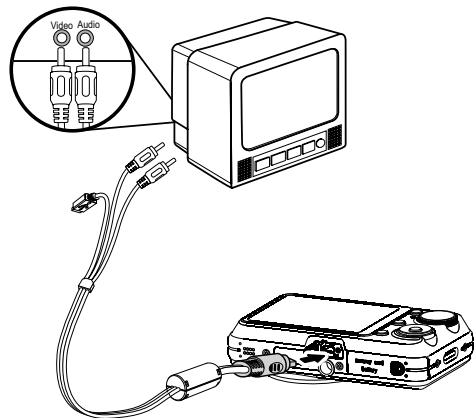

Make sure that both the camera and TV are turned off before connecting the AV cable.





Use a fully charged battery to prevent the camera from turning off unexpectedly while connected.

## Connecting to a PC

Use the USB cable and ArcSoft software (CD-ROM) supplied with your camera to copy (transfer) pictures to a computer.

### Setting the USB mode

Since the camera's USB port can be set to connect with either a PC or a Printer, the following steps will allow you to ensure that the camera is correctly configured to connect with a PC.

1. Press the  button and use the **Up/Down** navigation buttons to select **USB Connect**, and then press the Right navigation button.
2. Use the **Up/Down** navigation buttons to select **PC**.
3. Press the  button to confirm the setting.

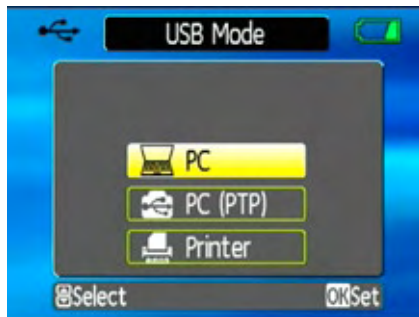

### Transferring files to your PC

The computer will automatically detect the camera as a removable drive. Double-click **My Computer** icon on the desktop to locate the removable drive and to copy the folders and files in the drive to a directory on your PC as you would copy any typical folder or file.



By using the USB cable, you can transfer the captured photos and videos to a PC. Follow the steps below to connect the camera to a PC.

1. Start a computer to which ArcSoft software has been installed.
2. Make sure both the camera and PC are turned on.
3. Connect one end of the supplied USB cable to the USB/AV OUT port on your camera.
4. Connect the other end of the cable to an available USB port on your PC.

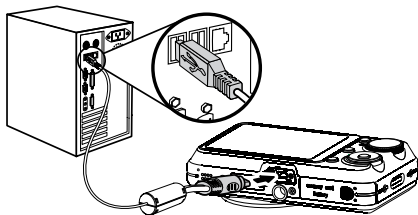

5. Disconnect the camera once transfer is completed.

**If the USB option is set to [PC]:**

Turn the camera off and disconnect the USB cable.

**If the USB option is set to [PC (PTP)]:**

Remove the camera from the system as described below before turning the camera off and disconnecting the USB cable.

**Window XP Home Edition/XP Professional**

Click the [Safely Remove Hardware] icon (  ) in the taskbar and select [Safely remove USB Mass Storage Device] from the menu displayed.



## Window 2000 Professional

Click the [Unplug or Eject Hardware] icon (  ) in the taskbar and select [Stop USB Mass Storage Device] from the menu displayed.

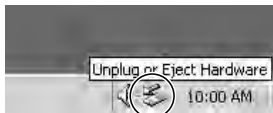

## Macintosh

Drag the untitled icon to the Trash. ("Untitled")



## Connecting to a PictBridge compatible printer





PictBridge allows printing images from a memory card in a digital camera directly to a printer, regardless of brand.

To find out if a printer is PictBridge compatible, simply look for the PictBridge logo on the packaging or check the manual for specifications. With the PictBridge function on your camera, you can print the captured photos directly with a PictBridge compatible printer using the supplied USB cable, without the need for a PC.

### Setting the USB mode

Since the camera's USB port can be set to connect with either a PC or a Printer, the following steps will allow you to ensure that the camera is correctly configured to connect with a Printer.

1. Press the  button and use **Up/Down** to select **USB Connect**, and then press the Right navigation button.
2. Use **Up/Down** to select **Printer**.
3. Press the  button to confirm the setting.

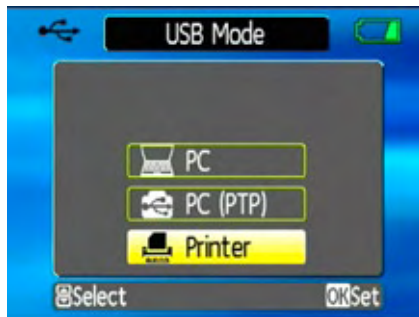

-  Every time the camera is powered off, the USB Mode will automatically revert back to PC mode.

## Connecting the camera and printer.

1. Make sure both the camera and printer are turned on.
2. Connect one end of the supplied USB cable to the USB port on your camera.
3. Connect the other end of the cable to the USB port on the printer.

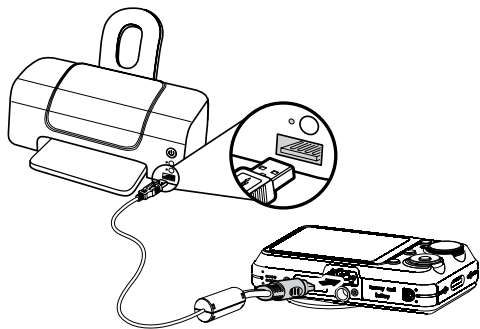

If the camera is not connected to a PictBridge compatible printer, the following error message appears on the LCD screen.



The above error message would also appear if the USB mode were set incorrectly, in which case you should disconnect the USB cable, check the USB mode settings, ensure that the Printer is turned on, and then try connecting the USB cable again.

## Using the PictBridge menu

After setting the USB mode to Printer, the **PictBridge** menu appears.

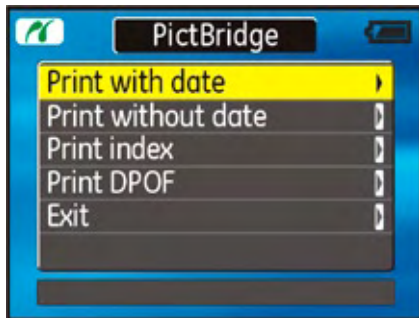

Use the **Up/Down** navigation buttons to select a menu item, and press the **Right** navigation button to enter.

Refer to the following sections for more detailed information on each setting.

### Print with date

If you have set the date and time of your camera, the date record would be saved with the photos you take. You can print the photos with date by following the steps below.

1. Select **Print with date** from the **PictBridge** menu. The following screen appears.

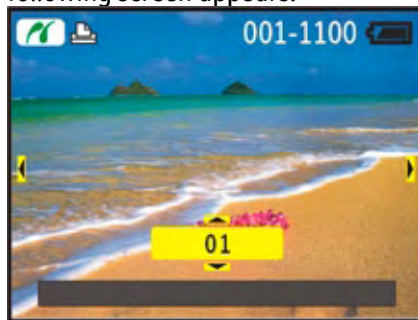

2. Use the **Left/Right** navigation buttons to scroll through the photos.
3. Use the **Up/Down** navigation buttons to select the number of prints for the current displayed photo.
4. Press the  button and the following screen appears.



5. Select **Yes** to confirm printing, or **No** to cancel. Then press the  button.

## Print without date

Use this setting to print the photos without dates on them.

1. Select **Print without date** from the **PictBridge** menu. The following screen appears.

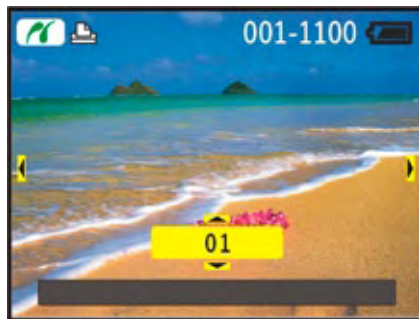

2. Use the **Left/Right** navigation buttons to scroll through the images.
3. Use the **Up/Down** navigation buttons to select the number of prints for the current

displayed image.

4. Press the  button and the following screen appears.

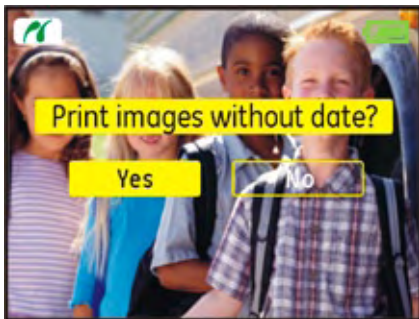

5. Select **Yes** to confirm printing, or **No** to cancel. Then press the  button.

## Print index

You can use this setting to print all indexes to show all the photos currently in your camera.

1. Select **Print index** from the **PictBridge** menu. The following screen appears.



2. Select **Yes** to confirm the printing, or **No** to cancel. Then press the  button.

## Print DPOF (Digital Print Order Format)

To use DPOF printing, you must make the selection of photos for printing using the DPOF settings before hand. See “DPOF” section on page 64.

1. Select **Print DPOF** from the **PictBridge** menu. The following screen appears.



2. Select **Yes** to confirm the printing, or **No** to cancel. Then press the  button.

## Exit

To exit the **PictBridge** menu, select **Exit**. The “Remove USB cable” message will be displayed.



Disconnect the USB cable from the camera and printer.



# Appendices

## Specifications : G2



"Design and specifications are subject to change without notice."

Effective Image Sensor Pixels		8.0 Megapixels
Image Sensor		8.31 Megapixels [1/2.35" Charge Coupled Device (CCD)]
Lens	Focal Length F =	6.75mm (Wide) ~ 27mm (Tele)
	[35mm film equivalent]	[38mm (Wide) ~ 152mm (Tele)]
	F number	F3.5 (Wide) ~ F5.15 (Tele)
	Lens Construction	14 elements in 11 groups
	Optical Zoom	4X
	Focusing Range	Normal: 60cm ~ ∞ Macro: (Wide) 6cm ~ ∞; (Tele) 40cm ~ ∞
Anti-Handshake		Electronic Image Stabilization
Digital Zoom		4.5X digital zoom (Combined Zoom: 18X)
Number of Recording Pixels	Still Image (See page36)	8MP, 7MP (3:2), 6MP(16:9),5MP,3MP, 2MP, 1MP, 0.3MP
	Movie	640x480pixels: 30fps/15fps, 320x240pixels: 30fps/15fps

Image Compression		Best, Fine, Normal
DCF, DPOF (Ver1.1) Support		Yes
File Format	Still Image	Exif 2.2 (JPEG)
	Movie	Image Compression: MPEG4, Audio: G.711 [Monaural]
	Audio	WAVE [Monaural] (Max 60 seconds)
Shooting Modes		Auto, Manual, Image Stabilization, Movie, Scene (Sport, Children, Indoor, Leaf, Snow, Sunset, Fireworks, Glass, Museum, Landscape, Night Landscape, Night Portrait), Panorama, Portrait
Face-Detection		Yes
Red-eye Removal		Yes
Panorama Stitching		Yes
LCD Display		2.7 inch LTPS (low-temperature polycrystalline silicon) TFT color LCD (230,400 pixels)
ISO Sensitivity		Auto, ISO 64/100/200/400/800/1600

AF Method	Single AF, Multi-AF (TTL 9-point), Face-Detection, AF Assist Light (On/Off)
Light Metering Method	Artificial Intelligence AE (Ai AE), Center-weighted Average, Spot (Fixed to center of frame)
Exposure Control Method	ProgramAE (AE-lock available)
Exposure Compensation	±2 EV in 1/3 steps
Shutter Speed	4 ~ 1/2000 second (Manual 30 seconds)
Continuous Shooting	Approx. 1.8 fps (Large/Fine mode)
Playback Modes	Single Photo, Index (4/9/16 thumbnails), Slide Show, Movie (Slow-Motion possible), Zoom (Approx. 2X~8X), Audio , Histogram Display
White Balance Control	Auto (AWB), Daylight, Cloudy, Fluorescent , Fluorescent CWF, Incandescent, Manual
Internal Flash (Shooting Range)	Auto/Red-Eye Reduction/Forced Flash/No Flash/Slow Synchro/Red-Eye Reduction+Slow Synchro
	Gno. 5.9 (ISO 100)
	(Shooting Range) Wide: Approx. 0.3m~3.3m / Tele: Approx. 0.3m~2.7m (ISO 400)

Recording Media	Internal Memory: 26MB
	SD Card/SDHC Card (Up to 4GB support)
Other Features	PictBridge, Exif Print Support, Multi-language Support (11 languages)
Jacks	USB2.0/AV-OUT (Integrated Proprietary Connector)
Power	Rechargeable Lithium-ion Battery GB-20, 3.7V 750mAh
Battery Charger	Input Voltage : AC 100 to 240V, 50/60Hz, 100mA Output Voltage : DC 4.2V, 500mA"
Shooting Capability (Battery Performance)	Approx. 200 shots (based on CIPA standards)
Operation Environment	Temperature: 0~40 <sup>0</sup> C, Humidity: 0~90%
Dimensions (W x H x D)	91x 60x 20 mm
Mass	Approx. 120g (Body only)

# Appendices

## Specifications : A735/A835



"Design and specifications are subject to change without notice."

Effective Image Sensor Pixels		7.07 /8.0 Megapixels
Image Sensor		7.40 /8.5 Megapixels [1/2.5" (CCD)]
Lens	Focal Length F =	6.1mm (Wide) ~ 18.3mm (Tele)
	[35mm film equivalent]	[36mm (Wide) ~ 108mm (Tele)]
	F number	F2.8 (Wide) ~ F4.8 (Tele)
	Lens Construction	7 elements in 6 groups
	Optical Zoom	3X
	Focusing Range	Normal: 60cm ~∞ Macro: (Wide) 5cm ~ ∞; (Tele) 40cm ~ ∞
Anti-Handshake		Electronic Image Stabilization
Digital Zoom		4.5X digital zoom (Combined Zoom: 13.5X)

Number of Recording Pixels	Still Image	<b>A735:</b> 7MP:(3072x2304), (3:2)6MP: (3072x2048), (16:9)5MP:(3072x1728), 3MP, 2MP, 1MP, 0.3MP
		<b>A835:</b> 8MP:(3264x2448),(3:2)7MP:(3264x2176), (16:9)6MP:(3264x1836), 5MP: (2560x1920), 3MP, 2MP, 1MP, 0.3MP
	Movie	640x480pixels: 30fps/15fps, 320x240pixels: 30fps/15fps
Image Compression		Best, Fine, Normal
DCF, DPOF (Ver1.1) Support		Yes
File Format	Still Image	Exif 2.21 (JPEG)
	Movie	Quick Time Motion JPEG, Audio: G.711 [Monaural]
	Audio	WAVE [Monaural] (Max 60 seconds)
Shooting Modes		Auto, Manual, Image Stabilization, Scene (Sport, Children, Indoor, Leaf, Snow, Sunset, Fireworks, Glass, Museum, Landscape, Night Landscape, Night Portrait), Panorama, Portrait
Face-Detection		Yes
Red-eye Removal		Yes

Panorama Stitching	Yes
LCD Display	2.5 inch LTPS (low-temperature polycrystalline silicon) TFT color LCD (153,600 pixels)
ISO Sensitivity	Auto, ISO 80/100/200/400/800/1600
AF Method	Single AF, Multi-AF (TTL 9-point), AF Assist Light (On/Off)
Light Metering Method	Artificial Intelligence AE (Ai AE), Center-weighted Average, Spot (Fixed to center of frame)
Exposure Control Method	ProgramAE (AE-lock available)
Exposure Compensation	±2 EV in 1/3 Step increments
Shutter Speed	4 ~ 1/2000 second (Manual 30s)
Continuous Shooting	Approx. 1.8 fps (Large/Fine mode)
Playback Modes	Single Photo, Index (4/9/16 thumbnails), Slide Show, Movie (Slow-Motion possible), Zoom (Approx. 2X~8X), Audio, Histogram Display
White Balance Control	Auto (AWB), Daylight, Cloudy, Fluorescent, Fluorescent CWF, Incandescent, Manual

Internal Flash (Shooting Range)	Auto/Red-Eye Reduction/Forced Flash/No Flash/ Slow Synchro/Red-Eye Reduction+Slow Synchro
	Gno. 6.5 (ISO 100)
	Shooting Range Wide: Approx. 0.3m~4.6m / Tele: Approx. 0.3m~2.7m (ISO 400)
Recording Media	Internal Memory: 32MB
	SD Card/SDHC Card (Up to 4GB support)
Other Features	PictBridge, ExifPrint Support, Multi-language Support (20 languages)
Jacks	USB2.0/AV-OUT (Integrated Proprietary Connector)
Power	2X AA Alkaline Battery, AA NiMH Battery [Sold Separately]
Shooting Capability (Battery Performance)	AA Alkaline Batteries: Approx. 130 shots (based on CIPA standards)
	AA NiMH Battery : Approx. 400 shots (CIPA Standards)
Operation Environment	Temperature: 0~40 <sup>0</sup> C, Humidity: 0~90%
Dimensions (W x H x D)	92 x 60 x 25 mm
Mass	Approx. 133g (Body only)



# Appendices

## Specifications : E840s/E1035/E1235



"Design and specifications are subject to change without notice."

Model name	E840s	E1035	E1235
Effective Image Sensor Pixels	8.0 Megapixels	10.1 Megapixels	12.1 Megapixels
Image Sensor	8.53 Megapixels 1/2.5" CCD	10.54 Megapixels 1/1.7" CCD	12.40 Megapixels 1/1.72" CCD
Lens Focal Length F =	6.15mm(Wide) ~ 24.6mm(Tele)	7.5mm (Wide) ~ 22.5mm (Tele)	7.5mm (Wide) ~ 22.5mm (Tele)
[35mm film equivalent]	[37mm (Wide) ~ 148mm (Tele)]	[35mm (Wide) ~ 105mm (Tele)]	[35mm (Wide) ~ 105mm (Tele)]
Lens F number	F3.4 (Wide) ~ F5.8 (Tele)	F2.8(Wide) ~ F4.9 (Tele)	F2.8(Wide) ~ F4.9 (Tele)
Lens Construction	7 elements in 6 groups	7 elements in 6 groups	7 elements in 7 groups
Optical Zoom	4X	3X	3X
Lens Focusing Range	Normal: 60cm ~∞ Macro: (W) 6cm~∞ (T) 40cm ~∞	Normal: 60cm ~∞ Macro: (W) 6cm ~ ∞ (T) 40cm ~ ∞	Normal: 60cm ~∞ Macro: (W) 6cm ~ ∞ (T) 40cm ~ ∞

Model name	E840s	E1035	E1235
Anti-Handshake	Electronic Image Stabilization		
Digital Zoom	4.5X digital zoom (Combined Zoom: 22.5X)	4.5X digital zoom (Combined Zoom: 13.5X)	4.5X digital zoom (Combined Zoom: 13.5X)
Number of Recording Pixels : Still Image (See page36)	8MP, 7MP(3:2), 6MP(16:9), 5MP, 3MP, 2MP, 1MP, 0.3MP	10MP, 9MP(3:2), 7MP(16:9), 5MP, 3MP, 2MP, 1MP, 0.3MP	12MP(4:3), 10MP(3:2), 9MP(16:9), 6MP, 3MP, 2MP, 1MP, 0.3MP
Number of Recording Pixels : Movie	640x480pixels: 30fps/ 15fps, 320x240pixels: 30fps/15fps	640x480pixels: 25fps/ 15fps, 320x240pixels: 25fps/15fps	640x480pixels: 20fps/ 15fps, 320x240pixels: 20fps/15fps
Image Compression	Best, Fine, Normal		
DCF, DPOF (Ver1.1) Support	Yes		
File Format : Still Image	Exif 2.2 (JPEG)		

Model name	E840s	E1035	E1235
File Format : Movie	Image Compression: MPEG4, Audio: G.711 [Monaural]		
File Format : Audio	WAVE [Monaural] (Max 60 seconds)		
Shooting Modes	Auto, Manual, Image Stabilization, Movie, Scene (Sport, Children, Indoor, Leaf, Snow, Sunset, Fireworks, Glass, Museum, Landscape, Night Landscape, Night Portrait), Panorama, Portrait		
Face-Detection	Yes		
Red-eye Removal	Yes		
Panorama Stitching	Yes		
LCD Display	2.7 inch LTPS TFT color LCD (230,400 pixels)	2.7 inch LTPS TFT color LCD (230,400 pixels)	2.7 inch LTPS TFT color LCD (230,400 pixels)

Model name	E840s	E1035	E1235
ISO Sensitivity	Auto, ISO 80/100/200 /400/800/1600	Auto, ISO 64/100/200/400/800/1600/3200	Auto, ISO 64/100/200/400/800/1600/3200 (3M)
AF Method	Single AF, Multi-AF (TTL 9-point), Face-Detection, AF Assist Light (On/Off)		
Light Metering Method	Artificial Intelligence AE (Ai AE), Center-weighted Average, Spot (Fixed to center of frame)		
Exposure Control Method	ProgramAE (AE-lock available)		
Exposure Compensation	±2 EV in 1/3 steps		
Shutter Speed	4 ~ 1/2000 second (Manual 30 seconds)		
Continuous Shooting	Approx. 1.8 fps (Large/Fine mode)	Approx. 1.39 fps (Large/Fine mode)	Approx. 1.25 fps (Large/Fine mode)
Playback Modes	Single Photo, Index (4/9/16 thumbnails), Slide Show, Movie (Slow-Motion possible), Zoom (E840s Approx. 2X~8X , E1035/E1235 Approx. 1X~8X), Audio , Histogram Display		
White Balance Control	Auto (AWB), Daylight, Cloudy, Fluorescent , Fluorescent CWF, Incandescent, Manual		

Model name	E840s	E1035	E1235
Internal Flash (Shooting Range)	Auto/Red-Eye Reduction/Forced Flash/No Flash/Slow Synchro/Red-Eye Reduction+Slow Synchro		
	Gno. 5.9 (ISO 100)	Gno. 5.7±0.5EV (ISO 100)	Gno. 5.7±0.5EV (ISO 100)
	(Shooting Range) (Wide): Approx. 0.3m~3.3m (Tele) : Ap- prox. 0.3m~2.7m (ISO 400)	(Shooting Range) (Wide): Approx. 0.3m~4.1m (Tele) : Approx. 0.3m~2.3m (ISO 400)	(Shooting Range) (Wide): Approx. 0.3m~3.2m (Tele) : Approx. 0.3m~2.0m (ISO 400)
Recording Media	Internal Memory: 26MB		
	SD Card/SDHC Card (Up to 4GB support)		
Other Features	PictBridge, Exif Print Support, Multi-language Support (11 languages)		
Jacks	USB2.0/AV-OUT (Integrated Proprietary Connector)		
Power	Rechargeable Lithium- ion Battery GB-20, 3.7V 750mAh	Rechargeable Lithium- ion Battery GB-40, 3.7V 1050mAh	Rechargeable Lithium- ion Battery GB-40, 3.7V 1050mAh
Battery Charger	Input Voltage : AC 100 to 240V, 50/60Hz, 100mA Output Voltage : DC 4.2V, 500mA"		

Model name	E840s	E1035	E1235
Shooting Capability (Battery Performance)	Approx. 200 shots (based on CIPA standards)	Approx. 210 shots (based on CIPA standards)	Approx. 210 shots (based on CIPA standards)
Operation Environment	Temperature: 0~40 <sup>0</sup> C, Humidity: 0~90%		
Dimensions (W x H x D)	95.7 x 56 x 19.5 mm	103 x 56 x 24 mm	103 x 56 x 24 mm
Mass	Approx. 95g (without the battery)	Approx. 145g (without the battery)	Approx. 145g (without the battery)

## Error messages

Messages	Explanation
No card	<ul style="list-style-type: none"><li>• The memory card is not inserted.</li></ul>
Card error	<ul style="list-style-type: none"><li>• The memory card is not formatted. (See P.68)</li></ul>
Card full	<ul style="list-style-type: none"><li>• The memory card is full and cannot store any new images.</li></ul>
Write protect	<ul style="list-style-type: none"><li>• The memory card is write-protected.</li></ul>
Picture error	<ul style="list-style-type: none"><li>• The picture is not captured correctly.</li><li>• The picture is damaged.</li></ul>
No picture	<ul style="list-style-type: none"><li>• There are no images in the memory card or in the internal memory.</li></ul>
Lens error	<ul style="list-style-type: none"><li>• The lens is probably stuck and the camera will power off automatically.</li></ul>
System error	<ul style="list-style-type: none"><li>• Unexpected error encountered.</li></ul>
No sound file	<ul style="list-style-type: none"><li>• There are no audio files in the memory card or in the internal memory.</li></ul>
Image cannot be saved	<ul style="list-style-type: none"><li>• The write protection switch in the memory card is set to the "LOCK" position.</li></ul>

**Messages****Explanation**

Card is not formatted, format?	<ul style="list-style-type: none"><li>• Confirm whether the memory card should be formatted.</li></ul>
This image cannot be deleted	<ul style="list-style-type: none"><li>• The picture or video you are trying to delete is protected.</li></ul>
Cannot record movie	<ul style="list-style-type: none"><li>• The write protection switch in the memory card is set to the "LOCK" position.</li></ul>
Sound file cannot be saved	<ul style="list-style-type: none"><li>• The write protection switch in the memory card is set to the "LOCK" position.</li></ul>
Warning!! Camera recording, please wait.	<ul style="list-style-type: none"><li>• No other actions allowed to perform during video/audio recording.</li></ul>
Warning!! Battery exhausted.	<ul style="list-style-type: none"><li>• The battery is out of charge.</li></ul>
This file cannot be played back	<ul style="list-style-type: none"><li>• The picture format cannot be recognized by the camera.</li></ul>
No connection	<ul style="list-style-type: none"><li>• The camera is not connected to the printer correctly.</li></ul>
Print error	<ul style="list-style-type: none"><li>• There is a problem with camera or printer.</li></ul>
Cannot print	<ul style="list-style-type: none"><li>• Check that the printer is out of paper or out of ink.</li><li>• Check if the printer has a paper jam.</li></ul>



## Troubleshooting

Problem	Possible causes	Solution
Camera does not turn on.	<ul style="list-style-type: none"><li>• The battery has run out.</li><li>• The battery is not inserted correctly.</li></ul>	<ul style="list-style-type: none"><li>• Charge the battery or replace with a fully charged battery.</li><li>• Re-insert the battery observing the correct polarity.</li></ul>
Camera turns off suddenly during operation.	<ul style="list-style-type: none"><li>• The battery has run out.</li></ul>	<ul style="list-style-type: none"><li>• Charge the battery or replace with a fully charged battery.</li></ul>
The picture is blurred.	<ul style="list-style-type: none"><li>• The lens is dirty.</li><li>•  appears when taking pictures.</li></ul>	<ul style="list-style-type: none"><li>• Use a soft cloth to clean the lens on your camera</li><li>• Use the <b>Image Stabilization</b> mode.</li></ul>
Images, video clips, and audio files cannot be saved.	<ul style="list-style-type: none"><li>• The memory card is full.</li></ul>	<ul style="list-style-type: none"><li>• Replace the memory card with a new one.</li><li>• Delete unwanted images.</li><li>• Unlock the memory card.</li></ul>

Problem	Possible causes	Solution
No picture is taken when pressing the shutter button.	<ul style="list-style-type: none"> <li>• The memory card is full.</li> <li>• No available space to store the files.</li> <li>• The mode dial is in <b>Playback</b> mode.</li> </ul>	<ul style="list-style-type: none"> <li>• Replace the memory card with a new one or clean off current memory card.</li> <li>• Delete unwanted images.</li> <li>• The memory card is locked.</li> <li>• Turn the mode dial to any still shooting mode.</li> </ul>
Images cannot print from the connected printer.	<ul style="list-style-type: none"> <li>• The camera is not connected to the printer correctly.</li> <li>• The printer is not PictBridge compatible.</li> <li>• The printer is out of paper or out of ink.</li> <li>• The paper is jammed.</li> </ul>	<ul style="list-style-type: none"> <li>• Check the connection between the camera and printer.</li> <li>• Use a PictBridge compatible printer.</li> <li>• Load some paper in the printer.</li> <li>• Replace the ink cartridge in the printer.</li> <li>• Remove the jammed paper.</li> </ul>