

VIZIO



USER MANUAL

Model: D24hn-G9

THANK YOU FOR CHOOSING VIZIO

And congratulations on your new VIZIO TV.

To get the most out of your new VIZIO product, read these instructions before using your product and retain them for future reference. Be sure to inspect the package contents to ensure there are no missing or damaged parts.

PRODUCT REGISTRATION

To purchase or inquire about accessories and installation services for your VIZIO product, visit our website at www.VIZIO.com or call toll free at (877) 698-4946.

We recommend that you register your VIZIO product at www.VIZIO.com.

EXTENDED WARRANTIES

For peace of mind, and to protect your investment beyond the standard warranty, VIZIO offers on-site extended warranty service plans. These plans provide additional coverage during the standard warranty period. To purchase an extended warranty service plan, visit www.VIZIO.com.

WHEN READING THIS MANUAL



When you see this symbol, please read the accompanying important warning or notice. It is intended to alert you to the presence of important operating instructions.



When you see this symbol, please read the accompanying helpful tip.

IMPORTANT SAFETY INSTRUCTIONS

Your TV is designed and manufactured to operate within defined design limits. Misuse may result in electric shock or fire. To prevent your TV from being damaged, the following instructions should be observed for the installation, use, and maintenance of your TV. Read the following safety instructions before operating your TV. Keep these instructions in a safe place for future reference.

- To reduce the risk of electric shock or component damage, switch off the power before connecting other components to your TV.
- Read these instructions.
- Keep these instructions.
- Heed all warnings.
- Follow all instructions.
- Do not use this apparatus near water.
- Clean only with dry cloth.
- Do not block any ventilation openings. Install in accordance with the manufacturer's instructions.
- Do not install near any heat sources such as radiators, heat registers, stoves, or other apparatus (including amplifiers) that produce heat.
- Do not defeat the safety purpose of the polarized or grounding-type plug. A polarized plug has two blades with one wider than the other. A grounding type plug has two blades and a third grounding prong. The wide blade or the third prong are provided for your safety. If the provided plug does not fit into your outlet, consult an electrician for replacement of the obsolete outlet.
- Protect the power cord from being walked on or pinched particularly at plugs, convenience receptacles, and the point where they exit from the apparatus.
- Only use attachments/accessories specified by the manufacturer.
- Use only with the cart, stand, tripod, bracket, or table specified by the manufacturer, or sold with the apparatus. When a cart is used, use caution when moving the cart/apparatus combination to avoid injury from tip-over. 
- Unplug this apparatus during lightning storms or when unused for long periods of time.

- Refer all servicing to qualified service personnel. Servicing is required when the apparatus has been damaged in any way, such as power-supply cord or plug is damaged, liquid has been spilled or objects have fallen into the apparatus, the apparatus has been exposed to rain or moisture, does not operate normally, or has been dropped.
- Unplug the power cord before cleaning your TV.
- When moving your TV from an area of low temperature to an area of high temperature, condensation may form in the housing. Wait before turning on your TV to avoid causing fire, electric shock, or component damage.
- A distance of at least three feet should be maintained between your TV and any heat source, such as a radiator, heater, oven, amplifier etc. Do not install your TV close to smoke. Operating your TV close to smoke or moisture may cause fire or electric shock.
- Slots and openings in the back and bottom of the cabinet are provided for ventilation. To ensure reliable operation of your TV and to protect it from overheating, be sure these openings are not blocked or covered. Do not place your TV in a bookcase or cabinet unless proper ventilation is provided.
- Never push any object into the slots and openings on your TV cabinet. Do not place any objects on the top of your TV. Doing so could short circuit parts causing a fire or electric shock. Never spill liquids on your TV.
- Your TV should be operated only from the type of power source indicated on the label. If you are not sure of the type of power supplied to your home, consult your dealer or local power company.
- Do not apply pressure or throw objects at your TV. This may compromise the integrity of the TV. The manufacturer's warranty does not cover user abuse or improper installations.
- The power cord must be replaced when using different voltage than the voltage specified. For more information, contact your dealer.
- When connected to a power outlet, power is always flowing into your TV. To totally disconnect power, unplug the power cord.
- The lightning flash with arrowhead symbol within an equilateral triangle is intended to alert the user to the presence of un-isolated, dangerous voltage within the inside of your TV that may be of sufficient magnitude to 

- constitute a risk of electric shock to persons.
- Do not overload power strips and extension cords. Overloading can result in fire or electric shock.
 - The wall socket should be installed near your TV and easily accessible.
 - Only power of the marked voltage can be used for your TV. Any other voltage than the specified voltage may cause fire or electric shock.
 - Do not touch the power cord during lightning. To avoid electric shock, avoid handling the power cord during electrical storms.
 - Unplug your TV during a lightning storm or when it will not be used for long period of time. This will protect your TV from damage due to power surges.
 - Do not attempt to repair or service your TV yourself. Opening or removing the back cover may expose you to high voltages, electric shock, and other hazards. If repair is required, contact your dealer and refer all servicing to qualified service personnel.
 - **WARNING:** Keep your TV away from moisture. Do not expose your TV to rain or moisture. If water penetrates into your TV, unplug the power cord and contact your dealer. Continuous use in this case may result in fire or electric shock.
 - Do not use your TV if any abnormality occurs. If any smoke or odor becomes apparent, unplug the power cord and contact your dealer immediately. Do not try to repair your TV yourself.
 - Avoid using dropped or damaged appliances. If your TV is dropped and the housing is damaged, the internal components may function abnormally. Unplug the power cord immediately and contact your dealer for repair. Continued use of your TV may cause fire or electric shock.
 - Do not install your TV in an area with heavy dust or high humidity. Operating your TV in environments with heavy dust or high humidity may cause fire or electric shock.
 - Follow instructions for moving your TV. Ensure that the power cord and any other cables are unplugged before moving your TV.
 - To prevent injury, this apparatus must be securely attached to the floor/wall in accordance with the installation instructions.
 - When unplugging your TV, grab the head of the power plug, not the cord. Pulling on the power cord may damage the wires inside the cord and cause fire or electric shock. When your TV will not be used for an extended period of time, unplug the power cord.

- To reduce risk of electric shock, do not touch the connector with wet hands.
- Insert batteries in accordance with instructions. Incorrect polarities may cause the batteries to leak which can damage the remote control or injure the operator. Do not expose batteries to excessive heat such as sunshine, fire or the like.
- If any of the following occurs, contact the dealer:
 - The power cord fails or frays.
 - Liquid sprays or any object drops into your TV.
 - Your TV is exposed to rain or other moisture.
 - Your TV is dropped or damaged in any way.
 - The performance of your TV changes substantially.
- This apparatus shall not be exposed to dripping or splashing and no objects filled with liquids, such as vases, shall be placed on the apparatus.
- The mains plug or appliance coupler is used as the disconnect device, the disconnect device shall remain readily operable.
- **CAUTION:** These servicing instructions are for use by qualified service personnel only. To reduce the risk of electric shock, do not perform any servicing other than that contained in the operating instructions unless you are qualified to do so.
- The lightning flash with arrowhead symbol within an equilateral triangle is intended to alert the user to the presence of uninsulated DANGEROUS VOLTAGE within the product's enclosure that may be of sufficient magnitude to constitute a risk of electrical shock to persons.
- **WARNING:** Exposure to loud sounds can damage your hearing causing hearing loss and tinnitus (ringing or buzzing in the ears). With continued exposure to loud noises, ears may become accustomed to the sound level, which may result in permanent damage to hearing without any noticeable discomfort.
- Install the TV where it cannot be pulled, pushed or knocked over.
- Do not allow children to hang onto the product.
- Store the accessories (remote, batteries, etc.) in a location safely out of the reach of children.
- The American Academy of Pediatrics discourages television viewing for children younger than two years of age.
- **WARNING:** Never place a television set in an unstable location. A television set may fall, causing serious personal injury or death.



- Many injuries, particularly to children, can be avoided by taking simple precautions such as:
 - Using cabinets or stands recommended by the manufacturer of the television set.
 - Only using furniture that can safely support the television set.
 - Ensuring the television set is not overhanging the edge of the supporting furniture.
 - Not placing the television set on tall furniture (for example, cupboards or bookcases) without anchoring both the furniture and the television set to a suitable support.
 - Not placing the television set on cloth or other materials that may be located between the television set and the supporting furniture.
 - Educating children about the dangers of climbing on furniture to reach the television set or its controls.
- If your existing television set is being retained and relocated, the same considerations as above should be applied.
- **WARNING:** To prevent injury, this apparatus must be securely attached to the floor/wall in accordance with the installation instructions.

TELEVISION ANTENNA CONNECTION PROTECTION

If an outside antenna/satellite dish or cable system is to be connected to the TV, make sure that the antenna or cable system is electrically grounded to provide some protection against voltage surges and static charges.

Article 810 of the National Electrical Code, ANSI/NFPA 70, provides information with regard to proper grounding of the mast and supporting structure, grounding of the lead-in wire to an antenna discharge unit, size of the grounding conductors, location of antenna discharge unit, connection to grounding electrodes, and requirements of the grounding electrode.

Lightning Protection

For added protection of the TV during a lightning storm or when it is left unattended or unused for long periods of time, unplug the TV from the wall outlet and disconnect the antenna or cable system.

Power Lines

Do not locate the antenna near overhead light or power circuits, or where it could fall into such power lines or circuits. Remember, the screen of the coaxial cable is intended to be connected to earth in the building installation.

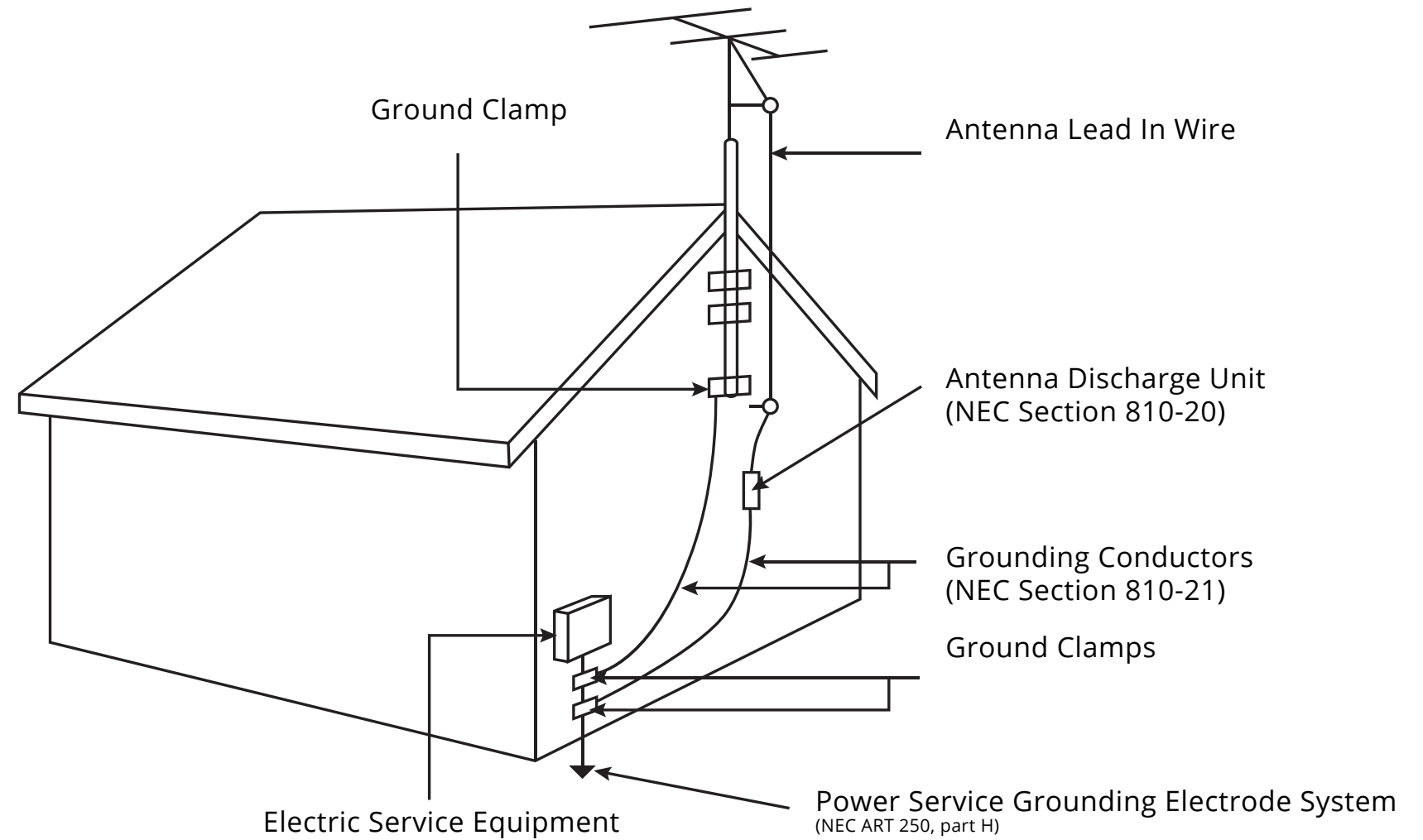



For DTS patents, see <http://patents.dts.com>.

Manufactured under license from DTS, Inc. DTS, the Symbol, DTS and the Symbol together, and TruSurround are registered trademarks and/or trademarks of DTS, Inc. in the United States and/or other countries. © DTS, Inc. All Rights Reserved.



Manufactured under license from Dolby Laboratories. Dolby, Dolby Audio, and the double-D symbol are trademarks of Dolby Laboratories.



The terms HDMI, HDMI High-Definition Multimedia Interface, and the HDMI Logo are trademarks or registered trademarks of HDMI Licensing Administrator, Inc.

Table Of Contents

Getting to Know Your TV	7	Setting the Timer	23	Using the Info Window	33
Front Panel	7	Setting the Auto Power Off Feature	23	Playing USB Media	34
Rear Panel	8	Setting Up Channels	24	Displaying USB Media.....	34
Connecting your devices	9	Scanning for Channels	24	Removing the USB Drive from the TV	34
Wall-mounting the TV	12	Skipping Channels	24	Troubleshooting & Technical Support.....	35
Using the remote	13	Listening to Alternate Audio	25	Specifications	38
Completing The First-Time Setup	14	Changing the Analog Audio Language	25	Regulatory Information	39
Using the On-Screen Menu	15	Parental controls	26	Limited Warranty	40
Navigating the On-Screen Menu.....	15	Using Parental Controls	26	Legal Information.....	42
Changing the Input Source	15	Enabling or Disabling Program Ratings	26		
Changing the Screen Aspect Ratio.....	16	Locking and Unlocking Channels.....	26		
Adjusting the Picture Settings.....	17	Blocking and Unblocking Content by Rating	26		
Adjusting More Picture Settings	17	Setting Up Closed Captioning	27		
Adjusting the Color Temperature.....	18	Changing the Appearance of Digital Closed Captions	27		
Adjusting the Picture Mode Edit Settings	18	Renaming Devices on the Input Menu	29		
Saving a Custom Picture Mode.....	18	Changing the TV Settings	30		
Locking/Unlocking a Custom Picture Mode.....	19	Viewing System Information.....	30		
Deleting a Custom Picture Mode.....	19	Changing the On-Screen Menu Language	30		
Resetting a Picture Mode	19	Setting the Time and Local Settings	31		
Adjusting the Color Tuner Settings	20	Adjusting the CEC Settings.....	31		
Adjusting the Audio Settings.....	22	Using the Reset & Admin Menu.....	32		
Setting Timers	23	Restoring the TV to Factory Default Settings.....	32		
		Setting a System Pin.....	32		

FRONT PANE



Remote Sensor and Power Indicator

When using the remote, aim it directly at this sensor. The power indicator flashes on when the TV turns on, then goes out after several seconds. To keep the power indicator on as long as the TV is on, see *Turning the Power Indicator On or Off*.

Rear Panel

HDMI - Connect an HDMI device.

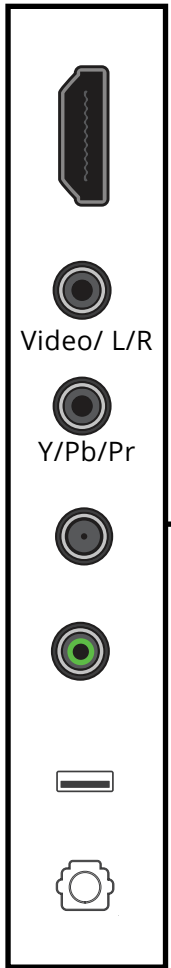

Component/Composite - Connect a component or composite.

Coaxial - Connect to a coaxial cable from cable, satellite, or antenna.

Stereo Audio Out - Connect 3.5mm audio device, such as a headset or sound bar.

USB - Connect a USB thumb drive to play photo.

Optical Audio Out - Connect to an optical/SPDIF audio device, such as home audio receiver.

Power - Press to turn on the TV. Press and hold to turn the TV off.

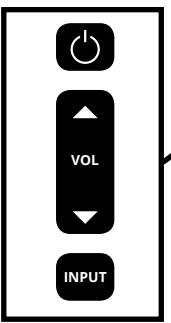

Volume - Press to increase or decrease the TV volume level.

Input - Press to access the input menu.

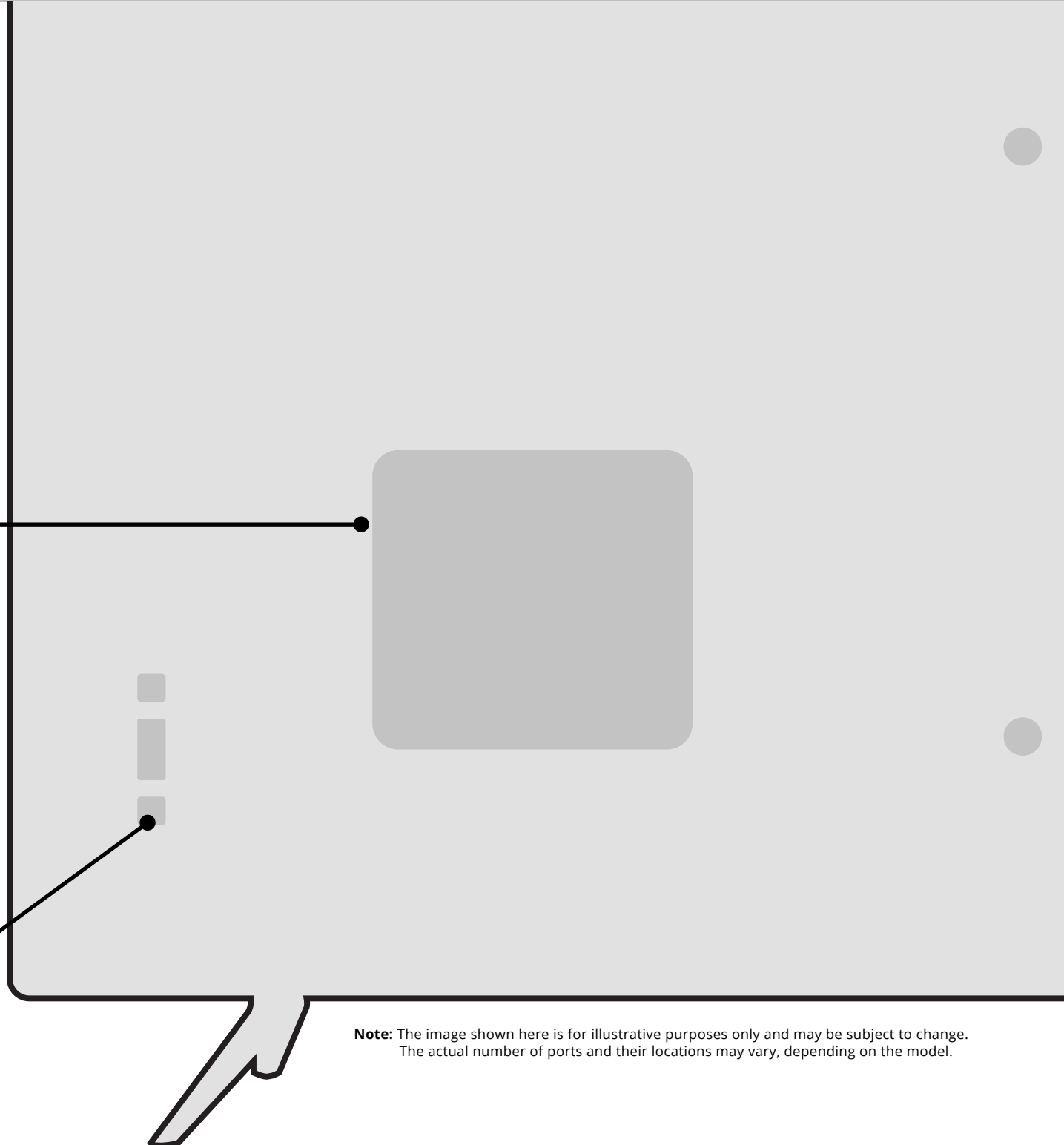

Note: The image shown here is for illustrative purposes only and may be subject to change. The actual number of ports and their locations may vary, depending on the model.

CONNECTING A DEVICE - AUDIO & VIDEO CABLE TYPES

Your TV can be used to display output from most devices.

- 1. Verify that your device has a video port that matches an available port on the TV (HDMI, Component, etc.).
- 2. Connect the appropriate cable (not included) to the TV and the device.
- 3. Turn the TV and your device on. Set the TV's input to match the connection you used (HDMI-1, HDMI-2, etc.).

HDMI CABLE



HDMI



COMPONENT CABLE



R L Pr/Cr Pb/Cb Y

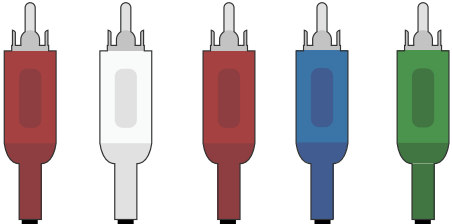

COMPOSITE (AV) CABLE
(Shared with Component input)



Y L R

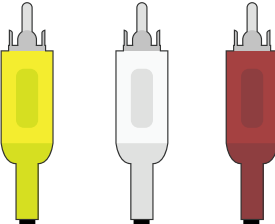

COAXIAL CABLE



Coaxial



Note: The actual ports and their locations may vary, depending on the TV model.

CONNECTING A DEVICE

D24hn-G9 includes a Component In/ AV In port that requires additional adapters (not included).

1. Connect the appropriate cable (not included) to the TV and the device using an adapter (not included).
2. Turn the TV and your device on. Set the TV's input to match the connection you used (Component or Composite).

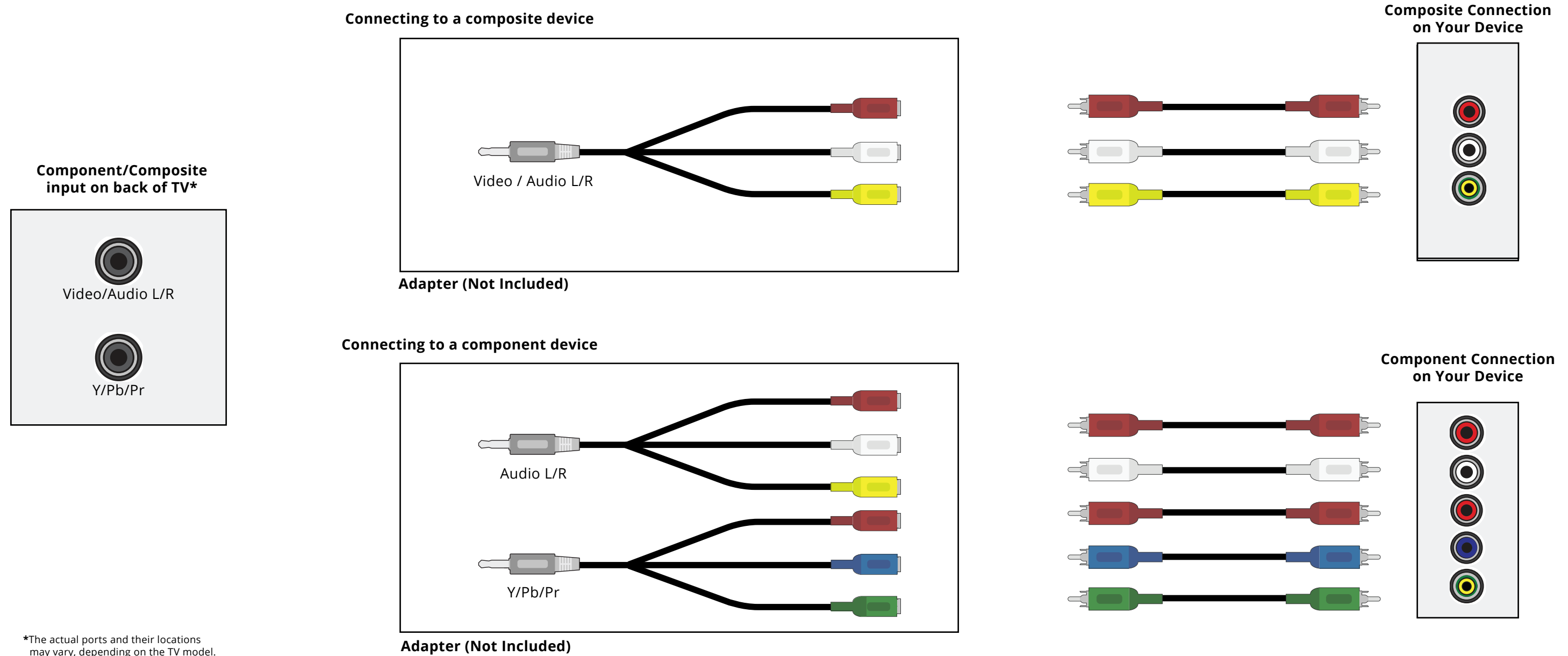

*The actual ports and their locations may vary, depending on the TV model.

CONNECTING A DEVICE - AUDIO CABLE TYPES

Your TV can be output sound to an audio device, such as a receiver or sound bar.

1. Verify that your device has audio port that matches an available port on the TV (Optical, RCA, etc).
2. Connect the appropriate cable (not included) to the TV and the device.
3. Turn the TV and your device on.

HDMI CABLE



HDMI

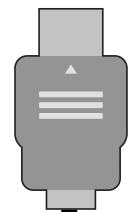

RCA CABLE



L

R

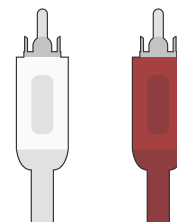

OPTICAL/SPDIF CABLE



Optical

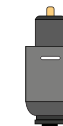

Note: The actual ports and their locations may vary, depending on the TV model.

WALL-MOUNTING THE TV

To mount your TV on a wall, you will need a wall mount. Consult the information on this page to find the appropriate mount for your TV.

Be sure the mount you choose is capable of supporting the weight of the TV. After you have determined that you have the correct mount for your TV, you can begin the installation.

To install your TV on a wall:

1. Disconnect any cables connected to your TV.
2. Place the TV face-down on a clean, flat, stable surface. Be sure the surface is clear of debris that can scratch or damage the TV.
3. If attached, remove the stands by loosening and removing the screws.
4. Attach your TV and wall mount to the wall, carefully following the instructions that came with your mount. Use only with a UL-listed wall mount bracket rated for the weight/load of this TV.

 Installing a TV on a wall requires lifting. To prevent injury or damage to the TV, ask someone to help you.

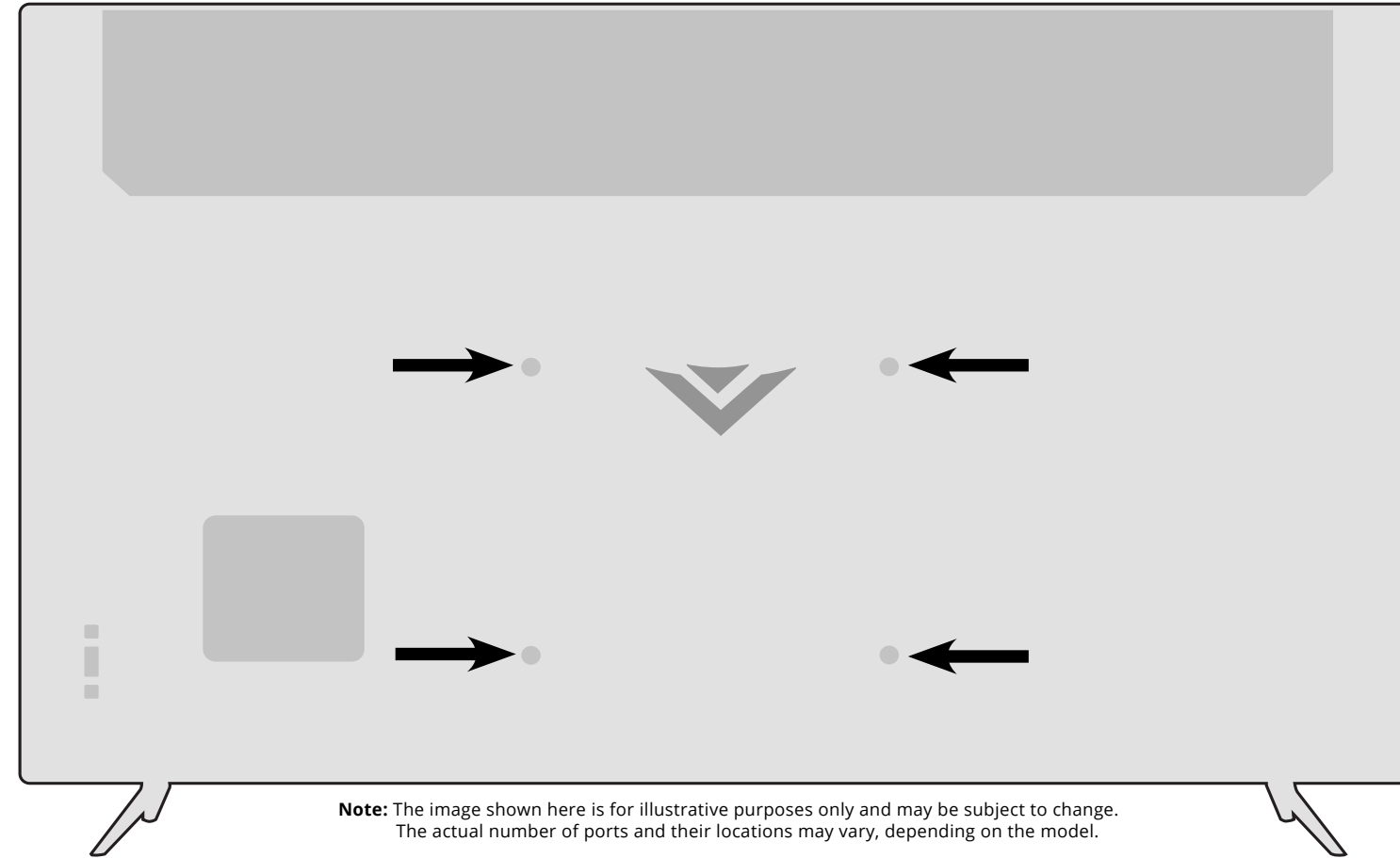

Note: The image shown here is for illustrative purposes only and may be subject to change. The actual number of ports and their locations may vary, depending on the model.

D24hn-G9	
Screw Size:	M4
Hole Depth:	8.5 mm
Hole Pattern:	100 mm x 100 mm
Weight w/o Stand:	5.95 lbs (2.70 kg)

USING THE REMOTE

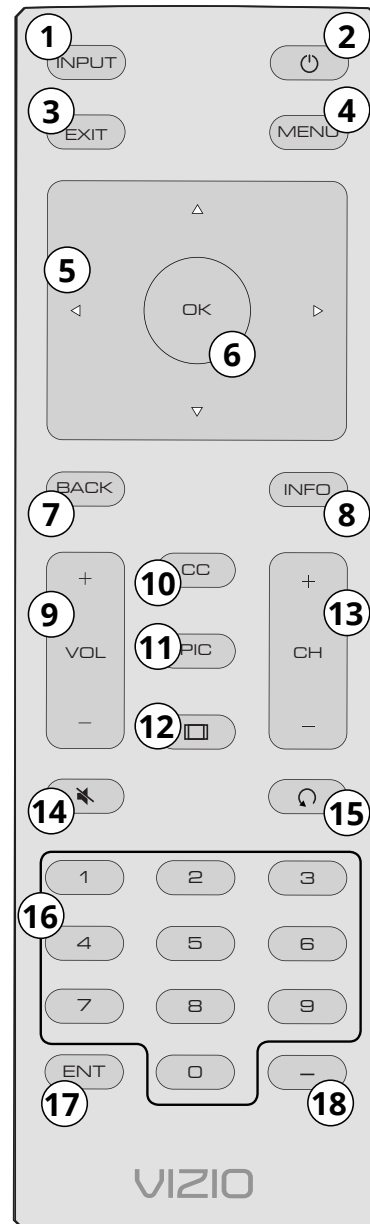

1. **Input** - Change the currently displayed input
2. **Power** - Turn Television on or off
3. **Exit** - Close the on-screen menu
4. **Menu** - Display the settings menu
5. **Arrow** - Navigate the on-screen menus
6. **OK / Enter** - Select the highlighted option / Confirm channel or passcode entered using the number pad.
7. **Back** - Go to the previous on-screen menu
8. **Info** - Display the info window
9. **Volume Up/Down** - Increase or decrease the loudness of the audio
10. **Closed Caption** - Open the closed caption menu
11. **Pic** - Cycle through the different picture setting modes
12. **Wide** - Change the Television mode
13. **Channel Up/Down** - Change the channel
14. **Mute** - Turn the audio on or off
15. **Last** - Return to the channel last viewed
16. **Number Pad** - Manually enter a channel
17. **Enter** - Confirm channel entered using the number pad.
18. **Dash** - Use with number pad to manually enter a digital sub-channel. (For example, 18-4 or 18-5)

Replacing the Batteries

1. Find the notch on the back of the remote. Insert a coin and pry open the back cover.

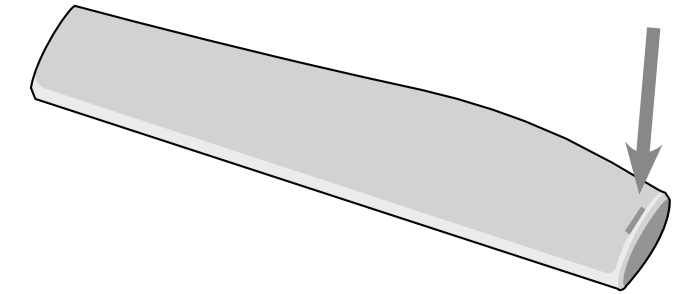

2. Insert two batteries into the remote control. Make sure that the (+) and (-) symbols on the batteries match the (+) and (-) symbols inside the battery compartment.
3. Replace the battery cover.

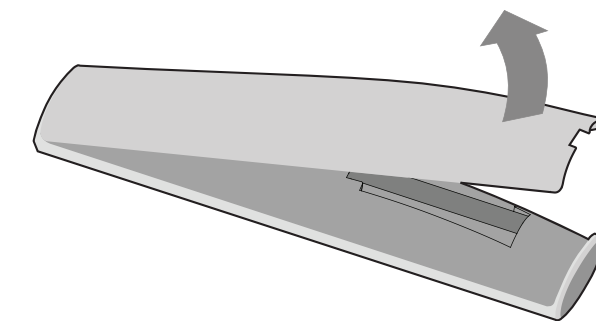

In many places batteries cannot be thrown away or discarded with household waste. Please ensure you properly dispose of your batteries consistent with the laws and/or regulations where you live. For more information please visit: www.vizio.com/environment



WARNING: keep the remote control batteries away from children. It may cause choking and/or lead to a fire or chemical burn if mishandled. Do not dispose of batteries in fire. Replace only with batteries of the correct type.



When needed, VIZIO recommends replacing the batteries that came with this remote with two, new Duracell 'AAA' alkaline batteries

**POWER UP WITH
DURACELL®**

The first time you turn on the TV, the on-screen instructions will guide you through each of the steps necessary to get your TV ready for use:

Before you begin the first-time setup:

- Your TV should be installed and the power cord should be connected to an electrical outlet.

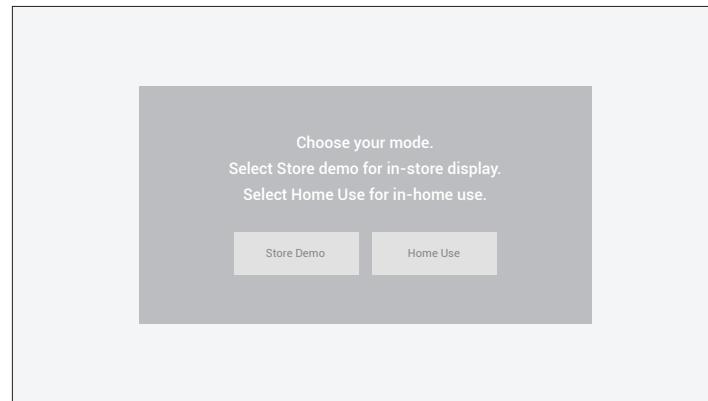

1. Choose home use.

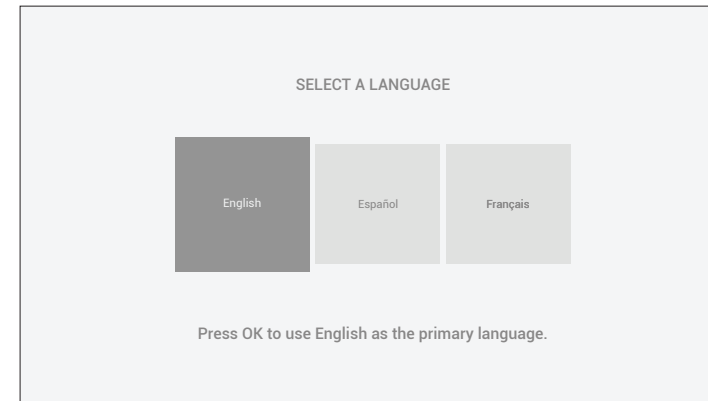

2. Choose your language

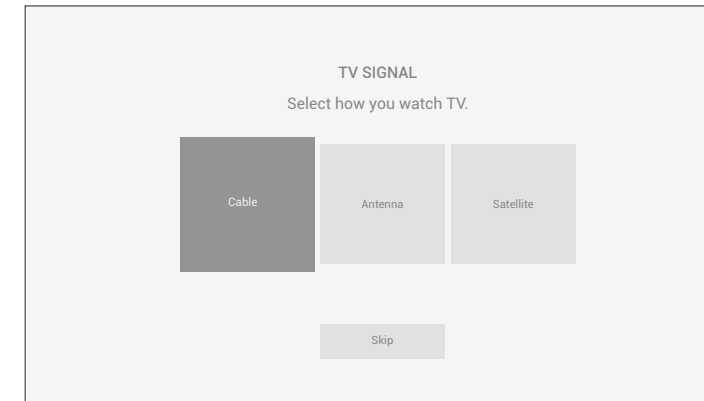

3. Select how you watch TV

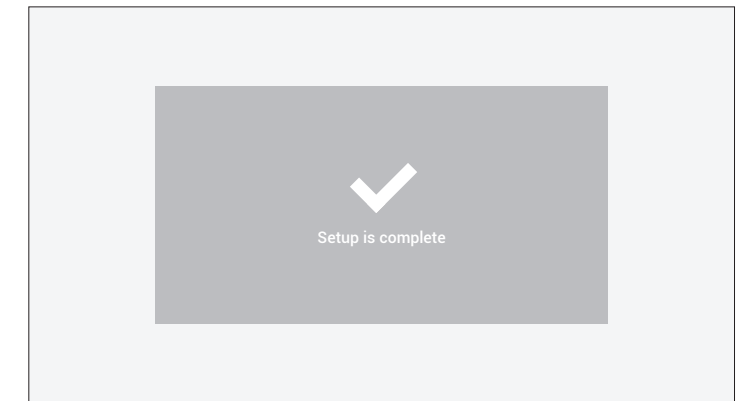

4. All set!

Your TV features an easy-to-use on-screen menu.

To open the on-screen menu, press the Menu button on the remote.

From this menu, you can:

- Adjust the Picture settings
- Adjust the Audio settings
- Set up the Timers
- Adjust the Channel settings
- Set up Closed Captioning
- Name and adjust Inputs
- Adjust TV settings

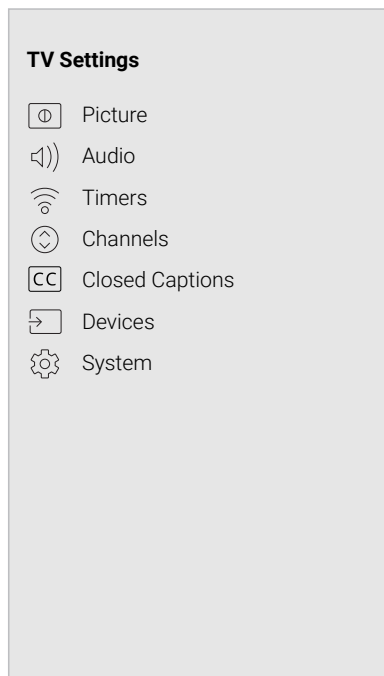

NAVIGATING THE ON-SCREEN MENU

To open the on-screen menu:

1. Press the **Menu** button on the remote.
2. Use the **Arrow** buttons to highlight a menu option, and press the **OK** button to select that option.

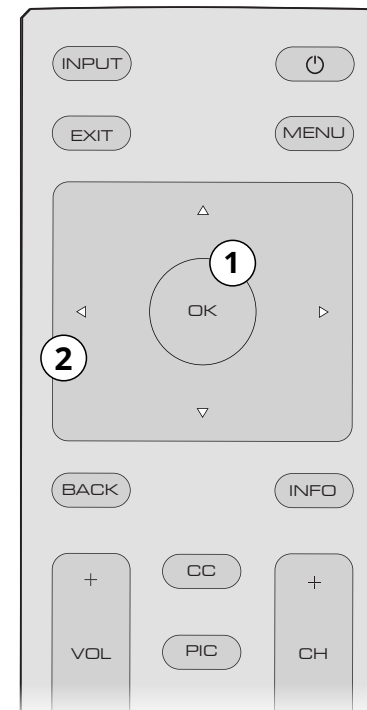

 While navigating the on-screen menu, you can press the **Back** button at any time to return to the previous menu screen. The **Exit** button will close the on-screen menu.

CHANGING THE INPUT SOURCE

External devices such as DVD players, Blu-ray Players, and video game consoles can be connected to your TV. To use one of these devices with your TV, you must first change the input source using the Input menu.

To change the input sources:

1. Press the **Input** button on the remote. The Input menu is displayed.
2. Use the **Right/Left Arrow** buttons or the **Input** button on the remote to highlight the input you wish to view and press **OK**. The selected input is displayed.

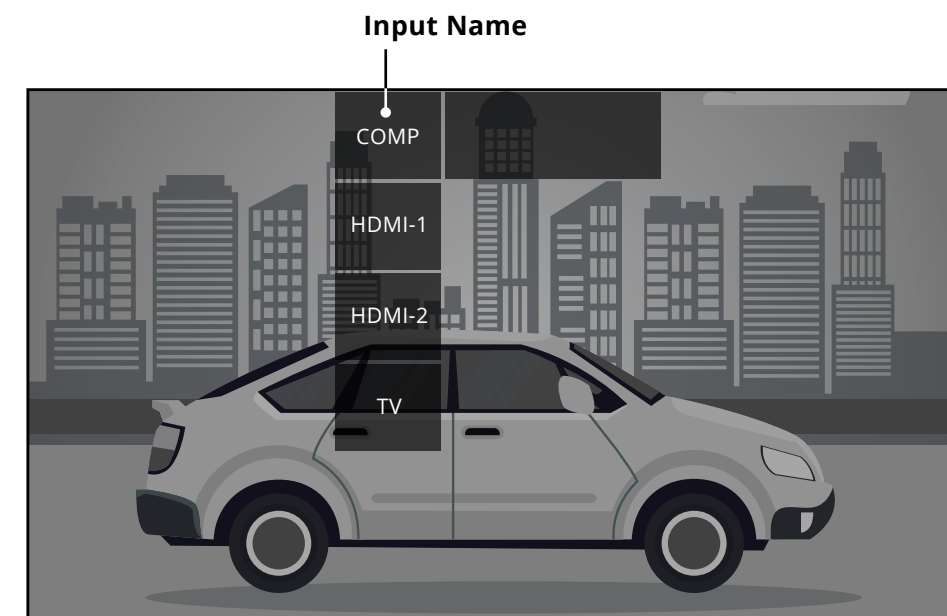

Note: Inputs may vary by TV.

 You can change the input names that appear on the Input menu to make your devices easy to recognize. See *Renaming Devices on the Input Menu* for more information.

CHANGING THE SCREEN ASPECT RATIO

The TV can display images in four different modes: Normal, Panoramic, Wide, and Zoom. Each mode displays the picture differently.

Some programs have black bars on the top or sides of the picture so that the picture keeps its original shape. Examples include wide-screen movies and older television programs.

To change the screen aspect ratio:

1. Press the **Wide** button on the remote.
2. Use the **Arrow** buttons to highlight the aspect ratio you wish to view and press **OK**.
 - **Normal** preserves the content's original aspect ratio and size.
 - **Stretch** expands a widescreen image to fill the screen from top to bottom and stretches it half as much from right to left. Figures appear tall and thin.
 - **Wide** stretches a 4:3 aspect ratio picture to the edges of the screen. Since the picture is being stretched, the display image may appear distorted—figures appear short and fat. If the program is already formatted for widescreen viewing (1.85:1 or 2.35:1), then black bars will appear on the top and bottom of the display image.
 - **Zoom** expands images evenly in all directions (33% taller and 33% wider) with black bars to fit the screen. A 720p image will fill a 1080p screen.

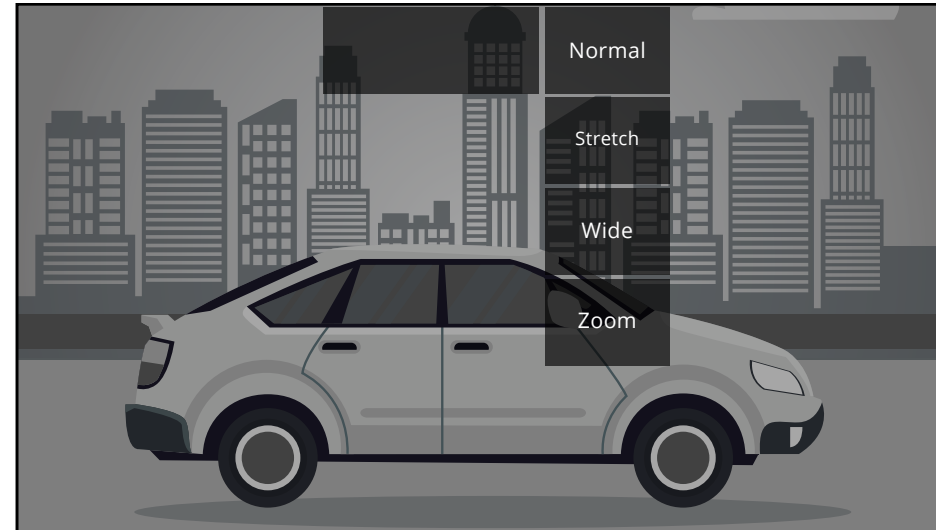

Note: Aspect ratio settings may vary by Input source.

ADJUSTING THE PICTURE SETTINGS

Your TV can be adjusted to suit your preferences and viewing conditions.



If you save changes to the settings for a picture mode, an asterisk appears after its name (see *Saving a Custom Picture Mode*).

To adjust the picture settings:

1. Press the Menu button on the remote. The on-screen menu is displayed.
2. Use the Arrow buttons on the remote to highlight Picture and press OK. The Picture menu is displayed.
3. Use the **Arrow** buttons on the remote to highlight **Picture Mode**, then use the **Left/Right Arrow** buttons to change the picture mode:
 - **Standard** mode sets the picture settings to the default settings.
 - **Calibrated** mode sets the picture settings to values ideal for watching TV in a brightly-lit room.
 - **Calibrated Dark** mode sets the picture settings to values ideal for watching TV in a dark room.
 - **Vivid** mode sets the picture settings to values that produce a brighter, more vivid picture.
 - **Game** mode reduces throughput delays and optimizes the picture settings for displaying game console output.
 - **Computer** mode optimizes the picture settings for displaying computer output.

4. To manually change each of the picture settings, use the **Up/Down Arrow** buttons on the remote to highlight that picture setting, then use the **Left/Right Arrow** buttons to adjust the setting:

- **Backlight** - Adjusts the LED brightness to affect the overall brilliance of the picture. Backlight cannot be adjusted when starting from some picture modes.
- **Brightness** - Adjusts the black level of the picture. When this setting is too low, the picture may be too dark to distinguish details. When this setting is too high, the picture may appear faded or washed out.
- **Contrast** - Adjusts the white level of the picture. When this setting is too low, the picture may appear dark. When this setting is too high or too low, detail may be difficult to distinguish in dark or bright areas of the picture.
- **Color** - Adjusts the intensity of the picture colors.
- **Tint** - Adjusts the hue of the picture. This setting is useful in adjusting the flesh tones in the picture. If flesh appears too orange, reduce the level of color before adjusting tint.
- **Sharpness** - Adjusts the edge sharpness of picture elements. It can be used to sharpen non-HD (high definition) content; however, it will not produce detail that does not otherwise exist.

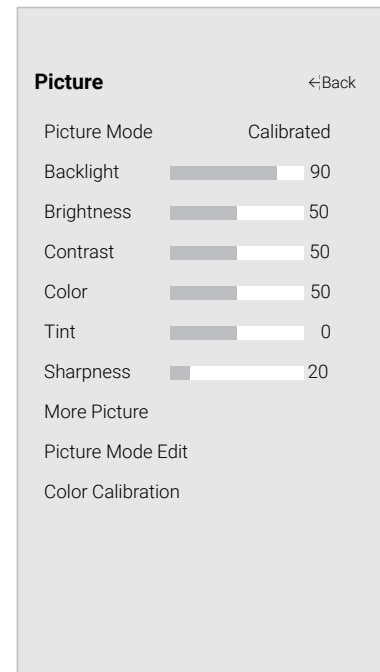

When you have finished adjusting the picture settings, press the **Exit** button on the remote.

Adjusting More Picture Settings

To adjust more picture settings:

1. From the PICTURE menu, use the **Arrow** buttons to highlight **More Picture**, and then press **OK**.
2. Use the **Arrow** buttons to highlight the setting you wish to adjust, then press the **Left/Right Arrow** buttons to change the setting:
 - **Color Temperature** - See *Adjusting the Color Temperature*.
 - **Black Detail** - Adjusts the average brightness of the picture to compensate for large areas of brightness. Select **Off**, **Low**, **Medium**, or **High**.
 - **Reduce Noise** - **Reduce Signal Noise** - Diminishes artifacts in the image caused by the digitizing of image motion content. Select **Off**, **Low**, **Medium**, or **High**.
- **Reduce Block Noise** - Reduces pixelation and distortion for mpeg files. Select **Off**, **Low**, **Medium**, or **High**.
 - **Game Low Latency** - Select **On** to reduce video delay (lag) when gaming.
 - **Film Mode** - Optimizes the picture for watching film. Select **Auto** or **Off**.
 - **Gamma** - Set the shape of the Gamma curve. Use lower Gamma values for bright room conditions, and higher values when it's dark.
3. When you have finished adjusting More Picture Settings, press the **Exit** button on the remote.

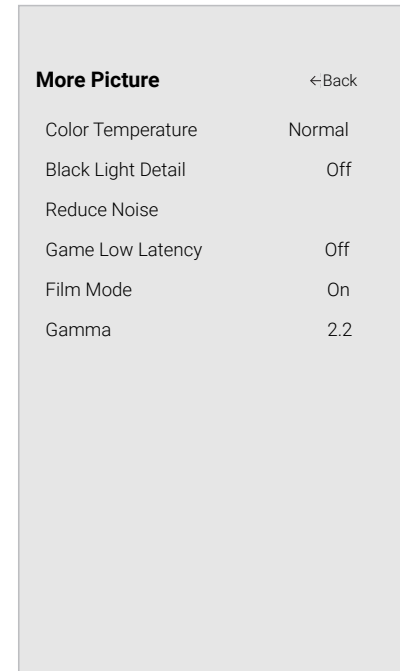

Adjusting the Color Temperature

Adjusting the color temperature changes the white balance of the picture.

To adjust the color temperature:

1. From the MORE PICTURE menu, use the **Arrow** buttons to highlight **Color Temperature**, and then press **OK**.
2. Use the **Arrow** buttons on the remote to highlight a color temperature preset and then press **OK**.
 - **Normal** is optimized for television viewing.
 - **Cool** produces a blue-hued picture.
 - **Computer** optimizes the picture for use as a PC monitor.
3. When you have finished adjusting the color temperature, press the **Exit** button on the remote.

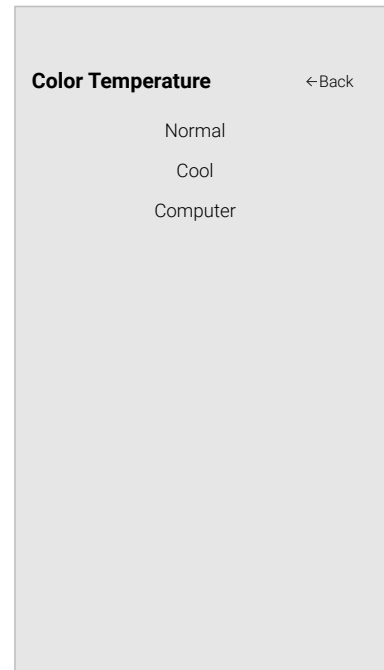

Adjusting the Picture Mode Edit Settings

Picture Mode Edit Settings allow you to make precise adjustments to the picture and to create picture modes to save groups of picture settings.

To adjust the Picture Mode Edit settings:

1. From the PICTURE menu, use the **Arrow** buttons to highlight **Picture Mode Edit**, and then press **OK**. The PICTURE MODE EDIT menu is displayed.
2. Use the **Arrow** buttons to highlight the setting you wish to adjust, then press **OK** to change the setting:
 - **Save Picture Mode** - Save a custom picture mode.
 - **Lock Picture Mode** - Prevent changes to custom picture modes. Choose between **On** or **Off**.
 - **Reset Picture Mode[†]** - Reset the picture mode settings to factory default values.

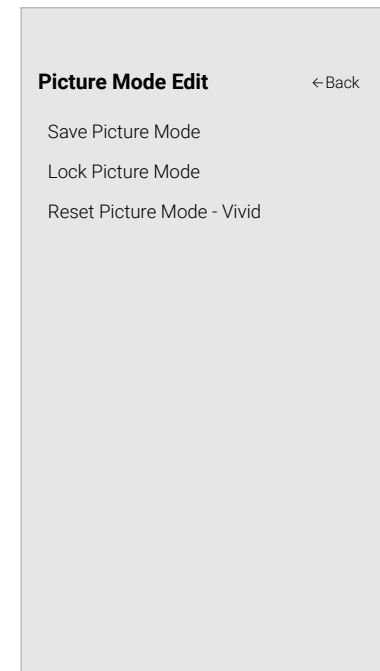

Saving a Custom Picture Mode

Custom picture modes allow you to save a group of custom settings for various viewing conditions and video sources.

- Changes made while on any preset picture mode will add an asterisk on the top right corner of the preset mode.
- The custom picture mode is not automatically saved.

To save a custom picture mode:

1. From the PICTURE MODE EDIT menu, use the **Arrow** buttons to highlight **Save Picture Mode**, and then press **OK**. The SAVE PICTURE MODE menu is displayed.
2. Use either on-screen keyboard to enter a name for your custom picture mode.
3. Highlight **Save** and press **OK**.
4. Press the **Exit** button to exit the menu screens.

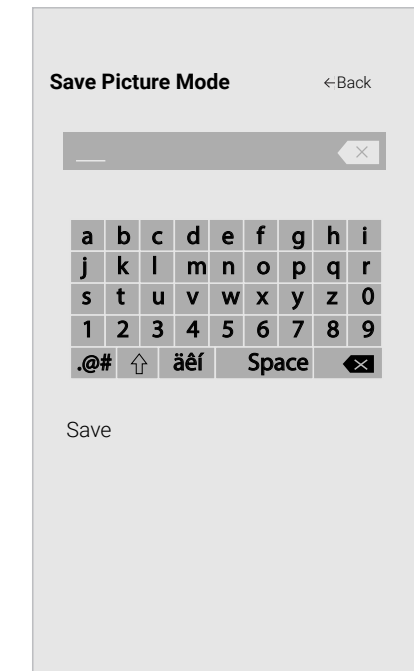

[†] Only available on customized preset modes.

Locking/Unlocking a Custom Picture Mode

Custom picture modes can be locked/unlocked with a unique PIN to prevent accidental changes to their settings.

To lock all custom picture modes:

1. From the PICTURE MODE EDIT menu, use the **Arrow** buttons to highlight **Lock Picture Mode**, and then press **OK**. The LOCK PICTURE MODE menu is displayed.
2. Use the **Number Pad** on your remote to enter a unique 4-digit PIN. If a system PIN is set, then lock/unlock. If no system PIN is set, then you will be prompted to set a PIN.
3. Highlight **Save** and press **OK**.
4. Press the **Exit** button to exit the menu screens.

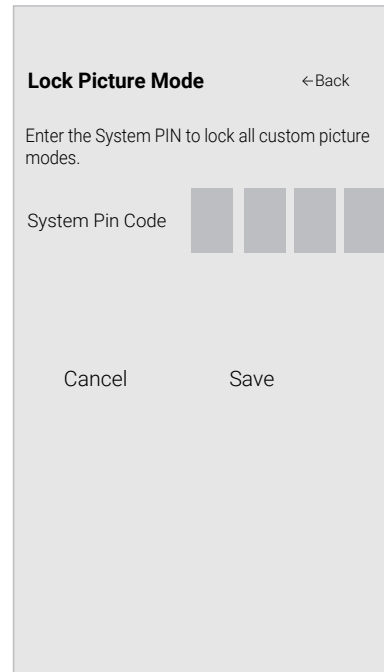

To unlock all custom picture modes:

1. From the PICTURE MODE EDIT menu, use the **Arrow** buttons to highlight **Lock Picture Mode**, and then press **OK**. The LOCK PICTURE MODE menu is displayed.
2. Use the **Arrow** buttons to select Off.
3. Use the **Number Pad** on your remote to enter your 4-digit PIN.
4. Make any desired changes to the picture modes.
5. Then turn ON Lock Picture Mode.
6. Press the **Exit** button to exit the menu screens.

Deleting a Custom Picture Mode

Custom picture modes that are no longer needed can be deleted.



Inputs assigned to a deleted custom picture mode become assigned to the *Calibrated* picture mode.

To delete a custom picture mode:

1. From the PICTURE MODE EDIT menu, use the **Arrow** buttons to highlight **Delete Picture Mode**, and then press **OK**. The DELETE PICTURE MODE window is displayed.
2. Use the **Left/Right** Arrow buttons to highlight **Delete** and press **OK**.
3. Press the **Exit** button to exit the menu screens.

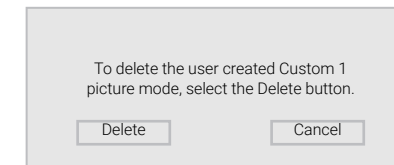

Resetting a Picture Mode

A preset picture mode that has been edited can be restored to the factory default settings.

To reset a customized preset picture mode:

1. From the PICTURE MODE EDIT menu, use the **Arrow** buttons to highlight **Reset Picture Mode**, and then press **OK**. The RESET PICTURE MODE window is displayed.
2. Use the **Left/Right** Arrow buttons to highlight **Reset** and press **OK**.
3. Press the **Exit** button to exit the menu screens.



Adjusting the Color Tuner Settings

The Color Tuner settings allow you to adjust the HSB color and 11 point white balance, turn color channels off for testing, and display color bar, flat, and ramp test patterns.



The Color Tuner, 11 Point White Balance, and test patterns allow technicians to manually calibrate the TV. Calibration requires specialized training, an input with precisely set colors, and a specialized light meter.

To adjust the HSB color settings:

1. From the COLOR CALIBRATION menu, use the Arrow buttons to highlight **Color Tuner**, and then press **OK**. The Color Tuner menu is displayed.

Color Tuner						
	Red	Green	Blue	Cyan	Magenta	Yellow
Hue	0	0	0	0	25	-14
Saturation	-1	5	-4	0	-2	0
Brightness	-24	0	-22	0	0	0
Offset	0	0	0			
Gain	0	0	0			

2. Use the **Arrow** buttons on the remote to highlight the Hue, Saturation, Brightness, Offset, or Gain of the color you wish to adjust. Press the **OK** button.
3. Use the **Left/Right Arrow** buttons to adjust the value. When you are finished press the **OK** button to save the setting.
4. When you have finished adjusting the color tuner settings, press the **Exit** button.

To turn color channels off and on:

1. From the COLOR CALIBRATION menu, use the **Arrow** buttons to highlight **Color Tuner**, and then press **OK**. The COLOR TUNER menu is displayed.

Color Tuner						
	Red	Green	Blue	Cyan	Magenta	Yellow
Hue	0	0	0	0	25	-14
Saturation	-1	5	-4	0	-2	0
Brightness	-24	0	-22	0	0	0
Offset	0	0	0			
Gain	0	0	0			

2. Use the **Arrow** buttons on the remote to highlight **Red, Green, or Blue**.
3. Press the **OK** button to turn the color channel off or on. An X appears over a color channel that has been turned off.
4. Use the **Arrow** buttons to highlight another color channel to turn off or on. Only two color channels can be turned off at the same time.
5. When you have finished with the color channels, press the **Exit** button.

To adjust the 11 Point White Balance settings:

1. From the Color Tuner menu, use the **Arrow** buttons to highlight **Color Tuner**, and then press the **Left/Right Arrow** buttons until the 11 POINT WHITE BALANCE menu is displayed.

11 Point White Balance				
Gain	Red	Green	Blue	
5%	0	0	0	

2. Use the **Arrow** buttons on the remote to highlight the **Gain** and **Color values** you wish to adjust. Press the **OK** button and use the **Left/Right Arrow** buttons to adjust the value. When you are finished, press the **OK** button to save the setting.
3. When you have finished, press the **Exit** button.

To show or hide the SMPTE Test Pattern:

1. From the Color Tuner menu, use the **Arrow** buttons to highlight **Calibration Tests**, and then press the **Left/Right Arrow** buttons until the SMPTE TEST PATTERN menu is displayed.

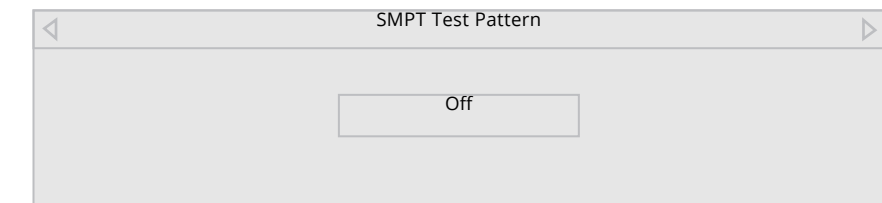

2. Use the **Arrow** buttons on the remote to highlight **Off**. Use the **Left/Right Arrow** buttons to highlight **On** to show the SMPTE Pattern.
—or—

To hide the SMPTE Test Pattern, use the **Left/Right Arrow** buttons to highlight **Off**.

3. When you are finished, press the **Exit** button.

To show or hide the Flat Test Pattern:

1. From the Color Tuner menu, use the **Arrow** buttons to highlight **Calibration Tests**, and then press the **Left/Right Arrow** buttons until the FLAT TEST PATTERN menu is displayed.

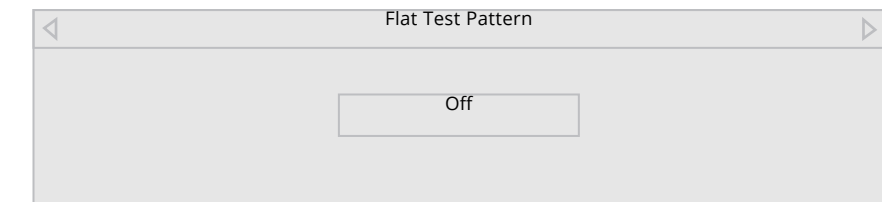

2. Use the **Arrow** buttons on the remote to highlight **Off**. Use the **Left/Right Arrow** buttons to select the percentage brightness for the flat test pattern. Selecting a percentage immediately shows the flat pattern at that brightness.

—or—

To disable the Flat Test Pattern, use the **Left/Right Arrow** buttons to highlight **Off**.

3. When you are finished, press the **Exit** button.

To show or hide the Ramp Test Pattern:

1. From the Color Tuner menu, use the **Arrow** buttons to highlight **Calibration Tests**, and then press the **Left/Right Arrow** buttons until the RAMP TEST PATTERN menu is displayed.

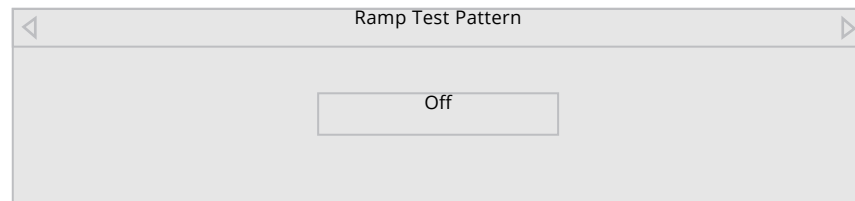

2. Use the **Arrow** buttons on the remote to highlight **Off**. Use the **Left/Right Arrow** buttons to select the color for the ramp test pattern. Selecting a color immediately shows that color ramp.

—or—

To hide the Ramp Test Pattern, use the **Left/Right Arrow** buttons to highlight **Off**.

3. When you are finished, press the **Exit** button.

To show or hide the Uniformity Analyzer Test Pattern:

1. From the Color Tuner menu, use the **Arrow** buttons to highlight **Calibration Test**, and then press the **Left/Right Arrow** buttons until the UNIFORMITY ANALYZER TEST PATTERN menu is displayed.

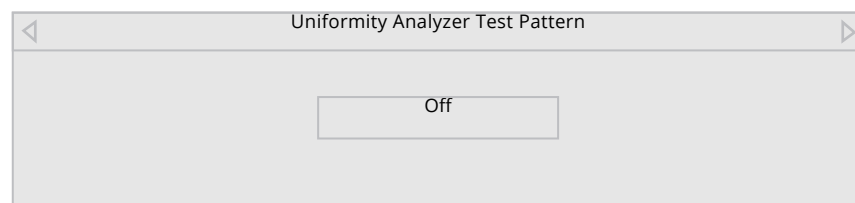

2. Use the **Arrow** buttons on the remote to highlight **Off**. Use the **Left/Right Arrow** buttons to highlight **On** to show the Uniformity Analyzer Test Pattern.

—or—

To hide the Uniformity Analyzer Test Pattern, use the **Left/Right Arrow** buttons to highlight **Off**.

3. When you are finished, press the **Exit** button.

ADJUSTING THE AUDIO SETTINGS

To adjust the audio settings:

1. Press the **Menu** button on the remote. The on-screen menu is displayed.
2. Use the **Arrow** buttons on the remote to highlight Audio and press **OK**. The Audio menu is displayed.
3. Use the **Arrow** buttons to highlight the setting you wish to adjust, then press **Left/Right Arrow** buttons to change the setting:
 - **Speakers** - Turns the built-in speakers On or Off.
 - **DTS TruSurround** - Toggle between On or Off to hide or display the Equalizer slider. When set On, DTS TruSurround audio provides Surround Sound to the TV speakers.

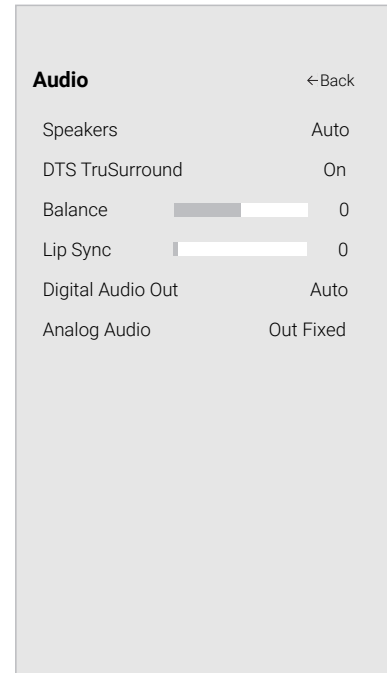

- **Analog Audio Out** - Sets the volume control properties for the RCA connector when connected to a home theater audio system. Select Variable if you are controlling the volume with the TV's volume controls, or select Fixed if an external audio device (sound bar or AV receiver) will control the volume.
4. When you have finished adjusting the audio settings, press the **Exit** button on the remote.



You must select **Bitstream** for audio with more than two channels (3.0, 5.0, or 5.1, for example).



When the TV speakers are set to On, DTS signals cannot be passed through digital audio outputs.

- **Balance** - Adjusts the loudness of the audio output from the left and right speakers.
- **Lip Sync** - Adjusts the synchronization between the display image and the accompanying audio track.
- **Digital Audio Out** - Changes the type of processing for digital audio out and HDMI ARC output when connected to a home theater audio system. Select Auto, PCM, Dolby D or Bitstream.

SETTING TIMERS

Setting the Timer

When activated, the TV's timer will turn the TV off after a set period of time.

1. Press the **Menu** button on the remote. The on-screen menu is displayed.
2. Use the **Arrow** buttons on the remote to highlight **Timers** and press **OK**. The TIMERS menu is displayed.
3. Use the **Left/Right Arrow** buttons on the remote to highlight the period of time after which you want the TV to go to sleep: **30, 60, 90, 120,** or **180 minutes**. If you don't want the sleep timer to activate, change the setting to **Off**.
4. When you have finished setting the sleep timer, press the **Exit** button on the remote.

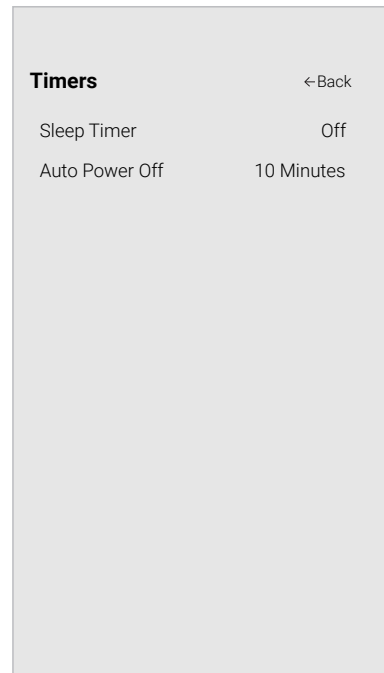

Setting the Auto Power Off Feature

To help save energy, your TV is set by default to turn off after 10 minutes without a video or audio signal. This feature can be deactivated.

To set the Auto Power Off feature:

1. From the TIMERS menu, use the **Up/Down Arrow** buttons on the remote to highlight **Auto Power Off**.
2. Use the **Left/Right Arrow** buttons on the remote to change whether the TV will turn off. If you don't want the TV to turn off when there is no signal, change the setting to **Off**. Otherwise, select **10 minutes**.
3. When you have finished setting the auto power off time, press the **Exit** button on the remote.

SETTING UP CHANNELS

You can use the TV's Channels menu to:

- Find Channels
- Select channels to skip
- Select Analog Audio mode
- Select the language for Digital Audio

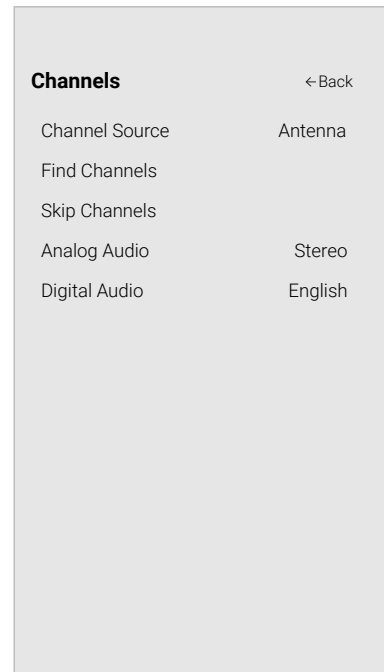

Scanning for Channels

The TV may need to scan for channels before it can display programs and their associated information. A channel scan is required for free over-the-air channels (using an antenna) and cable channels from an out-of-the-wall connection (without a cable box). Moving the TV to an area with different channels requires the TV to scan for channels again.

To perform an Auto Channel Scan:

1. From the CHANNELS menu, highlight **Find Channels**, and press **OK**. The auto channel scan begins.
2. Wait until the channel scan is 100% complete. Highlight **Done** and press **OK**.
3. Press the **Exit** button on the remote.

If the channel scan is canceled, the channels that were already discovered are retained. A new channel scan will clear all channels.

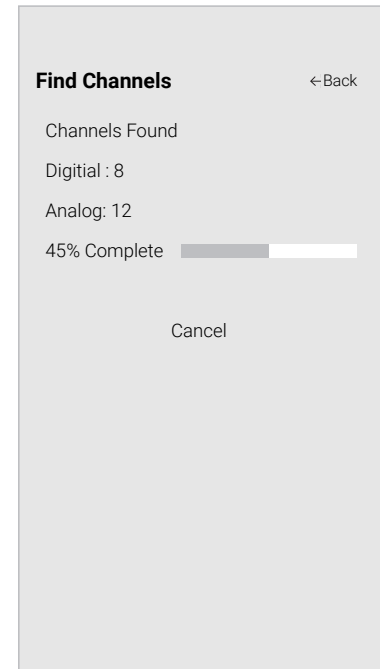

Skipping Channels

After a channel scan is completed, you may find that some channels are too weak to watch comfortably. There may also be some channels you do not want to view. You can remove these channels from the TV's memory with the Skip Channel feature.



Channels that have been removed with the Skip Channel feature can still be viewed if the channel is entered using the Number Pad. If you wish to completely block a channel from being viewed, use the parental controls. See *Locking and Unlocking Channels*.

To remove a channel:

1. From the CHANNELS menu, highlight **Skip Channel**, and press **OK**. The SKIP CHANNEL menu is displayed.
2. For each channel you wish to remove, use the **Up/Down Arrow** buttons on the remote to highlight the channel and press **OK**. A ✓ appears to the right of each channel you select.
3. When you have selected all of the channels you wish to remove, press the **Exit** button on the remote.

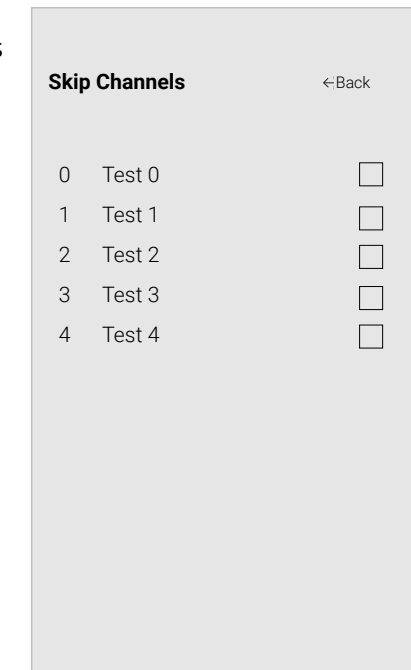

LISTENING TO ALTERNATE AUDIO

Changing the Analog Audio Language

Some analog over-the-air (free) and cable channels broadcast programs in more than one language. The TV's Analog Audio feature allows you to listen to audio in an alternate language using Secondary Audio Programming (SAP).



Not all programs are broadcast in SAP. The Analog Audio Language feature only works when the program being viewed is being broadcast with Secondary Audio Programming.

To use the Analog Audio feature:

1. From the Channels menu, highlight Analog Audio and press **OK**. The Analog Audio menu is displayed.
2. Select Stereo, SAP (secondary audio programming), or Mono. Press **OK**.
3. Press the **Exit** button on the remote.

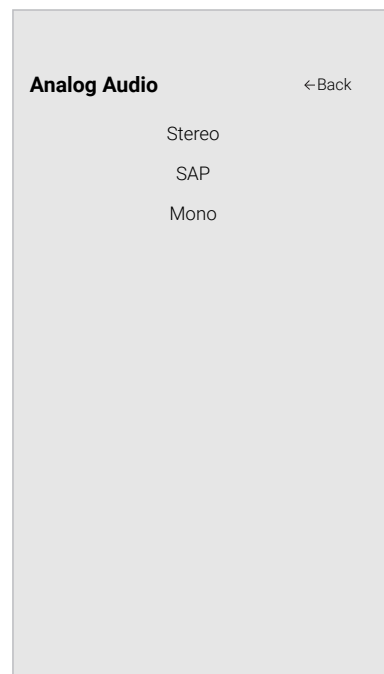

To use the Digital Language feature:

1. From the CHANNELS menu, highlight **Digital Audio** and press **OK**. The DIGITAL LANGUAGE menu is displayed.
2. Select your preferred language: **English, Spanish/Video Description, French**. Press **OK**.
3. Press the **Exit** button on the remote.

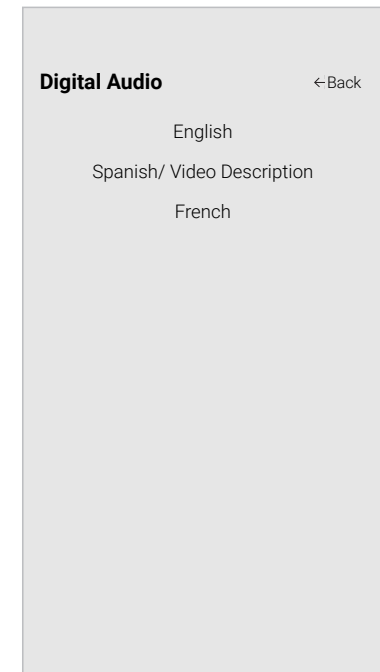

USING PARENTAL CONTROLS

The TV's parental controls allow you to prevent the TV from displaying certain channels or programs without a password.



Other devices have their own parental control settings.

The PARENTAL CONTROLS menu only appears when:

- You are using the tuner to receive your TV signals, such as when you are using an antenna for Over-the-Air signals or when connected to cable TV directly from the wall (no cable box).
- You have a device connected using a composite video cable or a coaxial cable, such as a VCR, satellite or cable box, or DVR.

Accessing the Parental Controls Menu

To access the PARENTAL CONTROLS menu:

1. Press the **Menu** button on the remote. The on-screen menu is displayed.
2. Use the **Arrow** buttons on the remote to highlight Channels and press **OK**. The CHANNELS menu is displayed.
3. Use the **Arrow** buttons on the remote to highlight **Parental Controls** and press **OK**.
4. Enter your set System PIN.



To set a custom PIN passcode, see *Setting a System Pin*.

Enabling or Disabling Program Ratings

To manage program content according to its rating, you must enable the Program Rating feature.



To enable or disable the Program Rating feature:

1. From the PARENTAL CONTROLS menu, highlight **Locks** and press **OK**. The LOCKS menu is displayed.
2. Select **On** or **Off** and press **OK**.

Locking and Unlocking Channels

When a channel is locked, it will be inaccessible. Locking a channel is a good way to prevent children from viewing inappropriate material.

To lock or unlock a channel:

1. From the PARENTAL CONTROLS menu, highlight **Channel Locks** and press **OK**. The CHANNEL LOCKS menu is displayed.
2. Highlight the channel you want to lock or unlock and press **OK**.
3. When a channel is *locked*, the **Lock** icon appears  **locked**. The channel is not accessible unless the parental PIN is entered.
4. When a channel is *unlocked*, the **Lock** icon appears  **unlocked**. The channel is accessible.

Blocking and Unblocking Content by Rating



A channel may sometimes broadcast programs that are meant for children, and at other times broadcast programs that are meant for mature audiences. You may not want to block the channel completely using a channel lock, but you may wish to block certain programs from being viewed.



For a list of content ratings and their definitions, visit www.tvguidelines.org.

When this is the case, you can use the TV's Rating Block feature to block content based on its rating.

To block or unblock content by its rating:

1. From the PARENTAL CONTROLS menu, highlight the content type you want to adjust and press **OK**:
 - **USA TV** - USA television program broadcasts.
 - **USA Movie** - USA movie broadcasts.
 - **Canadian English** - Canadian English television program broadcasts.
 - **Canadian French** - Canadian French television program broadcasts.
2. For each rating type you want to block or unblock, use the **Up/Down** and **Left/Right Arrow** buttons on the remote to highlight the rating type and press **OK**.
3. When the rating type is **blocked**, the **Lock** icon appears  **locked**. Content with this rating and all higher ratings cannot be viewed.
4. When the rating type is **unblocked**, the **Lock** icon appears  **unlocked**. Content with this rating and all lower ratings can be viewed.

If you want to block all unrated content, highlight **Block Unrated Shows** and use the **Arrow** buttons on the remote to select **On**.

5. When you are finished adjusting the rating level blocks, press the **Exit** button on the remote.

SETTING UP CLOSED CAPTIONING

Your TV can display closed captions for programs that include them. Closed captions display a transcription of a program's dialogue.



If the program you are viewing is not being broadcast with closed captions, the TV will not display the



The Closed Captions menu does not appear when an HDMI input is selected.

To activate or deactivate closed captions:

1. Press the **Menu** button on the remote. The on-screen menu is displayed.
2. Use the **Arrow** buttons on the remote to highlight **Closed Captions** and press **OK**. The **CLOSED CAPTION** menu is displayed.
3. Use the **Arrow** buttons on the remote to highlight **Closed Captions** and then use the **Left/Right Arrow** buttons to select **On** or **Off**.
4. Use the **Arrow** buttons on the remote to highlight either **Analog** or **Digital Closed Captions**.
5. Use the **Left/Right Arrow** buttons on the remote to select the caption channel you wish to display, then press **Exit**.

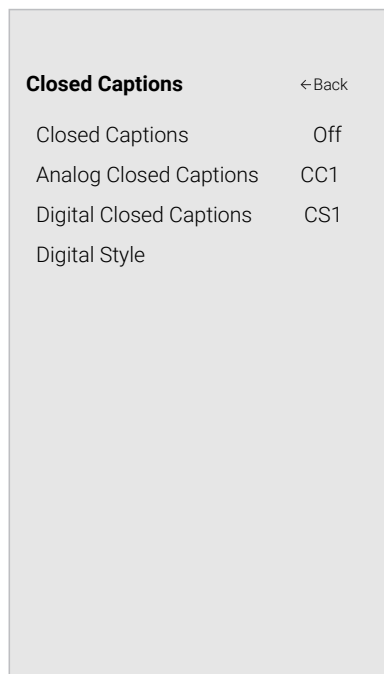

Changing the Appearance of Digital Closed Captions

Digital closed captions can be displayed according to your preference. See the diagram on the next page for an explanation of the parts of the closed caption area.

To change the appearance of digital closed captions:

1. From the **CLOSED CAPTION** menu, use the **Arrow** buttons to highlight **Digital Style** and press **OK**.
2. Use the **Left/Right Arrow** buttons on the remote to select **Custom**. The **DIGITAL STYLE** menu appears as shown.
3. Use the **Up/Down Arrow** buttons on the remote to highlight the setting you wish to change, then use the **Left/Right Arrow** buttons to change the setting:
 - **Caption Style** - Choose **As Broadcast** to keep default settings or **Custom** to manually change each setting.
 - **Text Style** - Change the font used for the closed captioning text.
 - **Text Size** - Make the text larger or smaller.
 - **Text Color** - Change the color of the text.
 - **Text Opacity** - Change the transparency of the text.
 - **Text Edges** - Change the effects at the edges of the text, such as raising the edges or adding drop shadows.
 - **Text Edges Color** - Change the color of the text edge effects.
 - **Background Color** - Change the color of the background directly behind the text.
 - **Background Opacity** - Change the transparency of the background directly behind the text.
 - **Window Color** - Change the color of the closed captioning box.
 - **Window Opacity** - Change the opacity of the closed captioning box.
4. When you are satisfied with the appearance of the closed captions, press the **Exit** button on the remote.



Typical choices include:

- Opaque background, transparent window—Only a strip of background appears behind the text, expanding as the text appears. This is the typical "As Broadcast" mode.
- Opaque background and window in the same color—When text appears, the entire line fills with color at once.

In the example, the closed caption text is green, the background is black, and the window is red.

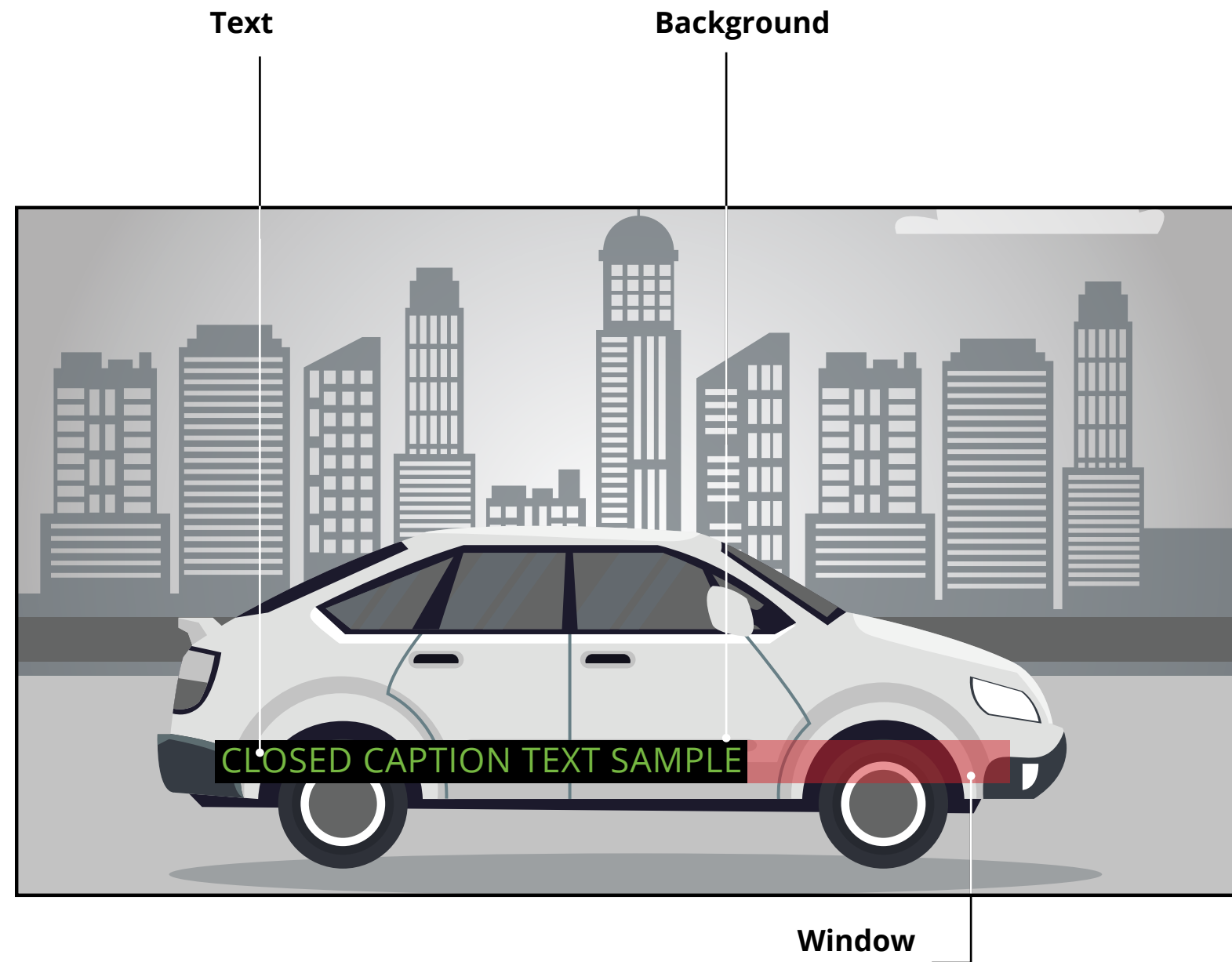

RENAMING DEVICES ON THE INPUT MENU

You can rename the inputs to make them easier to recognize on the Input menu. For example, if you have a DVD player connected to the Component input, you can rename that input to display "DVD Player." See *Changing the Input Source*.

To change the name of an input:

1. Press the **Menu** button on the remote. The on-screen menu is displayed.
2. Use the **Arrow** buttons on the remote to highlight Input Settings and press **OK**. The INPUT SETTINGS menu is displayed.
3. Highlight the input device that you want to rename and press **OK**.
 - To use a preset input name:
 - Highlight the **Name Input** row and press **OK**.
 - Highlight the input name and use the **Left/Right Arrow** buttons on the remote to cycle through preset input names
 - or—
 - To enter a custom name:
 - Highlight the **Name Input** row and press **OK**.
 - Enter your custom label using the on-screen keyboard.
 - Highlight and press **OK**.
 - The Input Name changes to show the custom name that you created.
4. When you have finished naming your input, press the **Exit** button on the remote.

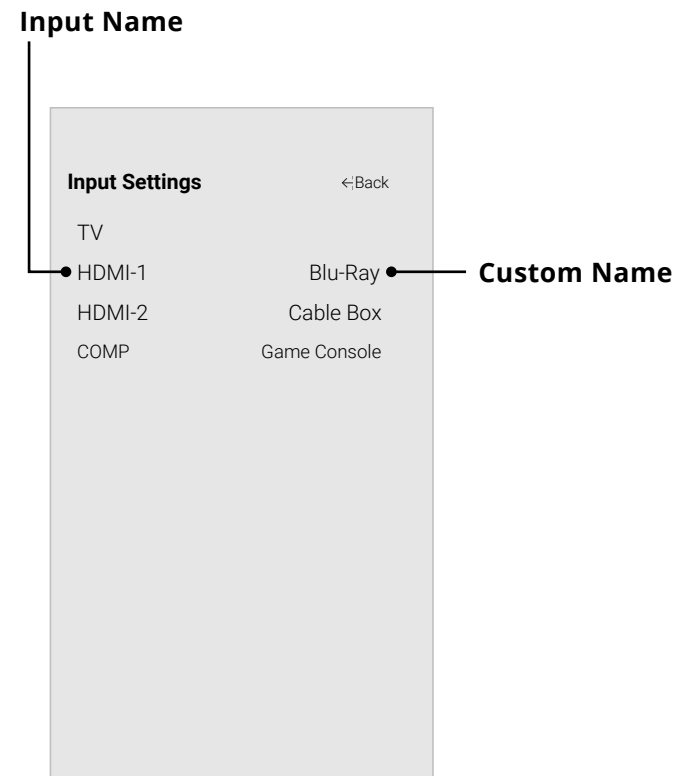

CHANGING THE TV SETTINGS

Using the SYSTEM menu, you can:

- View system information
- Change the on-screen menu language
- Set time zone and local settings
- Adjust the CEC settings
- Adjust to preserve Aspect Ratio or fill the screen
- Adjust accessibility settings
- Reset the TV settings & setup administrative controls

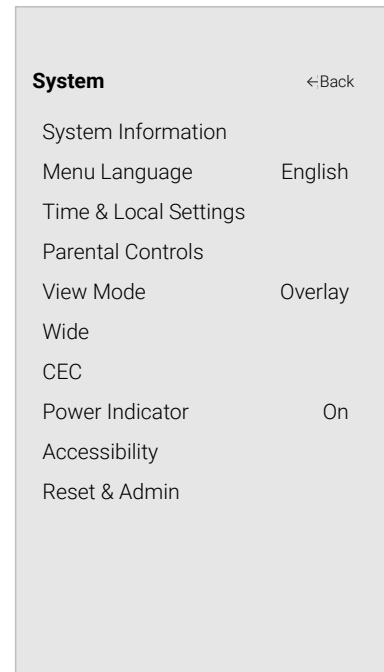

Viewing System Information

To view technical data and status information about your TV:

1. Press the **Menu** button on the remote. The on-screen menu is displayed.
2. Use the **Arrow** buttons on the remote to highlight **System** and press **OK**. The SYSTEM menu is displayed.
3. Highlight **System Information** and press **OK**.
4. Use the **Up/Down Arrow** buttons to scroll through the system information.
5. When you are finished reviewing the system information, press the **Exit** button on the remote.

Changing the On-Screen Menu Language

Your TV can display the on-screen menu in different languages.

To change the on-screen menu language:

1. Press the **Menu** button on the remote. The on-screen menu is displayed.
2. Use the **Arrow** buttons on the remote to highlight **System** and press **OK**. The SYSTEM menu is displayed.
3. Use the **Arrow** buttons on the remote to highlight **Menu Language** and press **OK**. The MENU LANGUAGE menu is displayed.
4. Highlight your preferred language (**English**, **Español**, or **Français**) and press **OK**.
5. Press the **Exit** button on the remote.



Setting the Time and Local Settings

To ensure the correct time is displayed when you press the **Info** button, set the TV's time zone:

1. Press the **Menu** button on the remote. The on-screen menu is displayed.
2. Use the **Arrow** buttons on the remote to highlight **System** and press **OK**. The SYSTEM menu is displayed.
3. Use the **Arrow** buttons on the remote to highlight **Time & Local Settings** and press **OK**. The menu headed by the local date and time is displayed.
4. Highlight **Time Zone** and press **OK**. The TIME ZONE menu is displayed.
5. Highlight your time zone and press **OK**.
6. Highlight **Daylight Saving Time** and press **OK**. The DAYLIGHT SAVING TIME menu is displayed. Choose **On** if it is currently Daylight Savings Time, **Off** if it is Standard Time, or **Auto** to have the system automatically detect Daylight Savings Settings.
7. Press the **Exit** button on the remote.

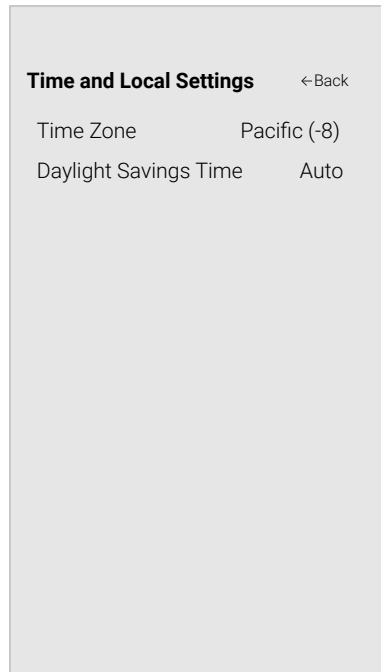

Adjusting the CEC Settings

The CEC function on your TV enables you to control devices connected to HDMI (ARC) input with the included remote, without any programming. Using CEC, your VIZIO TV remote can control:

- Power On/Off
- Volume
- Mute



Not all HDMI devices support CEC. See your device's user manual for details.

To enable, disable, or adjust CEC settings:

1. Set up your audio device and connect it to the HDMI-1(HDMI Arc) input on the TV
2. On your audio device, select the HDMI ARC input.
3. Press the **Menu** button on the remote. The on-screen menu is displayed.
4. Use the **Arrow** buttons on the remote to highlight **System** and press **OK**. The SYSTEM menu is displayed.
5. Use the **Arrow** buttons on the remote to highlight **CEC** and press **OK**. The CEC menu is displayed.
6. Highlight **CEC** and press **OK**. Select a setting and then press **OK**.
 - **CEC** - To use CEC, you must select Enable.
 - **Device Discovery** - To determine if your device is connected and supports CEC, select **Device Discovery** and then press **OK**.
7. Press the **Exit** button on the remote.

Accessibility settings

VIZIO is committed to providing intuitive, user-friendly products. Your new VIZIO TV offers several accessibility features that can help you get the most out of it.

To access the Accessibility menu:

1. Press the **Menu** button on the remote control.
2. Use the **Arrow** and **OK** buttons to navigate and select **System** → **Accessibility**.
3. Talk Back - Turn Text-to-Speech Talk Back **On** or **Off**. Text-to-Speech Talk Back enables your TV to speak all settings changes and adjustments using the remote in English.
4. Speech Rate* - Adjusts the rate in which Text-to-Speech is spoken. Select **Slow**, **Normal (Default)**, or **Fast**.
5. Zoom Mode - Enlarges a section of the screen by approximately 200%.

To access the Closed Caption menu:

- Press the **Menu** button on the remote control.
- Use the **Arrow** and **OK** buttons to navigate and select Closed Captions.

To access the Video Description menu:

- Press the **Menu** button on the remote control.
- Use the **Arrow** and **OK** buttons to navigate and select **Settings** → **Channel** → **Digital Audio** → **Spanish/ Video Description**.

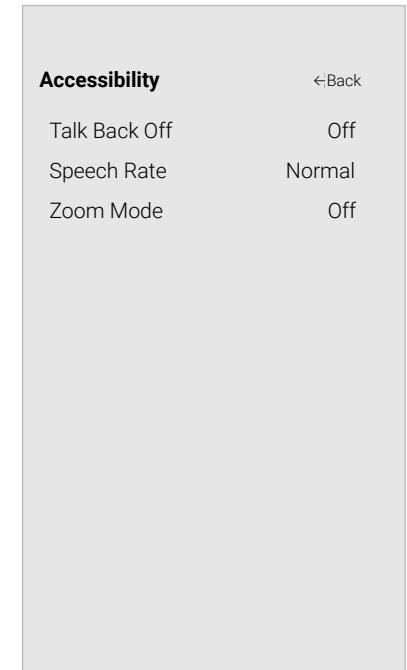

USING THE RESET & ADMIN MENU

You can use the TV's RESET & ADMIN menu to restore the TV to its factory default settings as well as access other system settings.

Using the RESET & ADMIN, you can:

- Reset the TV to factory settings
- Start or stop the Store Demo Mode

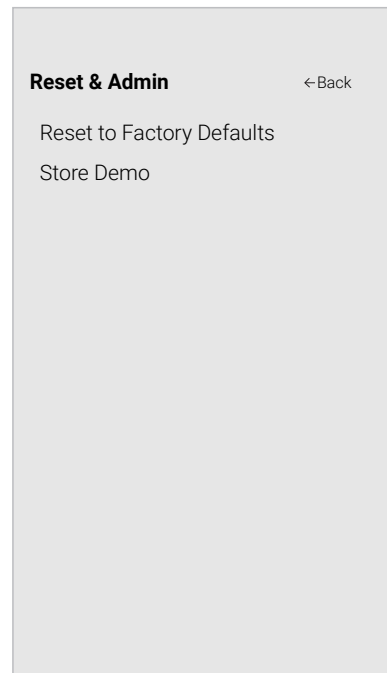

Restoring the TV to Factory Default Settings

All of the on-screen menu settings can be reset to the factory defaults.



If you restore the TV to the factory default settings, all changes you have made to the settings will be lost! This includes any wireless or picture settings

To restore the TV to its factory default settings:

1. Press the **Menu** button on the remote. The on-screen menu is displayed.
2. Use the **Arrow** buttons on the remote to highlight **System** and press **OK**. The SYSTEM menu is displayed.
3. Highlight **Reset & Admin** and press **OK**. The RESET & ADMIN menu is displayed.
4. Highlight **Reset to Factory Defaults** and press **OK**. If you have changed the set system PIN, enter it now.

The TV displays, "Select Reset to restore all TV settings to factory defaults and clear all account information."

5. Highlight **Reset** and press **OK**.
6. Wait for the TV to turn off. The TV will turn back on shortly afterward and the setup process will begin.

Setting a System PIN

You can set a System Pin to lock content and picture modes as well as prevent accidental system resets. The first time you select System PIN code, you will need to create a PIN. To create a PIN.

1. Press the **Menu** button on the remote. The on-screen menu is displayed.
2. Use the **Arrow** buttons on the remote to highlight **System** and press **OK**. The SYSTEM menu is displayed.
3. Highlight **Reset & Admin** and press **OK**. The RESET & ADMIN menu is displayed.
4. Highlight **System PIN Code** and press **OK**.
5. Enter and confirm your new PIN.
6. Highlight and select **Save** to confirm.

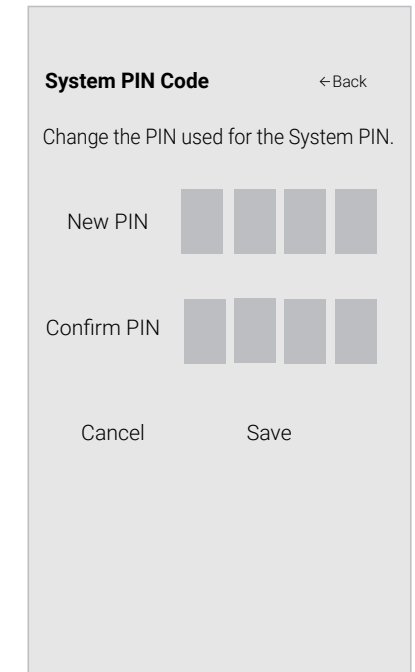

You will need to enter your current PIN code the next time you access this menu or if you'd like to change your PIN.

USING THE INFO WINDOW

The Info Window can be displayed by pressing the **Info** button on the remote:

- Press the **Info** button one time to display the current input, time and picture mode

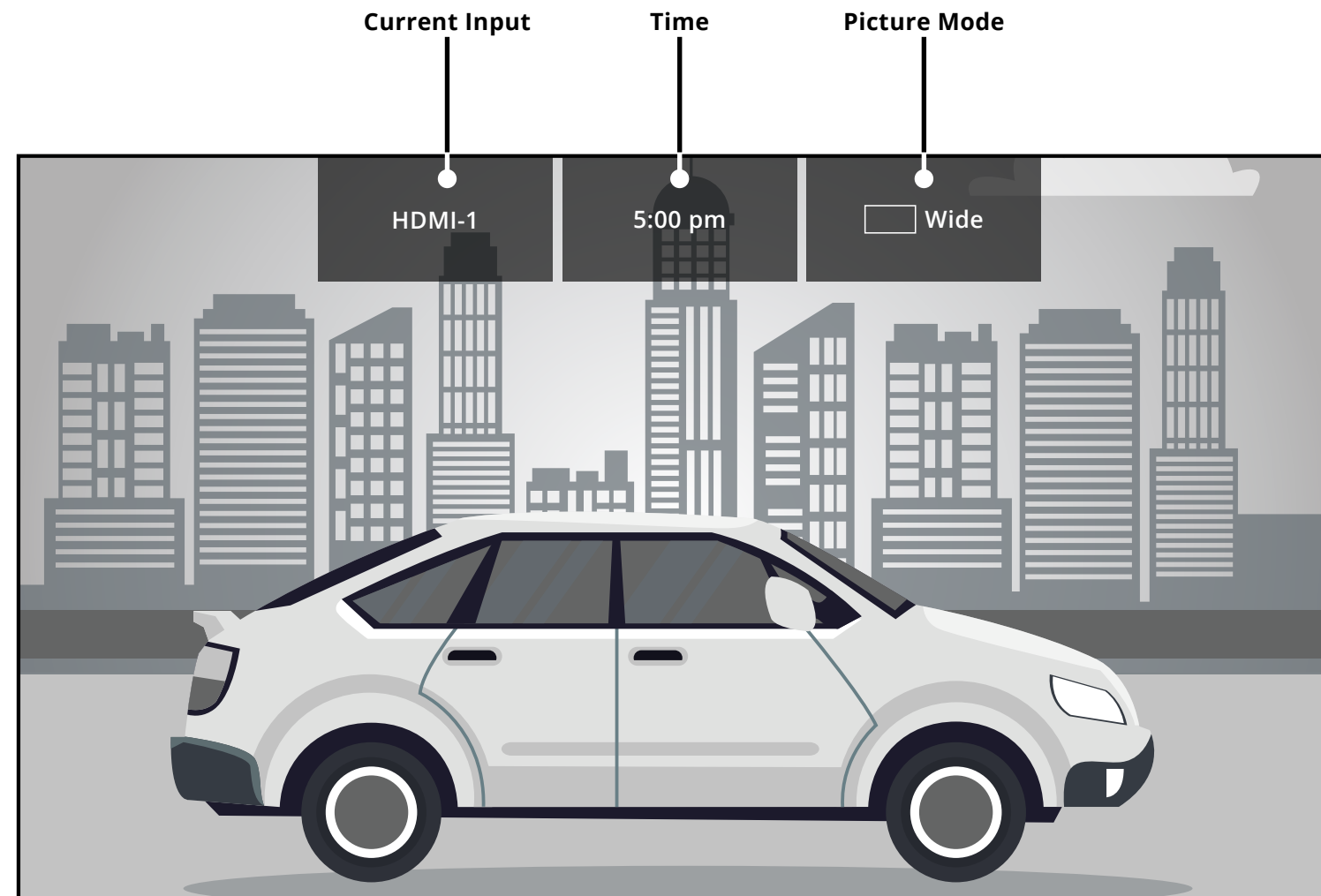

The USB Media Player allows you to connect a USB thumb drive to your TV and play photos.

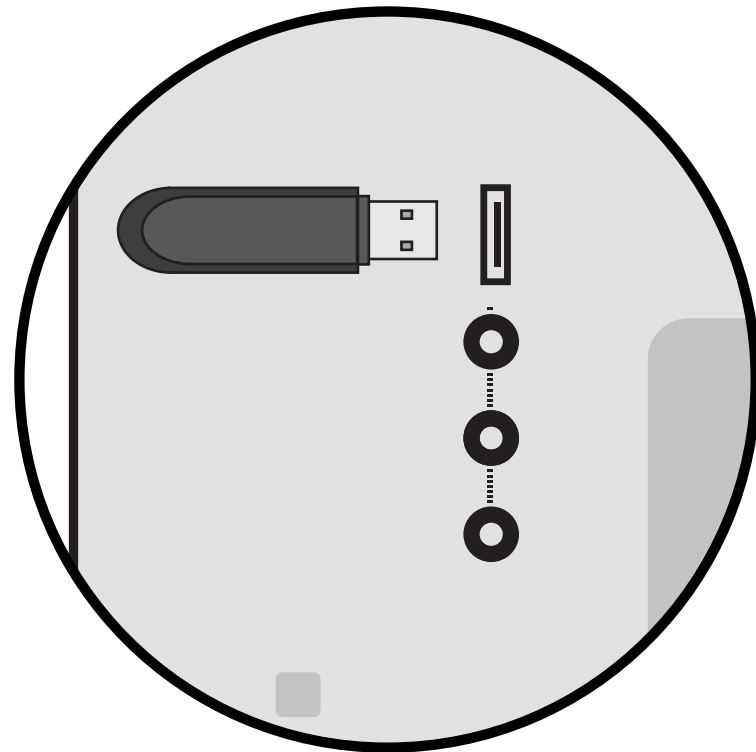

Note: The image shown here is for illustrative purposes only and may be subject to change. The actual number of ports and their locations may vary, depending on the model.

Displaying USB Media

To display your USB media:

1. Connect your USB thumb drive to the USB port on the side of the TV.
2. The TV will recognize the USB stick. Use the **Arrow Keys** on the remote to select the content you'd like to play.



You can display your photos in Fullscreen. Select the photo, press **OK**, then highlight **Fullscreen** and press OK

Removing the USB Drive from the TV

To safely remove your USB drive from the TV:

3. Turn off the TV.
4. Disconnect your USB thumb drive from the USB port on the side of TV



Do not remove the USB thumb drive while the TV is on. Doing so may damage the drive

Do You Have Questions? Find Answers At

SUPPORT.VIZIO.COM

Find help with:

- New Product Setup
- Connecting Your Devices
- Technical Problems
- Product Updates
- And More



**Live Chat
Support Available**

**You can also contact our
award-winning support team at:**

Phone: (877) 698-4946 (TOLL-FREE)



Take A Moment To Register Your Product At

VIZIO.COM/PRODUCT-REGISTRATION

Why Register?



Customized Support

Get assistance quickly with your information on-hand.



News & Offers

Take advantage of the latest news and special offers from VIZIO.



Safety & Satisfaction

Stay up to date with important product updates and notifications.

REGISTER YOUR VIZIO PRODUCT NOW

HELP TOPICS

The remote is not responding.

- Make sure the batteries are properly inserted matching the - and + symbols.
- Replace the batteries with fresh ones.

The TV displays “No Signal.”

- Press INPUT button on the remote control to select a different input source.
- If you are using cable TV or antenna connected directly to the TV, scan for channels. See *Scanning for Channels*.

There is no power.

- Ensure the TV is plugged into a working electrical outlet.
- Ensure the power cable is securely attached to the TV.
- Press the **Power/Standby** button on the remote or on the back of the TV to turn the TV on.

The power is on, but there is no image on the screen.

- Ensure all cables are securely attached to the TV.
- Ensure all devices are connected correctly. Devices differ; see your device’s user manual for details.
- Adjust Brightness, Contrast, or Backlight. See *Adjusting the Picture Settings*.
- Press the **INPUT** button on the remote to select a different input source.

The sound is flat or dialog is not audible.

- Turn off Volume Leveling. See *Adjusting the Audio Settings*.

Where do I find information on the accessibility features of this product and other VIZIO products?

- Please visit <https://www.vizio.com/accessibility>, Email us at: Accessibility@vizio.com, or give us a call at 1-877-698-4746.

There is no sound.

- Press Volume Up on the remote control.
- Press the **MUTE** button on the remote to ensure mute is off.
- Check the audio settings. See *Adjusting the Audio Settings*.
- Check the audio connections of external devices (Blu-ray player, game console, cable/satellite box) that are connected to the TV.
- If you are using an antenna, the signal strength of the channel may be low. Ensure your antenna is connected securely to the TV and move the antenna around the room or close to a window for the best signal.

The colors on the TV don’t look right.

- Adjust the Color and Tint settings in the Picture menu. See *Adjusting the Picture Settings*.
- Select a pre-set picture mode. See *Adjusting the Picture Settings*. VIZIO recommends selecting Calibrated.
- Check all cables to ensure they are securely attached.

The image quality is not good.

- For the best image quality, view high-definition programs using digital sources. Connect your devices with HDMI cables.
- If you are using an antenna, the signal strength of the channel may be low. Ensure your antenna is connected securely to the TV and move the antenna around the room or close to a window for the best signal.

The picture is distorted.

- Move the TV away from electrical appliances, cars, and fluorescent lights.
- Ensure all cables are securely attached.

The buttons on the remote aren’t working.

- Ensure you are only pressing one button at a time.
- Point the remote directly at the TV when pressing a button.
- Replace the remote batteries with new ones. See *Replacing the Batteries*.

The TV image does not cover the entire screen.

- If you are using TV, AV, or Component with 480i input, press the button  on the remote to change the screen mode.

The TV has pixels (dots) that are always dark.

- Your HD TV is precision-manufactured using an extremely high level of technology. However, sometimes pixels may not display correctly. These types of occurrences are inherent to this type of product and do not constitute a defective product.

I see “noise” or static on the screen.

- When your TV’s digital capabilities exceed a digital broadcast signal, the signal is up-converted (improved) to match your TV’s display capabilities. This up-converting can sometimes cause irregularities in the image.
- If you are using an antenna, the signal strength of the channel may be low. Ensure your antenna is connected securely to the TV and move the antenna around the room or close to a window for the best signal.

When I change input source, the TV image changes size.

- The TV remembers the viewing mode on each input source. If the viewing mode on the new input source differs from the one on the input source you switch from, the difference may be noticeable.
- See *Changing the Screen Aspect Ratio*.

D24hn-G9	
Size	24"
Viewable Area	23.5"
MOUNTING	
Dimensions w/ Stand	21.83" x 14.78" x 6.18" (554.5 x 375.5 x 157.0mm)
Dimensions w/o Stand	21.83" x 13.15" x 2.06" (554.5 x 334.1 x 52.4mm)
Weight w/ Stand	6.17 lbs (2.80 kg)
Weight w/o Stand	5.95 lbs (2.70 kg)
Mounting Screw Size	M4
Hole Pattern	100 mm x 100 mm
DISPLAY	
Maximum Resolution	720p
LCD Backlight	Edgelit LED
Refresh Rate	60 Hz
INPUTS / OUTPUTS	
HDMI Inputs	2
Component Video Inputs	1
Ethernet Input	0
RF Antenna Input	1
USB	1
Audio Output	HDMI ARC, Digital Optical
OTHER	
Remote Control Model	XRT134
Power Consumption	N/A
Standby Power	<0.5W
Voltage	120V
OSD Language	English, French, Spanish
Certification	UL, cUL, FCC Class B, BETS-7/ ICES-003 Class B, HDMI (CEC, ARC) Dolby Audio

FCC Class B Radio Interference Statement

NOTE: This equipment has been tested and found to comply with the limits for a Class B digital device, pursuant to Part 15 of the FCC Rules. These limits are designed to provide reasonable protection against harmful interference in a residential installation. This equipment generates, uses and can radiate radio frequency energy, and if not installed and used in accordance with the instructions, may cause harmful interference to radio communications. However, there is no guarantee that interference will not occur in a particular installation. If this equipment does cause harmful interference to radio or television reception, which can be determined by turning the equipment off and on, the user is encouraged to try to correct the interference by one or more of the following measures:

Reorient or relocate the receiving antenna.

Increase the separation between the equipment and receiver.

Connect the equipment into an outlet on a circuit different from that to which the receiver is connected.

Consult the dealer or an experienced radio/TV technician for help.

This device complies with Part 15 of the FCC Rules. Operation is subject to the following two conditions: (1) this device may not cause harmful interference, and (2) this device must accept any interference received, including interference that may cause undesired operation.

Notice

The changes or modifications not expressly approved by the party responsible for compliance could void the user's authority to operate the equipment.

Shielded interface cables and AC power cord, if any, must be used in order to comply with the emission limits.

The manufacturer is not responsible for any radio or TV interference caused by unauthorized modification to this equipment. It is the responsibilities of the user to correct such interference.

FCC Warning

Changes or modifications not expressly approved by the party responsible for compliance with the FCC Rules could void the user's authority to operate this equipment.

Caution

Always use a power outlet that is properly grounded.

Canada Notice for License-Exempt Radio Apparatus

This device complies with Industry Canada's license-exempt RSSs. Operation is subject to the following two conditions: (1) This device may not cause harmful interference, and (2) this device must accept any interference received, including interference that may cause undesired operation.

This device operates on a no-protection no-interference basis. Should the user seek to obtain protection from other radio services operating in the same TV bands, a radio license is required. Please consult Industry Canada's document CPC-2-1-28, Optional Licensing for Low-Power Radio Apparatus in the TV Bands, for details.

Cet appareil est conforme aux CNR exempts de licence d'Industrie Canada. Son fonctionnement est sujet aux deux conditions suivantes:

1. le dispositif ne doit pas produire de brouillage préjudiciable, et
2. ce dispositif doit accepter tout brouillage reçu, y compris un brouillage susceptible de provoquer un fonctionnement indésirable

Cet appareil fonctionne sur une base sans protection et sans interférence. Dans le cas où l'utilisateur cherche à obtenir de la protection des autres services de radio fonctionnant sur les mêmes bandes TV, aucune licence est requise. Veuillez consulter le document

CPC-2-1-28 d'Industrie Canada, License optionnelle pour les appareils radio de faible puissance, pour plus de détails.

Industry Canada Class B emission compliance statement

This Class B digital apparatus complies with Canadian ICES-003. Cet appareil numérique de la classe B est conforme à la norme NMB-003 du Canada.

UNITED STATES AND CANADA

BY USING YOUR VIZIO PRODUCT YOU AGREE TO BE BOUND BY ALL THE TERMS OF THIS WARRANTY. BEFORE USING YOUR VIZIO PRODUCT, PLEASE READ THIS WARRANTY CAREFULLY. IF YOU DO NOT AGREE TO THE TERMS OF THIS WARRANTY, DO NOT USE THE VIZIO PRODUCT AND, WITHIN THIRTY (30) DAYS OF THE DATE OF PURCHASE, RETURN IT FOR A REFUND TO THE AUTHORIZED RETAILER WHERE YOU PURCHASED IT.

This warranty contains a binding arbitration agreement and a class action waiver for United States residents. If you live in the United States, the binding arbitration agreement and class action waiver affect your rights under this warranty. Please read the text under the section titled "Binding Arbitration Agreement; Class Action Waiver (U.S. Residents Only)" carefully.

How Long This Warranty Lasts

For non-commercial use, VIZIO warrants the product on the terms set forth below for one (1) year from the date of original purchase. For commercial use, VIZIO warrants this product on the terms set forth below for ninety (90) days from the date of original purchase.

What This Warranty Covers

VIZIO warrants the product against defects in materials and workmanship when the product is used normally in accordance with VIZIO's user guides and manuals.

Except where restricted by law, this warranty applies only to the original purchaser of a new product. The purchase must have been made from an authorized retailer in the United States (including Puerto Rico) or Canada. The product must also be located in the country where it was purchased at the time of warranty service.

Zero Bright Pixel Defect Guarantee (Displays Only)

Your product may qualify for a warranty against "zero bright pixel" defects for the duration of the warranty on select new product purchases. To determine if this guarantee applies to your product, refer to the model's product information page at www.vizio.com, look for the "zero bright pixel" guarantee on the box, or contact VIZIO Technical Support at the email address or telephone number below.

How to Get Service

Before obtaining warranty service, you may visit www.vizio.com for additional help and troubleshooting. To obtain warranty service, contact VIZIO Technical Support via email at TechSupport@VIZIO.com or via phone at 877 MY VIZIO (877-698-4946).

Your Obligations Before Service

You must obtain pre-authorization before sending your product to a

VIZIO service center. You may be required to supply a purchase receipt (or copy) to show that the product is within the warranty period. When you return a product to a VIZIO service center, you must ship the product in its original packaging or in packaging that affords an equal degree of protection. VIZIO Technical Support will provide instructions for packing and shipping the product to the VIZIO service center. ALL USER DATA AND DOWNLOADED APPLICATIONS STORED ON A PRODUCT WILL BE DELETED IN THE COURSE OF SOME IN-HOME AND ALL SHIP-IN WARRANTY SERVICE. If this occurs, your product will be restored to its original state. You will be responsible for restoring all applicable user data and downloaded applications. Recovery and reinstallation of user data and downloaded applications is not covered under this warranty. In order to protect your personal information, VIZIO recommends that you always clear all personal information from the product before it is serviced, regardless of the servicer.

VIZIO's Responsibilities

If VIZIO determines that a product is covered by this warranty, VIZIO will (at its option) repair or replace it, or refund the purchase price to you. There will be no charge for parts or labor during the warranty period. Replacement parts may be new or recertified at VIZIO's option and sole discretion. Replacement parts and VIZIO's labor are warranted for the remaining portion of the original warranty or for ninety (90) days from warranty service, whichever is longer.

Types of Service

TVs that are 32 inches or larger will usually be serviced in-home. In-home service requires complete and easy access to the product and does not include de-installation or re-installation of the product. In-home service is subject to availability. VIZIO will provide other service options when in-home service is not available. All other VIZIO products must be sent to a VIZIO service center to obtain warranty service. VIZIO is not responsible for transportation costs to the service center, but VIZIO will cover return shipping to the customer.

What This Warranty Does Not Cover

This warranty does not cover: (a) cosmetic damage; (b) normal wear and tear; (c) improper operation; (d) improper voltage supply or power surges; (e) signal issues; (f) damage from shipping; (g) acts of God; (h) customer misuse, modifications or adjustments; (i) installation, set-up, or repairs attempted by anyone other than by a VIZIO authorized service center; (j) products with unreadable or removed serial numbers; (k) products requiring routine maintenance; or (l) products sold "AS IS", "CLEARANCE", "FACTORY RECERTIFIED", or by a non-authorized reseller.

What to Do If You Are Not Satisfied With Service

If you feel VIZIO has not met its obligations under this warranty, you may attempt to resolve the issue informally with VIZIO. If you are unable to resolve the issue informally and wish to file a formal claim against VIZIO, and if you are a resident of the United States, you must submit your claim to binding arbitration according to the procedures described below, unless an exception applies. Submitting a claim to binding arbitration means that you do not have the right to have your claim heard by a judge or jury. Instead your claim will be heard by a neutral arbitrator.

Binding Arbitration Agreement; Class Action Waiver (U.S. Residents Only)

UNLESS YOU HAVE BROUGHT AN ELIGIBLE CLAIM IN SMALL CLAIMS COURT OR HAVE OPTED OUT AS DESCRIBED BELOW, ANY CONTROVERSY OR CLAIM RELATING IN ANY WAY TO YOUR VIZIO PRODUCT, INCLUDING ANY CONTROVERSY OR CLAIM ARISING OUT OF OR RELATING TO THIS WARRANTY, A BREACH OF THIS WARRANTY, OR THE VIZIO PRODUCT'S SALE, CONDITION OR PERFORMANCE, WILL BE SETTLED BY BINDING ARBITRATION ADMINISTERED BY THE AMERICAN ARBITRATION ASSOCIATION AND CONDUCTED BY A SINGLE ARBITRATOR APPOINTED BY THE AMERICAN ARBITRATION ASSOCIATION, IN ACCORDANCE WITH ITS COMMERCIAL ARBITRATION RULES AND ITS SUPPLEMENTARY PROCEDURES FOR CONSUMER-RELATED DISPUTES. You may learn more about the American Arbitration Association and its rules for arbitration by visiting www.adr.org or by calling 800-778-7879. Since this warranty concerns a transaction in interstate or international commerce, the Federal Arbitration Act will apply.

The filing fees to begin and carry out arbitration will be shared between you and VIZIO, but in no event will your fees ever exceed the amount allowable by the American Arbitration Association, at which point VIZIO will cover all additional administrative fees and expenses. VIZIO waives its right to recover attorneys' fees in connection with any arbitration under this warranty. If you are the prevailing party in an arbitration to which the Supplementary Procedures for Consumer-Related Disputes applies, then you are entitled to recover attorneys' fees as the arbitrator may determine.

The dispute will be governed by the laws of the state or territory in which you resided at the time of your purchase (if in the United States). The place of arbitration will be Irvine, California, or your county of residence (if in the United States). The arbitrator will have no authority to award punitive or other damages not measured by the prevailing party's actual damages, except as may be required by statute. The arbitrator will not award consequential damages, and any award will be limited to monetary damages and will include no equitable relief, injunction,

or direction to any party other than the direction to pay a monetary amount. Judgment on the award rendered by the arbitrator will be binding and final, except for any right of appeal provided by the Federal Arbitration Act, and may be entered in any court having jurisdiction. Except as may be required by law, neither you nor VIZIO nor an arbitrator may disclose the existence, content, or results of any arbitration under this warranty without the prior written consent of you and VIZIO. ANY DISPUTE, WHETHER IN ARBITRATION, IN COURT, OR OTHERWISE, WILL BE CONDUCTED SOLELY ON AN INDIVIDUAL BASIS. VIZIO AND YOU AGREE THAT NO PARTY WILL HAVE THE RIGHT OR AUTHORITY FOR ANY DISPUTE TO BE ARBITRATED AS A CLASS ACTION, A PRIVATE ATTORNEY GENERAL ACTION, OR IN ANY OTHER PROCEEDING IN WHICH EITHER PARTY ACTS OR PROPOSES TO ACT IN A REPRESENTATIVE CAPACITY. NO ARBITRATION OR PROCEEDING WILL BE JOINED, CONSOLIDATED, OR COMBINED WITH ANOTHER ARBITRATION OR PROCEEDING WITHOUT THE PRIOR WRITTEN CONSENT OF ALL PARTIES TO ANY SUCH ARBITRATION OR PROCEEDING.

Exceptions to Binding Arbitration Agreement and Class Action Waiver IF YOU DO NOT WISH TO BE BOUND BY THE BINDING ARBITRATION AGREEMENT AND CLASS ACTION WAIVER, THEN: (1) you must notify VIZIO in writing within sixty (60) days of the date that you purchased the product; (2) your written notification must be mailed to VIZIO at 39 Tesla, Irvine, CA 92618, Attn: Legal Department; and (3) your written notification must include (a) your name, (b) your address, (c) the date you purchased the product, and (d) a clear statement that you wish to opt out of the binding arbitration agreement and class action waiver.

In addition, you may pursue a claim in small claims court in your county of residence (if in the United States) or in Orange County, California. In such case the provisions of the section titled "Binding Arbitration Agreement; Class Action Waiver (U.S. Residents)" will not apply.

Exclusions and Limitations

TO THE GREATEST EXTENT PERMITTED BY APPLICABLE LAW, THERE ARE NO EXPRESS WARRANTIES OTHER THAN THOSE DESCRIBED ABOVE. ANY IMPLIED WARRANTIES, INCLUDING ANY IMPLIED WARRANTY OF MERCHANTABILITY AND FITNESS FOR A PARTICULAR PURPOSE, WILL BE LIMITED IN DURATION TO THE WARRANTY PERIOD SET FORTH ABOVE. SOME STATES AND PROVINCES DO NOT ALLOW LIMITATIONS ON HOW LONG AN IMPLIED WARRANTY LASTS, SO THE ABOVE LIMITATION MAY NOT APPLY TO YOU.

VIZIO WILL NOT BE RESPONSIBLE FOR LOSS OF USE, LOSS OF INFORMATION OR DATA, COMMERCIAL LOSS, LOST REVENUE OR LOST PROFITS, OR OTHER INDIRECT, SPECIAL, INCIDENTAL OR CONSEQUENTIAL DAMAGES, EVEN IF VIZIO HAS BEEN ADVISED OF THE POSSIBILITY OF SUCH DAMAGES, AND EVEN IF THE REMEDY FAILS OF ITS

ESSENTIAL PURPOSE. SOME STATES AND PROVINCES DO NOT ALLOW THE EXCLUSION OR LIMITATION OF INCIDENTAL OR CONSEQUENTIAL DAMAGES, SO THE ABOVE LIMITATION OR EXCLUSION MAY NOT APPLY TO YOU.

IN LIEU OF ANY OTHER REMEDY FOR ANY AND ALL LOSSES AND DAMAGES RESULTING FROM ANY CAUSE WHATSOEVER (INCLUDING VIZIO'S NEGLIGENCE, ALLEGED DAMAGE, OR DEFECTIVE GOODS, NO MATTER WHETHER SUCH DEFECTS ARE DISCOVERABLE OR LATENT), VIZIO MAY, AT ITS SOLE AND EXCLUSIVE OPTION AND IN ITS DISCRETION, REPAIR OR REPLACE YOUR PRODUCT, OR REFUND ITS PURCHASE PRICE. AS NOTED, SOME STATES AND PROVINCES DO NOT ALLOW THE EXCLUSION OR LIMITATION OF INCIDENTAL OR CONSEQUENTIAL DAMAGES, SO THE ABOVE LIMITATION OR EXCLUSION MAY NOT APPLY TO YOU.

How the Law Applies

This warranty gives you specific legal rights, and you may also have other rights, which vary from state to state and province to province. This warranty applies to the greatest extent permitted by applicable law.

General

No employee or agent of VIZIO may modify this warranty. If any term of this warranty, other than the class action waiver, is found to be unenforceable, that term will be severed from this warranty and all other terms will remain in effect. If the class action waiver is found to be unenforceable, then the entire section titled "Binding Arbitration Agreement; Class Action Waiver (U.S. Residents Only)" will not apply. This warranty applies to the maximum extent not prohibited by law.

Changes to Warranty

This warranty may change without notice, but any change will not affect your original warranty. Check www.vizio.com for the most current version.

Software Licenses

All software is provided subject to a software license agreement(s) and you agree that you will be bound by such license agreement(s) in addition to these terms. Your use of this product is subject to VIZIO's privacy policy, which may be updated from time to time, and is available to view at <http://www.vizio.com/privacy>,

Export Regulations

Customer acknowledges that the VIZIO products, which include technology and software, are subject to customs and export control laws in the United States ("US"). The products may also be subject to the customs and export control laws and regulations of the country in which the products are manufactured and/or received.

Internet Connectivity

Network conditions, environmental and other factors may negatively affect connectivity and the resulting video quality, if any. The applications and content of the applications pictured herein or described in accompanying documentation may only be available in certain countries or languages, may require additional fees or subscription charges, and may be subject to future updates, modifications or discontinuation without notice. VIZIO has no control over third party applications or content and assumes no responsibility for the availability or interruption of such applications or content. Additional third party terms, conditions and restrictions apply.

Information in this User Manual is subject to change without notice. To review the most updated version of this User Manual and the associated Quick Start Guide, go to <http://www.vizio.com>.

© 2018 VIZIO, Inc. All Right Reserved.

This User Manual may not be copied in whole or in part without the written permission of VIZIO, Inc. VIZIO, Inc. has made reasonable efforts to ensure the accuracy of the information provided herein. All product specifications, functionality, features, configurations, performance, design and other product information described herein are subject to change without notice. VIZIO, Inc. is not responsible for typographical, technical, or descriptive errors.

VIZIO, the VIZIO logo, the V logo, and other terms and phrases are trademarks or registered trademarks of VIZIO, Inc.

The terms HDMI, HDMI High-Definition Multimedia Interface, and the HDMI Logo are trademarks or registered trademarks of HDMI Licensing Administrator, Inc.

For DTS patents, see <http://patents.dts.com>. Manufactured under license from DTS, Inc. DTS, the Symbol, DTS and the Symbol together, and DTS Studio Sound II are registered trademarks and/or trademarks of DTS, Inc. in the United States and/or other countries. © DTS, Inc. All Rights Reserved.

Dolby, Dolby Audio, and the double-D symbol are trademarks of Dolby Laboratories. Manufactured under license from Dolby Laboratories. Confidential unpublished work. Copyright © 2013-2015 Dolby Laboratories. All rights reserved.

© 2018 Google Inc. All rights reserved. Google Cast is a trademark of Google Inc.

Other names of companies, products, and services used in this User Manual may be trademarks, trade names or service marks of others and VIZIO, Inc. disclaims any interest in trademarks, trade names or service marks other than its own. Mention of non-VIZIO products is for informational purposes only.

Battery Disposal



Caution: This product may be shipped with batteries. Do not dispose of batteries in a fire or with ordinary household waste. Batteries may explode and can cause damage. Replace batteries only with the same or equivalent type of battery recommended by VIZIO. The disposal of batteries may be regulated by your state. For more information on recycling or properly disposing of your batteries, please check with your state or go to www.vizio.com/environment.

Product Recycling

The disposal and recycling of consumer electronic products may be regulated by your state. Always properly dispose of your VIZIO products in accordance with local laws and regulations. VIZIO supports the proper recycling of our products. For information on how to properly recycle your VIZIO products and to learn more about consumer electronics recycling laws, please go to www.vizio.com/environment or call (800) 374-3473.



Packaging Disposal

VIZIO encourages the recycling of the packaging used for this product. Please break-down all boxes and recycle eligible materials according to local laws and regulations. For more information please go to www.vizio.com/environment or call (800) 374-3473.

Accessibility

For information on the accessibility features of this product and other VIZIO products please visit: <https://www.vizio.com/accessibility>
Email: Accessibility@vizio.com
Phone: 1-877-698-4746

