



User Manual

Summary

For your safety	4
Guidelines	4
Mobile phone profile	4
Profile	4
Front.....	5
Rear / Lateral.....	6
Get started	6
SIM Card Installation.....	6
SIM cards installation diagram.....	7
Memory Card Installation	7
Memory card installation diagram.....	8
Battery Installation.....	8
Battery installation diagram	9
Battery Charging	9
Connections Diagram.....	9
Notices on using the battery.....	10
PIN Code.....	10
General Instructions.....	10
OK Key and Navigation Keys	10
Send Keys	11
End Key and Back Key	11
Standard Keyboard	11
FM Radio Keys.....	11
Keyboard Lock.....	11
Standby mode	12
Icons list meaning	12
Language and Input Mode	13
Call Hint.....	13
Services	14
Callers' group	14
Basic Operations	14
Switch On	14
Switch Off.....	14
How to Dial a Call	15

Adjust Receiver Volume	15
Answer a Call.....	15
DTMF tones.....	15
Dial Hold.....	15
Fast SMS Reading	16
Missed Calls.....	16
Answering Machine	16
Use of Menu functions.....	16
Phonebook	16
Call Center.....	17
Multimedia.....	19
Bluetooth	24
Messaging	25
Services	27
Chat	28
Audio Player	28
File manager.....	29
Fun & Games.....	30
Organizer	31
Settings.....	33
Coffer function	36
Text input	37
USB connection.....	38
Maintenance & Safety	38
Charger and adapter	38
Battery Information and Care	38
General Notice	38
Troubleshooting.....	39
Abbreviations.....	39
Certifications	41

For your safety

Guidelines

For your safety

For your safety and proper use of the telephone, please observe the following guidelines:

- Do not switch the phone in proximity to chemical plants, gas stations or other areas at risk of explosion.
- When driving, use only the headset, do not forget to always park your car at the roadside before starting a conversation with the apparatus.
- Since the use of mobile phones can cause interference on aircraft, not use any phone on an airplane. Such a wireless phone use is dangerous and illegal, always switch off your phone before boarding.
- Pay special attention to the use of the phone near cardiac pacemakers, hearing aids and other medical equipment, because the phone can be source of interference.
- The use of non genuine parts and accessories will void the warranty.
- Do not disassemble the phone without permission. In case of failure, please contact the supplier as soon as possible.
- Do not connect the charger to the phone when there is no battery connected. Turn off your phone before removing the battery, otherwise, the phone's memory may be damaged.
- When the phone is connected to the charger, always make sure that the room there is good ventilation or a heat sink, and the unit is away from flammable items or explosives.
- To avoid the risk of demagnetization, keep the phone away from magnetic objects such as CDs, credit cards, etc.
- Make sure the phone does not come into contact with any type of liquid in the case of such cases, remove the battery and contact your supplier immediately.
- Do not use the phone in situations with ambient temperature is too high or too low, do not expose the unit to strong direct sunlight or humid environments. The operating temperature for the correct phone and its accessories is between 0 ° and 40 °. The altitude when using the telephone should not exceed 2,000 meters.
- Do not use liquid or soft cloth moistened with detergent to clean the phone energetic.
- The phone has features of sound recording, video and photographs, which must be used according to the laws and regulations.
- Keep the phone away from children. Do not throw or shake the phone, because the internal circuits and structures accurately could be damaged.
- Do not dispose of batteries with household waste.

Note: *The manufacturer assumes no responsibility for any failure of the policy set forth above or for any unauthorized use of your phone. The manufacturer reserves the right to alter without notice the information contained in this guide. **The contents of this manual may differ from actual content displayed in the phone. In this case, the latter shall prevail.***

Mobile phone profile

Profile

Phone profile

The phone comes equipped with a screen, a vibrating motor, and a USB multifunction connector (data/charging). The next pages show front and rear / lateral (side) views of the phone.

Front

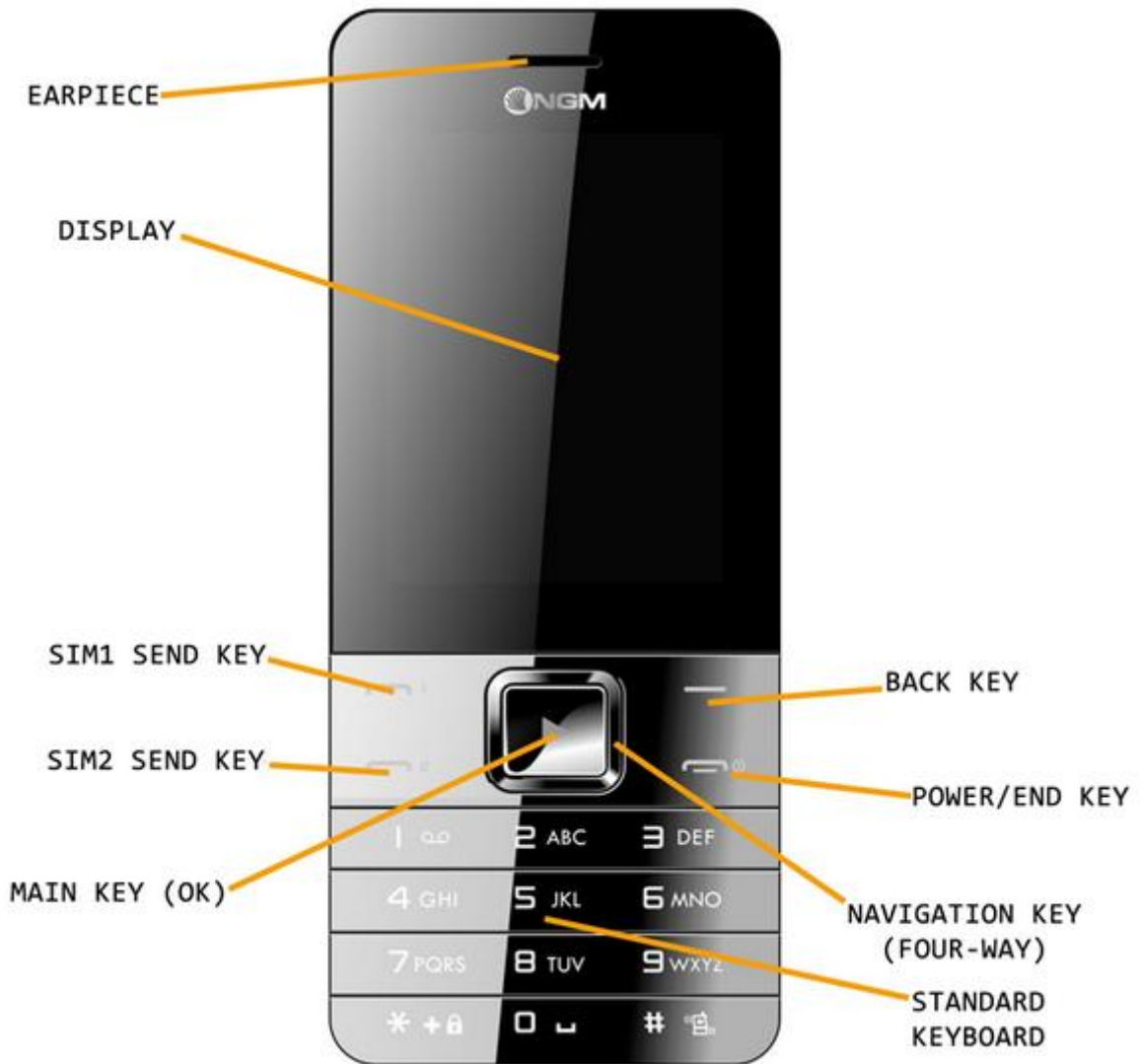

Rear / Lateral



Get started

SIM Card Installation

Installing the SIM Cards

Since the phone supports **two SIM cards**, when registering a mobile phone number, you can apply for two separate phone numbers, two different mobile phone network service providers and thus obtain two SIM (Subscriber Identification Module) cards.

With these two SIM cards, you can use all the features of your phone. The SIM cards save the parameters required for communications and personal information, including PIN (Personal Identification Number), address book, messages and other system services additional.

Warning: do not deform or scratch the SIM cards nor let it contact static, dust or moisture. If it is lost, please immediately contact your network operator for help.

Before SIM card installation, please switch off the mobile phone. The SIM cards must be inserted in the back of the phone, after removing the battery. Insert the SIM cards in their slots with the gold contacts facing down and the notched corner facing outwards. Insert the main SIM card in the **SIM1 slot** and secondary SIM card 2 in the **SIM2 slot**. See the diagram below.

Note: if a SIM card is inserted into the SIM1 slot only, then only the host works; likely, if a SIM card is inserted into the SIM2 slot only, then only the slave works. When two SIM cards are inserted into the SIM1 slot and SIM2 slot respectively, you can choose work mode freely as you wish.

Note: as the SIM card is small object, keep it out of children's touch or prevent children gulping it!

SIM cards installation diagram

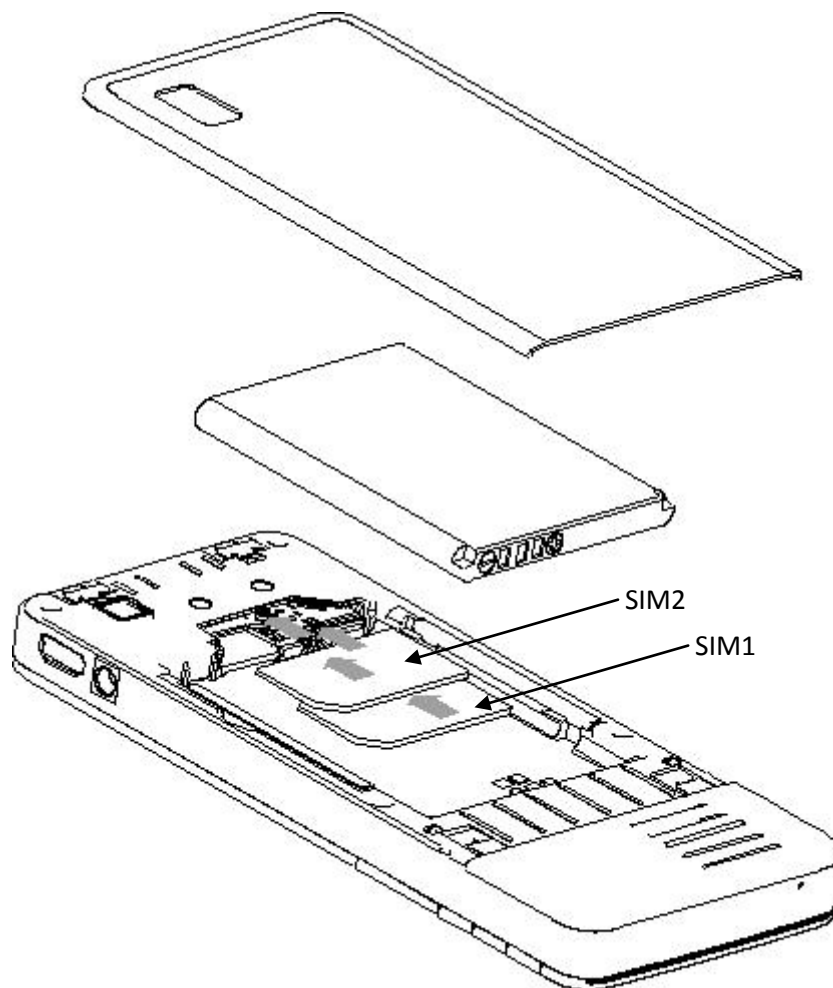

Memory Card Installation

Installing a Memory card

As the mobile phone does not have enough storage space, to use some functions, you need to install a **memory card** (this mobile phone use **T-FLASH** cards.)

To install a T-FLASH card: power off the phone, open the back cover to remove the battery, insert the T-Flash card into its dedicated slot (underneath the SIM cards' slots), and restore the battery and the cover before restarting the mobile phone.

To make the insertion of microSD card easier, it may be advisable to do this before introducing the SIM cards in their slots.

Note: as the T-FLASH card is small object, keep it out of children's touch or prevent children gulping it!

Memory card installation diagram

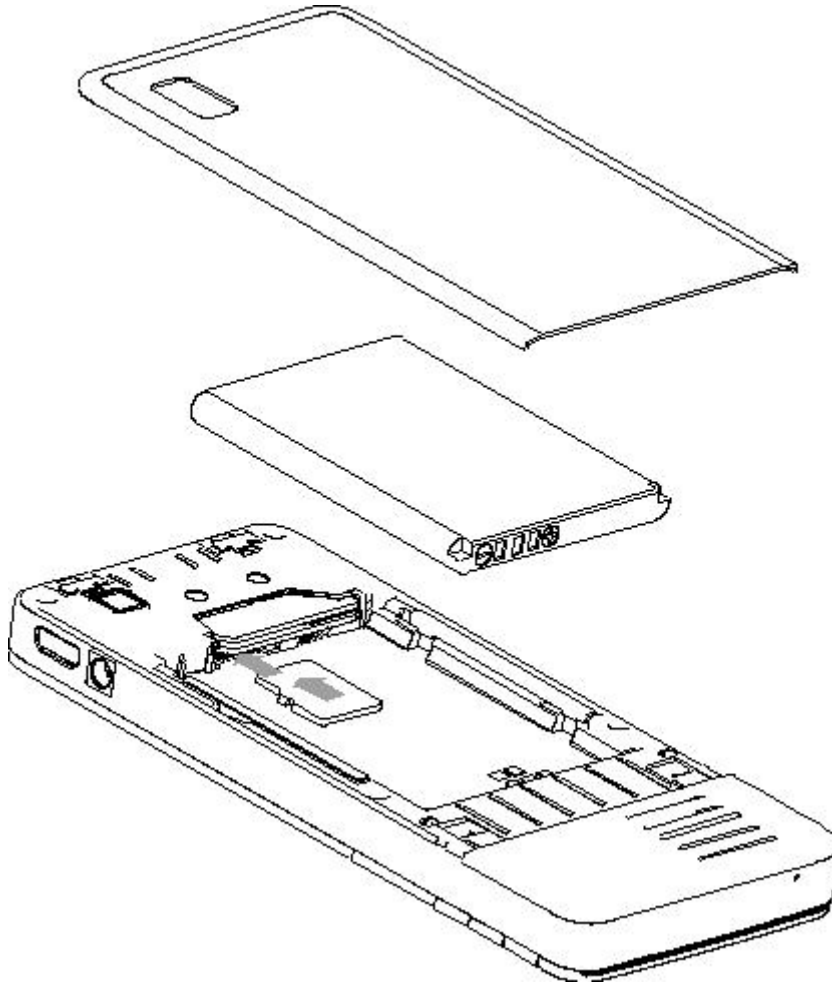

Battery Installation

Installing the Battery

Your device is provided with a lithium-ion battery and is designed to be used exclusively with original NGM batteries and chargers. Battery must be inserted from the backside of the phone. Align the battery contacts with the phone connector inside the dedicated slot, and let it slide down in position. Once the battery is inserted, close the rear cover by gently pushing it in position.

Note: do install the battery as per the diagram to prevent the battery contact patch being damaged.

Battery installation diagram

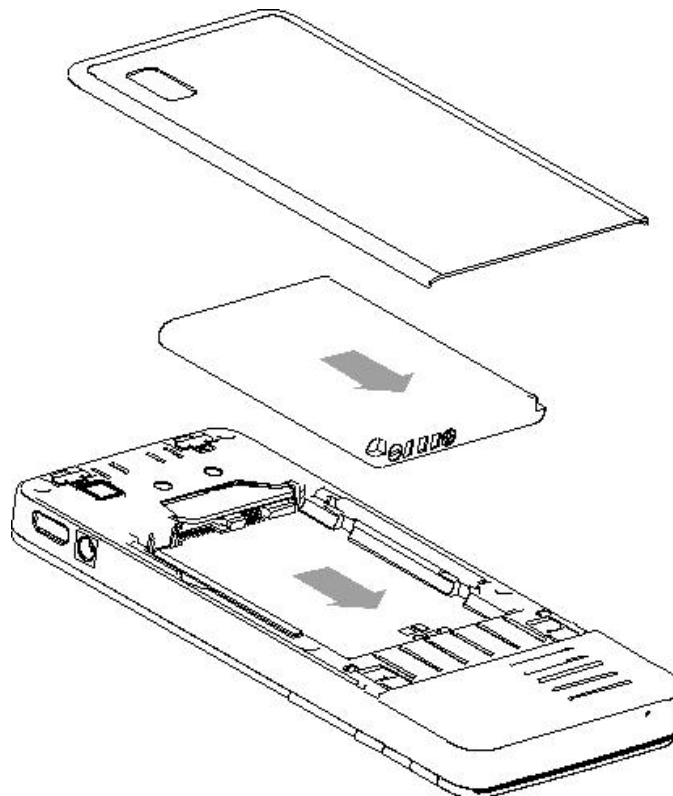

Battery Charging

Battery Charge

Please charge completely the battery before starting to use the device. The new battery cannot reach the optimal efficiency unless it has undergone several continuous complete charges and discharges.

Use the USB cable provided, and connect it one end to the USB connector placed on the right side of the phone, and the other end to the wall socket adaptor.

When the battery is used up, charge it in time. Over-discharge can damage the battery.

After the battery is charged full, cut off the connection of charger with the AC power supply and the connection with the mobile phone.

When battery is charging, an animated icon on screen will show the charging progress. Once the progress bar is completed phone can be disconnected from the grid.

Follow the diagram below to connect the charger.

Note: Use only the provided USB cable for recharging the device. Charge the battery indoors in a dry and favourable environment. It's normal for the battery to get slightly warm during the charging process.

Warning: use only original accessories to charge the battery. The use of other accessories may damage your mobile phone and cause risks!

Connections Diagram

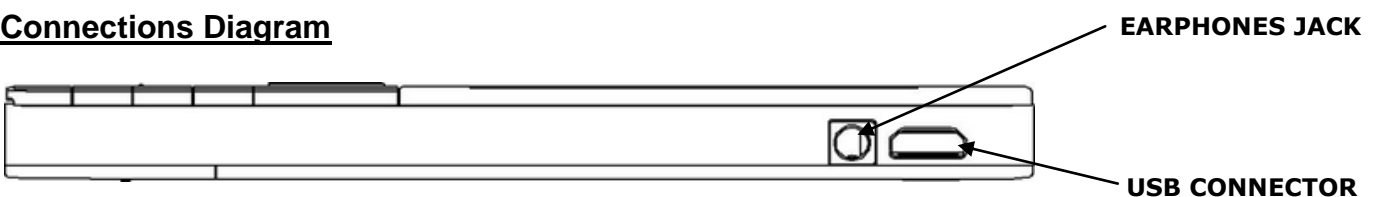

Notices on using the battery

Notices on using the battery

The performance of the battery is affected by many factors, including radio barrier network settings, signal strength, signal strength, work temperature, chosen and used functions or settings as well as phone accessories, tones, data or other applications.

For optimal performances, please follow the rules below:

- New battery or the battery having been idle for long need charging for long. The standard voltage scope for the battery is 3.6V-4.2V.
- During charging, keep the battery at room temperature or similar temperature.
- With time passing by, the battery will gradually be worn and thus need longer time to charge. This is normal. However, after normal charging, if call duration decreases but charging time increases, you need to buy another battery from the original manufacturer or authorized by the original manufacturer. The battery of inferior quality can damage your mobile phone and cause danger!
- If the phone is overused at low battery when charging, there might need a longer time for the charge indicator to be shown on the screen.

Note: please dispose the battery according to the local regulations. Try to recycle the battery as possible. Do not treat the waste battery as common waste.

Warning: do not throw the battery into fire so as to prevent fire hazard. The broken battery may cause explosion.

Warning

Charging the mobile phone by improper means can cause to explosion. Always refer to the related regulations for the disposal of the battery.

PIN Code

PIN Codes

PIN1 Code: it is the personal identification number used to enter SIM and able to prevent others using SIM1 without permission. If the mobile phone has activated the PIN1 code protection, when the mobile phone is switched on, the screen will display "Input PIN". In the process of inputting PIN1 code, the screen will use "*" to represent the input content. While obtaining SIM, you can obtain its PIN1 code.

PIN2 Code: it is the personal identification number used for some special functions.

PUK Code and **PUK2 Code** (8 digits): to change the locked PIN code, you need to use PUK (Personal Unblocking Key) code. To change the locked PIN2 code, you need to use PUK2 code. If these two codes are not provided together with the SIM cards, ask the local service provider for them.

Warning: if you input the wrong PIN code for three times continuously, the SIM card will be locked. Please contact the network operator immediately for help. Attempt to unlock the code may make the SIM card ineffective forever!

General Instructions

OK Key and Navigation Keys

OK Key and Navigation Keys

OK key is commonly used on various situations. In standby mode, this key will bring up the main menu, that you can browse through using the **Navigation** keys (up/down, left/right). Once a menu is open, use the Navigation keys to browse through the options and OK key to confirm.

Send Keys

Send 1 and Send 2 keys

Use these keys to make a call (after dialing the number, or after selecting an entry from the Phonebook) **via SIM1** or **via SIM2**. In standby mode, pressing one of these keys will bring up the recent call history (SIM1 and SIM2 can support up to 20 voices, including Missed calls, Dialed calls and Received calls). Select a contact from the list and press again SIM1 or SIM2 Send keys to call the number.

End Key and Back Key

End Key and Back Key

In call mode, **End** key will end the current call; in other situations, it will exit the current menu and return to standby mode. Pressing the key for 4~5 seconds will switch on or switch off the mobile. The **Back** key will exit the current menu or sub-menu and return to the previous screen; when inserting text, this key will delete the character to the left of the cursor.

Standard Keyboard

Standard Keyboard

The phone features a standard modern telephone keypad, with numeric keys **0-9 (A-Z)**, * key and # key, total 12 keys.

These keys are used to input numbers, passwords, letters and symbols when writing messages, or to choose menu options.

In different mode or different menus, "*" key and "# " key have different functions.

- Pressing "#" for some seconds will activate/deactivate the vibration mode.
-

FM Radio Keys

FM Radio keys

■ **OK key**: in FM radio mode, press this key to turn on/off the FM radio.

■ **Navigation keys** (up/down): to start a manual search for radio stations, scrolling the frequency up and down slowly. You can fine tune the radio frequency by +0.1 MHz. or by -0.1 MHz using these keys.

■ **Numeric keys** (1-9): if pressed briefly, these keys call up the corresponding channels, previously saved in the channels list; if pressed for a few seconds, they tune the current radio frequency in the corresponding channel.

■ "*" and "#": these keys act as volume control.

Keyboard Lock

Keypad Lock





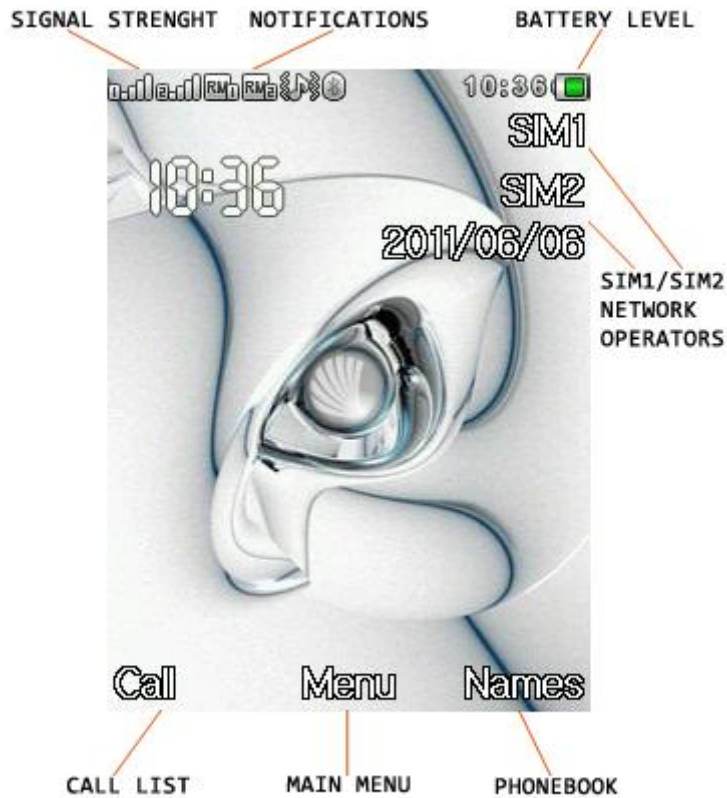









In standby mode, select Menu, then choose **SETTINGS > Security Settings > Auto Keypad lock**, then select the desired time; after the phone is idle for the selected time period, the keypad become locked. Press * key to unlock. When the keypad is locked, it's possible to answer a phone call just pressing the OK key; after the call is ended, the keypad will be locked again. You can also lock the keyboard on demand, pressing the OK key for some seconds from the standby mode; insert the password ("1122" by default) to unlock.

Standby mode

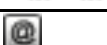

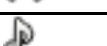
Icons list meaning

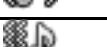
Icon	Status	Meaning	Notes
	1 2	SIM1 / SIM2 No signal	May be the signal is not present or the SIM is not correctly inserted
	1 1 1 1 1 2 2 2 2 2	SIM1 / SIM2 Signal searching / Signal Level	
		No power	
		charging	
		BT powered on	
		Call Active	
		Call Hold	
		Call Mute	
		Alarm on	
		Audio playing	
		Background sound on	
		SIM1 / SIM2 EDGE connection	
		SIM1 / SIM2 EDGE connecting	

		SIM1 / SIM2 GPRS connection	
		SIM1 / SIM2 GPRSC connecting	
		SIM1 / SIM2 Call forward	
		SIM1 / SIM2 Missed Call	
		SIM1 / SIM2 new messages	
		SIM1 / SIM2 roaming	Determined by Operator
		SIM1 / SIM2 MMS busy	
		SIM1 / SIM2 new MMS	
		Emails	
		Earphone plugged in	
		Profile ring mode	
		Profile silent mode	
		Vibrate and ring	
		Vibrate then ring	
		Profile Vibrate mode	
		Lock the idle screen	

Language and Input Mode

Language and Input Mode

Italian is the language by default and as input mode. For different areas, there are 4 languages available (english, french, spanish, german) with the corresponding input modes.

How to change the menu language: **SETTINGS > Phone settings > Language > [select a language]**.

How to change the input language: **SETTINGS > Phone settings > Input text > Writing language > [select a language]**.

Call Hint

Incoming Call Hints

The mobile phone is inbuilt with vibration motor and buzzer and provides several incoming call modes, each one indicated by one of the following icons:

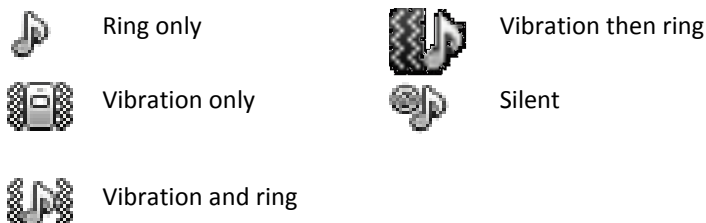

In order to change the alert mode, choose: **USER PROFILES > [Selected Profile] > Customize > Alert type** (there are separate settings for each SIM card).

In standby mode, press and hold the **#** key to quickly turn on **Vibrate** mode and to turn off the ringer. By pressing and holding the same key again, the previous user profile will be restored.

Services

Services

Services are provided with SIM kit. The mobile phone support service function. The detailed menu items depend on SIM card and the network. When the network provides such function and your SIM card supports such function, the service menu will be automatically displayed between the services of the mobile phone.

Callers' group

Callers' groups

The callers' groups in the mobile phone include various contacts sharing common characteristics and features (i.e. family, friends, work colleagues, etc.). You can set different ringtones and pictures for each callers' group.

To create a group, choose: **PHONEBOOK > Callers Groups > Add new group.**

After creating the group with a customized name, select it with **OK** key, then choose **Add** to view the number list and add the contact to the group.

Note: you can add to the group phone contacts only – not SIM contacts.

Basic Operations

Switch On

Switch On

Press the **Switch-on/off (End)** key to start the mobile phone, then the screen will display the switch-on image. When the standby screen is displayed, press the **OK** key to enter the main menu. Then you can enter **SETTINGS > Dual SIM settings** menu to set phone modes, including **Dual SIM open, Only SIM1 open, Only SIM2 open** and **Flight Mode**. The defaulted one is **Dual SIM open**.

After inserting SIM card, the mobile phone will automatically check the SIM card availability, and then it will be show the following informations on the display by sequence:

1. **"Input phone password"**— if you have set the password.
2. **"Input PIN"** — if you set SIM card password.
3. **"No service"**— indicates failure to register; the phone cannot make any calls.
4. **"Emergency calls only"**— indicates that the phone has registered to other network and can only make call to 112.
5. **"Searching"**— the mobile phone is searching an appropriate network.
6. **"Operator name"**— indicates network successfully registered.

Note: if you do not know your PIN code, please contact the network service provider. The mobile default password code is **"1122"**.

Switch Off

Switch off

To switch off the mobile phone, press the **End** key. When the screen displays the switch-off animation, the host and the slave SIM will be off at the same time. Do not take out the battery to switch off the mobile phone. If so, the SIM card can be easily damaged and some data will be lost.

How to Dial a Call

How to Make a Call

- With the number keypad, you can enter phone numbers (if wrong characters are input, press the **Back** key to delete them). Press the **Dial** keys to dial the phone number. In **SIM1** and **SIM2 On** state, you can choose to dial a call via SIM1 or SIM2 (**Send1** and **Send2** keys, respectively). To end a call, press the **End** key; or to cancel a dial, press the **Back** key or the **End** key. After the call is connected, you can see the call timer on the screen. If your dialled number is saved in mobile phone memory, the contact name will be displayed on screen.
- Dial a call via Phonebook: enter the **Phonebook** menu and search the desired name/phone number, and then press **Dial** keys to dial..
- Redial latest dialed number: in standby state, press **Dial** keys (**SIM1** or **SIM2**) to view the list of the latest dialed 20 phone number or names. Roll to the desired phone number or name and press **Dial** keys to dial call.

Adjust Receiver Volume

How to Adjust the Receiver Volume

When speaking to someone, press the Navigation keys **Up** (+ volume) or **Down** (- volume) to adjust the receiver volume.

Answer a Call

How to Answer a Call

When there is an incoming call, you will be alerted with ring, vibration, vibration and ring, or vibration then ring, according to the settings of the mobile phone.

To receive a call, press **Dial/Send** Keys or **OK** key. If you prefer to use whatever key to answer, you can select: **SETTINGS > User Profiles > [Selected Profile] > Options > Customize > Answer mode > Any key**.

To refuse a call, press the **End** key directly.

If the CLI (Call Line Identity) is opened, the phone number of the caller will be shown on the screen. If this number has been saved in the phonebook, the name corresponding to this number will be displayed on the screen.

DTMF tones

Sending DTMF tones

With this option enabled, when calling up a voice mailbox or another automated phone system press the desired number key and the "*" and "#" keys to send DTMF (Dual Tone Multi-Frequency) tones, in order to access options or extension numbers.

Dial Hold

Place a Call on Hold

If you have applied for dial hold, in the call conversation process, choose "**Call Center > Call Settings > SIM (1 or 2) Call Settings > Call Waiting**" to have the following function menus:

- **Activate**: to activate the function allowing to place a call on hold.
- **Deactivate**: to deactivate the same function.
- **Query status**: to query the current call status.

Note: some menu's elements need the network support; others may occur under special conditions. Please contact the network operator for further details.

Fast SMS Reading

Fast SMS Reading

When the user receives some new SMS, the screen will display an icon of unread SMS. Press **Read** to enter and read the SMS. The SIM card 1 unread SMS icon is marked with "1" and SIM card 2 unread SMS icon is marked with "2".

Missed Calls

Missed Calls

When there is a missed call incoming, the screen will display a missed call icon (separately for each SIM card). Press **Send** key (**SIM1/SIM2**) to enter and read details about the missed calls.

Answering Machine

Answering machine

The telephone answering machine is a device designed to record audio messages directly on its local memory without connecting to a server to listen the recordings, thus avoiding the relative charges. Moreover, you can customize your answering machine message, using the phone's microphone. The answering machine will turn on after a preset number of rings, or can be operated manually as answer option. You will be notified with an icon (separately for SIM1 and SIM2) when you got messages left on your answering machine. If you want to listen to messages, select **APPLICATIONS > Answer machine > Messages left** .

Use of Menu functions

Phonebook

Phonebook

Contacts can be saved to the SIM card or phone memory. The phonebook will show all the contacts from the SIM cards and phone. Only two details can be saved to a SIM card, name and phone number. More details can be stored in the phone memory, including multiple phone numbers, email address, pictures, and ringtones. The phone stores up to 1000 entries. Available options:

View

Display the contact name, the number, and other details.

Send message

Send a SMS to the selected contact.

Edit

Edit the details of the selected contact.

Copy

Copy the selected contact from phone to a SIM card (and vice versa), or from a SIM card to another; moreover, you can copy that same contact into the Black List, the White List or in a file (.vcf format).

Move

Move the selected contact from phone to a SIM card (and vice versa) or from a SIM card to another.

Send vCard

Send the **vCard** of the selected contact as text message, as multimedia message, as Email or via Bluetooth.

Delete

Delete the selected contact from the list.

Phonebook settings

- **Name filter:** you can select which list to display (SIM1, SIM2, phone and all the possible combinations)..
- **Speed dial:** you can toggle this option on and off; it allows to assign a phone number to each numeric key (2-9) for speed dials.
- **My number:** you can edit your **vCard** and send it as text message, as multimedia message, or via Bluetooth.
- **Extra numbers:** you can save (separately for SIM1 and SIM2) some particular numbers as owner numbers, service numbers and SOS numbers. You can also build a list (separately for SIM1 and SIM2) of fixed dialing: after that you can only make calls to contacts that appear in your fixed dialing list (except for emergency calls).
- **Phonebook backup:**
- **Memory status:** you can display the current status of the phonebook memory, including the memory available on SIM1 and SIM2. The display format for the memory usage is "used/total".
- **Delete all contacts:** delete all contacts from SIM1, from SIM2 or from phone.
- **Reminder time:** you can set here a time to get a reminder for all birthdays entered in the contact details.

Mark several

You can select more than one contact at a time to speed up the operations on the phonebook.

Caller Groups

You can organize your contacts into caller groups such as family, friends, business, etc. and customize the attributes for each group. You can choose a name (**Add new group**), a ringtone and a picture for each group.

Note: Only contacts from the phone memory can be added to caller groups.

Call Center

Call Center

Call center includes **Call History** and **Call Settings**. In dual-SIM mode, you can separately search the call register of SIM1 and SIM2 and set separately some operations corresponding to SIM1 and SIM2. In mono-SIM standby mode, you can set the available SIM card and see its call register.

SIM Call History

Call history allows you to view **missed calls**, **dialed calls** and **received calls** in both SIM cards.

In missed calls, received calls and dialed calls function list, you can see: date, time, duration of the call; call back the number; edit or delete the phone number in the list; save the number to phonebook or send SMS and MMS to the number; add the number to the Blacklist; delete call logs; view call time, call costs, SMS counter and GPRS counter.

Note: SIM1 and SIM2 contain up to 20 entries each (including Dialed calls, Received calls and Missed calls).

For each call in the list, you can watch the following counters:

Call timers

- **Last call:** with this function, you can view the last call duration.
- **Dialed calls:** with this function, you can view the global duration of all dialed calls.
- **Received calls:** with this function, you can view the global duration of all received calls.
- **Reset all:** with this function, you can clear all your call duration records.

Call Cost

This function needs the support of the network service provider.

- **Last Call Cost :** with this function, you can view the last call cost.
- **Total Cost:** with this function, you can view the global cost of all dialed calls.
- **Reset cost:** with this function, you can clear all your call cost records.
- **Max Cost:** with this function, you can limit call costs in the specified pricing unit or currency unit. PIN2 code must be input to set call cost.
- **Price per unit:** this function needs network support. For more details, please consult the network operator.

Note: real call's duration and time/cost counting for billing purpose on the network operator side may differ: this can be attributed to network functions, bill roundings, taxes, etc.

Text message counter

With this function, you can view the number of **sent** messages and **received** messages.

GPRS counter

- **Last sent:** you are able to view traffic sent in the last GPRS connection.
- **Last received:** you are able to view traffic received in the last GPRS connection.
- **All sent:** you are able to view global traffic sent.
- **All received:** you are able to view global traffic received.
- **Reset counter:** you can clear all your traffic data records.

Call Settings

1. SIM1/SIM2 Call Settings

In dual-SIM mode, you can maintain separate **Settings** for SIM1 and SIM2.

- **Caller ID:** you can choose ID as set by Network, Hide ID or Send ID.
 - **Set by network:** while in conversation, you can send your Caller ID in the form preset by the system.
 - **Hide ID:** while in conversation, you will not send your Caller ID. If the system does not support such function, call may fail.
 - **Send ID:** while in conversation, you can send your Caller ID to the system

Note: this function requires network support.

- **Call Waiting:** you can freely choose to turn On or Off this function. The call hold cannot be active unless this function is activated. This function requires network support.

- **Call Divert:** this kind of function cannot be used unless you apply to the network operator for it. With this function, you can divert calls meeting the following conditions to another number.

Option	Descriptions
Divert All Voice Calls	The network will divert all voice calls without conditions.
Divert if Unreachable	When the network cannot find your mobile phone (switched-off or out of the service area), it will divert the calls.
Divert if no Answer	When the mobile phone does not answer the call, the network will automatically divert it.
Divert if Busy	When you already are in a conversation, the network will divert the call.
Divert All Data Calls	The network will divert all data calls without conditions.
Cancel All Diverts	Cancel all divert conditions.

■ Call Barring:

■ Outgoing calls:

1. **All calls:** you can bar all outgoing calls.
2. **International calls:** you can bar international calls only.
3. **International calls except to home:** when abroad, you can dial the calls to the country you are currently in and to your own country (the service providers allows to do so).

■ Incoming calls:

1. **All calls:** you can bar all incoming calls.
2. **When roaming:** you can bar all incoming calls except the calls of the local service area.

- **Activate all:** global barring for all the outgoing and incoming calls.

- **Cancel all:** remove all barring, allowing to dial out and receive calls as usual.
 - **Change barring password:** you can apply to the network to change the password for call barring.
-

2. Advanced settings

■ Auto redial

You can set this function as On or Off. After the first automatic redial fails, you can have at most ten times to connect a phone number.

■ Background sounds

Background sounds help to recreate the realistic ambient sounds during a particular call (i.e. "platform" "airport", "station", "restaurant" and other user-recordable sounds). This option can be selected by default or can be set just in time when there is an incoming call.

You can control the volume level and reproduction mode (once, continuous, interval). The phone includes 10 pre-recorded background sounds; user can add his own sounds in .wav format (8 MHz, 16 bits samples).

■ Call time display

The phone screen can display the talking time of your current call.

■ Call time reminder

The phone has time reminder: you can set a sound warning at any time you like or at any time interval (between 30-60 seconds).

■ Reject by SMS

You can automatically reject a call by SMS, using a predefined message to select in **Message > Templates**.

Multimedia

Multimedia

Camera

Use the inbuilt camera to take your photos. The camera lens is on the back side of the phone and the LCD screen acts as a viewfinder. It is advisable to keep the phone in a horizontal position to view correctly the tools available on the LCD screen. The photos shall be saved in a JPG file format. Some software could be necessary to view the photos, if you download your camera phone pictures onto the computer.

If there is insufficient space on the drive to store the images, it should be necessary to remove some old pictures (or any other type of files) from "File manager" menu to free up disk space.

See picture below showing the **Camera** screen (in horizontal view), and its main functions:

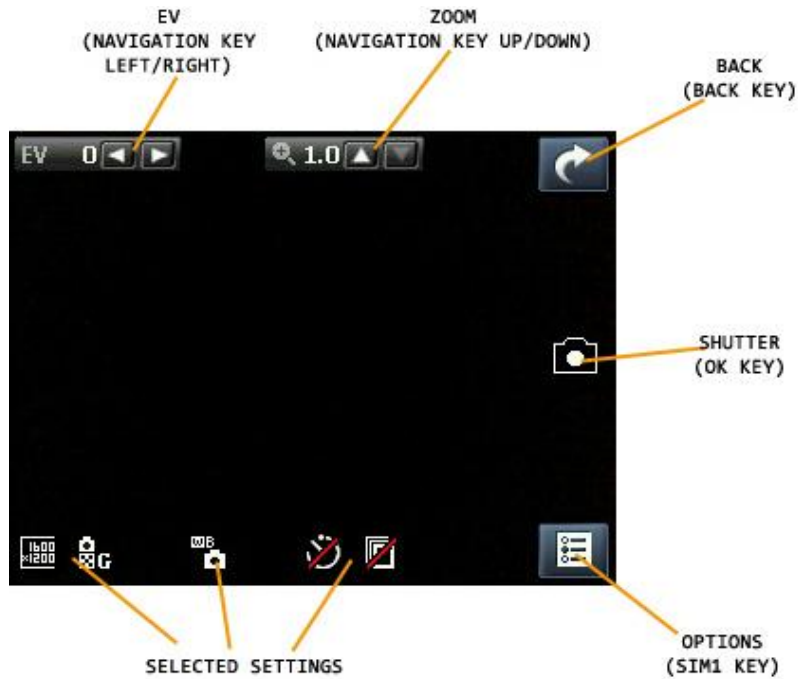

Once activated, the **Camera** screen will offer the following options (use the **SIM1 Key** to get access to Options) :

Options	Descriptions
Photos	Displays all pictures taken.
Camera settings	Shutter sound: Sound 1, Sound 2, Sound 3 or Off.
	EV (exposure value): in the range -2 to +2
	Contrast: High, Medium or Low.
	Anti-flicker: 50Hz (preset) or 60Hz.
	Delay timer: 5 seconds, 10 seconds, 15 seconds or Off.
	Continuous shot: 1 shot, 3 shots, 5 shots or Off.
Image settings	Image size (240x320, 640x480, 800x600 or 1600x1200) and Image quality (Good, Normal, Low).
White balance	Automatic, Daylight, Tungsten, Fluorescence, Cloudy or Incandescence.
Scene mode	Automatic or Night.
Effect settings	Normal, Gray scale, Sepia, Sepia green, Sepia blue, Color invert.
Storage	Select the storage path for image files (Phone or Memory card).
Restore default	Restore the default settings.

To browse/set the various available options, please see the following picture (in horizontal view):

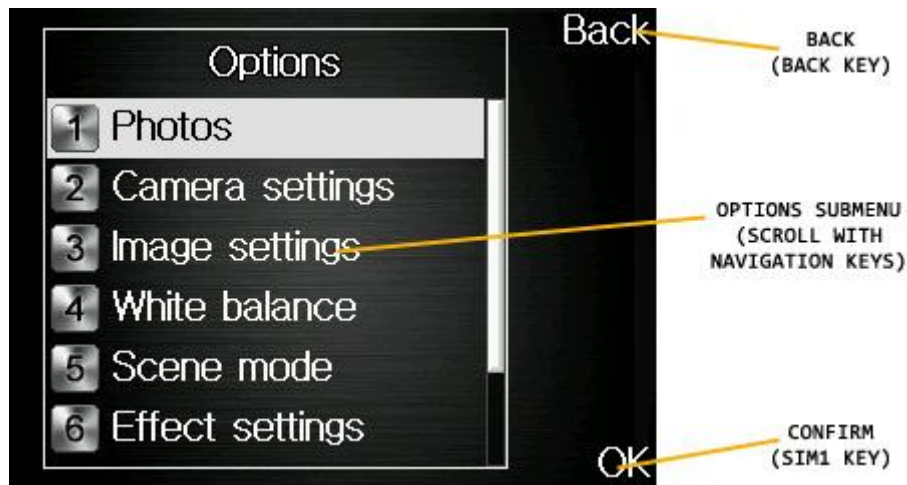

Video player

Use this menu to play/open a video file previously saved in phone or memory card. This application supports playing MP4 e 3GP video formats. Available options:

Options	Description
Play	MP4 and 3GP formats are supported, without size limit.
Send	Send the file as MMS, as E-mail attachment or via Bluetooth.
Rename	Rename the selected video clip.
Delete	Delete the selected video clip.
Delete all files	Delete all the video files from the chosen storage location.
Sort by	Sort the video clips by name, type, duration and size, or select "None".
Storage	Select the storage path for video files (Phone or Memory card).

Image viewer

Use this menu to view an image file previously saved in phone or memory card. This application supports JPG picture format. Available options:

Options	Description
View	View the selected picture.
Browsing style	List or matrix.
Send	Send the file as MMS, as E-mail attachment or via Bluetooth.
Use as	Use the selected picture as wallpaper, as screen saver, power on picture, power off picture, or caller picture.
Rename	Rename the selected picture.
Delete	Delete the selected picture.
Sort by	Sort the pictures by name, type, duration and size, or select "None".
Delete all files	Delete all the image files from the chosen storage location.
Storage	Select the storage path for video files (Phone or Memory card).

Video recorder

Use this menu to record a video file. The lens for the camcorder is the same as the one for the camera; it is advisable to keep the phone in a horizontal position to view correctly the tools available on the LCD screen. Press OK key to start a new video recording. The video duration is dependent on the fixed maximum recording time or storage memory.

See picture below showing the **Videorecorder** screen (in horizontal view), and its main functions:

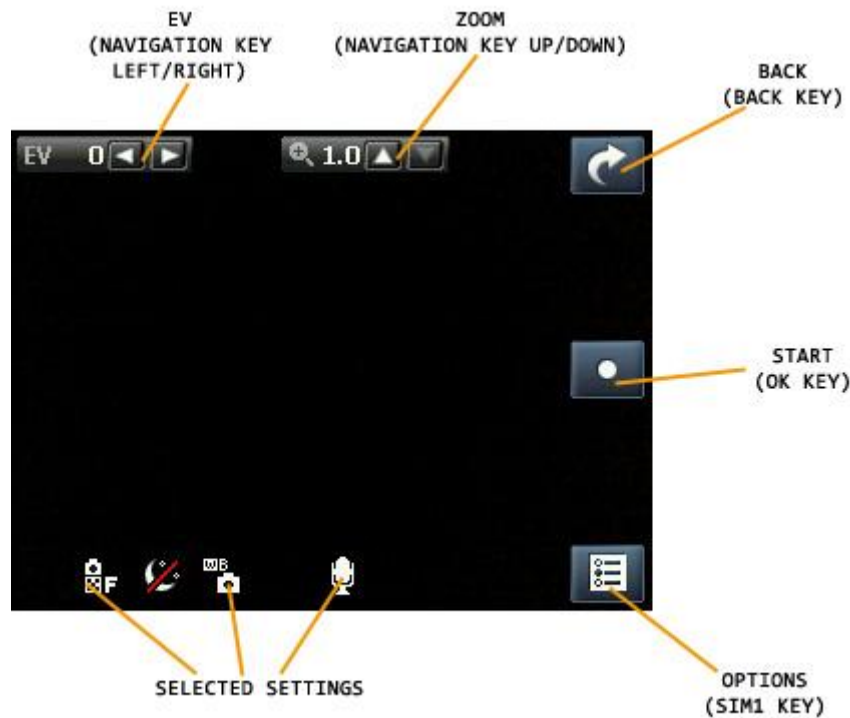

Once activated, the **Videorecorder** screen will offer the following options (use the **SIM1 Key** to get access to Options) :

Options	Description
Camcorder settings	EV (exposure value): in the range -2 to +2
	Night mode: On or Off
	Anti-flicker: 50Hz (preset) or 60Hz.
Video settings	Video quality: High, Good, Normal, Sharing.
	Size limit : 95k, 195 k, 295 k, or No limits.
	Time limit: 15 sec., 30 sec., 60 sec., or No limits.
	Audio recording: On or Off
White balance	Automatic, Daylight, Tungsten, Fluorescence, Cloudy or Incandescence.
Effect settings	Normal, Gray scale, Sepia, Sepia green, Sepia blue, Color invert.
Storage	Select the storage path for video files (Phone or Memory card).
Restore default	Restore the default settings.

To browse/set the various available options, you can use the same procedures illustrated before for the **Camera** (see the following picture, in horizontal view):

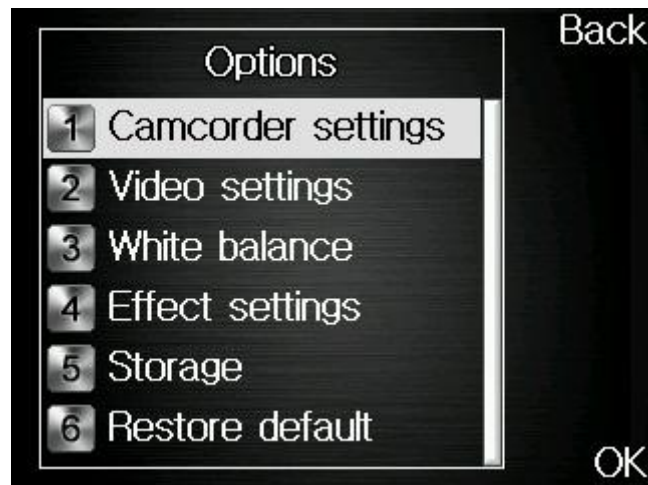

Audio recorder

Use this menu to start a new audio recording and play audio files previously saved in phone or memory card. From the list, select "**Options**" to get the following operations:

- **Play**: play the selected file.
- **Append**: combine two recorded files into one single file (only for files recorded in AMR format).
- **Rename**: rename the selected file.
- **Delete**: delete the selected file.
- **Delete all files**: delete all the audio files from the chosen storage location.
- **Use as**: use the selected recorded file, inserting it in the list of audio files available for **User's profiles**.
- **Send**: send the file as MMS, as E-mail attachment or via Bluetooth.

Choosing **Settings** from "**Audio recorder**" options, you can select the storage path for the recorded files (Phone or Memory card); the recording formats are AMR, AWB or WAV. It's also possible to choose the recording quality (High or Low).

FM Radio

The phone includes a built-in FM radio. The earphones are required to listen to FM Radio: insert first the earphones jack in the socket on the right side of the phone. The earphones cable acts as antenna, so let it hang free from the connector. It is possible to make/receive a telephone call when you are listening to the radio. When the conversation is rolling along, radio will automatically switch to silent mode. If some application is currently using GPRS or CSD to send/receive data, there could be interference with radio signal.

After starting FM radio, the phone will show number, name (if already saved), and frequency of the radio channel. If you already saved some radio channels into the phone, you can select the desired channel or press any numerical key (1 to 9) to choose the corresponding channel.

Options

- **Channel list**: save up to 30 radio channels (the first 9 can be directly recalled from the keyboard).
- **Manual input**: insert here directly a specific radio frequency. The frequency range of FM (frequency modulation) radio is 87.5 MHz to 108 MHz.
- **Auto search**: start an automatic search and save the frequency in the Channel list.
- **Settings**: enable/disable Background play, enable/disable loudspeaker, choose a recording format, choose audio quality and select the storage path for the recordings.
- **Record**: record an audio file from a radio program.
- **Append**: combine two recorded files into one single file (only for files recorded in AMR format).
- **File list**: view the recorded audio files.

FM Radio screen allows you to access to the most common operations through **navigation keys**, **OK** key, ***** and **#** keys:

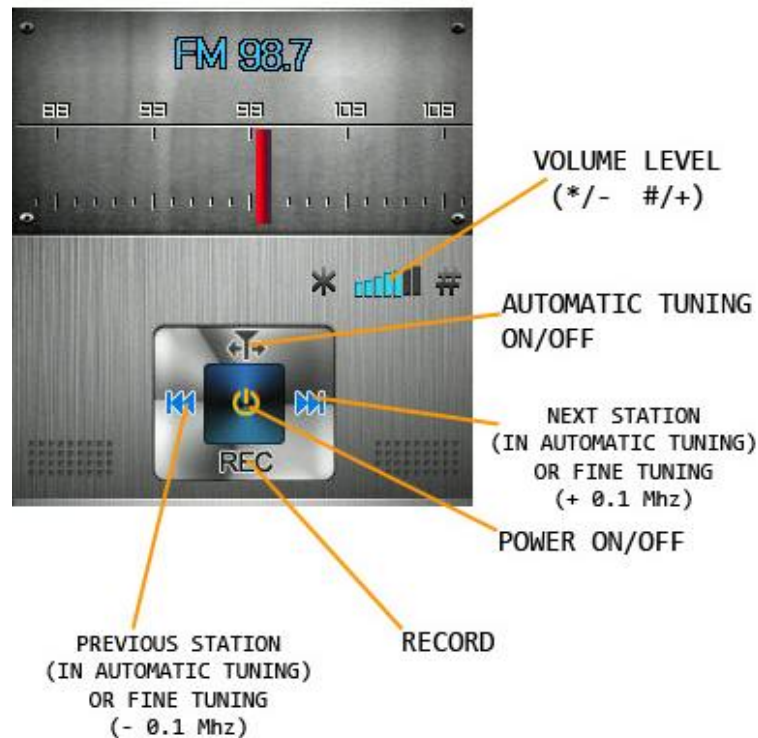

Bluetooth

Bluetooth

The phone supports Bluetooth. Bluetooth is a short-range radio transmission system that is useful for sending data between electronic devices, as cell phones, computers, earphones, car-kits, etc. Bluetooth allows to send photos, video clips, audio files, electronic business cards and reminders. You can also wirelessly connect to your PC and send files or establish a low-speed connection to the Internet.

When a Bluetooth connection is established, the distance between the communicating Bluetooth devices must be usually not more than 10 meters to guarantee optimal performance. In any case, walls and other solid barriers can shield the Bluetooth connection, and other electronic devices can cause interference. In order to verify the full compatibility of this phone with other Bluetooth devices, please check with the device's manufacturer for the latest information. Do not use Bluetooth in the hospitals, on aircrafts, etc.

- **Power:** turn the Bluetooth power on, before using this function. When not in use, Bluetooth power consumption could be rather high. So, it is advisable to turn off Bluetooth function when you are not using it.
- **Visibility:** when Visibility is on, other Bluetooth devices can detect your phone and its name after starting a search. If the audio player is on, your device will be undetectable.
- **My device:** with this function you can see all the devices that have been paired with the phone in the course of time and their type of connection. The option **Inquiry new device** will start a search for all Bluetooth devices compatible with your phone, and will pair the phone with the selected Bluetooth device. It's obviously possible to cancel the unwanted connections.
- **Inquiry audio device:** with this function you can start a search for all the Bluetooth audio devices compatible with your phone. Then, you can pair the phone with the selected Bluetooth audio device. When searching for Bluetooth devices of another kind, please use the function **Inquiry new device** instead.
- **Change device name:** change the name with which your phone is detected by other Bluetooth devices.
- **Active devices:** show all the devices currently paired with the phone and active.
- **Advanced:** when Bluetooth is powered on, this submenu allows to access the following settings:
 - **Audio path:** set Audio path (Phone or Bluetooth earphone).
 - **Storage:** set storage path for Bluetooth file transfer (Phone or Memory card).

- **Sharing permission:** to access the Bluetooth shared files as read-only or with full control.
- **My address:** view the physical address (**MAC**, Media Access Control) of your device.

Tip: when searching for other Bluetooth devices, make sure that the devices are inside the range reachable by Bluetooth signal. When pairing other devices, it shall be necessary to agree on a password shared with the Bluetooth devices' users. To pair the earphones with your phone, insert its own password.

Messaging

Messages

SMS

Both SIM cards are able to send and receive SMS. When an SMS message is sent from a mobile phone, it will reach an SMS center first. The SMS center then forwards the SMS message towards the destination. If the recipient is unavailable (for example, when the mobile phone is switched off), the SMS center will store the SMS message. It will forward the SMS message when the recipient is available. The storage duration of the message depends on sender's settings and network operator's policy.

Sending and receiving text messages can become costly depending upon the text message plan you have with your provider. Please contact your service provider/network operator for further details.

If SMS storage capability is exhausted, a SMS icon will flash in standby screen. Unnecessary SMS storage can affect the reception of new SMS; please delete older messages to prevent such problems.

When a message has been received, you will get a notification message tone (if the option has been previously selected).

Note: when sending SMS, the phone will usually show the "**Message sent**" notification. This means that the SMS has been sent to the SMS Center, but the message could anyway not be received by recipients. Please contact your service provider/network operator for further details.

MMS

MMS is a standard way to send messages that include multimedia content (short video clips, photos and audio). If MMS is over the size limit, the phone won't display the message. The phone will automatically resize the images attached to the MMS, so that they can be fully shown on the screen.

The visualization of each single MMS depends heavily upon the receiving devices.

Note: you can't send or receive multimedia content if your network operator/service provider does not support this service. Multimedia content can't be received or shown if the recipient doesn't have a MMS-compatible cell phone.

Write message

Select this option to write a new text message or a multimedia message. This device implements the T9 input mode, a predictive text method for quickening and simplifying the whole message writing process.

Each SMS can contain at most 160 characters; by linking two or more messages together (up to a maximum of 4) you can build a combined message (up to a maximum of 640 characters). Press the **#** key to change the input method. Press the "**Back**" key to remove the last incorrect character and keep it pressed longer to delete large portions of text.

When the message exceeds 160 characters, it will be automatically broken into multiple parts. You can insert pictures, animations, ringtones, etc. in SMS. Anyway, the message can't be received or shown if it's not supported by the recipient's phone or by the network.

For sending SMS/MMS, dial the recipient's number or select it from the Phonebook. In Dual-SIM mode, you can choose whether to send SMS/MMS via SIM1 or via SIM2.

Inbox

This submenu shows the list of the messages received.

- **View:** view the message received.
- **Reply:** reply to the message received.
- **Call sender:** make a voice call to the message's sender.
- **Forward:** directly forward the message received.
- **Delete:** delete the message received.
- **Delete all:** delete all the messages in the **Inbox** folder.
- **Filter:** filter the messages received by SIM1 or by SIM2.
- **Mark several:** mark multiple messages simultaneously.

■ **Advanced:** available options: **Copy to phone/SIM**, **Move to phone/SIM**, **Copy all** and **Move all** (from SIM and from phone).

Drafts

Use the Drafts folder to save messages you're still working on, before you send them. You can send, edit, delete or apply the Advanced options to the messages saved in this folder.

Outgoing

When message sending is unsuccessful, the message will be saved in this folder. Anyway, it is possible to directly save the edited SMS in this folder; these messages (not yet sent) will show the field Phone Number as empty. All the messages in the **Outgoing** folder are subject to the usual options: **Send** (from SIM1 or SIM2), **Edit**, **Delete**, **Copy to phone/SIM**, **Move to phone/SIM**, **Copy all** and **Move all**.

Outbox

This submenu shows the list of the sent messages. When sending SMS/MMS you can select the option "**Save and send**"; the message will be saved in the "**Outbox**" folder. The available options are the same as for **Inbox**.

Junkbox

Unwanted messages are saved into this folder, where you can view them sorted also by contact name or by SIM card of reception.

Thread SMS

This section shows all the messages sent to/received from a particular contact in a chat-style (threaded) interface.

Delete messages

Delete messages globally, or selectively (received, drafts, sent, etc.).

Email

You need to create and activate an email account (option **E-mail account**) before sending or receiving emails.

■ **Write Email:** write a new email.

■ **Inbox:** view e-mail received.

■ **Outgoing:** view outgoing e-mail.

■ **Sent:** view sent e-mail.

■ **Drafts:** view saved drafts.

■ **Clear mailbox:** delete e-mail globally, or selectively (received, drafts, sent, etc.).

■ **Delete marked e-mails:** delete only the selected e-mails.

■ **Email accounts:** create and activate an email account. Please follows these steps to create a new account:

- Email address: insert your email address(usually something like [account@provider.it](#));
- Protocol: choose between POP3 and IMAP4, according to your provider type.
- Data account: select the WAP/WEB profile to be used in the connection via SIM1 or via SIM2, choosing it from the list of pre-loaded data account.
- Incoming server: insert the name of the server suggested by your email provider (usually something like "pop.provider.it" or "imap.provider.it")
- Outcoming Server: insert the name of the SMTP server suggested by your email provider (usually something like "smtp.operatore.it")
- User name: insert your own user name for your mailbox. Usually, it is something like "nameaccount" or "[nameaccount@provider.it](#)", it may vary from provider to provider and according to the type of account.
- Password: insert your own password for your mailbox (paying attention to capitals, minuscules, spaces, etc)
- Account name: insert a name to identify the new account.

After creating the new account, activate it with "**Options**".

From "**Options**" you can also edit all the inserted infos and customize account details as signature, security options (SSL/ports), etc

■ **Templates:** some ready-to-use templates are available, for various situations.

Broadcast messages

Activate this function to receive broadcast messages. These messages are sent to every device on a network and usually contain information as weather forecasts, traffic conditions, etc.

Templates

Some ready-to-use templates are available, for various situations (SMS and MMS).

Message settings

Use this submenu for setting text and multimedia message options (separately for SIM1 and SIM2).

■ **Profile settings:** set the SMS/MMS Center number before sending and receiving SMS e MMS.

Note: this number is provided by the network operator.

■ **Voicemail server:** set name and number for the voicemail server.

■ **Common settings**

- **Delivery report:** it is a notification sent to you that lets you know when your text message has been delivered to the recipient, and when.
- **Reply path:** when the receiver of your SMS responds, it knows what SMS gateway to send the reply back to. This option requires SMS Center support.
- **Save sent message:** a copy of each message that you send will be saved in the **Outbox** folder.
- **Memory status:** check here memory capacity on SIM card and Phone, related to the messages.
- **Preferred storage:** select the storage path for message files (Phone or SIM card).

SMS Timing Send

You can postpone sending the message, scheduling the sending at a particular date and time. You can also specify multiple recipients, set the repetition of sending, and choose which SIM to use.

Answering Machine messages

Here you can listen to answering machine messages stored in your phone's own internal memory. This feature allows to save money avoiding connection to mobile network operator's voicemail system.

Services

Services

The first sections of **Services** menu are reserved to network operator services (SIM1 and SIM2), and therefore they may vary according to the quantity and type of options available.

The next two sections are dedicated to **Internet service** and to **Licence manager**.

Internet service (WAP)

- **Homepage:** set the initial or main web page from where to start navigation.
- **Bookmarks:** save a link to a web page (**Google** already linked). Available options:
 - **Go to:** open the selected web page.
 - **View:** view bookmark details (title and web address).
 - **Edit:** edit the selected bookmark.
 - **Delete:** delete the selected bookmark.
 - **Delete all files:** delete all the bookmarks.
 - **Add bookmark:** manually add a bookmark (specify title and web address).
 - **Set as Homepage:** set the current web page as Homepage.
 - **Send bookmark:** send the selected bookmark as SMS, as MMS, via Bluetooth or as Email.
 - **New folder:** create a new folder.
 - **Copy:** copy to vBookmark (a folder of choice) or to external memory (Phone or Memory card).
 - **Move:** move to vBookmark (a folder of choice) or to external memory (Phone or Memory card).
 - **Memory status:** check the free space available for the bookmarks.
- **Input address:** manually add a web address.
- **Last web address:** go back to the last web page.
- **Recent pages:** show the last 10 web pages visited.
- **Service inbox:** get service infos from the network operator (e.g. head news referred to specific arguments, web links, etc.).
- **Settings:**
 - **Select SIM:** SIM1, SIM2 or Always ask.
 - **Profiles:** select an account from the list or add a new one. The selected account may be activate or edited. To edit an existing account or insert a new one, you need filling the following fields:
 - ✓ **Profile name:** choose a name.
 - ✓ **Homepage:** set the initial web page for this profile.
 - ✓ **Data account:** set the network ID.
 - ✓ **Connection type:** HTTP or WAP.
 - ✓ **User name:** insert user name, if required.
 - ✓ **Password:** insert password, if required.

- **Browser options** : clear cache, clear cookies or clear authentication infos.
- **Preferences**: set a time-out, show/hide pictures, enable/disable cache and enable/disable cookies.
- **Security settings**: view your list of trusted certificates.
- **Service message settings**: enable/disable push notifications, enable/disable service message loading, enable/disable messages from trusted addresses only (White List), build a White List.
- **Restore browser settings**: reset the browser to factory settings.

Licence manager

In this section you can view and manage all the licences that are required for each device or user to connect to the network services.

Chat

Chat

Two chat applications are pre-installed on the phone.

MSN

After launching the application, insert your ID for **MSN (Windows Live)**[™] and the password. Check with your mobile provider if the current settings are valid for accessing network with your SIM card.

YAHOO! Messenger

After launching the application, insert your ID for **Yahoo! Messenger**[™] and the password. Check with your mobile provider if the current settings are valid for accessing network with your SIM card.

Audio Player

Music

From this menu you can choose to play audio files saved stored on phone or on memory card. To download files from your PC, T-Flash card must be inserted on the phone; then shut down the phone and connect it to your computer with the USB cable; the computer will detect the mobile phone automatically as a Mass Storage device . Download the desired MP3 files in "**My Music**" folder of the Memory card, otherwise the audio file will not play. Audio Player supports MP3, MIDI and AMR formats. If the operating system of your PC is Windows 2000 or later, any driver is required.

This phone implements **SRS WOW HD**[™], a sound solution that improves the dynamic audio performance of compressed and uncompressed audio.

Options	Description
SRS WOW HD	SRS WOW HD software (developed by SRS Labs) enhances your audio to make it sound best through the speaker or ear plugs. SRS WOW HD allows for 9 different equalizer settings.
Refresh list	Refresh the playlist, according to the changes made in " My music" folder.
Settings	Player settings: storage path, enable/disable repeat mode, enable/disable shuffle mode and enable/disable background play. Display settings: enable/disable lyrics display.

Options available for the single audio files (Playlist; see Audio Player screen)

Options	Description
Play	Play the selected file.
SRS WOW HD	SRS WOW HD software (developed by SRS Labs) enhances your audio to make it sound best through the speaker or ear plugs. SRS WOW HD allows for 9 different equalizer settings.
Details	File name, channel, bitrate/audio sample rate, size, time, title, artist, album, genre, year.
Add to ringtones	Add the selected track to the ringtones.
Refresh list	Refresh the playlist, according to the changes made in " My music" folder.
Settings	Player settings: storage path, enable/disable repeat mode, enable/disable shuffle mode and enable/disable background play. Display settings: enable/disable lyrics display.

Audio Player screen allows you to access to the most common operations through **navigation keys, OK key, *** and **# keys**:



File manager

File manager

With File manager, you can manage the contents and properties of files and folders on your device memory and memory card.

[Phone] -- the storage path is the phone memory.

[Memory card] --the storage path is the memory card.

For each **storage path**, the available options are:

- **Open**: view the root directory.

- **Format:** formatting will remove all the data from memory card or phone, including the folders created by user. After formatting, you'll need to reboot the phone; **Audio** and **Images** folders will be automatically restored, and the folder **Photos** will be automatically created after the first shot.
- **Rename:** rename an existing folder.
- **Details:** display the free space and the total capacity of the selected drive.

From **root directory** of each storage path, the available options are:

- **Open:** open folder (Video, Audio, Music, Photos, Received, etc.)
- **New folder:** create a new folder in the root directory.
- **Rename:** rename an existing folder.
- **Delete:** delete an existing folder.
- **Sort by:** sort the folders by Name, Type, Time or Size, or let them unsorted.

Inside any **folder**, the files options available are the same already described in **MULTIMEDIA**, plus the following ones:

- **New folder:** create a new sub-folder.
- **Rename:** rename a file in the list.
- **Delete:** delete a file in the list.
- **Sort by:** sort the files by Name, Type, Time or Size, or let them unsorted
- **Mark several:** to select a list of files at one time.
- **Copy:** copy the file(s) in another folder.
- **Move:** move the file(s) in another folder.
- **Delete all files:** delete all the files in the current folder.
- **Details:** view the details of the selected file (date, size, copyright).

These options are available in all the folders, including user created folders.

Fun & Games

Fun and Games

Java

It is necessary to set the required configuration information to launch the applications, since almost all of Java applications need network access. For this reason, the configuration information will depend on the SIM card you are currently using.

Java applications

All the downloaded Java applications will be available on this menu.

Java settings

- **Java audio :** set the volume to level (values between 1 and 7) or turn it off.
- **Java backlight:** turn on/off the LCD backlight.
- **Java vibration :** turn on/off the vibration.
- **Heap size:** the maximum heap size is 1048576 bytes.

Java default security

You can choose between **Third party** security, **Untrusted domain**, **Restore default** and **Domain options** (enable/disable Third party and/or Untrusted domain).

Java network

You can select the SIM card (SIM1 or SIM2) to use in Java activities.

- **Activate SIM:** activate the selected SIM.
- **Select profile:** select the desired Java profile from the list.

Games

The phone comes with an embedded game (**Puzzle**). Please refer to the attached instructions (**Help**) for further details.

■ Games settings

Available settings:

- **BGM** : enable/disable Background music
- **Sound effect**: enable/disable the sound effects in the game.
- **Volume**: set the global volume level.

■ Impostazioni evento

È possibile stabilire uno o più eventi (risultati), al verificarsi dei quali sarà mostrato un testo scelto dall'utente e un'immagine o un'animazione selezionate dai propri archivi.

Organizer

Organizer

Calendar

With this function, you can set the alarm clock to keep track of your schedule and record your monthly schedule. Roll the highlight block to the desired date and then the current date will be highlighted in red. To view all memos of one day, press OK and see the schedule.

Available options:

- **View**: you can view the schedule of the date where the cursor is on, and set the time, date, content and whether to activate alarm on this schedule of today's. When editing the schedule, you can choose an alarm type with the left and right direction keys. In addition, you can have such operations as Delete, Delete and Add on the schedule.
 - **View all**: you can view the entire schedule of the date where the cursor is on and set the time, date, content and whether to activate alarm on this schedule. The options available are the same as the previous feature.
 - **Add event**: you can select the type of task to memorize (Reminder, Meeting, Course) and set start/end date and hour, subject of the task, activate/deactivate alarm, set the frequency for repeating, location and priority.
 - **Delete event**: you can delete the selected task.
 - **Jump to date**: you can move the cursor to the specified date on the calendar.
 - **Go to today**: you can move the cursor to the current date.
 - **Go to weekly/monthly view**: change the way the time is displayed on the calendar.
-

Tasks

With this option, you can quickly add and update tasks or memos for various events (date, phone call, anniversary, etc). It's also possible set an alarm, specify a reminder repetition (if the event is a repeating event), mark the task as complete.

If you have set an alarm for the memo, when the set time is reached, the mobile phone will ring and display the memo content.

The available options are: View, Add, Edit, Search, Delete, Delete overdue, Delete all, Jump to date, View uncompleted, Send vCalendar or Save as file.

Alarm

The time format for the alarm clock is identical to that of clock. When the mobile phone is off, the alarm clock can still work provided the battery is sufficient. The system has set 5 alarm clock options and the defaulted is off. You can activate one option or all options according to the actual demand. Every alarm clock option can set independent time and date. When the time is reached, the mobile phone will give out alert tone and flicker the current time on the screen. Press Stop to stop alarm clock; press Snooze, then the mobile phone will pause ringing and continue after a given time period.

If alarm time is reached but the mobile phone is switched off, then the mobile phone will be switched on automatically and ring. If Stop is pressed, then the mobile phone will ask you whether to switch on the mobile phone. Press "No" to switch off the mobile phone and "Yes" to register at the network and switch on the mobile phone.

World Clock

World Clock allows you to keep track of current time for major cities and time zones on a real world map. Press the navigation keys **left/right** to move your cursor across the map to highlight individual time zones. It's also available an option to enable/disable the daylight saving time for a foreign city.

Note

Note lets you write and save short text notes for many different purposes.

Calculator

- After inserting your first number, use the upper direction key for "+" and the lower direction key for "-", the left direction key for "x" and the right direction key for "÷", then insert your second number;
- Press the **Clear** key to clear the latest inputs or results digit by digit; press the **Clear** key long to clear all content or result;
- Press **"OK"** key to obtain the result.

Note: the precision of this calculator is limited and can be used for simple calculation.

Ebook reader

After starting the Ebook reader, you will get the list of the available ebooks (Bookshelf). If any ebook is currently available, select **Options** to access sub-menus **Update bookshelf** and **Global settings**.

After uploading some e-books, you can select one from the list, choose **Options** and access sub-menus:

- **Open ebook:** open the selected ebook.
- **Update bookshelf:** update ebooks list after additions and deletions.
- **Global settings:** set font size, enable/disable auto scroll, set scroll speed, enable/disable full screen mode, change the character encoding, set text alignment, select storage path.
- **Book info:** show information about the selected e-book.
- **Delete:** delete the selected ebook.
- **Delete all files:** delete all the e-books in the Bookshelf.
- **Sort by:** sort the ebooks by name, type, time, size, or let them unsorted.
- **Apply global settings:** apply the selected settings.
- **Help:** here you find instructions on how to use shortcuts for Ebook reader. Use **0** key to go to **Global settings** screen; use **1** key to open this same **Help**; use **2** key to add a bookmark; use **3** key to go to **"Find"** screen; use **4** key to go to **"Jump to"** screen; use **5** key to go to a bookmark; use **6** key to find the next instance of a word; use **7** key to toggle the auto scroll; use **8** key to delete a bookmark; use **9** key to toggle full screen mode.

After opening an ebook, you get the following **Options**:

- **Find/Find next:** search for a word inside the text.
- **Jump to:** move through texts to locate particular lines.
- **Go to bookmark:** display a list of bookmarks you have made in the text.
- **Add Bookmark:** add a bookmark on the current page.
- **Delete Bookmark:** delete a bookmark on the current page.
- **Book info:** show information about the current ebook.
- **Settings:** see the **Global settings** (above).
- **Apply global settings:** apply the selected settings.
- **Help:** see **Help** above.
- **Close:** close the current ebook.

Answering machine

The built-in Answering machine allows people to leave voice messages for you when you can't answer your phone. The recorded phone message are stored in the submenu **Messages left**.

From **Settings**, you can toggle on/off the answering machine, select the storage path, fix the pick up time, fix the record duration, use the default greeting message or select one from your audio files, enable/disable remote access using any DTMF telephone.

For remote access, with the above said option enabled, you need a DTMF (touchtone) telephone. When the answering machine has picked up the call, you'll hear the invitation to leave a message; at this point you shall digit "#" and then wait for the prompt to digit your password (**1234** as default).

Note: remote access supports listening only.

Settings

Settings

1. Dual SIM settings

In every moment you can choose the most appropriate setting for your SIM cards according to the situation:

- **Dual SIM open**
 - **Only SIM1 open**
 - **Only SIM2 open**
 - **Flight mode**
-

2. Phone settings

Time and date

- **Set home city:** select the town you want to use as reference point.

Note: this option has to be used together with Update with time zone; this update must be permitted by the network operator.

- **Set time/date:** set the current date and time, and enable/disable daylight saving.
- **Set format:** set the date and time format.
- **Update with time zone:** if enabled, this allows to update the current date and time automatically, according to the time zone you're in.
- **Auto update of date and time:** toggle on/off the automatic update of date and time. This updating doesn't affect alarm clock or calendar. The update must be supported by network operator.

Special note: please disable this option in all areas where the use of mobile phones is inhibited.

Note: if the battery is removed from the phone, or if the device is not used for a long time, it shall be necessary to set again date and time.

Schedule on/off

You can easily make a schedule when your phone will turn on or off (4 different time slots).

Language

You can select the desired language to use in the menu (italian, english, french, spanish, german).

Input text

You can select the desired language to use for messaging, and enable/disable T9 system for predictive text input.

Display

- **Wallpaper:** you can use as wallpaper some system images as well as user defined images (previously saved in Phone or Memory card).
- **Screen saver:**
 - **Settings:** enable/disable the screen saver, and fix the waiting time (5 sec., 15 sec., 30 sec. o 1 minute).

- **Select:** seven system screen savers are available as well as a user defined screen saver (previously saved in Phone or Memory card).
- **Power on display:** one system animation is preloaded; a user defined video can be loaded from Phone or Memory card.
- **Power off display:** one system animation is preloaded; a user defined video can be loaded from Phone or Memory card.
- **Show date and time:** enable/disable date and time display on the screen.
- **Show owner number:** enable/disable owner number display during calls, separately for both SIM cards.
- **Clock type:** two options are available for the clock shown in the screen: **Digital** or **Analog**.

Greeting text

Enable/disable the display of a greeting text (freely customizable) on startup.

Shortcuts

Add/remove elements from the list of functionalities that are accessible via keyboard shortcuts (see below).

Dedicated key

Create keyboard shortcuts for the most commonly used functions, assigning a function to each navigation key (up, down, left, right).

UART settings

Enable the UART settings on one of the two SIM cards.

Miscellaneous settings

Set the LCD backlighting, controlling the **Brightness** and the **Timer** (5 sec. ~ 1 minute).

3. User profiles

Your mobile phone is provided with multiple profiles so that you can customize some settings in different cases for different events. Firstly, choose a profile and then activate it. You can have such profiles as General, Meeting, Outdoor, Indoor, Silent, Vibration, Headset and Bluetooth.

The features of each profile can be edited to fit your needs as follows:

- **Tone settings:** to set the tones for Incoming Call (SIM1 and SIM2), Alarm, Power On, Power Off, SMS Message (SIM1 and SIM2), and Keypad.
- **Volume:** to set the volume of Ring Tone (SIM1 and SIM2) and Keypad Tone.
- **Alert Type:** you can choose the current ring mode among Ring only, Vibration only, Vibration and Ring, or Vibration then Ring (separately for SIM1 and SIM2).
- **Ring Type:** you can choose the current ring type among Single, Repeat and Ascending (separately for SIM1 and SIM2).
- **Extra Tones:** to enable/disable Warning Tone, Error Tone, Camp on Tone, SMS Repeat Tone and Connect Tone.
- **Answer Mode:** you can choose to use any key to answer a call.

After customizing the settings, choose "**Activate**" in "**Options**" to start the selected profile.

Nota: after inserting headset plug into the matching jack, the mobile phone will automatically change into Headset profile. Unplug the headset to return to the previous profile.

In standby state, you can press # key to switch to Silent profile and again to the previous profile.

4. Network settings

- **Network selection:** for each SIM you can decide between an automatic selection and a manual one.
- **Preferences:** for each SIM you can browse a list of networks where to register and assign a priority.

5. Security settings

- **SIM1 and SIM2 security settings:** you can set up the SIM card lock on your phone, so that it can't be used without a Personal Identification Number (PIN). When the lock is enabled, you must enter the PIN each time you turn the phone on. You also have the option to change the PIN.
- **Phone lock:** you can set up the phone lock, digiting the requested password (the default password is "1122"). When the lock is enabled, the phone will prompt you for your password before you can make or receive calls. Insert the default password (or a personal one; see below how to change the password) to unlock, and confirm.
- **Auto keypad lock:** you can activate here the Automatic keypad lock. The phone will automatically lock the keypad after a certain time (5, 30, 60 seconds or 5 minutes). Press "**Unlock**" (back key) and then "*" to unlock.
- **Change Password:** you can change here the password for the phone lock (the default password is "1122") with another one easier to remember and more secure. The new password has to be between 4-8 digits long.
- **Certificate manager:** you can use **Certificate Manager** to see details about your certificates, modify them, delete them, or request new ones.
- **Message and Call Firewall:** here you can set and enable (separately for each SIM) a Black List and a White List, for the text messages as well as for calls.

A **Black List** of contacts (phone numbers) allows everyone to call you or send messages to you, except for the members of the Black List.

When this access control function is active, a blacklisted caller will just hear busy tone all the time; later, you will get a network SMS alert (if allowed in your network services) informing you about the number of the caller who was trying to contact you.

Messages received from a blacklisted number will be automatically transferred to the **Junkbox** folder.

A **White List** of contacts allows nobody to call you or send messages to you, except for the members of the White List. When this access control function is active, a non-whitelisted caller will just hear busy tone all the time; later, you will get a network SMS alert (if allowed in your network services) informing you about the number of the caller who was trying to contact you.

Messages received from a non-whitelisted number will be automatically transferred to the **Junkbox** folder.

Regardless of White and Black list, you can also block the calls coming from anonymous callers or from callers not stored in the Phonebook.

- **Create a Black/White list for incoming calls:** select the SIM card of your choice, then "**Calls**", and add the contacts to the Black or White List.
- **Create a Black/White list for incoming messages:** select the SIM card of your choice, then "**Messages**", and add the contacts to the Black or White List.
- **Enable a Black/White list and the block for anonymous numbers or for numbers not stored in the Phonebook:** select the SIM card of your choice, then select:
 - **Calls > Settings > Status:** here you can enable/disable the firewall or customize its activation time in a 24-hours interval (**Settings**).
 - **Calls > Settings > Reject Mode:** here you can select which type of firewall to enable/disable: **Blacklist, Whitelist, Numbers not in phonebook, Anonymous numbers, Blacklist + Anonymous, Blacklist + Not in phonebook.**
 - **Messages > Settings > Status:** here you can enable/disable the firewall or customize its activation time in a 24-hours interval (**Settings**).
 - **Messages > Settings > Reject Mode:** here you can select which type of firewall to enable/disable: **Blacklist, Whitelist, Numbers not in phonebook, Blacklist + Not in phonebook.**

From "**Hide spam alert**" it is possible to enable/disable the alert (text and sound) for the messages transferred to the **Junkbox** folder.

- **Privacy firewall:** after digiting the phone password (the default password is "1122"), you can enable/disable from here the locking on Phonebook, Messages or Call History.

6. Connettività

Bluetooth

See "**Bluetooth**" paragraph for a detailed description of Bluetooth function.

Data account

Here you can find the most common **GPRS** settings. For each account, you can view, add or edit the following details: account name, APN, user name, password, authentication type, primary DNS and secondary DNS.

Note: please contact your network operator for further details about settings and connection charges. Network services may vary from provider to provider and are subject to change.

7. Restore factory settings

Reset your device to the original settings. The password required to perform this operation is "**1122**".

Coffer function

Insert ***0000#** (default value, freely editable) from stand-by screen and access a private area of your phone, where you will find the following options: **Coffer Phonebook, Coffer Messages, Coffer Call Log, Change Coffer Lock, Block Incoming Calls, and Password Reminder.**

Coffer function is useful for storing contacts, SMS, call logs, etc., which you prefer to conceal from others.

The Coffer password insertion works only from the standby screen.

The contacts saved in the Coffer and the SMS coming from them as well as the whole call log, will be stored in the coffer only, and no trace of them will be visible outside of it.

The features of Phonebook, SMS, MMS, etc. inside the coffer are quite the same of the corresponding items in the "public area" of your phone.

■ Coffer Phonebook

The Coffer phonebook stores up to 100 contacts. The contacts may be saved with their real names and real phone number, and, simultaneously, with nicknames and fake numbers. When receiving a call from a number inserted in this area, the phone will display the nickname of the caller, and his/her fake number.

✧ Add new contact

Here you can add name, number, nickname or fake number.

Note: if a fake name/fake number has been set up, it will be displayed for incoming calls, outgoing calls and SMS sent or received; otherwise it will be displayed "Unknown contact".

✧ Options

Add from Phonebook: you can add the contact details, retrieving them from the "public" Phonebook.

Memory status: show the current status of the phonebook memory (100 entries max.). The display format for the memory usage is "used/total".

Delete all contacts: delete all the contacts from the Coffer phonebook.

Incoming call tone mode: enable/disable the tone for the incoming calls of the Coffer area.

■ Coffer Messages

✧ Write message

Write a new text message, and send it via SIM1 or SIM2. Each message may be up to 160 characters in length. A message longer than 160 characters will be cut up into multiple messages of 160 characters each.

✧ Inbox

Here you can view the messages received (up to 20 SMS).

◆ **Reply:** reply the selected SMS.

◆ **Edit:** edit the SMS to forward it later.

◆ **Delete:** delete the selected SMS.

◆ **Delete all:** delete all the received SMS.

Note: when selecting a contact in Coffer area to send a SMS, only the contacts saved in the Coffer phonebook will be displayed.

Tip: if you receive new messages when the folder Inbox is full, the phone will automatically overwrite old messages.

- ✧ **Drafts**
Use the Drafts folder to save messages you're still working on, before you send them.
- ✧ **Outgoing**
When message sending is unsuccessful, the message will be saved in this folder.
- ✧ **Outbox**
This folder shows a list of sent messages (up to 10 SMS). When sending a message you can select the option "**Save and send**"; the message will be saved in the Coffers "**Outbox**" folder.
- ✧ **Coffer SMS Tone Mode**
Enable/disable the tone for the incoming SMS of the Coffers area.

■ Coffer Call Log

These logs contain records of missed calls, received calls and dialled calls with Coffers phonebook contacts (up to 30 records). From one of these lists, press **Send** key to call the selected number. Select **Delete call logs** to delete all the records.

Tip: if your phone displays a notification of missed call, press "Read" to immediately open the Missed calls list. If a fake name/fake number has been set up, it will be displayed in the call logs.

■ Change Coffer Lock

Use this option to change the Coffer password: digit the default password first, and then the new one for two times. For instance, digit ***0000#** first in the stand-by screen; then choose **Change Coffer Lock**, digit the old code "**0000**", and then the new one ("**1111**", for example). You will be required to enter your new password again, then the change will take effect. The next time you access the Coffers area, you'll have to digit ***1111#** in the stand-by screen.

Note: do not ever forget your Coffer lock; otherwise, you will be prevented from accessing the Coffers area and your data will be lost.

■ Block Incoming Calls

You can choose to block all the calls coming from Coffers area contacts.

■ Password Reminder

Use this option to save and store strictly personal numbers as bank accounts, credit cards, ATM codes, various passwords, etc. There are 5 entries allowed.

Text input

Text input methods

The mobile phone provides multiple convenient input modes, with support of other functions. Besides the standard mode, you have the opportunity to use the T9 method (set as default method), a system for predictive text entry.

Basic letter input

Choose between the modes "**T9 abc**", "**T9 Abc**", "**T9 ABC**", "**abc**", "**ABC**" e "**123**", and insert the desired characters with the keyboard.

Numeric input (123)

This mode is mainly used to input phone numbers etc. After "Numeric" method has been chosen, you can input digit into the place where the cursor is flickering.

Symbol input

To see the symbol list, press "*" key in the "**Write message**" screen. If you want to use one symbol, press the up/down/left/right keys to select it.

USB connection

Notices before use

- Always make sure you connect and stop any USB devices correctly.
- Never use Windows formatting command to format the mobile disk of the mobile phone; otherwise, it could be severely damaged.
- USB work environment:
 - Minimum Operating System: Windows 2000 / XP .
 - Other operating systems could require the installation of a USB driver for PC/phone connection.

Maintenance & Safety

Maintenance and Safety

Please read and observe the following information for a safe and proper use of your phone and to prevent damage. Keep this User Guide in an easy to find place. When you need a quick reminder on how to respond to a particular situation, go to the relevant section for the information you need.

Post-sale service

For details, please refer to the Guarantee Certificate or Warranty Card inside the box.

Charger and adapter

Charger & External Power Adapter Safety Tips

Charger and adapter are designed for indoor use only. Do not use them in wet environments.

Battery Information and Care

Battery Safety Tips

- Please dispose of your battery properly.
- Do not disassemble or short-circuit the battery.
- Keep the battery's metal contacts clean.
- Recharge the battery after long periods of non-use to maximize battery life.
- Battery life could vary due to usage patterns and environmental conditions.
- The self-protection function of the battery cuts the power of the phone when its operation is in an abnormal status. In this case, remove the battery from the phone, reinsert it, and turn the phone on.

General Notice

General Notice

- Using a damaged battery or placing a battery in your mouth may cause serious injury.
- Do not place items containing magnetic components such as a credit card, phone card, bank book, or subway ticket near your phone. The magnetism of the phone may damage the data stored in the magnetic strip.
- Talking on your phone for long period of time may reduce call quality due to heat generated during use.
- When the phone is not used for a long period time, store it in a safe place with the power cord unplugged.
- Using the phone in proximity to receiving equipment (i.e. TV or Radio) may cause interference to the phone.
- Do not immerse your phone in water. If this happens, remove the battery and take it to nexian Authorized Service Center.
- Do not paint your phone.
- The data saved in your phone might be deleted due to careless use, repair of the phone, or upgrade of the software. Please backup your important phone numbers. (Ring tones, text messages, voice messages, picture, and videos could also be deleted.) The manufacturer is not liable for damage due to the loss of data.
- Do not turn your phone on or off when the device is close to your ear.

Troubleshooting

Troubleshooting

Problems	Possible Causes
Unable to switch on	<ol style="list-style-type: none"> Does the battery have enough electrical power? Is the battery placed correctly?
SIM failure	<ol style="list-style-type: none"> The SIM card is dirty. Clean it. Reinstall the SIM card. The SIM card is damaged. Replace it.
Poor signal	Check the signal strength icon on the screen. If the icon contains 4 bars, the signal is at its strongest; if it is below 1 bars, the signal is very poor.
Unable to dial out	<ol style="list-style-type: none"> Maybe you have set Hide My Caller ID but your network operator does not provide this service for you. There are lots of interference sources in your neighborhood. Maybe you have activated some call restriction function.
Unable to charge the battery	<ol style="list-style-type: none"> The battery may be over-discharged; so it requires a longer charging period than normal. Its performance has got worse; it is necessary to replace the battery.
Unable to register to the network	<ol style="list-style-type: none"> Too weak signals or strong interferences. SIM card not properly installed. Bad contact or SIM card damaged. If the SIM card is broken, please contact the network operator to replace it.
Photos taken are too dark	<ol style="list-style-type: none"> Brightness is set too low. Ambient light is poor.
Photos taken are unclear	<ol style="list-style-type: none"> Check if your subject is moving too fast. Maybe the phone slightly moved while the shutter was open.
Photos taken are distorted	The subject may be too close for the camera lens.
Service menu is not accessible	Maybe your SIM card doesn't support Services function.
The picture selected as wallpaper is only partially visible	The size of the photo is probably too large. The recommended size is 320x240.

Abbreviations

SMS	Short Message Service
MMS	Multimedia Message Service
EMS	Enhanced Message Service
SIM	Subscriber Identity Module
GSM	Global System for Mobile Communication
PIN	Personal Identity Number
PUK	PIN Unblocking Key
IMEI	International Mobile Equipment Identity

CSD	Circuit Switched Data
APN	Access Point Name
CB	Cell Broadcast
GPRS	General Packet Radio Service
Card 1	SIM Card principale (la card inserita nello slot SIM1)
Card 2	SIM Card secondaria (la card inserita nello slot SIM2)

Certifications

Certifications

Declaration of Conformity (R&TTE)



We, NGM Italia declare under our sole responsibility that the product identified as

GSM Mobile Phone : **Class**

conforms to the following standards and specifications:

Health	EN 50360, EN 62209-1
Safety	EN 60950-1+A11
EMC	EN 301 489-1/-7/-17
Radio	EN 301 511 EN 300 328

We declare that [all the series of fundamental radio test have been conducted and that] the aforesaid product meets all the essential requirements of the Directive 1999/5/EC.

The conformity assessment procedure referred to in Article 10 and detailed in Annex IV of Directive 1999/5/EC has been followed with the involvement of the following notified bodies:



PHOENIX TESTLAB GmbH
Königswinkel 10, D-32825 Blomberg, Germany

All technical documents conserved at NGM Italia S.r.l.
Available on request.
(UE Authorized Representative)
NGM Italia S.r.l.
Via L. Da Vinci, 7 - Ponticelli
56020 Santa Maria a Monte (Pi)

SAR certification information (Specific Absorption Rate)

This phone meets European Union (EU) requirements concerning exposure to radio waves coming from telecommunication and radio devices. The exposure standard for mobile phones employs a unit of measurement known as SAR (Specific Absorption Rate).

The SAR limit recommended by the EU Council is 2.0 W/kg averaged over ten grams of body tissue.

The highest SAR value for this model phone when tested for use at the ear was 0,957 watt /kg. Although the SAR is determined at the highest certified power level, the actual SAR of the phone while operating can be well below the maximum value. This is because the phone is designed to operate at multiple power levels so as to use only the power required to reach the network. In general, the closer you are to a base station, the lower the power output of the phone. The Declaration of Conformity here above proves that the designated product is in compliance with the essential requirements and other relevant provisions of the R&TTE - Directive (European Radio & Terminal Telecommunications Equipment)1999/5/EC