

nuu
mobile



F4L

User Manual

Table of Contents

1. Overview
2. Setting up your phone
3. Settings
4. Calls
5. Contacts
6. Messaging
7. Camera
8. Gallery

F4L Overview

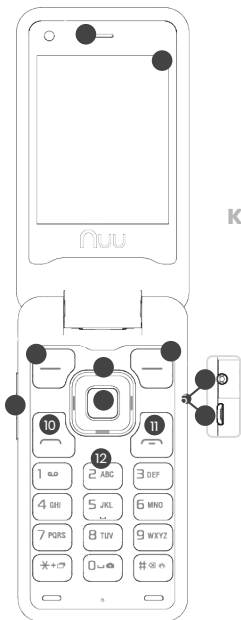

- Earpiece
- LCD Screen
- Volume Control
- AUX-In/
Headset Jack
- Micro-USB
Connector

Keypad

- Left Soft Key
- Right Soft Key
- Navigation Pad
- Center Soft Key
- 10 Phone Key
- 11 End/Power Key
- 12 Number Pad
 - a. Press & Hold 1 for voicemail
 - b. Press & Hold # to change between normal mode & vibrate mode
 - c. Press & Hold * to display recent tasks
 - d. Press & Hold 0 for camera

Setting Up Your Phone

Follow these step-by-step instructions to set up your F4L. Power off the phone **before** inserting any cards!

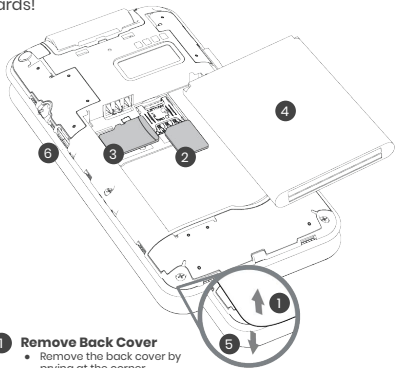

- 1 Remove Back Cover**
 - Remove the back cover by prying at the corner
- 2 Insert Sim**
 - Orient SIM card to match diagram on slot.
 - SIM supports 4G LTE connections.
- 3 Insert microSD Memory Card (Optional)**
 - Remember to power off the phone and remove battery before inserting memory card.
- 4 Insert the Battery**
 - Align the battery contacts, then insert the battery contacts-first.
- 5 Replace Back Cover**
 - After installing the SIM card, memory card, and battery, align the cover and snap it closed. Be sure to press around all the edges to ensure a secure fit.
- 6 Charge/Sync**
 - Plug in the Micro-USB connector to charge the phone or transfer data.

Warning:

SIM cards are small enough to become a choking hazard, so please keep them away from children & pets. SIM cards are also quite delicate. Please be careful when handling your card.

Settings

To access Settings, press the Center Soft Key from the home screen and select Settings

Network & Internet

Here you can enter Airplane mode, see a list of available WiFi networks, monitor data usage, and turn on Hotspot or tethering

Connected Devices

Connect to external Bluetooth devices

Battery

See remaining battery and other battery usage statistics

Display

Adjust brightness level, change background wallpaper, and adjust the display sleep settings

Sound

Adjust Media, Alarm and Ring Volume using the Navigation Pad

Storage

View used storage on both the device and a portable SD card (when installed)

Security & Location



Security settings such as screen lock, SIM Card lock and location permissions.







Calls

Making a call

Dialing - From the home screen, use the Number Pad to dial the number and press the green Phone Key 

Call History - Access your call history by pressing the green phone key.  Use the Number Pad to view all calls or missed calls. Press the green Phone Key  to place a call to the selected number

Contacts - Press the Center Soft Key  to access the App list. Select Contacts and use the Navigation Pad  to locate the contact. Press the Center Soft Key  to display the contact information. Select the number you wish to call and press the Phone key  to call.

Answering a call

To answer an incoming call simply flip open the phone. By default, opening the phone will answer the call and closing the phone will end the call. This can be changed by opening the phone app and selecting **Menu > Settings > Call settings**

Ending a call



Press the red End/Power Key  to end the call.

Contacts



Adding a contact

Press the Center Soft Key  to list all apps and then select Contacts. Select Create New Contact. Then chose if you want to save the contact to the phone itself or to the SIM Card. When you are done entering the information, scroll all the way up to the top, and select the three dots icon and then select Save.

Deleting a contact

Press the Center Soft Key  to list all apps and then select Contacts. Highlight the contact you want to delete and then press and hold the Center Soft Key.  Highlight the Trash Can icon and then press the Center Soft Key  to delete.

Messaging

Press the Center Soft Key  to list all apps and then select Messaging. Press the Left Soft Key  to create a new message. Type in the phone number or the name of the contact you wish to send a message to and then compose your message in the Type text message box. When your message is complete, select the Send Arrow and press the Center Soft Key. 

Press the pound sign # to switch input methods:

- KT9: Predictive Word Mode
- en: lowercase
- En: Sentence Case
- EN: All Caps
- 123: Numeric

If you'd like to send a picture or a video you can select the paperclip icon and choose the type of attachment to send.

Camera

To open the Camera app, press the Center Soft Key, use the Navigation Pad to highlight the Camera app and press the Center Soft Key to open.

*You can also access the camera by pressing and holding the 0 key on the Number Pad.

Press the Center Soft Key to take a picture. If you want to switch to video, use the Navigation Pad to select the Video option in the lower right-hand corner, and press the Center Soft Key to confirm.

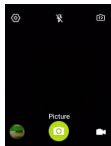

There are 3 icons across the top. Settings, Flash and Selfie

The Settings section is where you can customize the camera settings such as adding a timer, adjusting the white balance, and changing the picture file size.

The Flash settings allow you to turn the flash on, off, or on automatic.

The Selfie button switches to the front facing cam.

To view the Gallery, select the circular icon in the lower left hand of the screen.



Gallery



The Gallery is your collection of photos and videos to view, edit, share or delete.

To access the Gallery from within the Camera app, select the Gallery icon in the lower left hand corner.



You can also access the Gallery from the list of all apps.

Within the Gallery App:

Use the Navigation Pad  to highlight an image or video, and then press the Center Soft Key  to view. With an image selected, press the Left Soft Key  to bring up your available options such as Delete or Share

