



User Manual

Refrigerator-Freezer

HRF520BW

HRF520BS

HRF520BHS

HRF520FS

HRF520FHS

Haier

Thank you for purchasing a Haier Product.

Please read these instructions carefully before using this appliance. The instructions contain important information which will help you get the best out of the appliance and ensure safe and proper installation, use and maintenance.

Keep this manual in a convenient place so you can always refer to it for the safe and proper use of the appliance.

If you sell the appliance, give it away, or leave it behind when you move house, make sure you also pass on this manual so that the new owner can become familiar with the appliance and safety warnings.

Legend

Warning – important safety information



General information and tips



Environmental information



Disposal

Help protect the environment and human health. Put the packaging in applicable containers to recycle it. Help to recycle waste of electrical and electronic appliances. Do not dispose appliances marked with this symbol with the household waste. Return the product to your local recycling facility or contact your municipal office.



WARNING!

Risk of injury or suffocation!

Refrigerants and gases must be disposed of professionally. Ensure that the tubing of the refrigerant circuit is not damaged before being properly disposed of. Disconnect the appliance from the mains supply. Cut off the mains cable and dispose of it. Remove the trays and drawers as well as the door catch and seals, to prevent children and pets from getting closed in the appliance.

Content

Intended Use	5
Safety	6
Product Description	10
Use	14
Equipment	24
Care and Cleaning	27
Troubleshooting	29
Installation	32
Technical Data	37

Intended use

This appliance is intended for cooling and freezing food. It has been designed exclusively for use in dry-interior house holds. It is not intended for commercial or industrial use.

Changes or modifications to the device are not allowed. Unintended use may cause hazards and loss of warranty claims.

Accessories

Check the accessories and literature in accordance with this list:

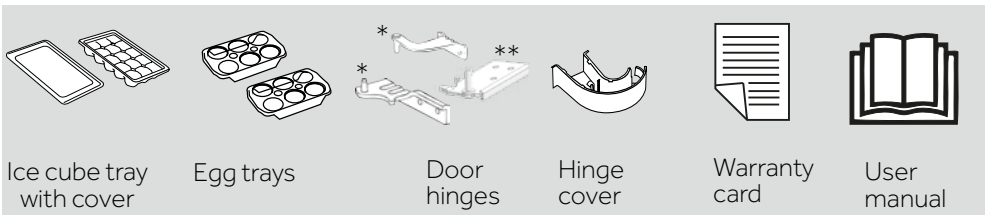

Notice

Due to technical changes and different models, some of the illustrations in this manual may differ from your model.

This appliance is intended to be used in household and similar applications such as:

- staff kitchen areas in shops, offices and other working environments;
- farm houses and by clients in hotels, motels and other residential type environments;
- bed and breakfast type environments;
- catering and similar non-retail applications.

Before switching on the appliance for the first time do...

- ▶ make sure there is no transport damage.
- ▶ make sure all packaging is removed and is kept out of children's reach.
- ▶ wait at least two hours after installing appliance before using to ensure refrigerant circuit is fully efficient.
- ▶ handle the appliance always with at least two persons because it is heavy.
- ▶ install the appliance in a well-ventilated place. Ensure a space of at least 5cm above and 5cm around the appliance. Install and level the appliance in an area suitable for its size and use.
- ▶ keep ventilation openings in the appliance or in the in-built structure clear of obstruction.
- ▶ make sure that the electrical information on the rating plate agrees with the power supply. If it does not, contact an electrician.
- ▶ consider that the appliance is operated by a 220~240 VAC/50 Hz power supply. Abnormal voltage fluctuation may cause the appliance to fail to start or not to operate correctly and damage the temperature control or compressor, originating abnormal noise too. To eliminate abnormal fluctuation it is suggested to use an automatic regulator.
- ▶ use a separate earthed socket for the power supply which is easily accessible. The appliance must be earthed. Make sure the plug is easily accessible.
- ▶ ensure that the power cable is not trapped by the refrigerator. Do not step on the power cable.



WARNING!

Make sure not to damage the electric cable and the plug. If damaged it must only be re-placed by either the manufacturer or the authorised service agent.

Before switching on the appliance for the first time do not...

- x install the appliance in direct sunlight or near sources of heat (eg stoves, heaters).
- x damage the refrigerant circuit. If it does become damaged, do not use the appliance.
- x use multi-plug adapters and extension cables.

During daily use do...

- ▶ ensure this appliance is only used by adults or those aged over 8 years of age. People with reduced physical, sensory or mental capabilities should be supervised or be instructed how to use in a safe way and understand hazards involved.
- ▶ keep away children under 3 years of age from the appliance unless they are constantly supervised.
- ▶ make sure children are not playing with the appliance.
- ▶ make sure children are supervised if they carry out cleaning and maintenance.
- ▶ hold the plug, not the cable, when unplugging the appliance.
- ▶ replace a damaged supply cord only by the manufacturer, its service agent or similarly qualified persons in order to avoid a hazard.
- ▶ follow these instructions if coal, gas or other flammable gas is leaking in the vicinity of the appliance: turn off the valve of the leaking gas, open the doors and windows and do not unplug or plug in the power cable of the appliance or any other appliance.
- ▶ open and close the doors only with the handles. The gap between the doors and between the doors and the cabinet is very narrow. Do not extend your hands in these areas to avoid pinching your fingers. Open or close the refrigerator doors only when there are no children standing within the range of door movement.
- ▶ disconnect the appliance from the electrical supply before undertaking any routine maintenance. Allow at least 5 minutes before restarting the appliance, as frequent starting may damage the compressor.
- ▶ eliminate the dust on the back of the unit at least once in the year to avoid hazard by fire, as well as increased energy consumption.
- ▶ notice that the product is set for operation at a specific ambient range between 10 and 43°C. The appliance may not work properly if it is left for a long period at a temperature above or below the

indicated range.

- ▶ check the condition of food if an increase in the freezer temperature has occurred.

During daily use do not...

- x set unnecessarily low temperature in the refrigerator compartment. Minus temperatures may occur at high settings. Attention: bottles can burst.
- x store medicines which need a precision storage temperature or bacteria or chemical agents in the appliance.
- x store liquids in bottles or cans (besides high percentage spirits) especially carbonated beverages in the freezer, as these will burst during freezing.
- x place unstable articles (heavy objects, containers filled with water) on the top of the appliance, to avoid personal injury caused by falling or electric shock caused by contact with water.
- x pull on the door shelves. The door may be pulled slant, the bottle rack, may be pulled away, or the appliance may topple.
- x damage the refrigerant circuit. If it does become damaged, do not use the appliance.
- x step on the freezer storage compartment door or drawer.
- x touch the inside surface of the freezer storage compartment when in operation, especially with wet hands, as your hands may freeze onto the surface.
- x touch frozen goods with wet hands (wear gloves). Especially do not eat ice lollies immediately after removal from the freezer compartment. There is the risk to freeze or the formation of frost blisters. First aid: keep immediately under running cold water. Do not pull away!
- x scrape off frost and ice with sharp objects. Do not use sprays, electric heaters, hair dryers, steam cleaners or other sources of heat in order to avoid damage to the plastic parts.
- x use mechanical devices or other means to accelerate the defrosting process, other than those recommended by the manufacturer.
- x clean the appliance with hard brushes, wire brushes, detergent powder, petrol, amyl acetate, acetone and similar organic solutions, acid or alkaline solutions. Please clean with special refrigerator detergent to avoid damage.
- x spray or flush the appliance during cleaning.

- x use water spray or steam to clean the appliance.
- x clean the cold glass shelves with hot water. Sudden temperature change may cause the glass to break.
- x use electrical devices inside the food storage compartments of the appliance, unless they are of the type recommended by the manufacturer.
- x try to repair the appliance by yourself. In case of repair please contact our customer service.
- x store explosive substances such as aerosol cans with a flammable propellant in this appliance.



WARNING!

Do not store or use flammable, explosives or corrosive materials in the appliance or in the vicinity.

Refrigerant gas information



WARNING!

The appliance contains the flammable refrigerant isobutane (R600a). Make sure the refrigerant circuit is not damaged during transportation or installation. Leaking refrigerant may cause eye injuries or ignite. If a damage has occurred, keep away open fire sources, thoroughly ventilate the room, do not plug or unplug the power cords of the appliance or any other appliance. Inform the customer service.

If eyes come into contact with the refrigerant, rinse immediately under running water and call immediately the eye specialist.

It is hazardous for anyone other than an Authorised Service Person to service this appliance.

In Queensland - the authorised service person **MUST** hold a gas work authorisation for hydrocarbon refrigerants to carry out servicing or repairs which involve the removal of covers.

Product Description

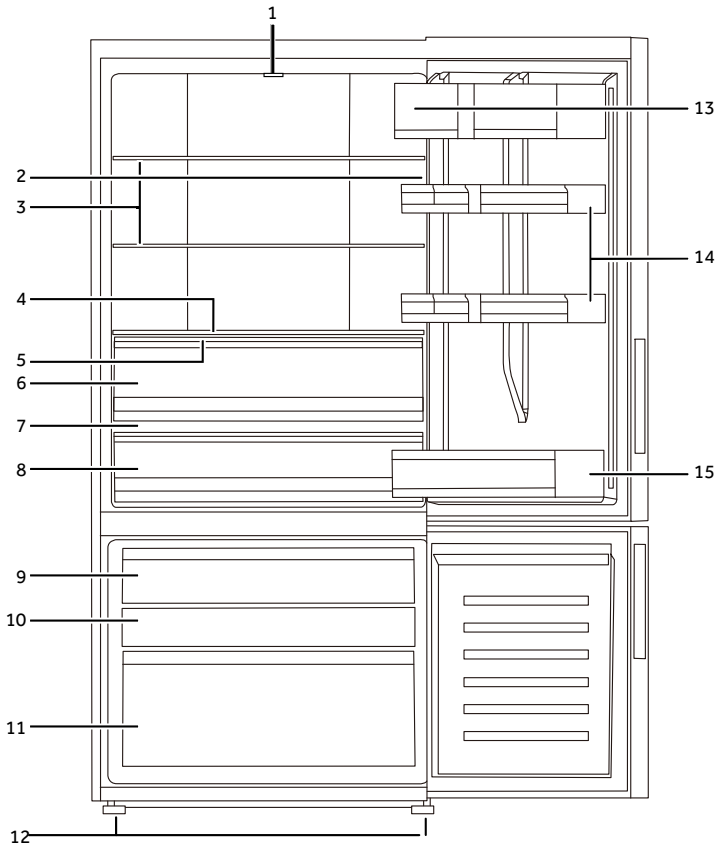

(HRF520BW HRF520BS)

- | | |
|---------------------------------|----------------------------------|
| 1 Refrigerator LED lamp | 9 Upper freezer storage drawer |
| 2 Rating plate | 10 Middle freezer storage drawer |
| 3 Glass shelves | 11 Lower freezer storage drawer |
| 4 Fresh storage box cover | 12 Adjustable feet |
| 5 HCS (Humidity Control System) | 13 Upper door dairy bin |
| 6 Fresh storage box | 14 Middle door shelves |
| 7 My Zone glass cover | 15 Bottom door shelf |
| 8 My Zone box | |

Product Description

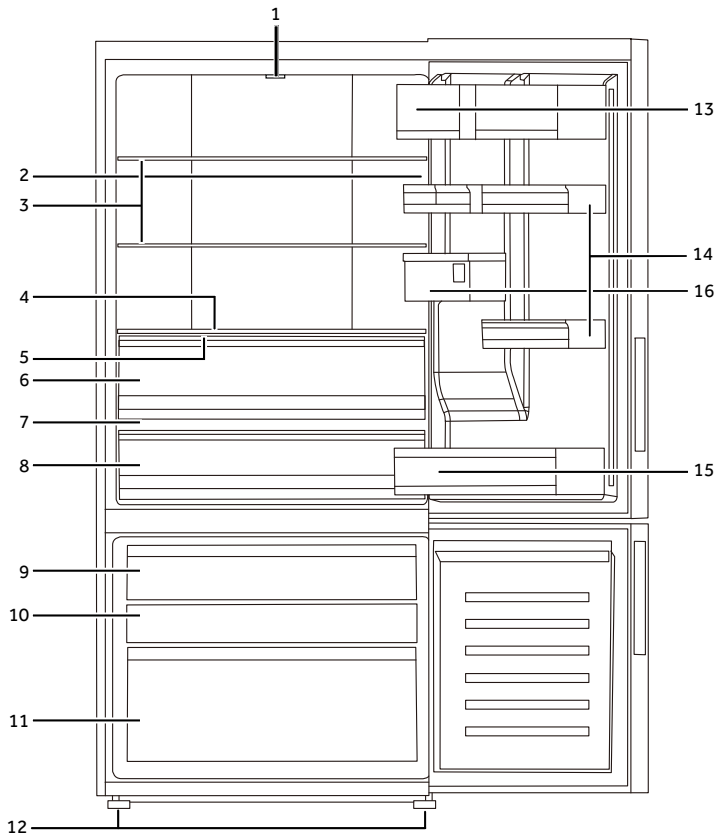

(HRF520BHS)

- | | |
|---------------------------------|----------------------------------|
| 1 Refrigerator LED lamp | 9 Upper freezer storage drawer |
| 2 Rating plate | 10 Middle freezer storage drawer |
| 3 Glass shelves | 11 Lower freezer storage drawer |
| 4 Fresh storage box cover | 12 Adjustable feet |
| 5 HCS (Humidity Control System) | 13 Upper door dairy bin |
| 6 Fresh storage box | 14 Middle door shelves |
| 7 My Zone glass cover | 15 Bottom door shelf |
| 8 My Zone box | 16 Water tank |

Product Description

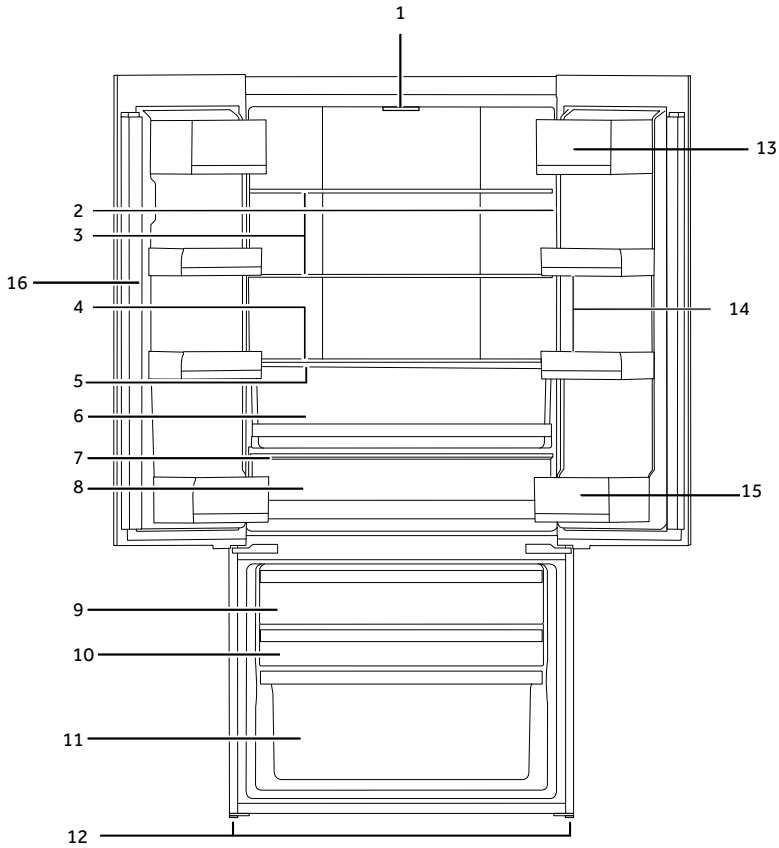

HRF520FS

1 Refrigerator LED lamp

2 Rating plate

3 Glass shelves

4 Fresh storage box cover

5 HCS (Humidity Control System)

6 Fresh storage box

7 My Zone glass cover

8 My Zone box

9 Upper freezer storage drawer

10 Middle freezer storage drawer

11 Lower freezer storage drawer

12 Adjustable feet

13 Upper door dairy bin

14 Middle door shelves

15 Bottom gallon door shelf

16 Door flapper

Product Description

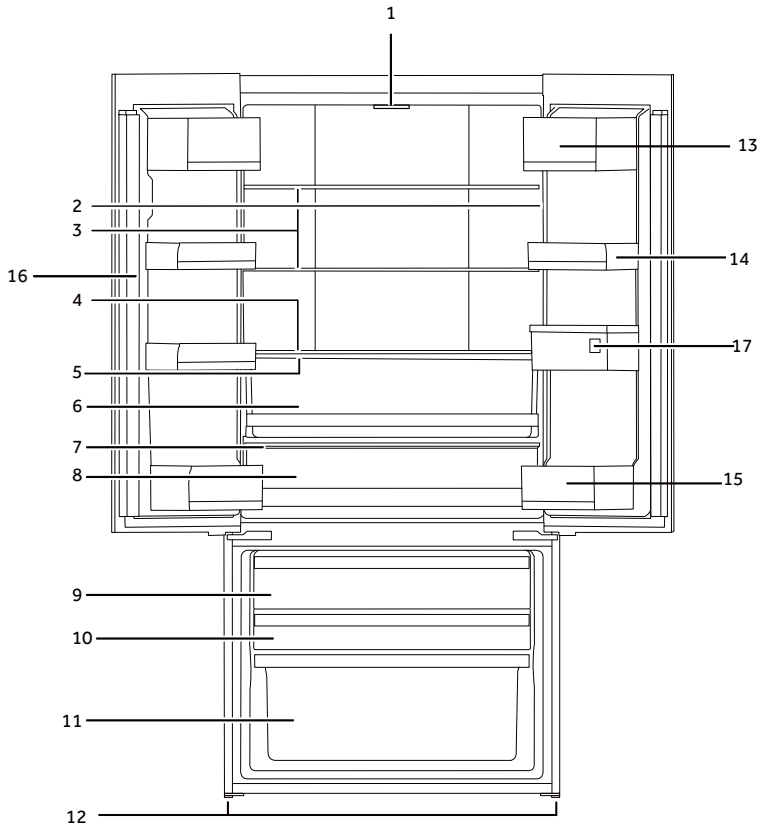

HRF520FHS

- | | |
|---------------------------------|----------------------------------|
| 1 Refrigerator LED lamp | 9 Upper freezer storage drawer |
| 2 Rating plate | 10 Middle freezer storage drawer |
| 3 Glass shelves | 11 Lower freezer storage drawer |
| 4 Fresh storage box cover | 12 Adjustable feet |
| 5 HCS (Humidity Control System) | 13 Upper door dairy bin |
| 6 Fresh storage box | 14 Middle door shelves |
| 7 My Zone glass cover | 15 Bottom gallon door shelf |
| 8 My Zone box | 16 Door flapper |
| | 17 Water Tank |

Before first use

- ▶ Remove all packaging materials, keep them out of children`s reach and dispose them in an environmentally friendly manner.
- ▶ Clean the inside and outside of the appliance with water and a mild detergent before putting any food in it.
- ▶ After the appliance has been levelled and cleaned, wait for at least 2 hours before connecting it to the power supply. See INSTALLATION.
- ▶ Precool the compartments at high settings before loading with food. The function Super Cool and Super Freeze help to cool down the compartments quickly.
- ▶ The refrigerator temperature and freezer temperature are automatically set to 3°C and -18°C respectively. These are the recommended settings. If desired, you can change these temperatures manually. Please see FUNCTIONS.

Control panel

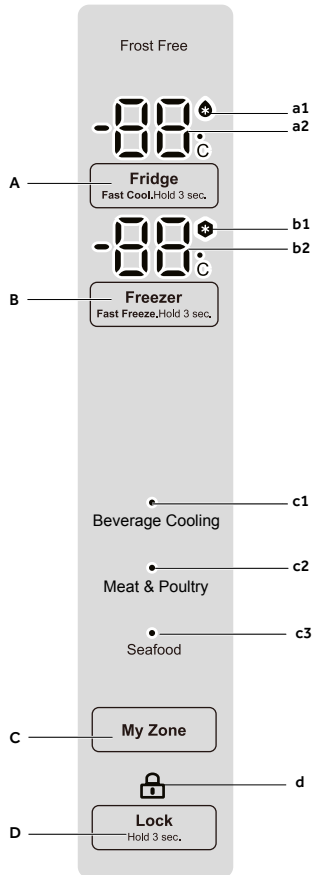

Buttons:

A. Fridge selector

B. Freezer selector

C. My Zone selector

D. Panel lock selector

Indicators:

a1. Super Cool function

a2. Temperature fridge

b1. Super Freeze function

b2. Temperature freezer

c1. Beverage Cooling function

c2. Meat & Poultry function

c3. Seafood function

d. Panel lock

Sensor keys

The buttons on the control panel are sensor keys, which respond when lightly touched with the finger.

Switch on/off the appliance

The appliance is in operation as soon as it is connected to the power supply.

When the appliance is powered on for the first time, indicator "b2" is shining on the display until the temperature reaches -5°C or after 1 hour working. The temperatures displayed in "a2" and "b2" will show the actual temperatures in the compartment.



Notice

- ▶ The appliance is preset to the recommended temperature of 3°C (refrigerator) and -18°C (freezer). Under normal ambient conditions you need not set a temperature.
- ▶ When the appliance is switched on after disconnection from the main power supply, it may take up to 12 hours for the correct temperatures to be reached.

Empty the appliance before switching off. To switch off the appliance, pull the power cord out off the power socket.

Standby-mode

The display screen turns off automatically 30 seconds after pressing a key. The display will be automatically locked. It lights up automatically when pressing any key or opening the door (alarm does not light up the display screen).

Lock/unlock panel

- ▶ Touch button "D" for 3 seconds to block all panel elements against activation. The related indicator "d" is now displayed.
- ▶ To unlock, press button "D" again.



Notice

The control panel is automatically blocked against activation if after 30 seconds no button is pressed. To change any settings the control panel must be unlocked.

Door/drawer opening alarm

When the refrigerator door or the freezer drawer is opened for more than 3 minutes, the door/drawer opening alarm will sound. The alarm can be silenced by either closing the door/drawer. If the door/drawer is left open for more than 7 minutes, the light inside the refrigerator/under the refrigerator door and control panel illumination will automatically switch off.

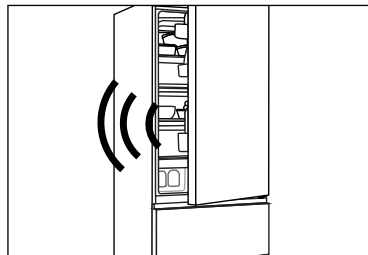

Adjust the temperature

The internal fridge/freezer temperatures are influenced by the following factors:

- ▶ ambient temperature;
- ▶ frequency of door opening;
- ▶ amount of stored foods;
- ▶ installation of the appliance;

Adjust the temperature for fridge

1. Unlock the panel if it is locked.
2. Press button "A" (Fridge) to select the fridge compartment. Indicator "a2" is flashing.
3. Press button "A" to set the refrigerator temperature. The temperature increases in sequences of 1°C from a minimum of 2°C to a maximum of 8°C, switching to 2°C again when pressing further. The optimum temperature in the refrigerator is 5°C. Colder temperatures mean unnecessary energy consumption.
4. Press any key except "A" to confirm, or the setting confirms automatically after 5 seconds. Indicator "a2" stops flashing.

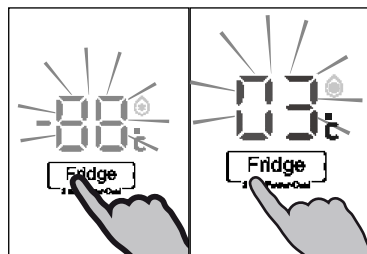

Adjust the temperature for freezer

1. Unlock the panel if it is locked.
2. Press button "B" (Freezer) to select the freezer compartment. Indicator "b2" is flashing.
3. Press button "B" (Freezer) to set the freezer temperature. The temperature increases in sequences of 1°C from a minimum of -14°C to a maximum of -24°C, switching to -14°C again when pressing further.

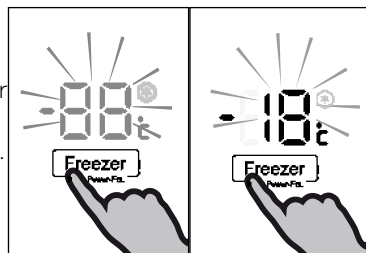

The optimum temperature in the freezer is -18°C . Colder temperatures mean unnecessary energy consumption.

4. Press any key except "B" (Freezer) to confirm, or the setting confirms automatically after 5 seconds. Indicator "b2" stops flashing.

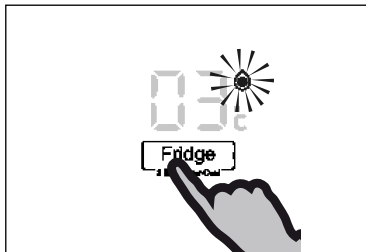

Super Cool function

Switch on the Super Cool function if larger quantities of food need to be stored (for example after the purchase). The Super Cool function accelerates the cooling of fresh food and protects the goods already stored from undesirable warming. The factory setting temperature is $+2^{\circ}\text{C}$.

1. Unlock the panel if it is locked.
2. Press button "A" (Fridge) for 3 seconds. Indicator "a1" illuminates and the function is activated.
3. The same operation can exit Super Cool function.



Notice

This function will be automatically disabled after 3 hours.



Super Freeze function

Fresh food should be frozen as quickly as possible to the core. This preserves the best nutritional value, appearance and taste. The Super Freeze function accelerates the freezing of fresh food and protects the goods already stored from undesirable warming. If you need to freeze a large amount of food once, it is recommended to turn the Super Freeze function on 24h before needing to use.

1. Unlock the panel if it is locked.
2. Press button "B" (Freeze) for 3 seconds. Indicator "b1" illuminates and the function is activated.
3. The same operation can exit Super Freeze function.



Notice

The Super Freeze function will automatically switch off after 56 hours. The appliance is then operated at the previously set temperature.

My Zone drawer

The fridge compartment is equipped with a My Zone drawer. In accordance with the food's storage demands, the most suitable function can be selected to get the optimal nutritional value of the foods. The following functions are available:

- ▶ **Beverage Cooling** (2-4°C). This function is suitable to cool beverages like beer, soft-drinks, yogurts, etc.

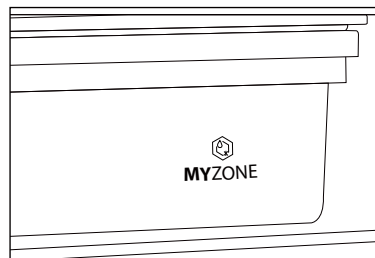

i Notice

The Beverage Cooling function has a temperature range of 2-4°C. This has been designed to store drinks at a cold temperature for consumption. It is also suitable to store some fruits and vegetables that will not be damaged at this temperature. Please note cold-sensitive fruits like pineapple, avocado, bananas, grapefruits and vegetables such as potatoes, aubergines, beans, cucumbers, zucchini and tomatoes and cheese should not be stored in the My Zone drawer.

- ▶ **Meat & Poultry** (0°C). This function is suitable to store fresh food such as meat or poultry for immediate consumption. Most foods stay fresh at 0°C, but not frozen.
- ▶ **Sea Food** (-1°C). This function is suitable to store fresh seafood such as fish and mussels.

i Notice

Due to the different water content within different types of meat or seafood, on occasions it may occur that some food will experience freezing to a degree when stored at temperature of 0°C or below. Freshly cut meat should be stored in the My Zone drawer.

Please do not store fruit and vegetables in the Meat & Poultry or Seafood functions. Due to the high water content of fruits and vegetables, it is likely they will experience some freezing and be damaged. It is easy to freeze the fruit and vegetables.

Select the function for My Zone drawer

1. Unlock the panel if it is locked.
2. Press button "C" to select the My Zone function.
Beverage Cooling "c1" light.
Meat & Poultry "c2" light.
Seafood "c3" light.
3. Press any key except "C" (My Zone) to confirm, or the setting confirms automatically after 5

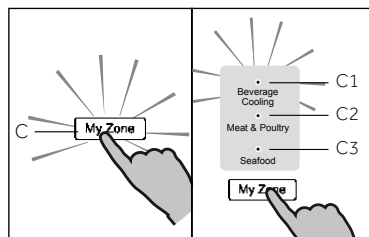

Use

Fresh storage drawer

The Fresh Storage drawer is suitable to store fruits and vegetables. It has a Humidity Control System (HCS) module which automatically controls the moisture above 85%. It can maintain this level for several weeks.

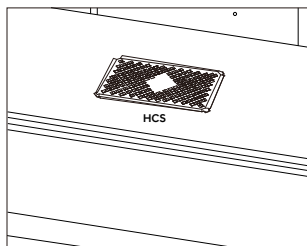

Water dispenser (Only models with water dispenser)

With the water dispenser, drinking water can be conveniently stored in your tank. The water tank should be cleaned before first use (see CARE AND CLEANING).

Filling the water tank



WARNING!

Use drinking water only.

1. Ensure that the water tank is properly inserted (see EQUIPMENT).
2. Rotate and lift the round lid (A) and fill the water tank up with fresh drinking water.
3. Fill water only up to the mark (2.5L); as it could overflow when the door opens and closes.
4. Close the round lid until it clicks into place.

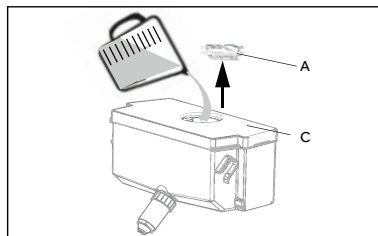

Notice

- ▶ Before refilling dispose residual water and clean the water tank.
- ▶ When you don't need water for a long time, please empty the water tank and insert the cleaned tank.
- ▶ The cover (C) on the water tank is additionally used to save energy. If you do not want to use water from the water dispenser for a long period, please still install the cover because of better insulating and saving energy.

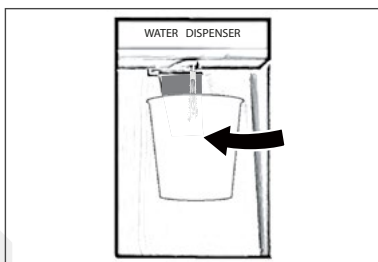

Getting water from the dispenser

1. Place a glass underneath the water outlet.
2. Push gently against the water dispenser lever with your glass.

Make sure the glass is in line with the dispenser to prevent the water from splashing out.

Tips on storing fresh food

Storing in the refrigerator compartment

- ▶ Keep your fridge temperature below 5°C.
- ▶ Hot food must be cooled to room temperature before storing in the appliance.
- ▶ Foods stored in the refrigerator should be washed and dried before storing.
- ▶ Food to be stored should be properly sealed to avoid odour or taste alterations.
- ▶ Do not store excessive quantities of food. Leave spaces between foods to allow cold air flowing around them, for a better and more homogeneous cooling.
- ▶ Foods eaten daily should be stored at the front of the shelf.
- ▶ Leave a gap between foods and the inner walls, allowing air flow. Don't store foods against the rear wall: foods could freeze against rear wall. Avoid direct contact of food (especially oily or acidic food) with the inner liner, as oil/acid can erode the inner liner. Clean away oily/acid dirt whenever it is found.
- ▶ Defreeze frozen food in the fridge storage compartment. This way, you can use the frozen food to decrease the temperature in the compartment and save energy.
- ▶ The ageing process of fruit and vegetables such as courgettes, melons, papaya, banana, pineapple, etc. can be accelerated in the refrigerator. Therefore, it is not advisable to store them in the refrigerator. However, the ripening of strongly green fruits can be promoted for a certain period. Onions, garlic, ginger and other root vegetables should also be stored at room temperature.
- ▶ Unpleasant odours inside the fridge are a sign that something has spilled and cleaning is required. See CARE AND CLEANING.
- ▶ Different foods should be placed in different areas according to their properties:

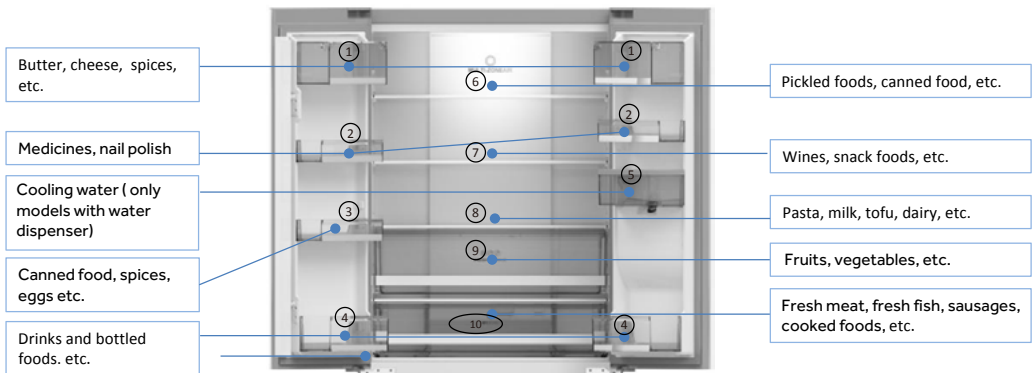

Storage in the freezer compartment

- ▶ Keep the freezer temperature at -18°C .
- ▶ 24 hours before freezing, switch on the Super Freeze function; for small quantities of food 4-6 hours are sufficient.
- ▶ Hot food must be cooled to room temperature before storing in the freezer compartment.
- ▶ Food cut into small portions will freeze faster and be easier to defrost and cook. The recommended weight for each portion is less than 2.5Kg
- ▶ It is better to pack food before putting it into the freezer. The outside of the packaging must be dry to avoid bags sticking together. Packaging materials should be odour-free, airtight, non-poisonous and nontoxic.
- ▶ In order to avoid expiration of storage periods, please note the freezing date, time limit and name of the food on the packaging according to the storage periods of different foods.
- ▶ **WARNING!** Acid, alkali and salt etc. could erode the internal surface of the freezer. Do not place food with these substances (eg. seafood) directly on internal surfaces. Salt water in the freezer should be cleaned up immediately.
- ▶ Do not exceed the food storage times recommended by the manufacturers. Only take the required amount of food out of the freezer.
- ▶ Consume defrosted food quickly. Defrosted food cannot be re-frozen unless it is first cooked, otherwise it may be less edible.
- ▶ Do not load excessive quantities of fresh food in the freezer compartment. Refer to the freezing capacity of the freezer (see TECHNICAL DATA).
- ▶ Food can be stored in the freezer at a temperature of at least -18°C for 2 to 12 months, depending on its properties (eg. meat: 3-12 months, vegetables: 6-12 months).
- ▶ When freezing fresh food, avoid bringing it in contact with already frozen food. Risk of thawing!
- ▶ Defreeze frozen food in the fridge. This way, you can use the frozen food to decrease the temperature in the fridge compartment and save energy.

Different foods should be placed in different areas according to their properties:

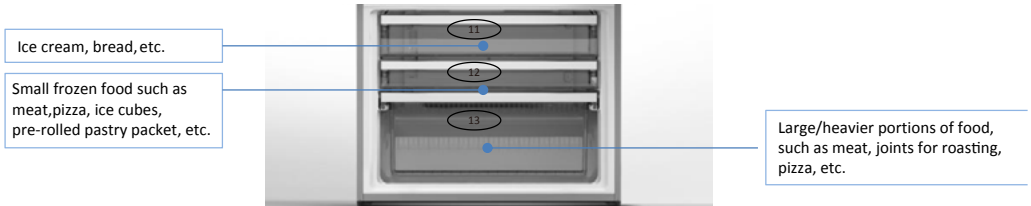

When storing commercially frozen foods, please follow these guidelines:

- ▶ Always follow manufacturers' guidelines for the length of time you should store food for. Do not exceed these guidelines!
- ▶ Try to keep the length of time between purchase and storage as short as possible to preserve food quality.
- ▶ Buy frozen foods, which have been stored at a temperature of -18°C or below.
- ▶ Avoid buying food which has ice or frost on the packaging. This indicates that the products might have been partially defrosted and refrozen at some point, which may affect the quality of food.

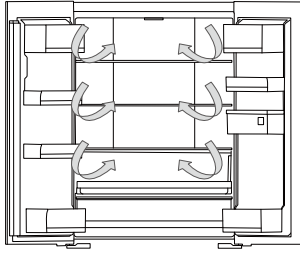

Multi-air-flow

The refrigerator is equipped with a multi-air-flow system, with which cool air flows are located on every shelf level. This helps to maintain a uniform temperature to ensure that your food is kept fresher for longer.

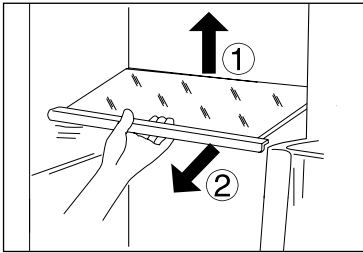

Adjustable shelves

The height of the shelves can be adjusted to fit your storage needs.

1. To relocate a shelf, remove it first by uplifting its hind edge (1) and pulling it out (2).
2. To reinstall it, put it on the lugs on both sides and push it to the most rearward position until the rear of the shelf is fixed inside the slots in the sides.



Notice

Ensure that both ends of a shelf are level.

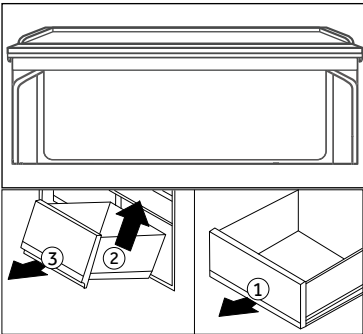

My Zone drawer and Fresh Storage drawer

For use and setting of the My Zone drawer please check section USE.

To remove the drawer:

Pull out (1) to the maximum extent.

Lift (2) to separate the drawer from the rail and remove (3).

It can be mounted in reverse order.

Use same process for the Fresh Storage drawer.

Removable door racks

The door racks can be removed for cleaning:

Place hands on each side of the rack, lift it upwards (1) and pull it out (2).

In order to insert the door rack, the above steps are carried out in reverse order.

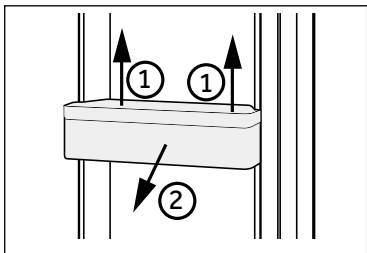

Removable water tank (only models with water dispenser)

The water tank can be removed and reinstalled for cleaning in the same way as the door racks.

Insert water tank (only models with water dispenser)

Place the water tank in the position that the water outlet (B) fits into the opening of the door. Make sure that the water tank is locked.

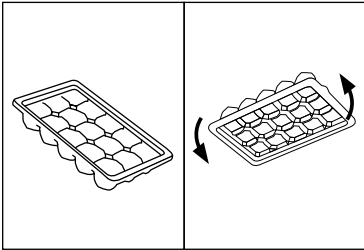
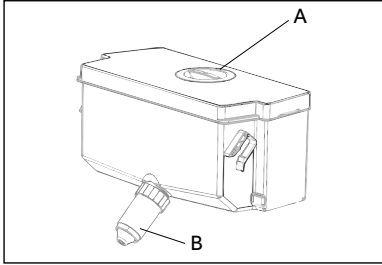

Ice cube tray

1. Fill the ice cube tray 3/4 full of water, close with the cover and put it into the pre-freezing compartment.
2. Twist the ice cube tray slightly or hold it under flowing water to loosen the ice cubes.

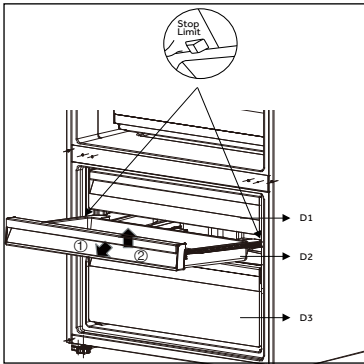

Removable freezer drawer

The freezer drawers are removable:

Drawer D1 and D3 (if fitted)

1. Pull out the drawer to the maximum extent.
2. Lift the drawer and remove.

Drawer D2

1. Pull out the drawer to maximum extent,
2. Press the Stop limit on both sides.
3. Lift the drawer and remove.

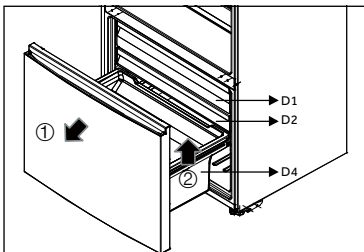

Drawer D4 (if fitted)

1. Pull out the drawer to maximum extent.
 2. Lift to separate the box from the rails and remove.
- In order to insert the boxes and drawer, the above steps are carried out in reverse order.



Energy saving tips

- ▶ Make sure the appliance is properly ventilated (see INSTALLATION).
- ▶ Do not install the appliance in direct sunlight or near sources of heat (eg. stoves, heaters).
- ▶ Avoid unnecessarily low temperature in the appliance. The energy consumption increases the lower the temperature in the appliance is set.
- ▶ Functions like Super Cool or Super Freeze consume more energy.
- ▶ Allow warm food to cool down before placing it in the appliance.
- ▶ Open the appliance door as little and as briefly as possible.
- ▶ Do not overfill the appliance to avoid obstructing the air flow.
- ▶ Avoid air within the food packaging.
- ▶ Keep door seals clean so that the door always closes correctly.
- ▶ Defreeze frozen food in the fridge storage compartment.



WARNING!

Disconnect the appliance from the power supply before cleaning.

Cleaning

Clean the appliance when only little or no food is stored.

The appliance should be cleaned every four weeks for good maintenance and to prevent bad stored food odors.



WARNING!

- ▶ Do not clean the appliance with hard brushes, wire brushes, detergent powder, petrol, amyl acetate, acetone and similar organic solutions, acid or alkaline solutions. Please clean with special refrigerator detergent to avoid damage.
 - ▶ Do not spray or flush the appliance during cleaning.
 - ▶ Do not use water spray or steam to clean the appliance.
 - ▶ Do not clean the cold glass shelves with hot water. Sudden temperature change may cause the glass to break.
 - ▶ Do not touch the inside surface of the freezer storage compartment, especially with wet hands, as your hands may freeze onto the surface.
 - ▶ In case of heating check the condition of frozen goods.
-
- ▶ Always keep the door gasket clean.
 - ▶ Clean the inside and housing of the appliance with a sponge dampened in warm water and neutral detergent.
 - ▶ Rinse and dry with soft cloth.
 - ▶ Do not clean any of the parts of the appliance in a dishwasher.
 - ▶ Allow at least 5 minutes before restarting the appliance as frequent starting may damage the compressor.

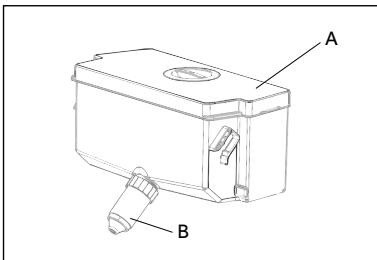
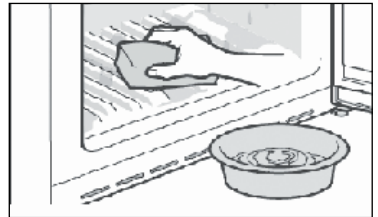

Cleaning the water tank (only models with water dispenser)

1. Take the water tank out of the appliance.
2. Remove the cover (A).
3. Unscrew the dispenser cock (B).
4. Clean the tank and dispenser cock with warm water and liquid dishwashing detergent. Make sure all soap is rinsed off.
5. Mount the dispenser cock, close the cover and replace the tank inside the appliance.

Care and Cleaning

Defrosting

The defrosting of the refrigerator and the freezer compartment are done automatically; no manual operation is needed.

Replacing the LED lamps



WARNING!

Do not replace the LED lamp yourself, it must only be replaced by either the manufacturer or the authorised service agent.

The appliance uses LED lamps as its light, featuring low energy consumption and long service life. If there is any abnormality, please contact customer service. See CUSTOMER SERVICE.

Parameters of the lamp:

Model	Refrigerator compartment		Freezer compartment	
	Voltage	max Power	Voltage	max Power
HRF520BW	12V	2W	-	-
HRF520BS				
HRF520BHS				
HRF520FS				
HRF520FHS				

Non-use for a longer period

If the appliance is not used for an extended period of time, and the Holiday function for the refrigerator is not being used:

- ▶ Take out the food.
- ▶ Unplug the power cord.
- ▶ Clean the appliance as described above.
- ▶ Keep the door and freezer drawers/door open to prevent the creation of bad odours inside.



Notice

Turn the appliance off only if strictly necessary.

Moving the appliance

1. Remove all food and unplug the appliance.
2. Secure shelves and other moveable parts in the fridge and the freezer with adhesive tape.
3. Do not tilt the refrigerator more than 45° to avoid damaging the refrigerating system.



WARNING!

- ▶ Do not lift the appliance by its handles.
- ▶ Never place the appliance horizontally on the ground.

Many problems that occur can be solved without specific expertise. In case of a problem, please refer to the below list of possibilities and follow instructions before contacting after sales service. See CUSTOMER SERVICE.



WARNING!

- ▶ Before maintenance, deactivate the appliance and disconnect the mains plug from the mains socket.
- ▶ Electrical equipment should be serviced only by qualified electrical experts, because improper repairs can cause considerable consequential damages.
- ▶ A damaged power supply should only be replaced by the manufacturer, its service agent or similarly qualified persons in order to avoid a hazard.

Problem	Possible Cause	Possible Solution
The compressor does not work.	<ul style="list-style-type: none"> • Mains plug is not connected in the mains socket. • The appliance is in the defrosting cycle. 	<ul style="list-style-type: none"> • Connect the mains plug. • This is normal for an automatic defrosting.
The appliance runs frequently or runs for too long a period of time.	<ul style="list-style-type: none"> • The indoor or outdoor temperature is too high. • The appliance has been powered off for a period of time. • A door/drawer of the appliance is not tightly closed. • The door/drawer has been opened too frequently or for too long. • The temperature setting for the freezer compartment is too low. • The door/drawer gasket is dirty, worn, cracked or mismatched. • The required air circulation is not guaranteed. 	<ul style="list-style-type: none"> • In this case, it is normal for the appliance to run longer. • Normally, it takes 8 to 12 hours for the appliance to cool down completely. • Close the door/drawer and ensure the appliance is located on level ground and there is no food or container holding door ajar. • Do not open the door/drawer too frequently. • Set the temperature higher until a satisfactory refrigerator temperature is obtained. It takes 24 hours for the refrigerator temperature to become stable. • Clean the door/drawer gasket or replace them through customer service. • Ensure adequate ventilation.
The inside of the refrigerator is dirty and/ or smells.	<ul style="list-style-type: none"> • The inside of the refrigerator needs cleaning. • Food of strong odour is stored in the refrigerator. 	<ul style="list-style-type: none"> • Clean the inside of the refrigerator. • Wrap the food thoroughly.

Troubleshooting

Problem	Possible Cause	Possible Solution
It is not cold enough inside the appliance.	<ul style="list-style-type: none"> • The temperature is set too high. • The temperature of the food stored is too warm. • Too much food has been stored at one time. • The goods are too close to each other. • A door/drawer of the appliance is not tightly closed. • The door/drawer has been opened too frequently or for too long. 	<ul style="list-style-type: none"> • Reset the temperature. • Always cool down goods before storing them. • Always store small quantities of food. • Leave a gap between several foods allowing air flow. • Close the door/drawer. • Do not open the door/drawer too frequently.
It is too cold inside the appliance.	<ul style="list-style-type: none"> • The temperature is set too low. • The Super Freeze/Super Cool function is activated or is running too long. 	<ul style="list-style-type: none"> • Reset the temperature. • Switch off the Super Freeze/Super Cool function.
Moisture formation on the inside of the refrigerator compartment.	<ul style="list-style-type: none"> • The climate is too warm and too damp. • A door/drawer of the appliance is not tightly closed. • The door/drawer has been opened too frequently or for too long. • Food containers or liquids are left open. 	<ul style="list-style-type: none"> • Increase the temperature. • Close the door/drawer. • Do not open the door/drawer too frequently. • Let hot foods cool to room temperature and cover foods and liquids.
Moisture accumulates on the refrigerator outside surface or between the doors/door and drawer.	<ul style="list-style-type: none"> • The climate is too warm and too damp. • The door/drawer is not closed tightly. The cold air in the appliance and the warm air outside it condensates. 	<ul style="list-style-type: none"> • This is normal in damp climate and will change when the humidity decreases. • Ensure that the door/drawer is tightly shut.
Strong ice and frost in the freezer compartment.	<ul style="list-style-type: none"> • The goods were not adequately packaged. • A door/drawer of the appliance is not tightly closed. • The door/drawer has been opened too frequently or for too long. • The door/drawer gasket is dirty, worn, cracked or mismatched. • Something on the inside prevents the door/drawer to close properly. 	<ul style="list-style-type: none"> • Always pack the goods well. • Close the door/drawer. • Do not open the door/drawer too frequently. • Clean the door/drawer gasket or replace them with new ones. • Reposition the shelves, door racks, or internal containers to allow the door/drawer to close.

Problem	Possible Cause	Possible Solution
The appliance makes abnormal sounds.	<ul style="list-style-type: none"> The appliance is not located on level ground. The appliance touches some object around it. 	<ul style="list-style-type: none"> Adjust the feet to level the appliance. Remove objects around the appliance.
A slight sound is heard similar to that of flowing water.	<ul style="list-style-type: none"> - 	<ul style="list-style-type: none"> This is normal.
You hear an alarm beep.	<ul style="list-style-type: none"> The fridge storage compartment door is open. The temperature in the freezer is too high. 	<ul style="list-style-type: none"> Close the door or silence the alarm manually. The alarm is normal when it is first started due to relatively higher temperature. You can silence the alarm manually (see USE).
You hear a faint hum.	<ul style="list-style-type: none"> The anti-condensation system is working. 	<ul style="list-style-type: none"> This prevents condensation and is normal.
The interior lighting or cooling system does not work.	<ul style="list-style-type: none"> Mains plug is not connected in the mains socket. The power supply is not intact. The LED lamp is out of order. 	<ul style="list-style-type: none"> Connect the mains plug. Check the electrical supply to the room. Call the local electricity company! Please call customer service to change the lamp.

Power interruption

In the event of a power cut, food should remain safely cold for about 16 hours. Follow these tips during a prolonged power interruption, especially in summer:

- ▶ Open the door/drawer as few times as possible.
- ▶ Do not put additional food into the appliance during a power interruption.
- ▶ If prior notice of a power interruption is given and the interruption duration is longer than 16 hours, make some ice and put it in a container in the top of the refrigerator compartment.
- ▶ An inspection of the goods is required immediately after the interruption.
- ▶ As temperature in the refrigerator will rise during a power interruption or other failure, the storage period and edible quality of food will be reduced. Any food that defrosts should be either consumed, or cooked and refrozen (where suitable) soon afterwards in order to prevent health risks.

Installation

Unpacking



WARNING!

- ▶ The appliance is heavy. Always handle with at least two persons.
- ▶ Keep all packaging materials out of children's reach and dispose them in an environmentally friendly manner.

- ▶ Take the appliance out of the packaging.
- ▶ Remove all packaging materials.

Environmental conditions

The room temperature should always be between 10°C and 43°C, since it can influence the temperature inside the appliance and its energy consumption. Do not install the appliance near other heat-emitting appliances (ovens, refrigerators) without isolation.

Door reversibility

Before the appliance is permanently installed, check the correct position of the door hinge. If necessary see door reversibility below.

Space requirement

Required space when door is opened:

Model	Appliance width in mm		Appliance depth in mm	
	W1	W2	D1	D2
HRF520BW HRF520BS HRF520BHS	1241	–	619	1423

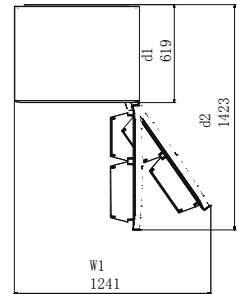

Model	Appliance width in mm		Appliance depth in mm	
	W1	W2	D1	D2
HRF520FS HRF520FHS	1008	1226	619	1024

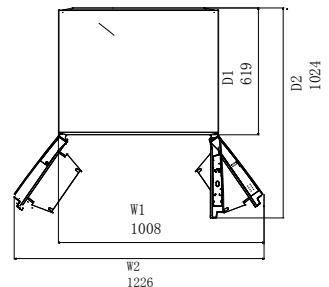

Positioning your appliance

This appliance should be installed in a room that is dry and well ventilated. To provide adequate ventilation, make sure the refrigerator is at least 20mm clear on all sides from kitchen cabinetry, and 30mm from the back wall. Any units placed above the appliance must be clear by 50mm to allow sufficient ventilation.

If locating the refrigerator close to a corner, sufficient spacing must be left for opening the doors and removing the shelves.

This appliance should be at least 100mm from any electric or gas cooker. If this is not possible, make sure that appropriate insulation is used (eg insulated wall).

Avoid exposing the appliance to direct sunlight, and sources of heat (such as radiators, heaters or cookers).

Locating this appliance in a cold environment (such as a shed, outhouse or garage) may compromise its performance. A consistent room temperature of 10°C or above is recommended to ensure optimum performance and food care.

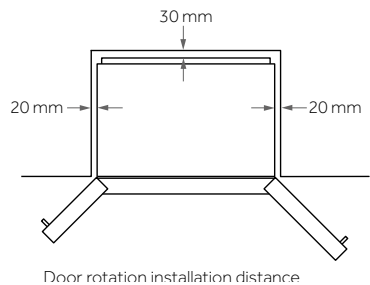
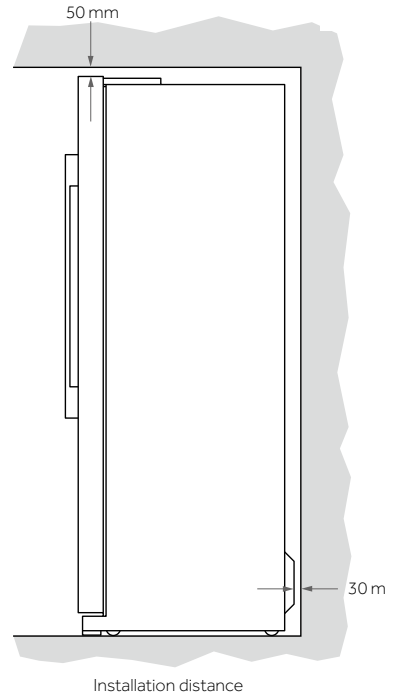

Installation

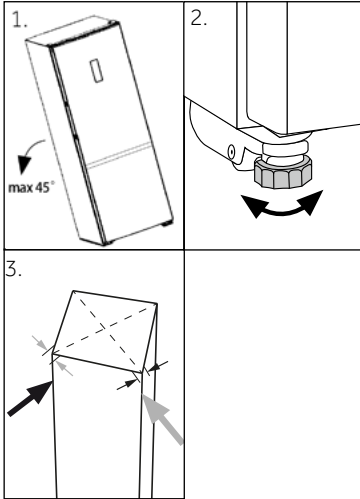

Aligning the appliance

The appliance should be placed on a flat and solid surface.

1. Tilt the appliance slightly backwards.
2. Set the feet to the desired level.

Make sure the distance to the wall on the hinge side is at least 100mm for the door to open properly.

3. The stability can be checked by alternately bumping on the diagonals. The slightly swaying should be the same in both directions. Otherwise the frame can warp; possible leaking door seals are the result. A lowering of the rear feet facilitates the door.

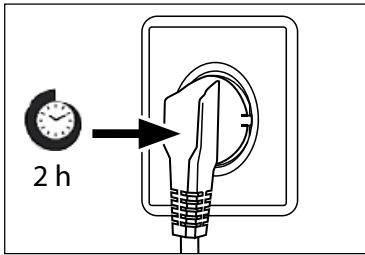

Waiting time

Maintenance-free lubrication oil is located in the capsule of the compressor. This oil may get through closed pipe system during transportation. Before connecting the appliance to the power supply you have to wait 2 hours so that the oil runs back into the capsule.

Electrical connection

Before each connection check if:

- ▶ power supply, socket and fusing are appropriate to the rating plate.
- ▶ the power socket is earthed and no multi-plug or extension is being used.
- ▶ the power plug and socket are of sound condition.

Connect the plug to a properly installed household socket.



WARNING!

To avoid risks, a damaged power cord must be replaced by customer services (see warranty card).

Door reversibility

Before connecting the appliance to the power supply, you should check whether the door swing must be changed from right (as delivered) to left, as required by the installation location and the usability.



WARNING!

- ▶ The appliance is heavy. You need two persons to carry out the door reversibility.
- ▶ Before any operation, first unplug the appliance from the mains .
- ▶ Do not tilt the appliance more than 45° to prevent damage of the cooling system.

1. Locate necessary tools.
2. Unplug the appliance.

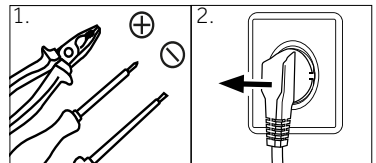

3. Remove the fixation of the cover.
4. Remove the faceplate of the body.

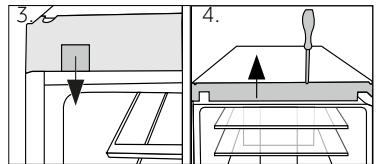

5. Remove the top-plate of the upper door.
6. Remove the hinge cover.

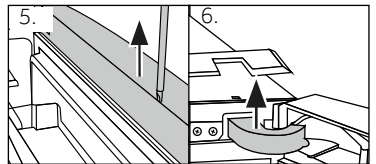

7. Unplug the connection cable.
8. Unscrew the upper hinge.

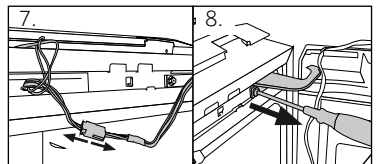

9. Lift the loose upper door carefully off the lower hinge.
10. Turn the upper door upside down and change the position of the hinge barrel on the lower side of the door.

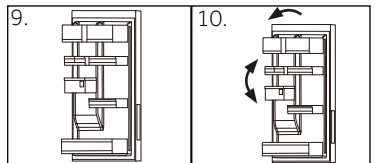

11. Change the door stop from the current position to opposite side.
12. Unscrew the lower hinge of the upper door.

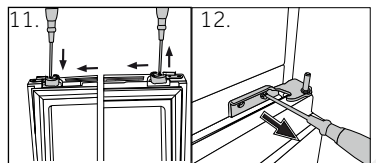

Installation

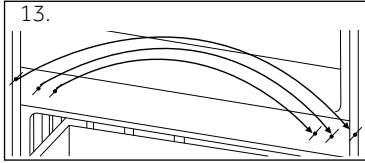

13. Change the positions of the blanking plugs and the screw on the other side.

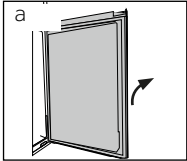

a Remove lower door.

b Change the door stop at the bottom of the lower door from the current position to opposite side.

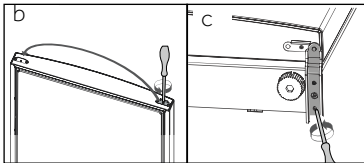

c Unscrew the bottom hinge.

d Take out the new bottom hinge from the accessory bag and screw the new bottom hinge to the other side of the door opening.

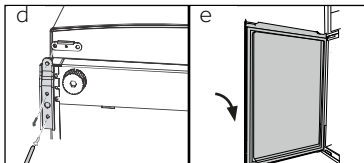

e Lift the lower door carefully onto the bottom hinge so that the pivot fits into the hinge barrel.

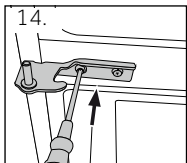

14. Take out the new hinge from the accessory bag and screw the new middle hinge of upper door to the other side of the door opening.

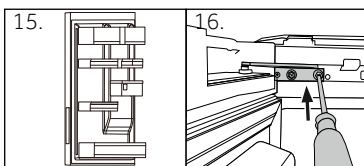

15. Lift the door carefully on to the lower hinge so that the pivot fits into the hinge barrel.

16. Fix the upper hinge with the screws.

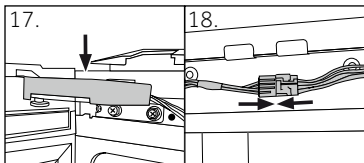

17. Put the connection cable through the hinge cover (delivered in the accessory bag) and put it over the hinge.

18. Plug in the connection cable and fit it into the opening.

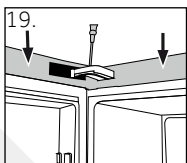

19. Replace faceplate and cover, fix it with the screws and reinsert the fixation (see fig. 3).

After changing the door check that the door seals are located properly on the housing and all screws are tightened well.

Trademark	Haier	Haier
Model No.	HRF520BW HRF520BS HRF520BHS	HRF520FS HRF520FHS
Category of the model	Refrigerator-freezer	Refrigerator-freezer
Voltage/Frequency	220V-240V~/50Hz	220V-240V~/50Hz
Energy Star	4 star	4 star
Frost-free system	Yes	Yes
Product group	5B	5B
Total gross volume	517L	514L
Total storage volume	433L	430L
Fresh food compartment volume	344L	341L
Freezer compartment volume	89L	89L
Climate class	T	T
Refrigerant	R600a 64g	R600a 64g
Insulation blowing gas	HC-C601	HC-C601
Dimension (DxWxH)	686x790x1725mm	686x790x1725mm
Protection class	I	I



Haier