

VACSTAR[®]

DENTAL VACUUM SYSTEM

PART NUMBERS: VS20, VS40, VS50, VS50H, VS80 AND VS80H



USER'S MANUAL

AIR equipped for life[®]
TECHNIQUES

ISO
9001
ISO 13485
FDA-GMP COMPLIANT

TABLE OF CONTENTS

SECTION	PAGE
Congratulations	3
Purpose of this Manual	3
Warranty	4
On-Line Warranty Registration	4
Safety Instructions	4
Sizing Guide	5
Optional In-Line Filter Kit	5
Operating Information	6
Key Parts Identification - Single Pumps	6
Key Parts Identification - Dual Pumps	7
Installation Information	8
Product Specifications/Dimensions	12
Site Requirements	12
Replacement/Reorder	13
Troubleshooting	14
Accessories/Options	14
Maintenance	15

LIST OF ILLUSTRATIONS

FIGURE	TITLE	PAGE
1	VacStar 20, 40 Parts Location	6
2	VacStar 50, 50H, 80 and 80H Parts Location	7
2A	Plumbing Connections Detail View	7
3	Bypass Valve Educator Assembly	7
4	VacStar 20, 40 without a HydroMiser or Air/Water Separator	8
5	VacStar 50, 80 without a HydroMiser or Air/Water Separator	8
6	VacStar with Built-In HydroMiser	9
7	VacStar with Wall Mounted Air/Water Separator	9
8	VacStar with Wall-Mounted HydroMiser	9
9	VacStar Electrical Connection Box - Interior View VacStar 20	10
10	VacStar Electrical Connections	11
11	Vacuum Relief Valve Filter Location	15
12	Intake Solids Collector Location	16
13	Water Inlet Strainer Location	17

Congratulations on the purchase of your new **VacStar™** Dental Vacuum System hereafter referred to as **VacStar™** in this manual.

Your **VacStar™** has been engineered to deliver maximum air flow at the ideal vacuum level without creating traumatic suction pressure that could harm patients' delicate tissue. The **VacStar™** is a wet ring pump that produces consistent high-volume air flow, even with multiple users on-line. The balanced, corrosion free bronze impeller minimizes noise and a patented vacuum relief valve maintains constant uniform vacuum pressure. A capacitor-start type motor, with a highly reliable electrical contactor and powerful transformer can be depended on to start every time. The **VacStar™** is designed with everything accessible from the front, including the easy to replace solids collector.

If your **VacStar™** comes with an integral HydroMiser (VS50H or VS80H), water consumption will be reduced by up to 75%. If not, a HydroMiser can be integrated into your **VacStar™** at a later date. The HydroMiser separates the liquid and gas discharge from the operatories. The gases are vented out while the liquid and its particulates are directed down the drain. The clean water extracted during this separation process is directed back toward the **VacStar™** where it is mixed with fresh water and then directed into the pump chamber to create vacuum. This efficient reuse of water reduces the VacStar's fresh water consumption.

Thousands of dentists have depended on the **VacStar™** since 1987. Now that your practice has a **VacStar™**, or a **VacStar™** with the water saving HydroMiser, you too can depend on constant, uniform delivery of vacuum to your operatories and proven trouble-free operation.

PURPOSE OF THIS MANUAL

This manual provides installation, operation and maintenance instructions for the support of the six available **VacStar™** systems listed below. Review and follow the guidelines included in this User Manual to ensure that the system provides the highest level of service.

VacStar Models



VS20
2 User Capability



VS50
4 User Capability



VS80
7 User Capability



VS40
3 User Capability



VS50H (See Note)
4 User Capability



VS80H (See Note)
7 User Capability

Note: VS50H and VS80H models include an integral HydroMiser that reduces fresh water consumption

WARRANTY

The **VacStar™** is warranted to be free from defects in material and workmanship from the date of installation for a period of twenty-four (24) months.

Any item returned to our factory through an Air Techniques Authorized Dealer, will be repaired or replaced at our option at no charge provided that our inspection shall indicate it to have been defective. Dealer labor, shipping and handling charges are not covered by this warranty.

This warranty does not apply to damage due to shipping, misuse, careless handling or repairs by other than authorized service personnel. Warranty is void if equipment is installed or serviced by other than dealer service personnel authorized by Air Techniques. Air Techniques, Inc. is not liable for indirect or consequential damages or loss of any nature in connection with this equipment.

This warranty is in lieu of all other warranties expressed or implied. No representative or person is authorized to assume for us any liability in connection with the sale of our equipment.

ON-LINE WARRANTY REGISTRATION

Quickly and easily register your new **VacStar™** on-line. Just have your product model and serial numbers available. Then go to the Air Techniques website, www.airtechniques.com, click the **register a product link** and complete the registration form. This on-line registration ensures a record for the warranty period and helps Air Techniques keep you informed of product updates and other valuable information.

SAFETY INSTRUCTIONS

Use of the **VacStar™** not in conformance with the instructions specified in this manual may result in permanent failure of the unit.

WARNING: To prevent fire or electrical shock, do not expose this appliance to rain in or moisture.

All user serviceable items are described in the maintenance section.

Manufacturing date code on serial number label is in the format Month YYYY.

ATTENTION USERS:



Alerts users to important Operating and Maintenance instructions. Read carefully to avoid any problems.



Warns users that uninsulated voltage within the unit may be of sufficient magnitude to cause electric shock.

I ON
O OFF

Indicates the ON and OFF position for the Equipment power switch.



Indicates protective Earth Ground for the Equipment power switch.



MEDICAL ELECTRICAL EQUIPMENT

WITH RESPECT TO ELECTRICAL SHOCK, FIRE, MECHANICAL AND OTHER SPECIFIED HAZARDS ONLY
IN ACCORDANCE WITH UL-60601-1, CAN/CSA C22.2 NO.601.1
66CA



Indicates that the equipment complies with the Medical Device Directive 93/42/EEC.



Medical Device Safety Service
Schiffgraben 41
30175 Hannover, Germany



Air Techniques, Inc.
1295 Walt Whitman Road
Melville, New York, USA 11747- 3062

Choosing the correct size **VacStar™** for your practice depends on the number of HVE (High Volume Evacuator) and SE (Saliva Ejector) users anticipated. To assure optimum vacuum, the vacuum demands should not exceed the number of HVE and SE users shown in the chart below:

Recommended Number of Simultaneous Users

VacStar 20 HVE's + SE's	VacStar 40 HVE's + SE's	*VacStar 50 & 50H HVE's + SE's	*VacStar 80 & 80H HVE's + SE's
2 + 0	3 + 0	4 + 0	7 + 0
1 + 1	2 + 2	3 + 2	6 + 1
0 + 4	1 + 4	2 + 4	5 + 3
	0 + 6	1 + 5	4 + 4
NOTES: HVE = High Volume Evacuator SE = Saliva Ejector * These combinations apply if both pumps are running together. If only one pump is running, use the Sizing Guide for VacStar 20 or 40.			3 + 6
			2 + 8
			1 + 10
			0 + 13

OPTIONAL IN-LINE FILTER KIT

Since larger quantities of particulates may occur initially when a VacStar is replacing another vacuum pump, an optional In-Line Filter is recommended to be installed at the intake connection (see Key Parts). This In-Line Filter is designed to collect larger quantities of particulates from the discharge BEFORE it flows into the VacStar. The larger quantities of debris is mainly due to the VacStar's increased pulling power and the effectiveness of the CleanStream Evacuation System Cleaner's ability to break down proteinaceous deposits and synthetic debris that have accumulated in the existing vacuum lines.

Use the In-Line Filter Kit P/N 55078 for single vacuum pump units VS20 and VS40. The kit part number for twin pump units (VS50, VS50H, VS80 and VS80H) is 55079. Refer to the Maintenance Section for recommended maintenance requirements.

OPERATING INFORMATION

❑ AT THE START OF THE DAY

Always TURN ON THE WATER before TURNING ON THE POWER.

- ❑ The VacStar may be turned on/off from a single, convenient location within the dental suite using a Remote Control Panel (See Optional Accessories).
- ❑ The vacuum level is factory preset at 10 In Hg (inches of mercury). This is the reading on the gauge when all HVE's (High Volume Evacuator) and SE's (Saliva Ejector) are CLOSED. Should this setting be too high for your needs, contact your dealer to readjust the setting.
- ❑ It is recommended that the system run continuously during the day. However, the VacStar can be turned off if suction is not required for a period of 15 minutes or longer.
- ❑ If one pump is being operated at a time, it is important to alternate pumps on an every other day schedule so that the pumps are used evenly.

❑ AT THE END OF THE DAY

Always TURN THE POWER OFF, then TURN THE WATER OFF.

KEY PARTS IDENTIFICATION - SINGLE PUMPS

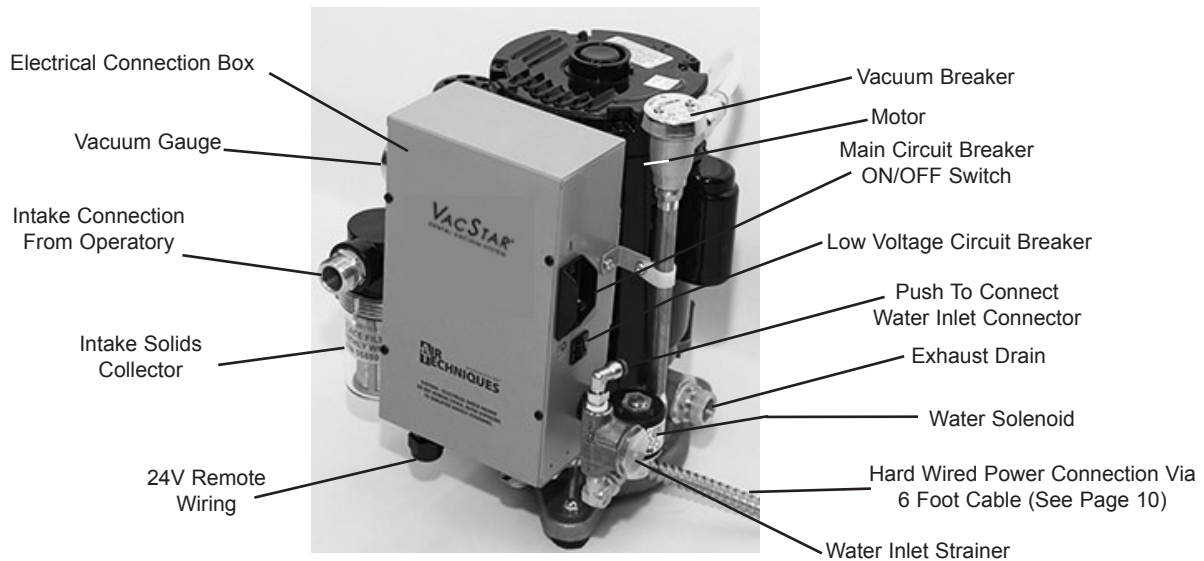

Figure 1. VacStar 20 and 40 Parts Location

NOTE: VACSTAR 20 shown. VACSTAR 40 is similar except main power connection is made via provided hospital grade NEMA 6-15P line cord.

KEY PARTS IDENTIFICATION - DUAL PUMPS

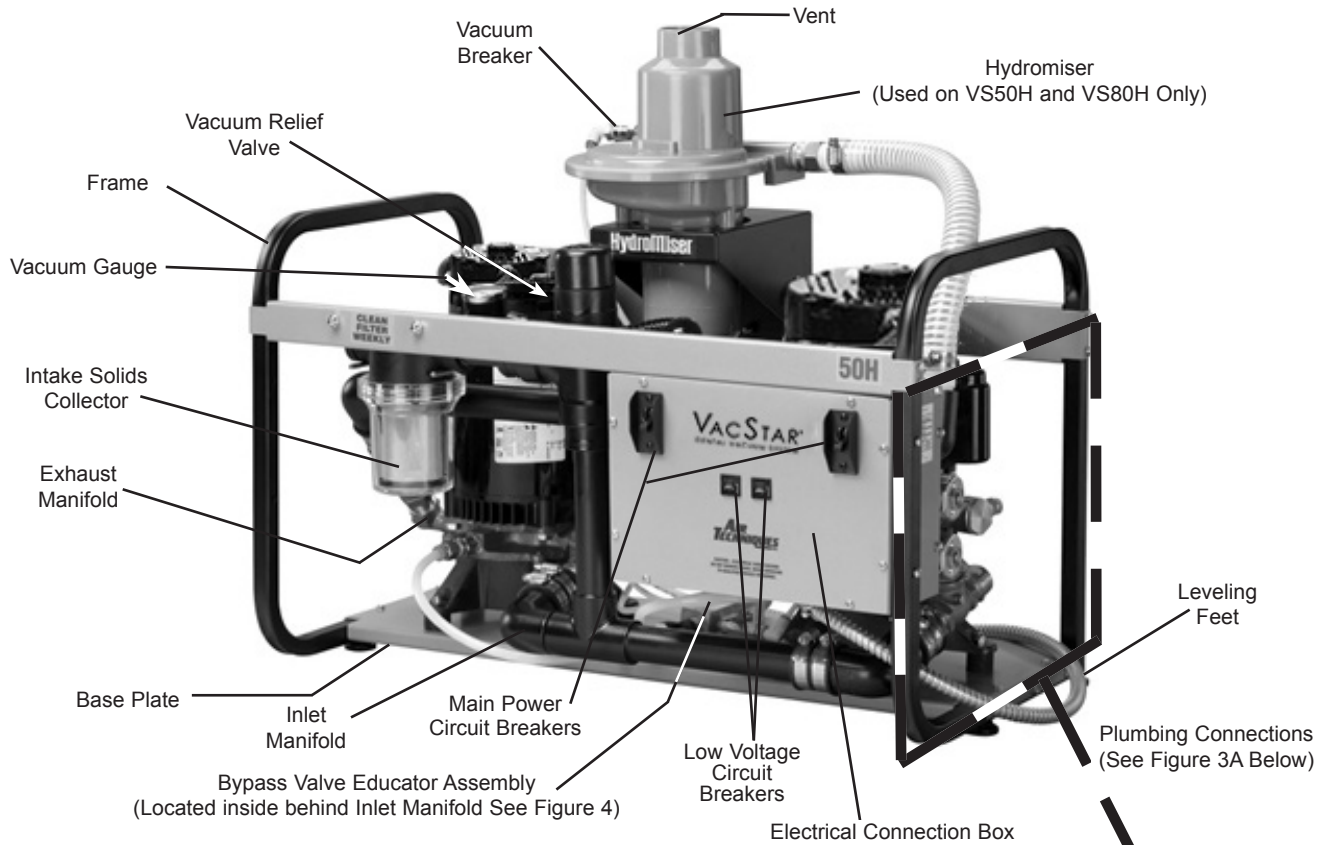

Figure 2. VacStar 50, 50H, 80 and 80H Parts Location

NOTE: VACSTAR 50H Shown, Other Models are Similar

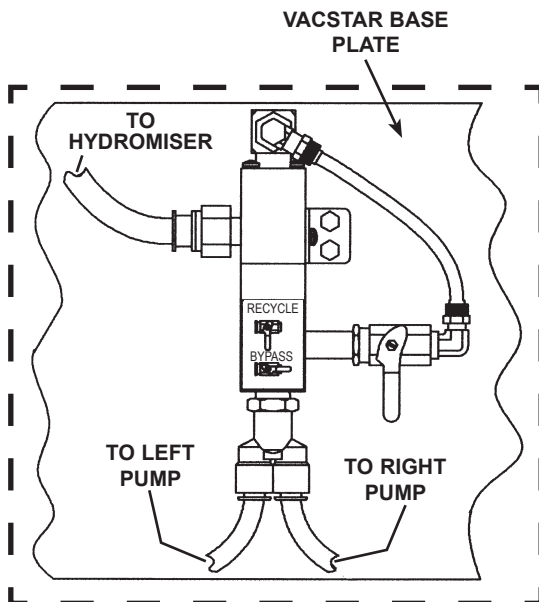

Figure 3.
Bypass Valve Educator Assembly

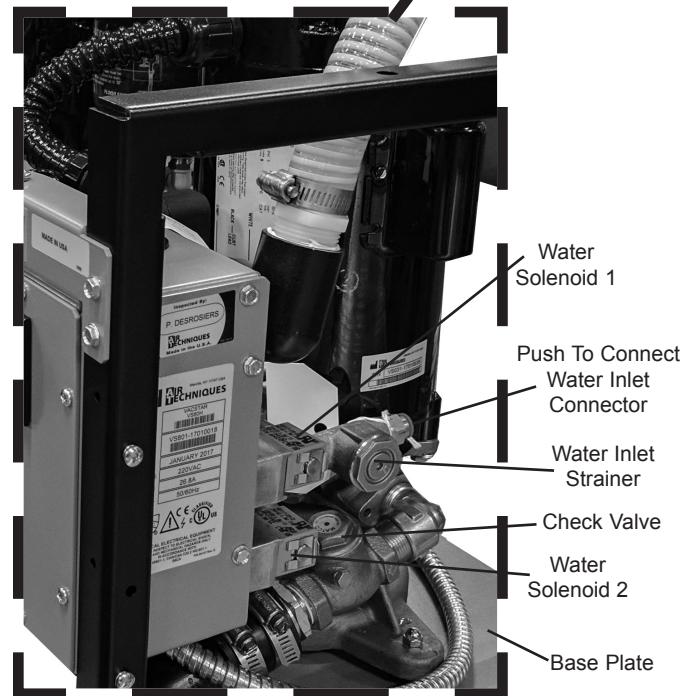

Figure 2A
Plumbing Connections Detail View

INSTALLATION INFORMATION

❑ Plumbing (water) lines

- To assure that the **VacStar™** provides optimum vacuum, incoming water pressure must be maintained between 20 and 100 psi.
- If heavy combinations of particulates exist in the incoming water, an in-line filter should be installed. (See Accessories/Options for the Remote Control Water Valve.) This will prevent the VacStar's water inlet filter from clogging too frequently.
- Incoming water temperature should be between 40° and 75°F.
- Water connection location is shown in Fig. 1 and 2a (water inlet connection).

❑ Suction

- For VacStar 20 and 40, suction hose is connected at suction intake, found on intake solids collector assembly. See Fig. 1.
- For VacStar twin pump units, suction hose is connected at suction intake, found on intake solids collector assembly. See Fig. 2.

❑ Drain lines

- For VacStar 20 and 40 without a HydroMiser or an Air/Water Separator, see Fig. 4.
- For VacStars without a HydroMiser or an Air/Water Separator, the effluent should be discharged into an open drain or a closed vented drain. See Fig. 5.
- For VacStars with a HydroMiser (see Fig. 6) or an Air/Water Separator (see Fig. 7), gases should be vented out according to code. The waste water (with particulates) from the operatories can be discharged via an open drain or a closed vented drain.

Note: For VacStars without a HydroMiser, the drain may be up to 36" above the unit.

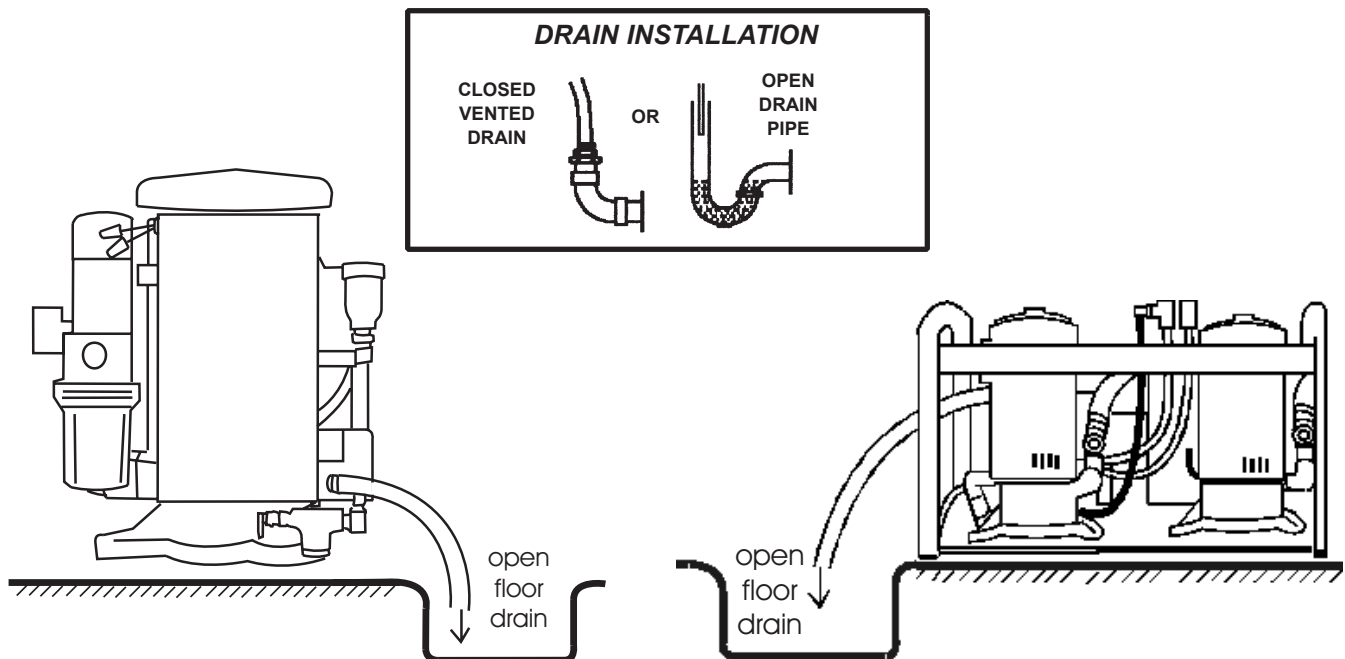

Figure 4. VacStar 20, 40 without a HydroMiser or Air/Water Separator

Figure 5. VacStar 50, 80 without a HydroMiser or Air/Water Separator

Figures 6, 7 and 8 show the typical installations of the dual **VacStar™** models 50, 50H, 80 and 80H. Install the **VacStar™** by referring to the figure corresponding to the system to be installed. Single **VacStar™** models 20 and 40 are installed in the same manner. Make sure that all notes, warnings and requirements are followed.

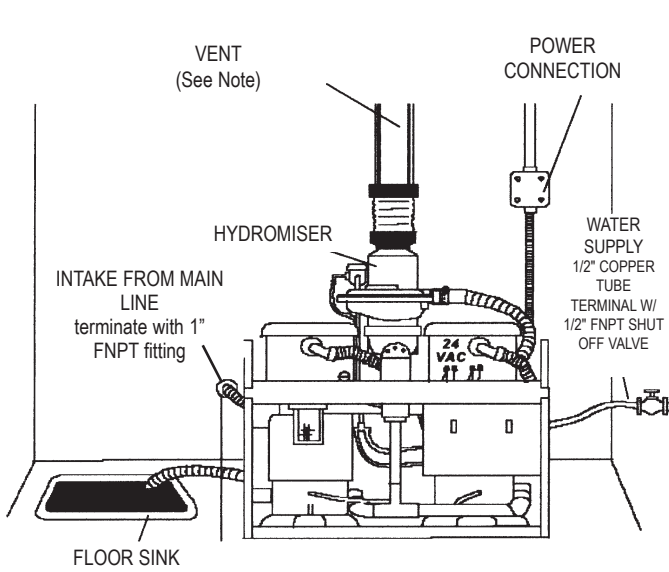

Figure 6.
VacStar with Built-In HydroMiser

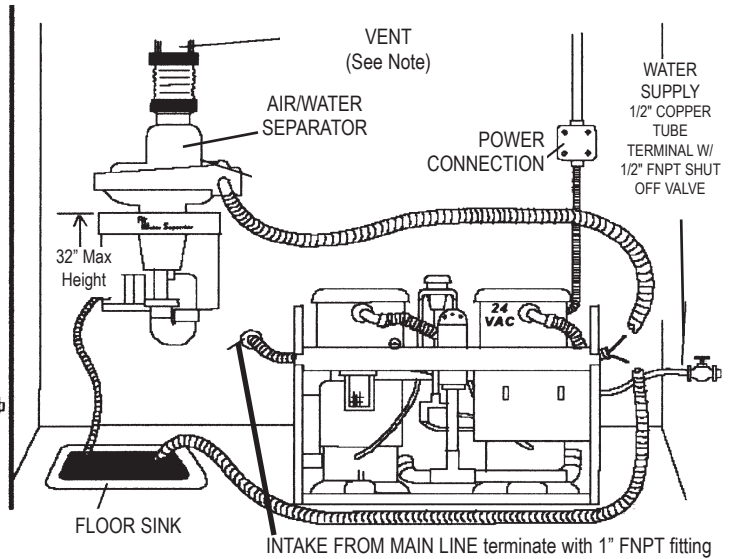
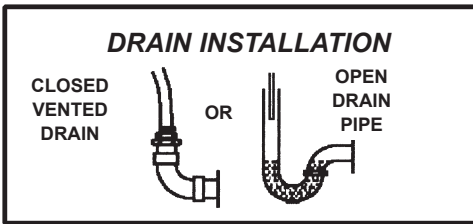

Figure 7.
VacStar with Wall Mounted Air/Water Separator



Note: For all installations, vent to outside with 2-inch schedule 40 pipe.

WARNING:

CONDENSATION OF WATER WILL OCCUR IN VENT PIPING. AVOID ACCUMULATION OF WATER IN VENT, SLOPE PIPING TOWARD SEPARATOR.

Wall-mounted HydroMiser

If the existing drain is higher than the HydroMiser outlet, the HydroMiser must be mounted so that its outlet is above the drain. The HydroMiser can be installed up to 36" above the base of the VacStar with the HydroMiser Wall Mount Kit (#55087).

**IMPORTANT NOTE:
ALL INSTALLATIONS**

Ambient temperature for all VacStar installations should be 40°- 104°F (5°- 40°C).

The liquid drain from the HydroMiser or an Air/Water Separator must slope downward at least 1/4" for every 10 feet of run toward the drain.

(Avoid local low sections, avoid creating traps in the line.)

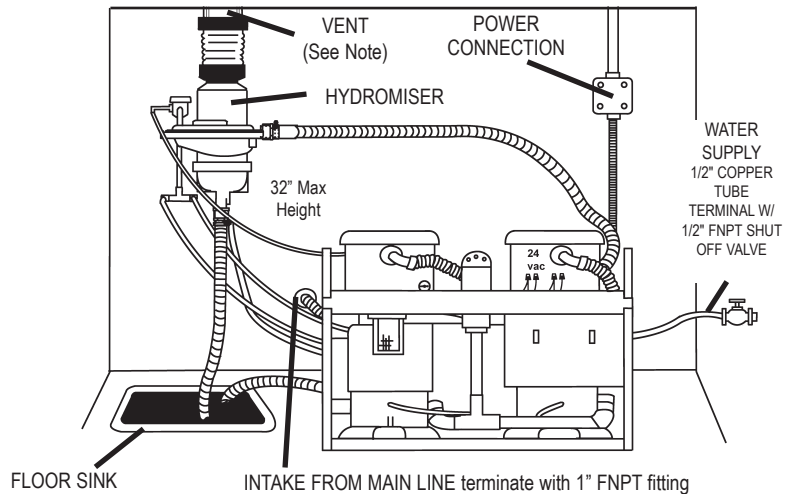

Figure 8. VacStar with Wall-Mounted HydroMiser

INSTALLATION INFORMATION

Electric

- To help prevent fire, electric shock, injury, or death, the wiring and grounding must conform to the latest edition of the National Electrical Code, ANSI/NFPA 70 and all applicable local regulations. Please contact a qualified electrician to check your wiring and breakers/fuses to ensure that there is adequate electrical power to operate the vacuum pump.
- All VacStar units (except VacStar 40) must be connected to a grounded metal, permanent wiring system, or an equipment grounding conductor must be run with the circuit conductors and connected to the equipment- Grounding/Protective Earth lead on the VacStar pump's flexible metal conduit power supply. Failure to do so can result in fire, electric shock, injury, or death.
- All VacStar VS20's can be configured to run on 120 VAC or 220 VAC. The VacStar VS20 is configured from the factory to run on 220 VAC. See below on how to configure for 120 VAC operation.
- All VacStar VS40's are wired with a supplied hospital grade NEMA 6-15P line cord and requires a hospital grade 6-15R receptacle. The VacStar 40 is wired with a supplied hospital grade NEMA 6-15P line cord and requires a grounded hospital grade 6-15R receptacle located near the unit. Outlet must meet all local codes and ordinances.
- All VacStar units (except VacStar 40) must be connected to a grounded metal, permanent wiring system, or an equipment grounding conductor must be run with the circuit conductors and connected to the equipment grounding lead in the VacStar's flexible metal conduit power supply. Failure to do so can result in fire, electric shock, injury, or death.

ALL INSTALLATIONS MUST CONFORM TO LOCAL CODES

VS40 220V Connections

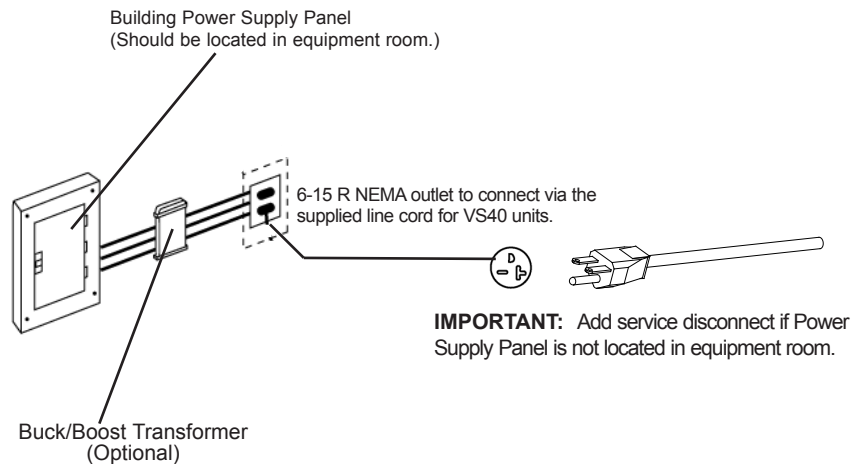
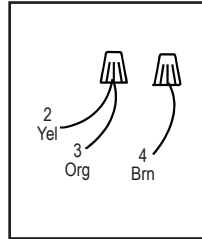

Figure 9. VacStar 40 Electrical Connection Line Cord

24V Connections

Connection without 24V Switch



Interior Electrical Box Connections

Connection to 24V Switch Only

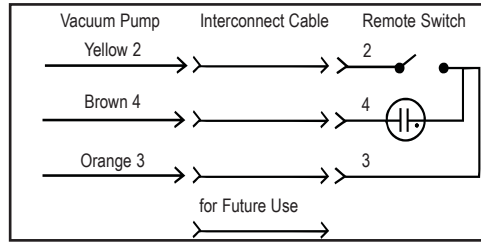

Use 18 Gauge, 4 Conductor, Interconnect Cable Between VacStar Pump and Remote Switch

VS20 120 or 220V Connections

Handy Box Connection
(Box not supplied)

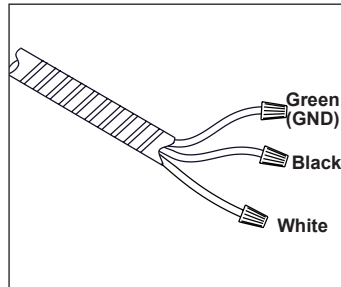

Internal Dual Voltage Jumpers
220 V, factory set Jumper Tabs
position shown below

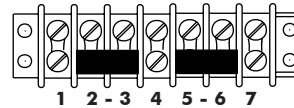

For 120 V, change by placing Jumper Tabs in position shown

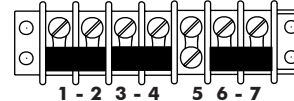

VacStar 50, 50H, 80, 80H 220V Power Connection

Handy Box Connection
(Box not supplied)

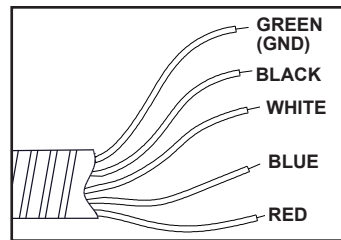

Dual Circuit	
Pumps	Power Leads
RIGHT	(L1) BLACK (L2) WHITE
LEFT	(L1) RED (L2) BLUE
Ground	(GND) GREEN

Note: For Single Circuit, connect Black, Red and (L1) wires from branch circuit together. Connect White, Blue and (L2) wires from branch circuit together. Connect Green to Ground/Protective Earth wires from branch circuit together (GND).

Figure 10. VacStar Electrical Connections

PRODUCT SPECIFICATIONS/DIMENSIONS

Spec/Dimension	VacStar Models																	
	VS20			VS40			VS50			VS50H			VS80			VS80H		
ELECTRICAL																		
Voltage Rating	*120/220			220			220			220			220			220		
Voltage Minimum/Maximum	*108/132 198/242			198/242			198/242			198/242			198/242			198/242		
Full Load Amps	*16/8			13.4			16			16			26.8			26.8		
Frequency	60			50/60			60			60			50/60			50/60		
WATER																		
Inlet Water Pressure (PSI)	20 - 100			20 - 100			20 - 100			20 - 100			20 - 100			20 - 100		
Flow Rate Per Pump (gal/min) w/HydroMiser	0.12			0.18			N/A			0.12			N/A			0.18		
Flow Rate Per Pump (gal/min) w/o HydroMiser	0.50			0.75			0.50			N/A			0.75			N/A		
Water Temperature (°F)	40 - 75			40 - 75			40 - 75			40 - 75			40 - 75			40 - 75		
VACUUM LEVEL	Preset at Factory to 10 In Hg. (Adjustable between 8 and 15 In Hg)																	
MINIMUM AIRFLOW (SCFM @ 0 In Hg)	15			20			30			30			40			40		
SHIPPING WEIGHT (lbs)	68			85			160			170			200			210		
DIMENSIONS Inches	H	W	D	H	W	D	H	W	D	H	W	D	H	W	D	H	W	D
	14	11	11	17	11	11	22	28	16	25	28	16	22	28	16	25	28	16

* VacStar 20 may be converted from 220 Volts (Factory Set) to 120 Volts at installation site. See Figure 9.

SITE REQUIREMENTS

Environment Conditions:

Operating Conditions:

Indoor use at altitudes up to 2000m

Temperature 5 to 40° C (41 to 104° F).

Maximum relative humidity 80% for temperatures up to 31° C, decreasing linearly to 50% relative humidity at 40° C.

Supply voltage fluctuation of +/- 10% of nominal voltage.

Storage and Transport:

Temperature, -18 to 65°C (0 to 150°F)..

Relative Humidity, 0 to 90%.

IEC 60601-1 Classification

Not suitable for use in the presence of a flammable anesthetic mixture with air or with oxygen or nitrous oxide.

Class I Installation Category

Ordinary equipment (IPXO). Does not protect against ingress of water.

Unit is suitable for continuous operation.

SITE REQUIREMENTS

Requirement	VacStar Models					
ELECTRICAL	VS20	VS40	VS50	VS50H	VS80	VS80H
Minimum Circuit Breaker Rating	30A(120V) 20A(220V)	20A	2 ea. 15A or 1 @ . 30A	2 ea. 15A or 1 @ 30A	2 ea. 20A or 1 @ 40A	2 ea. 20A or 1 @ 40A
Wire Size AWG (Minimum Gauge)	10(120V) 12(220V)	12	2 ea. #14 or 1 @ #10	2 ea. #14 or 1 @ #10	2 ea. 12 or 1 @ #8	2 ea. 12 or 1 @ #8
PLUMBING						
Minimum CFM @ 0" Hg	16	22	32	32	44	44
Air Exhaust	2" schedule 40 pipe	2" schedule 40 pipe	2" schedule 40 pipe	2" schedule 40 pipe	2" schedule 40 pipe	2" schedule 40 pipe
Ambient Temperature	40 - 104°F (5 - 40°C)	40 - 104°F (5 - 40°C)	40 - 104°F (5 - 40°C)	40 - 104°F (5 - 40°C)	40 - 104°F (5 - 40°C)	40 - 104°F (5 - 40°C)
<u>Overhead Plumbing</u>						
Main Line Minimum/Maximum Inside Diameter (inches)	1 / 1½	1¼ / 2	1¼ / 1½	1¼ / 1½	1½ / 2	1½ / 2
End Fitting Maximum	¾" FNPT	¾" FNPT	1" FNPT	1" FNPT	1" FNPT	1" FNPT
Riser Diameter Overhead Main Line	½" ID	½" ID	½" ID	½" ID	½" ID	½" ID
<u>Floor Plumbing</u>						
Main Line Minimum/Maximum Inside Diameter (inches)	1 / 1½	1¼ / 2	1¼ / 1½	1¼ / 1½	1½ / 2	1½ / 2
End Fitting Maximum	¾" FNPT	¾" FNPT	1" FNPT	1" FNPT	1" FNPT	1" FNPT
Branch Line Diameter Minimum/Maximum Inside Diameter (inches)	¾ / 1½	1 / 1½	1 / 1½	1 / 1½	1 / 1½	1 / 1½

NOTE: Suction piping must slope at least a ¼" for each 10 feet of run towards the pump.
Use PVC Schedule 40 or Copper Type M.

ALL INSTALLATIONS MUST CONFORM TO LOCAL CODES

REPLACEMENT/REORDER

DESCRIPTION	MODEL	PART NUMBER
Solids Collector Replacement Kit	VacStar 20, 40	55880 (¾ inch)
	VacStar 50, 50H, 80, 80H	55094 (1 inch)
In-Line Filter Replacement Kit	All VacStar Models	55094
Baseplate O-ring	All VacStar Models	55321
Baseplate and O-ring Kit	All VacStar Models	56361

TROUBLESHOOTING

PROBLEM	POSSIBLE CAUSE	POSSIBLE SOLUTIONS
1. Low suction.	<ul style="list-style-type: none"> a. Water filter or solids collector clogged. b. Check valves are stuck. c. Low water pressure. d. HydroMiser water recycler is clogged. e. HydroMiser clogged. f. Solenoids not operating. g. Restricted air exhaust. 	<ul style="list-style-type: none"> a. Clean/replace filter and/or collector. b. Use a system cleaner like CleanStream; turn vacuum on and off to free check valve. If valve remains stuck, call your authorized Air Techniques dealer for repair service. c. Raise water pressure. d. Open bypass valve to run VacStar. Call your authorized Air Techniques dealer for repair service. e. Call your authorized Air Techniques dealer for repair service. f. Open bypass valve to run VacStar. Call your authorized Air Techniques dealer for repair service. g. Check air exhaust pipe size to make sure it conforms to specification; check for and clear possible restrictions in air exhaust system.
2 No suction.	<ul style="list-style-type: none"> a. Pumps off. b. Pumps not running. c. Inlet check valves stuck closed. d. Water inlet filter and/or solids collector clogged. e. Suction hose collapsed. f. Solenoids not operating. g. Water off. 	<ul style="list-style-type: none"> a. Turn pumps on. b. Call your authorized Air Techniques dealer for repair service. c. Call your authorized Air Techniques dealer for repair service. d. Clean/replace filter. e. Hose needs to be replaced, call your authorized Air Techniques dealer for repair service. f. Call your authorized Air Techniques dealer for repair service. g. Turn water on via water inlet valve.
3. Excessive suction.	<ul style="list-style-type: none"> a. Relief valve stuck closed. b. Relief valve filter clogged. c. Relief valve set too high. 	<ul style="list-style-type: none"> a. Call your authorized Air Techniques dealer for repair service. b. Call your authorized Air Techniques dealer for repair service. c. Lower Relief valve setting.
4 Pumps do not run	<ul style="list-style-type: none"> a. Main circuit breakers off. b. Electrical problem. 	<ul style="list-style-type: none"> a. Turn main circuit breakers on. b. Call your authorized Air Techniques dealer for repair service.
5 Noisy pumps.	<ul style="list-style-type: none"> a. Inadequate water supply. b. HydroMiser eductor clogged. c. Drain line collapsed. d. Solenoids not operating. 	<ul style="list-style-type: none"> a. Call plumber to improve water supply system. b. Call your authorized Air Techniques dealer for repair service. c. Hose needs to be replaced. Call your authorized Air Techniques dealer for repair service. d. Call your authorized Air Techniques dealer for repair service.

ACCESSORIES/OPTIONS

Description	Model	Part Number
HydroMiser Wall Mount Kit	VacStar 50H, 80H	55087
Remote Control Panels with 24V switches:		
1-Switch Plate Kit		53111
2-Switch Plate Kit	All VacStar Models	53251
3-Switch Plate Kit		53250
4-Switch Plate Kit		53133
Remote Control Water Valve, with filter	All VacStar Models	53020 (24V) - 3 4" pipe 53020-1 (120V) - 3 4" pipe 53170 (24V) - 1" pipe 53171 (120V) - 1" pipe
HydroMiser Kit	VacStar 20 VacStar 40 VacStar 50 VacStar 80	H-2 H-4 56041 56042
Air/Water Separator	VacStar 20, 40, 50, 80	55540
In-Line Filter Kit	VacStar 20, 40 VacStar 50, 50H, 80, 80H	55078 - 3 4" pipe 55079 - 1" pipe
CleanStream Evacuation System Cleaner	All VacStar Models	57660 Starter Kit 57640 1 Box of 32 Packets

Like all precision products, your **VacStar™** requires a certain amount of care on a regularly scheduled basis. A well-organized maintenance program aids dependable equipment operation and reduces problems to a minimum. Routine checks help to detect general overall wear, and replacement of parts can often be made before a problem occurs.

Consequently, we have established minimum maintenance requirements listed below that include routine inspections and the replacement of filters. Adherence to this recommended maintenance schedule will ensure that the equipment will continue performing at its best with uninterrupted service.

❑ **Daily Maintenance - Clean vacuum lines**

Flush all vacuum lines and tubing in the dental system with Monarch CleanStream Evacuation System Cleaner.

❑ **Routine Inspection - Monthly**

1. Check tubing for kinks or cracks.
2. Check for abnormal noises and leaks.
3. Dual Units: Make sure both motors are running
4. Check exterior surfaces for dirt and debris, clean if necessary.
5. Make sure that no flammable, corrosive, or combustible materials are stored in the equipment room (especially in the area around the equipment).
6. Refer to Figure 11 and check the vacuum relief valve filter, clean if necessary.

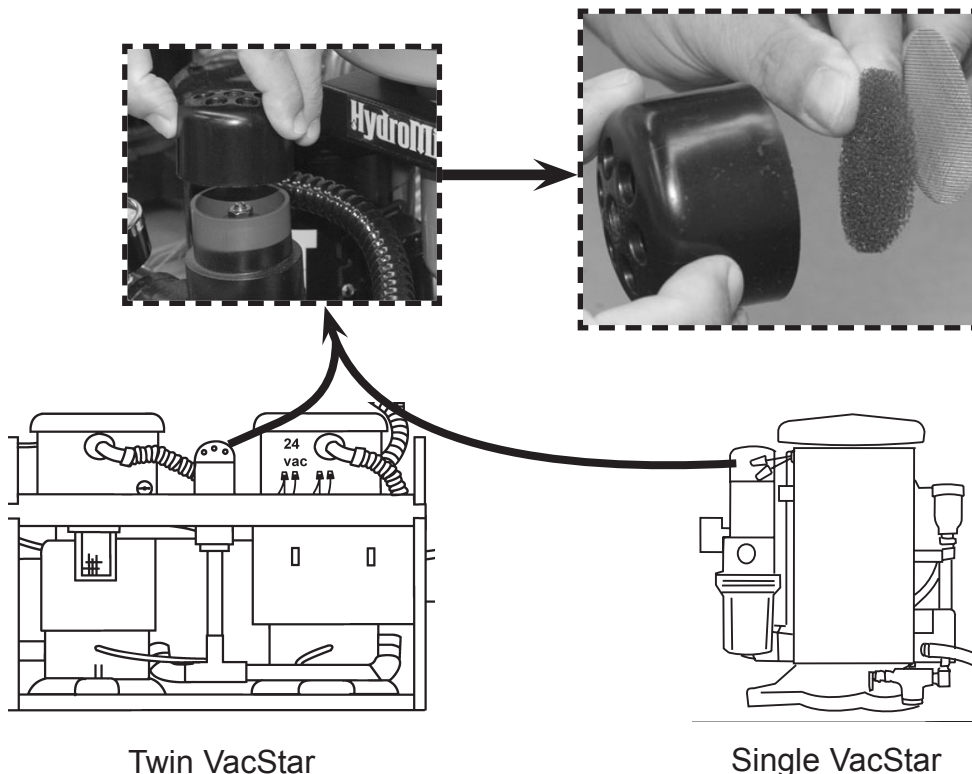

Figure 11. Vacuum Relief Valve Filter Location

MAINTENANCE

Caution: Solids collector may contain biologically hazardous material. Wear protective gloves. Dispose of waste in approved bio-hazard container.

Important: When a VacStar is replacing another vacuum pump, clean the collector DAILY during the first week of operation since larger quantities of particulates may initially occur.

A worn or missing gasket and/or failure to tightly screw the bowl to the solids collector body will cause poor suction due to air leakage.

DO NOT OPERATE THE VACSTAR WITHOUT THE SCREEN INSIDE THE FILTER BOWL.

☐ Intake Solids Collector Replacement - Monthly

Refer to Figure 12 and using the replacement kit listed below for the specific **VacStar™** models, replace the solids bowl, screen and gasket. Do the same replacement if using an optional in-line filter.

VacStar Model	Solids Collector Kit Part No.	Optional In-Line Filter Kit Part No.
VS20 & VS40	55880	55094
VS50, VS50H, VS80 & VS80H	55094	55094

Replacement Procedure

1. Turn off the power and water supply.
2. Unscrew the solids bowl (counter clock-wise) and remove the screen and gasket. Dispose of all three items.
3. Assemble a new bowl, screen and gasket included in the Solids Collector Replacement Kit.
4. Install the new solids collector by screwing the bowl into the solids collector body.



Figure 12. Intake Solids Collector Location

❑ **Check/Clean Solenoid Water Inlet Strainer - Semi-Annually**

Check the Inlet Strainer for dirt and debris by performing the following steps.

1. Turn off the power and water supply to the equipment.
2. Use a 1 3/16 inch wrench to unscrew (turn counter clockwise) the cover nut.
3. Remove the cover nut and strainer.
4. Inspect the strainer and clean as necessary.

**VacStar Models
VS20 and VS40**

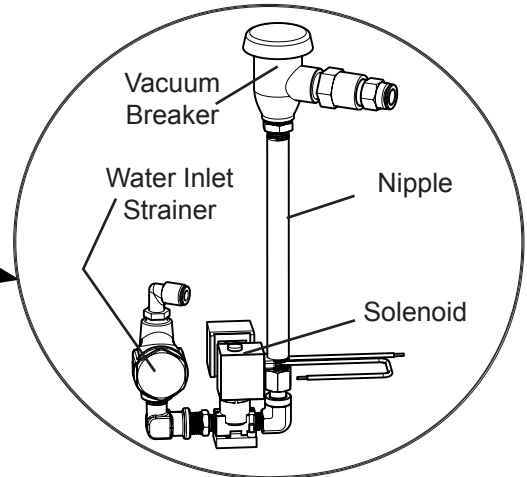
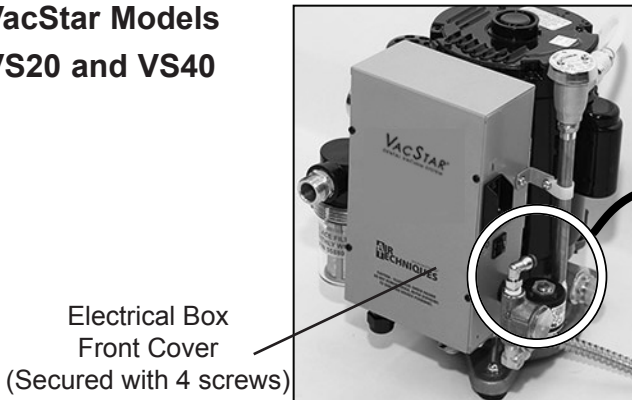

Water System Assembly, 55689

**VacStar Models
VS50, VS50H,
VS80 and VS80H**

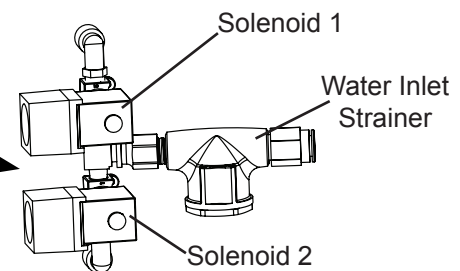
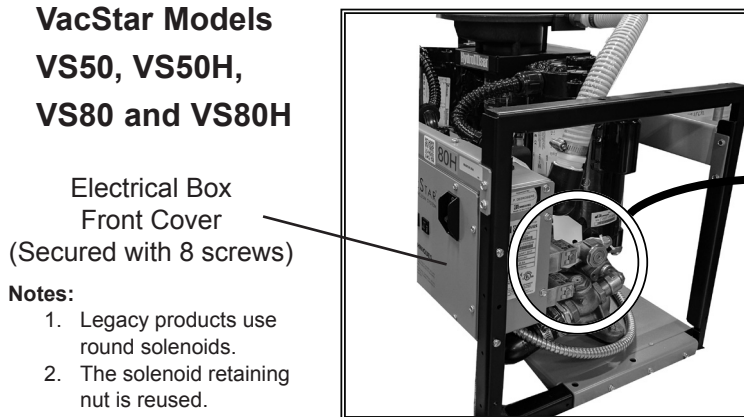

Solenoid and Water Inlet Strainer
Assembly, 55063

Figure 13. Water Inlet Strainer Location

Assembling the Water Inlet Strainer (All Models)

1. Orienting the assembly with the cover nut facing down as shown, seat strainer into the cover nut.
2. Insert the strainer up into the strainer body and tighten the cover nut.
3. Make sure the strainer stays perpendicular to the strainer body.
4. Push up and tighten the cover nut making sure not over tighten.

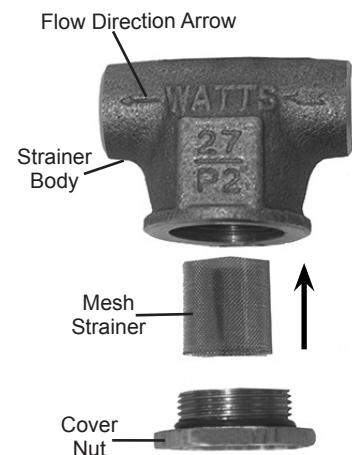

NOTES

For over 50 years, Air Techniques has been a leading innovator and manufacturer of dental products. Our priority is ensuring complete satisfaction by manufacturing reliable products and providing excellent customer and technical support. Whether the need is digital imaging, utility room equipment or merchandise, Air Techniques can provide the solution via our network of authorized professional dealers. Proudly designed, tested and manufactured in the U.S., our products are helping dental professionals take their practices to the next level.

Air Techniques' family of quality products for the dental professional include:

- ❑ **Digital Imaging**
 - Digital Radiography
 - Intraoral Camera
 - Caries Detection Aid
 - Intraoral X-ray
 - Film Processors

- ❑ **Utility Room**
 - Dry Vacuums
 - Wet Vacuums
 - Air Compressors
 - Amalgam Separator
 - Utility Accessories
 - Utility Packages

- ❑ **Merchandise**
 - Surface Disinfectant
 - Enzymatic Cleaner
 - Hand Sanitizer and Lotion
 - Waterline Cleaner
 - Evacuation System Cleaner
 - Imaging Accessories
 - Chemistry
 - Processor Accessories

Corporate Headquarters

1295 Walt Whitman Road | Melville, New York 11747-3062 | Phone: 800-247-8324 | Fax: 888-247-8481

Western Facility

291 Bonnie Lane, Suite 101 | Corona, CA 92880 - 2804 | Phone: 800-247-8324 | Fax: 951-898-7646

www.airtechniques.com

