



WASHING MACHINE

USER'S MANUAL

GWN48430CG

EN

www.grundig.com

GRUNDIG

Document Number 2820526900/11-05-18.(14.31)

Please read these instructions first before using your appliance

Dear Customer,

Thank you for choosing a Grundig appliance.

Please take some time to read this user manual before using your appliance, to ensure you know how to safely operate the controls and functions.





Carefully follow all unpacking and installation instructions to ensure the appliance is correctly connected and fitted prior to use.

Please write your product model and serial number on the last page of this user manual, and store in a safe location close to the appliance for easy future reference.

This user manual may also be applicable for several other models. Differences between models will be listed.

If you have any questions or concerns, please call our contact centre or find help and information online at www.grundig.co.uk

Explanation of symbols used throughout this User Manual

	Important information or useful hints about usage.
	Warning for hazardous situations with regard to life and property.
	Warning for electric shock.
	Packaging materials of the product are manufactured from recyclable materials in accordance with our National Environment Regulations.

Do not dispose of the packaging materials together with the domestic or other wastes. Take them to the packaging material collection points designated by the local authorities.



Allergy UK is the operational name of **The British Allergy Foundation**. The Seal of Approval endorsement, which indicates that the product bearing it specifically restricts / reduces / removes allergens from the environment of the allergy sufferer or has significantly reduced allergen content, was created in order to provide guidance for people seeking advice in this issue. It is aimed to assure people that products had been scientifically tested or reviewed with measurable results.

TABLE OF CONTENTS

Important instructions for safety and environment	4	End Time	29
General safety	4	Starting the programme	29
Electrical safety	5	Loading door lock.	29
Product safety.	6	Changing the selections after programme has started	30
Intended use	7	Child Lock	30
Children's safety.	7	Cancelling the programme	31
Compliance with the WEEE Directive	8	End of programme.	31
Package information	8	Setting VOLUME level	31
Your washing machine	9	Your machine is equipped with a "Standby Mode"	31
Overview	9	Quick User Guide	32
Package Contents	10	Preparing the machine	32
Technical specifications	11	Programme selection	32
Installation	12	Auxiliary function selection.	32
Appropriate installation location	12	Starting the programme	32
Removing packaging reinforcement	12	End of programme.	32
Removing the transportation locks	12	Cancelling the programme	32
Connecting water supply.	13	Child Lock	32
Connecting to the drain	13	Maintenance and cleaning	33
Adjusting the feet	14	Cleaning the detergent drawer.	33
Electrical connection.	14	Cleaning the loading door and the drum	33
Preparation	16	Cleaning the body and control panel	33
Sorting the laundry	16	Cleaning the water intake filters	34
Preparing laundry for washing.	16	Draining remaining water and cleaning the pump filter.	34
Things to be done for energy saving	17	If the product has an emergency draining hose, to discharge the water:	35
Initial use.	17	Troubleshooting	36
Correct load capacity.	17		
Loading the laundry.	18		
Using detergent and softener.	18		
Tips for efficient washing	20		
Operating the product	21		
Control panel	21		
Display symbols	21		
Preparing the machine	22		
Programme selection	22		
Programmes	22		
Temperature selection	24		
Selecting the spin speed	25		
Programme and consumption table	26		
Auxiliary function selection.	28		

Important instructions for safety and environment

This section contains safety instructions that will help protect from risk of personal injury or property damage. Failure to follow these instructions shall void any warranty.

General safety

- This product can be used by children at and above **8** years old and by persons whose physical, sensory or mental capabilities are not fully developed or who lack experience and knowledge provided that they are supervised or trained on the safe usage of the product and the risks it brings out. Children must not play with the product. Cleaning and maintenance works should not be performed by children unless they are supervised by someone. Children of less than 3 years should be kept away unless continuously supervised.
- Never place the product on a carpet-covered floor. Otherwise, lack of airflow beneath the machine will cause electrical parts to overheat. This will cause problems with your product.
- Always have the repairing procedures carried out by the **Authorised Service Agent**. Manufacturer shall not be held liable for damages that may arise from procedures carried out by unauthorised persons.

Electrical safety

- If the product has a failure, it should not be operated unless it is repaired by the Authorised Service Agent. There is the risk of electric shock!
- This product is designed to resume operating in the event of powering on after a power interruption. If you wish to cancel the programme, see "Cancelling the programme" section.
- Connect the product to a grounded outlet protected by a 13 A fuse. Have the grounding installation made by a qualified electrician. Our company shall not be liable for any damages that will arise when the product is used without grounding in accordance with the local regulations.
- nplug the product when not in use.
- Never wash the product by spreading or pouring water onto it! There is the risk of electric shock!
- Never touch the plug with wet hands! Never unplug by pulling on the cable, always pull out by grabbing the plug.
- Unplug the product during installation, maintenance, cleaning and repairing procedures.
- If the power cable is damaged, it must be replaced by the manufacturer, after sales service or a similarly qualified person (preferably an electrician) or someone designated by the importer in order to avoid possible risks.

Product safety

- The water supply and draining hoses must be securely fastened and remain undamaged. Otherwise, there is the risk of water leakage.
- Never open the loading door or remove the filter while there is still water in the drum. Otherwise, risk of flooding and injury from hot water will occur.
- Do not force open the locked loading door. The loading door will be ready to open just a few minutes after the washing cycle comes to an end. In case of forcing the loading door to open, the door and the lock mechanism may get damaged.
- Use detergents, softeners and supplements suitable for automatic washing machines only.
- Follow the instructions on the textile tags and on the detergent package.
- Place the product on a rigid, flat and level surface.
- Do not place it on a long-pile rug or similar surfaces.
- Do not place the product on a high platform or near the edge on a cascaded surface.
- Do not place the product on the power cable.
- Never use sponge or scrub materials. These will damage the painted, chrome plated and plastic surfaces.

Intended use

- This product has been designed for domestic use. It is not suitable for commercial use and it must not be used for anything other than its intended use.
- Use the product only for washing and rinsing of textile products that are marked accordingly.
- The manufacturer waives any responsibility arisen from incorrect usage or transportation.

Children's safety

- Packaging materials are dangerous to children. Keep packaging materials in a safe place away from reach of the children.
- Electrical products are dangerous to children. Keep children away from the product when it is in use. Do not let them to tamper with the product. Use child lock to prevent children from intervening with the product.
- Do not forget to close the loading door when leaving the room where the product is located.
- Store all detergents and additives in a safe place away from the reach of the children by closing the cover of the detergent container or sealing the detergent package.



While washing the laundry at high temperatures, the loading door glass becomes hot. Therefore, keep children away from the loading door of the machine while the washing operation is in progress.

Compliance with the WEEE Directive



This product complies with EU WEEE Directive (2012/19/EU). This product bears a classification symbol for waste electrical and electronic equipment (WEEE).

This product has been manufactured with high quality parts and materials which can be reused and are suitable for recycling.

Do not dispose of the waste product with normal domestic and other wastes at the end of its service life. Take it to the collection center for the recycling of electrical and electronic equipment. Please consult your local authorities to learn about these collection centers.

Compliance with RoHS Directive:

The product you have purchased complies with EU RoHS Directive (2011/65/EU). It does not contain harmful and prohibited materials specified in the Directive.

Package information

- Packaging materials of the product are manufactured from recyclable materials in accordance with our National Environment Regulations. Do not dispose of the packaging materials together with the domestic or other wastes. Take them to the packaging material collection points designated by the local authorities.

Your washing machine

Overview

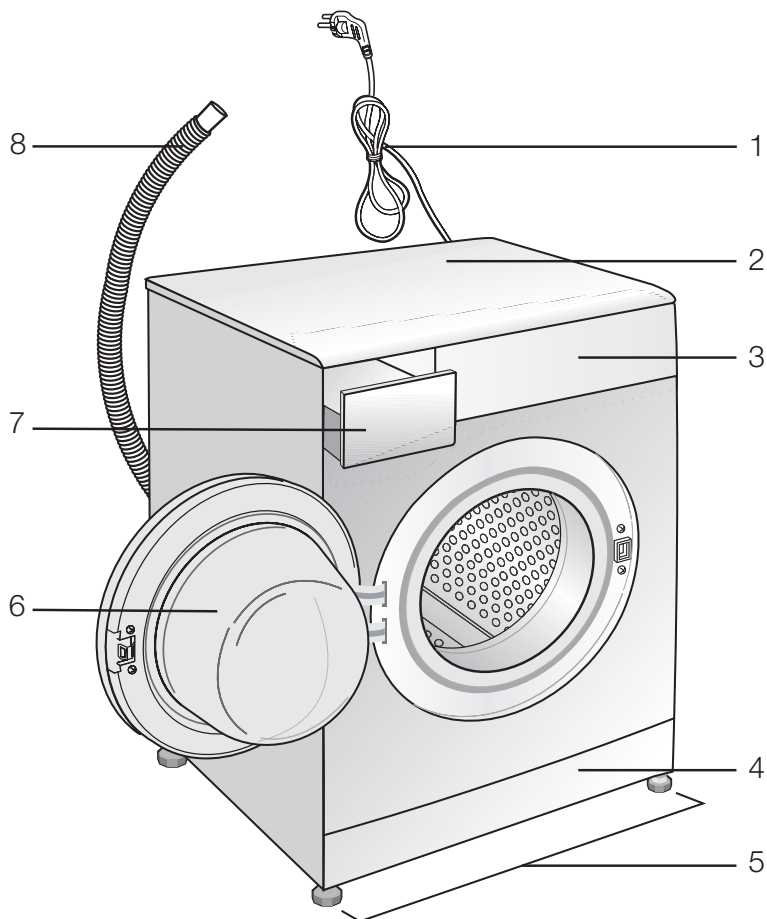

- 1- Power cable
- 2- Top panel
- 3- Control panel
- 4- Filter cap
- 5- Adjustable feet
- 6- Loading door
- 7- Detergent drawer
- 8- Drain hose

Package Contents

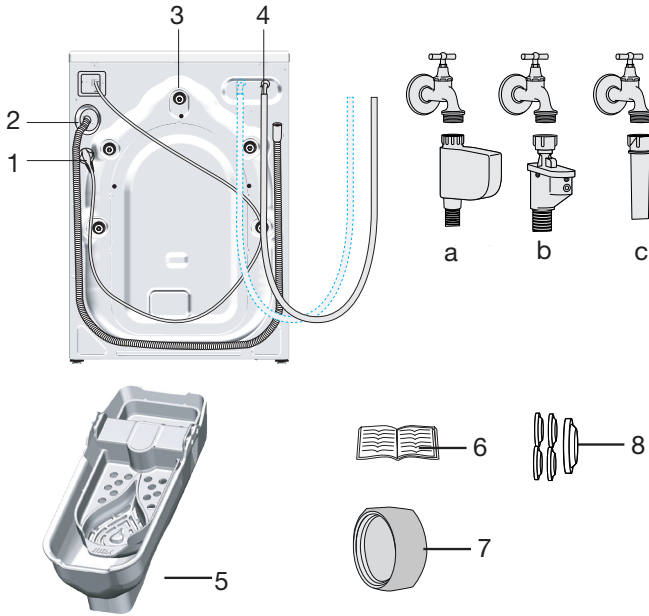

- 1- Power cable
 - 2- Drain hose
 - 3- Transportation safety bolts *
 - 4- Mains water inlet hose (One of the following filter types is used for the mains hose connection.)
 - a- Electronic water shut-off
 - b- Mechanical water shut-off
 - c- Standard
 - 5- Liquid detergent container**
 - 6- User Manual
 - 7- Blind plug***
 - 8- Plastic plug group
- * Number of transportation safety bolts may change depending on the model of your machine.
- ** This may be supplied with the machine depending on the model of your machine.
- *** This is supplied if your machine is equipped with double water inlet.

Technical specifications

Complying Commission Delegated Regulation (EU) No 1061/2010

Supplier name or trademark	GRUNDIG
Model name	GWN48430CG
Rated capacity (kg)	8
Energy efficiency class / Scale from A+++ (Highest Efficiency) to D (Lowest Efficiency)	A+++
Annual Energy Consumption (kWh) ⁽¹⁾	192
Energy consumption of the standard 60°C cotton programme at full load (kWh)	0,920
Energy consumption of the standard 60°C cotton programme at partial load (kWh)	0,805
Energy consumption of the standard 40°C cotton programme at partial load (kWh)	0,805
Power consumption in 'off-mode' (W)	0,440
Power consumption in 'left-on mode' (W)	0,640
Annual Water Consumption (l) ⁽²⁾	9900
Spin-drying efficiency class / Scale from A (Highest Efficiency) to G (Lowest Efficiency)	B
Maximum spin speed (rpm)	1400
Remaining moisture Content (%)	53
Standard cotton programme ⁽³⁾	Cotton Eco 60°C and 40°C
Programme time of the standard 60°C cotton programme at full load (min)	205
Programme time of the standard 60°C cotton programme at partial load (min)	177
Programme time of the standard 40°C cotton programme at partial load (min)	177
Duration of the left-on mode (min)	N/A
Airborne acoustical noise emissions washing/spinning (dB)	52/76
Built-in	No
Height (cm)	84
Width (cm)	60
Depth (cm)	65
Net weight (±4 kg.)	75
Single Water inlet / Double Water inlet	• / -
Electrical input (V/Hz)	230 V / 50Hz
Total current (A)	10
Total power (W)	2200
Main model code	978

⁽¹⁾ Energy Consumption based on 220 standard washing cycles for cotton programmes at 60°C and 40°C at full and partial load, and the consumption of the low-power modes. Actual energy consumption will depend on how the appliance is used.





⁽²⁾ Water consumption based on 220 standard washing cycles for cotton programmes at 60°C and 40°C at full and partial load. Actual water consumption will depend on how the appliance is used.

⁽³⁾ „Standard 60°C cotton programme“ and the „standard 40°C cotton programme“ are the standard washing programmes to which the information in the label and the fiche relates and these programmes are suitable to clean normally soiled cotton laundry and that they are the most efficient programmes in terms of combined energy and water consumption.

Technical specifications may be changed without prior notice to improve the quality of the product.

Installation

To make the product ready for use, review the information in the user manual and make sure that the electricity, tap water supply and water drainage systems are appropriate. If they are not, call a qualified technician and plumber to have any necessary arrangements carried out.

	Preparation of the location and electrical, tap water and waste water installations at the place of installation is under customer's responsibility.
	WARNING: Installation and electrical connections of the product must be carried out by competent persons. Manufacturer shall not be held liable for damages that may arise from procedures carried out by unauthorized persons.
	WARNING: Prior to installation, visually check if the product has any defects on it. If so, do not have it installed. Damaged products cause risks for your safety.
	Make sure that the water inlet and discharge hoses as well as the power cable are not folded, pinched or crushed while pushing the product into its place after installation or cleaning procedures.

Appropriate installation location

- Place the machine on a rigid floor. Do not place it on a long pile rug or similar surfaces.
- Total weight of the washing machine and the dryer -with full load- when they are placed on top of each other reaches to approx. 180 kilograms. Place the product on a solid and flat floor that has sufficient load carrying capacity!
- Do not place the product on the power cable.
- Do not install the product at places where temperature may fall below 0°C.
- Leaving a gap at the sides of the machine is suggested to reduce vibration and noise

- Do not place heat sources such as Hobs, Irons, Ovens, etc. on the washing machine and do not use them on the product.

Removing packaging reinforcement

Tilt the machine backwards to remove the packaging reinforcement. Remove the packaging reinforcement by pulling the ribbon.



Removing the transportation locks



WARNING: Do not remove the transportation locks before taking out the packaging reinforcement.



WARNING: Remove the transportation safety bolts before operating the washing machine! Otherwise, the product will be damaged.

- Loosen all the bolts with a suitable spanner until they rotate freely.

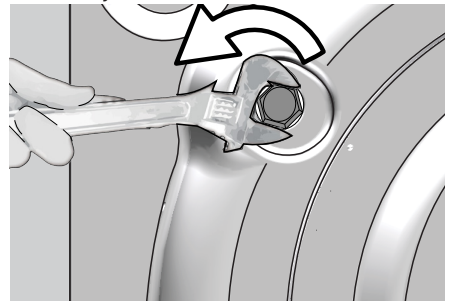

- Remove transportation safety bolts by turning them gently.

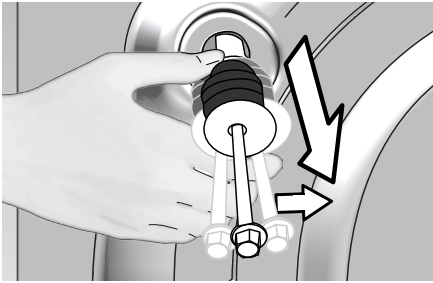

- Attach the plastic covers supplied in the User Manual bag into the holes on the rear panel.

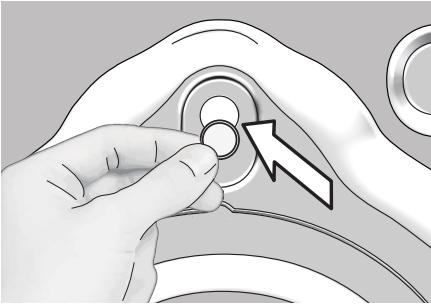

Keep the transportation safety bolts in a safe place to reuse when the washing machine needs to be moved again in the future.

Never move the product without the transportation safety bolts properly fixed in place!

- Tighten all hose nuts by hand. Never use a tool when tightening the nuts.

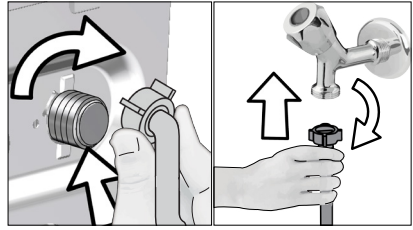

- Open the taps completely after making the hose connection to check for water leaks at the connection points. If any leaks occur, turn off the tap and remove the nut. Retighten the nut carefully after checking the seal. To prevent water leakages and damages caused by them, keep the taps closed when the machine is not in use.

Connecting to the drain

- The end of the drain hose must be directly connected to the wastewater drain or to the washbasin.



WARNING: Your house will be flooded if the hose comes out of its housing during water discharge. Moreover, there is risk of scalding due to high washing temperatures! To prevent such situations and to ensure smooth water intake and discharge of the machine, fix the end of the discharge hose tightly so that it cannot come out.

- The hose should be attached to a height of at least 40 cm, and 100 cm at most.
- In case the hose is elevated after laying it on the floor level or close to the ground (less than 40 cm above the ground), water discharge becomes more difficult and the laundry may come out excessively wet. Therefore, follow the heights described in the figure.

Connecting water supply



The water supply pressure required to run the product is between 1 to 10 bars (0.1 – 1 MPa). It is necessary to have 10 – 80 liters of water flowing from the fully open tap in one minute to have your machine run smoothly. Attach a pressure reducing valve if water pressure is higher.



WARNING: Models with a single water inlet should not be connected to the hot water tap. In such a case the laundry will get damaged or the product will switch to protection mode and will not operate.



WARNING: Do not use old or used water inlet hoses on the new product. It may cause stains on your laundry.

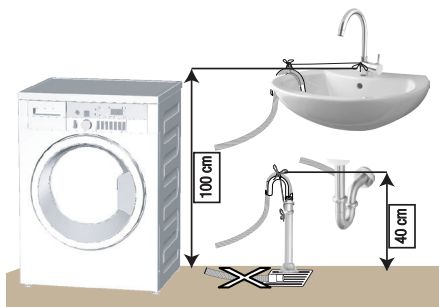

- To prevent flowing of dirty water back into the machine and to allow for easy discharge, do not immerse the hose end into the dirty water or do not drive it in the drain more than 15 cm. If it is too long, cut it short.
- The end of the hose should not be bent, it should not be stepped on and the hose must not be pinched between the drain and the machine.
- If the length of the hose is too short, use it by adding an original extension hose. Length of the hose may not be longer than 3.2 m. To avoid water leak failures, the connection between the extension hose and the drain hose of the product must be fitted well with an appropriate clamp as not to come off and leak.

Adjusting the feet



WARNING: In order to ensure that the product operates more silently and vibration-free, it must stand level and balanced on its feet. Balance the machine by adjusting the feet. Otherwise, the product may move from its place and cause crushing and vibration problems.

- Loosen the lock nuts on the feet by hand.

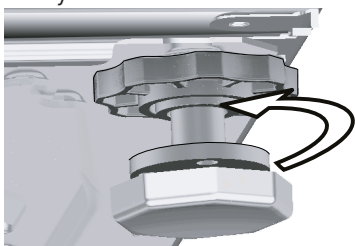

- Adjust the feet until the product stands level and balanced.

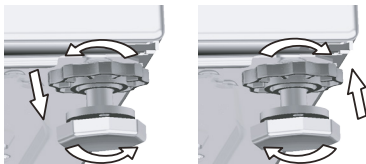

- Tighten all lock nuts again by hand.

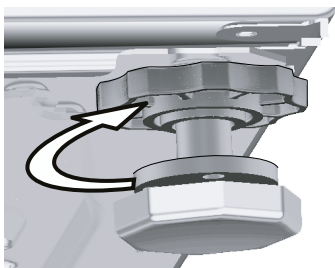

WARNING: Do not use any tools to loosen the lock nuts. Otherwise, they will get damaged.

Electrical connection

Connect the product to a grounded outlet protected by a 16 A fuse. Our company shall not be liable for any damages that will arise when the product is used without grounding in accordance with the local regulations.

- Connection must comply with national regulations.
- The wiring for the electrical outlet circuit must be sufficient to meet the appliance requirements. Use of a Ground Fault Circuit Interrupter (GFCI) is recommended.
- Power cable plug must be within easy reach after installation.
- If the current value of the fuse or breaker in the house is less than 16 Amps, have a qualified electrician install a 16 Amp fuse.
- The voltage specified in the "Technical specifications" section must be equal to your mains voltage.
- Do not make connections via extension cables or multi-plugs.



WARNING: Damaged power cables must be replaced by the Authorized Service Agents.

Electrical requirements

Before you insert the plug into the wall socket make sure that the voltage and the frequency shown in the rating label corresponds to your electricity supply. We recommend that this appliance be connected to the mains supply via a suitable switched and fused socket in a readily accessible position. Should the mains lead of the appliance become damaged or need replacing at any time, it must be replaced by a special purpose made mains lead which can only be obtained from a Authorised Service Agent.



WARNING: This appliance must be earthed.

If the fitted moulded plug is not suitable for your socket, then the plug should be cut off and an appropriate plug fitted.

Destroy the old plug, which is cut off as a plug with a bared cord could cause a shock hazard if inserted into a socket elsewhere in the house.

The moulded plug on this appliance incorporates a 13A fuse. Should the fuse need to be replaced an ASTA approved BS1362 fuse of the same rating must be used. Do not forget to refit the fuse cover. In the event of losing the fuse cover, the plug must not be used until a replacement fuse cover has been fitted. Colour of the replacement fuse cover must be the same colour as that visible on the pin face of the plug. Fuse covers are available from any good electrical store.

Important

Fitting a different plug

As the colours of the wires in the mains lead of this appliance may not correspond with the coloured markings identifying the terminals on your plug, proceed as follows:

- 1 Connect the green - yellow or green (earth) wire to the terminal in the plug marked 'E' or with the symbol or coloured green and yellow or green.
- 2 Connect the blue (neutral) wire to the terminal in the plug marked 'N' or coloured black.

- 3 Connect the brown (live) wire to the terminal in the plug marked 'L' or coloured red.

With the alternative plugs a 13A fuse must be fitted either in the plug or adaptor or in the main fuse box. If in doubt contact a qualified electrician.

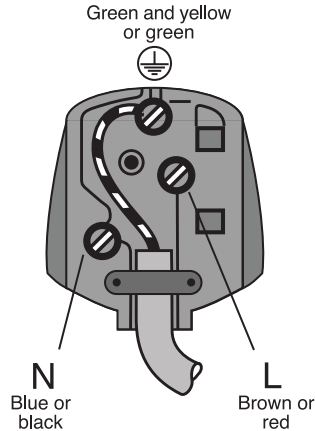

Transportation of the product

- Unplug the product before transporting it.
- Remove water drain and water supply connections.
- Drain all water that has remained in the product.
- Install transportation safety bolts in the reverse order of removal procedure; .



Never move the product without the transportation safety bolts properly fixed in place!































WARNING: Packaging materials are dangerous to children. Keep packaging materials in a safe place away from reach of the children.

Preparation

Sorting the laundry

- Sort laundry according to type of fabric, colour, and degree of soiling and allowable water temperature.
- Always obey the instructions given on the garment tags.

LAUNDRY WASH SYMBOLS											
 Machine Wash Symbols	 Normal wash	 No Iron	 Sensitive-Delicate wash	 Hand wash	 Not washable	 No Spin	WASH				
							Water Temperatures	Maximum	95°C	70°C	60°C
	Symbol(s)	•••	•••	••	•••	••	•				
 Drying Symbols	 Suitable for dryer	 No Iron	 Sensitive / Delicate dry	 Do not dry with dryer	 Do not dry	 Do not dry-clean	DRYING				
							Drying Settings	 At any temperature	 At high temperature	 At medium temperature	 At low temperature
 IRON	Iron -		 Iron at high temperature	 Iron at medium temperature	 Iron at low temperature	 Do not iron	 Iron without steam	BLEACH			
	Dry or Steam	Maximum temperature						200 °C	150 °C	110 °C	
	 All bleaches are allowed	 Bleach (sodium hypochlorite) can be used		 Bleach is not allowed		 Only bleaches without chlorine are allowed					

Preparing laundry for washing

- Laundry items with metal attachments such as, underwired bras, belt buckles or metal buttons will damage the machine. Remove the metal pieces or wash the clothes by putting them in a laundry bag or pillow case.
- Take out all items in the pockets such as coins, pens and paper clips, and turn pockets inside out and brush. Such objects may

damage the product or cause noise problem.

- Put small size clothes such as infant's socks and nylon stockings in a laundry bag or pillow case.
- Place curtains in without compressing them. Remove curtain attachment items.
- Fasten zippers, sew loose buttons and mend rips and tears.
- Wash "machine washable" or "hand washable" labelled

products only with an appropriate programme.

- Do not wash colours and whites together. New, dark coloured cottons release a lot of dye. Wash them separately.
- Tough stains must be treated properly before washing. If unsure, check with a dry cleaner.
- Use only dyes/colour changers and limescale removers suitable for machine wash. Always follow the instructions on the package.
- Wash trousers and delicate laundry turned inside out.
- Keep laundry items made of Angora wool in the freezer for a few hours before washing. This will reduce pilling.
- Laundry that are subjected to materials such as flour, lime dust, milk powder, etc. intensely must be shaken off before placing into the machine. Such dusts and powders on the laundry may build up on the inner parts of the machine in time and can cause damage.

Things to be done for energy saving

Following information will help you use the product in an ecological and energy-efficient manner.

- Operate the product in the highest capacity allowed by the programme you have selected, but do not overload; , "Programme and consumption table".
- Always follow the instructions on the detergent packaging.
- Wash slightly soiled laundry at low temperatures.
- Use faster programmes for small quantities of lightly soiled laundry.
- Do not use prewash and high temperatures for laundry that is not heavily soiled or stained.
- If you plan to dry your laundry in a dryer, select the highest spin speed recommended during washing process.
- Do not use detergent in excess of the amount recommended on the detergent package.

Initial use

Before starting to use the product, make sure that all preparations are completed in accordance with the instructions in sections "Important safety and environment instructions" and "Installation".

To prepare the product for washing laundry, perform first operation in Drum Cleaning programme. If your machine is not featured with this programme, apply the method described in .



Use an anti-limescale suitable for the washing machines.

Some water might have remained in the product due to the quality control processes in the production. It is not harmful for the product.

Correct load capacity

The maximum load capacity depends on the type of laundry, the degree of soiling and the washing programme desired.

The machine automatically adjusts the amount of water according to the weight of the loaded laundry.



WARNING: Follow the information in the "Programme and consumption table". When overloaded, machine's washing performance will drop. Moreover, noise and vibration problems may occur.

Laundry type	Weight (g)
Bathrobe	1200
Napkin	100
Duvet cover	700
Bed Sheet	500
Pillowcase	200
Tablecloth	250
Towel	200
Hand towel	100
Evening gown	200
Underclothing	100
Men's overalls	600
Men's shirt	200
Men's pyjamas	500
Blouses	100

Loading the laundry

- Open the loading door.
- Place laundry items loosely into the machine.
- Push the loading door to close until you hear a locking sound. Ensure that no items are caught in the door.



The loading door is locked while a programme is running. The door can only be opened a while after the programme comes to an end.



WARNING: In case of misplacing the laundry, noise and vibration problems may occur in the machine.

Using detergent and softener



When using detergent, softener, starch, fabric dye, bleach or limescale remover, read the manufacturer's instructions on the package carefully and follow the suggested dosage values. Use measuring cup if available.

Detergent Drawer

The detergent drawer is composed of three compartments:

- (1) for prewash
- (2) for main wash
- (3) for softener
- (*) in addition, there is siphon piece in the softener compartment.

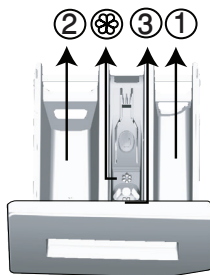

Detergent, softener and other cleaning agents

- Add detergent and softener before starting the washing programme.
- Never leave the detergent drawer open while the washing programme is running!
- When using a programme without prewash, do not put any detergent into the prewash compartment (compartment nr. „1“).

- In a programme with prewash, do not put liquid detergent into the prewash compartment (compartment nr. „1“).
- Do not select a programme with prewash if you are using a detergent bag or dispensing ball. Place the detergent bag or the dispensing ball directly among the laundry in the machine.
- If you are using liquid detergent, do not forget to place the liquid detergent cup into the main wash compartment (compartment nr. „2“).

Choosing the detergent type

The type of detergent to be used depends on the type and colour of the fabric.

- Use different detergents for coloured and white laundry.
- Wash your delicate clothes only with special detergents (liquid detergent, wool shampoo, etc.) used solely for delicate clothes.
- When washing dark coloured clothes and quilts, it is recommended to use liquid detergent.
- Wash woollens with special detergent made specifically for woollens.



WARNING: Use only detergents manufactured specifically for washing machines.



WARNING: Do not use soap powder.

Adjusting detergent amount

The amount of washing detergent to be used depends on the amount of laundry, the degree of soiling and water hardness.

- Do not use amounts exceeding the dosage quantities recommended on the detergent package to avoid problems of excessive foam, poor rinsing, financial savings and finally, environmental protection.
- Use lesser detergent for small amounts or lightly soiled clothes.

Using softeners

Pour the softener into the softener compartment of the detergent drawer.

- Do not exceed the (>max<) level marking in the softener compartment.
- If the softener has lost its fluidity, dilute it with water before putting it in the detergent drawer.

Using liquid detergents

If the product contains a liquid detergent cup:

- Place the liquid detergent cup in compartment nr. „2“.
- If the liquid detergent has lost its fluidity, dilute it with water before putting in the detergent cup.

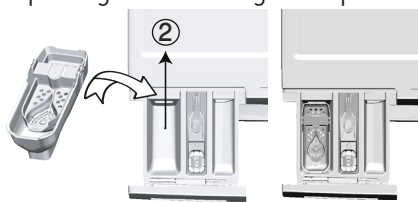

If the product does not contain a liquid detergent cup:

- Do not use liquid detergent for the prewash in a programme with prewash.
- Liquid detergent stains your clothes when used with Delayed Start function. If you are going to use the Delayed Start function, do not use liquid detergent.

Using gel and tablet detergent

- If the gel detergent thickness is fluidal and your machine does not contain a special liquid detergent cup, put the gel detergent into the main wash detergent compartment during first water intake. If your machine contains a liquid detergent cup, fill the detergent into this cup before starting the programme.
- If the gel detergent thickness is not fluidal or in the shape of capsule liquid tablet, put it directly into the drum before washing.

- Put tablet detergents into the main wash compartment (compartment nr. „2“) or directly into the drum before washing.



Tablet detergents may leave residues in the detergent compartment. If you encounter such a case, place the tablet detergent between the laundry, close to the lower part of the drum in future washings.



Use the tablet or gel detergent without selecting the prewash function.

Using starch

- Add liquid starch, powder starch or the fabric dye into the softener compartment.
- Do not use softener and starch together in a washing cycle.
- Wipe the inside of the machine with a damp and clean cloth after using starch.

Using bleaches

- Select a programme with prewash and add the bleaching agent at the beginning of the prewash. Do not put detergent in the prewash compartment. As an alternative application, select a programme with extra rinse and add the bleaching agent while the machine is taking water from the detergent compartment during first rinsing step.
- Do not use bleaching agent and detergent by mixing them.
- Use just a little amount (approx. 50 ml) of bleaching agent and rinse the clothes very well as it causes skin irritation. Do not pour the bleaching agent onto the clothes and do not use it for coloured clothes.
- When using oxygen based bleaches, select a programme that washes at a lower temperature.

- Oxygen based bleaches can be used together with detergents; however, if its thickness is not the same with the detergent, put the detergent first into the compartment nr. „2“ in the detergent drawer and wait until the detergent flows while the machine is taking in water. Add the bleaching agent from the same compartment while the machine is still taking in water.

Using limescale remover

- When required, use limescale removers manufactured specifically for washing machines only.

Tips for efficient washing

		Clothes	
		Light colours and whites	
		[Recommended temperature range based on soiling level: 40-90 °C]	
Soiling Level	Heavily Soiled (difficult stains such as grass, coffee, fruits and blood.)	It may be necessary to pre-treat the stains or perform prewash. Powder and liquid detergents recommended for whites can be used at dosages recommended for heavily soiled clothes. It is recommended to use powder detergents to clean clay and soil stains and the stains that are sensitive to bleaches.	
	Normally Soiled (For example, stains caused by body on collars and cuffs)	Powder and liquid detergents recommended for whites can be used at dosages recommended for normally soiled clothes.	
	Lightly Soiled (No visible stains exist.)	Powder and liquid detergents recommended for whites can be used at dosages recommended for lightly soiled clothes.	
		Colours	
		[Recommended temperature range based on soiling level: cold -40 °C]	

		Clothes	
Soiling Level	Heavily Soiled	Powder and liquid detergents recommended for colors can be used at dosages recommended for heavily soiled clothes. It is recommended to use powder detergents to clean clay and soil stains and the stains that are sensitive to bleaches. Detergents which do not contain bleach should be used.	
	Normally Soiled	Powder and liquid detergents recommended for colors can be used at dosages recommended for normally soiled clothes. Detergents which do not contain bleach should be used.	
	Lightly Soiled	Powder and liquid detergents recommended for colors can be used at dosages recommended for lightly soiled clothes. Detergents which do not contain bleach should be used.	
		Dark colours	
		[Recommended temperature range based on soiling level: cold -40 °C]	
Soiling Level	Heavily Soiled	Liquid detergents suitable for colors and dark colors can be used at dosages recommended for heavily soiled clothes.	
	Normally Soiled	Liquid detergents suitable for colors and dark colors can be used at dosages recommended for normally soiled clothes.	
	Lightly Soiled	Liquid detergents suitable for colors and dark colors can be used at dosages recommended for lightly soiled clothes.	
		Delicates/Woolens/Silks	
		[Recommended temperature range based on soiling level: cold -30 °C]	
Soiling Level	Heavily Soiled	Prefer liquid detergents produced for delicate clothes. Woolen and silk clothes must be washed with special woolen detergents.	
	Normally Soiled	Prefer liquid detergents produced for delicate clothes. Woolen and silk clothes must be washed with special woolen detergents.	
	Lightly Soiled	Prefer liquid detergents produced for delicate clothes. Woolen and silk clothes must be washed with special woolen detergents.	

Operating the product

Control panel

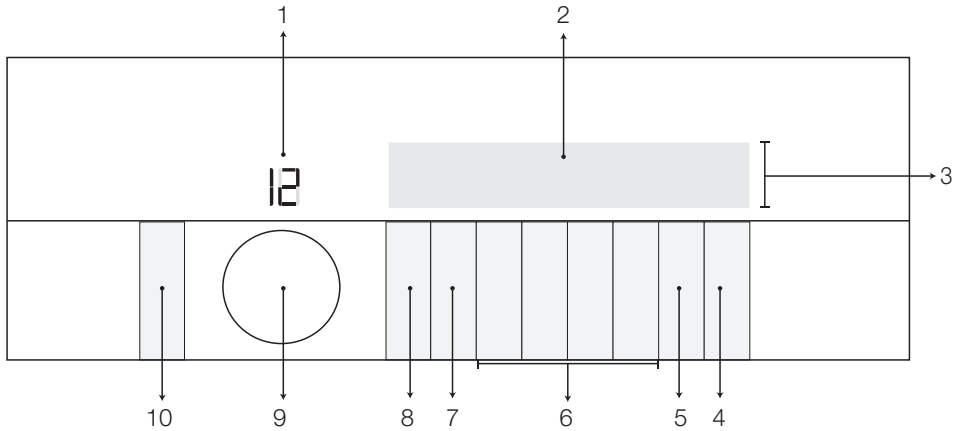

- 1 - Programme Selection display
- 2 - Display
- 3 - Programme Follow-up indicator
- 4 - Start / Pause button
- 5 - End Time Adjustment button

- 6 - Auxiliary Function buttons
- 7 - Spin Speed Adjustment button
- 8 - Temperature Adjustment button
- 9 - Programme Selection knob
- 10 - On / Off button

Display symbols

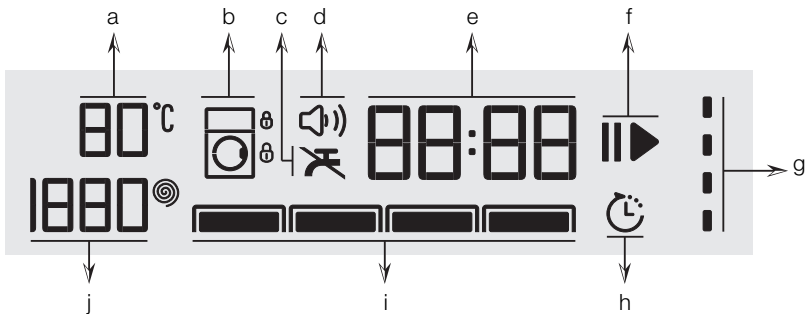

- a - Temperature indicator
- b - Lock indicator
- c - No Water indicator
- d - Audio Warning indicator
- e - Duration Information Line

- f - Start / Pause indicator
- g - Programme Follow-up indicator
- h - End Time indicator
- i - Auxiliary Function indicators
- j - Spin speed indicator

Preparing the machine

- Check if the hoses are connected tightly.
- Plug in your machine.
- Turn the tap on completely.
- Place the laundry in the machine.
- Add detergent and fabric softener.

Programme selection

- Select the programme suitable for the type, quantity and soiling level of the laundry in accordance with the "Programme and consumption table" and the temperature table below.

90°C	Heavily soiled white cottons and linens. (coffee table covers, tablecloths, towels, bed sheets, etc.)
60°C	Normally soiled, coloured, fade proof linens, cottons or synthetic clothes (shirt, nightgown, pajamas, etc.) and lightly soiled white linens (underwear, etc.)
40°C- 30°C- Cold	Blended laundry including delicate textile (veil curtains, etc.), synthetics and woolsens.

- Select the desired programme with the **Programme Selection** knob.

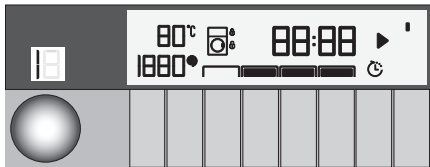

Programmes are limited with the highest spin speed appropriate for that particular type of fabric.

When selecting a programme, always consider the type of fabric, colour, degree of soiling and permissible water temperature.

Always select the lowest required temperature. Higher temperature means higher power consumption.

Programmes

• Cotton

Use this programme for your cotton laundry (such as bed sheets, duvet and pillowcase sets, towels, bathrobes, underwear, etc.). Your laundry will be washed with vigorous washing action for a longer washing cycle.

• Synthetics

Use this programme to wash your synthetic clothes (shirts, blouses, synthetic/cotton blends, etc.). It washes with a gentle action and has a shorter washing cycle compared to the Cotton programme.

For curtains and tulle, use the Synthetic 40°C programme with prewash and anti-creasing functions selected. As their meshed texture causes excessive foaming, wash the veils/tulle by putting little amount of detergent into the main wash compartment. Do not put detergent in the prewash compartment.

• WoolProtect

Use this programme to wash your woolen clothes. Select the appropriate temperature complying with the tags of your clothes. Use appropriate detergents for woolsens.



"The Wool wash cycle of this machine has been tested and approved by **The Woolmark Company** for the washing of Woolmark garments labelled as "machine wash" provided that the garments are washed according to the instructions on the garment label and those issued by the manufacturer of this washing machine. M13985"
"In UK, Eire, Hong Kong and India the Woolmark trade mark is a Certification trade mark."

• SenseWash

Use this to wash your frequently washable cotton, synthetic or blended (cotton+synthetic) clothes. Programme detects the type and quantity of the laundry to automatically adjust water consumption and programme time.



WARNING: Do not wash your woolen and delicate clothes in this programme.
If the temperature shown in the temperature indicator is not suitable for the garment, then select an appropriate temperature value.

The maximum washing temperature in Automatic programme depending on the soiling level and laundry type is 60°C. Washing performance may not be at the desired level for heavily soiled whites and stubborn stains (collar, sock soil, perspiration stain, etc.). In this case, it is recommended to select Cottons programme with prewash and to set the temperature to 50-60°C.

Many types of clothing are correctly detected and safely washed in the Automatic programme.

• Cotton Eco

Use this programme to wash your normally soiled, durable cotton and linen laundry. Although it washes longer than all other programmes, it provides high energy and water savings. Actual water temperature may be different from the stated wash temperature. When you load the machine with less laundry (e.g. ½ capacity or less), programme time may automatically get shorter. In this case, energy and water consumption will decrease more, providing a more economic wash. This programme is available in the models with the remaining time indicator.

• Anti-Allergy

Use this programme to wash baby laundry, and the laundry that belongs to allergic persons. Longer heating time and an additional rinsing step provide a higher level of hygiene.

• Hand Wash

Use this programme to wash your woolen/delicate clothes that bear “not machine- washable” tags and for which hand wash is recommended. It washes laundry with a very gentle washing action to not to damage clothes.

• GentleCare

Use this programme to wash your delicate clothes. It washes with a gentle action without any interim spin compared to the Synthetics programme.

• Mini 14'

Use this programme to wash your little amount of lightly soiled cotton clothes in a short time. Your clothes will be washed at 30 °C in a short time like 14 minutes.

• DarkCare

Use this programme to wash your dark coloured **cotton and synthetic** laundry or the laundry that you do not want it get faded. Washing is performed with gentle actions and at low temperatures. It is recommended to use liquid detergent or woolen shampoo for dark coloured laundry.

• Shirts



Use this programme to wash the cotton, synthetic and synthetic blended shirts together.

• Quick Wash 40°/40'

Use to wash your lightly soiled and unstained cotton laundry in a short time.

• Bedding

Use this programme to wash your fiber duvets that bear „machine washable“ tag. Make sure that you have loaded the duvet correctly in order not to damage the machine and the duvet. Remove the duvet cover before loading the duvet into the machine. Fold the duvet into two and load it into the machine. Load the duvet into the machine paying attention to place it in a way that it will not contact the bellow.

	Do not load more than 1 double fibre duvet (200 x 200 cm).
	Do not wash your duvets, pillows and etc. that contain cotton in the machine.
	WARNING: Do not wash the items apart from duvets such as carpets, rugs and etc. in the machine. Permanent damage occurs in the machine.

• MachineCare

Use this programme regularly (once in every 1-2 months) to clean the drum and provide the required hygiene. Run the programme without any laundry in the machine. To obtain better results, put powder limescale remover for washing machines into the detergent compartment "2". When the programme is over, leave the loading door ajar so that the inside of the machine gets dry.

	This is not a washing programme. It is a maintenance programme.
	Do not run the programme when there is something in the machine. If you try to do so, the machine detects that there is a load inside and aborts the programme.

• Rinsing

Use this programme when you want to rinse or starch separately.

• Spin+Pump

Use this programme to drain the water in the machine.

Temperature selection

Whenever a new programme is selected, the recommended temperature for the programme appears on the temperature indicator. It is possible that the recommended temperature value is not the maximum temperature that can be selected for the current programme.

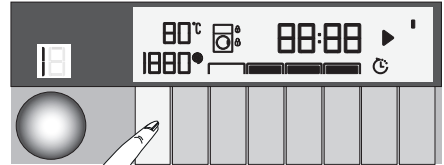

Press the **Temperature Adjustment** button to change the temperature. Temperature will decrease by steps of 10 °C.

	Temperature Adjustment button functions only in the temperature decrement direction.
---	--

Finally, “-” symbol indicating the cold option appears on the display.

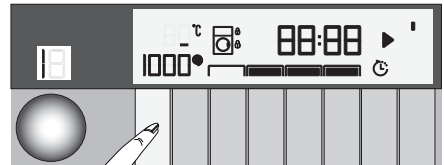

	No modification can be made in the programmes that do not allow temperature adjustment.
---	---

You can also change the temperature after the washing starts. If washing steps are appropriate then modification can be made. If washing steps are not appropriate then no modification can be made.

	If you scroll to cold wash option and press Temperature Adjustment button again, the recommended maximum temperature for the selected programme appears on the display. Press the Temperature Adjustment button again to decrease the temperature.
---	--

Selecting the spin speed

Whenever a new programme is selected, the recommended spin speed of the selected programme is displayed on the **Spin Speed** indicator.



It is possible that the recommended spin speed value is not the maximum spin speed that can be selected for the current programme.

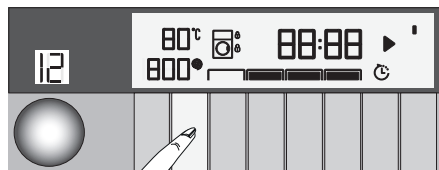

Press the **Spin Speed Adjustment** button to change the spin speed. Spin speed decreases gradually.

Then, depending on the model of the product, "Rinse Hold" and "No Spin" options appear on the display.



Spin speed adjustment button functions only in the spin speed decrement direction.

Rinse Hold option is indicated with "i_" symbol and No Spin option is indicated with "_ " symbol.

If you are not going to unload your laundry immediately after the programme completes, you can use **Rinse Hold** function in order to prevent them from getting wrinkled when there is no water in the machine.

This function holds the laundry in the final rinsing water.

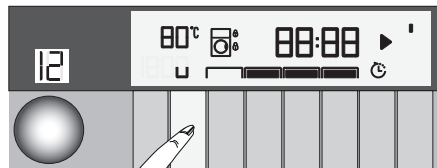

If you want to spin your laundry after the Rinse Hold function:

- Adjust the **Spin Speed**.
- Press **Start / Pause / Cancel** button.

The programme resumes. Machine discharges the water and spins the laundry.

If you want to discharge the water at the end of the programme without spinning, use **No Spin** function.

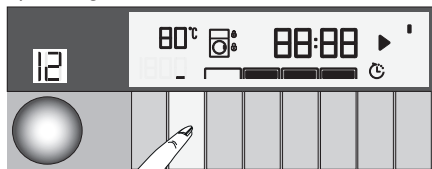



No modification can be made in the programmes that do not allow spin speed adjustment.

Spin Speed can be changed after the washing starts if the washing steps are suitable. If washing steps are not appropriate then no modification can be made.

Programme and consumption table

EN		Auxiliary functions								
Programme (°C)		Max. Load (kg)	Water Consumption (l)	Energy Consumption (kWh)	Max. Speed***	Express	Prewash	Silent Mode	Extra Rinse	Selectable temperature range °C
SenseWash	40	8	****	****	1400	•	•	•	•	Cold-60
Cotton Eco	60**	8	50,5	0,920	1400					Cold-60
	60**	4	41	0,805	1400					Cold-60
	40**	4	41	0,805	1400					Cold-60
Cotton	90	8	70	2,03	1400	•	•	•	•	Cold-90
	60	8	70	1,33	1400	•	•	•	•	Cold-90
	40	8	70	0,93	1400	•	•	•	•	Cold-90
Synthetics	60	4	65	1,13	1200	•	•	•	•	Cold-60
	40	4	65	0,90	1200	•	•	•	•	Cold-60
WoolProtect	40	2	45	0,35	1000	•		•	•	Cold-40
Hand Wash	30	1,5	40	0,22	600					Cold-30
Mini 14'	30	2	34	0,16	1400			•	•	Cold-30
Bedding	40	-	67	0,82	1000	•		•	•	Cold-60
Anti-Allergy	90	8	100	2,25	1400				*	30 - 90
GentleCare	40	3	54	0,44	1000	•	•	•	•	40-Cold
DarkCare	40	4	80	0,90	1000		•	•	*	Cold-40
QuickWash 40°/40'	40	8	55	0,65	1400					Cold-40
Shirts	60	4	85	1,29	800	•	•	•	•	Cold-60
MachineCare	70	-	110	2,60	700				*	70

- : Selectable.
- * : Automatically selected, no canceling.
- ** : Energy Label programme (EN 60456 Ed.3)
- *** : If maximum spin speed of the machine is lower then this value, you can only select up to the maximum spin speed.
- **** : Programme detects the type and quantity of the laundry to automatically adjust water and energy consumption and programme time.
- : See the programme description for maximum load.

 ** "Cotton eco 40°C and Cotton eco 60°C are standard programmes." These programmes are known as '40°C cotton standard programme' and '60°C cotton standard programme' and shown on the panel with  symbols.



The auxiliary functions in the table may vary according to the model of your machine.

Water and power consumption may vary subject to the changes in water pressure, water hardness and temperature, ambient temperature, type and amount of laundry, selection of auxiliary functions and spin speed, and changes in electric voltage.

You can see the washing duration on the display of your machine while selecting a programme. Depending on the amount of laundry you have loaded into your machine, there may be a difference of 1-1.5 hours between the duration shown on the display and the actual duration of the wash cycle. Duration will be automatically updated soon after the washing starts.

Indicative values for Synthetics programmes (EN)

	Load (kg)	Water Consumption (l)	Energy Consumption (kWh)	Programme Duration (min) *	Remaining Moisture Content (%) **	
					≤ 1000 rpm	> 1000 rpm
Synthetics 60	4	65	1.13	120/150	45	40
Synthetics 40	4	65	0.90	85/150	45	40

* You can see the washing time of the programme you have selected on the display of the machine. It is normal that small differences may occur between the time shown on the display and the real washing time.

** Remaining moisture content values may differ according to the selected spin speed.

Auxiliary function selection

Select the desired auxiliary functions before starting the programme. Whenever a programme is selected, frames of the auxiliary function symbols that can be selected together with it illuminate. When an auxiliary function is selected, the inner section will illuminate, as.

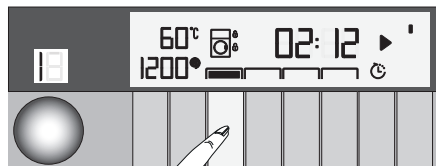

Frame of the auxiliary function symbol that cannot be selected with the current programme will not illuminate.

Also the frames of the auxiliary function suitable for the current programme after the washing has started remain illuminated. You can select or cancel the auxiliary functions whose frames are illuminated. If the wash cycle has reached a point where you cannot select the auxiliary function, the function's frame goes off.



Some functions cannot be selected together. If a second auxiliary function conflicting with the first one is selected before starting the machine, the function selected first will be canceled and the second auxiliary function selection will remain active. For example, if you want to select Quick Wash after you have selected the Extra Rinse, Extra Rinse will be canceled and Quick Wash will remain active.



An auxiliary function that is not compatible with the programme cannot be selected. (See „Programme and consumption table“)

Some programmes have auxiliary functions that must be operated simultaneously. Those functions cannot be cancelled. The frame of the auxiliary function will not be illuminated, only inner area will be illuminated.

• Prewash

A Prewash is only worthwhile for heavily soiled laundry. Not using the Prewash will save energy, water, detergent and time.

• Express

This function can be used in Cottons and Synthetics programmes. It decreases the washing times and also the number of rinsing steps for lightly soiled laundry.



When you select this function, load your machine with half of the maximum laundry specified in the programme table.

• Extra Rinse

This function enables the machine to make another rinsing in addition to the one already made after the main wash. Thus, the risk for sensitive skins (babies, allergic skins, etc.) to be effected by the minimal detergent remnants on the laundry can be reduced.

• Silent Mode

Use to wash the cottons with lesser energy consumption and silently. Spin steps are cancelled for a silent washing and the cycle ends with the Rinse Hold step. After completion of the programme, run Spin cycle to spin the laundry.

Time display

Remaining time for the completion of the programme while it is running is displayed as "01:30" in hours and minutes format.



Programme time may differ from the values in the "Programme and consumption table" depending on the water pressure, water hardness and temperature, ambient temperature, amount and the type of laundry, auxiliary functions selected and the changes at the mains voltage.

End Time

With the **End Time** function, the startup of the programme may be delayed up to 24 hours. After pressing **End Time** button, the displayed time is the programme's estimated end time. If the **End Time** is adjusted, **End Time** indicator is illuminated.

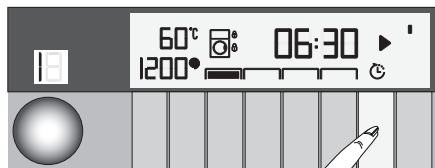

In order for the End Time function is activated and the programme is completed at the end of the specified time, you must press **Start / Pause** button after adjusting the time.

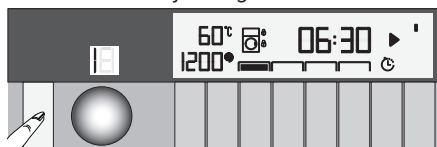

If you want to cancel the End Time function; restart the machine by pushing the **Turn On / Off** button.



Do not use liquid detergents when you activate End Time function! There is the risk of staining of the clothes.

- Open the loading door, place the laundry and put detergent, etc.
- Select the washing programme, temperature, spin speed and, if required, the auxiliary functions.
- Set the end time of your choice by pressing the **End Time** button. **End Time** indicator illuminates.
- Press **Start / Pause** button. Time countdown starts. ":" sign in the middle of the end time on the display starts flashing.



Additional laundry may be loaded during the End Time countdown period. At the end of the countdown, End Time indicator turns off, washing cycle starts and the time of the selected programme appears on the display.

When the End Time selection is done, the time appearing on the screen consists of end time plus the duration of the selected programme.

Starting the programme

- Press **Start / Pause** button to start the programme.
- The **Start / Pause** button which was dimmed starts to illuminate steadily now, indicating that the programme has started.

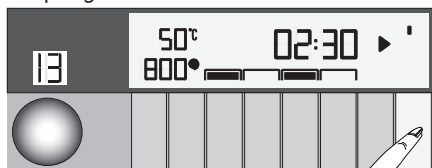

- Loading door is locked. Door locked symbol appears after it is locked.

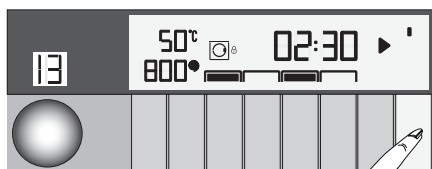

- Current programme step is indicated by the programme follow-up indicator LEDs on the display.

Loading door lock

There is a locking system on the loading door of the machine that prevents opening of the door in cases when the water level is unsuitable. "Door Locked" symbol is lit on the display when the loading door is locked.

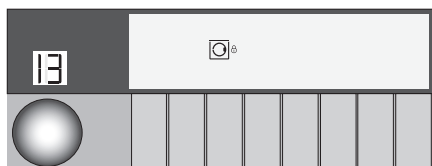

Changing the selections after programme has started

Adding laundry after the programme has started:

When the **Start / Pause** button is pressed, if the water level inside the machine is appropriate, the door symbol flashes on the display until it is opened and dims when the door is opened.



When **Start / Pause** button is pressed, if the water level inside the machine is not appropriate, then the door symbols stays on.

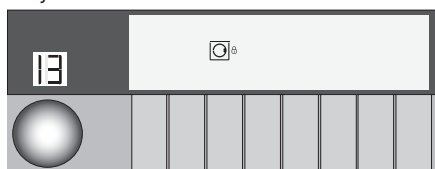

Switching the machine to pause mode:

Press **Start / Pause** button to pause the machine, a wait symbol will start flashing on the display.

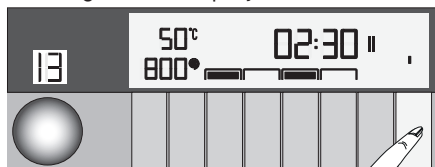

Changing the programme selection after programme has started:

The programme change is not allowed when the current programme is running.

You can select the new programme after switching the current programme to standby.

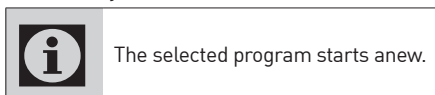

The selected program starts anew.

Changing the auxiliary function, speed and temperature

Depending on the step the programme has reached, you can cancel or activate the auxiliary functions; see, "Auxiliary function selection".

You can also change the speed and temperature settings; see, "Spin speed selection" and "Temperature selection".



The loading door will not open if the water temperature in the machine is high or the water level is above the door opening.

Child Lock

Use Child Lock function to prevent children from tampering with the machine. Thus you can avoid any changes in a running programme.



You can switch on and off the machine with **On / Off** button when the Child Lock is active. When you switch on the machine again, programme will resume from where it has stopped.

If you press any button when the Child Lock is activated, the machine will give an audio warning. No audible warning will be made when the buttons are pressed 5 times in a row.

To activate the Child Lock:

Press and hold **1st Auxiliary Function** button for 3 seconds. After the countdown as "**CL 3-2-1**" on the display is over "Child Lock Enabled" appears on the display. You can release the **1st Auxiliary Function** button when this warning is displayed.

To deactivate the Child Lock:

Press and hold **1st Auxiliary Function** button for 3 seconds. After the countdown as "**CL 3-2-1**" on the display is over "Child Lock Enabled" symbol turns off.

Cancelling the programme

The programme is cancelled when the machine is turned off and on again. Press and hold **On / Off** button for 3 seconds. After the countdown as "3-2-1" on the display is over, the machine turns off.



If you press **On / Off** button when the Child Lock is enabled, the programme will not be cancelled. You should cancel the Child Lock first.

If you want to open the loading door after you have cancelled the programme but it is not possible to open the loading door since the water level in the machine is above the loading door opening, then turn the **Programme Selection** knob to **Pump+Spin** programme and discharge the water in the machine.

Your machine is equipped

with a "Standby Mode"

In case of not starting any programme or waiting without making any other operation when the machine is turned on by On/Off button and while it is in selection step or if no other operation is performed approximately 2 minutes after the programme you selected has come to an end, your machine will automatically switch to energy saving mode. Brightness of indicator lights will decrease. Also, if your product is equipped with a display showing the programme duration, this display will completely turn off. In case of rotating the Programme Selection knob or pressing any button, lights and display will restore to their previous condition. Your selections made while exiting the energy saving mode may change. Check the appropriateness of your selections before starting the programme. Readjust if necessary. This is not a fault.

-

End of programme

When the programme completes, End symbol will be displayed.

If you do not press any button for 10 minutes, the machine will switch to OFF mode. Display and all indicators are turned off.

When you press On/Off button, the completed programme steps will be displayed.

Setting VOLUME level

- Low volume and high volume

To adjust the volume level keep the 2nd auxiliary function button pressed for 3 seconds. After the countdown as „ 3-2-1“ on the display is over, volume level symbol will be lit and the new volume level will be shown.

Quick User Guide

Preparing the machine

- Check if the hoses are connected tightly.
- Plug in your machine.
- Turn the tap on completely.
- Place the laundry in the machine.
- Add detergent and fabric softener.

Programme selection

- Select the programme suitable for the type, quantity and soiling level of the laundry in accordance with the "Programme and consumption table" and the temperature table.

Auxiliary function selection

Select the required auxiliary functions before starting the program. Whenever a programme is selected, frames of the auxiliary function symbols that can be selected together with it illuminate. When an auxiliary function is selected, the inner section will illuminate as well.

Starting the programme

- Press Start / Pause button to start the programme.
- Programme follow-up light showing the startup of the programme will turn on.



If no programme is started or no key is pressed within 1 minute during programme selection process, the machine will switch to Pause mode and the illumination level of the temperature, speed and loading door indicator lights will decrease. Other indicator lights and indicators will turn off. Once the Programme Selection knob is rotated or any button is pressed, indicator lights and indicators will turn on again.

End of programme

When the programme completes, End symbol will be displayed.

If you do not press any button for 10 minutes, the machine will switch to OFF mode. Display and all indicators are turned off.

When you press On/Off button, the completed programme steps will be displayed.

Cancelling the programme

The programme is cancelled when the machine is turned off and on again. Press and hold **On / Off** button for 3 seconds.

Child Lock

Use Child Lock function to prevent children from tampering with the machine. Thus you can avoid any changes in a running programme.



You can switch on and off the machine with **On / Off** button when the Child Lock is active. When you switch on the machine again, programme will resume from where it has stopped.

To activate the Child Lock:

* **Press and hold** 1st Auxiliary Function button for 3 seconds. "3-2-1 CL On" appears on the display after the countdown on the panel. You can release the **1st Auxiliary Function** button when this warning is displayed.

To deactivate the Child Lock:

keep the **1st auxiliary function** button pressed for 3 seconds. After the countdown on the panel is over, "3-2-1 CL On" symbol turns off.

Maintenance and cleaning

Service life of the product extends and frequently faced problems decrease if cleaned at regular intervals.

Cleaning the detergent drawer

Clean the detergent drawer at regular intervals (every 4-5 washing cycles) as shown below in order to prevent accumulation of powder detergent in time.

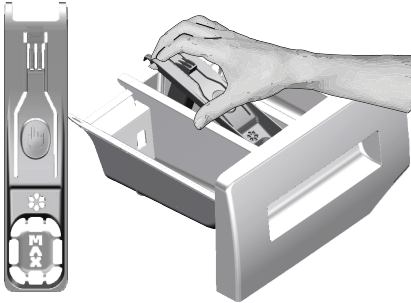

Lift the rear part of the siphon to remove it as illustrated.

- Press the dotted point on the siphon in the softener compartment and pull towards you until the compartment is removed from the machine.



If more than normal amount of water and softener mixture starts to gather in the softener compartment, clean the siphon.

- Wash the detergent drawer and the siphon with plenty of lukewarm water in a washbasin. Wear protective gloves or use an appropriate brush to avoid touching of the residues in the drawer with your skin when cleaning.
- After cleaning, seat the siphon well in its place and insert the drawer back.

Cleaning the loading door and the drum

For products with drum cleaning programme, please see Operating the product - Programmes.



Repeat Drum Cleaning process in every 2 months.

Use an anti-limescale suitable for the washing machines.

After every washing check that no foreign substance is left in the drum.



If the holes on the bellow shown in the figure is blocked, open the holes using a toothpick.



Foreign metal substances will cause rust stains in the drum. Clean the stains on the drum surface by using cleaning agents for stainless steel. Never use steel wool or wire wool.



WARNING: Never use sponge or scrub materials. These will damage the painted, chrome plated and plastic surfaces.

Cleaning the body and control panel

Wipe the body of the machine with soapy water or non-corrosive mild gel detergents as necessary, and dry with a soft cloth.

Use only a soft and damp cloth to clean the control panel.

Cleaning the water intake filters

There is a filter at the end of each water intake valve at the rear of the machine and also at the end of each water intake hose where they are connected to the tap. These filters prevent foreign substances and dirt in the water to enter the washing machine. Filters should be cleaned as they do get dirty.

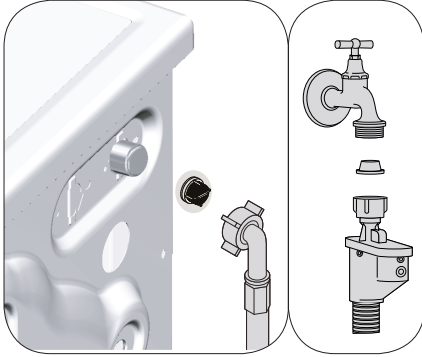

- Close the taps.
- Remove the nuts of the water intake hoses to access the filters on the water intake valves. Clean them with an appropriate brush. If the filters are too dirty, take them out by means of pliers and clean them.
- Take out the filters on the flat ends of the water intake hoses together with the gaskets and clean thoroughly under running water.
- Replace the gaskets and filters carefully in their places and tighten the hose nuts by hand.

Draining remaining water and cleaning the pump filter

The filter system in your machine prevents solid items such as buttons, coins and fabric fibers clogging the pump impeller during discharge of washing water. Thus, the water will be discharged without any problem and the service life of the pump will extend. If the machine fails to drain water, the pump filter is clogged. Filter must be cleaned whenever it is clogged or in every 3 months. Water must be drained off first to clean the pump filter.

In addition, prior to transporting the machine (e.g., when moving to another house) and in case of freezing of the water, water may have to be drained completely.



WARNING: Foreign substances left in the pump filter may damage your machine or may cause noise problem.



WARNING: If the product is not in use, turn the tap off, detach the supply hose and drain the water inside the machine against any freezing possibility in the region of installation.



WARNING: After each use close the supply hose tap of the product.

In order to clean the dirty filter and discharge the water:

- Unplug the machine to cut off the supply power.



WARNING: Temperature of the water inside the machine may rise up to 90 °C. To avoid burning risk, clean the filter after the water in the machine cools down.

- Open the filter cap.
- If the filter cap is composed of two pieces, press the tab on the filter cap downwards and pull the piece out towards yourself.



You can remove the filter cover by slightly pushing downwards with a thin plastic tipped tool, through the gap above the filter cover. Do not use metal tipped tools to remove the cover.

- Some of our products have emergency draining hose and some does not have. Follow the steps below to discharge the water.

If the product has an emergency draining hose, to discharge the water:

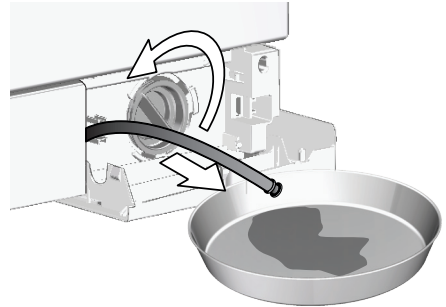

- Pull the emergency draining hose out from its seat
- Place a large container at the end of the hose. Drain the water into the container by pulling out the plug at the end of the hose. When the container is full, block the inlet of the hose by replacing the plug. After the container is emptied, repeat the above procedure to drain the water in the machine completely.
- When draining of water is finished, close the end by the plug again and fix the hose in its place.
- Turn the pump filter to take it out.
- Clean any residues inside the filter as well as fibers, if any, around the pump impeller region.
- Install the filter.
- If the filter cap is composed of two pieces, close the filter cap by pressing on the tab. If it is one piece, seat the tabs in the lower part into their places first, and then press the upper part to close.

Troubleshooting

Program does not start after closing the door.

- Start / Pause / Cancel button was not pressed. >>> **Press the Start / Pause / Cancel button.*
- It may be difficult to close the loading door in case of excessive loading. >>> *Reduce the amount of laundry and make sure that the loading door is closed properly.*

Programme cannot be started or selected.

- Washing machine has switched to self protection mode due to a supply problem (line voltage, water pressure, etc.). >>> *Press and hold On / Off button for 3 seconds to reset the machine to factory settings. ("Cancelling the programme")*

Water in the machine.

- Some water might have remained in the product due to the quality control processes in the production. >>> *This is not a failure; water is not harmful to the machine.*

There is water leaking from the bottom of the machine.

- Likely problems with hoses or the pump filter. >>> *Be sure the seals of the water inlet hoses are securely fitted. Attach the hose to the tap tightly.*
- Pump filter might not be closed fully. >>> *Check if the pump filter is completely closed.*

Machine does not fill with water.

- Tap is turned off. >>> *Open the taps.*
- Water inlet hose is bent. >>> *Correct the hose.*
- Water inlet filter is clogged. >>> *Clean the filter.*
- The loading door is ajar. >>> *Close the loading door.*

Machine does not drain water.

- Water drain hose might be clogged or twisted. >>> *Clean or flatten the hose.*
- Pump filter is clogged. >>> *Clean the pump filter.*

Machine vibrates or makes noise.

- Machine might be standing unbalanced. >>> *Adjust the feet to level the machine.*
- A hard substance might have entered into the pump filter. >>> *Clean the pump filter.*
- Transportation safety bolts are not removed. >>> *Remove the transportation safety bolts.*
- Laundry quantity in the machine might be too little. >>> *Add more laundry to the machine.*
- Machine might be overloaded with laundry. >>> *Take out some of the laundry from the machine or distribute the load by hand to balance it homogenously in the machine.*
- Machine might be leaning on a rigid item. >>> *Check if the machine is not leaning on anything.*

Machine stopped shortly after the programme started.

- Machine might have stopped temporarily due to low voltage. >>> *It will resume running when the voltage restores to the normal level.*

Machine directly discharges the water it takes in.

- Draining hose might not be at adequate height. >>> *Connect the water draining hose as described in the operation manual.*

No water can be seen in the machine during washing.

- The water level is not visible from outside of the washing machine. This is not a failure.

Loading door cannot be opened.

- Door lock is activated because of the water level in the machine. >>> *Drain the water by running the Pump or Spin programme.*
- Machine is heating up the water or it is at the spinning cycle. >>> *Wait until the programme completes.*
- Child lock is engaged. Door lock will be deactivated a couple of minutes after the programme has come to an end. >>> *Wait for a couple of minutes for deactivation of the door lock.*
- Loading door may be stuck because of the pressure it is subjected to. >>> *Grab the handle and push and pull the loading door to release and open it.*

Washing takes longer than the specified in the manual. (*)

- Water pressure is low. >>> *Machine waits until taking in adequate amount of water to prevent poor washing quality due to the decreased amount of water. Therefore, the washing time extends.*
- Voltage might be low. >>> *Washing time is prolonged to avoid poor washing results when the supply voltage is low.*
- Input temperature of water might be low. >>> *Required time to heat up the water extends in cold seasons. Also, washing time can be lengthened to avoid poor washing results.*
- Number of rinses and/or amount of rinse water might have increased. >>> *Machine increases the amount of rinse water when good rinsing is needed and adds an extra rinsing step if necessary.*
- Excessive foam might have occurred and automatic foam absorption system might have been activated due to too much detergent usage. >>> *Use recommended amount of detergent.*

Programme time does not countdown. (On models with display) (*)

- Timer may stop during water intake. >>> *Timer indicator will not countdown until the machine takes in adequate amount of water. The machine will wait until there is sufficient amount of water to avoid poor washing results due to lack of water. Timer indicator will resume countdown after this.*
- Timer may stop during heating step. >>> *Timer indicator will not countdown until the machine reaches the selected temperature.*
- Timer may stop during spinning step. >>> *Automatic unbalanced load detection system might be activated due to the unbalanced distribution of the laundry in the drum.*

Programme time does not countdown. (*)

- There might be an imbalance of laundry in the machine. >>> *Automatic unbalanced load detection system might be activated due to the unbalanced distribution of the laundry in the drum.*

Machine does not switch to spinning step. (*)

- There might be an imbalance of laundry in the machine. >>> *Automatic unbalanced load detection system might be activated due to the unbalanced distribution of the laundry in the drum.*
- The machine will not spin if water is not drained completely. >>> *Check the filter and the draining hose.*
- Excessive foam might have occurred and automatic foam absorption system might have been activated due to too much detergent usage. >>> *Use recommended amount of detergent.*

Washing performance is poor: Laundry turns grey. ()**

- Insufficient amount of detergent was used over a long period of time. >>> *Use the recommended amount of detergent appropriate for water hardness and the laundry.*
- Washing was made at low temperatures for a long time over a long period of time. >>> *Select the proper temperature for the laundry to be washed.*
- Insufficient amount of detergent is used with hard waters. >>> *Using insufficient amount of detergent with hard water causes the soil to stick on the cloth and this turns the cloth into grey in time. It is difficult to eliminate greying once it happens. Use the recommended amount of detergent appropriate for water hardness and the laundry.*
- Too much detergent is used. >>> *Use the recommended amount of detergent appropriate for water hardness and the laundry.*

Washing performance is poor: Stains persist or the laundry is not whitened. ()**

- Insufficient amount of detergent is used. >>> *Use recommended amount of detergent appropriate for the laundry.*
- Excessive laundry was loaded in. >>> *Do not load the machine in excess. Load with amounts recommended in the "Programme and consumption table".*
- Wrong programme and temperature were selected. >>> *Select the proper programme and temperature for the laundry to be washed.*
- Wrong type of detergent is used. >>> *Use original detergent appropriate for the machine.*
- Detergent is put in the wrong compartment. >>> *Put the detergent in the correct compartment. Do not mix the bleaching agent and the detergent with each other.*

Washing performance is poor: Oily stains appeared on the laundry. ()**

- Regular drum cleaning is not applied. >>> *Clean the drum regularly. For this, please .*

Washing performance is poor: Clothes smell unpleasantly. ()**

- Odours and bacteria layers are formed on the drum as a result of continuous washing at lower temperatures and/or in short programmes. >>> *Leave the detergent drawer as well as the loading door of the machine ajar after each washing. Thus, a humid environment favorable for bacteria cannot occur in the machine.*

Colour of the clothes faded. ()**

- Excessive laundry was loaded in. >>> *Do not load the machine in excess.*
- Detergent in use is damp. >>> *Keep detergents closed in an environment free of humidity and do not expose them to excessive temperatures.*
- A higher temperature is selected. >>> *Select the proper programme and temperature according to the type and soiling degree of the laundry.*

It does not rinse well.

- The amount, brand and storage conditions of the detergent used are inappropriate. >>> *Use a detergent appropriate for the washing machine and your laundry. Keep detergents closed in an environment free of humidity and do not expose them to excessive temperatures.*
- Detergent is put in the wrong compartment. >>> *If detergent is put in the prewash compartment although prewash cycle is not selected, machine can take this detergent during rinsing or softener step. Put the detergent in the correct compartment.*
- Pump filter is clogged. >>> *Check the filter.*
- Drain hose is folded. >>> *Check the drain hose.*

Laundry became stiff after washing. ()**

- Insufficient amount of detergent is used. >>> *Using insufficient amount of detergent for the water hardness can cause the laundry to become stiff in time. Use appropriate amount of detergent according to the water hardness.*
- Detergent is put in the wrong compartment. >>> *If detergent is put in the prewash compartment although prewash cycle is not selected, machine can take this detergent during rinsing or softener step. Put the detergent in the correct compartment.*
- Detergent might be mixed with the softener. >>> *Do not mix the softener with detergent. Wash and clean the dispenser with hot water.*

Laundry does not smell like the softener. ()**

- Detergent is put in the wrong compartment. >>> *If detergent is put in the prewash compartment although prewash cycle is not selected, machine can take this detergent during rinsing or softener step. Wash and clean the dispenser with hot water. Put the detergent in the correct compartment.*
- Detergent might be mixed with the softener. >>> *Do not mix the softener with detergent. Wash and clean the dispenser with hot water.*

Detergent residue in the detergent drawer. ()**

- Detergent is put in wet drawer. >>> *Dry the detergent drawer before putting in detergent.*
- Detergent has gotten damp. >>> *Keep detergents closed in an environment free of humidity and do not expose them to excessive temperatures.*
- Water pressure is low. >>> *Check the water pressure.*
- The detergent in the main wash compartment got wet while taking in the prewash water. Holes of the detergent compartment are blocked. >>> *Check the holes and clean if they are clogged.*
- There is a problem with the detergent drawer valves. >>> *Call the Authorised Service Agent.*
- Detergent might be mixed with the softener. >>> *Do not mix the softener with detergent. Wash and clean the dispenser with hot water.*
- Regular drum cleaning is not applied. >>> *Clean the drum regularly. For this, please .*

There is detergent left on the laundry. ()**

- Excessive laundry was loaded in. >>> *Do not load the machine in excess.*
- Wrong programme and temperature were selected. >>> *Select the proper programme and temperature for the laundry to be washed.*
- Wrong detergent was used. >>> *Select the proper detergent for the laundry to be washed.*

Too much foam forms in the machine. ()**

- Improper detergents for the washing machine are being used. >>> *Use detergents appropriate for the washing machine.*
- Excessive amount of detergent is used. >>> *Use only sufficient amount of detergent.*
- Detergent was stored under improper conditions. >>> *Store detergent in a closed and dry location. Do not store in excessively hot places.*
- Some meshed laundry such as tulle may foam too much because of their texture. >>> *Use smaller amounts of detergent for this type of item.*
- Detergent is put in the wrong compartment. >>> *Put the detergent in the correct compartment.*
- Softener is being taken early. >>> *There may be problem in the valves or in the detergent dispenser. Call the Authorised Service Agent.*

Foam is overflowing from the detergent drawer.

- Too much detergent is used. >>> *Mix 1 tablespoonful softener and ½ l water and pour into the main wash compartment of the detergent drawer.*
- Put detergent into the machine suitable for the programmes and maximum loads indicated in the "Programme and consumption table". When you use additional chemicals (stain removers, bleaches and etc), reduce the amount of detergent.

Laundry remains wet at the end of the programme. (*)

- Excessive foam might have occurred and automatic foam absorption system might have been activated due to too much detergent usage. >>> *Use recommended amount of detergent.*
- * Machine does not switch to spinning step when the laundry is not evenly distributed in the drum to prevent any damage to the machine and to its surrounding environment. Laundry should be rearranged and re-spun.
- ** Regular drum cleaning might not be applied.>>> *Clean the drum regularly.*



WARNING: If you cannot eliminate the problem although you follow the instructions in this section, consult the dealer or the Authorised Service Agent. Never try to repair a nonfunctional product yourself.

Your new Grundig product is guaranteed against faulty materials, defective components or manufacturing defects.

The standard guarantee starts from the date of original purchase of the product, and lasts for a period of thirty six (36) months unless Beko plc (the "Manufacturer") agrees to extend the guarantee for the product in writing.

If you have registered the product within 90 days of purchase by completing the online registration form, then the standard 36 month guarantee will be extended to 60 months, under the same terms and conditions as detailed below

If you have any questions about the guarantee on your product (including how long it is valid), please contact your retailer or our contact centre on **0333 207 9920** (UK and Northern Ireland) or **01 691 0203** (Republic of Ireland)

This guarantee does not in any way diminish or affect your statutory rights in connection with the product. This guarantee is in addition to your statutory rights as a consumer. If you have any questions about these rights, please contact the retailer from which you purchased the product. In certain circumstances, it is possible that your statutory rights may offer additional or higher levels of protection than those offered under the terms of this guarantee.

What is covered by this guarantee?

- Repairs to the product required as a result of faulty materials, defective components or manufacturing defects.
- Functional replacement parts to repair a product.
- The costs of a Grundig Approved Engineer to carry out the repair.

What is not covered?

- Transit and delivery damage.
- Cabinet or appearance parts, including but not limited to control knobs, flaps and handles.
- Accessories and/or consumable items including but not limited to ice trays, scrapers, cutlery baskets, filters and light bulbs.
- Repairs necessary as a direct or indirect result of:
 - Accidental damage, misuse or abuse of a product.
 - An attempted repair of a product by anyone other than a Grundig Approved Engineer (the "Engineer").
 - Installation or use of a product where such installation or use fails to meet the requirements contained in this guarantee or the User Instructions Booklet.
- Repairs to a product operated at any time on commercial or non-residential household premises (unless we have previously agreed to the installation environment).

This guarantee is limited to the cost of repairing the product. To the extent permitted by law, the Manufacturer does not accept and will not be held liable for any financial loss incurred in connection with the failure of any product to operate in accordance with the expected standards. Such financial loss includes but is not limited to loss arising from:

- Time taken off work.
- Damaged food, clothing or other items.
- Meals taken at restaurants or from takeaways.
- General compensation for inconvenience.

Important Notes

1. Your product is designed and built for domestic household use only.
2. The guarantee will automatically be void if the product is installed or is used in commercial or non-residential domestic household premises, unless we have previously agreed to the installation environment.
3. The product must be correctly installed, located and operated in accordance with the instructions contained in the User Instructions Booklet provided with your product.
4. Professional installation by a qualified Electrical Domestic Appliance Installer is recommended for all Washing Machines, Dishwashers and Electric Cookers (as incorrect installation may result in you having to pay for the cost of repairing the product).
5. Gas Cookers must be professionally installed by a Gas Safe (or Gas Networks Ireland for Republic of Ireland) registered gas installer.
6. This guarantee is given in respect of products purchased and used within the United Kingdom and the Republic of Ireland.
7. This guarantee is effective from the initial date of purchase of a new product from an authorised retailer and will be void if the product is resold.
8. This guarantee does not apply to graded sales (where the product is purchased as a "second").
9. Possession of a copy of these terms and conditions does not necessarily mean that a product has the benefit of this guarantee. If you have any questions, please call our Call Centre on the number set out above.

10. The Manufacturer reserves the right to terminate the guarantee if its staff or representatives are subjected to physical or verbal abuse in the course of carrying out their duties.
11. Optional extras, where available (i.e. extendable feet) are supplied on a chargeable basis only.

Does Grundig offer replacements?

This is a repair-only guarantee. On occasion, the Manufacturer may at its sole discretion, replace your product with a new product instead of carrying out a repair. Where a replacement is offered, this would normally be an identical model but when this is not possible, a model of similar specification will be provided. The Manufacturer will cover the costs and arrange for the delivery of the new product and for the return of the old product. Any costs related to disconnecting the faulty product and installing the replacement product will not be borne by the Manufacturer unless previously agreed to in writing. The original guarantee will continue to apply to the replacement product; the new product will not come with a new guarantee.

When will the repair take place?

Our Engineers work Monday to Friday 9.00am to 5.00pm. Appointments outside these hours may be possible at the sole discretion of the Manufacturer but cannot be guaranteed. Whilst our Engineers will endeavour to minimize inconvenience and to meet requests for specific timed appointments, this cannot be guaranteed. We will not be liable for delays or if it is unable to carry out a repair because a convenient appointment cannot be arranged.

Will there be any charge for the repairs?

It is your responsibility to provide evidence to the Engineer that your product is covered by this guarantee with a proof of purchase. The Manufacturer reserves the right to charge for the reasonable cost of any service call if:

- You cannot provide evidence that your product is covered by this guarantee.
- Where a service call has been made and the engineer finds that there is no fault with your product.
- That your product has not been installed or operated in accordance with the User Instructions Booklet.
- That the fault was caused by something other than faulty materials, defective components or manufacturing defects.
- For missed appointments.

Payment of these costs are due immediately upon the Engineer providing you with an invoice. The Manufacturer reserves the right to terminate the guarantee if you fail to pay the costs for the service call in a timely manner.

If you are a resident of the United Kingdom, this guarantee will be governed by English law and subject to the English Courts, save where you live in another part of the United Kingdom, in which case the law and courts of that location will apply.

If you are resident in the Republic of Ireland, this guarantee will be governed by Irish law and the Irish courts will have jurisdiction.

This guarantee is provided by Beko plc. Beko House, 1 Greenhill Crescent, Watford, Hertfordshire. WD18 8QU.

Beko plc is registered in England and Wales with company registration number 02415578.

GRUNDIG UK AND IRELAND ECO INVERTER MOTOR GUARANTEE TERMS AND CONDITIONS**This 10 year guarantee relates to Grundig products that feature the Eco Inverter Motor.**

The Eco Inverter Motor guarantee terms and conditions are in addition to our Standard guarantee terms and conditions detailed in the previous section.

In order to activate the 10 year guarantee you MUST register the appliance within 90 days of the original purchase date. You can register by first visiting grundig.co.uk/register and by following the online instructions.

Grundig Free standing and Built-in appliances come with a 36 month parts and labour guarantee as standard, which can be extended to a 60 months parts and labour guarantee by registering within 90 days of the original purchase date

To make a claim against your Grundig Eco Inverter Motor Guarantee (the "Guarantee"), all customer and product details must be registered with Beko plc using the procedure outlined below.

1. This extra 7 years (or 5 years for appliances registered within 90 days of the original purchase date) Guarantee is only effective after the expiration of the standard manufacturer's guarantee.
2. It is only valid for the Eco Inverter motors of selected washing machines, washer-dryers, tumble dryers and dishwashers. It does not cover any labour charge or any other components of the product. In addition, it is only valid for one replacement of the Eco Inverter motor during the extra 7 years (or 5 years for appliances registered within 90 days of the original purchase date) guarantee period.
3. To activate your guarantee, you MUST register your appliance within 90 days of the original purchase date, by visiting Grundig.co.uk/register.
4. Customers will receive a unique reference code as proof of guarantee validation by email or post, which must be quoted at the time of a claim being made.
5. Any repair/replacement of the Eco Inverter motor must only be carried out by an authorised Grundig Service Agent (the "Service Agent").
6. Labour for the repair/replacement of the Eco Inverter motor is not included in this guarantee and is chargeable directly by the Service Agent.
7. Any additional components fitted to the product at any time will not be covered by this guarantee and will be chargeable directly by the Service Agent.
8. The guarantee is not transferable and cannot be exchanged for cash.
9. There are no alternative or additional offers to this Guarantee.
10. The guarantee is exclusive of the manufacturer's standard guarantee
11. The Terms and Conditions shown above are in addition to the standard terms and conditions of your product guarantee. Please read and refer to such Terms and Conditions when making any claim.
12. We may use the information you provide for marketing purposes and to analyse your purchasing preferences. We may keep your information for a reasonable period for these purposes in accordance with the applicable Data Protection Laws and General Data Protection Regulations (GDPR). You can opt into this service during the registration process. Further details are available at <http://www.Grundig.co.uk/cookie-and-privacy>.
13. These Terms and Conditions are governed by the laws of England and Wales; manufacturer: Beko plc, Beko House, 1 Greenhill Crescent, Watford WD18 8QU. Company Registration Number: 02415578.

HOW TO OBTAIN SERVICE FOR YOUR APPLIANCE

Please keep your purchase receipt or other proof of purchase details in a safe place; you will need to have this documentation available should the product require attention under guarantee.

Please take a few moments to complete the details below, as you will need this information when you call us, or to use our online services. When you call us you may be required to input your serial number into your telephone keypad. For help please visit grundig.co.uk/support/model-finder

- The product model number is printed on the Operating Instruction Booklet / User guide
- The product model and serial number is printed on the Rating Label affixed to the appliance.
- The Retailer (Purchased from) and Date of purchase will be printed on your purchase receipt or other proof of purchase paperwork

Recording of these details alone will not count as proof of purchase. A valid proof of purchase is required for requesting service under guarantee.

Model number	Serial number	Purchased from	Date of purchase

For service under guarantee or for product advice please call our Contact centre

Before requesting service please check the troubleshooting guide in the Operating Instructions booklet, as a charge may be levied where no fault is found, and even though your product may still be under guarantee.

After arranging service the area around the product must be easily accessible to the Engineer, without the need for cabinets or furniture to be removed or moved.

It is your responsibility to ensure our Engineers have a clean and safe environment to carry out any repairs.

Please have your Model number and Serial number available when you call us, as you may be required to input your serial number into your telephone keypad during your call.

UK Mainland & Northern Ireland:

0333 207 9920

Landline or mobile calls to 0333 numbers cost no more than calls to geographic numbers 01 or 02, and are charged at the basic rate. Calls from landlines and mobiles are included in free call packages but please check with your telephone service provider for exact call charges.

Republic of Ireland:

01 691 0203

Service once the manufacturers guarantee has expired

If you have purchased an extended guarantee please refer to the instructions contained within the extended guarantee agreement document, otherwise please call us using the appropriate number above, where service can be obtained at a charge.

Should you experience any difficulty in obtaining service please call us on **0333 207 9920** or **01 691 0203**

Contact us though our website

Send us a secure message through our online contact us form. Please visit our website, click Contact Us and choose a product support topic from the list of options. Complete the required details and click send message.

Product registrations

For UK and Republic of Ireland product registrations please visit grundig.co.uk/register.

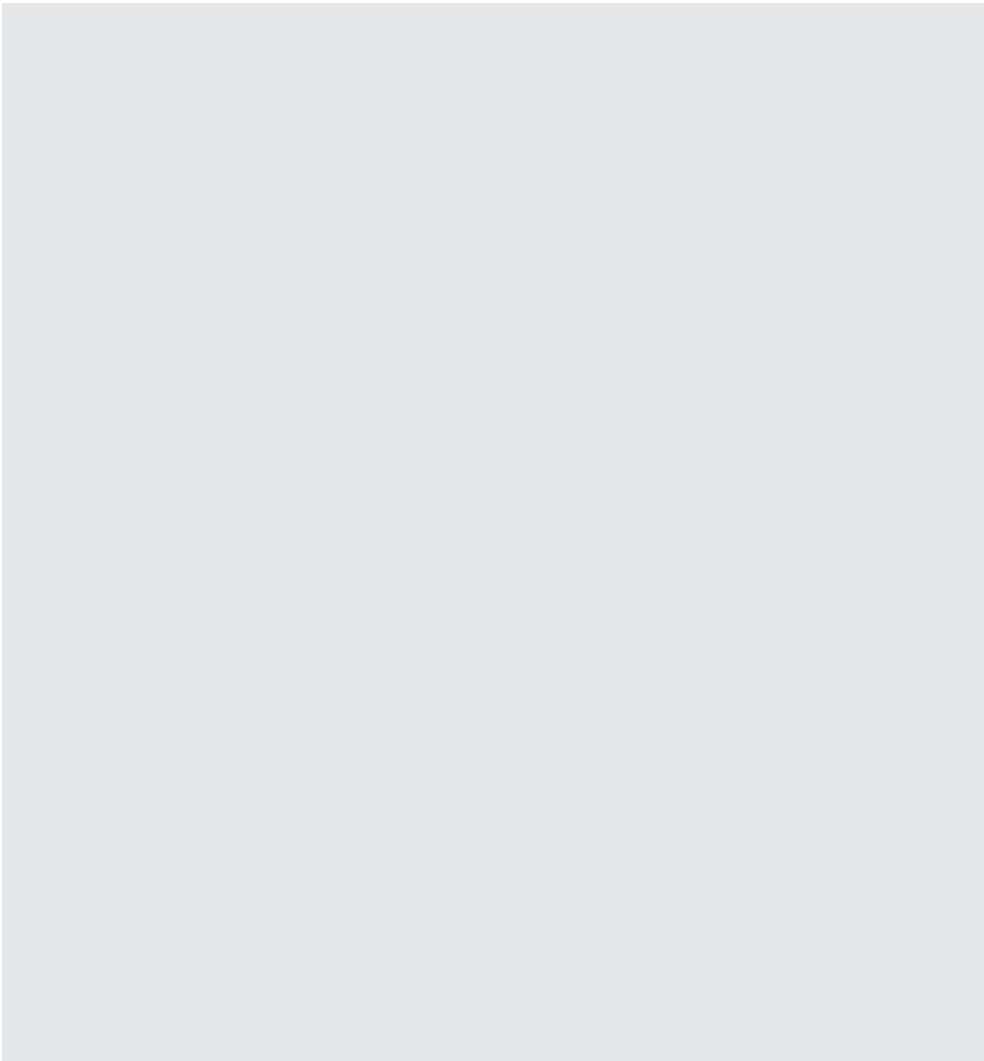

GRUNDIG

www.grundig.com