

RS-485 USER'S MANUAL

FRENIC **Mini** SERIES

FRENIC **ECO** SERIES

FRENIC **Multi** SERIES

FRENIC **MEGA** SERIES

FRENIC-Mini
FRENIC-Eco
FRENIC-Multi
FRENIC-MEGA

User's Manual
for RS-485 Communications Card

Copyright © 2002-2009 Fuji Electric Systems Co., Ltd.

All rights reserved.

The copyright in this user's manual belongs to Fuji Electric Systems Co., Ltd.

This manual may not be reprinted or reproduced, in whole or in part, except as may be expressly permitted by Fuji Electric Systems Co., Ltd.

Microsoft and Windows are registered trademarks or trademarks of Microsoft Corporation, U.S. The other company and product names used herein are generally trademarks or registered trademarks of other companies.

Any information contained herein is subject to change without prior notice for improvement.

Preface

The inverter can be connected with the keypad through RJ-45 connector (modular jack) *1, RS-485 communications card (option) *2, and control circuit terminal base *3. Using these connection methods, the inverter function can be expanded to such a level where RS-485 communications can be used. Use of RJ-45 connector for connection with the keypad permits remote operation from the keypad.

*1 FRENIC-Eco/Multi/MEGA

*2 FRENIC-Mini/Eco/Multi

*3 FRENIC-MEGA

This manual describes the functional expansion. For the handling of the inverter, see each User's Manual and Instruction Manual.

Please read through this user's manual to familiarize yourself with proper use. Improper handling or misuse may result in malfunction, shorter service life or failure.

This user's manual describes RS-485 communications function commonly used for FRENIC-Mini, FRENIC-Eco, FRENIC-Multi, and FRENIC-MEGA (FRENIC series).

The following shows relevant documents. Use the documents according to your purpose.

FRENIC-Mini

Name	Document number	Description
User's Manual	MEH446	Overview of FRENIC-Mini, how to operate the keypad, control block diagram, selection of peripherals, capacity selection, specifications, function codes, etc.
Catalog	MEH441 MEH451	Overview of FRENIC-Mini, features, specifications, outline drawing, options, etc.
Instruction Manual	INR-SI47-0791-E INR-SI47-1205-E	Inspection at the time of product arrival, installation and wiring, how to operate the keypad, troubleshooting, maintenance and inspection, specifications, etc.
RS-485 communications card Installation Manual	INR-SI47-0773	Inspection at the time of arrival, how to install the product

FRENIC-Eco

Name	Document number	Description
User's Manual	MEH456	Overview of FRENIC-Eco, how to operate the keypad, control block diagram, selection of peripherals, capacity selection, specifications, function codes, etc.
Catalog	MEH442	Overview of FRENIC-Eco, features, specifications, outline drawing, options, etc.
Instruction Manual	INR-SI47-0882-E INR-SI47-1059-E INR-SI47-1225-E	Inspection at the time of product arrival, installation and wiring, how to operate the keypad, troubleshooting, maintenance and inspection, specifications, etc.
RS-485 communications card Installation Manual	INR-SI47-0872	Inspection at the time of arrival, how to install the product

FRENIC-Multi

Name	Document number	Description
User's Manual	MEH457	Overview of FRENIC-Multi, how to operate the keypad, control block diagram, selection of peripherals, capacity selection, specifications, function codes, etc.
Catalog	MEH652 MEH653	Overview of FRENIC-Multi, features, specifications, outline drawing, options, etc.
Instruction Manual	INR-SI47-1094-E INR-SI47-1204-E	Inspection at the time of product arrival, installation and wiring, how to operate the keypad, troubleshooting, maintenance and inspection, specifications, etc.
RS-485 communications card Installation Manual	INR-SI47-1089	Inspection at the time of arrival, how to install the product

FRENIC-MEGA



Name	Document number	Description
User's Manual	MEH278	Overview of FRENIC-MEGA, how to operate the keypad, control block diagram, selection of peripherals, capacity selection, specifications, function codes, etc.
Catalog	MEH642 MEH655 MEH656	Overview of FRENIC-MEGA, features, specifications, outline drawing, options, etc.
Instruction Manual	INR-SI47-1183-E INR-SI47-1223-E	Inspection at the time of product arrival, installation and wiring, how to operate the keypad, troubleshooting, maintenance and inspection, specifications, etc.

These documents are subject to revision as appropriate. Obtain the latest versions when using the product.

■ Safety Precautions

Prior to installation, connection (wiring), operation, maintenance or inspection, read through this user's manual as well as the instruction and installation manuals to ensure proper operation of the product. Familiarize yourself with all information required for proper use, including knowledge relating to the product, safety information, and precautions.

This user's manual classifies safety precautions as shown below according to the severity of the accident that may occur if you fail to observe the precaution:

 WARNING	Failure to heed the information indicated by this symbol may lead to dangerous conditions, possibly resulting in death or serious bodily injuries.
 CAUTION	Failure to heed the information indicated by this symbol may lead to dangerous conditions, possibly resulting in minor or light bodily injuries and/or substantial property damage.

Failure to heed the information contained under the CAUTION title can also result in serious consequences. These safety precautions are of utmost importance and must be observed at all times.

 CAUTION
<p>The FRENIC-Mini/Eco is not designed for use in appliances and machinery on which lives depend. Consult Fuji before considering the FRENIC-Mini/Eco series of inverters for equipment and machinery related to nuclear power control, aerospace uses, medical uses or transportation. When the product is to be used with any machinery or equipment on which lives depend or with machinery or equipment which could cause serious loss or damage should this product malfunction or fail, ensure that appropriate safety devices and/or equipment are installed.</p>

Wiring

 WARNING
<ul style="list-style-type: none"> - Before starting wiring, confirm that the power is turned OFF (open). <p>An electric shock may result.</p>

 CAUTION
<ul style="list-style-type: none"> - The product cannot be connected directly to an RS-232C interface of a personal computer. - Before connecting wiring to the RJ-45 connector (modular jack) for connecting the keypad, equipped on the inverter (FRENIC-Eco) or the RJ-45 connector (modular jack) on the RS-485 communications card (option) (FRENIC-Mini), confirm the wiring of the device to be connected. For further information, see "2.2 Connections" under Chapter 2 of this manual. <p>Failure may result.</p>

Operation

 WARNING
<ul style="list-style-type: none"> - Note that the inverter starts to supply power to the motor and the motor runs upon resetting of an alarm with the operation command ON (closed). <p>An accident may result.</p>

Table of Contents

CHAPTER 1 OVERVIEW

1.1	Features	1-1
1.2	List of Functions	1-2

CHAPTER 2 COMMON SPECIFICATIONS1

2.1	Specifications of RS-485 Communications	2-1
2.1.1	Specification of the RJ-45 connector for RS-485 communications (modular jack)	2-3
2.1.2	Specification of the terminal for RS-485 communications	2-4
2.1.3	RJ-45 connector (modular jack) for function expansion	2-5
2.1.4	Specification of connection cable for RS-485 terminal	2-7
2.2	Connections	2-8
2.2.1	Basic connection	2-8
2.2.2	Connection procedures	2-11
2.2.3	Devices for connection	2-15
2.2.4	Measures against noise	2-16
2.3	Switching to Communications	2-18
2.3.1	Functions for the switching	2-18
2.3.2	Link functions (operation selection)	2-19
2.3.3	How to switch communications enabled/disabled	2-20
2.3.4	Link functions for supporting data input (operation select)	2-21
2.4	Making RS-485-related Settings	2-22
2.4.1	Link function (RS-485 setting)	2-22
2.5	Selecting the Method of Storing Communications Data	2-25

CHAPTER 3 Modbus RTU PROTOCOL

3.1	Messages	3-1
3.1.1	Message formats	3-1
3.1.2	Message types	3-1
3.1.3	Message frames	3-2
3.1.4	Message categories	3-4
3.1.5	Communications examples	3-11
3.2	Host Side Procedures	3-12
3.2.1	Inverter's response time	3-12
3.2.2	Timeout processing	3-13
3.2.3	Receiving preparation complete time and message timing from the host	3-14
3.2.4	Frame synchronization method	3-14
3.3	Communications Errors	3-15
3.3.1	Categories of communications errors	3-15
3.3.2	Operations in case of errors	3-16
3.4	CRC-16	3-19
3.4.1	Overview of the CRC-16	3-19
3.4.2	Algorithm	3-19
3.4.3	Calculation example	3-21
3.4.4	Frame length calculation	3-22

CHAPTER 4 FUJI GENERAL-PURPOSE INVERTER PROTOCOL

4.1	Messages	4-1
4.1.1	Message formats	4-1
4.1.2	Transmission frames	4-2
4.1.3	Descriptions of fields.....	4-11
4.1.4	Communications examples.....	4-13
4.2	Host Side Procedures	4-15
4.2.1	Inverter's response time	4-15
4.2.2	Timeout processing.....	4-16
4.2.3	Receiving preparation complete time and message timing from the host.....	4-16
4.3	Communications Errors.....	4-17
4.3.1	Categories of communications errors.....	4-17
4.3.2	Operations in case of communications errors	4-18

CHAPTER 5 FUNCTION CODES AND DATA FORMATS

5.1	Communications Dedicated Function Codes	5-1
5.1.1	About communications dedicated function codes	5-1
5.1.2	Command data	5-2
5.1.3	Monitor data 1	5-9
5.1.4	Information displayed on the keypad	5-15
5.2	Data Formats.....	5-26
5.2.1	List of data format numbers	5-26
5.2.2	Data format specifications	5-47

===Appendix===

CHAPTER 6 FLOOR LEVEL NETWORK (P1 PROTOCOL)

6.1	Messages	6-1
6.1.1	polling/selecting	6-1
6.2	Point Database.....	6-1
6.3	Setting up Communications of the FRENIC-Eco	6-1
6.4	Using the FRENIC-Eco	6-2
6.5	Strategies	6-3
6.5.1	Monitoring	6-3
6.5.2	Supervisory Control	6-3
6.5.3	Slaving the Drive.....	6-4
6.6	Other Functionality	6-4
6.6.1	Start and stop the drive.....	6-4
6.6.2	Change drive directions	6-4
6.6.3	Lock the FRENIC-Eco panel.....	6-4
6.6.4	Digital Outputs	6-4
6.6.5	Analog Inputs monitor.....	6-5
6.6.6	Loop gains	6-5
6.6.7	Reading and resetting faults	6-5
6.6.8	Address limitations.....	6-5
6.6.9	Point 90,91,92,93 Read/Write Parameter Number (Parameter Data).....	6-10
6.6.10	Reading and Writing from/to Inverter's Function Codes.....	6-11

CHAPTER 7 Metasys N2 (N2 PROTOCOL)

- 7.1 Messages 7-1
 - 7.1.1 Transmission Specification 7-1
 - 7.1.2 polling/selecting 7-1
- 7.2 Setting up Communications of the FRENIC-Eco 7-1
- 7.3 Point mapping tables 7-2
- 7.4 Read / Write Parameter..... 7-3
- 7.5 Support Command List..... 7-4

CHAPTER 1

OVERVIEW

This chapter describes the functions that can be realized by performing RS-485 communications.

Table of Contents

1.1	Features	1-1
1.2	List of Functions	1-2

1.1 Features

The functions listed below can be implemented using RS-485 communications.

- The keypad can be mounted on the easy-to-access front of control panel with an extension cable (option).
- The function code data of the inverter can be edited and the operation status of the inverter can be monitored by connecting it to a personal computer on which inverter support software runs (see the "FRENIC Loader Instruction Manual").
- The inverter can be controlled as a subordinate device (slave) by connecting it to an upper level device (host (master)) such as a PLC or personal computer.

As the communications protocols for controlling inverter, the Modbus RTU widely used by a variety of appliances, and the Fuji general-purpose inverter protocol common to Fuji's inverters are available.

Modbus RTU protocol

The Modbus RTU protocol is a set of communications specifications defined to connect Modicon's PLCs (Programmable Logic Controllers) in a network. A network is established between PLCs or between a PLC and another slave unit(s) (inverter(s), etc.). The main functions include:

- supporting both a query-response format and a broadcast format for messages.
- enabling the host unit as the master to transmit queries to each inverter as a slave, and each slave to send back responses to the queries to the master.
- supporting two modes, RTU mode and ASCII mode, as transmission mode for the standard Modbus Protocol. FRENIC-Mini/Eco/Multi supports the RTU mode only, which provides a high transmission density.
- performing an error check through a CRC (cyclic redundancy check) to ensure accurate data transmission.

Fuji general-purpose inverter protocol

This protocol is commonly used for all models of Fuji's general-purpose inverters. The main functions include:

- enabling, as a common protocol, operation of all models of Fuji's general-purpose inverters with the same host program (function codes cannot be generally edited because specifications are different among models).
- adopting fixed-length transmission frames as standard frames to facilitate developing communications control programs for hosts.
- reducing the communications time in response to operation commands and frequency setting which are required quick response by using optional transmission frames.

 Since the protocol switches to the keypad dedicated protocol automatically by connecting the keypad, it is not necessary to set up the communications-related functions.

- Although the FRENIC Loader uses a dedicated protocol for loader commands, part of the communications conditions must be set. (For further information, see the "FRENIC Loader Instruction Manual.")
- With regard to a FRENIC-Mini that uses inverter ROM 0399 or earlier version, part of the RTU protocol functions are restricted. Contact us for these restrictions. Confirm the ROM version according to the menu "5_14" described in "3.2.2 [5] Reading Maintenance Information" under Chapter 3 of the FRENIC-Mini Instruction Manual (INR-SI47-0791-E).

1.2 List of Functions

The functions listed below become available by operating the appropriate function codes from the host controller.

The chapters that follow describe these functions in detail.

Table 1.1 List of RS-485 communications functions

Function	Description	Related function code
Operation	The functions equivalent to the terminal functions shown below can be executed through communications: -Forward operation command "FWD" and reverse operation command "REV" -Digital input commands ([FWD], [REV], [X1] - [X9] terminals) (The number of X terminals varies with the inverter model.) -Alarm reset command ("RST")	S codes (dedicated to communications)
Frequency setting	Either of the following three setting methods can be selected: -Set up as "±20000/maximum frequency." -Frequency (adjustable unit: 0.01 Hz) without polarity -Rotation speed (adjustable unit: 1r/min) Only MEGA has a polarity.	
PID command	-Set up as "±20000/100%."	
Operation monitor	The items below can be monitored: -Frequency command -Actual values (frequency, current, voltage, etc.) -Operation status, information on general-purpose output terminals, etc.	
Maintenance monitor	The items below can be monitored: -Cumulative operation time, DC link voltage -Information to determine the service life of parts to be periodically replaced (main circuit capacitor, PC board capacitor, cooling fan) -Model codes, capacity codes, ROM version, etc.	M codes W codes X codes Z codes (dedicated to communications)
Alarm monitor	The items below can be monitored: -Monitoring alarm history (last four alarms) -Monitoring information when an alarm occurs (last four alarms) Operation information (output/set frequencies, current, voltage, etc.) Operation status, information on general-purpose output terminals Maintenance information (cumulative operation time, DC link voltage, heat sink temperature, etc.)	
Function code	All types of function code data can be monitored and changed.	All function codes other than above

CHAPTER 2

COMMON SPECIFICATIONS

This chapter describes the specifications common to the Modbus RTU protocol, Fuji general-purpose inverter protocol, and loader protocol. For further information about the specific specifications of each protocol, see Chapter 3 "Modbus RTU Protocol" and Chapter 4 "Fuji General-purpose Inverter Protocol."

Table of Contents

2.1	Specifications of RS-485 Communications	2-1
2.1.1	Specification of the RJ-45 connector for RS-485 communications (modular jack)	2-3
2.1.2	Specification of the terminal for RS-485 communications	2-4
2.1.3	RJ-45 connector (modular jack) for function expansion	2-5
2.1.4	Specification of connection cable for RS-485 terminal	2-7
2.2	Connections	2-8
2.2.1	Basic connection	2-8
2.2.2	Connection procedures	2-11
2.2.3	Devices for connection	2-15
2.2.4	Measures against noise	2-16
2.3	Switching to Communications	2-18
2.3.1	Functions for the switching	2-18
2.3.2	Link functions (operation selection)	2-19
2.3.3	How to switch communications enabled/disabled	2-20
2.3.4	Link functions for supporting data input (operation select)	2-21
2.4	Making RS-485-related Settings	2-22
2.4.1	Link function (RS-485 setting)	2-22
2.5	Selecting the Method of Storing Communications Data	2-25

2.1 Specifications of RS-485 Communications

Table 2.1 shows the specifications of RS-485 communications.

Table 2.1 RS-485 communications specifications

Item	Specification		
Protocol	FGI-BUS	Modbus RTU	Loader commands
Complying with	Fuji general-purpose inverter protocol	Modicon Modbus RTU-compliant (only in RTU mode only)	Special commands dedicated to inverter support loader software (not disclosed)
No. of supporting stations	Host device: 1 Inverters: up to 31		
Physical level	EIA/RS-485		
Connection to RS-485	Connect using an 8-wire RJ-45 connector or terminal block	8-wire RJ-45 connector	
Synchronization method of character	Start-Stop system		
Transmission mode	Half-duplex		
Transmission speed (bps)	2400, 4800, 9600, 19200 and 38400 (maximum 19200 for FRENIC-Mini)		
Maximum transmission cable length	500m		
No. of available station addresses	1 to 31	1 to 247	1 to 255
Message frame format	FGI-BUS	Modbus RTU	Loader command
Synchronization method of transmission frames	Detection SOH (Start Of Header) character (SOH 01 _H)	Detection of no-data transmission time for 3 byte period	Start code 96H detection
Frame length	Normal transmission: 16 bytes (fixed) High-speed transmission: 8 or 12 bytes	Variable length	Variable length
Maximum transfer data	Write: 1 word Read: 1 word	Write: 50 words Read: 50 words FRENIC-MEGA Write: 100 words Read: 100 words	Write: 41 words Read: 41 words
Messaging system	Polling/Selecting/Broadcast		Command message
Transmission character format	ASCII	Binary	Binary
Character length	8 or 7 bits (selectable by the function code)	8 bits (fixed)	8 bits (fixed)
Parity	Even, Odd, or None (selectable by the function code)		Even
Stop bit length	1 or 2 bits (selectable by the function code)	No parity: 2 bits Even or Odd parity: 1 bit	1 bit (fixed)
Error checking	Sum-check	CRC-16	Sum-check

Table 2.2 Connection method and applicable protocol for FRENIC series

Model	Communications means	Connection port	Hardware specifications for connection port	Port type	Applicable protocol *1			
					Keypad*2	Loader	Modbus RTU*3	Fuji general-purpose inverter protocol
FRENIC-Mini	RS-485 communications card (option)	RJ-45 connector	See 2.1.1.	Standard port	○	○	○	○
FRENIC-Eco*4	Inverter-keypad coupling connector	RJ-45 connector	See 2.1.1.	Standard port	○	○	○	○
	RS-485 communications card (option)	Terminal block	See 2.1.2.	Extension port	×	×	○	○
FRENIC-Multi	Inverter-keypad coupling connector	RJ-45 connector	See 2.1.1.	Standard port	○	○	○	○
	RS-485 communications card*4 (option)	RJ-45 connector for function expansion (2 pc)	See 2.1.3.	Extension port	×	×	○	○
FRENIC-MEGA	Inverter-keypad coupling connector	RJ-45 connector	See 2.1.1.	Standard port	○	○	○	○
	Standard port	Terminal block	See 2.1.2.	Extension port	×	×	○	○

*1 The protocol support ranges such as keypad monitoring items, loader functions, and accessible function codes differ depending on the inverter type. For details, see the instruction manual for each protocol.

*2 The applicable keypad depends on the inverter type.

Series	Remote keypad			Multi-function keypad	
	TP-E1	TP-M1	TP-E1U	TP-G1	TP-G1-J1
FRENIC-Eco	○	×	×	○	○
FRENIC-Multi	×	○	×	○	○
FRENIC-MEGA	×	×	○	×	○

*3 The Modbus RTU used for FRENIC-Mini does not support the coil commands. See "Chapter 3 Modbus RTU PROTOCOL" for details.

*4 N2 Protocol is applicable only with FRN□□F1□-□A, FRN□□F1□-□C, FRN□□F1□-□E and FRN□□F1□-□U. Refer to INR-SI47-1322-E

2.1.1 Specification of the RJ-45 connector for RS-485 communications (modular jack)

The RS-485 communications port of the FRENIC-Mini's RS-485 communications card (option) and the RS-485 communications port for connecting the keypad equipped on the FRENIC-Eco/Multi are the RJ-45 connectors with the pin assignment shown below.

Pin No.	Signal name	Function	Remarks
1, 8	Vcc	Power source for the keypad	5V
2, 7	GND	Reference voltage level	Ground (0V)
3, 6	NC	No connection	—
4	DX-	RS-485 communications data (-)	A terminating resistor of 112Ω is incorporated. Connection/cut off is selected by a switch*1.
5	DX+	RS-485 communications data (+)	

*1 For the details of the switch, refer to 2.2.2 [2] "About terminating resistors".

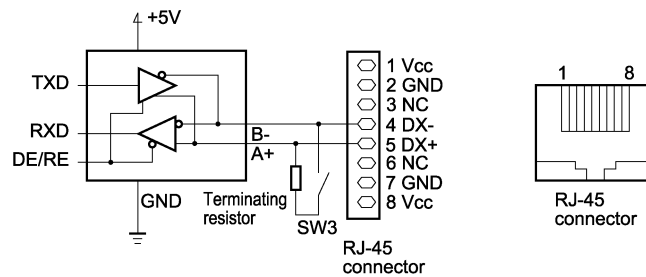

A power supply for the keypad is connected to the RJ-45 connector for RS-485 communications (via pins 1, 2, 7, and 8). Note that the pins assigned to the power supply must not be connected when connecting the inverter with another device.

2.1.2 Specification of the terminal for RS-485 communications

- RS-485 communications card for FRENIC-Eco (option)

FRENIC-Eco/Multi's RS-485 communications card is equipped with two pairs of terminals for multidrop. The terminal symbols, terminal names, and functions of the respective terminals are as shown in the table below.

Terminal symbol	Terminal name	Function description
1	DX+	RS-485 communications data (+) terminal This is the (+) terminal of RS-485 communications data.
	DX-	RS-485 communications data (-) terminal This is the (-) terminal of RS-485 communications data.
	SD	Communications cable shield terminal This is the terminal for relaying the shield of the shielded cable, insulated from other circuits.
2	DX+	DX+ relay terminal for multidrop This is the relay terminal of RS-485 communications data (+).
	DX-	DX- relay terminal for multidrop This is the relay terminal of RS-485 communications data (-).
	SD	SD relay terminal for multidrop This is the terminal for relaying the shield of the shielded cable, insulated from other circuits.
Internal switch	Terminating resistor switching	A terminating resistor of 112Ω is incorporated. Connection/release is switched by this switch*1.

*1 For the details of the switch, see "2.2.2 Cautions [2] About terminating resistors."

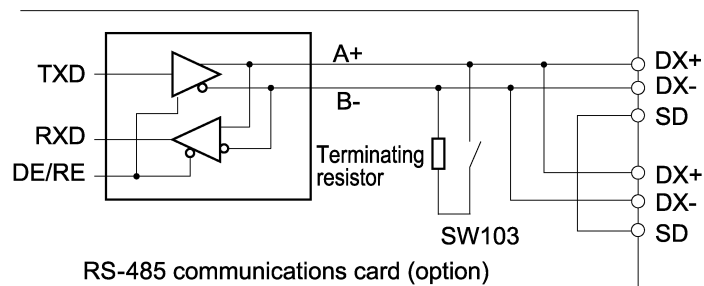

- FRENIC-MEGA

The terminal for RS-485 communications port 2 is provided in the control circuit terminals of the inverter. The table below shows the code, name, and function of each terminal. These terminals can be easily connected with the multi-drop circuit.

Terminal symbol	Terminal name	Function description
DX+	RS-485 communications data (+) terminal	This is the relay terminal of RS-485 communications data (+).
DX-	RS-485 communications data (-) terminal	This is the relay terminal of RS-485 communications data (-).
SD	Communications cable shield terminal	This is the terminal for relaying the shield of the shielded cable, insulated from other circuits.
Internal switch	Terminating resistor switching	A terminating resistor of 112Ω is incorporated. Connection/release is switched by this switch*1.

*1 For the details of the switch, see "2.2.2 Cautions [2] About terminating resistors."

2.1.3 RJ-45 connector (modular jack) for function expansion

RS-485 communications card for FRENIC-Multi (option)

Two RJ-45 connectors for function expansion are provided for connection with the multi-drop circuit. The terminal symbol, terminal name, and functions are shown in the table below. The connector for standard equipment and that for a relay have the same specifications without any distinction.

Pin No.	Signal name	Description	Remarks
1, 6, 7, 8	NC	Unused	—
2	SD	Communications cable shielded terminal	Terminal for relaying the shield of the shielded cable. The 2nd terminals of the two RJ-45 connectors are internally connected with each other.
3	—	Unused	The 3rd terminals of the two RJ-45 connectors are internally connected with each other.
4	DX-	RS-485 communications data (-) terminal	Negative terminal for RS-485 communications data
5	DX+	RS-485 communications data (+) terminal	Positive terminal for RS-485 communications data



The RJ-45 connector for function expansion differs in terminal functions from the RJ-45 connected with the keypad built in the inverter.

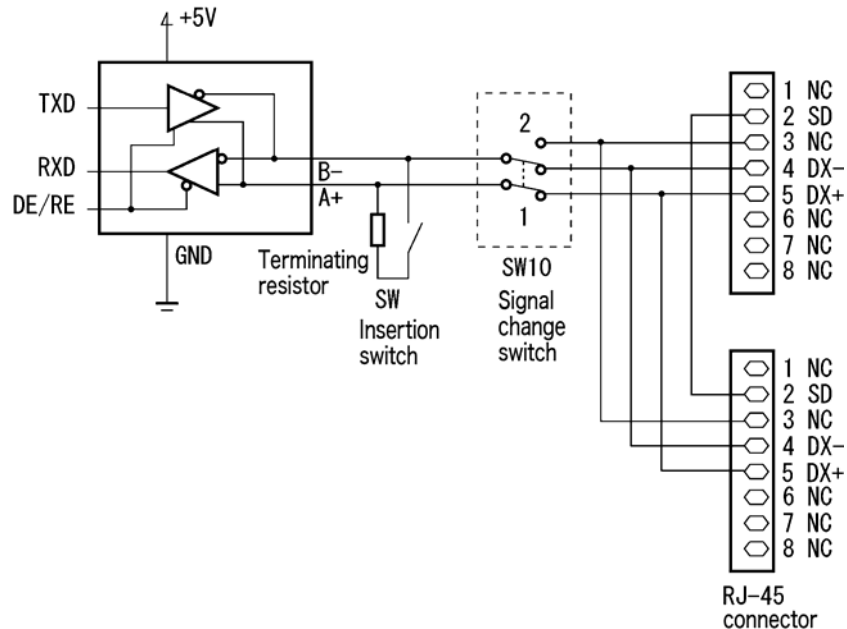

* For details regarding terminator insertion switch (insertion SW), see "2.2.2 Cautions [2] About terminating resistors."



Connection with FVR-E11S series

The pin assignment of FVR-E11S series differs from that of FRENIC series. Therefore, it may be impossible to access the communications system to which FVR-E11S is connected. The signal change switch (SW10) equalize the signal assignment with that of FVR-E11S series, which makes it easy to connect with the communications system. When SW10 switch is set to "2", the functions are assigned to the pins as shown in the table below.

Pin No.	Signal name	Description	Remarks
1, 6, 7, 8	NC	Unused	–
2	SD	Communications cable shielded terminal	Terminal for relaying the shield of the shielded cable. The 2nd terminals of the two RJ-45 connectors are internally connected with each other.
3	DX-	RS-485 communications data (-) terminal	Negative terminal for RS-485 communications data
4	DX+	RS-485 communications data (+) terminal	Positive terminal for RS-485 communications data
5	NC	Unused	The 5th terminals of the two RJ-45 connectors are internally connected with each other.

* For comparison of pin assignment between FRENIC series and FVR-E11S series, see "Table 2.3. in 2.2.2 Caution [1] RJ-45 connector (modular jack) pin layout. "

For the arrangement of the signal change switch (SW10), see "Figure 2.6 (e) in 2.2.2 Cautions [2] About terminating resistors."

2.1.4 Specification of connection cable for RS-485 terminal

[1] RJ-45 connector

The specification of the connection cable is as follows to ensure the reliability of connection.

	Specifications
Common specification	Straight cable for 10BASE-T/100BASE-TX, satisfying the US ANSI/TIA/EIA-568A category 5 standard (commercial LAN cable)
Extension cable for remote operations (CB-5S)	Same as above, 8-core, 5m long, RJ-45 connector (both ends)
Extension cable for remote operations (CB-3S)	Same as above, 8-core, 3m long, RJ-45 connector (both ends)
Extension cable for remote operations (CB-1S)	Same as above, 8-core, 1m long, RJ-45 connector (both ends)

To connect a keypad, use an 8-core straight cable. Use an extension cable for remote operations (CB-5S, CB-3S, or CB-1S) or a commercial LAN cable (20m max.).

Recommended LAN cable

Maker: Sanwa Supply (JAPAN)

Type: KB-10T5-01K (1 m)

KB-STP-01K (1-m shielded cable: Compliant with EMC Directives)

[2] Cable specifications for connection with terminals

To secure the reliability in connection, use the twisted pair shielded cable AWG16 to 26 for long-distance transmission.

Recommended cable

Maker: Furukawa Electric's AWM2789 long-distance cable

Type(Product code): DC23225-2PB

2.2 Connections

2.2.1 Basic connection

When connecting the keypad with the inverter or connecting the inverter with a host such as personal computer or PLC, use a standard LAN cable (straight for 10BASE-T). A converter is necessary to connect a host not equipped with RS-485 interface.

(1) Connection with the keypad

FRENIC-Mini:

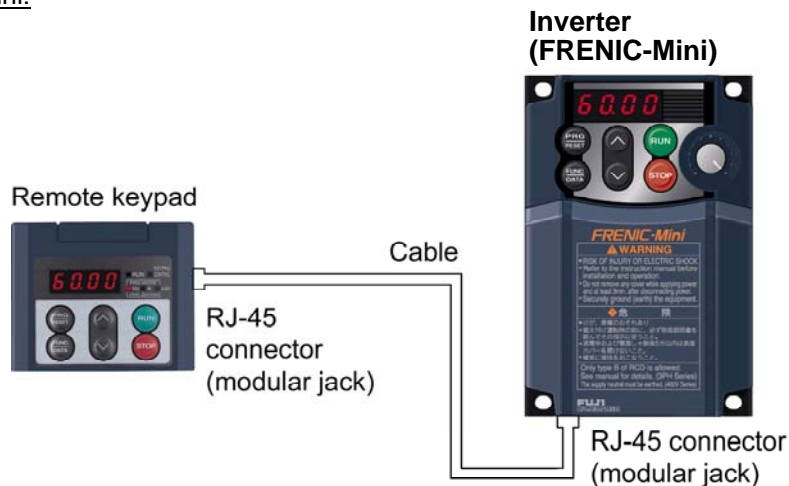

FRENIC-Eco/Multi/MEGA:

The figure below shows the method of connecting the keypad to the keypad connector of the inverter.

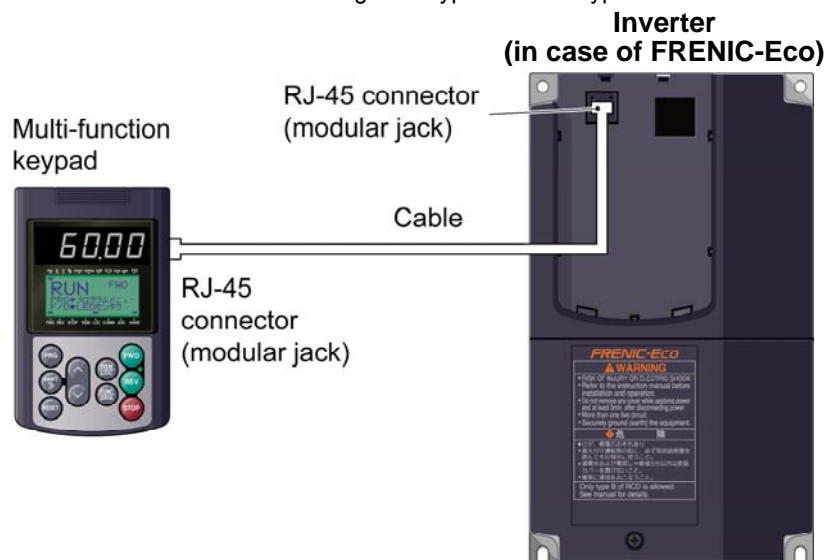

Figure 2.1 Connection with the keypad

Cable: extension cable for remote operations (CB-5S, CB-3S, or CB-1S) or commercial LAN cable



- For the keypad, be sure to turn off the terminating resistor.
- Keep wiring length 20m or less.
- For FRENIC-Mini, only the remote keypad is available. In addition, the RS-485 communications card (option) is necessary for connection.

- (2) Connection with the inverter support software FRENIC Loader (personal computer)(when connecting with the USB port via a recommended converter)

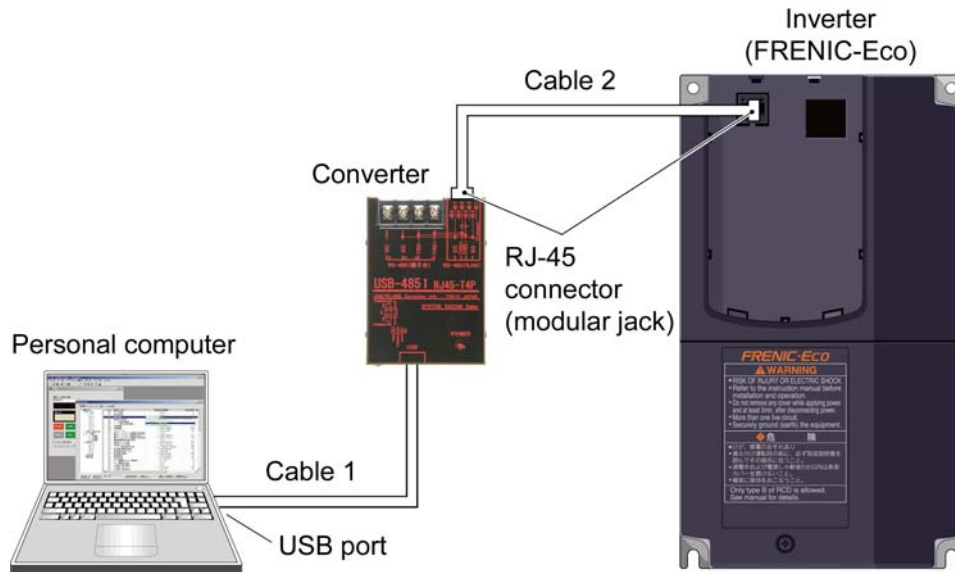

Figure 2.2 Connection with a personal computer

- Converter: USB-485I, RJ45-T4P (System Sacom Sales Corp., Japan)
 Cable 1: USB cable supplied with the converter
 Cable 2: extension cable for remote operations (CB-5S, CB-3S, or CB-1S) or commercial LAN cable



For FRENIC-Mini, the RS-485 communications card (option) is necessary for connection.

(3) Example of typical connection other than above (Multidrop connection using the RJ-45 connector)

The figure below shows a connecting example to the multi-drop circuit with RJ-45 connector. RJ-45 needs a multi-drop branch adaptor as an external device for relaying. The adaptor for relaying is not necessary for the inverter with RJ-45 connector for function expansion. Set the terminator insertion switch of the terminating inverter to ON. For the terminator insertion switch ON/OFF switch, see "2.2.2 Cautions [2] About terminating resistors."

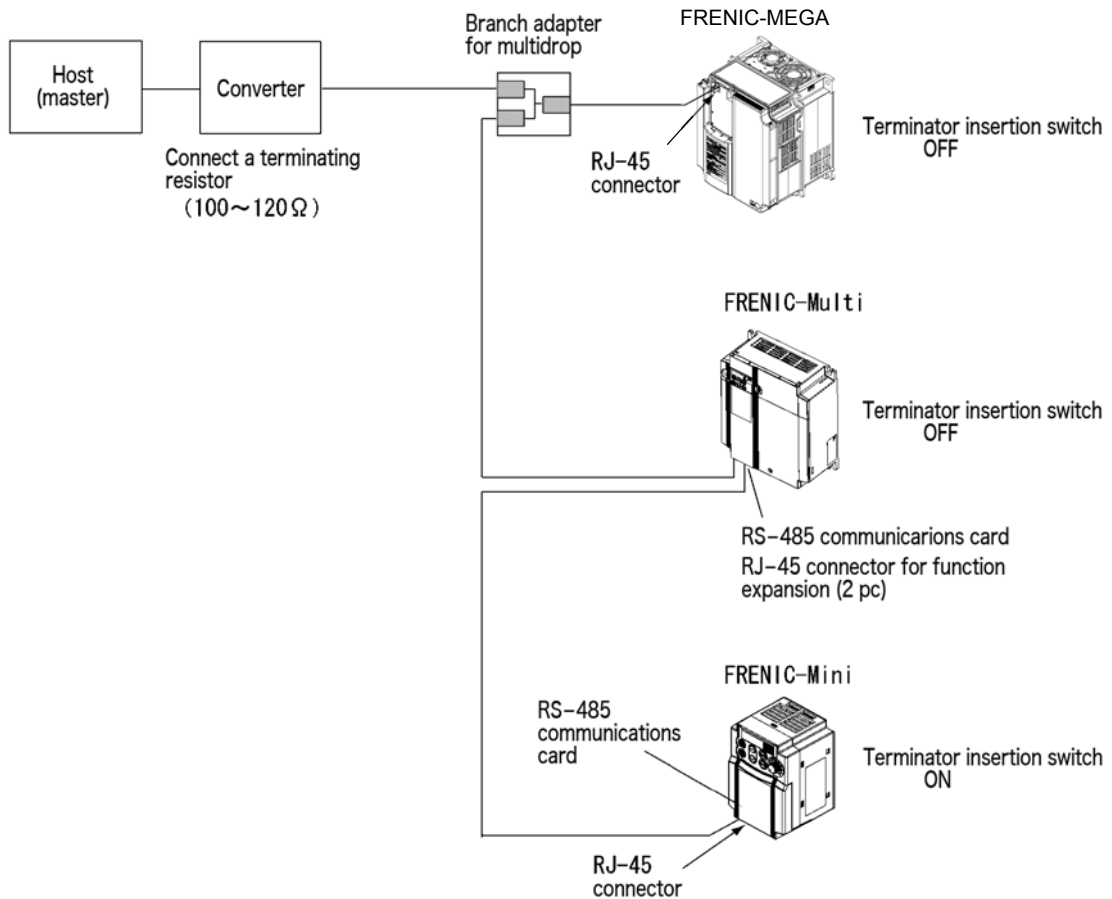

Figure 2.3 Multidrop connection diagram (connection via the RJ-45 connector)

- Converter: Not necessary if the host is equipped with RS-485 interface.
- Branch adapter for multidrop: Useful when implementing 1:n multidrop configuration using a cable with a RJ-45 connector.
- Cable: Use a connection cable meeting the specification. (Refer to 2.1.4.)

- CAUTION** - A power supply for the keypad is connected to the RJ-45 connector of the inverter (via pins 1, 2, 7, and 8). When connecting the inverter with another device, do not use the pins assigned to the power supply but use the signal pins (pins 4 and 5).
- When selecting additional devices to prevent the damage or malfunction of the control PCB caused by external noises or eliminate the influence of common mode noises, be sure to see section 2.2.3 "Devices for connection."
 - Keep the total wiring length 500m max.
 - For FRENIC-Mini, the RS-485 communications card (option) is necessary for connection.

(4) Multidrop connection using terminal block

When using the RS-485 communications card (option) to connect FRENIC-Eco with a host by multidrop connection, connect them as shown in the figure below. Turn on the SW103 switch for inserting a terminating resistance, equipped on the RS-485 communications card (option) mounted on the inverter used as the terminator.

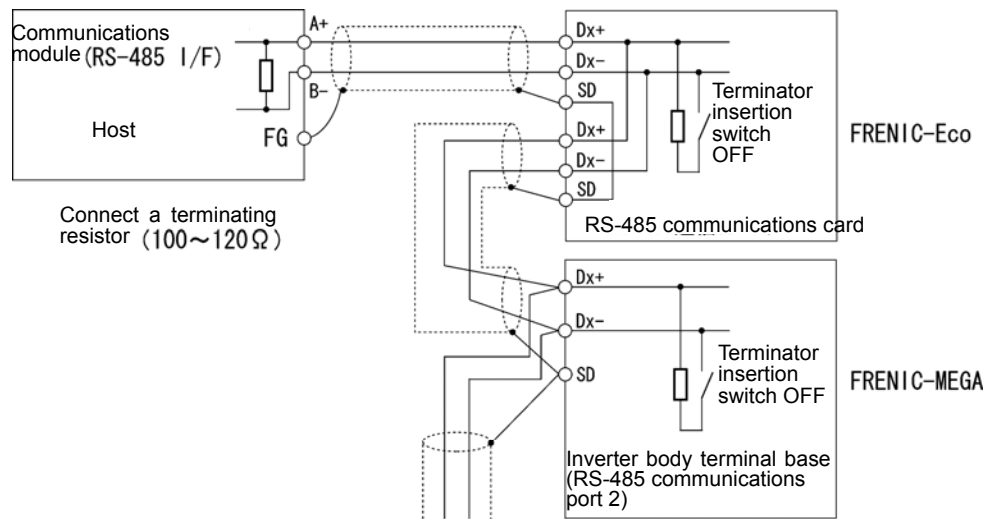

Figure 2.4 Multidrop connection diagram (terminal block connection)

For the switch used to insert the terminal resistance, refer to [2] About terminating resistors in "2.2.2 Connection procedures."

- When selecting additional devices to prevent the damage or malfunction of the control PCB caused by external noises or eliminate the influence of common mode noises, be sure to see section 2.2.3 "Devices for connection."
- Keep the total wiring length 500m max.

2.2.2 Connection procedures

This section describes the knowledge necessary for connecting with a host.

[1] RJ-45 connector (modular jack) pin layout

To facilitate connection with a typical RS232C to RS-485 converter, the FRENIC-Mini/Eco/Multi/MEGA assigned pin No. 4 to DX- signals and pin No. 5 to DX+ signals.

- Pins 1, 2, 7, and 8 are assigned to the power supply for the keypad. Do not use these pins when connecting the inverter with another device via the RJ-45 connector but use signal pins (pins 4 and 5) only.

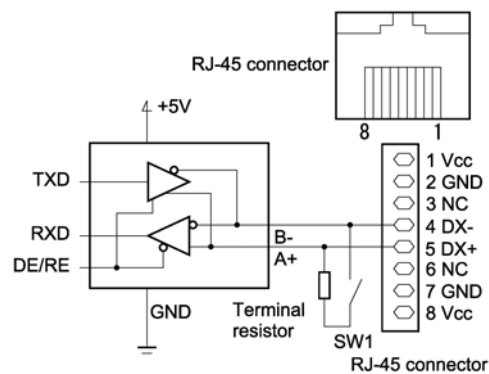

Figure 2.5 Pin layout of RJ-45 connector

- To connect the FVR-E11S series inverter on the communications network on which the FRENIC-Mini/Eco/Multi exists, pin Nos. 3 and 5 must be switched using a connection cable, etc. Table 2.3 makes a comparison of pin layout between the FRENIC-Mini/Eco/Multi and the FVR-E11S series.

 **WARNING**

- RJ-45 connector for communications through RS-485 is connected with the keypad power (pin No. 1, 2, 7, and 8). When connecting with the other equipment, be careful not to connect with the pins assigned as the power supply.
- If the communications circuit is connected with FVR-E11S series, there is a possibility that the power circuit is shorted or the signal wires collide with each other, resulting in the damage to the circuit. For details, see "2.2.2 Cautions."

Failure may occur.

Table 2.3 Comparison of pin layout between the FRENIC series and the FVR-E11S

Pin No.	Inverter itself of FRENIC series (FRENIC Mini needs an option.)	FVR-E11S	Remarks
1	VCC (+5V)	SEL_TP (keypad selected)	The power supply is short-circuited when connected.
2	GND	GND	
3	NC	DX-	
4	DX-	DX+	
5	DX+	SEL_ANY (optional)	
6	NC	GND	
7	GND	VCC	The power supply is short-circuited when connected.
8	VCC (+5V)	VCC	The power supply is short-circuited when connected.

When RS-485 communications card for FRENIC-Multi is used, RJ-45 connector for function expansion receives the same pin assignment of DX+ and DX- signals with the pin assignment for FVR-E11S series using the signal change switch SW10. See "2.1.3 Specification of RJ-45 connector (modular jack) for function expansion" for details, see "Figure. 2.6 (e) in [2] About terminating resistors" regarding pin layout of the signal change switch SW10.

[2] About terminating resistors

Insert a terminating resistor (100 to 120Ω) into both the ends of the connection cable. This allows controlling signal reflection and reducing noises.

Be sure to insert a terminating resistor into the terminating host side and the side of the device connected to the final stage, in short, both the terminating devices configuring the network. Terminating resistors are inserted into total two positions. Note that the current capacity of signals may be insufficient if terminating resistors are inserted into three or more devices.

If the inverter is used as a terminating device, turn on the switch for terminal resistor insertion.

Model	Objective PCB	Switch No.	Layout
FRENIC-Mini	RS-485 communications card	SW1	See Figure 2.6(a).
FRENIC-Eco	Control PCB of inverter	SW3	See Figure 2.6(b).
	RS-485 communications card	SW103	See Figure 2.6(c).
FRENIC-Multi	Body (printed circuit board)	SW3	See Figure 2.6(d).
	RS-485 communications card	SW9	See Figure 2.6(e).
FRENIC-MEGA	Body (printed circuit board)	SW2	See Figure 2.6(f).
		SW3	

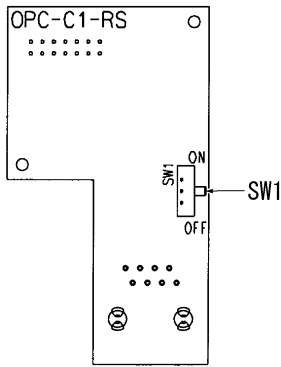

(a) RS-485 communications card (for FRENIC-Mini)

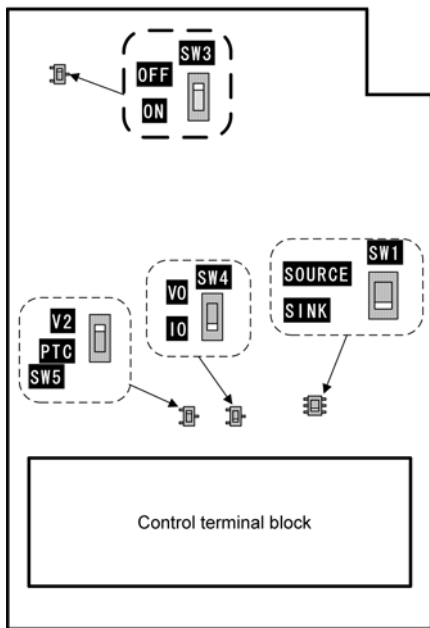

(b) Control PCB (FRENIC-Eco)

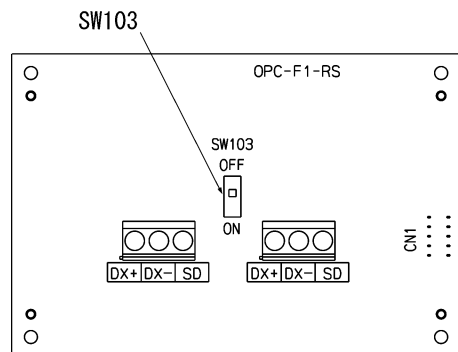

(c) RS-485 communications card (for FRENIC-Eco)

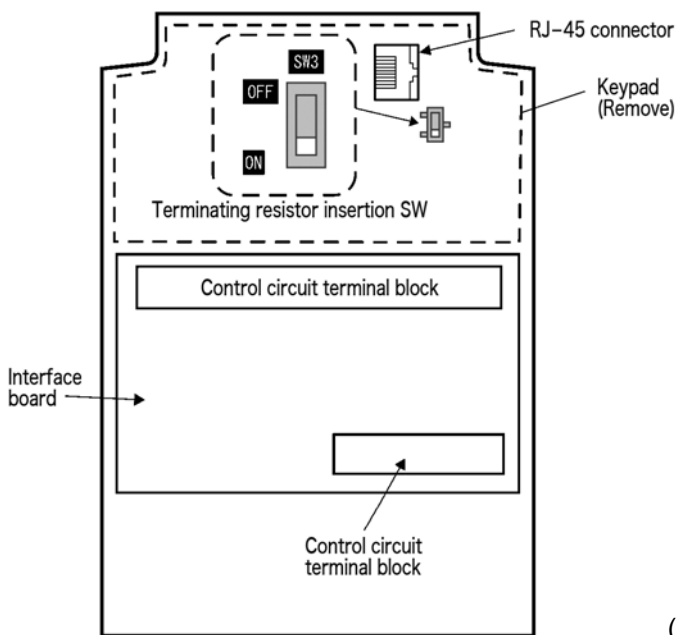

(d) Printed circuit board (FRENIC-Multi)

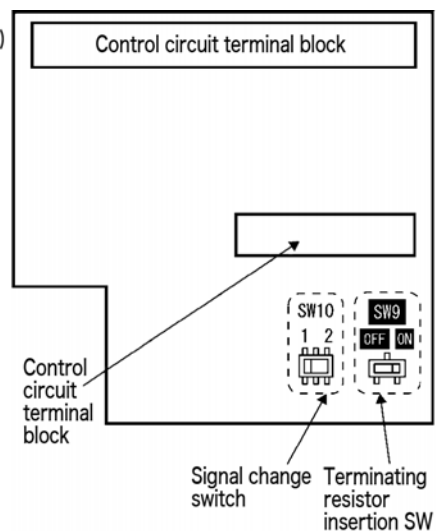

(e) RS-485 communications card (for FRENIC-Multi)

Figure 2.6(1) Layout of the switches for inserting a terminating resistance

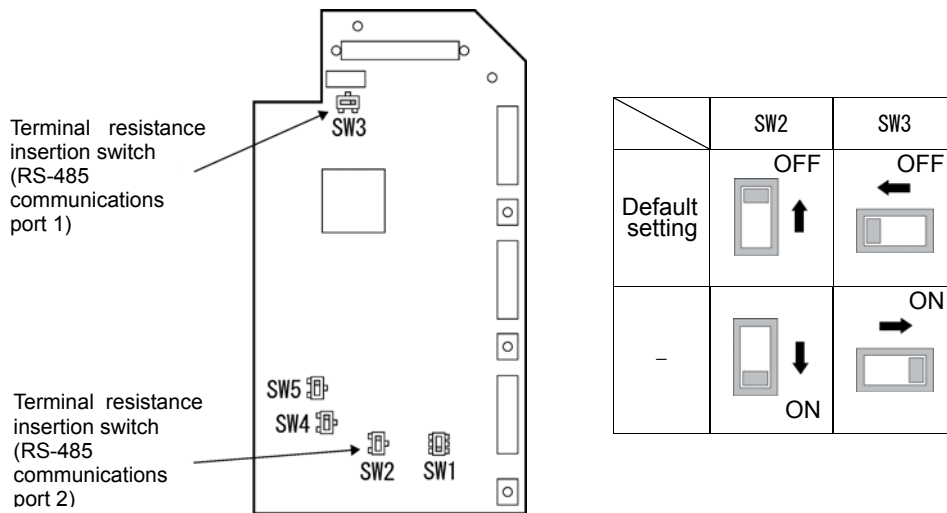

(f) Printed circuit board (FRENIC-MEGA)

Figure 2.6 (2) Switch arrangement for insertion of a terminal resistance

[3] Connection with a four-wire host

Although FRENIC-Mini/Eco uses two-wire cables, some hosts adopt only four-wire cables. Connect to such a host by connecting the driver output with the receiver input with a crossover cable on the host side to change the wiring method to two-wire.

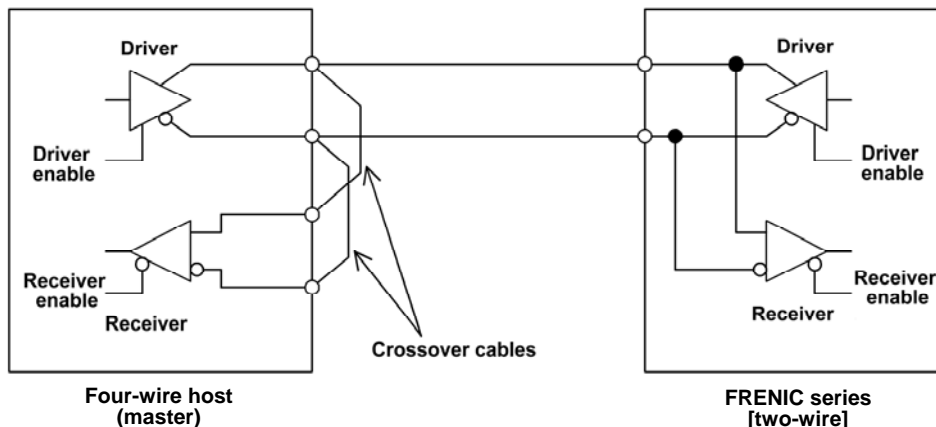

Figure 2.7 Connection with a four-wire host

- CAUTION**
- The driver circuit on the host side must have a function to set the driver output to high impedance (driver enable: OFF). Though products conforming to RS-485 normally has this function, check the specifications of the host.
 - Keep the output of the driver circuit on the host side in the status of high impedance except when the host is transmitting data (driver enable: OFF).
 - Keep the receiver circuit of the host device deactivated (receiver enable: OFF) while the host is transmitting data to prevent the host from receiving the data it transmitted. If the receiver cannot be deactivated, program the host so that the data transmitted by the host is discarded.

2.2.3 Devices for connection

This section describes the devices necessary for connecting a host not equipped with RS-485 interface, such as a personal computer, or for multidrop connection.

[1] Converter

In general, personal computers are not equipped with an RS-485 port. An RS-232C to RS-485 converter or USB to RS-485 converter is therefore required. Use a converter meeting the following recommended specifications for proper operation. Note that proper performance may not be expected from a converter other than the recommended one.

Specifications of the recommended converter

Transmission/receiving switching system: Automatic switching by monitoring transmission data on the personal computer side (RS-232C)

Isolation: The RS-232C side of the converter must be isolated from the RS-485 side.

Failsafe: Equipped with a failsafe function (*1)

Other requirements: The converter must have enough noise immunity for successful communications.

*1 The failsafe function means a function that keeps the RS-485 receiver's output at high logic level even when the RS-485 receiver's input is open or short-circuited or when all the RS-485 drivers are inactive.

Recommended converter

System Sacom Sales Corporation (Japan) : KS-485PTI (RS-232C to RS-485 converter)

: USB-485I RJ45-T4P (USB to RS-485 converter)

Transmission/receiving switching system

Since RS-485 communications adopts the half-duplex system (two-wire system), the converter must have a transmission/receiving switching function. The following two systems are available as the switching system.

(1) Automatic turnaround of the transceiver buffer

(2) Switching with the flow control signal (RTS or DTR) from the personal computer

In the case of FRENIC Loader, the operating system released before Microsoft Windows98 or an older version does not support the switching system described in (2) above. Use the converter described in (1).

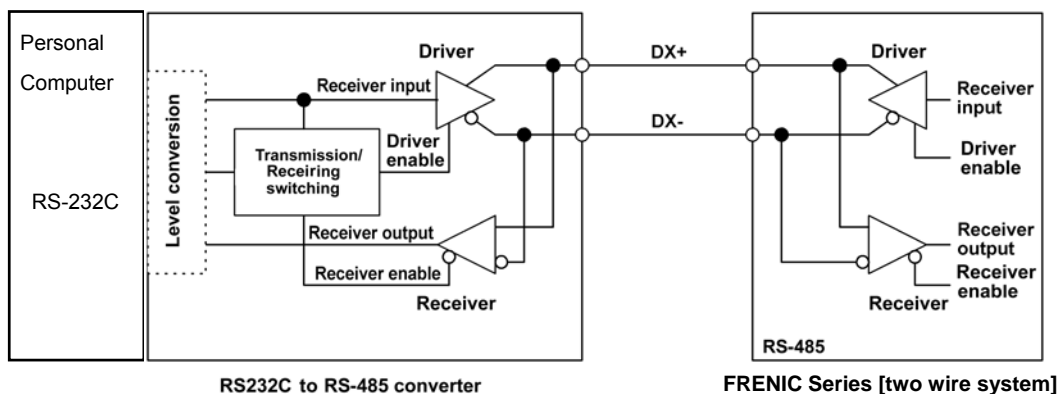

Figure 2.8 Communications level conversion

[2] Branch adapter for multidrop

When a slave unit has only 1 port of RJ-45 connector (modular jack), a branch adaptor is necessary for multidrop connection using standard LAN cables.

Recommended branch adapter

SK Kohki (Japan): MS8-BA-JJJ

2.2.4 Measures against noise

Depending on the operating environment, normal communications cannot be performed or instruments and converters on the host side may malfunction due to the noise generated by the inverter. This section describes measures to be taken against such problems. Consult Appendix A "Advantageous Use of Inverters (Notes on electrical noise)" in User's Manual of each inverter type.

[1] Measures for devices subjected to noise

Using an isolated converter

An isolated converter suppresses common mode noise that exceeds the specified operating voltage range of the receiver in case of long-distance wiring. However, since the isolated converter itself may malfunction, use a converter insusceptible to noise.

Using a category 5 compliant LAN cable

Category 5 compliant LAN cables are generally used for RS-485 communications wiring. To obtain an improved preventive effect on electromagnetically induced noise, use Category 5 conformed LAN cables with four twisted-pair-cores and apply one twisted pair, DX+ and DX-. To ensure a high preventive effect on electrostatically induced noise, use Category 5 conformed LAN cables with four shielded-and-twisted-pair-cores, and ground the shield at the master-side end.

Effect of twisted pair cables

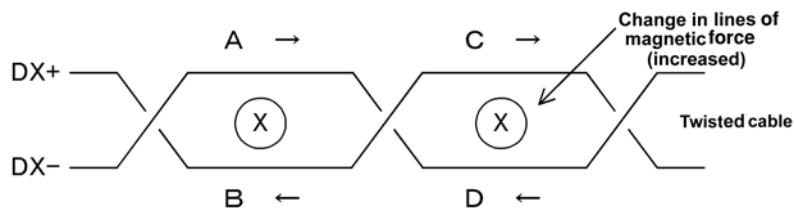

A uniform magnetic flux directing from the face to back of the paper exists, and if it increases, electromotive force in the direction of \rightarrow is generated. The electromotive forces of A to D are the same in intensity, and their directions are as shown in the above figure. In the cable DX+, the direction of electromotive forces B is reverse to that of electromotive force C, then the electromotive forces B and C offset each other, and so do electromotive forces A and D in the cable DX-. So, normal mode noise caused by electromagnetic induction does not occur. However, noise cannot be completely suppressed under such conditions as an uneven twist pitch. In the case of twisted cables, the normal mode noise is considerably reduced. But in the case of parallel cables, there may be a case where noises are not sufficiently reduced.

Shield effect

- 1) When the shield is not grounded, the shield functions as an antenna and receives noise.
- 2) When the shield is grounded at both ends, if the grounding points are separated from each other, the ground potential may be different between them, and the shield and the ground form a loop circuit in which a current flows and may cause noise. Additionally, the magnetic flux within the loop may vary and generate noise.
- 3) When the shield is grounded at either end, the effect of electrostatic induction can be completely eliminated within the shielded section.

Connecting terminating resistors

Insert a resistor equivalent to the characteristic impedance of the cables (100 to 120Ω) into both end terminals of the wiring (network) to prevent ringing due to the reflection of signals.

Separating the wiring

Separate the power lines (input L1/R, L2/S, and L3/T and output U, V, and W) from the RS-485 communications line, because induced noise can be prevented.

Separating the grounding

Do not ground instruments and the inverter together. Noise may conduct through the grounding wire. Use as a thick wire as possible for grounding.

Isolating the power supply

Noise may carry through the power supply line to instruments. It is recommended that the distribution system be separated or a power isolation transformer (TRAFY) or noise suppression transformer be used to isolate the power supply for such instruments from the power supply for the inverter.

Adding inductance

Insert a chalk coil in series in the signal circuit, or pass the signal wiring through a ferrite core, as shown in the figure below. This provides the wiring higher impedance against high-frequency noise, and suppresses the propagation of high-frequency noise.

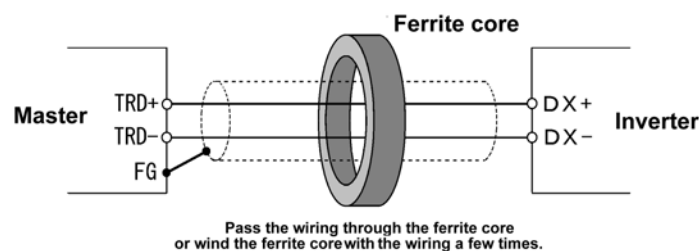

If an inductance is added, the signal waveform may become irregular and a transmission error may result during communications at a high baud rate. In this case, reduce the baud rate by changing the setting of function code y04.

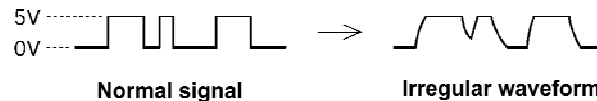
**[2] Measures against noise sources****Reducing carrier frequency**

By lowering data of function code F26 "motor sound (carrier frequency)," the noise level can be reduced. However, reducing the carrier frequency increases the motor sound.

Installing and wiring an inverter

Passing the power lines through metal conduit or adopting metal control panels can suppress radiation or induction noise.

Isolating the power supply

Using a power isolation transformer on the line side of the inverter can cut off the propagation (transmission) of noise.

[3] Additional measures to reduce the noise level

Consider using a zero-phase reactor or EMC compliance filter. The measures described in [1] and [2] above can generally prevent noise. However, if the noise does not decrease to the permissible level, consider additional measures to reduce the noise level. For details, see the User's Manual of each inverter model. (Chapter 6, 6.4.1 for FRENIC-Mini/Eco/Multi, and Chapter 4, 4.4.1 for FRENIC-MEGA)

2.3 Switching to Communications

2.3.1 Functions for the switching

Figure 2.9 below shows a block diagram via communications for frequency setting and operation commands.

This block diagram indicates only the base of the switching section, and some settings may be given higher priority than the blocks shown in this diagram or details may be different due to functional expansion and so on. For details, see the User's Manual of each inverter model. (Chapter 4 for FRENIC-Mini/Eco/Multi, and Chapter 6 for FRENIC-MEGA)

CAUTION Operation commands herein include digital input signals via communications.

According to the setting of function code H30 link function (operation selection), the command system when communications is valid is selected.

Even if digital input is set to link enable (LE), when the link becomes invalid ("LE" = OFF), the command system switches from communications to other settings including digital input signal. In short, the frequency setting, forward operation command, and X1 signal in Figure 2.9 switch from communications dedicated function codes S01, S05, and S06 to terminals [12], [FWD], and [X1], respectively.

Function code data can be read and written through communications regardless of the setting function code H30 (link function (operation selection)).

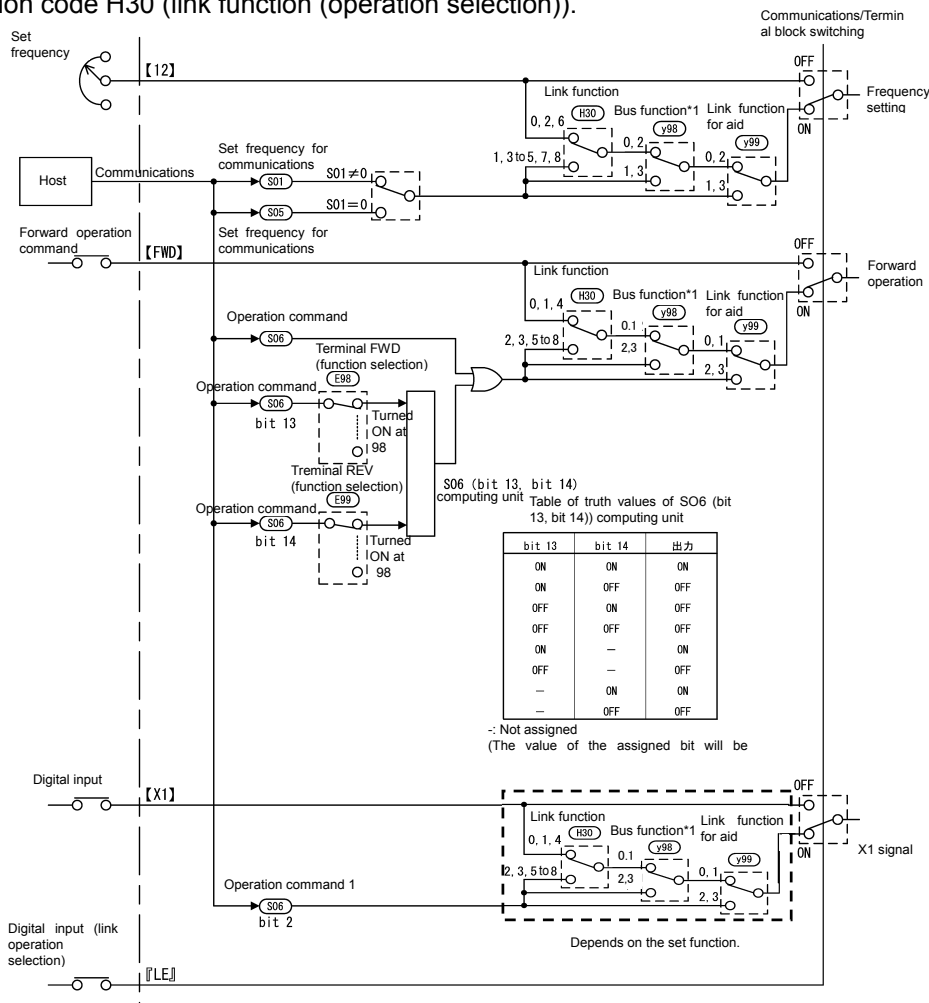

*1 The code y98 (bus function: operation selection) is not available in FRENIC-Mini.

Figure 2.9 Operation command block diagram via communications

2.3.2 Link functions (operation selection)

According to the setting of function code H30: Serial link (function select), the frequency setting and the operation command source (via-communications command or command selected by function codes F01/C30 and F02 when communications is valid can be selected.

Frequency setting done when the communications is valid and selection of operation source are influenced by the settings at y98, y99. For details, see Fig 2.9.

Table 2.4 Link function H30 (operation selection)

Data of link function H30	When communications are valid		Support			
	Frequency setting	Operation command	Mini	Eco	Multi	MEGA
0	Inverter itself	Inverter itself	○			
1	RS-485 communications (via standard RJ-45 or port 1)*1	Inverter itself				
2	Inverter itself	RS-485 communications (via standard RJ-45 or port 1)*1				
3	RS-485 communications (via standard RJ-45 or port 1)*1	RS-485 communications (via standard RJ-45 or port 1)*1				
4	RS-485 communications (via option or port 2)*2	Inverter itself		○	○	○
5	RS-485 communications (via option or port 2)*2	RS-485 communications (via standard RJ-45 or port 1)*1				
6	Inverter itself	RS-485 communications (via option or port 2)*2	×			
7	RS-485 communications (via standard RJ-45 or port 1)*1	RS-485 communications (via option or port 2)*2				
8	RS-485 communications (via option or port 2)*2	RS-485 communications (via option or port 2)*2				

*1 FRENIC-Mini requires RS-485 communications card (option).

*2 FRENIC-Eco/Multi requires RS-485 communications card (option). FRENIC-MEGA is equipped with RS-485 communications port 2 (terminal base) as standard equipment.

HINT By selecting continuous communications valid without setting any digital input terminal, and switching the data of H30 to communications valid/invalid (external signal input valid), communications valid/invalid can be switched in the same manner as switching at the digital input terminal. See the next section or later.

2.3.3 How to switch communications enabled/disabled

To issue a frequency setting or operation command through communications to control the inverter, select "Through RS-485 communications" by function code H30: link function (operation selection).

In addition, when switching control through communications with control from the terminal block (frequency setting from terminal [12], operation command from terminal [FWD] and so on) to switch remote operations with operations on the inverter body, assign "link operation selection" (data = 24: "LE") to the function code related to the digital input terminal (one of E01-E05: terminals [X1] to [X5], E98: terminal [FWD], or E99: terminal [REV]). (FRENIC-Mini does not support E04, E05, [X4], and [X5].) Control can be switched by the terminal to which "link operation selection" (data = 24: "LE") is assigned.

Communications automatically becomes valid when link operation selection is not assigned to any digital input terminal.

Table 2.5 Digital input terminal settings and communications statuses

Input terminal	Status
OFF	Communications invalid
ON (short-circuited to the terminal [CM])	Communications valid



- Via-communications command data and operation data must be rewritten from the host (controller) because the memory is initialized when the power is turned ON.
- Although command data and operation data can be written even if communications is invalid, they will not be validated because the switch is made invalid by link operation selection. If communications is made valid with no operation data written (operation command OFF, frequency setting = 0Hz) during operation, the running motor decelerates to a stop and may exert impact on the load depending on the set deceleration time. Operation can be switched without causing impact to the load by setting data in communications invalid mode in advance and then switching the mode to valid.
- If negative logic is set as Link enable (data 1024), the logical value corresponding to the ON/OFF status of the command "LE" will be reversed.
- FRENIC-Eco/Multi/MEGA has the field bus option other than RS-485 communications. The field bus option is handled prior to RS-485 communications depending on the setting of it in some cases. For details, see the function code "y98 Bus function (function selection)" of each inverter type.

2.3.4 Link functions for supporting data input (operation select)

According to the setting of function code y99: link function for supporting data input (operation select), the frequency setting and the operation command source (via-communications command or command specified by function code H30 and y98) when communications is valid can be selected individually.



- This function code is designed for inverter support software such as for FRENIC Loader, and forcibly makes communications valid without changing the setting of H30. Do not change the current setting unless otherwise required.
- FRENIC-Mini operates in the same way as y99 is set to 0 even if y99 is set 1, 2, or 3 when this function code is changed from the keypad. When setting a value other than 0, the value of y99 must be written through communications.
- The data of this function code cannot be saved in the inverter and will return to 0 when the power supply is turned off.

Table 2.6 Link functions for supporting data input

Link function y99	When communications is valid	
	Frequency setting	Operation command
0	Frequency setting specified by H30 and y98	Operation command specified by H30 and y98
1	Communications valid (S01, S05)	
2	Frequency setting specified by H30 and y98	Communications valid (S06)
3	Communications valid (S01, S05)	

2.4 Making RS-485-related Settings

2.4.1 Link function (RS-485 setting)

Use function codes (y01 to y10 and y11 to y20) to make settings for RS-485 communications functions. Use the codes y01 to 10 for port 1 and the codes y11 to 20 for port 2.

Station address (y01, y11)

Set a station address for RS-485 communications. The setting range depends on the protocol.

Table 2.7 RS-485 setting (station addresses)

Protocol	Range	Broadcast
Modbus RTU protocol	1 to 247	0
Protocol for loader commands	1 to 255	–
Fuji general-purpose inverter protocol	1 to 31	99



- No response is expected if an address number out of the specified range is set.
- Match the station address with that of the personal computer when FRENIC Loader is connected.

Operation made selection when an error occurs (y02, y12)

Set the operation performed when an RS-485 communications error occurs.

RS-485 communications errors are logical errors such as an address error, parity error, or framing error, transmission error, and communications disconnection error set by y08 and y18. In any case, error is detected only while the inverter is running in the link operation made for both the operation command and frequency setting. If neither the operation command nor frequency setting is sent through RS-485 communications or the inverter is not running, error is ignored.

Table 2.8 RS-485 setting (operations when an error has occurred)

y02, y12 data	Function
0	Indicates an RS-485 communications error (E_{r1} for port 1 and E_{r2} for port 2), and stops operation immediately (alarm stop).
1	Runs during the time set on the error processing timer (y03, y13), and then displays an RS-485 communications error (E_{r1} for port 1 and E_{r2} for port 2) and stops operation (alarm stop).
2	Runs during the time set on the error processing timer (y03, y13). If communications are recovered, continues operation. Otherwise, displays an RS-485 communications error (E_{r1} for port 1 and E_{r2} for port 2) and stops operation (alarm stop).
3	Continues operation even after a communications error has occurred.

Timer for y02 and y12 (y03, y13)

Set a timer for error detection.

It is judged as an error that the response to a request is not received within time set because of no response of the other end and so on. See the section of "Communications disconnection detection time (y08, y18)."

- Data input range: 0.0 to 60.0 (s)

Baud rate (y04, y14)

Set a baud rate.

- Setting when FRENIC Loader is connected
Match the baud rate with that of the personal computer.

Table 2.9 Baud rate

Data	Baud rate
0	2400 bps
1	4800 bps
2	9600 bps
3	19200 bps
4	38400 bps (FRENIC-Mini does not support it.)

Data length (y05, y15)

Set a character length.

- Setting when FRENIC Loader is connected
This code does not need to be set because it is automatically set to eight bits (as in the Modbus RTU protocol).

Table 2.10 Data length

Data	Function
0	8 bits
1	7 bits

Parity check (y06, y16)

Set a parity bit.

- Setting when FRENIC Loader is connected
This code does not need to be set because it is automatically set to even parity.

Table 2.11 Parity check

Data	Function	RTU Stop bits (auto setting)
0	No parity bit	2 bits
1	Even parity	1 bit
2	Odd parity	1 bit
3	No parity bit (Not supported for FRENIC-Mini/Eco) For the detailed method of use, see "Chapter 3 Modbus RTU PROTOCOL"	1 bit

Stop bits (y07, y17)

Set a stop bit.

- Setting when FRENIC Loader is connected
This code does not need to be set because it is automatically set to 1.
- In the Modbus RTU protocol, this code does not need to be set because it is automatically determined in conjunction with the parity bit.

Table 2.12 Stop bits

Data	Function
0	2 bits
1	1 bit

No response error detection time (y08, y18)

In a system designed to be sure to access a station (inverter) managed by a host within a specific period of time, access may be lost during RS-485 communications due to wire disconnections. In such a case, the inverter starts the operation of communications error set up by y02 and y12 if the inverter detects the symptom and access is still lost even after the communications disconnection detection time has passed.

Table 2.13 No response error detection time

Data	Function
0	No response error detection disabled
1 to 60	Detecting time from 1 to 60 seconds

Response interval (y09, y19)

Set the time from the completion of receipt of a request from the host, to the return of response to it. Even in a slow processing device, timing can be adjusted by changing the response interval time.

- Data setting range: 0.00 to 1.00 (second)

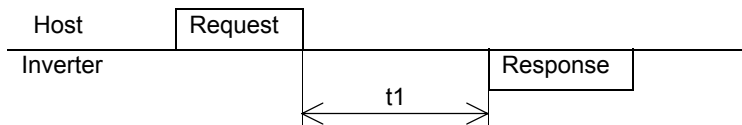

$t1 = \text{Response interval time} + \alpha$

- α : The processing time within the inverter. It depends on the timing and command given. For further information, see the procedure for each protocol on the host below:
 Modbus RTU protocol → Chapter 3 "3.2 Host Side Procedures"
 Fuji general-purpose inverter protocol → Chapter "4.2 Host Side Procedures"

- Setting when FRENIC Loader is connected
 Set the response interval time according to the performance and conditions of the personal computer and converter (RS-232C TO RS-485 converter, etc.).
 (Some converters monitor the communications status and use a timer to switch transmission/receiving.)

Protocol select (y10, y20)

Select a communications protocol.

- Setting when FRENIC Loader is connected
 Select the protocol for FRENIC Loader commands (y10 = 1).

Table 2.14 Protocol select

Data	Protocol
0	Modbus RTU
1	FRENIC Loader (supported by y10 only)
2	Fuji general-purpose inverter
3*1	N2 Protocol

*1 Applicable only with FRN□□F1□-□A, FRN□□F1□-□C, FRN□□F1□-□E and FRN□□F1□-□U

2.5 Selecting the Method of Storing Communications Data

Selecting the method of storing communications data (y97: Applicable only to the FRENIC-MEGA)

The times of data writing onto the inverter memory are limited (100 thousand to 1 million times). If the data is overwritten too many times, data change or storage may be disabled. If you frequently rewrite the data obtained via communications, the data can be temporarily stored without being written in the memory. Doing so prevents increase of data rewriting times and memory failure.

As a means of storing temporarily stored data onto the memory, the inverter is provided with the function for transferring the temporarily stored data to a nonvolatile memory (by the ALL SAVE command).

To change the data of function code y97, perform the double-key operation; (STOP) key + (▲) / (▼) key.

y97 data	Functions
0	Data is stored in the nonvolatile memory (with the limit in the number of data writing times).
1	Data is stored in the temporary memory (without the limit in the number of data writing times.)
2	Data is transferred from the temporary memory to the nonvolatile memory. (After execution of ALL SAVE command, data storage method returns to the state where data 1 is set at y97.



CHAPTER 3

Modbus RTU PROTOCOL

This chapter describes the Modbus RTU protocol, as well as the host side procedure for using this protocol and error processing.

The Modbus RTU protocol was a set of specifications developed in the United States. For the FRENIC-Mini of which inverter ROM version is 0399 or earlier, the Modbus RTU functions are partially restricted. Contact us about details of restrictions. Check the inverter ROM version with menu "5_ /4" described in "3.8 Reading Maintenance Information" under Chapter 3 of the FRENIC-Mini Instruction Manual (INR-SI47-0791-E).

In addition, for FRENIC-Eco/Multi/MEGA, coil support (coil reading out, coil reading in, and serial coil writing) is added to the protocol of Modbus RTU.

Table of Contents

3.1	Messages	3-1
3.1.1	Message formats	3-1
3.1.2	Message types.....	3-1
3.1.3	Message frames	3-2
3.1.4	Message categories.....	3-4
3.1.5	Communications examples.....	3-11
3.2	Host Side Procedures	3-12
3.2.1	Inverter's response time	3-12
3.2.2	Timeout processing.....	3-13
3.2.3	Receiving preparation complete time and message timing from the host.....	3-14
3.2.4	Frame synchronization method	3-14
3.3	Communications Errors.....	3-15
3.3.1	Categories of communications errors.....	3-15
3.3.2	Operations in case of errors	3-16
3.4	CRC-16.....	3-19
3.4.1	Overview of the CRC-16.....	3-19
3.4.2	Algorithm.....	3-19
3.4.3	Calculation example	3-21
3.4.4	Frame length calculation.....	3-22

3.1 Messages

3.1.1 Message formats

The regular formats for transmitting RTU messages are shown below:

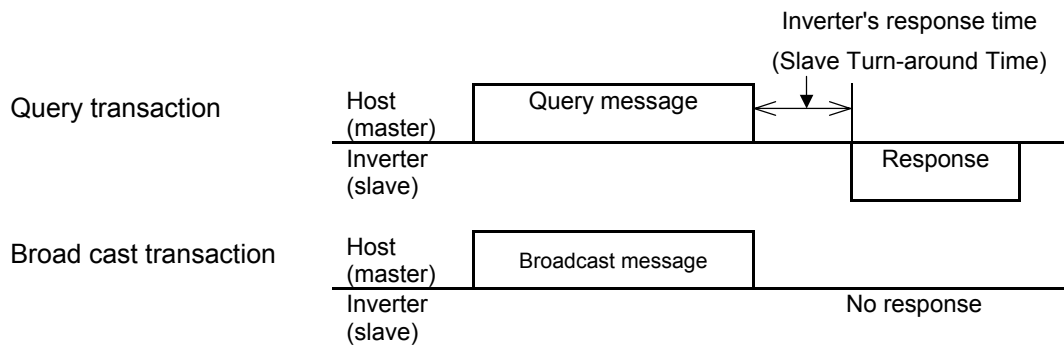

If the inverter receives from the host a message in the standby status and considers it properly received, it executes a transaction in response to the request and sends back normal response. If the inverter judges that the message has not been received properly, it returns error response. The inverter does not send back any response in the case of broadcast transactions.

3.1.2 Message types

Message types are classified into four types; query, normal response, error response, and broadcast.

Query

The host sends messages to an inverter.

Normal response

After the inverter received a query from the host, the inverter executes a transaction in response to the request, and sends back corresponding normal response.

Error response

If the inverter receives a query but cannot execute the requested function because an invalid function code is specified or for other reasons, it sends back error response.

The error response is accompanied by a message describing the reason the request cannot be executed.

The inverter cannot send back any response in case of a CRC or physical transmission error (parity error, framing error, overrun error).

Broadcast

The host uses address 0 to send messages to all slaves. All slaves, which receive a broadcast message, execute the requested function. This transaction will be terminated upon timeout of the host.

In the broadcast communications, only S01, S05, S06, S13, S14, or S19 can be selected from the standard frame.

3.1.3 Message frames

As shown below, a transmission frame consists of four blocks, which are called fields. Details depend on FC (RTU function codes). To make a clear distinction between RTU function codes and the inverter's function codes, the former will be hereinafter referred to as 'FC'.

1 byte	1 byte	Up to 105 bytes*1	2 bytes
Station address	FC (RTU function code)	Information	Error check

*1 Max 205 bytes for FRENIC-MEGA

Station address

The station address field is one byte long, in which a station address between 0 and 247 can be selected.

Selecting address 0 means the selection of all slave stations and a broadcast message.

'FC' (RTU function code)

The 'FC' field is one byte long, in which a function code is defined with a number from 0 to 255. The 'FCs' in the shaded rows are available. Do not use any unavailable (unused) 'FC'. Failure to observe this rule results in error response.

Table 3-1 List of 'FC'

'FC'	Description	Support			
		Mini	Eco	Multi	MEGA
0	Unused	-	-	-	-
1	Read Coil Status (80 coils maximum)	×	○	○	○
2	Unused	-	-	-	-
3	Read Holding Registers (50 registers maximum)	○	○	○	○
4	Unused	-	-	-	-
5	Force Single Coil	×	○	○	○
6	Preset Single Register	○	○	○	○
7	Unused	-	-	-	-
8	Diagnostics	○	○	○	○
9 to 14	Unused	-	-	-	-
15	Force Multiple Coils (16 coils maximum)	×	○	○	○
16	Preset Multiple Registers (50 registers maximum*1)	○	○	○	○
17 to 127	Unused	-	-	-	-
128 to 255	Reserved for exception response	-	-	-	-

*1 Max 100 data for FRENIC-MEGA

Information

The information field contains all information (function code, byte count, number of data, data, etc.). For further information about the information field for each message type (broadcast, query, normal response, error response), see "3.1.4 Message categories."

Error check

The error check field is a CRC-16 check system and two bytes long. Since the length of the information field is variable, the frame length required for calculating the CRC-16 code is calculated based on the 'FC' and the byte count data.

For further information about CRC-16 calculations and algorithm, see "3.4 CRC-16."

For byte counts, see "3.1.4 Message categories."

Character format

Each byte of a message is transmitted as a character. Character formats are described on the following page.

A character comprises a start bit (logical value 0), 8-bit data, an additional (optional) parity bit, and a stop bit (logical value 1).

A character always consists of eleven bits, and the number of stop bits varies depending on whether parity exists.

Without parity

LSB								MSB		
0	1	2	3	4	5	6	7	8	9	10
Start	Data							Stop		

With parity

LSB								MSB		
0	1	2	3	4	5	6	7	8	9	10
Start	Data							Parity (optional)	Stop	



- Modbus RTU protocol has the above character format as specified by the rule. But, some devices use the format "No parity + Stop bit: 1 bit." For connection with these devices, FRENIC- Multi/MEGA support the parity bit selection: y06, y16=3. When y06, y16=3 are selected, the protocol is given the following character format.

LSB								MSB	
0	1	2	3	4	5	6	7	8	9
Start	Data							Stop	

3.1.4 Message categories

There are eight RTU message categories; read holding registers, preset single register, preset multiple registers, diagnostics, read coil status, force single coil, force multiple coils and error response.

Each category is described below:

[1] Read holding registers

Query

1 byte	1 byte	2 bytes		2 bytes		2 bytes	
Station address	03 _H	Function code		Number of read data		Error check	
		Hi	Lo	Hi	Lo		

Normal response

1 byte	1 byte	1 byte	2 to 100 bytes*1		2 bytes	
Station address	03 _H	Byte count	Read data		Error check	

Hi, Lo (data 0); Hi, Lo (data 1);

*1 From 2 to 200 bytes for FRENIC-MEGA

How to set a query

- This request is not available for broadcast transactions. Station address 0 will become invalid (no response).
- 'FC' = 3 (03_H)
- The function code is two bytes long. The Hi byte indicates the function code group (see Table 3.2), and the Lo byte represents a function code identification number (0 to 99).

(Example) When the function code is E15, the Hi byte is 01_H and the Lo byte is 0F_H.

Table 3.2 Function code group/code conversion table

Group	Code		Name	Group	Code		Name
F	0	00 _H	Fundamental function	o	6	06 _H	Operational function
E	1	01 _H	Extension terminal function	M	8	08 _H	Monitor data
C	2	02 _H	Control function of frequency	J	13	0D _H	Application function 1
P	3	03 _H	Motor1 parameter				
H	4	04 _H	High performance function	d	19	13 _H	Application function 2
A	5	05 _H	Motor2 parameter	y	14	0E _H	Link function
b	18	12 _H	Motor3 parameter	W	15	0F _H	Monitor 2
r	10	0A _H	Motor4 parameter	X	16	10 _H	Alarm 1
S	7	07 _H	Command/ Function data	Z	17	11 _H	Alarm 2

- The length of the read data is up to 50 words (2 byte each) (100 words for FRENIC-MEGA).
- If the read data contains an unused function code, 0 will be read, which will not result in an error.
- Data does not extend over two or more function code groups. If, for example, reading of 40 words is specified from F40 but only function codes up to F40 are available, the data of F40 will be set at the first word, and the other 49 words will be 0.

Interpretation of normal response

- The data range of byte counts is between 2 and 100 (from 2 to 100 for FRENIC-MEGA). A byte count is double the number of read data (1 - 50 data) of the response (1 to 100 data for FRENIC-MEGA).
- The read data contains each word data in order of Hi byte and Lo byte, and each word data is sent back in order of the data of the function code (address) requested by the query, the data of that address number plus 1, the data of that number address number plus 2 ... If two or more function data are read and the second or any of the following data contains an unused function code (F19, etc.), the read data will become 0.

[2] Preset single register**Query**

1 byte	1 byte	2 bytes	2 bytes	2 bytes
Station address	06 _H	Function code	Write data	Error check
		Hi Lo	Hi Lo	

Normal response

1 byte	1 byte	2 bytes	2 bytes	2 bytes
Station address	06 _H	Function code	Write data	Error check

How to set a query

- When address 0 is selected, broadcast is available. In this case, all inverters do not respond even if a broadcast request is executed.
- 'FC' = 6 (06_H)
- The function code is two bytes long. The Hi byte indicates the function code group (see Table 3.2), and the Lo byte represents a function code identification number (0 to 99).
- The written data field is fixed two bytes long. Set the data on the function code to be written.

Interpretation of normal response

The frame is the same as the query.

[3] Preset multiple registers**Query**

1 byte	1 byte	2 bytes	2 bytes	1 byte	2 to 100 bytes*1	2 bytes
Station address	10 _H	Function code	Number of write data	Byte count	Write data	Error check
		Hi Lo	Hi Lo		Hi, Lo; Hi, Lo...	

*1 From 2 to 200 bytes for FRENIC-MEGA

Normal response

1 byte	1 byte	2 bytes	2 bytes	2 bytes
Station address	10 _H	Function code	Number of write data	Error check

How to set a query

- When the station address 0 is selected, broadcast is available. In this case, all inverters do not respond even if a broadcast request is executed.
- 'FC' = 16 (10_H)
- The function code is two bytes long. The Hi byte indicates the function code group (see Table 3.2), and the Lo byte represents a function code identification number (0 to 99).
- The number of write data is two bytes long, and the setting range is from 1 to 50 (from 1 to 100 for FRENIC-MEGA). If 51 or a higher value (101 or a higher value for FRENIC-MEGA) is set, error response will result.
- The byte count field is one byte long, and the setting range is from 2 to 100 (from 2 to 200 for FRENIC-MEGA). Set a value equivalent to the double of the number of write data.
- Set the lowest order code (the data on the function code requested by the query) at the first two bytes of the write data, and the higher order data (address plus 1, address plus 2 ...) at the following bytes.
- If the write data contains an unused function code, the writing will be ignored, which will not result in an error.

Interpretation of normal response

- With regard to the function code and the number of write data, the same values as those of the query will be sent back.

[4] Diagnostics

Query

1 byte	1 byte	2 bytes	2 bytes	2 bytes
Station address	08 _H	Sub function code 0000 _H	Write data	Error check
		Hi Lo	Hi Lo	

Normal response

1 byte	1 byte	2 bytes	2 bytes	2 bytes
Station address	08 _H	Sub function code 0000 _H	Write data	Error check

How to set a query

- This request cannot use broadcast. Station address 0 will become invalid (no response).
- 'FC' = 8 (08_H)
- Set the sub function code field to be 2 bytes long fixed 0000_H. Error response will result if data other than 0000_H is set.
- The write data field is two bytes long, and any contents of data can be set.

Interpretation of normal response

- The frame is the same as the query.

[5] Read coil status (not supported by FRENIC-Mini)

Query

1 byte	1 byte	2 bytes	2 bytes	2 bytes
Station address	01 _H	Coil address	No. of coils	Error check
		Hi Lo	Hi Lo	

Normal response

1 byte	1 byte	1 byte	1 to 10 bytes	2 bytes
Station address	01 _H	Byte count	Read data	Error check

How to set a query

- Broadcast with station address 0 is not usable. If this address is used, no response is returned.
- 'FC'=1 (01_H)
- Read out a coil (bit data) by specifying the top address of the coil to be read out and the number of points read out (number of coils).
- For the assignment of a coil (bit data), see table 3.3. For each content, refer to the S and M codes in the remarks column.

Table 3.3 Description of coil (bit data)

Coil number	+7	+6	+5	+4	+3	+2	+1	+0	Remarks
1	X6	X5	X4	X3	X2	X1	REV	FWD	S06: Run operation command (Read/Write)
9	RST	XR	XF	-	-	X9	X8	X7	
17	VL	TL	NUV	BRK	INT	EXT	REV	FWD	M14: Run status (Read only)
25	BUSY	WR		RL	ALM	DEC	ACC	IL	
33	FAN	KP	OL	IPF	SWM2	RDY	FDT	FAR	M70: Run status 2 (Read only)
41	-	-	IDL	ID	OPL	LIFE	OH	TRY	
49	X6	X5	X4	X3	X2	X1	REV	FWD	M13: Run operation command (final command) (Read only)
57	RST	XR	XF	-	-	X9	X8	X7	
65	-	-	-	Y5	Y4	Y3	Y2	Y1	M15: General-purpose output terminal information (Read only)
73	-	-	-	-	-	-	-	30	

- The "-" symbols in the table mean that the bit is reserved and always zero.
- Coil addresses are 0 to 79, calculated by subtracting one from coil numbers. If a coil address is 80 or more, an error occurs because of an incorrect address.
- The number of coils is 1 to 80. If the number of coils exceeds the range, an error occurs because of an incorrect address.
- No error occurs even if the sum of the numbers of coil addresses and coils exceeds the coil range.

Interpretation of normal response

- Data are stored from the LSB (the rightmost bit in the table above) in ascending order of coil number. When a coil is turned on, the data becomes one, and all the remaining bits are changed to zero.
- The byte length of the read data is filled in the byte count field.
- For a data example, see table 3.4.

Table 3.4 Example of coil address = 13 and the number of coils = 9

	Bit 7	Bit 6	Bit 5	Bit 4	Bit 3	Bit 2	Bit 1	Bit 0
Data's 1st byte	BRK	INT	EXT	REV	FWD	RST	XR	XF
Data's 2nd byte	0	0	0	0	0	0	0	NUV

[6] Force single coil (not supported by FRENIC-Mini)

Query

1 byte	1 byte	2 bytes	2 bytes	2 bytes
Station address	05 _H	Coil address	Data	Error check
		Hi Lo	Hi Lo	

Normal response

1 byte	1 byte	2 bytes	2 bytes	2 bytes
Station address	05 _H	Coil address	Data	Error check

How to set a query

- Broadcast with station address 0 is not usable. If used, no response is returned.
- 'FC' = 5 (05_H)
- Turn on/off a coil (bit data) by specifying only a bit.
- For the assignment of a coil (bit data), see table 3.5. For each content, refer to the S and M codes in the remarks column.

Table 3.5 Description of coil (bit data)

Coil number	+7	+6	+5	+4	+3	+2	+1	+0	Remarks
1	X6	X5	X4	X3	X2	X1	REV	FWD	S06: Run operation command (Read/Write)
9	RST	XR	XF	-	-	X9	X8	X7	

- The "-" symbol in the table means that the bit is reserved, and writing is ignored.
- The coil address is 0 to 15, calculated by subtracting one from the coil number. If a coil address is 16 or more, an error occurs because of an incorrect address.
- When a coil is turned off, data are 0000_H. When a coil is turned on, data are FF00_H.

Interpretation of normal response

- The format of normal response is the same as that of inquiry.
- No response is returned to the broadcast command.

[7] Force multiple coils (not supported by FRENIC-Mini)

Query

1 byte	1 byte	2 bytes	2 bytes	1 byte	1 to 2 bytes	2 bytes
Station address	0F _H	Coil address	No. of coils	Byte account	Write data	Error check
		Hi Lo	Hi Lo		Hi Lo	

Normal response

1 byte	1 byte	2 bytes	2 bytes	2 bytes
Station address	0F _H	Coil address	No. of coils	Error check
		Hi Lo	Hi Lo	

How to set a query

- Broadcast with station address 0 is not usable. If is used, no response is returned.
- 'FC' = 15 (0F_H)
- Write a coil (bit data) by specifying the top address of the coil to be written, the number of points written (number of coils), and data to be written.
- For the assignment of a coil (bit data), see table 3.6. For each content, refer to the S and M codes in the remarks column.

Table 3.6 Description of coil (bit data)

Coil number	+7	+6	+5	+4	+3	+2	+1	+0	Remarks
1	X6	X5	X4	X3	X2	X1	REV	FWD	S06: Run operation command (Read/Write)
9	RST	XR	XF	-	-	X9	X8	X7	

- The "-" symbol in the table means that the bit is reserved and always zero.
- The coil address is 0 to 15, calculated by subtracting one from the coil number. If a coil address is 16 or more, an error occurs because of an incorrect address.
- If the byte count is 0 or 3 or more, an error occurs because of an incorrect data.
- The number of coils is 1 to 16. If 0 or 17 or more, an error occurs because of an incorrect address.
- No error occurs even if the coil address plus number of coils exceeds the coil range.
- If the number of coils is 9 or more and the byte count is 1 or less, an error occurs because of an incorrect data.
- If the number of coils is 8 or less and the byte count is 2, no error occurs.
- Data are stored from the LSB (the rightmost bit in the table above) in ascending order of coil number. When a coil is turned on, the data becomes one. When a coil is turned off, the data becomes zero. All the remaining bits are ignored.
- The byte count field indicates the byte length of the write data.
- For a data example, see table 3.7.

Table 3.7 Example of coil address = 2 and the number of coils = 9

	Bit 7	Bit 6	Bit 5	Bit 4	Bit 3	Bit 2	Bit 1	Bit 0
Data's 1st byte	X8	X7	X6	X5	X4	X3	X2	X1
Data's 2nd byte	0	0	0	0	0	0	0	X9

Interpretation of normal response

- The forms of coil address and number of coils are the same as the forms of query.
- No response is returned to the broadcast command.

[8] Error response

If the inverter receives an improper query, it will not execute it, which will result in error response.

Error response

1 byte	1 byte	1 byte	2 bytes
Station address	Exception function	Subcode	Error check

Interpretation of error response

- The station address is the same as that of the query.
- The exception function is a value obtained by adding 80_H to the 'FC' of the query message (or the value of the 'FC' if the 'FC' is larger than 80_H).
For example, when the 'FC' is 3, the exception function is 3 + 128 = 131 (83_H).
- The subcode represents the code of the reason for the improper query.

Table 3.8 Subcodes

Subcode	Item		Description	Order of priority
1	Improper 'FC'		The inverter received an unsupported FC. (See table 3.1.)	1
2	Improper address	Improper function code	An unused function code or a function code out of range was received. When the read/write data (except the first one) containing an unused function code. - During function reading Zero (0) will be read, which will not result in an error. - During continuous function writing The writing will be ignored, which will not result in an error.	2
		Improper number of data	- When the number of read/write data is not between 1 and 50. (from 1 to 100 for FRENIC-MEGA) - No error will result when the value of the function code plus the number of data is beyond the setting range of the function code.	
		Diagnostic code error (maintenance code)	A value other than 0 was received although the subfunction code as the diagnostics was fixed to 0.	
3	Improper data	Data range error	The write data is beyond the permissible write range.	3*1
7	NAK	No right of writing	No right of writing by H30/y98/y99 FRENIC-Mini: This error does not occur.	
		Write disable	- Writing was attempted to the functions to which writing from RTU is prohibited or to which writing is disabled during operation. - Writing was attempted to a function code (other than S01, S05, S06, S13, and S14) that could not be written when the voltage was insufficient.	

*1 The priority between sub code 3 and 7 depending on a cause of sub code 7.

- If response is sent back to an improper query, a subcode will be set in an error code (that can be referred to with M26).

3.1.5 Communications examples

Typical communications examples are shown below (the station address is 5 in all cases).

(Example 1) M06: Reading actual frequency and speed

Query (host ⇒ inverter)

05	03	08	06	00	01	67	EF
----	----	----	----	----	----	----	----

Normal response (inverter ⇒ host)

05	03	02	27	10	A3	B8
----	----	----	----	----	----	----

The detected speed value is 2710_H, or 10000_d. The actual frequency is 30 Hz according to the expression shown below:

$$10000 \times \frac{\text{Maximum frequency}}{20000} = 30 \text{ (Hz)} \quad (\text{Maximum frequency: 60 Hz})$$

(Example 2) S01: The value of 15Hz will be written to frequency command (maximum frequency: 60 Hz).

According to the expression shown below, the value to be written is 1388_H.

$$15\text{Hz} \times \frac{20000}{60 \text{ (Hz)}} = 5000_{\text{d}} = 1388_{\text{H}}$$

Query (host ⇒ inverter)

05	06	07	01	13	88	D5	AC
----	----	----	----	----	----	----	----

Normal response (inverter ⇒ host)

05	06	07	01	13	88	D5	AC
----	----	----	----	----	----	----	----

3.2 Host Side Procedures

3.2.1 Inverter's response time

Upon receipt of a query from the host, the inverter executes the queried transaction and sends back response after the response time shown below:

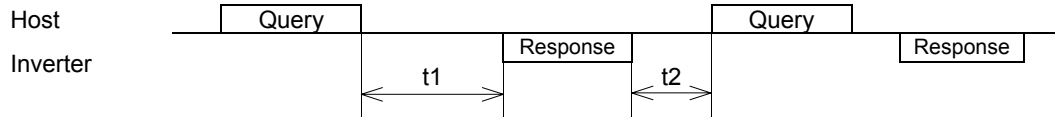

t1: Response interval time

The response interval time is the longest time out of the time setting by a function code(1), 3-character time(2), or inverter's processing time(3).

- (1) y09/y19: setting of response interval time
0.00-1.00(s), factory shipment setting: 0.01(s)

You can set the time from receiving a request issued from a host to starting to send a response. By setting a response interval time, even the host side which is slower than the inverter can meet timing.

- (2) 3-character time (maximum value)

Table 3.9 3-character time (maximum time)

Baud rate (bps)	2400	4800	9600	19200	38400 (Not supported by FRENIC-Mini)
3-character time (ms)	15	10	5	5	5

- (3) Inverter processing time (The data volume shown below indicates the number of words.)

1) Read holding registers, read coil status, multiple read holding registers

Table 3.10 Inverter processing time

Data count	Inverter processing time (minimum to maximum)
1 to 7	5 to 10 (ms)
8 to 16	10 to 15 (ms)
n	$\text{Int}((n-1)/8) \times 5$ to $\text{int}((n-1)/8) \times 5 + 5$ (ms)

2) Preset single register, preset multiple registers, force single coil, and force multiple coils

Table 3.11 Inverter processing time

Data count	Inverter processing time (minimum to maximum)
1	25 to 30 (ms)
2	45 to 50 (ms)
3	65 to 70 (ms)
4	85 to 90 (ms)
n	$n \times 20 + 5$ to $n \times 20 + 10$ (ms)

If the data is written in H03=1, the inverter processing time is a maximum of 5 seconds. If the data is written in H03=2(*1) or in P02(*1), the processing time is a maximum of 500 (ms). (*1) For FRENIC-Multi, write in such a way that H03=2, 3 and P02, A16. For FRENIC-MEGA, write in such a way that H03=2, 3, 4, 5 and P02, A16, b16, r16.

3) Maintenance code: 10 (ms)

t2: Receiving preparation time

See section 3.2.3 "Receiving preparation complete time and message timing from the host."

3.2.2 Timeout processing

To read/write data from/to the host, transmit the next frame after confirming response. If response is not transmitted from the inverter for more than a specified period of time (timeout time), it is a timeout, and perform a retry. (If a retry begins before a timeout time elapses, the requested frame cannot be received properly.)

The timeout time must be set longer than the response time of the inverter. In case of a timeout, retransmit the same frame or read details of the error (M26) to confirm whether the inverter sends back normal response. If normal response is returned, this indicates that some transient transmission error occurred due to noise or for other reasons, and subsequent communications is normal. (However, if this phenomenon frequently occurs even when normal response is sent back, some problem may exist. Perform a close investigation.) In case of no response, perform another retry. If the number of retries exceeds the set value (generally about three times), there may be a problem with the hardware and the software of the host. Investigate and correct the cause.

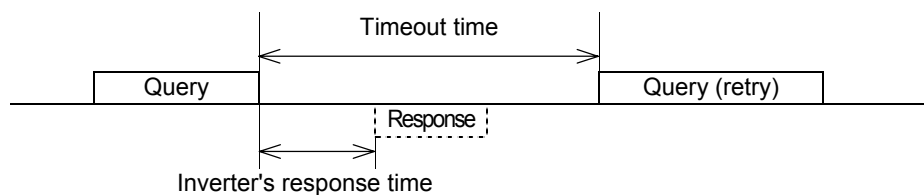

3.2.3 Receiving preparation complete time and message timing from the host

The time from the return of response by the inverter until the completion of receiving preparation of the communications port (switching from transmission to receiving) is called a receiving preparation complete time.

Transmit the following messages after the receiving preparation complete time:

Receiving preparation complete time: 3-character time

In the case of broadcast

Upon receipt of a query message from the host by broadcast, the inverter executes the query and enters the receiving enabled status.

When sending a message from the host after broadcast is performed, send the message after the inverter processing time shown in section 3.2.1 "Inverter response time" has passed.

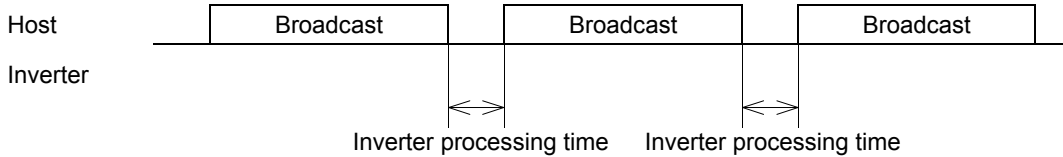

3.2.4 Frame synchronization method

Since the RTU transmits and receives binary data without using header characters for frame synchronization, a frame synchronization system is defined as a time without data to identify the head of the frame.

If data communications does not occur for a period equal to three characters (33 bits including the start and stop bits) at the current transmission speed during receiving standby, initialize the frame information, and consider the first received data the first byte of the frame. If a character interval reaches the length of three characters or more while a frame is received, the frame is discarded.

For this reason, the host must transmit data at a time interval of three or less characters between two characters.

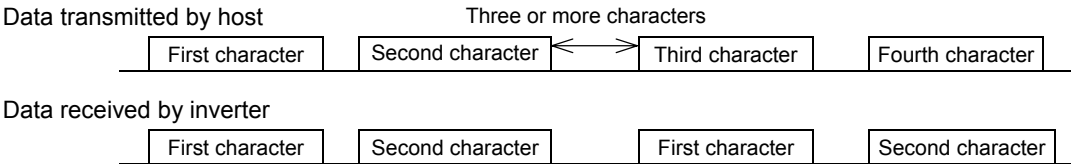

With regard to data to another station, messages from the host and response from that station will be received. In response transmission to identify the head of the frame, a waiting time of three characters (33 bits including the start and stop bits) is required between the completion of data receipt by the station and the start of transmission.

Any devices multidropped also requires such a waiting time.

3.3 Communications Errors

3.3.1 Categories of communications errors

The communications-related errors the inverter detects are listed below:

Table 3.12 Communications errors detected by inverter

Error category	Error name	Description	Error code (M26 or M67)
Logical error	Improper 'FC'	See "Table 3.8 Subcodes" shown in 3.1.4 [8].	1(01 _H)
	Improper address		2(02 _H)
	Improper data		3(03 _H)
	NAK		7(07 _H)
Transmission error	CRC error	The frame to the local station is found unmatched in CRC collation.	71(47 _H)
	Parity error	The parity is unmatched.	72(48 _H)
	Other errors	Receiving errors other than the abovementioned (framing error, overrun error)	73(49 _H)
Communications disconnection error	Communications disconnection error	The inverter did not receive a normal frame addressed to local or to other stations within the communications disconnection time set with the function code.	—

Logical error (error codes 1 to 7)

When a logical error is detected, an error response frame reports it. For further information, see "3.1.4 [8] Error response."

Transmission error (error codes 71 to 73)

When a transmission error occurs eight straight times, it is handled as a communications error. However, the inverter does not return response in order to avoid overlapping of response from multiple inverters. The count of eight straight times will be cleared upon normal receipt of a frame to another station or to the local inverter (station) itself.

Communications disconnection error

If the inverter in operation does not receive a normal frame to itself or to other stations when it has received a normal frame more than once and is operating via communications (frequency command or operation command), this status is considered disconnected.

If the status of disconnection continues for the communications disconnection time set up by function code (y08, y18), error processing is performed as a communications error.

1) Communications disconnection detection time (y08, y18): 0 (without detection), 1 to 60 (seconds)

2) Condition to clear communications disconnection detection timer:

It will be cleared in a status other than disconnection.

When it is necessary to take action against errors by factor, the factor can be identified by reading M26 or M67. (M26 or M67 stores the latest communications error codes.)

3.3.2 Operations in case of errors

The action when a transmission or communications disconnection error occurs can be selected with function code y02, y12. (For further information, see "2.4 Making RS-485-related settings.") This section shows specific examples of action by different settings of function code y02. (The same operation is performed for y12 as well. In this case, the y02 and y03 in the figure are replaced with y12 and y13, and the error indication becomes E_{rP} .)

When y02 = 0 (mode in which the inverter is forced to immediately stop in case of communications error)

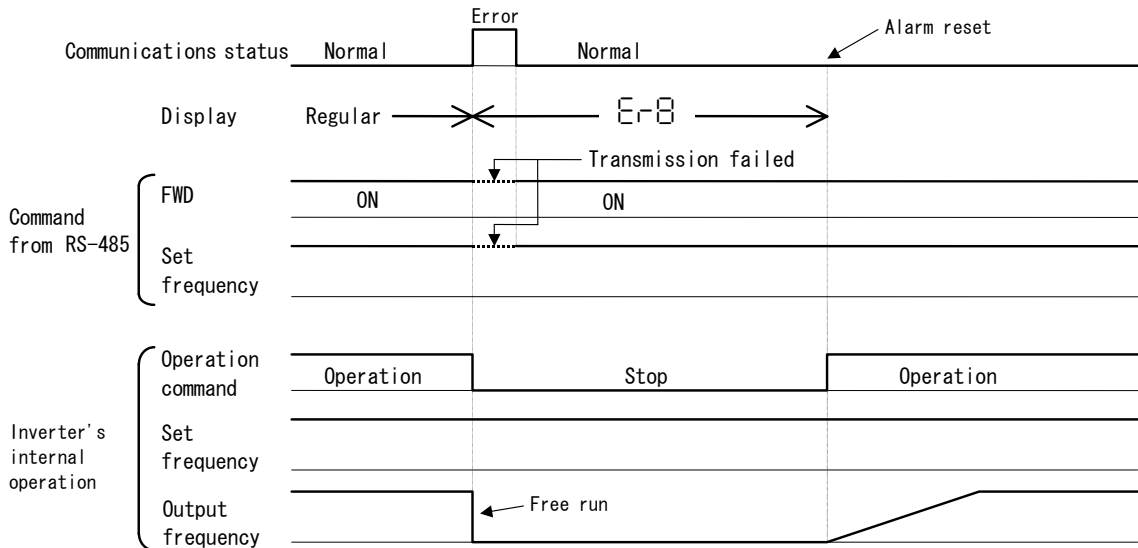

When y02 = 1 and y03 = 5.0 (seconds) (mode in which the inverter is forced to stop five seconds after a communications error occurred)

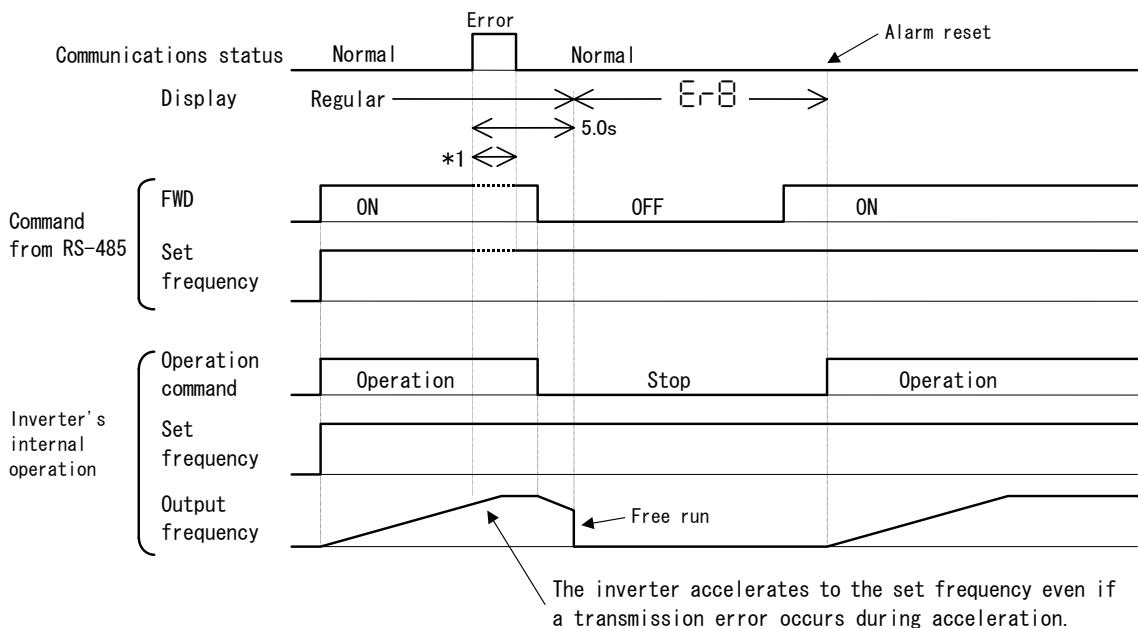

*1 For the period until communications is recovered, the command (command data, operation data) executed just before the communications error had occurred is retained.

When y02 = 2 and y03 = 5.0 (seconds)

(when communications is not recovered although five seconds elapsed from the occurrence of a communications error, and an $\epsilon p8$ trip occurs)

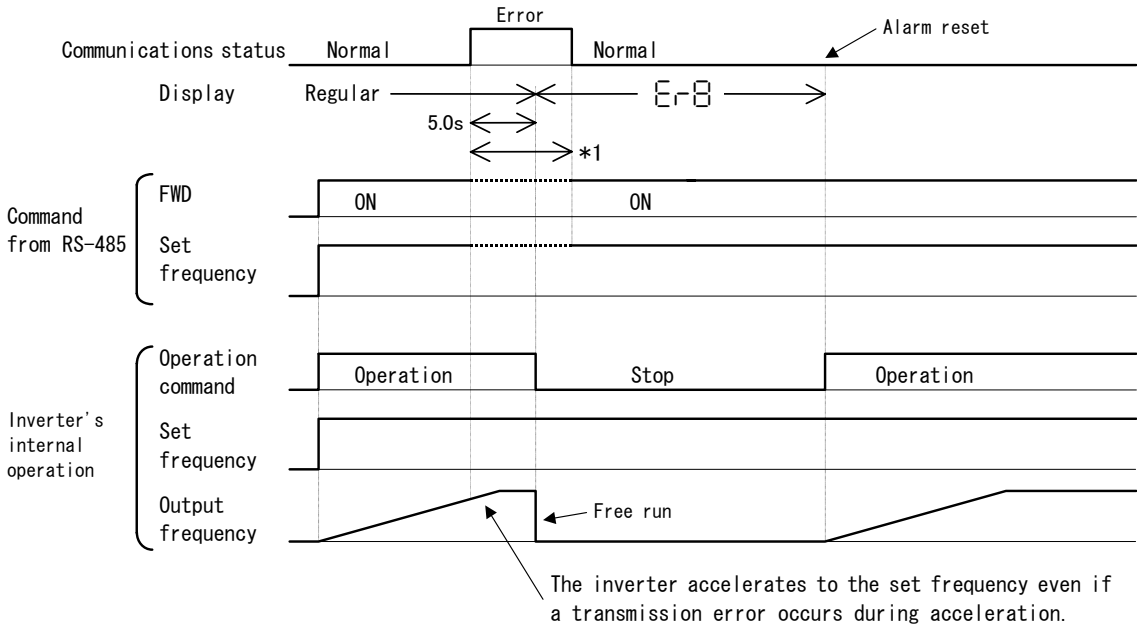

*1 For the period until communications is recovered, the command (command data, operation data) executed just before the communications error had occurred is retained.

When y02 = 2 and y03 = 5.0 (seconds)

(when a communications error occurred but communications was recovered within five seconds)

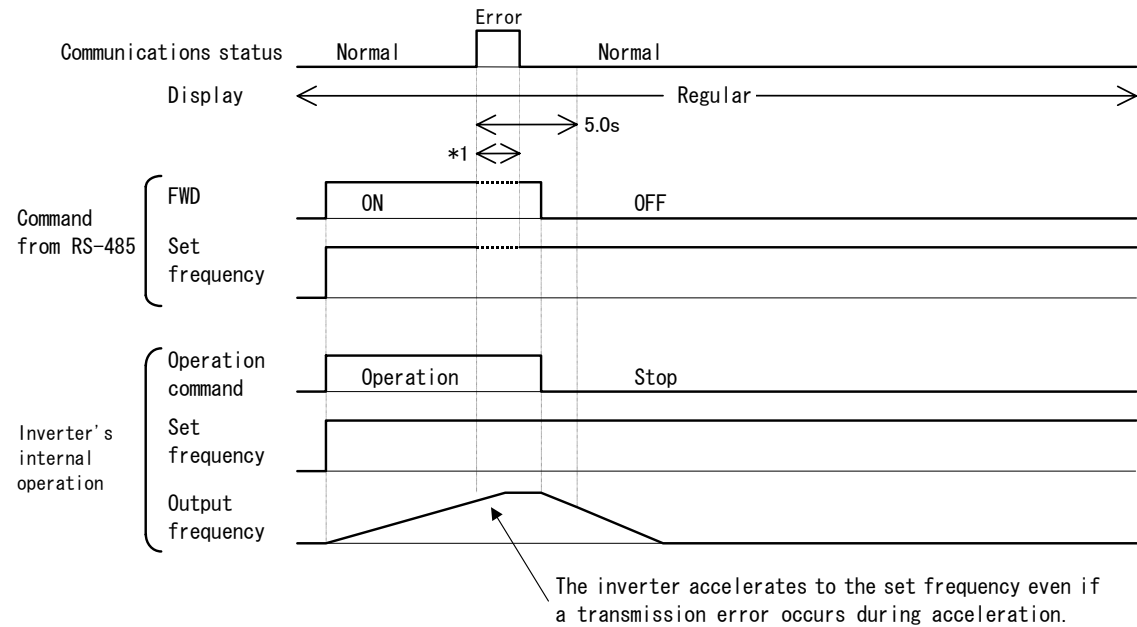

*1 For the period until communications is recovered, the command (command data, operation data) executed just before the communications error had occurred is retained.

When y02 = 3

(mode in which the inverter continues operating when a communications error occurs)

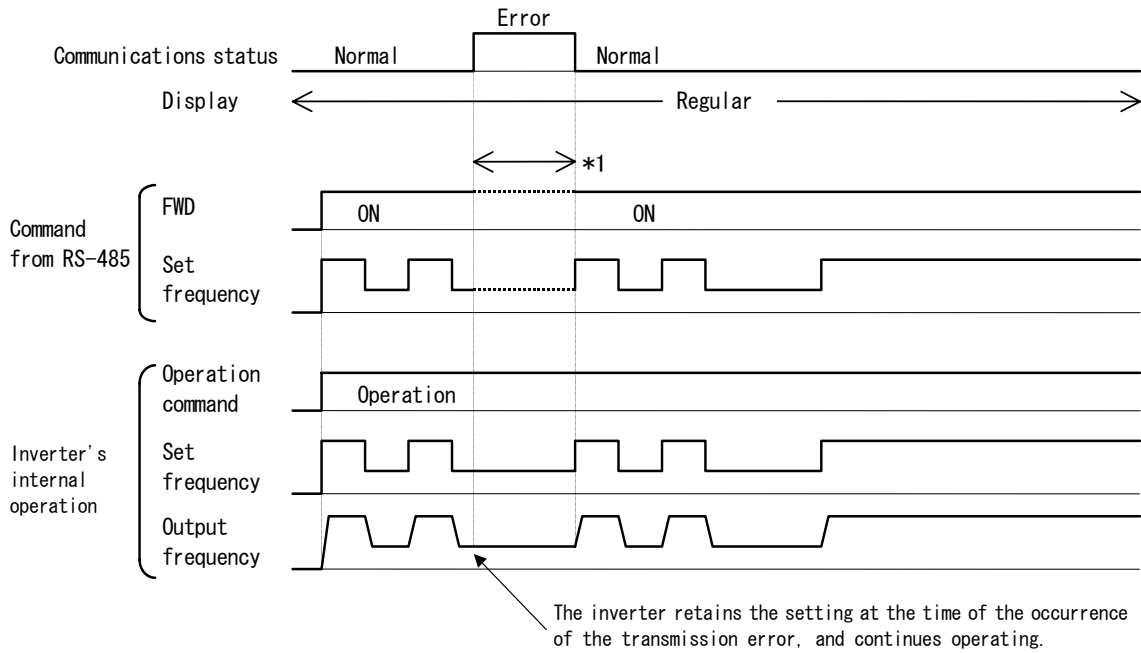

*1 For the period until communications is recovered, the command (command data, operation data) executed just before the communications error had occurred is retained.

3.4 CRC-16

3.4.1 Overview of the CRC-16

The CRC (cyclic redundancy check) is a system to confirm whether there is any error in the communications frame during data transmission.

The CRC is among the most effective error check systems. The transmission station calculates and adds CRC data to the last block of the frame, and the receiving station also calculates CRC data against the data received, and compares them with each other.

Steps to calculate CRC data

- Divide data expressed as a polynomial (for example, 0000 0001 0000 0011 0000 0011 0000 0010 0000 0000 0001 0100, the 48-bit data shown in section 3.4.3 "Calculation example" → $X^{40}+X^{33}+X^{32}+X^{25}+X^{24}+X^{17}+X^4+X^2$) by a generative polynomial expression (17 bits; $X^{16}+X^{15}+X^2+1$). CRC data is the remainder (16 bits) of this division.
- Ignore the quotient, and send a message with the remainder added to the final two characters of the data.
- The receiving station divides this message (with the CRC added) by the generative polynomial expression, and considers the transmitted message to have been received without any error if the "remainder" is 0.

CRC-16

The generative polynomial expression is expressed as a multiplier of X, such as $X^3 + X^2 + 1$, in place of the description of binary code 1101. Although any prime polynomial expression is acceptable as the generative polynomial expression, some standard generative polynomial expressions for optimizing error detection are defined and proposed. The RTU protocol uses the generative polynomial expression ($X^{16} + X^{15} + X^2 + 1$) corresponding to binary code 1 (1000 0000 0000 0101). In this case, the CRC generated is well known as CRC-16.

3.4.2 Algorithm

Figure 3.1 on the following page shows the algorithm for calculating CRC-16. Consult it together with the calculation example that follows.

In this figure, the transmission station calculates CRC data and finally adds it to the transmission frame as a check code.

The receiving station uses the same algorithm to perform a transaction. However, it collates the CRC data it calculated with the transmitted CRC data.

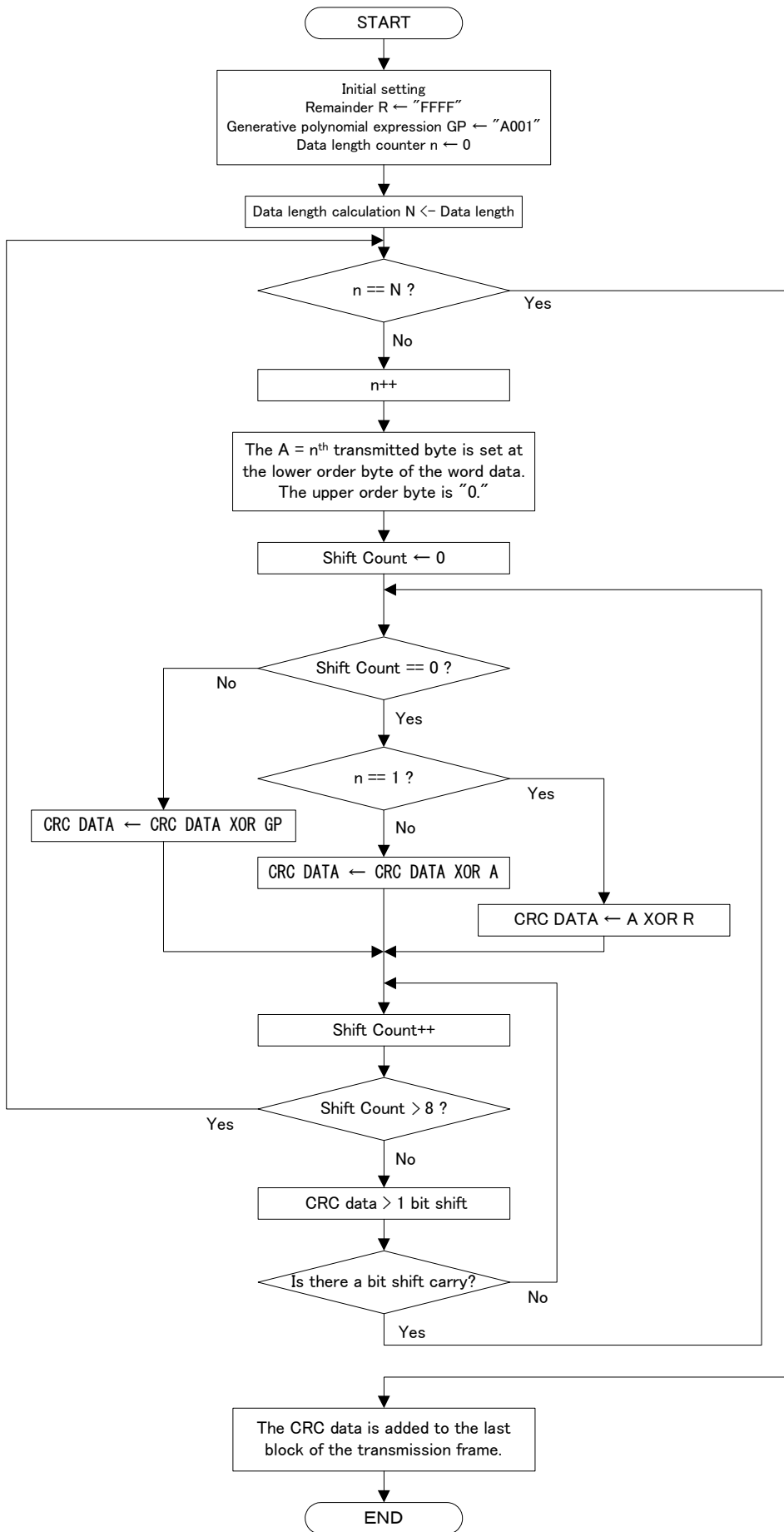

Figure 3.1 CRC algorithm

3.4.3 Calculation example

Example of transmitting read data

Station address = 1, 'FC' = 3, function code = P02 (P = 03_H, 02 = 02_H), number of read data = 20, GP = generative polynomial expression(1010 0000 0000 0001)

Station address	'FC'	Function code		Number of read data	
01 _H	03 _H	03 _H	02 _H	00 _H	14 _H

Table 3.13 CRC data calculation table

N	PROCESS	15	14	13	12	11	10	9	8	7	6	5	4	3	2	1	0	Flag
1	Initial data R = "FFFF"	1	1	1	1	1	1	1	1	1	1	1	1	1	1	1	1	
2	1 st data byte	0	0	0	0	0	0	0	0	0	0	0	0	0	0	0	0	1
3	CRC = No.1 Xor No.2	1	1	1	1	1	1	1	1	1	1	1	1	1	1	1	1	0
4	Shift > 2 (up to flag = 1)	0	0	1	1	1	1	1	1	1	1	1	1	1	1	1	1	1
5	CRC = No.4 Xor GP	1	0	0	1	1	1	1	1	1	1	1	1	1	1	1	1	0
6	Shift > 2	0	0	1	0	0	1	1	1	1	1	1	1	1	1	1	1	1
7	CRC = No.6 Xor GP	1	0	0	0	0	1	1	1	1	1	1	1	1	1	1	1	0
8	Shift > 2	0	0	1	0	0	0	0	1	1	1	1	1	1	1	1	1	1
9	CRC = No.8 Xor GP	1	0	0	0	0	0	0	1	1	1	1	1	1	1	1	1	0
10	Shift > 2 (shift of No. 8 terminated)	0	0	1	0	0	0	0	0	0	1	1	1	1	1	1	1	1
11	CRC = No.10 Xor GP	1	0	0	0	0	0	0	0	0	1	1	1	1	1	1	1	0
12	2 nd data byte	0	0	0	0	0	0	0	0	0	0	0	0	0	0	0	1	1
13	CRC = No.11 Xor No.12	1	0	0	0	0	0	0	0	0	1	1	1	1	1	0	1	
14	Shift > 1	0	1	0	0	0	0	0	0	0	0	1	1	1	1	1	0	1
15	CRC = No.14 Xor GP	1	1	1	0	0	0	0	0	0	0	1	1	1	1	1	1	
16	Shift > 1	0	1	1	1	0	0	0	0	0	0	0	1	1	1	1	1	1
17	CRC = No.16 Xor GP	1	1	0	1	0	0	0	0	0	0	0	1	1	1	1	1	0
18	Shift > 2	0	0	1	1	0	1	0	0	0	0	0	0	0	1	1	1	1
19	CRC = No.18 Xor GP	1	0	0	1	0	1	0	0	0	0	0	0	0	1	1	0	
20	Shift > 2	0	0	1	0	0	1	0	1	0	0	0	0	0	0	0	1	1
21	CRC = No.20 Xor GP	1	0	0	0	0	1	0	1	0	0	0	0	0	0	0	0	0
22	Shift > 2 (shift of No. 8 terminated)	0	0	1	0	0	0	0	1	0	1	0	0	0	0	0	0	0
23	3 rd data byte	0	0	0	0	0	0	0	0	0	0	0	0	0	0	0	1	1
24	CRC = No.22 Xor No.23	0	0	1	0	0	0	0	1	0	1	0	0	0	0	1	1	
25	Shift > 1	0	0	0	1	0	0	0	0	1	0	1	0	0	0	0	1	1
26	CRC = No.25 Xor GP	1	0	1	1	0	0	0	0	1	0	1	0	0	0	0	0	
27	Shift > 6	0	0	0	0	0	0	1	0	1	1	0	0	0	0	1	0	1
28	CRC = No.27 Xor GP	1	0	1	0	0	0	1	0	1	1	0	0	0	0	1	1	
29	Shift > 1	0	1	0	1	0	0	0	1	0	1	1	0	0	0	0	1	1
30	CRC = No.29 Xor GP	1	1	1	1	0	0	0	1	0	1	1	0	0	0	0	0	
31	4 th data byte	0	0	0	0	0	0	0	0	0	0	0	0	0	0	0	1	0
32	CRC = No.30 Xor No.31	1	1	1	1	0	0	0	1	0	1	1	0	0	0	1	0	
33	Shift > 2	0	0	1	1	1	1	0	0	0	1	0	1	1	0	0	0	1
34	CRC = No.33 Xor GP	1	0	0	1	1	1	0	0	0	1	0	1	1	0	0	1	
35	Shift > 1	0	1	0	0	1	1	1	0	0	0	1	0	1	1	0	0	1
36	CRC = No.35 Xor GP	1	1	1	0	1	1	1	0	0	0	1	0	1	1	0	1	
37	Shift > 1	0	1	1	1	0	1	1	1	0	0	0	1	0	1	1	0	1

(To be continued)

Table 3.13 CRC data calculation table (Continued)

N	PROCESS	15	14	13	12	11	10	9	8	7	6	5	4	3	2	1	0	Flag
38	CRC = No.37 Xor GP	1	1	0	1	0	1	1	1	0	0	0	1	0	1	1	1	
39	Shift > 1	0	1	1	0	1	0	1	1	1	0	0	0	1	0	1	1	1
40	CRC = No.39 Xor GP	1	1	0	0	1	0	1	1	1	0	0	0	1	0	1	0	
41	Shift > 2	0	0	1	1	0	0	1	0	1	1	1	0	0	0	1	0	1
42	CRC = No.41 Xor GP	1	0	0	1	0	0	1	0	1	1	1	0	0	0	1	1	
43	Shift > 1	0	1	0	0	1	0	0	1	0	1	1	1	0	0	0	1	1
44	CRC = No.43 Xor GP	1	1	1	0	1	0	0	1	0	1	1	1	0	0	0	0	
45	5 th data byte	0	0	0	0	0	0	0	0	0	0	0	0	0	0	0	0	
46	CRC = No.44 Xor No.45	1	1	1	0	1	0	0	1	0	1	1	1	0	0	0	0	
47	Shift > 5	0	0	0	0	0	1	1	1	0	1	0	0	1	0	1	1	1
48	CRC = No.47 Xor GP	1	0	1	0	0	1	1	1	0	1	0	0	1	0	1	0	
49	Shift > 2	0	0	1	0	1	0	0	1	1	1	0	1	0	0	1	0	1
50	CRC = No.49 Xor GP	1	0	0	0	1	0	0	1	1	1	0	1	0	0	1	1	
51	Shift > 1	0	1	0	0	0	1	0	0	1	1	1	0	1	0	0	1	1
52	CRC = No.51 Xor GP	1	1	1	0	0	1	0	0	1	1	1	0	1	0	0	0	
53	6 th data byte	0	0	0	0	0	0	0	0	0	0	0	1	0	1	0	0	
54	CRC = No.52 Xor No.53	1	1	1	0	0	1	0	0	1	1	1	1	1	1	1	0	0
55	Shift > 3	0	0	0	1	1	1	0	0	1	0	0	1	1	1	1	1	1
56	CRC = No.55 Xor GP	1	0	1	1	1	1	0	0	1	0	0	1	1	1	1	0	
57	Shift > 2	0	0	1	0	1	1	1	1	0	0	1	0	0	1	1	1	1
58	CRC = No.57 Xor GP	1	0	0	0	1	1	1	1	0	0	1	0	0	1	1	0	
59	Shift > 2	0	0	1	0	0	0	1	1	1	1	0	0	1	0	0	1	1
60	CRC = No.59 Xor GP	1	0	0	0	0	0	1	1	1	1	0	0	1	0	0	0	
61	Shift > 1 (shift of No. 8 terminated)	0	1	0	0	0	0	0	1	1	1	1	0	0	1	0	0	0
	Transmitted CRC data	4				1				E				4				

From the above calculation, the transmitted data is as shown below:

Station address	'FC'	Function code		Number of read data		CRC check	
01 _H	03 _H	03 _H	02 _H	00 _H	14 _H	E4 _H	41 _H

3.4.4 Frame length calculation

To calculate CRC-16, it is necessary to know the length of variable length messages. The length of all types of messages can be determined according to Table 3.14 Lengths of response messages.

Table 3.14 Length of response messages

'FC'	Description	Query/Broadcast message length (except CRC code)	Length of response message (except CRC code)
1	Read coil status	6 bytes	3+(3 rd) bytes*1
3	Read holding registers	6 bytes	3 + (3 rd) bytes*1
5	Force single coil	6 bytes	6 bytes
6	Preset single register	6 bytes	6 bytes
8	Diagnostics	6 bytes	6 bytes
15	Force multiple coils	7 + (7 th) bytes*1	6 bytes
16	Preset multiple registers	7 + (7 th) bytes*1	6 bytes
128 to 255	Exception function	Unused	3 bytes

*1 7th, 3rd: The 7th and 3rd byte count values stored in the frame.

CHAPTER 4

FUJI GENERAL-PURPOSE INVERTER

PROTOCOL

This chapter describes the Fuji general-purpose inverter protocol, a common protocol to Fuji general-purpose inverters, as well as the host side procedure to use this protocol and error processing.

Table of Contents

4.1	Messages	4-1
4.1.1	Message formats	4-1
4.1.2	Transmission frames	4-2
4.1.3	Descriptions of fields.....	4-11
4.1.4	Communications examples.....	4-13
4.2	Host Side Procedures	4-15
4.2.1	Inverter's response time	4-15
4.2.2	Timeout processing.....	4-16
4.2.3	Receiving preparation complete time and message timing from the host.....	4-16
4.3	Communications Errors.....	4-17
4.3.1	Categories of communications errors.....	4-17
4.3.2	Operations in case of communications errors	4-18

4.1 Messages

4.1.1 Message formats

The polling/selecting system is used to transmit and receive messages. The inverter always waits for selecting (write requests) or polling (read requests) from a host such as a personal computer or PLC.

When the inverter in the standby status receives a request frame from the host addressed to itself (local station) and considers the request frame to have been normally received, the inverter executes the transaction in response to the request, and sends back an acknowledgement (ACK) frame (or response and data in the case of polling). If the inverter judges that the receiving failed, it returns negative acknowledgment (NAK) frame. In the case of broadcast (all station batch selecting), the inverter does not send back response.

(Each frame is described in "4.1.2 Transmission frames.")

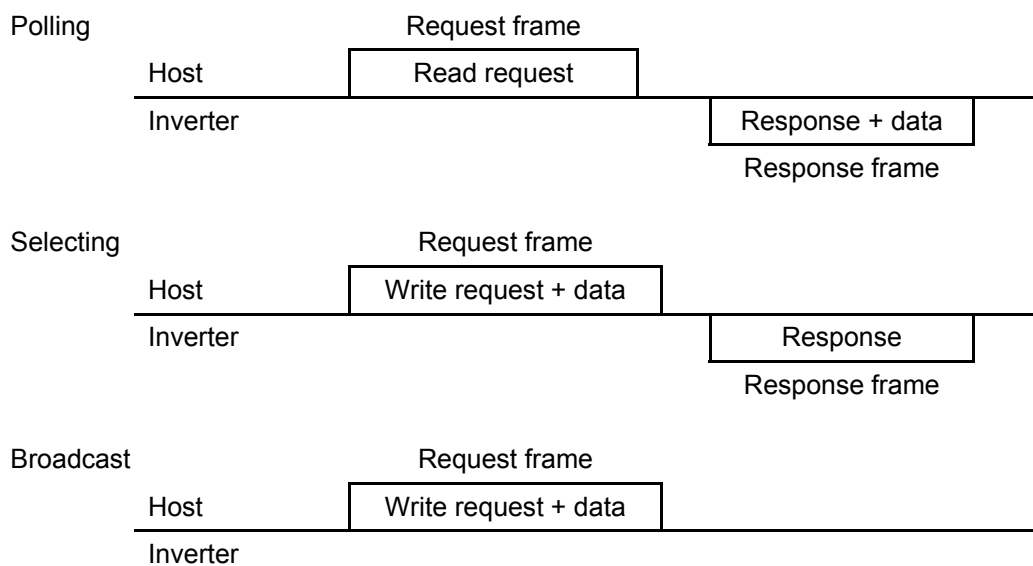

Broadcast (all station batch selecting)

A frame with the station address set to 99 is treated by all inverters as broadcast.

By using broadcast, operation or frequency commands can be simultaneously assigned to all inverters.

In broadcast communications, only selecting of S01, S05, S06, S13, S14, and S19 in the standard frame, and commands (W, E, a, e, f, and m) in the optional frame are valid.

4.1.2 Transmission frames

Transmission frames are classified into two types; standard frames with which all communications functions are available, and optional frames, allowing high-speed communications, but whose function is limited to issuing commands to and monitoring the inverter.

All characters (including BCC) comprising both standard and optional frames are represented by ASCII codes. The lengths of standard and optional frames are as shown in Table 4.1 below:

Table 4.1 Lengths of transmission frames

Frame type			Frame length
Standard frame	Selecting	Request	16 bytes
		Response	16 bytes
	Polling	Request	16 bytes
		Response	16 bytes
Optional frame	Selecting	Request	12 bytes
		Response	8 bytes
	Polling	Request	8 bytes
		Response	12 bytes

[1] Standard frame

Standard frames are classified into request frame, ACK frame, and NAK frame, and their frame configurations are as shown below.

For the meanings of the fields comprising each frame, see the tables shown on the pages that follow.

Request frame [host ⇒ inverter]

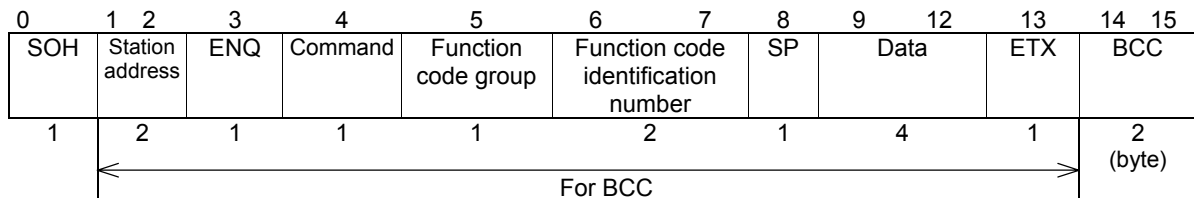

ACK frame [inverter ⇒ host]

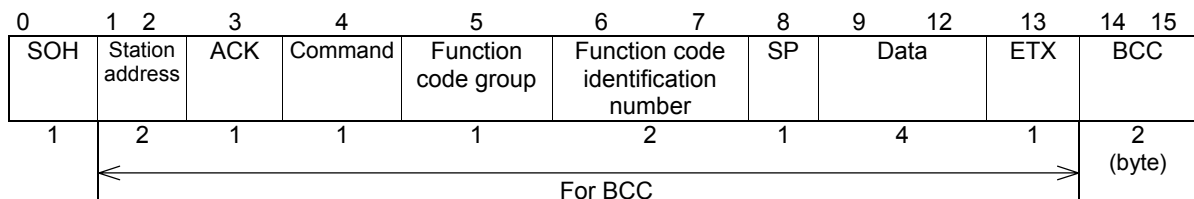

NAK frame [inverter ⇒ host]

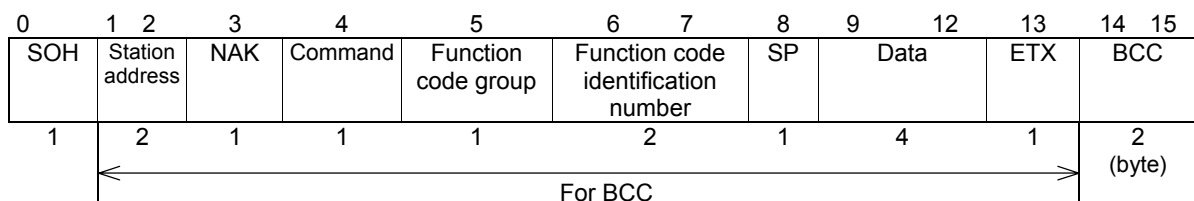

Table 4.2 Request frame

Byte	Field	Value		Description
		ASCII format	Hexadecimal format	
0	SOH	SOH	01 _H	Start of message
1	Station address	0 to 3, 9	30 _H to 33 _H 39 _H	Station address of the inverter (decimal: ten's figure)
2		0 to 9	30 _H to 39 _H	Station address of the inverter (decimal: one's figure)
3	ENQ	ENQ	05 _H	Transmission request
4	Command	R W A E	52 _H 57 _H 41 _H 45 _H	Request command Polling (read) Selecting (write) High-speed response selecting (write) *2 Alarm reset
5	Function code group *1	F E C P H A b r J d y o S M W X Z	46 _H 45 _H 43 _H 50 _H 48 _H 41 _H 42 _H 52 _H 4A _H 44 _H 59 _H 4F _H 53 _H 4D _H 57 _H 58 _H 5A _H	Function code group *3 Fundamental function Extension terminal function Control function of frequency Motor1 parameter High performance function Motor2 parameter Motor3 parameter Motor4 parameter Application function 1 Application function 2 Link function Option function Command data Monitor data 1 Monitor data 2 Alarm data 1 Alarm data 2
6	Function code identification number *1	0 to 9	30 _H to 39 _H	Function code identification number (decimal: ten's figure)
7		0 to 9	30 _H to 39 _H	Function code identification number (decimal: one's figure)
8	Special additional data	SP	20 _H	Unused (space fixed)
9	Data	0 to 9, A to F	30 _H to 39 _H 41 _H to 46 _H	Data's first character (hexadecimal: thousand's figure)
10				Data's second character (hexadecimal: hundred's figure)
11				Data's third character (hexadecimal: ten's figure)
12				Data's fourth character (hexadecimal: one's figure)
13	ETX	ETX	03 _H	End of message
14	BCC	0 to 9, A to F	30 _H to 39 _H 41 _H to 46 _H	Checksum 1 (hexadecimal: ten's figure)
15				Checksum 2 (hexadecimal: one's figure)

*1 A space (SP = 20_H) will be set for an alarm reset command.

*2 Use high-speed response selecting to read the monitor when a command, which takes time for selecting (see Table 4.13 in "4.2 Host Side Procedures"), is written. The inverter does not respond to the regular write command W until writing is completed. With regard to high-speed response command A, the inverter sends back response upon receipt of a write request and communications can, therefore, continue even during writing. To confirm whether writing is completed in this case, read the BUSY flag (M14: 15 bits). If additional writing is performed during writing, NAK (error during writing) will result.

*3 Function codes are divided into function codes that can be edited from the keypad of the inverter, and communications dedicated function codes.

1) Function codes editable from the keypad

Fundamental function:	F code
Extension terminal function:	E code
Control function of frequency:	C code
Motor1 parameter:	P code
High performance function:	H code
Motor2 parameter:	A code
Motor3 parameter:	b code
Motor4 parameter:	r code
Application function 1:	J code
Application function 2:	d code
Link function:	y code
Option function:	o code

For the contents of function codes, see Chapter 2, 2.4 Making RS-485-related Settings and User's Manual of each inverter model (Chapter 9 in FRENIC-Mini/Eco-Multi and Chapter 5 in FRENIC-MEGA).

2) Communications dedicated function codes

Command data:	S code
Monitor data 1:	M code
Monitor data 2:	W code
Alarm data 1:	X code
Alarm data 2:	Z code

For further information about these codes, see "Chapter 5 Function Codes and Data Formats."

Table 4.3 ACK frame

Byte	Field	Value		Description
		ASCII format	Hexadecimal format	
0	SOH	SOH	01 _H	Start of message
1	Station address	0 to 3	30 _H to 33 _H	Station address of the inverter (decimal: ten's figure)
2		0 to 9	30 _H to 39 _H	Station address of the inverter (decimal: one's figure)
3	ACK	ACK	06 _H	Transmission response Acknowledgement: There was no receiving or logical error.
4	Command	R W A E	52 _H 57 _H 41 _H 45 _H	Answerback of request command Polling (read) Selecting (write) High-speed response selecting (write) Alarm reset
5	Function code group *1	F E C P H A b r J d y o S M W X Z	46 _H 45 _H 43 _H 50 _H 48 _H 41 _H 42 _H 52 _H 4A _H 44 _H 59 _H 4F _H 53 _H 4D _H 57 _H 58 _H 5A _H	Function code group Fundamental function Extension terminal function Control function of frequency Motor1 parameter High performance function Motor2 parameter Motor3 parameter Motor4 parameter Application function 1 Application function 2 Link function Option function Command data Monitor data 1 Monitor data 2 Alarm data 1 Alarm data 2
6	Function code identification number *1	0 to 9	30 _H to 39 _H	Function code identification number (decimal: ten's figure)
7		0 to 9	30 _H to 39 _H	Function code identification number (decimal: one's figure)
8	Special additional data	SP -	20 _H 2D _H	Fixed to "sp (space)" normally. "-" for negative data
9	Data	0 to 9, A to F	30 _H to 39 _H 41 _H to 46 _H	Data's first character (hexadecimal: thousand's figure)
10				Data's second character (hexadecimal: hundred's figure)
11				Data's third character (hexadecimal: ten's figure)
12				Data's fourth character (hexadecimal: one's figure)
13	ETX	ETX	03 _H	End of message
14	BCC	0 to 9, A to F	30 _H to 39 _H 41 _H to 46 _H	Checksum 1 (hexadecimal: ten's figure)
15				Checksum 2 (hexadecimal: one's figure)

*1 A space (SP = 20_H) will be set for an alarm reset command.

Table 4.4 NAK frame

Byte	Field	Value		Description
		ASCII format	Hexadecimal format	
0	SOH	SOH	01 _H	Start of message
1	Station address	0 to 3	30 _H to 33 _H	Station address of the inverter (decimal: ten's figure)
2		0 to 9	30 _H to 39 _H	Station address of the inverter (decimal: one's figure)
3	NAK	NAK	15 _H	Transmission response Negative acknowledgement: There was a logical error in the request.
4	Command *1	R W A E	52 _H 57 _H 41 _H 45 _H	Answerback of request command Polling (read) Selecting (write) High-speed response selecting (write) Alarm reset
5	Function code group *1	F E C P H A b r J d y o S M W X Z	46 _H 45 _H 43 _H 50 _H 48 _H 41 _H 42 _H 52 _H 4A _H 44 _H 59 _H 4F _H 53 _H 4D _H 57 _H 58 _H 5A _H	Function code group Fundamental function Extension terminal function Control function of frequency Motor1 parameter High performance function Motor2 parameter Motor3 parameter Motor4 parameter Application function 1 Application function 2 Link function Option function Command data Monitor data 1 Monitor data 2 Alarm data 1 Alarm data 2
6	Function code identification number *1	0 to 9	30 _H to 39 _H	Function code identification number (decimal: ten's figure)
7		0 to 9	30 _H to 39 _H	Function code identification number (decimal: one's figure)
8	Special additional data	SP	20 _H	Unused (space fixed)
9	Data	SP	20 _H	Unused (space fixed)
10		SP	20 _H	Unused (space fixed)
11		0 to 9, A to F	30 _H to 39 _H 41 _H to 46 _H	Communications error code higher order (hexadecimal: ten's figure)
12				Communications error code lower order (hexadecimal: one's figure)
13	ETX	ETX	03 _H	End of message
14	BCC	0 to 9, A to F	30 _H to 39 _H 41 _H to 46 _H	Checksum 1 (hexadecimal: ten's figure)
15				Checksum 2 (hexadecimal: one's figure)

*1 The field contents of command type, function code group, function code identification number vary at the format error or command error.

[2] Optional frame

This section describes the structure and meaning of each optional frame.

Selecting request frame [host ⇒ inverter]

Table 4.5 Selecting request frame

Byte	Field	Value		Description
		ASCII format	Hexadecimal format	
0	SOH	SOH	01 _H	Start of message
1	Station address	0 to 3, 9	30 _H to 33 _H 39 _H	Station address of the inverter (decimal: ten's figure)
2		0 to 9	30 _H to 39 _H	Station address of the inverter (decimal: one's figure)
3	ENQ	ENQ	05 _H	Transmission request
4	Command	a e f m	61 _H 65 _H 66 _H 6D _H	Request command Speed setting (S01) Frequency command (S05) Operation command (S06) Reset command (The data part is all zero)
5	Data	0 to 9, A to F	30 _H to 39 _H 41 _H to 46 _H	Data's first character (hexadecimal: thousand's figure)
6				Data's second character (hexadecimal: hundred's figure)
7				Data's third character (hexadecimal: ten's figure)
8				Data's fourth character (hexadecimal: one's figure)
9	ETX	ETX	03 _H	End of message
10	BCC	0 to 9, A to F	30 _H to 39 _H 41 _H to 46 _H	Checksum 1 (hexadecimal: ten's figure)
11				Checksum 2 (hexadecimal: one's figure)

Selecting response frame [inverter ⇒ host]

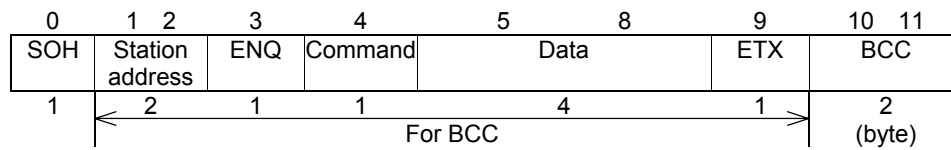
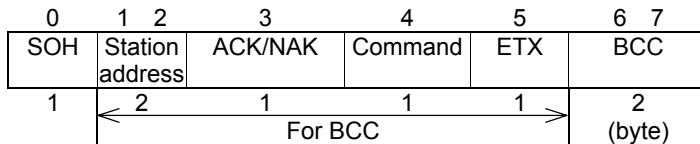

Table 4.6 Selecting response frame (ACK/NAK)

Byte	Field	Value		Description
		ASCII format	Hexadecimal format	
0	SOH	SOH	01 _H	Start of message
1	Station address	0 to 3	30 _H to 33 _H	Station address of the inverter (decimal: ten's figure)
2		0 to 9	30 _H to 39 _H	Station address of the inverter (decimal: one's figure)
3	ACK/NAK	ACK	06 _H	Transmission response Acknowledgement: There was no receiving or logical error.
		NAK	15 _H	Negative acknowledgment: There was a logical error in the request.
4	Command	a	61 _H	Request command
		e	65 _H	Speed setting (S01)
		f	66 _H	Frequency command (S05)
		m	6D _H	Operation command (S06) Reset command
5	ETX	ETX	03 _H	End of message
6	BCC	0 to 9, A to F	30 _H to 39 _H 41 _H to 46 _H	Checksum 1 (hexadecimal: ten's figure)
7				Checksum 2 (hexadecimal: one's figure)

Polling request frame [host ⇒ inverter]

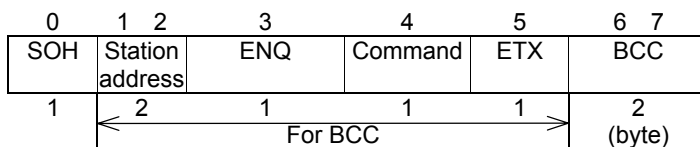

Table 4.7 Polling request frame

Byte	Field	Value		Description
		ASCII format	Hexadecimal format	
0	SOH	SOH	01 _H	Start of message
1	Station address	0 to 3	30 _H to 33 _H	Station address of the inverter (decimal: ten's figure)
2		0 to 9	30 _H to 39 _H	Station address of the inverter (decimal: one's figure)
3	ENQ	ENQ	05 _H	Transmission request
4	Command	g	67 _H	Request command
		j	6A _H	Actual frequency, actual speed (M06)
		k	6B _H	Output frequency monitor (M09)
		h	68 _H	Operation status monitor (M14)
		i	69 _H	Torque monitor (M07) (not supported by FRENIC-Mini) Torque current monitor (M08) (Usable only for FRENIC-MEGA)
5	ETX	ETX	03 _H	End of message
6	BCC	0 to 9, A to F	30 _H to 39 _H 41 _H to 46 _H	Checksum 1 (hexadecimal: ten's figure)
7				Checksum 2 (hexadecimal: one's figure)

Polling response frame [inverter ⇒ host]

Table 4.8 Polling response frame (ACK)

Byte	Field	Value		Description
		ASCII format	Hexadecimal format	
0	SOH	SOH	01 _H	Start of message
1	Station address	0 to 3	30 _H to 33 _H	Station address of the inverter (decimal: ten's figure)
2		0 to 9	30 _H to 39 _H	Station address of the inverter (decimal: one's figure)
3	ACK/NAK	ACK	06 _H	Transmission request Acknowledgement: There was no receiving or logical error.
4	Command	g j k h i	67 _H 6A _H 6B _H 68 _H 69 _H	Request command Actual frequency, actual speed (M06) Output frequency monitor (M09) Operation status monitor (M14) Torque monitor (M07) (not supported by FRENIC-Mini) Torque current monitor (M08) (Usable only for FRENIC-MEGA)
5	Data	0 to 9, A to F	30 _H to 39 _H 41 _H to 46 _H	Data's first character (hexadecimal: thousand's figure)
6				Data's second character (hexadecimal: hundred's figure)
7				Data's third character (hexadecimal: ten's figure)
8				Data's fourth character (hexadecimal: one's figure)
9	ETX	ETX	03 _H	End of message
10	BCC	0 to 9, A to F	30 _H to 39 _H 41 _H to 46 _H	Checksum 1 (hexadecimal: ten's figure)
11				Checksum 2 (hexadecimal: one's figure)

Table 4.9 Polling response frame (NAK)

Byte	Field	Value		Description
		ASCII format	Hexadecimal format	
0	SOH	SOH	01 _H	Start of message
1	Station address	0 to 3	30 _H to 33 _H	Station address of the inverter (decimal: ten's figure)
2		0 to 9	30 _H to 39 _H	Station address of the inverter (decimal: one's figure)
3	ACK/NAK	NAK	15 _H	Transmission request Negative acknowledgment: There was a logical error in the request.
4	Command	g j k h i	67 _H 6A _H 6B _H 68 _H 69 _H	Request command Actual frequency, actual speed (M06) Output frequency monitor (M09) Operation status monitor (M14) Torque monitor (M07) (not supported by FRENIC-Mini) Torque current monitor (M08) (Usable only for FRENIC-MEGA)
5	Data	SP	20 _H	Unused (fixed space)
		SP	20 _H	Unused (fixed space)
		0 to 9, A to F	30 _H to 39 _H 41 _H to 46 _H	Communications error code high-order digit (hexadecimal: ten's figure) Communications error code low-order digit (hexadecimal: one's figure)
9	ETX	ETX	03 _H	End of message
10	BCC	0 to 9, A to F	30 _H to 39 _H 41 _H to 46 _H	Checksum 1 (hexadecimal: ten's figure)
11				Checksum 2 (hexadecimal: one's figure)

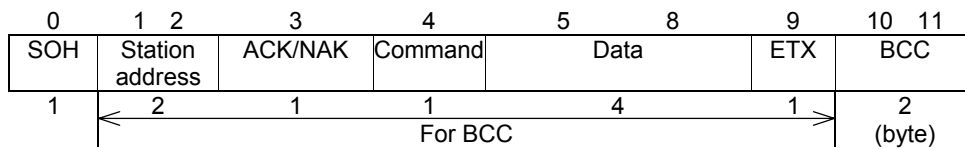
[3] NAK frame

When the response frame length is determined by the command type and the command type character is correctly identified, response will be given according to the frame length specified by the command in principle. Concerning all the request frames, if the inverter failed to detect ETX after detecting request-to-send character with the specified 3-byte position until reaching the 15-byte position, the inverter returns no response.

Table 4.10 Negative acknowledgment (NAK) frame

No.	Frame/Command type	Cause of error	NAK response frame	Error code (M26)
1	Standard frame Optional frame	The ENQ was not detected in the specified position.	Standard frame (16 bytes long)	Format error [74]
2	Selecting command (a, e, f, m)	The ETX was not detected in the specified position.	Optional frame (8 bytes long)	Format error [74]
3	Polling command (g, j, k, h, i)	The ETX was not detected in the specified position.	Optional frame (12 bytes long)	Format error [74]
4	Other than specified commands	A command other than the specified commands (R, W, A, E, a, e, f, g, j, k, h, i, m) was detected.	Standard frame (16 bytes long)	Command error [75]



When negative acknowledgement (NAK) for a format or command error is returned with the standard format as in the case of No. 1 and No. 4, the contents of the command type, function code group, and function code identification number fields will be undefined.

4.1.3 Descriptions of fields

[1] Command field

The table below shows command types. The applicable frame is different among the command types.

Table 4.11 Command formats

Command	Description	Applicable frame
ASCII R	Reads function code data (polling).	Standard frame
ASCII W	Writes function code data (selecting).	
ASCII A	Writes function code data at high speed (writing that does not wait for writing to be completed).	
ASCII E	Resets an alarm.	
ASCII a	Gives a frequency command (S01). *1	Optional frame
ASCII e	Gives a frequency command (S05). *1	
ASCII f	Gives an operation command (S06). *1	
ASCII g	Reads the output frequency (M06). *1	
ASCII h	Reads the torque monitor (M07). *1 (not supported by FRENIC-Mini)	
ASCII i	Reads the torque current monitor (M08) *1 (Usable only for FRENIC-MEGA)	
ASCII j	Reads the output frequency (M09). *1	
ASCII k	Reads the operation status monitor (M14). *1	
ASCII m	Resets an alarm.	

*1 The above commands "a" to "k" are used to read or write data in the function code data format specified in parentheses.

[2] Data field

Standard frame

8	9	10	11	12
Special additional data	Data's first character	Data's second character	Data's third character	Data's fourth character

Optional frame

9	10	11	12
Data's first character	Data's second character	Data's third character	Data's fourth character

All data, except for some special ones, are treated as 16 bits long. In the data field of the communications frame, data is hexadecimal (0000_H – FFFF_H), and each digit is represented by an ASCII code. Negative integer data (signed data) is treated as a complement of 2 of the integer data without the sign.



- The alphabetic characters A to F of hexadecimal data must be uppercase.
- Set 0 in all the data fields of the request frame for polling.
- In selecting, the data field of the ACK frame will be undefined.

(Example) When setting 20Hz with function code S01 (speed setting 1) (maximum frequency = 60Hz)

1) Calculate the set value according to the data format of S01 ($\pm 20000/\text{maximum frequency}$).

$$\begin{aligned} \text{Data} &= 20\text{Hz} \times \pm 20000/60\text{Hz} \text{ (+ for forward rotation, - for reverse rotation)} \\ &= \pm 6666.6 \\ &\approx \pm 6667 \end{aligned}$$

2) Convert the data into hexadecimal (a complement of 2 in the case of negative data).

$$\begin{aligned} \text{Data} &= 6667 \dots\dots\dots \text{(forward rotation)} \\ &= 1A0B_H \end{aligned}$$

$$\begin{aligned} \text{Data} &= -6667 \dots\dots\dots \text{(reverse rotation)} \\ &= 0 - 6667 \end{aligned}$$

Thus,

$$65536 - 6667 = 58869 = E5F5_H$$

3) Set the data.

Position	Set value (forward rotation)	Set value (reverse rotation)
Data's first character	ASCII 1	ASCII E
Data's second character	ASCII A	ASCII 5
Data's third character	ASCII 0	ASCII F
Data's fourth character	ASCII B	ASCII 5

[3] Checksum field

The data in this field is intended to check whether there is any error in the communications frame at the time of data transmission. Calculate the data by adding one byte to all fields, except for SOH and the checksum field, treating the last byte of the result as a two-digit hexadecimal value, and converting each digit into an ASCII code.

(Example) When the result of addition is 0123_H

Position	Set value (forward rotation)
Checksum 1	ASCII 2
Checksum 2	ASCII 3

4.1.4 Communications examples

Typical communications examples are shown below (the station number is 12 in all cases):

[1] Standard frame

(Example 1) Selecting S01: speed setting 1 (write)

10Hz command x 20,000/maximum frequency 50Hz = 4000d = 0FA0_H

Request frame (host ⇒ inverter)

SOH	1	2	ENQ	W	S	0	1	SP	0	F	A	0	ETX	7	D
-----	---	---	-----	---	---	---	---	----	---	---	---	---	-----	---	---

ACK frame (inverter ⇒ host)

SOH	1	2	ACK	W	S	0	1	SP	0	F	A	0	ETX	7	E
-----	---	---	-----	---	---	---	---	----	---	---	---	---	-----	---	---

NAK frame (inverter ⇒ host) ... Link priority error

SOH	1	2	NAK	W	S	0	1	SP	SP	SP	4	C	ETX	5	D
-----	---	---	-----	---	---	---	---	----	----	----	---	---	-----	---	---

(Example 2) Polling of M09: output frequency (read)

Request frame (host ⇒ inverter)

SOH	1	2	ENQ	R	M	0	9	SP	0	0	0	0	ETX	5	3
-----	---	---	-----	---	---	---	---	----	---	---	---	---	-----	---	---

ACK frame (inverter ⇒ host)

SOH	1	2	ACK	R	M	0	9	SP	0	B	B	8	ETX	8	0
-----	---	---	-----	---	---	---	---	----	---	---	---	---	-----	---	---

[2] Optional frame

(Example 1) Selecting of operation command (write)

Request frame (host ⇒ inverter) ... FWD command

SOH	1	2	ENQ	f	0	0	0	1	ETX	9	2
-----	---	---	-----	---	---	---	---	---	-----	---	---

ACK frame (inverter ⇒ host)

SOH	1	2	ACK	f	ETX	D	2
-----	---	---	-----	---	-----	---	---

NAK frame (inverter ⇒ host)

The cause of the error can be confirmed with function code M26 (transmission error transaction code).

SOH	1	2	NAK	f	ETX	E	1
-----	---	---	-----	---	-----	---	---

(Example 2) Selecting of operation command in broadcast (write)

Request frame (host ⇒ inverter) ... REV command

SOH	9	9	ENQ	f	0	0	0	2	ETX	A	2
-----	---	---	-----	---	---	---	---	---	-----	---	---

The inverter does not respond to broadcast.

Table 4.12 ASCII code table

	00 _H	10 _H	20 _H	30 _H	40 _H	50 _H	60 _H	70 _H
0 _H	NUL	DLE	SP	0	@	P	`	p
1 _H	SOH	DC1	!	1	A	Q	a	q
2 _H	STX	DC2	"	2	B	R	b	r
3 _H	ETX	DC3	#	3	C	S	c	s
4 _H	EOT	DC4	\$	4	D	T	d	t
5 _H	ENQ	NAK	%	5	E	U	e	u
6 _H	ACK	SYN	&	6	F	V	f	v
7 _H	BEL	ETB	'	7	G	W	g	w
8 _H	BS	CAN	(8	H	X	h	x
9 _H	HT	EM)	9	I	Y	i	y
A _H	LF	SUB	*	:	J	Z	j	z
B _H	VT	ESC	+	;	K	[k	{
C _H	FF	FS	,	<	L	\	l	
D _H	CR	GS	-	=	M]	m	}
E _H	SO	RS	.	>	N	-	n	~
F _H	SI	US	/	?	O	_	o	DEL

The shaded codes are used for this communications protocol.

4.2 Host Side Procedures

4.2.1 Inverter's response time

Upon receipt of a query request from the host, the inverter executes the requested command, and sends back response after the response time shown below:

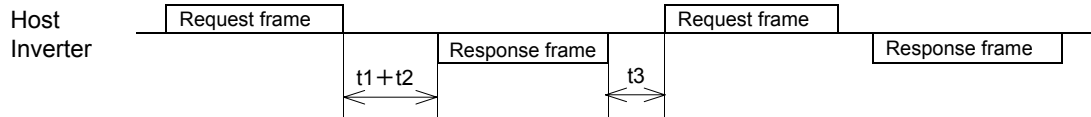

$t_1 + t_2$: Inverter's response time

t1: Response interval time (function code: y09)

The time until the inverter starts to send response to the request from the host can be set. Setting the response interval time enables even the host side with a slow transaction execution speed to adjust timing.

t2: Inverter's transaction time

This is the time until the inverter executes the request and sends back response as shown in Table 4.13 below.

t3: See "4.2.3 Receiving preparation complete time and message timing from the host."

Table 4.13 Inverter's transaction time

Command	Transaction	Description	t2	Timeout time (recommended)
R	Function code read data		≤10ms	0.1 sec
W	Function code write data	S code commands other than S08 or S09	≤10ms	0.1 sec
		Motor parameter initialization FRENIC-Mini/Eco: H03 = 2 FRENIC-Multi: H03 = 2, 3 FRENIC-MEGA: H03 = 2, 3, 4, 5	≤500ms	1.0 sec
		Data initialization: H03 = 1	≤5s	10.0 sec
		Function code other than above	≤100ms	0.5 sec
A	Function code data high-speed writing		≤10ms	0.1 sec
E, m	Alarm reset		≤10ms	0.1 sec
a, e, f	Specific function code write data		≤10ms	0.1 sec
g, h, i, j, k	Specific function code read data		≤10ms	0.1 sec

4.2.2 Timeout processing

To read/write data from/to the host, transmit the next frame after confirming response. If response is not transmitted from the inverter for more than a specified period of time (timeout time), it is a timeout, and perform a retry. (If a retry begins before a timeout, the requested frame cannot be received properly.)

The timeout time must be set longer than the response time of the inverter. Table 4.13 above mentioned shows recommended timeout times when no response interval time is set.

In case of a timeout, retransmit the same frame or perform polling (M26) for reading details of an error to confirm whether the inverter sends back normal response. If normal response is returned, this indicates that some transient transmission error occurred due to noise or other reasons, and subsequent communications is normal. (However, if this phenomenon frequently occurs even when normal response is sent back, some problem may exist. Perform a close investigation.) In case of no response, perform another retry. If the number of retries exceeds the set value (generally about three times), there may be a problem with the hardware and the software for the host controller. Investigate and correct the cause.

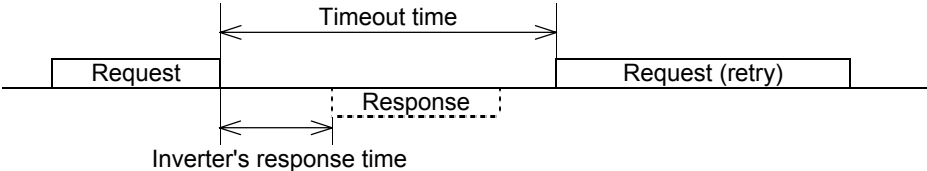

4.2.3 Receiving preparation complete time and message timing from the host

The time from the return of response by the inverter to the completion of receiving preparation of the communications port (switching from transmission to receiving) is called a receiving preparation complete time.

Transmit the following messages after the receiving preparation complete time:

- Receiving preparation complete time: 5ms or less
- Message timing from the host (t3): t3 > 5ms

In the case of broadcast

Upon receipt of a request for a query message from the host by broadcast, the inverter executes the command and enters the receiving enabled status.

Transmit the next message from the host following broadcast after the transaction time (t2) of the inverter.

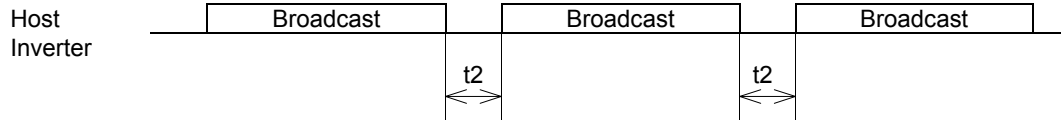

4.3 Communications Errors

4.3.1 Categories of communications errors

The communications-related errors the inverter detects are listed below:

Table 4.14 Communications errors detected by inverter

Error category	Error name	Description	Error code (M26)	Order of priority
Transmission error	Checksum error	The frame to the local station is found unmatched in checksum collation.	71(47 _H)	–
	Parity error	The parity is unmatched.	72(48 _H)	–
	Other errors	Receiving errors other than the abovementioned (framing error, overrun error)	73(49 _H)	–
Logical error	Format error	<ul style="list-style-type: none"> - The characters of the transmission request are incorrect. - The last character of the message is not in the specified position. 	74(4A _H)	1
	Command error	A command that does not exist was transmitted.	75(4B _H)	2
	Link priority error (does not occur for FRENIC-Mini)	A frequency command, PID command, or change command of the run command (writing request to S01, S05, S06, and S13) are sent through the communications route other than that specified with H30.	76(4C _H)	3
	Function code error	A function code that does not exist was requested.	78(4E _H)	4
	Write disabled error	An attempt was made during operation to write the function code for write disabled or for write disabled during operation.	79(4F _H)	5
	Data error	The write data is beyond the writable range.	80(50 _H)	6
	Error during writing	An attempt was made to write another function data during function writing with command A.	81(51 _H)	7
	Communications disconnection error	Communications disconnection error	The inverter did not receive a normal frame addressed to local station or to other stations within the communications disconnection detection time set with the function code.	–

Transmission error (error codes 71 to 73)

When a transmission error occurs eight straight times, it is handled as a communications error. However, the inverter does not return response in order to avoid overlapping of response from multiple inverters. The count of eight straight times will be cleared upon normal receipt of a frame to another station or to the local inverter (station) itself.

Logical error (error codes 74 to 81)

When a logical error is detected, a negative acknowledgment (NAK) frame reports it. For further information, see the NAK response of each frame. The table 4.14 shows the order of priority of logical error. If the alarm is caused by two or more factors, the factor with the highest priority (smallest number) is indicated as an error code.

Concerning all the request frames, if the inverter failed to detect ETX after detecting request-to-send character with the specified 3-byte position until reaching the 15-byte position, the inverter returns no response.

Communications disconnection error

If the inverter in operation does not receive a normal frame to itself (local station) or to another station when it has received a normal frame more than once and is operating via communications (frequency command or operation command), this status is considered disconnected.

When a disconnection status is set and remains over the setting time of function code y08, y18 (communications disconnection detection time), it is treated as a communications error.

- 1) Communications disconnection detection time (y08, y18): 0 (without detection), 1 to 60 (seconds)
- 2) Condition to clear communications disconnection detection timer: It will be cleared in a status other than disconnection.

When it is necessary to take action against errors by factor, the factor can be identified by reading M26. (M26 stores the latest communications error codes.)

4.3.2 Operations in case of communications errors

Operations in case of a transmission or communications disconnection error are the same as those of the Modbus RTU protocol. See "3.3.2 Operations in case of errors" in Chapter 3 Modbus RTU Protocol.

CHAPTER 5

FUNCTION CODES AND DATA FORMATS

This chapter describes communications dedicated function codes and the data formats of communications frames. FRENIC-Mini, FRENIC-Eco and FRENIC-Multi support different function codes. For details, see the description of each function code.

Table of Contents

5.1	Communications Dedicated Function Codes	5-1
5.1.1	About communications dedicated function codes	5-1
5.1.2	Command data	5-2
5.1.3	Monitor data 1	5-9
5.1.4	Information displayed on the keypad	5-15
5.2	Data Formats	5-26
5.2.1	List of data format numbers	5-26
5.2.2	Data format specifications	5-47

5.1 Communications Dedicated Function Codes

5.1.1 About communications dedicated function codes

Communications dedicated function codes are available to monitor the operation and status of the inverter via communications. They are classified into the groups shown in Table 5.1 below:

Table 5.1 Types of communications dedicated function codes

Communications dedicated function code group	Function
S	Command data
M	Monitor data 1 (for reading only)
W	Monitor data 2 (for reading only)
X	Alarm information (for reading only)
Z	

The sections that follow describe communications dedicated function codes of each group.

5.1.2 Command data

[1] List of command data

The table below shows the function codes (S code) for the command data. The "Support" column indicates whether the function code is supported or not. The symbol "O" means that the code is supported and the symbol "X" means that the code is not supported.

Table 5.2 List of command data

Code	Name	Function	Permissible setting range	Min. step	Unit	R/W *1	Support			
							Mini	Eco	Multi	MEGA
S01	Frequency reference (p.u.)	Frequency command issued through communications (the reference value for maximum frequency)	-32768 to 32767 (Max frequency: at +/- 20000)	1	-	R/W	○	○	○	○
S05	Frequency reference	Frequency command issued through communications (in units of 0.01 Hz)	0.00 to 655.35	00.1	Hz	R/W	○	○	○	○
S06	Operation command	Operation command issued through communications [general input terminal functions (X1 to X9, XF (FWD), R (REV)) and FWD, REV, RST only through communications]	0000 _H to FFFF _H	1	-	R/W	○	○	○	○
S07	Universal DO	Command issued to DO terminal through communications	0000 _H to FFFF _H	1	-	R/W	×	○	○ ^{*2}	○
S08	Acceleration time F07	Each data is set with the code or communications format common to all the inverter types.	Mini/Eco/Multi: 0.0 to 3600.0 MEGA: 0.0 to 6000.0	0.1	s	R/W	○	○	○	○
S09	Deceleration time F08		Mini/Eco/Multi: 0.0 to 3600.0 MEGA: 0.0 to 6000.0	0.1	s	R/W	○	○	○	○
S10	Torque limit level 1 F40		20 to 200, 999	1	%	R/W	×	×	○	×
	Torque limit value		-300.00 to 300.00, 999	0.01			×	×	×	○
S11	Torque limit level 2 F41	20 to 200, 999	1	%	R/W	×	×	○	×	
	Torque limit value	-300.00 to 300.00, 999	0.01			×	×	×	○	
S12	Universal AO	Command issued to AO terminal through communications	-32768 to 32767 (Full scale: at +/- 20,000)	1	-	R/W	×	○	○	○
S13	PID command	PID command issued through communications	-32768 to 32767 (+/- 20000 corresponds to +/- 100%)	1	-	R/W	○	○	○	○

*1 Legends in R/W column...R: Readable, W: Write-enabled, R/W: Read/write possible

*2 ROM version which is older than 0800 is not applicable to FRENIC-Multi.

Code	Name	Function	Permissible setting range	Min. step	Unit	R/W *1	Support			
							Mini	Eco	Multi	MEGA
S14	Alarm reset command	Alarm reset command issued through communications	0 or 1	1	–	R/W	○	○	○	○
S19	Speed command	Speed command issued via communications	-32768 to 32767	1	r/min	R/W	×	×	×	○ *2

*1 Legends in R/W column...R: Readable, W: Write-enable, R/W: Read/write possible

*2 ROM version which is older than 0500 is not applicable to FRENIC-MEGA.

[2] Frequency and PID command data

Table 5.3 Function codes for frequency and PID command data

Code	Name	Function	Permissible setting range	Min. step	Unit	R/W *1
S01	Frequency reference (p.u.)	Frequency command via communications (value based on the maximum frequency)	-32768 to 32767 ($\pm 20,000 =$ maximum frequency)	1	–	R/W
S05	Frequency reference	Frequency command from communications (by 0.01Hz)	0.00 to 655.35	0.01	Hz	R/W
S13	PID command	PID command from communications	-32768 to 32767 ($\pm 100\%$ at $\pm 20,000$)	1	–	R/W
S19	Speed command	Speed command issued via communications	-32768 to 32767	1	r/min	R/W

*1 Legends in R/W column...R: Readable, W: Write-enable, R/W: Read/write possible

- 1) When both S01 and S05 are set and S01 is not 0, the command of S01 has precedence over that of S05. (All inverter models) When both S05 and S19 are specified and S05 is not 0, the S05 command takes precedence over the other command.
- 2) The actual operation specified by each command is limited by internal processing of the inverter. For example, a value over 20,000 can be written to S01, but the actual frequency is limited to the maximum frequency or to the upper limit frequency set with another function code. (The FRENIC-Mini/Eco treats negative data of S13 as 0.)
- 3) When an attempt is made to read the command data shown here, the data previously directed by communications, not the command value for actual operation, will be read. (Obtain the latest command value by reading the M code.)
- 4) At S01, set a value based on $\pm 20,000$ as the maximum frequency. For example, when the maximum frequency is 60Hz, set 20,000 at S01 with a set frequency of 60Hz, or 10,000 with a set frequency of 30Hz.

[3] Operation command data

Table 5.4 Function codes for operation command data

Code	Name	Function	Permissible setting range	Min. step	Unit	R/W *1
S06	Operation command	Operation command via communications (general-purpose input terminal functions (X1 – X9, XF (FWD), XR (REV)) and communications dedicated command (FWD, REV, RST))	0000 _H to FFFF _H	1	–	R/W
S14	Alarm reset command	Alarm reset command via communications	0 or 1	1	–	R/W

*1 Legends in R/W column...R: Readable, W: Write-enable, R/W: Read/write possible

- 1) To make alarm resetting with S06, bit 15 must be set to 1 and then set back to 0. Alarm resetting is impossible unless the communications side is made valid by the settings of function codes H30, y98, and y99 and the "LE" assigned terminal.
- 2) S14 does not require the operation described in 1) above, and writing 1 permits alarm resetting (because writing the value once turns ON the reset command that will be turned OFF after a specific period of time). This command is 0 whenever it is read, and is always valid, irrespective of function codes H30, y98, and y99 and the status of the "LE" assigned terminal.
- 3) X1 – X9, XF (FWD), and XR (REV) operate according to the functions set with function codes E01 – E09, E98, and E99.
General-purpose input terminals X4 and X5 and function codes E04 and E05 are not supported by FRENIC-Mini.
- 4) When giving operation command S06 via communications, the relation between S06 and the inverter terminal (external signal input) command is shown in Table 5.4 on the next page. The "Support" column of the table indicates whether each function is supported by the respective models or not. ○ indicates the function is supported, and × indicates the function is not supported.

 **WARNING**

If alarm resetting is performed with the operation command (S06) uncleared, the inverter will start to operate just upon alarm resetting. Before alarm resetting, confirm that the operation command is cleared.

Otherwise, an accident may result.

Table 5.5 Relation between operation command (S06) and inverter terminal command (external signal input)

Type	Function			When not assigned (positive logic)	Command		Support				
	Assignment number	Internal operation command symbol	Name		Com-Munic-A-tions *1	Terminal block	Mini	Eco	Multi	MEGA	
Fixed function	-	FWD	Forward operation/stop command	-	Valid	Invalid	○	○	○	○	
		REV	Reverse operation/stop command	-			○	○	○	○	
		RST	Alarm reset	-			○	○	○	○	
General-purpose input	0	SS1	Multistep frequency selection (0 to 1steps)	OFF	Valid	Invalid	○	○	○	○	
	1	SS2	Multistep frequency selection (0 to 3steps)	OFF			○	○	○	○	
	2	SS4	Multistep frequency selection (0 to 7steps)	OFF			○	○	○	○	
	3	SS8	Multistep frequency selection (0 to 15steps)	OFF			×	×	○	○	
	4	RT1	Acceleration/deceleration time selection (2steps)	OFF			○	×	○	○	
	5	RT2	Acceleration/deceleration time selection (4steps)	OFF			×	×	×	○	
	X1	6	HLD	3-wire operation stop command	OFF	Invalid		○	○	○	○
	X2	7	BX	Coast-to-stop command	OFF	Valid		○	○	○	○
	X3	8	RST	Alarm reset	OFF	Valid		○	○	○	○
	X4	9	THR	Trip command (External fault)	ON	Invalid	Valid	○	○	○	○
	X5	10	JOG	Jogging operation	OFF	Invalid		○	×	○	○
	X6	11	Hz2/Hz1	Frequency setting 2/1 switching command	OFF	Valid	Invalid	○	○	○	○
	X7	12	M2/M1	Motor 2 /motor 1	OFF	Valid	Invalid	×	×	○	×
	X8		M2	Motor selection 2	OFF	Valid	Invalid	×	×	×	○
	X9	13	DCBRK	DC braking command	OFF	Valid	Invalid	×	○	○	○
	XF (FWD)	14	TL2/TL1	Torque limit 2/torque limit 1	OFF			×	×	○	○
	XR (REV)	15	SW50	Switching to commercial power supply (50Hz)	OFF			×	○	×	○
	(Note)	16	SW60	Switching to commercial power supply (60Hz)	OFF			×	○	×	○
		17	UP	UP command	OFF	Invalid	Valid	×	○	○	○
		18	DOWN	DOWN command	OFF	Invalid	Valid	×	○	○	○
		19	WE-KP	Write enable for keypad	ON	Valid		○	○	○	○
		20	Hz/PID	PID control cancel	OFF	Valid	Invalid	○	○	○	○
		21	IVS	Normal/Inverse mode changeover	OFF			○	○	○	○
		22	IL	Interlock	OFF	Invalid	Valid	×	○	×	○
		24	LE	Link operation enable	ON			○	○	○	○
		25	U-DI	Universal DI	OFF			×	○	○	○
		26	STM	Start characteristic selection	ON			Valid		×	○
					OFF	Valid		×	×	○	○
		30	STOP	Forced stop	ON	Valid		×	○	○	○

(Note) X4 and X5 are not provided for FRENIC-Mini.

X6, X7, X8, and X9 are provided only for FRENIC-MEGA.

*1 When the command is given through the communications, negative logic setting is invalid.

Table 5.5 Relation between operation command (S06) and inverter terminal command (external signal input)
(Continued)

Type	Function			When not assigned (positive logic)	Command		Support				
	Assignment number	Internal operation command symbol	Name		Com-Munications *1	Terminal block	Mini	Eco	Multi	MEGA	
General-purpose input	32	EXITE	Preparatory excitation	OFF	Valid	Invalid	×	×	×	○	
	33	PID-RST	PID integration/differential reset	OFF	Valid	Invalid	○	○	○	○	
	34	PID-HLD	PID integration hold	OFF	Valid	Invalid	○	○	○	○	
	35	LOC	Local (keypad) command selection	OFF	Invalid	Valid	×	○	×	○	
	36	M3	Motor selection 3	OFF	Valid	Invalid	×	×	×	○	
	37	M4	Motor selection 4	OFF			×	×	×	○	
	38	RE	Run enable	ON	Valid	Invalid	×	○	×	×	
	39	DWP	Condensation protection	OFF			×	○	×	○	
	40	ISW50	Switching to commercial power supply incorporated sequence (50Hz)	OFF			×	○	×	○	
	41	ISW60	Switching to commercial power supply incorporated sequence (60Hz)	OFF			×	○	×	○	
	X1	42	LS	Zero limit switch			OFF	Invalid	Valid	×	×
	X2	43	S/R	Start/reset	OFF	×	×			○	×
	X3	44	SPRM	Serial pulse receive mode	OFF	×	×			○	×
	X4	45	RTN	Return mode	OFF	×	×			○	×
	X5	46	OLS	Overload stop valid command	OFF	Valid	Invalid	×	×	○	×
	X6	47	LOCK	Servo lock command	ON	Valid	Invalid	×	×	×	○
	X7	48	PIN	Pulse train input	OFF	Invalid	Valid	×	×	×	○
		49	SIGN	Pulse train sign	OFF	Invalid	Valid	×	×	×	○
	X8	72	CRUN-M1	Input during operation by commercial power (Motor 1)	OFF	Valid	Valid	×	×	×	○
X9	73	CRUN-M2	Input during operation by commercial power (Motor 2)	OFF	×			×	×	○	
XF (FWD)	74	CRUN-M3	Input during operation by commercial power (Motor 3)	OFF	×			×	×	○	
XR (REV)	75	CRUN-M4	Input during operation by commercial power (Motor 4)	OFF	×			×	×	○	
(Note)	76	DROOP	Droop selection	OFF	Valid	Invalid	×	×	×	○	
	77	PG-CCL	PG alarm cancel	OFF			×	×	×	○	
	87	FR2/FR1	Run command 2/run command 1	OFF	Valid	Invalid	×	○	×	×	
	88	FWD2	Forward run/stop command 2	OFF			×	○	×	×	
	89	REV2	Reverse run/stop command 2	OFF			×	○	×	×	
	98	FWD *2	Forward operation/stop command	OFF			○	○	○	○	
99	REV *2	Reverse operation/stop command	OFF	○	○	○	○				

(Note) X4 and X5 are not provided for FRENIC-Mini.

X6, X7, X8, and X9 are provided only for FRENIC-MEGA.

*1 When the command is given through the communications, negative logic setting is invalid.

*2 Terminals FWD/REV only

[4] Function data

Table 5.6 Function code and data (S08, S09, S10, S11)

Code	Name	Function	Permissible setting range	Min. step	Unit	R/W *1
S08	Acceleration time F07	Set data with common code numbers and in common communications formats to models.	Mini/Eco/Multi: 0.0 to 3600.0 MEGA: 0.0 to 6000.0	0.1	s	R/W
S09	Deceleration time F08		Mini/Eco/Multi: 0.0 to 3600.0 MEGA: 0.0 to 6000.0	0.1	s	R/W
S10	Torque limit level 1 F40 (MEGA: torque limit value 1-1)		Multi: 20 to 200, 999	1	%	R/W
			MEGA: -300.00 to 300.00, 999	0.01	%	
S11	Torque limit level 2 F41 (MEGA: torque limit value 1-2)	Multi: 20 to 200, 999	1	%	R/W	
		MEGA: -300.00 to 300.00, 999	0.01	%		

*1 Legends in R/W column...R: Readable, W: Write-enable, R/W: Read/write possible

- 1) When an attempt is made to enter a value out of the appropriate permissible setting range, an out-of-range error will result.
- 2) The acceleration/deceleration times specified with S08, S09 are set to F07 (Acceleration time 1) and F08 (Deceleration time 1). The torque limit levels specified with S10 and S11 are set to F40 (Torque limit level 1 for driving, Torque limit 1-1 for MEGA) and F41 (Torque limit level 1 for controlling, Torque limit 1-2 for MEGA). If the function codes are changed through the keypad, etc., the changes are also reflected to S08 to S11.
- 3) The figures below the fourth place figure of the S08 acceleration time and the S09 deceleration time are omitted within the inverter. (If, for example, 123.4s is written, 123.0s is entered.)

[5] Universal DO and universal AO

(Not supported by FRENIC-Mini)

Table 5.7 Function code and data (S07, S12)

Code	Name	Function	Permissible setting range	Min. step	Unit	R/W *1
S07	Universal DO	Command from communications function to terminal DO	0000 _H to FFFF _H	1	–	R/W
S12	Universal AO	Command from communications function to terminal AO	-32768 to 32767 (Full scale by ±20000)	1	–	R/W

*1 Legends in R/W column...R: Readable, W: Write-enable, R/W: Read/write possible

- 1) A host can control the output terminal of the inverter through the communications function to issue commands to peripheral devices.
- 2) When universal DO and universal AO are assigned to the following signals, the signals operate as simple output regardless of inverter's operation.
Universal DO: Transistor output (Y1, Y2, Y3, Y4), relay output (Y5A/C, 30A/B/C)
Universal AO: Analog output (FMA), pulse output (FMP)

5.1.3 Monitor data 1

Function codes for monitor data 1 (M codes) are described in the four tables (1 to 4) below. These function codes are for reading only.

These function codes are for reading only. The "Support" column of the table indicates whether each function is supported by the respective models or not. ○ indicates the function is supported, and × indicates the function is not supported.

Table 5.8 Monitor data 1 function codes (1)

Code	Name	Description	Monitor range	Min. step	Unit	Support			
						Mini	Eco	Multi	MEGA
M01	Frequency reference (p.u.) (Final command)	Frequency command based on the maximum frequency	-32768 to 32767 (±20,000 = maximum frequency)	1	–	○	○	○	○
M02	Torque command (Final command)	Torque command based on the motor rated torque (100%)	-327.68 to 327.67	0.01	%	×	×	×	○
M03	Torque current command (Final command)	Torque current command based on the motor rated torque current (100%)	-327.68 to 327.67	0.01	%	×	×	×	○
M04	Flux command	Flux command based on the rated motor flux (100%)	-327.68 to 327.67	0.01	%	×	×	×	○
M05	Frequency reference (Final command)	Frequency command with min. step 0.01Hz	0.00 to 655.35	0.01	Hz	○	○	○	○
M06	Output frequency 1 (p.u.)	Output frequency based on the maximum frequency (before slip compensation)	-32768 to 32767 (±20,000 = maximum frequency)	1	–	○	○	○	○
M07	Torque real value	Motor output torque based on the motor's rated torque (100%)	-327.68 to 327.67	0.01	%	×	○	○	○
M08	Torque current	Torque current based on the rated torque current of the motor (100%)	-327.68 to 327.67	0.01	%	×	×	×	○
M09	Output frequency	Output frequency with min. step 0.01Hz	FGI: -655.35 to 655.35 RTU: 0.00 to 655.35	0.01	Hz	○	○	○	○
M10	Input power	Power consumption value based on the "nominal applicable motor output" (100%)	0.00 to 399.99	0.01	%	○	○	○	○
M11	Output current effective value	Output current effective value based on the inverter rated current	0.00 to 399.99 (100% = inverter rated current)	0.01	%	○	○	○	○
M12	Output voltage effective value	Output voltage effective value (min. step: 1.0V)	0.0 to 1000.0	0.1 *1	V	○	○	○	○

*1 Since M12 does not have any data after the decimal point, the minimum step is 1.0.

Table 5.9 Monitor data 1 function codes (2)

Code	Name	Description	Monitor range	Min. step	Unit	Support			
						Mini	Eco	Multi	MEGA
M13	Operation command (Final command)	Displays the final command created by information from the keypad, terminal block, and communications, and transmitted to the inverter inside.	0000 _H to FFFF _H	1	–	○	○	○	○
M14	Operation status	Displays the operation status in bit signal.	0000 _H to FFFF _H	1	–	○	○	○	○
M15	General-purpose output terminal information	General-purpose output terminal information is monitored.	0000 _H to FFFF _H	1	–	○	○	○	○
M16	Latest alarm contents	Display alarm contents in the form of code.	0 to 127	1	–	○	○	○	○
M17	Last alarm contents								
M18	Second last alarm contents								
M19	Third last alarm contents								
M20	Cumulative operation time	–	0 to 65535	1	h	○	○	○	○
M21	DC link circuit voltage	Displays the DC link circuit voltage of the inverter.	0 to 1000	1	V	○	○	○	○
M22	Motor temperature	Motor temperature is displayed.	-30 to 200	1	°C	×	×	×	○
M23	Model code	Displays the series, generation, model, and voltage series in four-digit HEX data.	0000 _H to FFFF _H	1	–	○	○	○	○
M24	Capacity code	Displays the capacity of the inverter.	0 to 65535	1	–	○	○	○	○
M25	ROM version	Displays the ROM version used in the inverter.	0 to 9999	1	–	○	○	○	○
M26	Transmission error transaction code	Communications error code of RS-485	0 to 127	1	–	○	○	○	○
M27	Frequency reference on alarm (p.u.) (Final command)	Data equivalent to M01 on alarm	-32768 to 32767 (±20,000 = maximum frequency)	1	–	○	○	○	○

Table 5.10 Monitor data 1 function codes (3)

Code	Name	Description	Monitor range	Min. step	Unit	Support			
						Mini	Eco	Multi	MEGA
M28	Torque command on alarm (Final command)	Data equivalent to M02 on alarm	-327.68 to 327.67	0.01	%	×	×	×	○
M29	Torque current command on alarm (Final command)	Data equivalent to M03 on alarm	-327.68 to 327.67	0.01	%	×	×	×	○
M30	Flux command on alarm (Final command)	Data equivalent to M04 on alarm	-327.68 to 327.67	0.01	%	×	×	×	○
M31	Frequency reference on alarm (Final command)	Data equivalent to M05 on alarm	0.00 to 655.35	0.01	Hz	○	○	○	○
M32	Output frequency 1 on alarm (p.u.)	Data equivalent to M06 on alarm	-32768 to 32767 (±20,000 = maximum frequency)	1	–	○	○	○	○
M33	Torque real value on alarm	Data equivalent to M07 on alarm	-327.68 to 327.67	0.01	%	×	○	○	○
M34	Torque current on alarm	Data equivalent to M08 on alarm	-327.68 to 327.67	0.01	%	×	×	×	○
M35	Output frequency on alarm	Data equivalent to M09 on alarm	FGI: -655.35 to 655.35 RTU: 0.00 to 655.35	0.01	Hz	○	○	○	○
M36	Input power on alarm	Data equivalent to M10 on alarm	0.00 to 399.99	0.01	%	○	○	○	○
M37	Output current effective value on alarm	Data equivalent to M11 on alarm	0.00 to 399.99 (100% = inverter rated current)	0.01	%	○	○	○	○
M38	Output voltage effective value on alarm	Data equivalent to M12 on alarm	0.0 to 1000.0	1.0	V	○	○	○	○
M39	Operation command on alarm	Data equivalent to M13 on alarm	0000 _H to FFFF _H	–	–	○	○	○	○
M40	Operation status on alarm	Data equivalent to M14 on alarm	0000 _H to FFFF _H	–	–	○	○	○	○
M41	Output terminal information on alarm	Data equivalent to M15 on alarm	0000 _H to FFFF _H	–	–	○	○	○	○
M42	Cumulative operation time on alarm	Data equivalent to M20 on alarm	0 to 65535	1	h	○	○	○	○

Table 5.11 Monitor data 1 function codes (4)

Code	Name	Description	Monitor range	Min. step	Unit	Support			
						Mini	Eco	Multi	MEGA
M43	DC link circuit voltage on alarm	Data equivalent to M21 on alarm	0 to 1000	1	V	○	○	○	○
M44	Inverter internal air temperature on alarm	Air temperature inside the inverter on alarm	0 to 255	1	°C	×	○	×	○
M45	Heat sink temperature on alarm	Data equivalent to M62 on alarm	0 to 255	1	°C	○	○	○	○
M46	Life of main circuit capacitor	The capacity of the main circuit capacitor is 100% when delivered from the factory	0.0 to 100.0	0.1	%	○	○	○	○
M47	Life of PC board electrolytic capacitor	Cumulative operation time of the capacitor packaged on the PC board	0 to 65535 *1	1	h	○	○	○	○
M48	Life of heat sink	Cumulative operation time of the heat sink	0 to 65535 *1	1	h	○	○	○	○
M49	Input terminal voltage [12] (p.u.)	Input voltage of terminal [12] (-20,000/-10V, 20,000/10V)	-32768 to 32767	1	-	○	○	○	○
M50	Input terminal current [C1] (p.u.)	Input current of terminal [C1] (0/0mA, 20,000/20mA)	0 to 32767	1	-	○	○	○	○
M52	Input terminal voltage [32]	Input voltage of terminal [32] (-20,000/-10V, 20,000/10V)	-32768 to 32767	1	-	×	×	×	○
M53	Input terminal current [C2]	Input current of terminal [C2] (0/0mA, 20,000/20mA)	0 to 32767	1	-	×	×	×	○
M54	Input terminal voltage [V2] (p.u.)	Input voltage of terminal [V2] (-20000/10V to 20000/10V)	-32768 to 32767	1	-	×	○	○	○
M61	Inverter internal air temperature	Current temperature inside the inverter	0 to 255	1	°C	×	○	×	○
M62	Heat sink temperature	Current temperature of the heat sink within the inverter	0 to 255	1	°C	○	○	○	○
M63	Load factor	Load rate based on the motor rating	-327.68 to 327.67	0.01	%	×	○	○	○
M64	Motor output	Motor output based on the motor's rated output (kW)	-327.68 to 327.67	0.01	%	×	○	○	○

*1 For FRENIC-Multi/MEGA, even if each of the accumulated operation time exceeds 65535 hours, the data at M47 and M48 remains 65535 hours. In that case, use W67, W68 to be monitored in units of 10 hours.

Table 5.12 Monitor data 1 function codes (5)

Code	Name	Description	Monitor range	Min. step	Unit	Support			
						Mini	Eco	Multi	MEGA
M65	Motor output on alarm	Data equivalent to M64 on alarm	-327.68 to 327.67	0.01	%	×	○	○	○
M66	Speed detection	Detected speed	-327.68 to 327.67	1	—	×	×	×	○
M67	Transmission error processing code	Error processing code for data transfer	0 to 127	—	—	×	×	×	○
M68	PID final command	±20000/±100%	-32768 to 32767	1	—	○	○	○	○
M69	Inverter rated current	FGI	0.00 to 9999	Variable	A	○	○	○	○
		RTU (inverter capacity 22kW (30HP) or less)	0.00 to 655.35	0.01	A	○	○	○	○
		RTU (inverter capacity 30kW (40HP) or more)	0.0 to 6553.5	0.1	A	×	○	—	○
M70	Operation status 2	Displays the operation status in the form of a bit signal.	0000H to FFFFH	1	—	○	○	○	○
M71	Input terminal information	Operation command information from the terminal block and communications	0000H to FFFFH	1	—	○	○	○	○
M72	PID feedback value	PID feedback based on 100% of analog input (±20000/100%)	-32768 to 32767	1	—	×	○	○	○
M73	PID output	PID output based on the maximum frequency (F03) (±20000/100%)	-32768 to 32767	1	—	×	○	○	○
M74	Operating status 2	Displays the operation status in the form of a bit signal.	0000H to FFFFH	1	—	×	×	×	○
M76	Main circuit capacitor life (elapsed time)	Main circuit capacitor use time	0 to 65535 (in units of 10 hours)	1	10h	×	×	×	○
M77	Main circuit capacitor life (remaining time)	Main circuit capacitor remaining life	0 to 65535 (in units of 10 hours)	1	10h	×	×	×	○
M81	Remaining time before maintenance (M1)	Time before the next maintenance	0 to 65535 (in units of 10 hours)	1	10h	×	×	×	○
M85	No. of starting times before maintenance (M1)	Allowable starting times before the next maintenance	0 to 65535	1	Times	×	×	×	○
M86	Light alarm (latest)	Latest light alarm indicated with a code	0 to 254	1	—	×	×	×	○

Table 5.13 Monitor data 1 function codes (6)

Code	Name	Description	Monitor range	Min. step	Unit	Support			
						Mini	Eco	Multi	MEG A
M87	Light alarm (last)	Last light alarm indicated with a code	0 to 254	1	–	×	×	×	○
M88	Light alarm (second last)	Second last light alarm indicated with a code	0 to 254	1	–	×	×	×	○
M89	Light alarm (third last)	Third last light alarm indicated with a code	0 to 254	1	–	×	×	×	○

5.1.4 Information displayed on the keypad

The function codes used to read, via RS-485, information displayed on the keypad are classified into W codes, X codes, and Z codes. All of these function codes are for read only.

The function codes shown in Tables 5.14 to 5.16 correspond to the menu numbers displayed on the LEDs on the keypad shown in the "LED display" field. The "Support" column of the table indicates whether each function is supported by the respective models or not. ○ indicates the function is supported, and × indicates the function is not supported.

For details about the keypad display, see "Chapter 3 OPERATION USING THE KEYPAD" in the instruction manual of each inverter type.

RTU and FGI in the Remarks field represent the Modbus RTU protocol and the Fuji general-purpose inverter protocol, respectively.

Table 5.14 Keypad-related function code (W codes)

Code	Name	Monitor range	Min step	Unit	LED display	Support				Remarks
						Mini	Eco	Multi	MEGA	
W01	Operation status	0000H to FFFFH	1	–	3_07	○	○	○	○	
W02	Frequency reference	0.00 to 655.35	0.01	Hz	3_05	○	○	○	○	
W03	Output frequency (before slip compensation)	0.00 to 655.35	0.01	Hz	3_00	○	○	○	○	
W04	Output frequency (after slip compensation)	0.00 to 655.35	0.01	Hz	3_01	○	×	○	○	
W05	Output current	0.00 to 9999	Variable	A	3_02	○	○	○	○	FGI RTU (inverter capacity 22kW (30HP) or less)
		0.00 to 655.35	0.01	A	3_02	○	○	○	○	
		0.0 to 6553.5	0.1	A	3_02	×	○	–	○	RTU (inverter capacity 30kW (40HP) or more)
W06	Output voltage	0.0 to 1000.0	0.1	V	3_03	○	○	○	○	
W07	Torque	-999 to 999	1	%	3_04	×	○	○	○	
W08	Rotation speed	0.00 to 99990	Variable	r/min	3_08	×	○	○	○	
W09	Load rotation speed	0.00 to 99990	Variable	r/min	3_09	○	○	○	○	
W10	Line speed	0.00 to 99990	Variable	m/min	3_09	○	×	○	○	
W11	PID process command	-999 to 9990	Variable	–	3_10	○	○	○	○	PID command value or PID feedback value converted to the physical quantity of the control target by E40 and E41
W12	PID feedback value	-999 to 9990	Variable	–	3_11	○	○	○	○	
W13	Level of torque value A	0 to 1000	1	%	3_12	×	×	○	○	
W14	Level of torque value B	0 to 1000	1	%	3_13	×	×	○	○	
W15	Ratio value	0.00 to 655.35	0.01	%	3_14	×	×	×	○	
W16	Rotation speed set value	0.00 to 99990	Variable	r/min	Speed monitor (Set with E43 or E48)	×	○	○	○	
W17	Load speed set value	0.00 to 99990	Variable	r/min		○	○	○	○	
W18	Line speed set value	0.00 to 99990	Variable	r/min		○	×	○	○	
W19	Constant feed time set value	0.00 to 999.9	Variable	min		○	×	○	×	
W20	Constant feed time	0.00 to 999.9	Variable	min	○	×	○	×		
W21	Input power	0.00 to 9999	Variable	kW	Operation status monitor (Set with E43)	○	○	○	○	
W22	Motor output	0.00 to 9999	Variable	kW		×	○	○	○	
W23	Load rate	-999 to 999	1	%		×	○	○	○	
W24	Torque current	-999 to 999	1	%		×	×	×	○	
W26	Flux command value	-999 to 999	1	%	3_22	×	×	×	○	
W27	Timer operation remaining time	0 to 9999	1	s	Operation status monitor (Set with E43)	○	×	○	×	

Table 5.14 Keypad-related function code (W codes) (Continued)

Code	Name	Monitor range	Min step	Unit	LED display	Support				Remarks
						Mini	Eco	Multi	MEGA	
W28	Operation command source	0 to 23	1	–	–	○	○	○	○	*1
W29	Frequency and PID command source	0 to 36	1	–	–	○	○	○	○	*2
W30	Speed set value at percentage	0.00 to 100.00	0.01	%	Speed monitor (Set with E43 or E48)	×	○	○	○	
W31	Speed set value at percentage	0.00 to 100.00	0.01	%		×	○	○	○	
W32	PID output	0 to 150.0	0.1	%	Operation status monitor (Set with E43)	×	○	○	○	PID output expressed by a percentage with setting the maximum frequency (F03) to 100%
W33	Analog input monitor	-999 to 9990	Variable	–		×	○	×	○	Inverter's analog input converted by E40 and E41

*1 Operation command source code

Indicates the current source of operation commands.

Code	Description	Mini	Eco	Multi	MEGA
0	Run by the keypad (rotation direction: depends on the terminal input)	○	○	○	○
1	Run by the terminals	○	○	○	○
2	Run by the keypad (forward rotation)	○	○	○	○
3	Run by the keypad (reverse rotation)	○	○	○	○
4	Run command 2 (when FR2/FR1 is ON)	×	○	×	×
20	Port 1 (RS-485 channel 1) (Note)	○	○	○	○
21	Port 2 (RS-485 channel 2) (Note)	×	○	○	○
22	Bus option	×	○	○	○
23	Loader	×	○	○	○

For FRENIC-Mini, this code is 20 when operation commands from the loader are effective.

*2 Frequency command source/PID command source code

Code	Description	Mini	Eco	Multi	MEGA
0	Keypad key operations	○	○	○	○
1	Voltage input (terminal 12)	○	○	○	○
2	Current input (terminal C1)	○	○	○	○
3	Voltage input (terminal 12) + current input (terminal C1)	○	○	○	○
4	Inverter volume	○	×	×	×
5	Voltage input (terminal V2)	×	○	○	○
7	UP/DOWN	×	○	○	○
20	Port 1 (RS-485 channel 1) (Note)	○	○	○	○
21	Port 2 (RS-485 channel 2) (Note)	×	○	○	○
22	Bus option	×	○	○	○
23	Loader (20 for FRENIC-Mini)	×	○	○	○
24	Multi-step frequency	×	○	○	○
30	PID keypad command	×	○	○	○
31	PID analog command 1	×	○	○	○
33	PID UP/DOWN command	×	○	○	○
34	PID communications process command	×	○	○	○
36	PID multi-step command	×	○	○	○

FRENIC-Mini : Indicates a frequency command source even if PID is effective.

This code is 20 when the frequency command from the loader is effective.

FRENIC-Eco/Multi/MEGA : Indicates a PID command source if PID is effective
(code 30 or later).

Indicates a frequency command source if PID is not effective
(code 29 or less).

(Note) RS-485 port (channel)

	FRENIC-Mini	FRENIC-Eco/Multi	FRENIC-MEGA
Port 1 (channel 1)	RS-485 communications card (option)	Keypad connection connector on the inverter	Keypad connection connector on the inverter
Port 2 (channel 2)	–	RS-485 communications card (option)	Terminal base for the inverter control circuit

Table 5.14 Keypad-related function code (W codes) (Continued)

Code	Name	Monitor range	Min step	Unit	LED display	Support				Remarks
						Mini	Eco	Multi	MEGA	
W35	Terminal [32] input voltage	-12.0 to 12.0	0.1	V	4_20	×	×	×	○	
W36	Terminal [C2] input current	0.0 to 30.0	0.1	mA	4_21	×	×	×	○	
W37	Terminal [A0] output voltage	-12.0 to 12.0	0.1	V	4_22	×	×	×	○	
W38	Terminal [CS] output current	0.0 to 30.0	0.1	mA	4_23	×	×	×	○	
W39	[X7] pulse input monitor	-327.68 to 327.67	0.01	–	4_11	×	×	×	○	Unit: kp/s
W40	Control circuit terminal (input)	0000 _H to FFFF _H	1	–	4_00	○	○	○	○	
W42	Communications control signal (input)	0000 _H to FFFF _H	1	–	4_01	○	○	○	○	
W43	Communications control signal (output)	0000 _H to FFFF _H	1	–	4_01	○	○	○	○	
W44	Terminal [12] input voltage	0.0 to 12.0	0.1	V	4_02	○	○	○	○	
W45	Terminal [C1] input current	0.0 to 30.0	0.1	mA	4_03	○	○	○	○	
W46	FMA*1 output voltage	0.0 to 12.0	0.1	V	4_04	○	○	○	○	
W47	FMP*1 output voltage	0.0 to 12.0	0.1	V	4_05	×	○	×	○	
W48*2	FMP output frequency	0 to 6000	1	p/s	4_06	×	○	○	○	The output pulse rate of terminal FMP expressed by (p/s)
W49	V2 terminal input voltage	0.0 to 12.0	0.1	V	4_07	×	○	○	○	
W50	FMA*1 output current	0.0 to 30.0	0.1	mA	4_08	×	○	×	○	
W51	Situation of input terminals on DIO option	0000 _H to FFFF _H	1	–	4_10	×	×	○	○	
W52	Situation of output terminals on DIO option	0000 _H to FFFF _H	1	–	4_10	×	×	○	○	
W53	Pulse input (Master - side A/B phase)	-327.68 to 327.67	0.01	–	4_15	×	×	○	○	Unit: kp/s
W54	Pulse input (Master - side Z phase)	0 to 6000	1	p/s	4_15	×	×	○	○	
W55	Pulse input(Slave - side A/B phase)	-327.68 to 327.67	0.01	–	4_17	×	×	○	○	Unit: kp/s
W56	Pulse input(Slave - side Z phase)	0 to 6000	1	p/s	4_18	×	×	○	○	
W57	Current Position Pulse(Upper column)	-999 to 999	1	–	3_18	×	×	○	×	
W58	Current Position Pulse(Lower column)	0 to 9999	1	–	3_18	×	×	○	×	
W59	Stop Position Pulse(Upper column)	-999 to 999	1	–	3_17	×	×	○	×	

*1 As for FRN□□G1□-□A and FRN□□G1□-□E, the terminal name changes from FMA to FM1 and FMP to FM2 respectively.

*2 Not applicable with FRN□□G1□-□A and FRN□□G1□-□E

Table 5.14 Keypad-related function code (W codes) (Continued)

Code	Name	Monitor range	Min step	Unit	LED display	Support				Remarks
						Mini	Eco	Multi	MEGA	
W60	Stop Position Pulse(Lower column)	0 to 9999	1	-	3.17	×	×	○	×	
W61	Difference Pulse of Position(Upper column)	-999 to 999	1	-	3.19	×	×	○	×	
W62	Difference Pulse of Position(Lower column)	0 to 9999	1	-	3.19	×	×	○	×	
W63	Positioning Status	0 to 10	1	-	3.20	×	×	○	×	
W65	Terminal [FM1] output current	0.0 to 30.0	0.1	mA	4.09	×	○*1	×	×	
	Terminal [FM2] output current	0.0 to 30.0	0.1	mA	4.09	×	×	×	○*2	
W67	Cumulative operation time of electrolytic	0 to 9999	1	10h	5.06	×	×	○	○	
W68	Cumulative operation time of cooling fan	0 to 9999	1	10h	5.07	×	×	○	○	
W70	Cumulative operation time	0 to 65535	1	h	5.00	○	○	○	○	
W71	DC link circuit voltage	0 to 1000	1	V	5.01	○	○	○	○	
W72	Internal air highest temperature	0 to 255	1	°C	5.02	×	○	×	○	
W73	Heat sink maximum temperature	0 to 255	1	°C	5.03	○	○	○	○	
W74	Maximum effective current value	0.00 to 9999	Variable	A	5.04	○	○	○	○	FGI
		0.00 to 655.35	0.01	A	5.04	○	○	○	○	URT (inverter capacity 22 kW (30 HP) or less
		0.0 to 6553.5	0.0	A	5.04	×	○	-	○	URT (inverter capacity 30 kW (40 HP) or less
W75	Main circuit capacitor's capacitor	0.0 to 100.0	0.1	%	5.05	○	○	○	○	
W76	Cumulative ope. time of capacitor on PC board	0 to 65535	1	h	5.06	○	○	○	×	
W77	Cumulative ope. time of cooling fan	0 to 65535	1	h	5.07	○	○	○	×	
W78	Number of startups	0 to 65535	1	Times	5.08	○	○	○	○	
W79	Cumulative ope. time of motor	0 to 65535	1	h	5.23	×	○	○	×	
W80	Standard fan life	0 to 65535	1	h	-	×	○	×	×	
W81	Integrating electric power	0.000 to 9999	Variable	-	5.09	×	○	○	○	Value calculated by assuming an integral power consumption of 100kWh as one (100kWh when W81=1)

*1 Applicable only with FRN□□F1□-□A, FRN□□F1□-□E and FRN□□F1□-□U

*2 Applicable only with FRN□□G1□-□A, and FRN□□G1□-□E

Table 5.14 Keypad-related function code (W codes) (Continued)

Code	Name	Monitor range	Min step	Unit	LED display	Support				Remarks
						Mini	Eco	Multi	MEGA	
W82	Data used integrating electric power	0.000 to 9999	Variable	-	5_10	×	○	○	○	Value calculated as integral power consumption (kWh) multiplied by function code E51
W83	Number of RS485 ch1 errors	0 to 9999	1	Times	5_11	○	○	○	○	Mini: optional
W84	Contents of RS485 ch1 error	0 to 127	1	-	5_12	○	○	○	○	
W85	Number of RS485 ch2 errors	0 to 9999	1	Times	5_17	×	○	○	○	
W86	Number of option communications errors	0 to 9999	1	Times	5_41	×	×	×	○	
W87	Inverter's ROM version	0 to 9999	1	-	5_14	○	○	○	○	
W89	Remote keypad's ROM version	0 to 9999	1	-	5_16	○	○	○	○	
W90	Option1 ROM version	0 to 9999	1	-	5_19	×	○	○	○	
W91	Option2 ROM version	0 to 9999	1	-	5_20	×	×	×	○	
W92	Option3 ROM version	0 to 9999	1	-	5_21	×	×	×	○	
W94	Contents of RS485 ch2 error	0 to 127	1	-	5_18	×	○	○	○	
W95	Number of option communications errors	0 to 9999	1	Times	5_13	×	○	○	×	
	Option 1 (A-port) No. of communications errors					×	×	×	○	
W96	Content of option communications error	0 to 9999	1	-	-	×	○	○	×	*1
	Option 1 (A-port) communications error content				5_40	×	×	×	○	
W97	Option communicate error contents	0 to 9999	1	-	5_42	×	×	×	○	*1
W98	Number of option communications errors	0 to 9999	1	Times	5_43	×	×	×	○	
W99	Option communicate error contents	0 to 9999	1	-	5_44	×	×	×	○	*1

*1 Indicates the content of a communications error between the inverter and an option card. For details, see the manual of each option.

Table 5.15 Keypad-related function codes (X codes)

Code	Name	Monitor range	Min step	Unit	LED display	Support				Remarks
						Mini	Eco	Multi	MEGA	
X00	Alarm history (latest)	0000 _H to FFFF _H	1	–	E _{PL}	○	○	○	○	Contents of 1 in alarm list (example: 1.OL1)
X01	Multiple alarm 1 (latest)	0000 _H to FFFF _H	1	–	E ₁₅	○	○	○	○	
X02	Multiple alarm 2 (latest)	0000 _H to FFFF _H	1	–	E ₁₇	○	○	○	○	
X03	Sub code	0 to 9999	1	–	E ₂₁	×	○	○	○	
X05	Alarm history (last)	0000 _H to FFFF _H	1	–	E _{PL}	○	○	○	○	Contents of 2 in alarm list (example: 2.OL1)
X06	Multiple alarm 1 (last)	0000 _H to FFFF _H	1	–	E ₁₅	○	○	○	○	
X07	Multiple alarm 2 (last)	0000 _H to FFFF _H	1	–	E ₁₇	○	○	○	○	
X08	Sub code	0 to 9999	1	–	E ₂₁	×	○	○	○	
X10	Alarm history (second last)	0000 _H to FFFF _H	1	–	E _{PL}	○	○	○	○	Contents of 3 in alarm list (example: 3.OL1)
X11	Multiple alarm 1 (second last)	0000 _H to FFFF _H	1	–	E ₁₅	○	○	○	○	
X12	Multiple alarm 2 (second last)	0000 _H to FFFF _H	1	–	E ₁₇	○	○	○	○	
X13	Sub code	0 to 9999	1	–	E ₂₁	×	○	○	○	
X15	Alarm history (third last)	0000 _H to FFFF _H	1	–	E _{PL}	○	○	○	○	Contents of 4 in alarm list (example: 4.LL1)
X16	Multiple alarm 1 (third last)	0000 _H to FFFF _H	1	–	E ₁₅	○	○	○	○	
X17	Multiple alarm 2 (third last)	0000 _H to FFFF _H	1	–	E ₁₇	○	○	○	○	
X18	Sub code	0 to 9999	1	–	E ₂₁	×	○	○	○	
X20	Latest info. on alarm (output frequency)	0.00 to 655.35	0.01	Hz	E ₀₀	○	○	○	○	
X21	(output current)	0.00 to 9999	Variable	A	E ₀₁	○	○	○	○	FGI
		0.00 to 655.35	0.01	A	E ₀₁	○	○	○	○	RTU (inverter capacity 22kW (30HP) or less)
		0.0 to 5000.0	0.1	A	E ₀₁	×	○	–	○	RTU (inverter capacity 30kW (40HP) or more)
X22	(output voltage)	0 to 1000	1	V	E ₀₂	○	○	○	○	
X23	(Torque)	-999 to 999	1	%	E ₀₃	×	○	○	○	
X24	(set frequency)	0.00 to 655.35	0.01	Hz	E ₀₄	○	○	○	○	
X25	(operation status)	0000 _H to FFFF _H	1	–	E ₀₅	○	○	○	○	
X26	(cumulative ope. time)	0 to 65535	1	h	E ₀₇	○	○	○	○	
X27	(number of startups)	0 to 65535	1	Times	E ₀₈	○	○	○	○	
X28	(DC link circuit voltage)	0 to 1000	1	V	E ₀₉	○	○	○	○	

Table 5.15 Keypad-related function codes (X codes) (Continued)

Code	Name	Monitor range	Min step	Unit	LED display	Support				Remarks
						Mini	Eco	Multi	MEGA	
X29	(internal air temperature)	0 to 255	1	°C	5_10	×	○	×	○	
X30	(heat sink temperature)	0 to 255	1	°C	5_11	○	○	○	○	
X31	(input terminal)	0000 _H to FFFF _H	1	–	5_12 5_13	○	○	○	○	
X32	(output terminal)	0000 _H to FFFF _H	1	–	5_12 5_14	○	○	○	○	
X33	(input terminal(com.))	0000 _H to FFFF _H	1	–	5_18 5_19	○	○	○	○	
X34	(output terminal(com.))	0000 _H to FFFF _H	1	–	5_18 5_20	○	○	○	○	
X35	Latest info. on alarm (Input power)	0.00 to 9999	0.01	kW	–	×	○	○	○	
X36	(operation status)	0000 _H to FFFF _H	1	–	5_22	×	×	×	○	
X37	(speed detection)	-32768 to 32767	1	–	5_23	×	×	×	○	
X60	Last info. on alarm (output frequency)	0.00 to 655.35	0.01	Hz	5_00	○	○	○	○	
X61	(output current)	0.00 to 9999	Variable	A	5_01	○	○	○	○	FGI
		0.00 to 655.35	0.01	A	5_01	○	○	○	○	RTU (inverter capacity 22kW (30HP) or less)
		0.0 to 5000.0	0.1	A	5_01	×	○	–	○	RTU (inverter capacity 30kW (40HP) or more)
X62	(output voltage)	0 to 1000	1	V	5_02	○	○	○	○	
X63	(Torque)	-999 to 999	1	%	5_03	×	○	○	○	
X64	(set frequency)	0.00 to 655.35	0.01	Hz	5_04	○	○	○	○	
X65	(operation status)	0000 _H to FFFF _H	1	–	5_05	○	○	○	○	
X66	(cumulative ope. time)	0 to 65535	1	h	5_07	○	○	○	○	
X67	(number of startups)	0 to 65535	1	Times	5_08	○	○	○	○	
X68	(DC link circuit voltage)	0 to 1000	1	V	5_09	○	○	○	○	
X69	(internal air temperature)	0 to 255	1	°C	5_10	×	○	×	○	
X70	(heat sink temperature)	0 to 255	1	°C	5_11	○	○	○	○	
X71	(input terminal)	0000 _H to FFFF _H	1	–	5_12 5_13	○	○	○	○	
X72	(output terminal)	0000 _H to FFFF _H	1	–	5_12 5_14	○	○	○	○	
X73	(input terminal(com.))	0000 _H to FFFF _H	1	–	5_18 5_19	○	○	○	○	
X74	(output terminal(com.))	0000 _H to FFFF _H	1	–	5_18 5_20	○	○	○	○	
X76	(operation status)	0000 _H to FFFF _H	1	–	5_22	×	×	×	○	
X77	(speed detection)	-32768 to 32767	1	–	5_23	×	×	×	○	

Table 5.16 Keypad-related function codes (Z codes)

Code	Name	Monitor range	Min step	Unit	LED display	Support				Remarks
						Mini	Eco	Multi	MEGA	
Z00	Second last info. on alarm (output frequency)	0.00 to 655.35	0.01	Hz	<i>5.00</i>	○	○	○	○	
Z01	(output current)	0.00 to 9999	Variable	A	<i>5.01</i>	○	○	○	○	FGI
		0.00 to 655.35	0.01	A	<i>5.01</i>	○	○	○	○	RTU (inverter capacity 22kW (30HP) or less)
		0.0 to 5000.0	0.1	A	<i>5.01</i>	×	○	–	○	RTU (inverter capacity 30kW (40HP) or more)
Z02	(output voltage)	0 to 1000	1	V	<i>5.02</i>	○	○	○	○	
Z03	(Torque)	-999 to 999	1	%	<i>5.03</i>	×	○	○	○	
Z04	(set frequency)	0.00 to 655.35	0.01	Hz	<i>5.04</i>	○	○	○	○	
Z05	(operation status)	0000 _H to FFFF _H	1	–	<i>5.06</i>	○	○	○	○	
Z06	(cumulative ope. time)	0 to 65535	1	h	<i>5.07</i>	○	○	○	○	
Z07	(number of startups)	0 to 65535	1	Times	<i>5.08</i>	○	○	○	○	
Z08	(DC link circuit voltage)	0 to 1000	1	V	<i>5.09</i>	○	○	○	○	
Z09	(internal air temperature)	0 to 255	1	°C	<i>5.10</i>	×	○	×	○	
Z10	(heat sink temperature)	0 to 255	1	°C	<i>5.11</i>	○	○	○	○	
Z11	(input terminal)	0000 _H to FFFF _H	1	–	<i>5.12</i> <i>5.13</i>	○	○	○	○	
Z12	(output terminal)	0000 _H to FFFF _H	1	–	<i>5.12</i> <i>5.14</i>	○	○	○	○	
Z13	(input terminal(com.))	0000 _H to FFFF _H	1	–	<i>5.18</i> <i>5.19</i>	○	○	○	○	
Z14	(output terminal(com.))	0000 _H to FFFF _H	1	–	<i>5.18</i> <i>5.20</i>	○	○	○	○	
Z16	(operation status)	0000 _H to FFFF _H	1	–	<i>5.22</i>	×	×	×	○	
Z17	(speed detection)	-32768 to 32767	1	–	<i>5.23</i>	×	×	×	○	
Z40	cumulative operation time of motor (M1) (in units of 10 hours)	0 to 65535	1	10h	<i>5.23</i>	×	×	×	○	
Z41	cumulative operation time of motor (M2) (in units of 10 hours)	0 to 65535	1	10h	<i>5.28</i>	×	×	×	○	
Z42	cumulative operation time of motor (M3) (in units of 10 hours)	0 to 65535	1	10h	<i>5.29</i>	×	×	×	○	
Z43	cumulative operation time of motor (M4) (in units of 10 hours)	0 to 65535	1	10h	<i>5.30</i>	×	×	×	○	
Z44	number of startups (M2)	0 to 65535	1	Times	<i>5.32</i>	×	×	×	○	
Z45	number of startups (M3)	0 to 65535	1	Times	<i>5.33</i>	×	×	×	○	
Z46	number of startups (M4)	0 to 65535	1	Times	<i>5.34</i>	×	×	×	○	

Table 5.16 Keypad-related function codes (Z codes) (Continued)

Code	Name	Monitor range	Min step	Unit	LED display	Support				Remarks
						Mini	Eco	Multi	MEGA	
Z50	Third last info. on alarm (output frequency)	0.00 to 655.35	0.01	Hz	5.00	○	○	○	○	
Z51	(output current)	0.00 to 9999	Variable	A	5.01	○	○	○	○	FGI
		0.00 to 655.35	0.01	A	5.01	○	○	○	○	RTU (inverter capacity 22kW (30HP) or less)
		0.0 to 5000.0	0.1	A	5.01	×	○	–	○	RTU (inverter capacity 30kW (40HP) or more)
Z52	(output voltage)	0 to 1000	1	V	5.02	○	○	○	○	
Z53	(Torque)	-999 to 999	1	%	5.03	×	○	○	○	
Z54	(set frequency)	0.00 to 655.35	0.01	Hz	5.04	○	○	○	○	
Z55	(operation status)	0000 _H to FFFF _H	1	–	5.06	○	○	○	○	
Z56	(cumulative ope. time)	0 to 65535	1	h	5.07	○	○	○	○	
Z57	(number of startups)	0 to 65535	1	Times	5.08	○	○	○	○	
Z58	(DC link circuit voltage)	0 to 1000	1	V	5.09	○	○	○	○	
Z59	(internal air temperature)	0 to 255	1	°C	5.10	×	○	×	○	
Z60	(heat sink temperature)	0 to 255	1	°C	5.11	○	○	○	○	
Z61	(input terminal)	0000 _H to FFFF _H	1	–	5.12 5.13	○	○	○	○	
Z62	(output terminal)	0000 _H to FFFF _H	1	–	5.12 5.14	○	○	○	○	
Z63	(input terminal(com.))	0000 _H to FFFF _H	1	–	5.18 5.19	○	○	○	○	
Z64	(output terminal(com.))	0000 _H to FFFF _H	1	–	5.18 5.20	○	○	○	○	
Z66	(operation status)	0000 _H to FFFF _H	1	–	5.22	×	×	×	○	
Z67	(speed detection)	-32768 to 32767	1	–	5.23	×	×	×	○	
Z90	Current Position Pulse(Upper column)	-999 to 999	1	–	3.27	×	×	×	○	
Z91	Current Position Pulse(Lower column)	0 to 9999	1	–	3.27	×	×	×	○	
Z92	Stop Position Pulse(Upper column)	-999 to 999	1	–	3.26	×	×	×	○	
Z93	Stop Position Pulse(Lower column)	0 to 9999	1	–	3.26	×	×	×	○	
Z94	Difference Pulse of Position(Upper column)	-999 to 999	1	–	3.28	×	×	×	○	
Z95	Difference Pulse of Position(Lower column)	0 to 9999	1	–	3.28	×	×	×	○	

5.2 Data Formats

5.2.1 List of data format numbers

The following table shows the communications data format numbers for function code data. Create data according to the data format specifications described below. For the data setting range and setting unit, see the User's Manual of each inverter type (Chapter 9 for FRENIC-Mini/Eco/Multi, and Chapter 5 for FRENIC-MEGA.) The "Support" column of the table indicates whether each function is supported by the respective models or not. ○ indicates the function is supported, and × indicates the function is not supported.

RTU and FGI in the Format number field mean the Modbus RTU protocol and the Fuji general-purpose inverter protocol, respectively.

Table 5.17 List of data format numbers (F codes)

Code	Name	Format number	Support			
			Mini	Eco	Multi	MEGA
F00	Data Protection	[1]	○	○	○	○
F01	Frequency command 1	[1]	○	○	○	○
F02	Operation method	[1]	○	○	○	○
F03	Maximum frequency 1	[3]	○	○	○	○
F04	Base frequency 1	[3]	○	○	○	○
F05	Rated voltage at base frequency 1	[1]	○	○	○	○
F06	Maximum output voltage 1	[1]	○	×	○	○
F07	Acceleration time 1	[12]	○	○	○	○
F08	Deceleration time 1	[12]	×	○	○	○
F09	Torque boost 1	[3]	○	○	○	○
F10	Electronic thermal overload protection for motor 1 (Select motor characteristics)	[1]	×	○	○	○
F11	Electronic thermal overload protection for motor 1 (Overload detection level)	[24] (FGI)	○	○	○	○
		[19] (RTU)	×	○	○	○
		[24] (BUS) *1	○	○	○	○
F12	Electronic thermal overload protection for motor 1 (Thermal time constant)	[3]	×	○	○	○
F14	Restart mode after momentary power failure (Mode selection)	[1]	○	○	○	○
F15	Frequency Limiter (High)	[3]	×	○	○	○
F16	Frequency Limiter (Low)	[3]	○	○	○	○
F18	Bias (Frequency command 1)	[6]	×	○	○	○
F20	DC Braking 1(Braking starting frequency)	[3]	○	○	○	○
F21	DC Braking 1(Braking level)	[1]	×	○	○	○
F22	DC Braking 1(Braking time)	[5]	○	○	○	○
F23	Starting frequency 1	[3]	×	○	○	○
F24	Starting frequency 1 (Holding time)	[5]	○	×	○	○
F25	Stopping frequency	[3]	○	○	○	○
F26	Motor sound (Carrier frequency)	[1] *2	○	○	○	○
F27	Motor sound (Tone)	[1]	○	○	○	○

*1 BUS: The field bus option format is selected. For details about the field bus option, see the instruction manual for each field bus option.

*2 The frequency of 0.75kHz will be treated as 0.

Table 5.17 List of data format numbers (F codes) (Continued)

Code	Name	Format number	Support			
			Mini	Eco	Multi	MEGA
F29	Terminal [FMA*1] (Function selection)	[1]	×	○	×	○
	Terminal [FM] (Function selection)	[1]	×	×	○	×
F30	Terminal [FMA*1] (Gain to output voltage)	[1]	○	○	×	○
	Terminal [FM] (Gain to output voltage)	[1]	×	×	○	×
F31	Terminal [FMA*1] (Function Selection)	[1]	○	○	×	○
	Terminal [FM] (Function Selection)	[1]	×	×	○	×
F32	Terminal [FM2] (Mode selection)	[1]	×	×	×	○*2
F33	Terminal [FMP] (Pulse Rate)	[1]	×	○*3	×	○*4
	Terminal [FM] (Pulse Rate)	[1]	×	×	○	×
F34	Terminal [FMP*6] (Voltage adjust)	[1]	×	○*3	×	○*4
	Terminal [FMI] (output current adjust)	[1]	×	○*5	×	×
F35	Terminal [FMP*6] (Function)	[1]	×	○*3	×	○*4
	Terminal [FMI] (Function)	[1]	×	○*5	×	×
F37	Load Selection/Auto Torque Boost/Auto Energy Saving Operation	[1]	○	○	○	○
F38	Stop Frequency (Detection System)	[1]	×	×	×	○
F39	Stop Frequency (Holding Time)	[5]	×	×	○	○
F40	Torque Limiter 1 (Limiting Level for driving)	[1]	×	×	○	○
F41	Torque Limiter 1 (Limiting Level for braking)	[1]	×	×	○	○
F42	Control Mode Selection 1	[1]	×	×	○	○
F43	Current Limiter (Mode selection)	[1]	○	○	○	○
F44	Current Limiter (Level)	[1]	○	○	○	○
F50	Electronic Thermal Overload Protection for Braking Resistor (Discharging capability)	[1] *7	○	×	○	○
F51	Electronic Thermal Overload Protection for Braking Resistor (Allowable average loss)	[7] *7	○	×	○	○
F52	Electronic Thermal Overload Protection for Braking Resistor (for braking resistor)	[12]	×	×	×	○
F80	HD/LD switching	[1]	×	×	×	○

*1 As for FRN□□G1□-□A and FRN□□G1□-□E, the terminal name changes from FMA to FM1.

*2 Applicable only with FRN□□G1□-□A and FRN□□G1□-□E

*3 Not applicable with FRN□□□F1□-□A, FRN□□□F1□-E and FRN□□□F1□-□U

*4 Not applicable with FRN□□G1□-□A and FRN□□G1□-□E

*5 Applicable only with FRN□□□F1□-□A, FRN□□□F1□-E and FRN□□□F1□-□U

*6 As for FRN□□G1□-□A and FRN□□G1□-□E, the terminal name changes from FMP to FM2.

*7 The value of 999 will be treated as 7FFF_H.

Table 5.18 List of data format numbers (E codes)

Code	Name	Format number	Support			
			Mini	Eco	Multi	MEGA
E01	Terminal [X1] Function	[1]	○	○	○	○
E02	Terminal [X2] Function	[1]	○	○	○	○
E03	Terminal [X3] Function	[1]	○	○	○	○
E04	Terminal [X4] Function	[1]	×	○	○	○
E05	Terminal [X5] Function	[1]	×	○	○	○
E06	Terminal [X6] Function	[1]	×	×	×	○
E07	Terminal [X7] Function	[1]	×	×	×	○
E08*1	Terminal [X8] Function	[1]	×	×	×	○
E09*1	Terminal [X9] Function	[1]	×	×	×	○
E10	Acceleration time 2	[12]	○	×	○	○
E11	Deceleration time 2	[12]	○	×	○	○
E12	Acceleration time 3	[12]	×	×	×	○
E13	Deceleration time 3	[12]	×	×	×	○
E14	Acceleration time 4	[12]	×	×	×	○
E15	Deceleration time 4	[12]	×	×	×	○
E16	Torque Limiter 2 (Limiting Level for driving)	[1]	×	×	○	○
E17	Torque Limiter 2 (Limiting Level for braking)	[1]	×	×	○	○
E20	Terminal [Y1] Function	[1]	○	○	○	○
E21	Terminal [Y2] Function	[1]	×	○	○	○
E22	Terminal [Y3] Function	[1]	×	○	×	○
E23	Terminal [Y4] Function	[1]	×	×	×	○
E24	Terminal [Y5] Function	[1]	×	○	×	○
E27	Terminal [30A/B/C] Function	[1]	○	○	○	○
E29	Frequency level detection delay timer	[5]	×	×	○	×

*1 Not applicable with FRN□□G1□-□A and FRN□□G1□-□E

Table 5.18 List of data format numbers (E codes)(Continued)

Code	Name	Format number	Support			
			Mini	Eco	Multi	MEGA
E30	Frequency Arrival (Hysteresis width)	[3]	×	×	○	○
E31	Frequency Detection (FDT)(Detection level)	[3]	○	○	○	○
E32	Frequency Detection (FDT)(hysteresis width)	[3]	×	○	○	○
E34	Overload early warning/Current detection 1 (level)	[24] (FGI)	○	○	○	○
		[19] (RTU)	○	○	○	○
		[24] (BUS) *1	×	○	○	○
E35	Overload early warning/Current detection 1 (timer)	[5]	○	○	○	○
E36	Frequency Detection 2 (FDT 2) (Detection Level)	[3]	×	×	×	○
E37	Current detection 2/Low current detection (Detection Level)	[24] (FGI)	×	×	○	○
		[19] (RTU)	×	×	○	○
		[24] (BUS) *1	×	×	○	○
E38	Current detection 2/Low current detection (timer)	[5]	×	×	○	○
E39	Coefficient for Constant Feeding Rate Time	[7]	○	×	○	○
E40	PID Display Coefficient A	[12]	○	○	○	○
E41	PID Display Coefficient B	[12]	○	○	○	○
E42	LED Display filter	[5]	×	×	○	○
E43	LED Monitor (Item selection)	[1]	○	○	○	○
E45	LCD monitor (Item selection)	[1]	×	○	○	○
E46	LCD monitor (Language selection)	[1]	×	○	○	○
E47	LCD monitor (Contrast control)	[1]	×	○	○	○
E48	LED Monitor details (Speed monitor item)	[1]	○	○	○	○
E50	Coefficient for Speed Indication	[5]	○	○	○	○
E51	Display Coefficient for Input Watt-hour Data	[45]	×	○	○	○
E52	Keypad (Menu display mode)	[1]	○	○	○	○
E59	Switch function of C1 terminal	[1]	×	×	○	○
E60	Built-in Potentiometer (Function selection)	[1]	○	×	×	×
E61	Terminal [12] Extended Function	[1]	○	○	○	×
E62	Terminal [C1] (Extended function selection)	[1]	○	○	×	○
	Terminal [C2] (C1 function) (Extended function selection)	[1]	×	×	○	○
E63	Terminal [V2] (Extended function selection)	[1]	×	○	×	×
	Terminal [C1] (V2 function) (Extended function selection)	[1]	×	×	○	○
E64	Saving Digital Reference Frequency	[1]	×	○	×	×
E65	Reference Loss Detection	[1] *2	×	○	○	○
E80	Detect Torque 2/Detect Low Torque 2(Detection level)	[1]	×	○	×	○
E81	Detect Torque 2/Detect Low Torque 2(Timer)	[5]	×	○	×	○
E98	Terminal [FWD] Function	[1]	○	○	○	○
E99	Terminal [REV] Function	[1]	○	○	○	○

*1 BUS: The field bus option format is selected. For details about the field bus option, see the instruction manual for each field bus option.

*2 The value of 999 will be treated as 7FFF_H.

Table 5.19 List of data format numbers (C codes)

Code	Name	Format number	Support			
			Mini	Eco	Multi	MEGA
C01	Jump Frequency 1	[3]	○	○	○	○
C02	Jump Frequency 2	[3]	○	○	○	○
C03	Jump Frequency 3	[3]	○	○	○	○
C04	Jump Frequency (Hysteresis)	[3]	○	○	○	○
C05	Multi-Frequency 1	[5]	○	○	○	○
C06	Multi-Frequency 2	[5]	○	○	○	○
C07	Multi-Frequency 3	[5]	○	○	○	○

Table 5.19 List of data format numbers (C codes) (Continued)

Code	Name	Format number	Support			
			Mini	Eco	Multi	MEGA
C08	Multi-Frequency 4	[5]	○	○	○	○
C09	Multi-Frequency 5	[5]	○	○	○	○
C10	Multi-Frequency 6	[5]	○	○	○	○
C11	Multi-Frequency 7	[5]	○	○	○	○
C12	Multi-Frequency 8	[5]	×	×	○	○
C13	Multi-Frequency 9	[5]	×	×	○	○
C14	Multi-Frequency 10	[5]	×	×	○	○
C15	Multi-Frequency 11	[5]	×	×	○	○
C16	Multi-Frequency 12	[5]	×	×	○	○
C17	Multi-Frequency 13	[5]	×	×	○	○
C18	Multi-Frequency 14	[5]	×	×	○	○
C19	Multi-Frequency 15	[5]	×	×	○	○
C20	Jogging Frequency	[5]	○	×	○	○
C21	Timer Operation	[1]	○	×	○	○
C30	Frequency command 2	[1]	○	○	○	○
C31	Analog Input Adjustment for [12] (offset)	[4]	×	×	○	○
C32	Analog Input Adjustment for [12] (Gain)	[5]	○	○	○	○
C33	Analog input Adjustment for [12] (Filter time constant)	[5]	○	○	○	○
C34	Analog input Adjustment for [12] (Gain base point)	[5]	○	○	○	○
C35	Analog input Adjustment for [12] (Polarity)	[1]	×	×	○	○
C36	Analog Input Adjustment for [C1] (Offset)	[4]	×	×	○	○
	Analog Input Adjustment for [C1] (C1 function) (Offset)	[4]	×	×	○	×
C37	Analog Input Adjustment for [C1] (Gain)	[5]	○	○	×	○
	Analog Input Adjustment for [C1] (C1 function) (Gain)	[5]	×	×	○	×
C38	Analog Input Adjustment for [C1] (Filter time constant)	[5]	○	○	×	○
	Analog Input Adjustment for [C1] (C1 function) (Filter time constant)	[5]	×	×	○	○
C39	Analog Input Adjustment for [C1] (Gain base point)	[5]	○	○	×	○
	Analog Input Adjustment for [C1] (C1 function) (Gain base point)	[5]	×	×	○	×
C41	Analog Input Adjustment for[V2] (Offset)	[4]	○	○	×	○
	Analog Input Adjustment for [C1] (V2 function) (Offset)	[4]	×	×	○	×
C42	Analog Input Adjustment for [V2] (Gain)	[5]	×	○	×	○
	Analog Input Adjustment for [C1] (V2 function) (Gain)	[5]	×	×	○	×
C43	Analog Input Adjustment for [V2] (Filter time constant)	[5]	×	○	×	○
	Analog Input Adjustment for [C1] (V2 function) (Filter time constant)	[5]	×	×	○	×
C44	Analog Input Adjustment for[V2] (Gain base point)	[5]	×	○	×	○
	Analog Input Adjustment for [C1] (V2 function) (Gain base point)	[5]	×	×	○	×
C45	Analog input Adjustment for [V2] (Polarity)	[1]	×	×	×	○
C50	Bias (Frequency command 1) (Bias base point)	[5]	○	○	○	○
C51	Bias [PID command 1] (Bias value)	[6]	○	○	○	○
C52	Bias [PID command 1] (Bias base point)	[5]	○	○	○	○
C53	Selection of Normal/Inverse Operation (Frequency command 1)	[1]	×	○	○	○

Table 5.20 List of data format numbers (P codes)

Code	Name	Format number	Support			
			Mini	Eco	Multi	MEGA
P01	Motor 1 (No. of poles)	[1]	×	○	○	○
P02	Motor 1 (Rated Capacity) When P99 = 0, 2 to 4 When P99 = 1	[11]	○	○	○	○
		[25]	○	○	○	○
P03	Motor 1 (Rated current)	[24] (FGI)	○	○	○	○
		[19] (RTU)	○	○	○	○
		[24] (BUS) *1	×	○	○	○
P04	Motor 1 (Auto-tuning)	[21]	×	○	○	○
P05	Motor 1 (Online Tuning)	[1]	×	×	○	×
P06	Motor 1 (No-load current)	[24] (FGI)	×	○	○	○
		[19] (RTU)	×	○	○	○
		[24] (BUS) *1	×	○	○	○
P07	Motor 1 (%R1)	[5]	×	○	○	○
P08	Motor 1 (%X)	[5]	×	○	○	○
P09	Motor 1 (Slip compensation gain for driving)	[3]	○	×	○	○
P10	Motor 1 (Slip compensation response time)	[5]	×	×	○	○
P11	Motor 1 (Slip compensation gain (Braking))	[3]	×	×	○	○
P12	Motor 1 (Rated slip frequency)	[5]	×	×	○	○
P13	Motor 1 (Iron loss coefficient 1)	[5]	×	×	×	○
P14	Motor 1 (Iron loss coefficient 2)	[5]	×	×	×	○
P15	Motor 1 (Iron loss coefficient 3)	[5]	×	×	×	○
P16	Motor 1 (Magnetic saturation coefficient 1)	[3]	×	×	×	○
P17	Motor 1 (Magnetic saturation coefficient 2)	[3]	×	×	×	○
P18	Motor 1 (Magnetic saturation coefficient 3)	[3]	×	×	×	○
P19	Motor 1 (Magnetic saturation coefficient 4)	[3]	×	×	×	○
P20	Motor 1 (Magnetic saturation coefficient 5)	[3]	×	×	×	○
P21	Motor 1 (Magnetic saturation expansion coefficient a)	[3]	×	×	×	○
P22	Motor 1 (Magnetic saturation expansion coefficient b)	[3]	×	×	×	○
P23	Motor 1 (Magnetic saturation expansion coefficient c)	[3]	×	×	×	○
P53	Motor 1 (%X compensation coefficient 1)	[1]	×	×	×	○
P54	Motor 1 (%X compensation coefficient 2)	[1]	×	×	×	○
P55	Motor 1 (Vector control torque current)	[24] (FGI)	×	×	×	○
		[19] (RTU)	×	×	×	○
		[24] (BUS) *1	×	×	×	○
P56	Motor 1 (Vector control t inductive voltage coefficient)	[1]	×	×	×	○
P57	Reserved.	[7]	×	×	×	○
P99	Motor 1 Selection	[1]	○	○	○	○

*1 BUS: The field bus option format is selected. For details about the field bus option, see the instruction manual for each field bus option.

Table 5.21 List of data format numbers (H codes)

Code	Name	Format number	Support			
			Mini	Eco	Multi	MEGA
H03	Data Initialization	[1]	○	○	○	○
H04	Auto-reset (times)	[1]	○	○	○	○
H05	Auto-reset (Reset interval)	[3]	○	○	○	○
H06	Cooling Fan ON/OFF Control	[1]	○	○	○	○
H07	Acceleration/Deceleration Pattern	[1]	○	○	○	○
H08	Rotation Direction Limitation	[1]	×	×	○	○
H09	Start Mode (Auto search)	[1]	×	○	○	○
H11	Deceleration Mode	[1]	×	○	○	○
H12	Instantaneous Overcurrent Limiting (Mode selection)	[1]	○	○	○	○

Table 5.21 List of data format numbers (H codes) (Continued)

Code	Name	Format number	Support			
			Mini	Eco	Multi	MEGA
H13	Restart Mode after Momentary Power Failure (Restart time)	[3]	×	○	○	○
H14	Restart Mode after Momentary Power Failure (Frequency fall rate)	[5] *1	×	○	○	○
H15	Restart Mode after Momentary Power Failure (Holding DC voltage)	[1]	×	○	×	○
H16	Restart Mode after Momentary Power Failure (Allowable momentary power failure time)	[3] *1	×	○	○	○
H17	Start Mode (Pick up frequency)	[3] *1	×	○	×	×
H26	Thermistor (Mode selection)	[1]	○	○	○	○
H27	Thermistor (Level)	[5]	○	○	○	○
H28	Droop control	[4]	×	×	○	○
H30	Communications Link Function (Mode selection)	[1]	○	○	○	○
H42	Capacitance of DC Link Bus Capacitor	[1]	○	○	○	○
H43	Cumulative Run Time of Cooling Fan	[1]	○	○	○	○
H44	Startup Times 1 of Motor	[1]	×	×	○	○
H45	Mock Alarm	[1]	×	×	○	○
H46	Restart Mode after Momentary Power Failure (Restart time)	[3]	×	×	×	○
H47	Initial Capacitance of DC Link Bus Capacitor	[1]	×	○	○	○
H48	Cumulative Run Time of Capacitors on the PCB	[1]	×	○	○	○
H49	Starting Mode (Delay time)	[3]	×	○	○	○
H50	Non-linear V/f Pattern 1 (Frequency)	[3]	○	○	○	○
H51	Non-linear V/f Pattern 1 (Voltage)	[1]	○	○	○	○
H52	Non-linear V/f 2 (Frequency)	[3]	×	×	○	○
H53	Non-linear V/f 2 (Voltage)	[1]	×	×	○	○
H54	Acceleration time (Jogging operation)	[12]	○	×	○	○
H55	Deceleration time (Jogging operation)	[12]	×	×	×	○
H56	Deceleration Time for Forced Stop	[12]	×	○	○	○
H57	1st S-curve range at acceleration (start)	[1]	×	×	×	○
H58	2nd S-curve range at deceleration (end)	[1]	×	×	×	○
H59	1st S-curve range at acceleration (start)	[1]	×	×	×	○
H60	2nd S-curve range at deceleration (end)	[1]	×	×	×	○
H61	UP/DOWN Control Initial frequency setting	[1]	×	×	○	○
H63	Low Limiter (Mode selection)	[1]	×	○	○	○
H64	Low Limiter (Lower limiting frequency)	[3]	○	○	○	○
H65	Non-linear V/f 3 (Frequency)	[3]	×	×	×	○
H66	Non-linear V/f 3 (Voltage)	[1]	×	×	×	○
H67	Automatic energy saving operation (Mode selection)	[1]	×	×	×	○
H68	Slip Compensation 1 (Operating conditions)	[1]	×	×	○	○
H69	Automatic deceleration (Mode selection)	[1]	○	○	○	○
H70	Overload prevention control	[5] *1	○	○	○	○
H71	Deceleration Characteristics	[1]	×	○	○	○
H72	Main Power Down Detection (Mode Selection)	[1]	×	×	×	○
H73	Torque Limiter (Operation condition selection)	[1]	×	×	×	○
H76	Torque Limiter (Frequency increment limit for braking)	[3]	×	×	○	○
H77	Main circuit capacity life (remaining hour)	[74]	×	×	×	○
H78	Maintenance setting time(M1)	[74]	×	×	×	○
H79	No. of maintenance setting starting times (M1)	[1]	×	×	×	○
H80	Output Current Fluctuation Damping Gain for Motor 1	[5]	○	○	○	○
H81	Light alarm selection 1	[1]	×	×	×	○
H82	Light alarm selection 2	[1]	×	×	×	○
H84	Pre-excitation (initial level)	[1]	×	×	×	○
H85	Pre-excitation (time)	[5]	×	×	×	○
H86	Reserved.	[1]	×	○	×	○

*1 The value of 999 will be treated as 7FFF_H.

Table 5.21 List of data format numbers (H codes) (Continued)

Code	Name	Format number	Support			
			Mini	Eco	Multi	MEGA
H87	Reserved.	[3]	×	○	×	○
H88	Reserved.	[1]	×	○	×	○
H89	Reserved.	[1]	×	○	○	○
H90	Reserved.	[1]	×	○	○	○
H91	PID feedback disconnection detection	[1]	×	○	○	○
H92	Continue to Run (P-component: gain)	[7] *1	×	○	×	○
H93	Continue to Run (I-component: time)	[7] *1	×	○	×	○
H94	Cumulative Motor Run Time 1	[1]	×	○	○	○
H95	DC braking (Braking response mode)	[1]	×	○	○	○
H96	STOP key priority / Start check function	[1]	○*2	○	○	○
H97	Clear alarm data	[1]	○	○	○	○
H98	Protection/Maintenance Function (Mode selection)	[1]	○	○	○	○

*1 The value of 999 will be treated as 7FFF_H.

*2 Applicable with Frenic-mini ROM version C1S11000 or later.

Table 5.22 List of data format numbers (A codes)

Code	Name	Format number	Support			
			Mini	Eco	Multi	MEGA
A01	Maximum frequency 2	[3]	×	×	○	○
A02	Base frequency 2	[3]	×	×	○	○
A03	Rated voltage at base frequency 2	[1]	×	×	○	○
A04	Maximum output voltage 2	[1]	×	×	○	○
A05	Torque boost 2	[3]	×	×	○	○
A06	Electronic thermal overload protection for motor 2 (Select motor characteristics)	[1]	×	×	○	○
A07	Electronic thermal overload protection for motor 2 (Overload detection level)	[24] (FGI)	×	×	○	○
		[19] (RTU)	×	×	○	○
		[24] (BUS) *1	×	×	○	○
A08	Electronic thermal overload protection for motor 2 (Thermal time constant)	[3]	×	×	○	○
A09	DC Braking 2 (Braking starting frequency)	[3]	×	×	○	○
A10	DC braking 2 (Braking level)	[1]	×	×	○	○
A11	DC braking 2 (Braking time)	[5]	×	×	○	○
A12	Starting frequency 2	[3]	×	×	○	○
A13	Load Selection/Auto Torque Boost/Auto Energy Saving Operation 2	[1]	×	×	○	○
A14	Control Mode Selection 2	[1]	×	×	○	○
A15	Motor 2 (No. of poles)	[1]	×	×	○	○
A16	(Rated Capacity)Motor 2 (No. of poles) When A39 = 0, 2 to 4 When A39 = 1	[11]	×	×	○	○
		[25]	×	×	○	○
A17	Rated Motor 2 Capacity	[24] (FGI)	×	×	○	○
		[19] (RTU)	×	×	○	○
		[24] (BUS) *1	×	×	○	○
A18	Motor 2 (Auto-tuning)	[21]	×	×	○	○
A19	Motor 2 (Online-tuning)	[1]	×	×	○	○
A20	Motor 2 (No-load current)	[24] (FGI)	×	×	○	○
		[19] (RTU)	×	×	○	○
		[24] (BUS) *1	×	×	○	○

*1 BUS: The field bus option format is selected. For details about the field bus option, see the instruction manual for each field bus option.

Table 5.22 List of data format numbers (A codes)(Continued)

Code	Name	Format number	Support			
			Mini	Eco	Multi	MEGA
A21	Motor 2 (%R2)	[5]	×	×	○	○
A22	Motor 2 (%X)	[5]	×	×	○	○
A23	Motor 2 (Slip compensation gain for driving)	[3]	×	×	○	○
A24	Motor 2 (Slip compensation response time)	[5]	×	×	○	○
A25	Motor 2 (Slip compensation gain for braking)	[3]	×	×	○	○
A26	Motor 2 (Rated slip frequency)	[5]	×	×	○	○
A27	Motor 2 (Iron loss coefficient 1)	[5]	×	×	×	○
A28	Motor 2 (Iron loss coefficient 2)	[5]	×	×	×	○
A29	Motor 2 (Iron loss coefficient 3)	[5]	×	×	×	○
A30	Motor 2 (Magnetic saturation coefficient 1)	[3]	×	×	×	○
A31	Motor 2 (Magnetic saturation coefficient 2)	[3]	×	×	×	○
A32	Motor 2 (Magnetic saturation coefficient 3)	[3]	×	×	×	○
A33	Motor 2 (Magnetic saturation coefficient 4)	[3]	×	×	×	○
A34	Motor 2 (Magnetic saturation coefficient 5)	[3]	×	×	×	○
A35	Motor 2 (Magnetic saturation expansion coefficient a)	[3]	×	×	×	○
A36	Motor 2 (Magnetic saturation expansion coefficient b)	[3]	×	×	×	○
A37	Motor 2 (Magnetic saturation expansion coefficient c)	[3]	×	×	×	○
A39	Motor 2 Selection	[1]	×	×	○	○
A40	Slip Compensation 2 (Operating conditions)	[1]	×	×	○	○
A41	Output Current Fluctuation Damping Gain 2	[5]	×	×	○	○
A42	Motor/parameter switching 2 (Mode selection)	[1]	×	×	×	○
A43	Speed control 2 (Speed command filter)	[7]	×	×	×	○
A44	Speed control 2 (Speed detection filter)	[7]	×	×	×	○
A45	Cumulative Motor Run Time 2	[1]	×	×	○	○
	Speed control 2 P (Gain)	[3]	×	×	×	○
A46	Number of Starting Times 2	[1]	×	×	○	○
	Speed control 2 I (Integration time)	[7]	×	×	×	○
A48	Speed control 2 (Output filter)	[7]	×	×	×	○
A51	Cumulative Motor Run Time 2	[74]	×	×	×	○
A52	Startup Times of Motor 2	[1]	×	×	×	○
A53	Motor 2 (%X compensation efficient 1)	[1]	×	×	×	○
A54	Motor 2 (%XCompensation coefficient 2)	[1]	×	×	×	○
A55	Motor 2 (Vector control torque current)	[24] (FGI)	×	×	×	○
		[19] (RTU)	×	×	×	○
		[24](BUS) *1	×	×	×	○
A56	Motor 2 (Vector control inductive voltage coefficient)	[1]	×	×	×	○
A57	Reserved.	[7]	×	×	×	○

*1 BUS: The field bus option format is selected. For details about the field bus option, see the instruction manual for each field bus option.

Table 5.23 List of data format numbers (b codes) (Continued)

Code	Name	Format number	Support			
			Mini	Eco	Multi	MEGA
b48	Speed control 3 (Output filter)	[1]	×	×	×	○
b51	Cumulative Motor Run Time 3	[7]	×	×	×	○
b52	Startup Times of Motor 3	[1]	×	×	×	○
b53	Motor 3 (%X compensation efficient 1)	[1]	×	×	×	○
b54	Motor 3 (%XCompensation coefficient 2)	[1]	×	×	×	○
b55	Motor 3 (Vector control torque current)	[24] (FGI)	×	×	×	○
		[19] (RTU)	×	×	×	○
		[24](BUS) *1	×	×	×	○
b56	Motor 3 (Vector control inductive voltage coefficient)	[1]	×	×	×	○
b57	Reserved.	[1]	×	×	×	○

*1 BUS: The field bus option format is selected. For details about the field bus option, see the instruction manual for each field bus option.

Table 5.24 List of data format numbers (r codes)

Code	Name	Format number	Support			
			Mini	Eco	Multi	MEGA
r01	Maximum frequency 4	[3]	×	×	×	○
r02	Base frequency 4	[3]	×	×	×	○
r03	Rated voltage at base frequency 4	[1]	×	×	×	○
r04	Maximum output voltage 4	[1]	×	×	×	○
r05	Torque boost 4	[3]	×	×	×	○
r06	Electronic thermal overload protection for motor 4 (Select motor characteristics)	[1]	×	×	×	○
r07	Electronic thermal overload protection for motor 4 (Overload detection level)	[24] (FGI)	×	×	×	○
		[19] (RTU)	×	×	×	○
		[24] (BUS) *1	×	×	×	○
r08	Electronic thermal overload protection for motor 4 (Thermal time constant)	[3]	×	×	×	○
r09	DC Braking 4 (Braking starting frequency)	[3]	×	×	×	○
r10	DC Braking 4 (Braking level)	[1]	×	×	×	○
r11	DC Braking 4 (Braking time)	[5]	×	×	×	○
r12	Starting frequency 4	[3]	×	×	×	○
r13	Load Selection/Auto Torque Boost/Auto Energy Saving Operation 4	[1]	×	×	×	○
r14	Control Mode Selection 4	[1]	×	×	×	○
r15	Motor 4 (No. of poles)	[1]	×	×	×	○
r16	Motor 4 (Rated Capacity) r49=0, 2 to4 r=1	[11]	×	×	×	○
		[25]	×	×	×	○
r17	Motor 4 (Rated current)	[24] (FGI)	×	×	×	○
		[19] (RTU)	×	×	×	○
		[24] (BUS) *1	×	×	×	○
r18	Motor 4 (Auto-tuning)	[21]	×	×	×	○
r20	Motor 4 (No-load current)	[24] (FGI)	×	×	×	○
		[19] (RTU)	×	×	×	○
		[24] (BUS) *1	×	×	×	○
r21	Motor 4 (%R4)	[5]	×	×	×	○
r22	Motor 4 (%X)	[5]	×	×	×	○
r23	Motor 4 (Slip compensation gain for driving)	[3]	×	×	×	○
r24	Motor 4 (Slip compensation response time)	[5]	×	×	×	○
r25	Motor 4 (Slip compensation gain for braking)	[3]	×	×	×	○
r26	Motor 4 (Rated slip frequency)	[5]	×	×	×	○
r27	Motor 4 (Iron loss coefficient 1)	[5]	×	×	×	○

*1 BUS: The field bus option format is selected. For details about the field bus option, see the instruction manual for each field bus option.

Table 5.24 List of data format numbers (r codes) (Continued)

Code	Name	Format number	Support			
			Mini	Eco	Multi	MEGA
r28	Motor 4 (Iron loss coefficient 2)	[5]	×	×	×	○
r29	Motor 4 (Iron loss coefficient 4)	[5]	×	×	×	○
r30	Motor 4 (Magnetic saturation coefficient 1)	[3]	×	×	×	○
r31	Motor 4 (Magnetic saturation coefficient 2)	[3]	×	×	×	○
r32	Motor 4 (Magnetic saturation coefficient 4)	[3]	×	×	×	○
r33	Motor 4 (Magnetic saturation coefficient 4)	[3]	×	×	×	○
r34	Motor 4 (Magnetic saturation coefficient 5)	[3]	×	×	×	○
r35	Motor 4 (Magnetic saturation expansion coefficient a)	[3]	×	×	×	○
r36	Motor 4 (Magnetic saturation expansion coefficient b)	[3]	×	×	×	○
r37	Motor 4 (Magnetic saturation expansion coefficient c)	[3]	×	×	×	○
r39	Motor 4 Selection	[1]	×	×	×	○
r40	Slip Compensation 4 (Operating conditions)	[1]	×	×	×	○
r41	Output Current Fluctuation Damping Gain 4	[5]	×	×	×	○
r42	Motor/parameter switching 4 (Mode selection)	[1]	×	×	×	○
r43	Speed control 4(Speed command filter)	[7]	×	×	×	○
r44	Speed control 4 (Speed detection filter)	[7]	×	×	×	○
r45	Speed control 4 P (Gain)	[3]	×	×	×	○
r46	Speed control 4 P (Integration time)	[7]	×	×	×	○
r48	Speed control 4 (Output filter)	[1]	×	×	×	○
r51	Cumulative Motor Run Time 4	[7]	×	×	×	○
r52	Startup Times of Motor 4	[1]	×	×	×	○
r53	Motor 4 (%X compensation efficient 1)	[1]	×	×	×	○
r54	Motor 4 (%XCompensation coefficient 2)	[1]	×	×	×	○
r55	Motor 4 (Vector control torque current)	[24] (FGI)	×	×	×	○
		[19] (RTU)	×	×	×	○
		[24](BUS) *1	×	×	×	○
r56	Motor 4 (Vector control inductive voltage coefficient)	[1]	×	×	×	○
r57	Reserved.	[1]	×	×	×	○

*1 BUS: The field bus option format is selected. For details about the field bus option, see the instruction manual for each field bus option.

Table 5.25 List of data format numbers (J codes)

Code	Name	Format number	Support			
			Mini	Eco	Multi	MEGA
J01	PID control (Mode selection)	[1]	○	○	○	○
J02	PID control (Remote command)	[1]	○	○	○	○
J03	PID control P (gain)	[7]	○	○	○	○
J04	PID control I (Integration time)	[3]	○	○	○	○
J05	PID control D (Derivative time)	[5]	○	○	○	○
J06	PID control (Feedback filter)	[3]	○	○	○	○
J08	PID control (Pressurized frequency)	[3]	×	×	×	○
J09	PID control (Pressuring time)	[1]	×	×	×	○
J10	PID control (Anti reset windup)	[1]	×	○	○	○
J11	PID control (Select alarm output)	[1]	×	○	○	○
J12	PID control (Upper level alarm (AH))	[2]	×	○	○	○
J13	PID control (Lower level alarm (AL))	[2]	×	○	○	○
J15	PID control (Stop frequency for slow flowrate)	[1]	×	○	×	○
J16	PID control (Slow flowrate level stop latency)	[1]	×	○	×	○
J17	PID control (Starting frequency)	[1]	×	○	×	○

Table 5.25 List of data format numbers (J codes)(Continued)

Code	Name	Format number	Support			
			Mini	Eco	Multi	MEGA
J18	PID control (Upper limit of PID process output)	Eco [1] *1 Multi [2] *1 MEGA [2]*1	×	○	○	○
J19	PID control (Lower limit of PID process output)	Eco [1] *1 Multi [2] *1 MEGA [2]*1	×	○	○	○
J21	Dew Condensation Prevention (Duty)	[1]	×	○	×	○
J22	Commercial Power Switching Sequence	[1]	×	○	×	○
J56	PID control (Speed command filter)	[5]	×	×	○	○
J57	PID control (Dancer reference position)	[2]	×	×	○	○
J58	PID control (Detection width of Dancer position deviation)	[1]	×	×	○	○
J59	PID control P (gain) 2	[7]	×	×	○	×
J60	PID control I (Integral time) 2	[3]	×	×	○	×
J61	PID control D (Derivative time) 2	[5]	×	×	○	×
J62	PID control (PID control block selection)	[1]	×	×	○	×
J63	Overload Stop (Detected value)	[1]	×	×	○	○
J64	Overload Stop (Detection level)	[1]	×	×	○	○
J65	Overload Stop (Function selection)	[1]	×	×	○	○
J66	Overload Stop (Operation condition)	[1]	×	×	○	○
J67	Overload Stop (Timer)	[5]	×	×	○	○
J68	Braking signal (Brake release current)	[1]	×	×	○	○
J69	Braking signal (Brake release frequency)	[3]	×	×	○	○
J70	Braking signal (Brake release timer)	[3]	×	×	○	○
J71	Braking signal (Brake apply frequency)	[3]	×	×	○	○
J72	Braking signal (Brake apply timer)	[3]	×	×	○	○
J73	Position control (Start time)	[3]	×	×	○	×
J74	Position control (Start point : Upper column)	[73]	×	×	○	×
J75	Position control (Start point : Lower column)	[75]	×	×	○	×
J76	Position control (Zero point : Upper column)	[73]	×	×	○	×
J77	Position control (Zero point : Lower column)	[75]	×	×	○	×
J78	Position control (Distance of low speed control : Upper column)	[73]	×	×	○	×
J79	Position control (Distance of low speed control : Lower column)	[1]	×	×	○	×
J80	Position control (Speed command on low speed control)	[1]	×	×	○	×
J81	Position control (Objective Stop point : Upper column)	[73]	×	×	○	×
J82	Position control (Objective Stop point : Lower column)	[1]	×	×	○	×
J83	Position control (Permissible range of objective stop point)	[1]	×	×	○	×
J84	Position control (End time)	[3]	×	×	○	×
J85	Position control (Compensation of over travel)	[1]	×	×	○	×
J86	Position control (Selection mode)	[1]	×	×	○	×
J87	Position control (Compensation of over travel)	[1]	×	×	○	×
J88	Position control (Selection mode)	[1]	×	×	○	×
J90	Overload Stop Function Torque Limit P (Gain)	[7]	×	×	○	×
J91	Overload Stopping Function Torque Limit I (Integral time)	[7]	×	×	○	×
J92	Overload Stopping Function (Current control level)	[3]	×	×	○	×
J95	Brake Signal (Release torque)	[1]	×	×	×	○
J96	Brake Signal (Speed selection)	[1]	×	×	×	○
J97	Servo lock (Gain)	[5]	×	×	×	○
J98	Servo lock (Completion timer)	[7]	×	×	×	○
J99	Position control (Permissible range of objective stop point)	[1]	×	×	×	○

*1 The value of 999 will be treated as 7FFF_H.

Table 5.26 List of data format numbers (d codes)

Code	Name	Format number	Support			
			Mini	Eco	Multi	MEGA
d01	Speed Control 1	[7]	×	×	×	○
d02	Speed Control 1	[7]	×	×	×	○
d03	Speed Control 1	[3]	×	×	×	○
d04	Speed Control 1	[3]	×	×	×	○
d06	Speed Control 1	[7]	×	×	×	○
d09	Speed Control (JOG)	[7]	×	×	×	○
d10	Speed Control (JOG)	[7]	×	×	×	○
d11	Speed Control (JOG)	[3]	×	×	×	○
d12	Speed Control (JOG)	[7]	×	×	×	○
d13	Speed Control (JOG)	[7]	×	×	×	○
d14	Feedback input	[1]	×	×	×	○
d15	Feedback input	[1]	×	×	×	○
d16	Feedback input	[1]	×	×	×	○
d17	Feedback input	[1]	×	×	×	○
d21	Speed consistency/PG error (Detection width)	[3]	×	×	×	○
d22	Speed consistency/PG error (Detection timer)	[5]	×	×	×	○
d23	PG Error Selection	[1]	×	×	×	○
d24	Zero Speed Control	[1]	×	×	×	○
d25	ASR Switching Time	[7]	×	×	×	○
d32	Torque Control Speed Limit 1	[1]	×	×	×	○
d33	Torque Control Speed Limit 2	[1]	×	×	×	○
d51	Reserved	[1]	×	×	×	○
d52	Reserved	[1]	×	×	×	○
d53	Reserved	[1]	×	×	×	○
d54	Reserved	[1]	×	×	×	○
d55	Reserved	[1]	×	×	×	○
d59	Command (Pulse train input) Pulse Input Method	[1]	×	×	×	○
d61	Command (Pulse train input) Filter Time Constant	[1]	×	×	×	○
d62	Command (Pulse train input) Pulse Compensation Coefficient 1	[1]	×	×	×	○
d63	Command (Pulse train input) Pulse Compensation Coefficient 2	[1]	×	×	×	○
d67	Starting Mode (Auto search)	[1]	×	×	×	○
d68	Reserved	[1]	×	×	×	○
d99	Reserved	[1]	×	×	×	○

Table 5.27 List of data format numbers (y codes)

Code	Name	Format number	Support			
			Mini	Eco	Multi	MEGA
y01	RS-485 Communications (Standard) (Station address)	[1]	○	○	○	○
y02	RS-485 Communications (Standard) (Communications error processing)	[1]	○	○	○	○
y03	RS-485 Communications (Standard) (Timer)	[3]	○	○	○	○
y04	RS-485 Communications (Standard) (Baud rate)	[1]	○	○	○	○
y05	RS-485 Communications (Standard) (Data length)	[1]	○	○	○	○
y06	RS-485 Communications (Standard) (Parity check)	[1]	○	○	○	○
y07	RS-485 Communications (Standard) (Stop bits)	[1]	○	○	○	○
y08	RS-485 Communications (Standard) (No response error detection time)	[1]	○	○	○	○
y09	RS-485 Communications (Standard) (Response interval)	[5]	○	○	○	○
y10	RS-485 Communications (Standard) (Protocol selection)	[1]	○	○	○	○
y11	RS-485 Communications (Option) (Station address)	[1]	×	○	○	○

Table 5.27 List of data format numbers (y codes)(Continued)

Code	Name	Format number	Support			
			Mini	Eco	Multi	MEGA
y12	RS-485 Communications (Option) (Communications error processing)	[1]	×	○	○	○
y13	RS-485 Communications (Option) (Timer)	[3]	×	○	○	○
y14	RS-485 Communications (Option) (Baud rate)	[1]	×	○	○	○
y15	RS-485 Communications (Option) (Data length)	[1]	×	○	○	○
y16	RS-485 Communications (Option) (Parity check)	[1]	×	○	○	○
y17	RS-485 Communications (Option) (Stop bits)	[1]	×	○	○	○
y18	RS-485 Communications (Option) (No response error detection time)	[1]	×	○	○	○
y19	RS-485 Communications (Option) (Response interval)	[5]	×	○	○	○
y20	RS-485 Communications (Option) (Protocol selection)	[1]	×	○	○	○
y97	Communications Data Saving Method Selection	[1]	×	×	×	○
y98	Bus Link Function (Mode selection)	[1]	×	○	○	○
y99	Loader Link Function (Mode selection)	[1]	○	○	○	○

Table 5.28 List of data format numbers (S codes)

Code	Name	Format number	Support			
			Mini	Eco	Multi	MEGA
S01	Frequency reference (p.u.)	[29]	○	○	○	○
S05	Frequency reference	[22]	○	○	○	○
S06	Operation command	[14]	○	○	○	○
S07	Universal DO	[15]	×	○	○*1	○
S08	Acceleration time F07	[3]	○	○	○	○
S09	Deceleration time F08	[3]	○	○	○	○
S10	Torque Limit Level 1	Multi [1] MEGA [6]	×	×	○	○
S11	Torque Limit Level 2	[1]	×	×	○	○
S12	Universal AO	[29]	×	○	○	○
S13	PID command	[29]	○	○	○	○
S14	Alarm reset command	[1]	○	○	○	○

*1 Not applicable with the FRENIC-Multi ROM version 0799 or older.

Table 5.29 List of data format numbers (M codes)

Code	Name	Format number	Support			
			Mini	Eco	Multi	MEGA
M01	Frequency reference (p.u.) (Final command)	[29]	○	○	○	○
M02	Torque command (Final command)	[6]	×	×	×	○
M03	Torque current command (Final command)	[6]	×	×	×	○
M04	Magnetic flux command value	[6]	×	×	×	○
M05	Frequency reference (Final command)	[22]	○	○	○	○
M06	Output frequency 1 (p.u.)	[29]	○	○	○	○
M07	Torque real value	[6]	×	○	○	○
M08	Torque current	[6]	×	×	×	○
M09	Output frequency	[23] (FGI)	○	○	○	○
		[22] (RTU)	○	○	○	○
		[22] (BUS) *1	×	○	○	○
M10	Input power	[5]	○	○	○	○
M11	Output current effective value	[5]	○	○	○	○
M12	Output voltage effective value	[3]	○	○	○	○
M13	Operation command (Final command)	[14]	○	○	○	○
M14	Operation status	[16]	○	○	○	○
M15	General-purpose output terminal information	[15]	○	○	○	○
M16	Latest alarm contents	[10]	○	○	○	○
M17	Last alarm contents	[10]	○	○	○	○
M18	Second last alarm contents	[10]	○	○	○	○
M19	Third last alarm contents	[10]	○	○	○	○
M20	Cumulative operation time	[1]	○	○	○	○
M21	DC link circuit voltage	[1]	○	○	○	○
M22	Motor temperature	[2]	×	×	×	○
M23	Model code	[17]	○	○	○	○
M24	Capacity code	[11]	○	○	○	○
M25	ROM version	[35]	○	○	○	○
M26	Transmission error transaction code	[20]	○	○	○	○
M27	Frequency reference on alarm (p.u.) (Final command)	[29]	○	○	○	○
M28	Torque command on alarm (Final command)	[6]	×	×	×	○
M29	Torque current command on alarm (Final command)	[6]	×	×	×	○
M30	Flux command on alarm (Final command)	[6]	×	×	×	○
M31	Frequency reference on alarm (Final command)	[22]	○	○	○	○
M32	Output frequency 1 on alarm (p.u.)	[29]	○	○	○	○
M33	Torque real value on alarm	[6]	×	○	○	○
M34	Torque current on alarm	[6]	×	×	×	○
M35	Output frequency on alarm	[23] (FGI)	○	○	○	○
		[22] (RTU)	○	○	○	○
		[22] (BUS) *1	×	○	○	○
M36	Input power on alarm	[5]	○	○	○	○
M37	Output current effective value on alarm	[5]	○	○	○	○
M38	Output voltage effective value on alarm	[3]	○	○	○	○
M39	Operation command on alarm	[14]	○	○	○	○
M40	Operation status on alarm	[16]	○	○	○	○
M41	Output terminal information on alarm	[15]	○	○	○	○
M42	Cumulative operation time on alarm	[1]	○	○	○	○
M43	DC link circuit voltage on alarm	[1]	○	○	○	○
M44	Inverter internal air temperature on alarm	[1]	×	○	×	○
M45	Heat sink temperature on alarm	[1]	○	○	○	○

*1 BUS: The field bus option format is selected. For details about the field bus option, see the instruction manual for each field bus option.

Table 5.29 List of data format numbers (M codes) (Continued)

Code	Name	Format number	Support			
			Mini	Eco	Multi	MEGA
M46	Life of main circuit capacitor	[3]	○	○	○	○
M47	Life of PC board electrolytic capacitor	[1]	○	○	○	○
M48	Life of heat sink	[1]	○	○	○	○
M49	Input terminal voltage [12] (p.u.)	[29]	○	○	○	○
M50	Input terminal current [C1] (p.u.)	[29]	○	○	○	○
M51	Input terminal current [22]	[29]	×	×	×	○
M52	Input terminal current [32]	[29]	×	×	×	○
M53	Input terminal current [C2]	[29]	×	×	×	○
M54	Input terminal voltage [V2] (p.u.)	[29]	×	○	○	○
M61	Inverter internal air temperature	[1]	×	○	×	○
M62	Heat sink temperature	[1]	○	○	○	○
M63	Load rate	[6]	×	○	○	○
M64	Motor output	[6]	×	○	○	○
M65	Motor output on alarm	[6]	×	○	○	○
M66	Speed detection	[29]	×	×	×	○
M67	Transmission error handling code 2	[20]	×	×	×	○
M68	PID final command	[29]	○	○	○	○
M69	Inverter rated current	[24] (FGI)	○	○	○	○
		[19] (RTU)	○	○	○	○
		[24] (BUS) *1	×	○	○	○
M70	Operation status 2	[44]	○	○	○	○
M71	Input terminal information	[14]	○	○	○	○
M72	PID feedback value	[29]	×	○	○	○
M73	PID output	[29]	×	○	○	○
M74	Operating status 2	[76]	×	×	×	○
M76	Main circuit capacity life (Elapsed time)	[74]	×	×	×	○
M77	Main circuit capacity life (Remaining time)	[74]	×	×	×	○
M81	Maintenance (Remaining time) (M1)	[74]	×	×	×	○
M85	Maintenance (Starting times) (M1)	[1]	×	×	×	○
M86	Light alarm contents (Latest)	[10]	×	×	×	○
M87	Light alarm contents (Last)	[10]	×	×	×	○
M88	Light alarm contents (Second last)	[10]	×	×	×	○
M89	Light alarm contents (Third last)	[10]	×	×	×	○

*1 BUS: The field bus option format is selected. For details about the field bus option, see the instruction manual for each field bus option.

Table 5.30 List of data format numbers (W codes)

Code	Name	Format number	Support			
			Mini	Eco	Multi	MEGA
W01	Operation status	[16]	○	○	○	○
W02	Frequency reference	[22]	○	○	○	○
W03	Output frequency (before slip compensation)	[22]	○	○	○	○
W04	Output frequency (after slip compensation)	[22]	○	×	○	○
W05	Output current	[24] (FGI)	○	○	○	○
		[19] (RTU)	○	○	○	○
		[24] (BUS) *1	×	○	○	○
W06	Output voltage	[3]	○	○	○	○
W07	Torque	[2]	×	○	○	○
W08	Rotation speed	[37]	×	○	○	○
W09	Load rotation speed	[37]	○	○	○	○
W10	Line speed	[37]	○	×	○	○
W11	PID process command	[12]	○	○	○	○
W12	PID feedback value	[12]	○	○	○	○
W13	Level of torque value A	[1]	×	×	○	○
W14	Level of torque value B	[1]	×	×	○	○
W15	Ratio value	[5]	×	×	×	○
W16	Rotation speed set value	[37]	×	○	○	○
W17	Load speed set value	[37]	○	○	○	○
W18	Line speed set value	[37]	○	×	○	○
W19	Constant feed time set value	[37]	○	×	○	×
W20	Constant feed time	[37]	○	×	○	×
W21	Input power	[24]	○	○	○	○
W22	Motor output	[24]	×	○	○	○
W23	Load rate	[2]	×	○	○	○
W24	Torque current	[2]	×	×	×	○
W26	Flux reference	[2]	×	×	×	○
W27	Timer operation remaining time	[1]	○	×	○	×
W28	Operation command source	[1]	○	○	○	○
W29	Frequency and PID command source	[1]	○	○	○	○
W30	Speed at percentage	[5]	×	○	○	○
W31	Speed set value at percentage	[5]	×	○	○	○
W32	PID output	[4]	×	○	○	○
W33	Analog input monitor	[12]	×	○	×	○
W35	Terminal [32] input voltage	[4]	×	×	×	○
W36	Terminal [C2] input current	[3]	×	×	×	○
W37	Terminal [A0] output voltage	[4]	×	×	×	○
W38	Terminal [CS] output frequency	[3]	×	×	×	○
W39	Pulse input monitor [X7]	[6]	×	×	×	○
W40	Control circuit terminal (input)	[43]	○	○	○	○
W41	Control circuit terminal (output)	[15]	○	○	○	○
W42	Communications control signal (input)	[14]	○	○	○	○
W43	Communications control signal (output)	[15]	○	○	○	○
W44	Terminal [12] input voltage	[4]	○	○	○	○
W45	Terminal [C1] input current	[4]	○	○	○	○
W46	FMA*2 output voltage	[3]	○	○	○	○
W47	FMP*2 output voltage	[3]	×	○	×	○
W48*3	FMP output frequency	[1]	×	○	○	○
W49	V2 terminal input voltage	[4]	×	○	○	○
W50	FMA*2 output current	[3]	×	○	×	○
W51	Situation of input terminals on DIO option	Multi [1] MEGA [77]	×	×	○	○

*1 BUS: The field bus option format is selected. For details about the field bus option, see the instruction manual for each field bus option.

*2 As for FRN□□G1□-□A and FRN□□G1□-□E, the terminal name changes from FMA to FM1 and FMP to FM2 respectively.

*3 Not applicable with FRN□□G1□-□A and FRN□□G1□-□E

Table 5.30 List of data format numbers (W codes) (Continued)

Code	Name	Format number	Support			
			Mini	Eco	Multi	MEGA
W52	Situation of output terminals on DIO option	Multi [1] MEGA [78]	×	×	○	○
W53	Pulse input (Master - side A/B phase)	[6]	×	×	○	○
W54	Pulse input (Master - side Z phase)	[1]	×	×	○	○
W55	Pulse input (Slave - side A/B phase)	[6]	×	×	○	○
W56	Pulse input (Slave - side Z phase)	[1]	×	×	○	○
W57	Current Position Pulse (Upper column)	[73]	×	×	○	○
W58	Current Position Pulse (Lower column)	[1]	×	×	○	×
W59	Stop Position Pulse (Upper column)	[73]	×	×	○	×
W60	Stop Position Pulse (Lower column)	[1]	×	×	○	×
W61	Difference Pulse of Position (Upper column)	[73]	×	×	○	×
W62	Difference Pulse of Position (Lower column)	[1]	×	×	○	×
W63	Positioning Status	[1]	×	×	○	×
W65	Terminal [FM1] output current	[3]	×	○*1	×	×
	Terminal [FM2] output current	[3]	×	×	×	○*2
W67	Cumulative operation time of electrolytic	[74]	×	×	○	○
W68	Cumulative operation time of cooling fan	[74]	×	×	○	○
W70	Cumulative operation time	[1]	○	○	○	○
W71	DC link circuit voltage	[1]	○	○	○	○
W72	Internal air highest temperature	[1]	×	○	×	○
W73	Heat sink maximum temperature	[1]	○	○	○	○
W74	Maximum effective current value	[24] (FGI)	○	○	○	○
		[19] (RTU)	○	○	○	○
		[24] (BUS) *3	×	○	○	○
W75	Main circuit capacitor's capacitor	[3]	○	○	○	○
W76	Cumulative ope. time of capacitor on PC board	[1]	○	○	○	×
W77	Cumulative ope. time of cooling fan	[1]	○	○	○	×
W78	Number of startups	[1]	○	○	○	○
W79	Cumulative ope. time of motor driving	[74]	×	○	○	×
W80	Standard fan life	[1]	×	○	×	×
W81	Integrating electric power	[45]	×	○	○	○
W82	Data used integrating electric power	[45]	×	○	○	○
W83	Number of RS485 ch1 errors	[1]	○	○	○	○
W84	Contents of RS485 ch1 error	[20]	○	○	○	○
W85	Number of RS485 ch2 errors	[1]	×	○	○	○
W86	Number of option communications errors		×	×	×	○
W87	Inverter's keypad's ROM version	[35]	○	○	○	○
W89	Remote keypad's ROM version	[35]	○	○	○	○
W90	Option 1 ROM version	[35]	×	○	○	○
W91	Option 2 ROM version	[35]	×	×	×	○
W92	Option 3 ROM version	[35]	×	×	×	○
W94	Contents of RS485 ch2 error	[20]	×	○	○	○
W95	Number of option communications errors	[1]	×	○	○	○
W96	Option communicate error contents	[1]	×	○	○	○
W97	Option communicate error contents	[1]	×	×	×	○
W98	Number of option communications errors	[1]	×	×	×	○
W99	Option communicate error contents	[1]	×	×	×	○

*1 Applicable only with FRN□□F1□-□A, FRN□□F1□-□E and FRN□□F1□-□U

*2 Applicable only with FRN□□G1□-□A and FRN□□G1□-□E

*3 BUS: The field bus option format is selected. For details about the field bus option, see the instruction manual for each field bus option.

Table 5.31 List of data format numbers (X codes)

Code	Name	Format number	Support			
			Mini	Eco	Multi	MEGA
X00	Alarm history (latest)	[41]	○	○	○	○
X01	Multiple alarm 1 (latest)	[40]	○	○	○	○
X02	Multiple alarm 2 (latest)	[40]	○	○	○	○
X03	Sub code	[1]	×	○	○	○
X05	Alarm history (last)	[41]	○	○	○	○
X06	Multiple alarm 1 (last)	[40]	○	○	○	○
X07	Multiple alarm 2 (last)	[40]	○	○	○	○
X08	Sub code	[1]	×	○	○	○
X10	Alarm history (second last)	[41]	○	○	○	○
X11	Multiple alarm 1 (second last)	[40]	○	○	○	○
X12	Multiple alarm 2 (second last)	[40]	○	○	○	○
X13	Sub code	[1]	×	○	○	○
X15	Alarm history (third last)	[41]	○	○	○	○
X16	Multiple alarm 1 (third last)	[40]	○	○	○	○
X17	Multiple alarm 2 (third last)	[40]	○	○	○	○
X18	Sub code	[1]	×	○	○	○
X20	Latest info. on alarm (output frequency)	[22]	○	○	○	○
X21	(output current)	[24] (FGI)	○	○	○	○
		[19] (RTU)	○	○	○	○
		[24] (BUS) *1	×	○	○	○
X22	(output voltage)	[1]	○	○	○	○
X23	(Torque)	[2]	×	○	○	○
X24	(set frequency)	[22]	○	○	○	○
X25	(operation status)	[16]	○	○	○	○
X26	(cumulative ope. time)	[1]	○	○	○	○
X27	(number of startups)	[1]	○	○	○	○
X28	(DC link circuit voltage)	[1]	○	○	○	○
X29	(internal air temperature)	[1]	×	○	×	○
X30	(heat sink temperature)	[1]	○	○	○	○
X31	(input terminal)	[43]	○	○	○	○
X32	(output terminal)	[15]	○	○	○	○
X33	(input terminal(com.))	[14]	○	○	○	○
X34	(output terminal(com.))	[15]	○	○	○	○
X35	(Input power)	[24]	×	○	○	○
X36	(Power consumption during alarm)	[76]	×	×	×	○
X37	(Operation status 2)	[29]	×	×	×	○
X60	Last info. on alarm (output frequency)	[22]	○	○	○	○
X61	(output current)	[24] (FGI)	○	○	○	○
		[19] (RTU)	○	○	○	○
		[24] (BUS) *1	×	○	○	○
X62	(output voltage)	[1]	○	○	○	○
X63	(Torque)	[2]	×	○	○	○
X64	(set frequency)	[22]	○	○	○	○
X65	(operation status)	[16]	○	○	○	○
X66	(cumulative ope. time)	[1]	○	○	○	○
X67	(number of startups)	[1]	○	○	○	○
X68	(DC link circuit voltage)	[1]	○	○	○	○
X69	(internal air temperature)	[1]	×	○	×	○
X70	(heat sink temperature)	[1]	○	○	○	○
X71	(input terminal)	[43]	○	○	○	○
X72	(output terminal)	[15]	○	○	○	○
X73	(input terminal(com.))	[14]	○	○	○	○
X74	(output terminal(com.))	[15]	○	○	○	○
X76	(Operation status 2)	[76]	×	×	×	○
X77	(Speed detection)	[29]	×	×	×	○

*1 BUS: The field bus option format is selected. For details about the field bus option, see the instruction manual for each field bus option.

Table 5.32 List of data format numbers (Z codes)

Code	Name	Format number	Support			
			Mini	Eco	Multi	MEGA
Z00	Second last info. on alarm (output frequency)	[22]	○	○	○	○
Z01	(output current)	[24] (FGI)	○	○	○	○
		[19] (RTU)	○	○	○	○
		[24] (BUS) *1	×	○	○	○
Z02	(output voltage)	[1]	○	○	○	○
Z03	(Torque)	[2]	×	○	○	○
Z04	(set frequency)	[22]	○	○	○	○
Z05	(operation status)	[16]	○	○	○	○
Z06	(cumulative ope. time)	[1]	○	○	○	○
Z07	(number of startups)	[1]	○	○	○	○
Z08	(DC link circuit voltage)	[1]	○	○	○	○
Z09	(internal air temperature)	[1]	×	○	×	○
Z10	(heat sink temperature)	[1]	○	○	○	○
Z11	(input terminal)	[43]	○	○	○	○
Z12	(output terminal)	[15]	○	○	○	○
Z13	(input terminal(com.))	[14]	○	○	○	○
Z14	(output terminal(com.))	[15]	○	○	○	○
Z16	(Operation status 2)	[74]	×	×	×	○
Z17	(Speed detection)	[74]	×	×	×	○
Z40	Cumulative operation time of motor (M1)	[74]	×	×	×	○
Z41	Cumulative operation time of motor (M2)	[74]	×	×	×	○
Z42	Cumulative operation time of motor (M3)	[74]	×	×	×	○
Z43	Cumulative operation time of motor (M4)	[74]	×	×	×	○
Z44	Number of starting time (M2)	[74]	×	×	×	○
Z45	Number of starting time (M3)	[74]	×	×	×	○
Z46	Number of starting time (M4)	[74]	×	×	×	○
Z50	Third last info. on alarm (output frequency)	[22]	○	○	○	○
Z51	(output current)	[24] (FGI)	○	○	○	○
		[19] (RTU)	○	○	○	○
		[24] (BUS) *1	×	○	○	○
Z52	(output voltage)	[1]	○	○	○	○
Z53	(Torque)	[2]	×	○	○	○
Z54	(set frequency)	[22]	○	○	○	○
Z55	(operation status)	[16]	○	○	○	○
Z56	(cumulative ope. time)	[1]	○	○	○	○
Z57	(number of startups)	[1]	○	○	○	○
Z58	(DC link circuit voltage)	[1]	○	○	○	○
Z59	(internal air temperature)	[1]	×	○	×	○
Z60	(heat sink temperature)	[1]	○	○	○	○
Z61	(input terminal)	[43]	○	○	○	○
Z62	(output terminal)	[15]	○	○	○	○
Z63	(input terminal(com.))	[14]	○	○	○	○
Z64	(output terminal(com.))	[15]	○	○	○	○
Z66	(Operation status 2)	[76]	×	×	×	○
Z67	(Speed detection)	[29]	×	×	×	○
Z90	Current Position Pulse (Upper column)	[73]	×	×	×	○
Z91	Current Position Pulse (Lower column)	[1]	×	×	×	○
Z92	Stop Position Pulse (Upper column)	[73]	×	×	×	○
Z93	Stop Position Pulse (Lower column)	[1]	×	×	×	○
Z94	Difference Pulse of Position (Upper column)	[73]	×	×	×	○
Z95	Difference Pulse of Position (Lower column)	[1]	×	×	×	○

*1 BUS: The field bus option format is selected. For details about the field bus option, see the instruction manual for each field bus option.

5.2.2 Data format specifications

The data in the data fields of a communications frame are 16 bits long, binary data, as shown below.

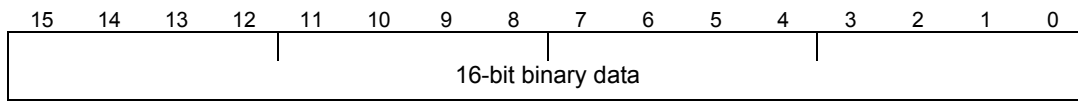

For the convenience of description, 16-bit data is expressed in hexadecimal with one upper-order byte (eight bits from 15 to 8) and one lower-order byte (eight bits from 7 to 0).

For example, the following data is 1234H in hexadecimal and expressed as

12 _H	34 _H
-----------------	-----------------

.

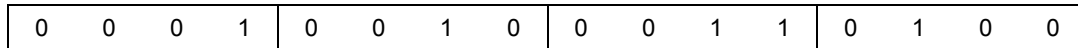

Data format [1] Integer data (positive): Minimum step 1

(Example) When F05 (base) frequency voltage = 200V

200 = 00C8_H Consequently \Rightarrow

00 _H	C8 _H
-----------------	-----------------

Data format [2] Integer data (positive/negative): Minimum step 1

(Example) When the value is -20

-20 = FFEC_H Consequently, \Rightarrow

FF _H	EC _H
-----------------	-----------------

Data format [3] Decimal data (positive): Minimum step 0.1

(Example) When F17 (gain frequency set signal) = 100.0%

100.0 x 10 = 1000 = 03E8_H Consequently, \Rightarrow

03 _H	E8 _H
-----------------	-----------------

Data format [4] Decimal data (positive/negative): Minimum step 0.1

(Example) When C31 (analog input offset adjustment) = -5.0%

-5.0 x 10 = -50 = FFCE_H Consequently, \Rightarrow

FF _H	CE _H
-----------------	-----------------

Data format [5] Decimal data (positive): Minimum step 0.01

(Example) C05 (multistep frequency) = 50.25Hz

50.25 x 100 = 5025 = 13A1_H Consequently, \Rightarrow

13 _H	A1 _H
-----------------	-----------------

Data format [6] Decimal data (positive/negative): Minimum step 0.01

(Example) When M07 (actual torque value) = -85.38%

-85.38 x 100 = -8538 = DEA6_H Consequently, \Rightarrow

DE _H	A6 _H
-----------------	-----------------

Data format [7] Decimal data (positive): Minimum step 0.001

(Example) When F51(electronic thermal (permissible loss)) = 0.105kW

0.105 x 1000 = 105 = 0069_H Consequently, \Rightarrow

00 _H	69 _H
-----------------	-----------------

Data format [8] Decimal data (positive/negative): Minimum step 0.001

(Example) When the data is -1.234

-1.234 x 1000 = -1234 = FB2E_H Consequently, \Rightarrow

FB _H	2E _H
-----------------	-----------------

Data format [10] Alarm codes

Table 5.33 List of alarm codes

Code	Description	Code	Description
0	No alarm	28	PG disconnection
1	Overcurrent (during acceleration)	29	NTC disconnection error
2	Overcurrent (during deceleration)	31	Memory error
3	Overcurrent (during constant speed operation)	32	Keypad communications error
5	Ground fault	33	CPU error
6	Overvoltage (during acceleration)	34	Option communications error
7	Overvoltage (during deceleration)	35	Option error
8	Overvoltage (during constant speed operation or stopping)	36	Run operation error
10	Undervoltage	37	Tuning error
11	Input phase loss	38	RS-485 communications error (communications port1)
14	Fuse blown	44	Motor overload: motor 3
16	Charging circuit fault	45	Motor overload: motor 4
17	Heat sink overheat	46	Output phase loss
18	External alarm	47	Following error, excessive speed deviation
19	Internal air overheat	51	Data save error on insufficient voltage
20	Motor protection (PTC/NTC thermistor)	53	RS-485 communications error (Option/Communications port 2)
22	Braking resistor overheat	54	Hardware error
23	Motor overload	57*1	EN circuit error
24	Motor overload: motor 2	58	PID feedback disconnection detected
25	Inverter overload	59	DB transistor trouble
27	Over speed protection	100	DC fan lock detected

*1 (Applicable only with FRN□□G1□-□E and FRN□□G1□-□A.)

Code	Description		Code	Description	
101	Motor overload warning	OL	106	Low torque detected	LT
102	Cooling fin overheat warning	OH	107	Thermistor detected (PTC)	PTC
103	Life warning	LF	108	Machine life (accumulated operation hours)	LE
104	Command loss	CL	109	Machine life (No. of starting times)	LS
105	PID warning output	PI	254	Simulated error	ERR

(Example) In the case of overvoltage (during acceleration) (OV)

6 = 0006_H Consequently,

⇒

00 _H	06 _H
-----------------	-----------------

Data format [11] Capacity code (unit: kW)

As shown in the table below, the capacity (kW) is multiplied by 100.

Table 5.34 Capacities and data

Capacity (kW)	Data	Capacity (kW)	Data	Capacity (kW)	Data
0.06	6	22	2200	280	28000
0.1	10	30	3000	315	31500
0.2	20	37	3700	355	35500
0.4	40	45	4500	400	40000
0.75	75	55	5500	450	45000
1.5	150	75	7500	500	50000
2.2	220	90	9000	550	55000
3.7	370	110	11000	600	60000
5.5	550	132	13200	650	60650
7.5	750	160	16000	700	60700
11	1100	200	20000	750	60750
15	1500	220	22000	800	60800
18.5	1850	250	25000	1000	61000

(Example) When the capacity is 2.2 kW

$$2.20 \times 100 = 220 = 00DC_H \text{ Consequently,}$$

⇒

00 _H	DC _H
-----------------	-----------------

Data format [12] Floating point data (accel./decal. time, PID display coefficient)

15	14	13	12	11	10	9	8	7	6	5	4	3	2	1	0
Polarity	0	0	0	Exponent											
	Unused				Mantissa										

Polarity: 0 → Positive (+), 1 → Negative (-) Exponent: 0 to 3 Mantissa: 1 to 999

Value expressed in this form = (polarity) Mantissa x (Exponent - 2) power of 10

Value	Mantissa	Exponent	(Exponent - 2) power of 10
0.01 to 9.99	1 to 999	0	0.01
10.0 to 99.9	100 to 999	1	0.1
100 to 999	100 to 999	2	1
1000 to 9990	100 to 999	3	10

(Example) When F07 (acceleration time 1) = 20.0 seconds

$$20.0 = 200 \times 0.1 \Rightarrow 0000\ 0100\ 1100\ 1000_b = 04C8_H$$

⇒

04 _H	C8 _H
-----------------	-----------------

Consequently,

Data format [14] Operation command

15	14	13	12	11*1	10	9	8	7	6	5	4	3	2	1	0
RST	XR (REV)	XF (FWD)	0	EN	X9	X8	X7	X6	X5	X4	X3	X2	X1	REV	FWD
↑ Alarm reset	General-purpose input		Unused	EN terminal	General-purpose input								FWD: Forward command REV: Reverse command		

*1 bit11: The EN terminal is a bit dedicated for monitor and the terminal command cannot be input through communications. (Applicable only with FRN□□G1□-□E and FRN□□G1□-□A.)

(All bits are turned ON when set to 1.)

(Example) When S06 (operation command) = FWD, X1 = ON

0000 0000 0000 0101_b = 0005_H Consequently, ⇒

00 _H	05 _H
-----------------	-----------------

Data format [15] General-purpose output terminal

15	14	13	12	11	10	9	8	7	6	5	4	3	2	1	0
0	Y3A	Y2A	Y1A	0	0	0	30	0	0	0	Y5	Y4	Y3	Y2	Y1
Unused	Relay option output (Eco only)			Unused			↑ Alarm (general-purpose output)	Unused			General-purpose output				

(All bits are turned ON when set to 1.)

(Example) When M15 (general-purpose output terminal) = Y1 = ON

0000 0000 0000 0001_b = 0001_H Consequently, ⇒

00 _H	01 _H
-----------------	-----------------

Data format [16] Operation status

15	14	13	12	11	10	9	8	7	6	5	4	3	2	1	0
BUSY	0	0	RL	ALM	DEC	ACC	IL	VL	0	NUV	BRK	INT	EXT	REV	FWD

(All bits are turned ON or become active when set to 1.)

Bit	Symbol	Description	Support*1				Bit	Symbol	Description	Support*1			
			Mini	Eco	Multi	MEGA				Mini	Eco	Multi	MEGA
0	FWD	During forward rotation	○	○	○	○	8	IL	During current limiting	○	○	○	○
1	REV	During reverse rotation	○	○	○	○	9	ACC	During acceleration	○	○	○	○
2	EXT	During DC braking (or during pre-exciting)	○	○	○	○	10	DEC	During deceleration	○	○	○	○
3	INT	Inverter shut down	○	○	○	○	11	ALM	Alarm relay (for any fault)	○	○	○	○
4	BRK	During braking (fixed to 0 for FRENIC-Mini)	×	○	○	○	12	RL	Communications effective	○	○	○	○
5	NUV	DC link circuit voltage established (0 = undervoltage)	○	○	○	○	13	0	–	×	×	×	×
6	TL	During torque limiting	×	×	○	○	14	0	–	×	×	×	×
7	VL	During voltage limiting	○	○	○	○	15	BUSY	During function code data writing	○	○	○	○

*1 The "Support" column indicates whether each inverter type supports the corresponding bit or not. The symbol "O" means the code is supported and the symbol "X" means that the code is not supported (fixed to 0).

Data format [17] Model code															
15	14	13	12	11	10	9	8	7	6	5	4	3	2	1	0
Model				Generation				Destination				Input power supply			

Table 5.35 List of model codes

Code	1	2	3	4	5	6	7	8	9	A	B	C	D	E
Model	VG	G	P	E	C	S	DPS	DGS	H (1667Hz)	H (3000Hz)	F	RHC	RHR	Lift
Generation	11 series	7 series	1 series RHR A series RHC C series	Eco PLUS series										
Destination	Japan (standard)	Asia	China	Europe	USA	Taiwan								
Input power supply	Single-phase 100V	Single-phase 200V	Three-phase 200V	Three-phase 400V										

(Example) When the inverter type is FRN1.5C 1 S-2 J

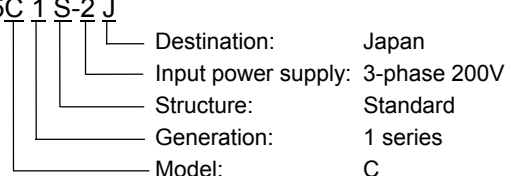

Since "model ":C is represented by code 5, "generation": 1 series by code 3, "destination": Japan (standard) by 1, and "input power supply": 3-phase 200V by 3, the model code is 5313_H.

Data format [19] Current value

Current values are decimal data (positive). The minimum step is 0.01 for an inverter capacity of 22kW (30HP) or less and 0.1 for an inverter capacity of 30kW (40HP) or more.

When inverter capacity is 22kW (30HP) or less, any data higher than 655A cannot be written. No correct value can be read out when a direction for write data higher than 655A is issued.

Current data is rounded down on and after the fifth digit inside the inverter. (Ex.: When a writing direction of 107.54A is issued to an inverter with a capacity of 22kW (30HP), 107.5A is written.)

(Ex.) When F11 (electronic thermal operation level) = 107.0A (40HP)

$$107.0 \times 10 = 1070 = 042E_H, \text{ consequently} \Rightarrow \begin{array}{|c|c|} \hline 04_H & 2E_H \\ \hline \end{array}$$

(Ex.) When F11 (electronic thermal operation level) = 3.60A (1HP)

$$3.60 \times 10 = 360 = 0168_H, \text{ consequently} \Rightarrow \begin{array}{|c|c|} \hline 01_H & 68_H \\ \hline \end{array}$$

Data format [20] Communications error

Table 5.36 Communications error codes (common to both protocols)

Code	Description	Code	Description
71	Checksum error, CRC error ⇒ No response	73	Framing error, overrun error, buffer full ⇒ No response
72	Parity error ⇒ No response		

Table 5.37 Communications error codes (for Fuji general-purpose inverter protocol)

Code	Description	Code	Description
74	Format error	78	Function code error
75	Command error	79	Write disabled
76	Link priority error	80	Data error
77	Function code data write right error	81	Error during writing

Table 5.38 Communications error codes (for RTU protocol)

Code	Description	Code	Description
1	Improper 'FC'	3	Improper data (range error)
2	Improper address (function code error)	7	NAK (link priority, no right, write disabled)

(Example) In case of an improper address

2 = 0002_H Consequently, ⇒

00 _H	02 _H
-----------------	-----------------

Data format [21] Auto tuning (not supported by FRENIC-Mini)

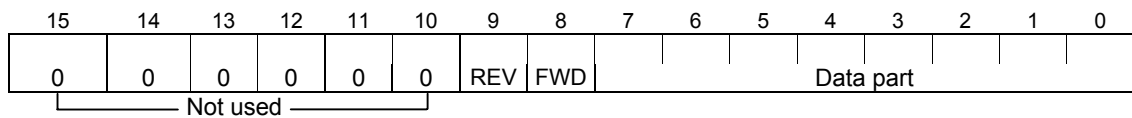

When FWD is 1, this data is the forward rotation command. When REV is 1, this data is the reverse rotation command. However, if both FWD and REV are 1, the command is not effective. Both FWD and REV are 0 for reading.

(Ex.) When P04 (motor 1 automatic tuning) = 1 (forward rotation),

0000 0001 0000 0001_b = 0101_H Consequently, ⇒

01 _H	01 _H
-----------------	-----------------

Data format [22] Frequency data

Decimal data (positive): Resolution 0.01Hz

Data format [23] Polarity + decimal data (positive)
 (for Fuji general-purpose inverter protocol)

Decimal data (positive): Resolution 0.01Hz

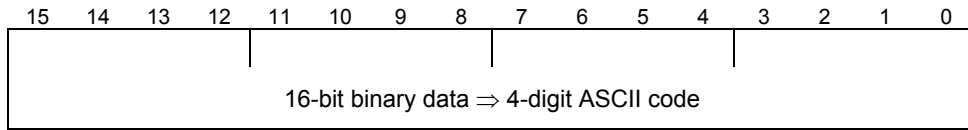

For reverse rotation, add a negative sign (-) (ASCII) to the special additional data in the standard frame, or for forward rotation, enter a space (ASCII).

(Example) When maximum frequency = 60Hz and M09 (output frequency) = 60.00Hz (forward rotation)

$60.00 \times 100 = 6000 = 1770_H$ Consequently, \Rightarrow

	1	7	7	0
--	---	---	---	---

(Positive data is in the same data format as data format [5].)

Data format [24] Floating point data

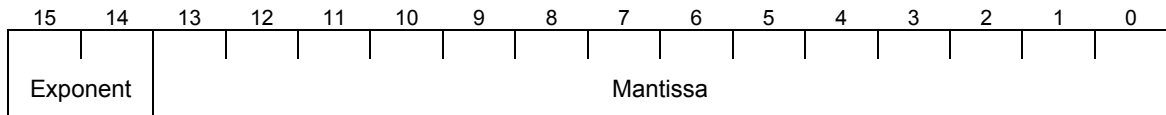

Exponent: 0-3 Mantissa: 1 to 9999

The value expressed by this format = the mantissa $\times 10^{(\text{exponent}-2)}$

Numeric value	Mantissa	Exponent	$10^{(\text{exponent}-2)}$
0.00 to 99.99	0 to 9999	0	0.01
100.0 to 999.9	1000 to 9999	1	0.1
1000 to 9999	1000 to 9999	2	1
10000 to 99990	1000 to 9999	3	10

Data format [25] Capacity code (for HP)

As shown in the table below, the capacity (HP) is multiplied by 100.

Table 5.39 Capacities and data (for HP)

Code	Capacity (HP)	Code	Capacity (HP)	Code	Capacity (HP)
7	0.07 (reserved)	3000	30	40000	400
15	0.15 (reserved)	4000	40	45000	450
25	0.25	5000	50	50000	500
50	0.5	6000	60	60000	600
100	1	7500	75	60700	700
200	2	10000	100	60750	750
300	3	12500	125	60800	800
500	5	15000	150	60850	850
750	7.5	17500	175	60900	900
1000	10	20000	200	60950	950
1500	15	25000	250	61000	1000
2000	20	30000	300	61050	1050
2500	25	35000	350		

(Example) When the capacity is 3HP

$3 \times 100 = 300 = 012C_H$ Consequently, \Rightarrow

01 _H	2C _H
-----------------	-----------------

Data format [29] Positive/Negative data of values converted into standard (p.u.) with 20,000

(Example) Speed (frequency) Data of $\pm 20,000/\pm$ maximum speed (frequency)

Data format [35] ROM version

Range: 0 to 9999

Data format [37] Floating point data (load rotation speed, etc.)

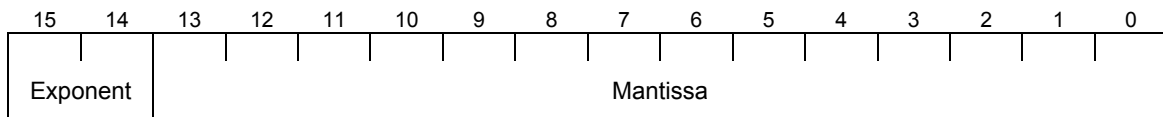

Exponent: 0-3 Mantissa: 1 to 9999

The value expressed by this format = the mantissa $\times 10^{(\text{exponent}-2)}$

Numeric value	Mantissa	Exponent	$10^{(\text{exponent}-2)}$
0.01 to 99.99	1 to 9999	0	0.01
100.0 to 999.9	1000 to 9999	1	0.1
1000 to 9999	1000 to 9999	2	1
10000 to 99990	1000 to 9999	3	10

Data format [40] Alarm factor

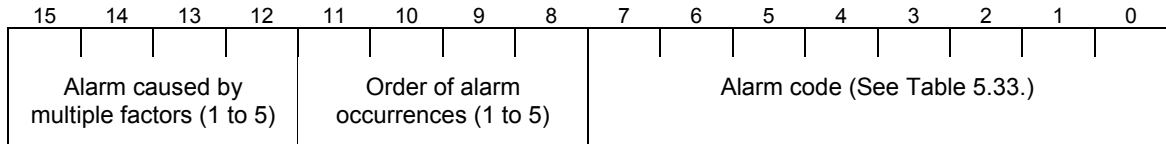

Data format [41] Alarm history

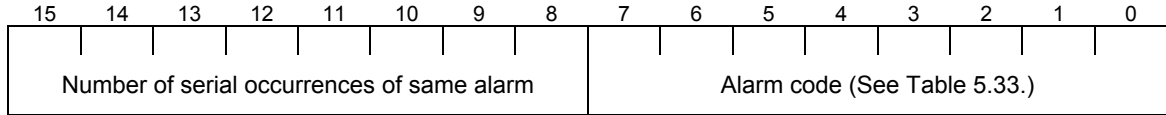

Indicates the content of an alarm that has occurred and the number of serial occurrence times of the alarm.

Data format [43] Operation command (for I/O check)

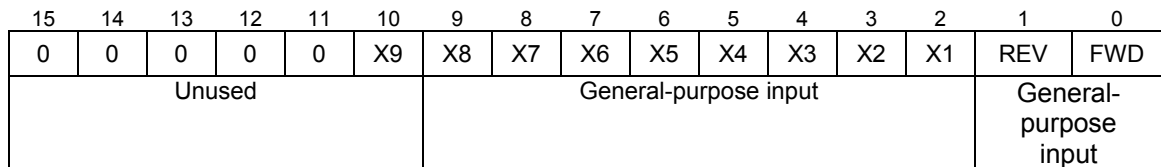

(All bits are turned ON when set to 1.)

Data format [44] Operation status 2

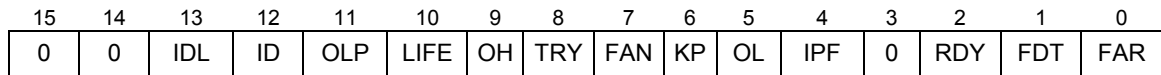

(All bits are turned ON or become active when set to 1.)

Bit	Symbol	Description	Support*1				Bit	Symbol	Description	Support*1			
			Mini	Eco	Multi	MEGA				Mini	Eco	Multi	MEGA
0	FAR	Frequency arrival signal	○	○	○	○	8	TRY	Retry in operation	○	○	○	○
1	FDT	Frequency level detection	○	○	○	○	9	OH	Heat sink overheat early warning	×	○	○	○
2	RDY	Inverter ready to run	×	○	○	○	10	LIFE	Lifetime alarm	○	○	○	○
3	SWM2	2nd motor is selected	×	×	○	○	11	OLP	Overload prevention control	○	○	○	○
4	IPF	Auto-restarting after recovery of power	○	○	○	○	12	ID	Current detection	○	○	○	○
5	OL	Motor overload early warning	○	○	○	○	13	IDL	Low level current detection	○	×	×	○
6	KP	Running per keypad	×	×	×	○	14	ID2	Current detection 2	×	×	○	○
7	FAN	Cooling fan in operation	×	○	×	○	15	0	–	×	×	×	×

*1 The "Support" column indicates whether each inverter type supports the corresponding bit or not. The symbol "O" means the code is supported and the symbol "X" means that the code is not supported (fixed to 0).

Data format [45] Floating point data

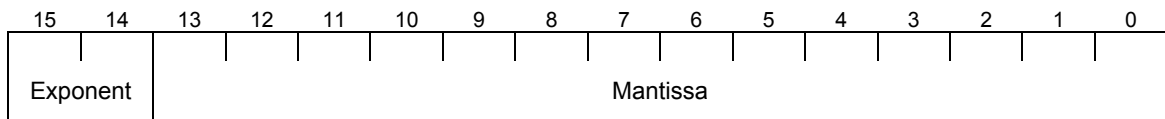

Exponent: 0-3 Mantissa: 0 to 9999

The value expressed by this format = the mantissa $\times 10^{(\text{exponent}-3)}$

Numeric value	Mantissa	Exponent	$10^{(\text{exponent}-3)}$
0.000 to 9.999	0 to 9999	0	0.001
10.0 to 99.9	1000 to 9999	1	0.01
100.0 to 999.9	1000 to 9999	2	0.1
1000 to 9999	1000 to 9999	3	1

Data format [67] Operation command source codes

Code	Description	Remarks
0	Keypad operation (Rotating direction: Depends on the terminal input)	Same with the selections for F02
1	Terminal operation	
2	Keypad operation (CW)	
3	Keypad operation (CCW)	
4	Operation command 2	
5 to 19	Reserved	
20	RS-485 channel1	
21	RS-485 channel2	
22	Bus option	
23	FRENIC Loader	

Data format [68] Frequency command source codes

Code	Description	Remarks	
0	Keypad key operation	Same with the selections for F01	
1	Voltage input (Terminal [12])		
2	Current input (Terminal [C1])		
3	Voltage input (Terminal [12]) + Current input (Terminal [C1])		
4	Inverter body volume		
5	Voltage input (Terminal [V2])		
7	UP/DOWN		
8	Keypad key operation (Balanceless, bumpless functions are activated.)		
11	Digital input (option)		
12	Pulse train input		
20	RS-485 channel1		
21	RS-485 channel2		
22	Bus option		
23	FENIC Loader		
24	Multi-step		
25	JOG		
30 *1	PID TP		
31 *1	PID analog1		
33 *1	PID UP/DOWN		
34 *1	PID communications command		
36 *1	PID multi-step		

*1 Under the PID dancer control, the inverter monitors the PID command source although the frequency command becomes effective as the main setting.

Data format [73] Integer data (positive/negative sign bit)

Resolution 1 (The high-order digit of position control data)

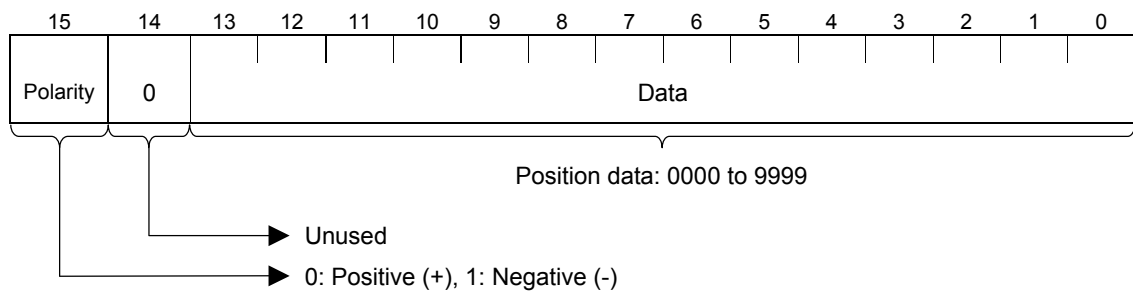

Data format [74] Integer data (positive): by 10 hours

(Example) M81 (Maintenance remaining hours-M1) = 12340 hours

12340 ÷ 10 = 04D2_H Consequently

⇒

04_H

D2_H

Data format [75] Integer data (positive) + [P] Exception for position control

Based on the positive integer data, setting of “-1” is permitted exceptionally. When “-1” is set on the touch probe or the loader, [P] is displayed.

Data format [76] Operating status 2

15	14	13	12	11	10	9	8	7	6	5	4	3	2	1	0
Spare	Spare	Spare	Spare	Spare	Spare	Spare	Spare	Speed limit ON	Spare	Select motor	Control method				

(Spares are always set to “0.”)

Signal name	Description	Mini	Eco	Multi	MEGA
Control method	The final control method including set values and terminal conditions are shown below. 0: V/f control without slip compensation 1: Dynamic torque-vector control 2: V/f control with slip compensation 3: V/f control with speed sensor 4: Dynamic torque-vector control with speed sensor 5: Vector control without speed sensor 6: Vector control with speed sensor 10: Torque control (vector control without speed sensor) 11: Torque control (vector control with speed sensor) Other than the above: Reserved	×	×	×	○
Motor selection	Selected motor is shown 00 _b : motor1 01 _b : motor2 10 _b : motor3 11 _b : motor4	×	×	×	○
Speed limit ON	“1” is set during speed limit.	×	×	×	○

Data format [77] Optional input terminals

15	14	13	12	11	10	9	8	7	6	5	4	3	2	1	0
I16	I15	I14	I13	I12	I11	I10	I9	I8	I7	I6	I5	I4	I3	I2	I1

Data format [78] Optional output terminals

15	14	13	12	11	10	9	8	7	6	5	4	3	2	1	0
0	0	0	0	0	0	0	0	08	07	06	05	04	03	02	01

┌──────────────────┐ Unused ───────────────────┘

===Appendix===

CHAPTER 6

FLOOR LEVEL NETWORK

(P1 PROTOCOL)

The FRN***F1S-*U (FRENIC-Eco USA version) has an optional built-in Floor Level Network (FLN) communication driver and point database allowing the FRENIC-Eco to coexist on an APOGEE® network with other FLN devices.

A Fuji Electric systems representative is responsible for proper configuration of the drive for its primary application, while a Siemens Building Technologies, Inc. representative is responsible for field panel programming, to make use of the drive’s functionality in the building automation system. As such, there must be coordination between the Fuji Electric systems and Siemens Building Technologies representatives to ensure that programming of the FRENIC-Eco is consistent with requirements for field panel programming.

This chapter describes how the FRN***F1S-*U can be accessed through a field panel and how it can be used as a part of a larger control scheme.

Table of Contents

- 6.1 Messages 6-1
 - 6.1.1 polling/selecting 6-1
- 6.2 Point Database 6-1
- 6.3 Setting up Communications of the FRENIC-Eco 6-1
- 6.4 Using the FRENIC-Eco 6-2
- 6.5 Strategies 6-3
 - 6.5.1 Monitoring 6-3
 - 6.5.2 Supervisory Control 6-3
 - 6.5.3 Slaving the Drive 6-4
- 6.6 Other Functionality 6-4
 - 6.6.1 Start and stop the drive 6-4
 - 6.6.2 Change drive directions 6-4

6.6.3	Lock the FRENIC-Eco panel.....	6-4
6.6.4	Digital Outputs	6-4
6.6.5	Analog Inputs monitor	6-5
6.6.6	Loop gains	6-5
6.6.7	Reading and resetting faults	6-5
6.6.8	Address limitations.....	6-5
6.6.9	Point 90,91,92,93 Read/Write Parameter Number (Parameter Data).....	6-10
6.6.10	Reading and Writing from/to Inverter's Function Codes.....	6-11

6.1 Messages

6.1.1 polling/selecting

When the FRENIC-Eco receives a request frame from the host addressed to itself (local station), the FRENIC-Eco sends back a response frame.

Polling/ Selecting

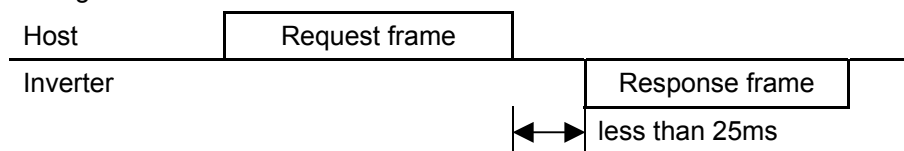

6.2 Point Database

Table 6.3 presents the point database information for FLN. For complete descriptions of these points, See this manual and FRENIC-Eco Instruction Manual (*INR-SI47-0882a-E* or *INR-SI47-1225-E*).

For more information on installation, start-up, and programming, See FRENIC-Eco Drives User's Manual (*MEH456*).

6.3 Setting up Communications of the FRENIC-Eco

Set up of the FRENIC-Eco variable frequency drive for FLN communications and control must be performed by the drive representative. This document provides the correct parameters required for FLN communications and control of the drive.

Table 6.1 lists the values required for proper FLN communications and control:

Table 6.1 Set-up Parameters.

Parameter Number/Name	Value
H30 / Link functions (operation selection)	3 = Possible via RJ45 socket port 8 = Possible via Optional terminal block port
y01 / Station address of RJ45 port	Set the Node address (default=1)
y04 / Baud rate of RJ45 port	Select P1 baudrate (default =19200) 1 = 4800, 2 = 9600 Also the following extended settings are possible; 0 = 2400, 3 = 19200 and 4 = 38400
y10 / Protocol Select of RJ45 port	4 = P1 Protocol
y11 / Station address of Optional port	Set the Node address (default=1)
y14 / Baud rate of Optional port	Select P1 baudrate (default =19200) 1 = 4800, 2 = 9600 Also the following extended settings are possible; 0 = 2400, 3 = 19200 and 4 = 38400
y20 / Protocol Select of Optional port	4 = P1 Protocol

6.4 Using the FRENIC-Eco

The FRENIC-Eco controls the speed of fans, pumps, and other equipment. The following strategies achieve a required control sequence. The field panel commands other tasks and functions specific to the FRENIC-Eco.

A Siemens Building Technologies representative must communicate all control requirements to a factory trained Fuji Electric systems representative before setting up the FRENIC-Eco. The Fuji Electric systems representative must implement these strategies, tasks, and functions prior to setting up the FRENIC-Eco.

6.5 Strategies

6.5.1 Monitoring

Several drive parameters are available for monitoring purposes. These include DR.FREQUENCY (Point 3), DR.TORQUE(Point4), DR.CURRENT (Point 5), DR.VOLTAGE (Point 6), DR.POWER (Point 7), OPERAT.TIME (Point 8), and INTEGRAT.PWR (Point 9). These points can be unbundled for monitoring or used in various global control strategies.

6.5.2 Supervisory Control

This is the most typical application. The sensor for the control variable (e.g., water temperature) is hard-wired to the FRENIC-Eco and the control device (fan) is modulated using the control loop (PI loop macro must be enabled during drive set-up) that is built into the FRENIC-Eco. The set point for the control variable (water temperature set point) is unbundled and commanded by the field panel, based on some building control strategy implemented in PPCL.

When this strategy is used, the point to unbundle and command for the set point is REF.FREQ (Point 21). The control variable (e.g., water temperature) can be monitored by unbundling PID FEEDBACK (Point 55). These points are provided with units of percent, where 0% and 100% correspond to the range of the sensor being used to measure the control variable. These points have default units in Hz. If other units are required, unbundle these points with appropriate slopes and intercepts. The new intercept will be equal to the lowest value of the desired range. The following formula lets you define a new slope and intercept in order to accomplish the unit conversion.

$$\begin{aligned} \text{New Slope} &= \frac{(\text{Desired Range}) \times (\text{Slope of Existing Point})}{\text{Range of Existing Point}} \\ &= \frac{(60 - 0 \text{ HZ}) \times (0.01)}{100 - 0 \%} = 0.006 \end{aligned}$$

New Intercept is equal to the lowest value of the desired range.

The following examples illustrate this conversion procedure:

6.5.2.1 Example

You are controlling water temperature from a cooling tower using the FRENIC-Eco to control a fan. The temperature sensor has a range of 30 to 250 degrees Fahrenheit.

To unbundle the set point (REF.FREQ), for commanding in degrees Fahrenheit, where 0 to 60 Hz is equal to 30 to 250 degrees Fahrenheit:

New Intercept = 30 (the temperature that corresponds to 0%)

$$\begin{aligned} \text{New Slope} &= \frac{(\text{Desired Range}) \times (\text{Slope of Existing Point})}{\text{Range of Existing Point}} \\ &= \frac{(250 - 30 \text{ degrees Fahrenheit}) \times (0.1)}{100 - 0 \%} = 0.22 \end{aligned}$$

To unbundle the feedback (PID FEEDBACK) for monitoring in degrees Fahrenheit:

New Intercept = 30

$$\begin{aligned} \text{New Slope} &= \frac{(\text{Desired Range}) \times (\text{Slope of Existing Point})}{\text{Range of Existing Point}} \\ &= \frac{(250 - 30 \text{ degrees Fahrenheit}) \times (0.01)}{100 - 0\%} = 0.022 \end{aligned}$$

6.5.3 Slaving the Drive

In this strategy, the sensor is connected to the APOGEE network at a remote location, and the control loop is executed in PPCL. The drive speed command is passed from the field panel to the FRENIC-Eco by commanding REF.FREQ (Point 21).

 CAUTION	This strategy is not normally recommended because it means that the loop is being closed over the network. Delays due to network traffic can cause control to be degraded or lost, and depending on the setup of the drive, if there is a problem with the network, the drive may cause physical damage to the HVAC system by winding up to its maximum or dropping off to its minimum speed.
--	---

6.6 Other Functionality

Each of the following functions must be enabled during start-up of the FRENIC-Eco.

6.6.1 Start and stop the drive

CMD RUN.STOP (Point 25) can be commanded to start or stop the drive. RUN.STOP (Point 24) shows the current status of the drive.

6.6.2 Change drive directions

CMD FWD.REV (Point 23) can be commanded to change the drive direction. FWD.REV (Point 22) shows the current direction of the drive rotation.

 CAUTION	Changing drive directions while the controlled equipment is moving may damage HVAC equipment.
--	---

6.6.3 Lock the FRENIC-Eco panel

Locking the panel prevents users from modifying any parameters locally at the drive panel. LOCK PANEL (Point 33) can be commanded to lock and unlock the panel.

6.6.4 Digital Outputs

Y1 (Point 40), Y2 (Point 41), Y3 (Point 42), and Y5 (Point 44) are physical DOs on the FRENIC-Eco. Their purpose depends on how the drive has been set-up. The drive can be programmed so that these points can display various limits, warnings, and status conditions. Some examples include current limiting, undervoltage detection, and motor overload early warning.

6.6.5 Analog Inputs monitor

AI VALUE 12 (Point 56), AI VALUE C1(Point 57), and AI VALUE V2 (Point 58) are monitors of an analog value inputted into physical AIs on the FRENIC-Eco.

6.6.6 Loop gains

PID P GAIN (Point 52) and PID I TIME (Point 53) are gain parameters similar to the P and I gains in the APOGEE TECs. The Fuji Electric systems PID loop is structured differently than the Siemens loop, so there is not a one-to-one correspondence between the gains. The following formulas allow translation from Fuji Electric systems gains to Siemens gains and vice versa:

Converting from Fuji Electric systems PI gains to Siemens P and I gains

$$P \text{ GAIN}_{\text{Siemens}} = PI \text{ GAIN}_{\text{FujiElectric}} \times 0.000015$$

$$I \text{ GAIN}_{\text{Siemens}} = \frac{PI \text{ GAIN}_{\text{FujiElectric}}}{PI \text{ TIME}_{\text{FujiElectric}}} \times 0.0015$$

Converting from Siemens P and I gains to Fuji Electric systems PI gains

$$P \text{ GAIN}_{\text{FujiElectric}} = PI \text{ GAIN}_{\text{Siemens}} \times 66700$$

$$I \text{ GAIN}_{\text{FujiElectric}} = \frac{PI \text{ GAIN}_{\text{Siemens}}}{PI \text{ TIME}_{\text{Siemens}}} \times 667$$

6.6.7 Reading and resetting faults

FAULT (Point 80) shows the current status of the drive. FLT.MEM.0 (Point 83) contains the code for the most recent fault. LAST FAULT (Point 82) contains the code for the second most recent fault. See Table 6.2 for descriptions of the fault codes. The drive can be reset back to OK mode by commanding FAULT RESET (Point 81) to RESET.

6.6.8 Address limitations

The default value for CTRL ADDRESS (Point 1) is 1.

Table 6.2 FRENIC-Eco Drive Faults.

Fault Number	Meaning
1	Overcurrent in acceleration (OC1)
2	Overcurrent in deceleration (OC2)
3	Overcurrent in constant speed (OC3)
5	Earth fault (EF)
6	Overvoltage in acceleration (OU1)
7	Overvoltage in deceleration (OU2)
8	Overvoltage in constant speed or stopping (OU3)
10	Undervoltage (LU)
11	Input phase loss (Lin)
14	Fuse blowout (FUS)
16	Charging circuit abnormal (PbF)
17	Cooling fin overheat (OH1)
18	External alarm (OH2)
19	Inverter inside overheat (OH3)
20	Motor protection by PTC thermistor (OH4)
22	Braking resistor overheat (dbH)
23	Motor overload (OL1)
25	Inverter overload (OLU)
31	Memory error (Er1)
32	Keypad communications error (Er2)
33	CPU error (Er3)
34	Option communications error (Er4)
35	Option error (Er5)
36	Run operation error (Er6)
37	Tuning error (Er7)
38	RS485 communications error in RJ45 (Er8)
46	Output phaseloss (OPL)
51	Data save error on insufficient voltage (ErF)
53	RS485 communications error in option (ErP)
54	LSI error on power PCB (ErH)

Table 6.3 Point Database for FLN.

Point Number	Point Type	Subpoint Name	Factory Default (SI Units)	Engr. Units (SI Units)	Slope (SI Units)	Intercept (SI Units)	On Text	Off Text
1	LAO	CTRL ADDRESS	1	–	1	0	–	–
2	LAO	APPLICATION	2743	–	1	0	–	–
{3}	LAI	DR.FREQUENCY	0	HZ	0.01	0	–	–
{4}	LAI	DR.TORQUE	0	PCT	0.01	0	–	–
{5}	LAI	DR.CURRENT	0	PCT	0.01	0	–	–
{6}	LAI	DR.VOLTAGE	0	VOLTS (V)	0.1	0	–	–
{7}	LAI	DR.POWER	0	PCT	0.01	0	–	–
{8}	LAI	OPERAT. TIME	0	HRS	1	0	–	–
{9}	LAI	INTEGRAT.PWR	0	KWH	10	0	–	–
{10}	LDI	READY	NOTRDY	–	1	0	RDY	NOTRDY
{11}	LDI	IN ACCEL	NO ACC	–	1	0	ACC	NO ACC
{12}	LDI	IN DECEL	NO DEC	–	1	0	DEC	NO DEC
{13}	LDI	DRIVE.AT.REF	NOTREF	–	1	0	AT REF	NOTREF
{14}	LDI	FREQ.LVL.DTC	NO DTC	–	1	0	DTC	NO DTC
{15}	LDI	TORQUE.LIMIT	OFF	–	1	0	ON	OFF
{16}	LDI	VOLT.LIMIT	OFF	–	1	0	ON	OFF
{17}	LDI	CURRNT.LIMIT	OFF	–	1	0	ON	OFF
{18}	LDI	REMOTE.LOCAL	LOC	–	1	0	REM	LOC
20	LAO	OVRD TIME	0	HRS	1	0	–	–
{21}	LAO	REF.FREQ	0	HZ	0.01	0	–	–
{22}	LDI	FWD.REV	FWD	–	1	0	REV	FWD
{23}	LDO	CMD FWD.REV	FWD	–	1	0	REV	FWD
{24}	LDI	RUN.STOP	STOP	–	1	0	RUN	STOP
{25}	LDO	CMD RUN.STOP	STOP	–	1	0	RUN	STOP
26	LAO	FREQ UPLIMIT	0	–	0.1	0	–	–
27	LAO	FREQ LOLIMIT	0	–	0.1	0	–	–
{29}	LDO	DAY.NIGHT	DAY	–	1	0	NGT	DAY
33	LDO	LOCK PANEL	UNLOCK	–	1	0	LOCK	UNLOCK
{40}	LDI	Y1	OFF	–	1	0	ON	OFF

- a. Points not listed are not used in this application.
b. A single value in a column means that the value is the same in English units and in SI units.
c. Point numbers that appear in brackets { } may be unbundled at the field panel.

continued on the next page...

Table 6.3 Point Database for FLN.

Point Number	Point Type	Subpoint Name	Factory Default (SI Units)	Engr. Units (SI Units)	Slope (SI Units)	Intercept (SI Units)	On Text	Off Text
{41}	LDI	Y2	OFF	–	1	0	ON	OFF
{42}	LDI	Y3	OFF	–	1	0	ON	OFF
{44}	LDI	Y5	OFF	–	1	0	ON	OFF
{50}	LAO	UNI.ANLG.OUT	0	PCT	0.01	-150	–	–
51	LAO	PID MODE SL	0	–	1	0	–	–
52	LAO	PID P GAIN	0	PCT	0.1	0	–	–
53	LAO	PID I TIME	0	SEC	0.1	0	–	–
{54}	LAI	PID OUTVALUE	0	PCT	0.01	-160	–	–
{55}	LAI	PID FEEDBACK	0	PCT	0.01	-160	–	–
{56}	LAI	AI VALUE 12	0	PCT	0.01	-150	–	–
{57}	LAI	AI VALUE C1	0	PCT	0.01	0	–	–
{58}	LAI	AI VALUE V2	0	PCT	0.01	-150	–	–
59	LAI	OUTPUT.AMPS	0	Amps (A)	0.1	0	–	–
{60}	LDO	X1	OFF	–	1	0	ON	OFF
{61}	LDO	X2	OFF	–	1	0	ON	OFF
{62}	LDO	X3	OFF	–	1	0	ON	OFF
{63}	LDO	X4	OFF	–	1	0	ON	OFF
{64}	LDO	X5	OFF	–	1	0	ON	OFF
{70}	LDO	UNIVRSL.DO.1	OFF	–	1	0	ON	OFF
{71}	LDO	UNIVRSL.DO.2	OFF	–	1	0	ON	OFF
{72}	LDO	UNIVRSL.DO.3	OFF	–	1	0	ON	OFF
{74}	LDO	UNIVRSL.DO.5	OFF	–	1	0	ON	OFF
{80}	LDI	FAULT	NOTFLT	–	1	0	FLT	NOTFLT
{81}	LDO	FAULT RESET	NORMAL	–	1	0	RESET	NORMAL
{82}	LAI	LAST FAULT	0	–	1	0	–	–
{83}	LAI	FLT.MEM.0	0	–	1	0	–	–
{90}	LAO	RD PARAM NUM	0	–	1	0	–	–
{91}	LAI	RD PARAM DAT	0	–	1	0	–	–
{92}	LAO	WR PARAM NUM	0	–	1	0	–	–
{93}	LAO	WR PARAM DAT	0	–	1	0	–	–
{99}	LAI	ERROR STATUS	0	–	1	0	–	–

- a. Points not listed are not used in this application.
- b. A single value in a column means that the value is the same in English units and in SI units.
- c. Point numbers that appear in brackets { } may be unbundled at the field panel.

Table 6.4 Point Database for FLN.

Point Number	Subpoint Name	Parameter
1	CTRL ADDRESS	y01 : RJ45 port y11 : Optional port
3	DR.FREQUENCY	M09
4	DR.TORQUE	M07
5	DR.CURRENT	M11
6	DR.VOLTAGE	M12
7	DR.POWER	M10
8	OPERAT. TIME	M20
9	INTEGRAT.PWR	W81
10	READY	M70 (Bit 2)
11	IN ACCEL	M14 (Bit 9)
12	IN DECEL	M14 (Bit 10)
13	DRIVE.AT.REF	M70 (Bit 0)
14	FREQ.LVL.DTC	M70 (Bit 1)
15	TORQUE.LIMIT	M14 (Bit 6)
16	VOLT.LIMIT	M14 (Bit 7)
17	CURRNT.LIMIT	M14 (Bit 8)
18	REMOTE.LOCAL	M14 (Bit 12)
21	REF.FREQ	S05
22	FWD.REV	M14 (Bit 0 and Bit 1)
23	CMD FWD.REV	S06 (Bit 0 and Bit 1)
24	RUN.STOP	M14 (Bit 0 and Bit 1)
25	CMD RUN.STOP	S06 (Bit 0 and Bit 1)
26	FREQ UPLIMIT	F15
27	FREQ LOLIMIT	F16
33	LOCK PANEL	F00
40	Y1	M15 (Bit 0)
41	Y2	M15 (Bit 1)
42	Y3	M15 (Bit 2)
44	Y5	M15 (Bit 4)
50	UNI.ANLG.OUT	S12
51	PID MODE SL	J01
52	PID P GAIN	J03
53	PID I TIME	J04
54	PID OUTVALUE	M73
55	PID FEEDBACK	M72
56	AI VALUE 12	M49
57	AI VALUE C1	M50
58	AI VALUE V2	M54
59	OUTPUT.AMPS	—

Table 6.4 Point Database for FLN.

Point Number	Subpoint Name	Parameter
60	X1	S06 (Bit 2)
61	X2	S06 (Bit 3)
62	X3	S06 (Bit 4)
63	X4	S06 (Bit 5)
64	X5	S06 (Bit 6)
70	UNIVRSL.DO.1	S07 (Bit 0)
71	UNIVRSL.DO.2	S07 (Bit 1)
72	UNIVRSL.DO.3	S07 (Bit 2)
74	UNIVRSL.DO.5	S07 (Bit 4)
80	FAULT	M14 (Bit 11)
81	FAULT RESET	S14
82	LAST FAULT	M17
83	FLT.MEM.0	M16

6.6.9 Point 90,91,92,93 Read/Write Parameter Number (Parameter Data)

Parameter Number is used to access the object (function code) not allocated in Table 6.3. When the writing processing is done by Write Point(07H) and the Memorize Point(75H) command, the writing value is not judged by Value Range according to the Point Type(PT).

6.6.9.1 Function code reading procedure

1. Write the function code to "Point Number 90 Read Parameter Number" in the format shown in 6.6.10.
2. Read "Point Number 91 Read Parameter Data".

After writing Read Parameter Number, Read Parameter Number can be read at the point of executing 2. The same function code can be read by executing 2 only.

Moreover, when the function code that doesn't exist is specified, the data read by 2 becomes "0".

6.6.9.2 Function code writing procedure

1. Write the function code to "Point Number 92 Write Parameter Number" in the format shown in 6.6.10.
2. Write a data to "Point Number 93 Write Parameter Data".

The reflection of writing value to the function code is done at the point of executing 2. After 1 is previously done without fail, it is necessary to do 2.

It is possible to write to the same function code by executing 2 only.

When writing to the function code of not being possible to write or the function code that doesn't exist is specified, it is ignored. (The reply becomes ACK reply.) Moreover, when the upper limit value of the function code data range is exceeded, the upper limit value is written to the function code.

It is similar for the lower limit value.

6.6.10 Reading and Writing from/to Inverter's Function Codes

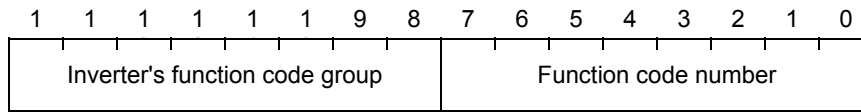

Inverter's function code group: Group of function codes (F, E, C etc.). See Table 6.5 below.

Function code number: 2-digit number following the function code group. For example, 98 in E98.

(Example) Reading H30 from the inverter

H:	Function code group 08	}	081E (hexadecimal) = 2078 (decimal)
30:	1E (hexadecimal)		

For details about the data format of individual function codes, refer to the Chapter 5, Section 5.2 "Data Formats."

Table 6.5 Function Code Groups

Group	Group code	Function code name	Group	Group code	Function code name
S	0x02	Run command data	o	0x0A	Option function
M	0x03	Monitor data	J	0x0E	Application functions
F	0x04	Fundamental functions	y	0x0F	Link functions
E	0x05	Extension terminal functions	W	0x10	Keypad monitor data
C	0x06	Control functions	X	0x11	Alarm data 1 for keypad
P	0x07	Motor parameters	Z	0x12	Alarm data 2 for keypad
H	0x08	High performance functions			

===Appendix===

CHAPTER 7

Metasys N2

(N2 PROTOCOL)

Metasys N2 is a serial communication system protocol from the Johnson Controls company that is layered on top of an EIA RS-485 hardware platform. It is primarily a fieldbus used by the building and automation industries.

The FRN***F1S-*A,K,E,U (FRENIC-Eco Asia, Taiwan and Korea, EU and USA version) have an optional built-in Metasys N2 communication driver.

Table of Contents

7.1	Messages	7-1
7.1.1	Transmission Specification	7-1
7.1.2	polling/selecting	7-1
7.2	Setting up Communications of the FRENIC-Eco	7-1
7.3	Point mapping tables.....	7-2
7.4	Read / Write Parameter.....	7-3
7.5	Support Command List.....	7-4

7.1 Messages

7.1.1 Transmission Specification

Item	Specification
Physical level	EIA RS-485
Transmission distance	1640 ft (500 m) max
Number of nodes	255 total
Transmission speed	9600 (bits/s) fixed
Transmission mode	Half duplex
Bus topology	Master-Slave communication
Character code	ASCII 7bits fixed
Character length	8 bits fixed
Stop bit	1 bit fixed
Frame length	Variable length
Parity	none fixed
Error check	sum-check

7.1.2 polling/selecting

When the FRENIC-Eco receives a request frame from the host addressed to itself (local station), the FRENIC-Eco sends back a response frame.

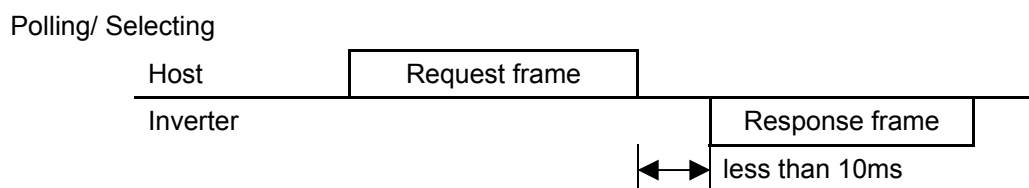

7.2 Setting up Communications of the FRENIC-Eco

Baudrate

The baudrate on a Metasys N2 network is always 9600kbps.

Termination

The end nodes in a Metasys network can be terminated to avoid reflections on the bus line. The drive is equipped with a termination switch to accomplish this in an easy way. If the drive is used as the first or last drop in a network the termination switch should be in ON position. Otherwise the switch has to be in OFF position.

Note: If an external termination connector is used the switch must be in OFF position.

Node Address

Before the drive is connected to the network and activated, the node or drop address has to be set. This is done with Function Code, y01/y11. See Chapter 2 of this manual for setting instructions.

Note: The node address can not be changed during operation.

7.3 Point mapping tables

Point mapping tables AI BI

NPT	NPA	Units	Description	Range, Value	Notes
AI	1	Hz	Output Frequency	0 to 655.35	M09
AI	2	%	Actual Torque	-327.68 to 327.67	M07
AI	3	%	Output Current	0 to 399.99	M11
AI	4	%	Motor output power	-327.68 to 327.67	M64
AI	5	Vrms	Output Voltage	0.0 to 1000.0	M12
AI	6	-	Fault memory 0	0 to 127	M16
AI	7	-	Last Fault	0 to 127	M17
AI	8	-	PID Output Value	-32768 to 32767	M73, 20000=100%
AI	9	-	PID Feedback Value	-32768 to 32767	M72, 20000=100%
AI	10	h	Cumulative operation time	0 to 65535	M20
AI	11	kWh	Integrating electric power	0.001 to 9999	W81
AI	12	-	Input terminal voltage [I2]	-32768 to 32767	M49, 20000=10V
AI	13	-	Input terminal current [C1]	0 to 32767	M50, 20000=20mA
AI	14	-	Input terminal voltage [V2]	-32768 to 32767	M54, 20000=10V
AI	15	-	Read parameter data	float	
BI	1	-	FWD	0/1=Off/On	M14 bit0
BI	2	-	REV	0/1=Off/On	M14 bit1
BI	3	-	Fault	0/1=Off/On	M14 bit11
BI	4	-	Frequency At Ref	0/1=Off/On	M70 bit0
BI	5	-	Frequency Level Detect	0/1=Off/On	M70 bit1
BI	6	-	Ready	0/1=Off/On	M70 bit2
BI	7	-	Reserve	-	
BI	8	-	Reserve	-	
BI	9	-	Current Limit Active	0/1=Off/On	M14 bit8
BI	10	-	In Acceleration	0/1=Off/On	M14 bit9
BI	11	-	In Deceleration	0/1=Off/On	M14 bit10
BI	12	-	Remote / Local	0/1=Local/Remote	
BI	13	-	Y1 (Programmable)	0/1=Off/On	Defined by E20
BI	14	-	Y2 (Programmable)	0/1=Off/On	Defined by E21
BI	15	-	Y3 (Programmable)	0/1=Off/On	Defined by E22
BI	16	-	Reserve	-	
BI	17	-	Y5 (Programmable)	0/1=Off/On	Defined by E24
BI	18	-	30ABC Programmable)	0/1=Off/On	Defined by E25

Point mapping tables AO

NPT	NPA	Units	Description	Range, Value	Notes
AO	1	Hz	Reference Frequency	0 to 655.35	S05
AO	2	-	Universal Analog Output	-32768 to 32767	S12, FMA(F31=10), 20000=100%
AO	3	-	Reserve	-	
AO	4	-	Reserve	-	
AO	5	-	Reserve	-	
AO	6	-	Reserve	-	
AO	7	s	Acceleration time	0.0 to 3600.0	S08
AO	8	s	Deceleration time	0.0 to 3600.0	S09
AO	9	-	PID Set Value	-32768 to 32767	S13, 20000=100%
AO	10	Hz	Frequency limiter high	0.0 to 120.0	F15
AO	11	Hz	Frequency limiter low	0.0 to 120.0	F16
AO	12	-	PID select	0 to 2	J01
AO	13	Times	PID P-Gain	0.000 to 30.000	J03
AO	14	s	PID I-time	0.0 to 3600.0	J04
AO	15	-	Read Parameter Number	0 to 65535	see page4
AO	16	-	Write Parameter Number	0 to 65535	see page4
AO	17	-	Write Parameter Data	float	

7.4 Read / Write Parameter

Read Parameter Number, Write Parameter Number

Code Group			Code name
0	0x00	-	Reserve.
2	0x02	S	Command data
3	0x03	M	Monitor data
4	0x04	F	Fundamental Functions
5	0x05	E	Extension Terminal Functions
6	0x06	C	Control Functions of Frequency
7	0x07	P	Motor Parameters
8	0x08	H	High Performance Functions
9	0x09	-	Reserve.
10	0x0A	o	Option Functions
11	0x0B	-	Reserve.
12	0x0C	-	Reserve.
13	0x0D	-	Reserve.
14	0x0E	J	Application Functions
15	0x0F	y	LINK Functions
16	0x10	W	Monitor data out of keypad display information
17	0x11	X	Alarm information out of keypad display information
18	0x12	Z	Alarm information out of keypad display information
19	0x13	-	Reserve.
20	0x14	-	Reserve.
247	0xF7	-	Reserve.
248	0xF8	-	Reserve.
252	0xFC	-	Reserve.

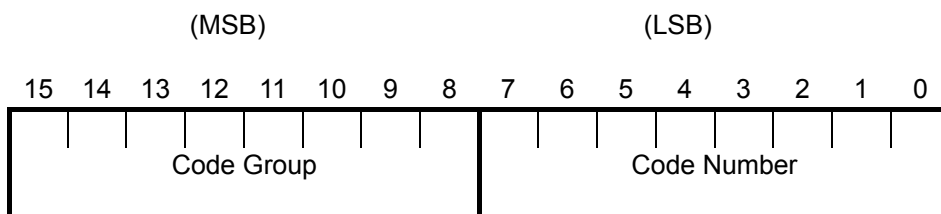

Point mapping tables **BO**

NPT	NPA	Units	Description	Range, Value	Notes
BO	1	-	FWD	0/1=Off/On	S06 bit0
BO	2	-	REV	0/1=Off/On	S06 bit1
BO	3	-	X1	0/1=Off/On	S06 bit2
BO	4	-	X2	0/1=Off/On	S06 bit3
BO	5	-	X3	0/1=Off/On	S06 bit4
BO	6	-	X4	0/1=Off/On	S06 bit5
BO	7	-	X5	0/1=Off/On	S06 bit6
BO	8	-	Reserve	-	
BO	9	-	Reserve	-	
BO	10	-	Reserve	-	
BO	11	-	Reserve	-	
BO	12	-	Reserve	-	
BO	13	-	Reset	0/1=Off/On	S06 bit15
BO	14	-	Universal Digital Out Y1	0/1=Off/On	S07 bit0 , E20=27
BO	15	-	Universal Digital Out Y2	0/1=Off/On	S07 bit1 , E21=27
BO	16	-	Universal Digital Out Y3	-	S07 bit2, E22=27
BO	17	-	Reserve	0/1=Off/On	-
BO	18	-	Universal Digital Out Y5	0/1=Off/On	S07 bit4, E24=27
BO	19	-	Universal Digital Out 30ABC	0/1=Off/On	S07 bit8, E25=27
BO	20		Panel lock	0/1=Off/On	F00

7.5 Support Command List

Support Command List 1

Message	Command	Sub Command	Region	NPA	Attribute number	Attribute type	Response	Error code	Note
Synch Time	0	0	-	-	-	-	ACK		No Action.
Read Memory	0	1	-	-	-		NAK	01	
Poll Without ACK	0	4	-	-	-	-	ACK		
Poll With ACK	0	5	-	-	-	-	ACK		
Warm Start	0	8	-	-	-		NAK	01	
Status Update Request	0	9	-	-	-	-	ACK		See *1
Read Analog Input (Object Configuration)	1	-	1	0-6	1	Byte	ACK		
Read Analog Input (Object status & Value)	1	-	1	0-6	2	Byte Float	ACK		
Read Analog Input (Value)	1	-	1	0-6	3	Float	ACK		
Read Analog Input	1	-	1	0-6	4-7		NAK	11	
Read Analog Input (Low Alarm Limit)	1	-	1	0-6	8	Float	ACK		
Read Analog Input (Low Warning Limit)	1	-	1	0-6	9	Float	ACK		
Read Analog Input (High Warning Limit)	1	-	1	0-6	10	Float	ACK		
Read Analog Input (High Alarm Limit)	1	-	1	0-6	11	Float	ACK		
Read Analog Input (Differential)	1	-	1	0-6	12	Float	ACK		
Read Analog Input	1	-	1	0-6	13- 14	Float	NAK	11	
Read Binary Input (Object Configuration)	1	-	2	0-17	1	Byte	ACK		
Read Binary Input (Object status)	1	-	2	0-17	2	Byte	ACK		
Read Binary Input	1	-	2	0-17	3-4		NAK	11	

*1: Device manufacturing model number = M23+M24+M25+"0000", Days in service = M20, Device status = "0000" .

Support Command List 2

Message	Command	Sub Command	Region	NPA	Attribute number	Attribute type	Response	Error code	Note
Read Analog Output (Object Configuration)	1	-	3	0-8	1	Byte	ACK		
Read Analog Output (Object status)	1	-	3	0-8	2	Byte	ACK		
Read Analog Output (Current Value)	1	-	3	0-8	3	Float	ACK		
Read Analog Output	1	-	3	0-8	4-5	Float	NAK	11	
Read Binary Output (Object Configuration)	1	-	4	0-18	1	Byte	ACK		
Read Binary Output (Object status)	1	-	4	0-18	2	Byte	ACK		
Read Binary Output (Minimum On-time)	1	-	4	0-18	3	Integer	ACK		Return attribute value is "00".
Read Binary Output (Minimum Off-time)	1	-	4	0-18	4	Integer	ACK		Return attribute value is "00".
Read Binary Output (Maximum Cycles/Hour)	1	-	4	0-18	5	Integer	ACK		Return attribute value is "00".
Read Binary Output	1	-	4	0-18	6-7	Integer	NAK	11	
Read Internal Parameter	1	-	5-8	-	1-2	-	NAK	01	
Write Analog Input (Object Configuration)	2	-	1	0-6	1	Byte	ACK		
Write Analog Input	2	-	1	0-6	2-7	-	NAK	11	
Write Analog Input (Low Alarm Limit)	2	-	1	0-6	8	Float	ACK		
Write Analog Input (Low Warning Limit)	2	-	1	0-6	9	Float	ACK		
Write Analog Input (High Warning Limit)	2	-	1	0-6	10	Float	ACK		
Write Analog Input (High Alarm Limit)	2	-	1	0-6	11	Float	ACK		
Write Analog Input (Differential)	2	-	1	0-6	12	Float	ACK		
Write Analog Input	2	-	1	0-6	13-14	Float	NAK	11	
Write Binary Input (Object Configuration)	2	-	2	0-17	1	Byte	ACK		
Write Binary Input	2	-	2	0-17	2-4	-	NAK	11	

Support Command List 3

Message	Command	Sub Command	Region	NPA	Attribute number	Attribute type	Response	Error code	Note
Write Analog Output (Object Configuration)	2	-	3	0-8	1	Byte	ACK		
Write Analog Output	2	-	3	0-8	2-5	-	NAK	11	
Write Binary Output (Object Configuration)	2	-	4	0-18	1	Byte	ACK		
Write Binary Output (Object status)	2	-	4	0-18	2	Byte	NAK	11	
Write Binary Output (Minimum On-time)	2	-	4	0-18	3	Integer	ACK		No Action
Write Binary Output (Minimum Off-time)	2	-	4	0-18	4	Integer	ACK		No Action
Write Binary Output (Maximum Cycles/Hour)	2	-	4	0-18	5	Integer	ACK		No Action
Write Binary Output	2	-	4	0-18	6-7	Integer	NAK	11	
Write Internal Parameter	2	-	5-8	-	-	-	NAK	11	
Override Analog Input	7	2	1	0-6	-	Float	ACK		No Action
Override Binary Input	7	2	2	0-17	-	Byte	ACK		No Action
Override Analog Output	7	2	3	0-8	-	Float	ACK		
Override Binary Output	7	2	4	0-18	-	Byte	ACK		
Override Internal Parameter	7	2	5-8	-	-	-	NAK	01	
Override Release Request	7	3	1-8	-	-	-	ACK		
Write Analog Input Attributes Request	7	7	1	0-6	-	-	NAK	01	
Write Binary Input Attributes Request	7	7	2	0-17	-	-	NAK	01	
Write Analog Output Attributes Request	7	7	3	0-8	-	-	NAK	01	
Write Binary Output Attributes Request	7	7	4	0-18	-	-	NAK	01	
Read Analog Input Attributes Request	7	8	1	0-6	-	-	NAK	01	
Read Binary Input Attributes Request	7	8	2	0-17	-	-	NAK	01	
Read Analog Output Attributes Request	7	8	3	0-8	-	-	NAK	01	
Read Binary Output Attributes Request	7	8	4	0-18	-	-	NAK	01	

Support Command List 4

Message	Command	Sub Command	Region	NPA	Attribute number	Attribute type	Response	Error code	Note
Identify Device Type	F	-	-	-	-	-	ACK		Device code="10"
Upload Request	8	0-1	-	-	-	-	NAK	01	
Upload Record	8	3	-	-	-	-	NAK	01	
Upload Complete	8	4	-	-	-	-	NAK	01	
Download Request	9	0-1	-	-	-	-	NAK	01	
Download Record	9	3	-	-	-	-	NAK	01	
Download Complete	9	4	-	-	-	-	NAK	01	

FRENIC-Mini
FRENIC-Eco
FRENIC-Multi
FRENIC-MEGA

User's Manual for RS-485 Communications Card

First edition: October 2002
Fifth edition: July 2009

Fuji Electric Systems Co., Ltd.

- We prepared and examined the contents of this manual with extreme care. However, if you have any questions or notice errors, omissions, misprints, etc., please contact us.
- We are not responsible for any effects of the results caused by the operation of this product, irrespective of such errors, omissions, misprints, etc. as described above.

 Fuji Electric Co., Ltd.

Gate City Ohsaki, East Tower, 11-2, Osaki 1-chome, Shinagawa-ku, Tokyo, 141-0032, Japan
Phone: +81-3-5435-7058 Fax: +81-3-5435 7420
URL <http://www.fujielectric.com/>