

To buy, sell, rent or trade-in this product please click on the link below:
<http://www.avionteq.com/Olympus-Sonic-1200HR-Ultrasonic-Flaw-Detector.aspx>

AvionTEq

□ □ □ □ □ □ □ □ □ □
Test with full trust

www.avionteq.com

OLYMPUS

Sonic[®] 1200S/HR Ultrasonic Flaw Detector

User's Manual

PN 7720044, PN 7720066 — March 2006



In accordance with European Directive 2002/96/EC on Waste Electrical and Electronic Equipment, this symbol indicates that the product must not be disposed of as unsorted municipal waste, but should be collected separately. Refer to your local Olympus NDT distributor for return and/or collection systems available in your country.

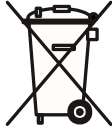

Copyright © 2006 by Olympus NDT. All rights reserved.

No part of this manual may be reproduced or transmitted in any form or by any means, electronic or mechanical, including photocopying, recording, or by any information storage and retrieval system, without the written permission of Olympus NDT, except where permitted by law. For information, contact: info@OlympusNDT.com.

Panametrics, Panametrics-NDT, and the Panametrics-NDT logo are trademarks of Panametrics Inc.

Other product names mentioned in this document may be trademarks of their respective companies, and are mentioned for identification purposes only.

Printed in the United States of America.

Warranty

The Sonic 1200S/HR has been designed and manufactured as a high quality instrument.

Inspect the unit thoroughly upon receipt for evidence of external or internal damage that may have occurred during shipment. Notify the carrier making the delivery immediately of any damage, since the carrier is normally liable for damage in shipment. Preserve packing materials, waybills, and other shipping documentation in order to establish damage claims. After notifying the carrier, contact Olympus NDT™ so that we may assist in the damage claims, and provide replacement equipment, if necessary.

Olympus NDT guarantees the Sonic 1200S/HR to be free from defects in materials and workmanship for a period of one year (twelve months) from date of shipment. This warranty only covers equipment that has been used in a proper manner as described in this instruction manual and has not been subjected to excessive abuse, attempted unauthorized repair, or modification. DURING THIS WARRANTY PERIOD, Olympus NDT LIABILITY IS STRICTLY LIMITED TO REPAIR OR REPLACEMENT OF A DEFECTIVE UNIT AT ITS OPTION. Olympus NDT does not warrant the Sonic 1200S/HR to be suitable of intended use, or fitness for any particular application or purpose. Olympus NDT accepts no liability for consequential or incidental damages including damage to property and/or personal injury. In addition to our standard one year warranty, Olympus NDT also offers an optional two year warranty (call for further details).

This warranty does **not** include transducers, transducer cables, or battery. The customer will pay shipping expense to the Olympus NDT plant for warranty repair; Olympus NDT will pay for the return of the repaired equipment. (For instruments not under warranty, the customer will pay shipping expenses both ways.)

In this manual, we have attempted to teach the proper operation of the Sonic 1200S/HR consistent with accepted flaw detection techniques. We believe the procedures and examples given are accurate. However, the information contained herein is intended solely as a teaching aid and should not be used in any particular application without independent testing and/or verification by the operator or the supervisor. Such independent verification of procedures

become more important as the criticality of the application increases.

For these reasons, we make no warranty, expressed or implied, that the techniques, examples, or procedures described herein are consistent with industry standards nor that they will meet the requirements of any particular application. Olympus NDT expressly disclaims all implied warranties of merchantability and of fitness for any particular application.

Olympus NDT reserves the right to modify all products without incurring the responsibility for modifying previously manufactured products. Olympus NDT does not assume any liability for the results of particular installations, as these circumstances are not within our control.

THE WARRANTIES SET FORTH HEREIN ARE EXCLUSIVE AND ARE IN LIEU OF ALL OTHER WARRANTIES WHETHER STATUTORY, EXPRESS, OR IMPLIED (INCLUDING WARRANTIES OF MERCHANTABILITY AND FITNESS FOR A PARTICULAR PURPOSE, AND WARRANTIES ARISING FROM COURSE OF DEALING OR USAGE OR TRADE).

Table of Contents

Warranty and PowerLink™

1	Preparation for Operation	1
1.1	Unpacking the Sonic 1200S/HR	4
1.2	Sonic 1200S/HR Packages	5
1.3	Sonic 1200S+/HR+ Packages	8
1.4	Optional Accessories	11
1.5	Initial Inspection Checklist.....	11
1.6	Power Requirements	12
1.7	Ni-MH Battery Characteristics.....	14
1.8	Li-Ion Battery Characteristics	15
1.9	Charging the Ni-MH/Li-Ion Battery	16
1.10	Operating Environment	20
2	Technical Data	21
3	FastBreak Operation	29
3.1	Getting Started with FastBreak Operation	29
3.2	Ready	29
3.3	Operating Menu Structure	30
3.4	Set.....	31
4	Control Descriptions.....	35
4.1	Instrument Controls.....	36
4.2	Power Button.....	37
4.3	Displays	37
4.4	Soft Keys	39
4.5	INC/DEC Arrow Keys	40
4.6	Main Menu Keys	40

4.7	Enter Key.....	42
4.8	Print Key.....	42
4.9	SmartKnob™.....	42
4.10	RCV and XMIT BNCs.....	42
4.11	Pulser Menu.....	43
4.12	Receiver Menu.....	43
4.13	Range Menu.....	44
4.14	Gate 1 Menu.....	45
4.15	Gate 2 Menu.....	46
4.16	Thickness Menu.....	47
4.17	Angle Menu.....	48
4.18	DAC Menu.....	49
4.19	Main Menu.....	50
4.20	SPCL Menu.....	51
4.21	Program Sub-Menu.....	54
4.22	Report Form Sub-Menu.....	55
4.23	Clock Sub-Menu.....	56
4.24	A-scan Sub-Menu.....	57
4.25	A-scan Attribute Sub-Menu.....	58
4.26	Data Sub-Menu.....	59
4.27	New Block Editor.....	60
4.28	Block Review Sub-Menu.....	61
4.29	Text Editor.....	62
4.30	Instrument Reset.....	63
5	Applications.....	65
5.1	Pulse-Echo Contact Thickness Testing.....	65
5.2	Dual Transducer Thickness Testing.....	74
5.3	Delay Line Thickness Testing.....	87
5.4	Shear Wave (Angle Beam) Testing.....	98
5.5	Distance Amplitude Correction (DAC) Testing.....	112
6	Internal Datalogger.....	119
6.1	Introduction.....	119
6.2	Creating a New Block.....	120
6.3	Selecting a Block.....	121
6.4	Storing Readings into Memory.....	121
6.5	Selecting Locations and Reviewing Readings.....	122
6.6	Clearing Readings.....	122

6.7 Clearing a Block.....	123
6.8 Deleting a Block.....	124
6.9 Deleting All Blocks.....	124
7 Computer Interface	127
7.1 Description	127
7.2 RS-232 Communication	128
7.3 Modes of Operation.....	130
7.4 Command Strings	130
7.5 Status Reporting	131
7.6 RS-232 Command Set.....	132
7.7 Examples	143

Documentation Comments

1. Preparation for Operation

What's in this section?

Introduction to PowerLink™

- 1.1 Unpacking the Sonic® 1200S/HR
- 1.2 Sonic® 1200S/HR Optional Accessories
- 1.3 Initial Inspection Checklist
- 1.4 Power Requirements
- 1.5 Ni-MH Battery Characteristics
- 1.6 Li-Ion Battery Characteristics
- 1.7 Charging the Ni-MH / Li-Ion Battery
- 1.8 Operating Environment

Introduction to PowerLink™

The PowerLink™ feature enables the Sonic® 1200S/HR instrument to recognize a Olympus NDT PowerLink transducer type and provides the capability to modify selected instrument parameters for program storage and recall. PowerLink has a separate screen with a sign-on

message and menu structure (as shown).



Each PowerLink transducer is programmed at the factory to identify itself by model, frequency, serial number and type. The operator may select the factory default setup for each transducer type in the event that an instrument setup has not been associated with that transducer.

The stored program feature is tied into the program store and recall features of the instrument. This makes stored programs associated with transducers look the same to the operator as other stored programs.

Before any stored transducer programs can be recalled, a Olympus NDT transducer must be connected to the instrument and identified. Multiple programs are associated with each transducer and the operator is allowed to select from the programs stored.



When a transducer linked through PowerLink is removed and replaced with another transducer, the Sonic® 1200S/HR instrument **MUST** be recalibrated, or the new transducer relinked before testing.

PowerLink™ Connection

After connecting a Olympus NDT transducer to your Sonic® 1200S/HR instrument, touch and *hold* the transducer to the PowerLink contact disc on your EL/LCD display for approximately 4 seconds, or 2 beeps. If contact is not maintained for the proper amount of time, the screen will show the PowerLink display with N/A parameters. In this case, try again, until the PowerLink connection is complete and parameters are displayed.

Menu Description

- *Model*Transducer Model
- *Frequency*Transducer Nominal Frequency
- *S/N*Serial Number (stamped on the front of the transducer)
- *Mode*Single or Dual
- *Program Name and Date Stamp* - Program number, optional operator-entered description, and date stamp. The stored program number is shown in the PROGRAM softkey menu box.

Program

This line displays the program storage location/transducer setup, which is to be stored, recalled, or erased. Rotating the SmartKnob™ will cycle through the storage locations associated with the identified transducer. If no stored locations are associated with the identified transducer, the number of the next empty storage location will be displayed.

Store/Recall

Instrument settings associated with the identified transducer are stored to or recalled from the selected program location. If the location is empty, the operator is allowed to store the instrument setup. Whenever a transducer setup is recalled, the current instrument settings are overwritten and cannot be recovered unless the setup was previously saved.

Erase

Allows the operator to erase the selected transducer setup. This needs to be done only if the storage location is to be reused. An ENTER confirmation will be required from the operator before the program location is cleared. An erased location cannot be recovered.

Name

Allows the operator to enter a name of up to 26 characters to identify the setup. Only program locations which are not empty may be named.

Default

Restores the factory default instrument setup and changes the PULSEWIDTH, FREQUENCY, and MODE parameters of the receiver in accordance with the identified transducer parameters.

The PowerLink menu may be exited at any time without changing instrument setups by pressing any menu key on the main keypad. When recalling default setups for an angle beam transducer, the operator will be sent to the ANGLE menu on return from the PowerLink menu. When recalling the default setting from a nonangle beam transducer, the operator will be returned to the RCVR menu on exit from PowerLink.

1.1 Unpacking the Sonic 1200S/HR

All cartons should be opened and inspected upon receipt. The cartons and contents should be inspected for any signs of damage that may have occurred during shipment. If damage is noted, contact the carrier and retain the damaged shipping materials until an inspection can be performed by a representative of the carrier. With the exception of the UBC (*universal battery charger*) and external accessories, all Sonic® 1200S/HR options are installed before the unit is shipped. Check the contents of the carton or cartons against the *Packing List* to ensure that all accessories ordered have been received.

1.2 Sonic® 1200S/HR Packages

1.2.1 Sonic® 1200S Packages

Qty.	Sonic® 1200S Basic Kit	Qty.	Sonic® 1200S Standard Kit	Qty.	Sonic® 1200S Deluxe Kit
1	Sonic® 1200S Base Unit	1	Sonic® 1200S Base Unit	1	Sonic® 1200S Base Unit
	<i>Kit includes choice of one (1) of the following displays.</i>		<i>Kit includes choice of two (2) of the following displays.</i>		<i>Kit includes choice of two (2) of the following displays.</i>
1	Hi Brite EL Display Module	1	Hi Brite EL Display Module	1	Hi Brite EL Display Module
1	Backlit LCD Display Module	1	Backlit LCD Display Module	1	Backlit LCD Display Module
	<i>Included Accessories</i>		<i>Included Accessories</i>		<i>Included Accessories</i>
2	Ni-MH Batteries DR-35	2	Ni-MH Batteries DR-35	4	Ni-MH Batteries DR-35
1	Universal Battery Charger	1	Universal Battery Charger	1	Universal Battery Charger
1	Power Cord	1	Power Cord	1	Power Cord
1	2 oz. bottle X30 Couplant	1	2 oz. bottle X30 Couplant	1	2 oz. bottle X30 Couplant
1	BNC-BNC 6' Cable	1	BNC-BNC 6' Cable	1	BNC-BNC 6' Cable
1	BNC-Microdot 6' Cable	1	BNC-Microdot 6' Cable	1	BNC-Microdot 6' Cable
1	Soft Protective Cover	1	Soft Protective Cover	1	Soft Protective Cover
1	Operation Manual	1	Operation Manual	1	Operation Manual
1	NIST Calibration Certificate	1	NIST Calibration Certificate	1	NIST Calibration Certificate
1	Hard Shell Travel Case	1	Hard Shell Travel Case	1	Hard Shell Travel Case
-	---	-	---	1	Pentax Printer Kit
-	---	-	---	1	FlawMaster Software Kit
1	Charger Cable	1	Charger Cable	1	Charger Cable

	<i>Kit includes choice of two (2) of the following transducers.</i>		<i>Kit includes choice of three (3) of the following transducers.</i>		<i>Kit includes choice of four (4) of the following transducers.</i>
1	Spectrum™ E8L 5MHz 0.5" PowerLink™ Transducer	1	Spectrum™ E8L 5MHz 0.5" PowerLink™ Transducer	1	Spectrum™ E8L 5MHz 0.5" PowerLink™ Transducer
1	Spectrum™ E4L 2.25MHz 0.75" PowerLink™ Transducer	1	Spectrum™ E4L 2.25MHz 0.75" PowerLink™ Transducer	1	Spectrum™ E4L 2.25MHz 0.75" PowerLink™ Transducer
1	Spectrum™ C17L 10MHz 0.25" PowerLink™ Transducer	1	Spectrum™ C17L 10MHz 0.25" PowerLink™ Transducer	1	Spectrum™ C17L 10MHz 0.25" PowerLink™ Transducer
1	Spectrum™ F2L 2.25MHz 0.5" PowerLink™ Angle Beam Transducer	1	Spectrum™ F2L 2.25MHz 0.5" PowerLink™ Angle Beam Transducer	1	Spectrum™ F2L 2.25MHz 0.5" PowerLink™ Angle Beam Transducer
1	Spectrum™ G2 45° Wedge	1	Spectrum™ G2 45° Wedge	1	Spectrum™ G2 45° Wedge
1	Spectrum™ G4 60° Wedge	1	Spectrum™ G4 60° Wedge	1	Spectrum™ G4 60° Wedge
1	Spectrum™ G6 70° Wedge	1	Spectrum™ G6 70° Wedge	1	Spectrum™ G6 70° Wedge

1.2.2 Sonic[®] 1200HR Packages

Qty.	Sonic [®] 1200HR Basic Kit	Qty.	Sonic [®] 1200HR Standard Kit	Qty.	Sonic [®] 1200HR Deluxe Kit
1	Sonic [®] 1200HR Base Unit	1	Sonic [®] 1200HR Base Unit	1	Sonic [®] 1200HR Base Unit
	<i>Kit includes choice of one (1) of the following displays.</i>		<i>Kit includes choice of two (2) of the following displays.</i>		<i>Kit includes choice of two (2) of the following displays.</i>
1	Hi Brite EL Display Module	1	Hi Brite EL Display Module	1	Hi Brite EL Display Module
1	Backlit LCD Display Module	1	Backlit LCD Display Module	1	Backlit LCD Display Module
	<i>Included Accessories</i>		<i>Included Accessories</i>		<i>Included Accessories</i>
2	Ni-MH Batteries DR-35	2	Ni-MH Batteries DR-35	4	Ni-MH Batteries DR-35
1	Universal Battery Charger	1	Universal Battery Charger	1	Universal Battery Charger
1	Power Cord	1	Power Cord	1	Power Cord
1	2 oz. bottle X30 Couplant	1	2 oz. bottle X30 Couplant	1	2 oz. bottle X30 Couplant
1	BNC-BNC 6' Cable	1	BNC-BNC 6' Cable	1	BNC-BNC 6' Cable
1	BNC-Microdot 6' Cable	1	BNC-Microdot 6' Cable	1	BNC-Microdot 6' Cable
1	Soft Protective Cover	1	Soft Protective Cover	1	Soft Protective Cover
1	Operation Manual	1	Operation Manual	1	Operation Manual
1	NIST Calibration Certificate	1	NIST Calibration Certificate	1	NIST Calibration Certificate
1	Hard Shell Travel Case	1	Hard Shell Travel Case	1	Hard Shell Travel Case
-	---	-	---	1	Pentax II Printer Kit
-	---	-	---	1	FlawMaster Software Kit

	<i>Kit includes choice of two (2) of the following transducers.</i>		<i>Kit includes choice of three (3) of the following transducers.</i>		<i>Kit includes choice of four (4) of the following transducers.</i>
1	Spectrum [™] E8L 5MHz 0.5" PowerLink [™] Transducer	1	Spectrum [™] E8L 5MHz 0.5" PowerLink [™] Transducer	1	Spectrum [™] E8L 5MHz 0.5" PowerLink [™] Transducer
1	Spectrum [™] E4L 2.25MHz 0.75" PowerLink [™] Transducer	1	Spectrum [™] E4L 2.25MHz 0.75" PowerLink [™] Transducer	1	Spectrum [™] E4L 2.25MHz 0.75" PowerLink [™] Transducer
1	Spectrum [™] C17L 10MHz 0.25" PowerLink [™] Transducer	1	Spectrum [™] C17L 10MHz 0.25" PowerLink [™] Transducer	1	Spectrum [™] C17L 10MHz 0.25" PowerLink [™] Transducer
1	Spectrum [™] F2L 2.25MHz 0.5" PowerLink [™] Angle Beam Transducer	1	Spectrum [™] F2L 2.25MHz 0.5" PowerLink [™] Angle Beam Transducer	1	Spectrum [™] F2L 2.25MHz 0.5" PowerLink [™] Angle Beam Transducer
1	Spectrum [™] G2 45° Wedge	1	Spectrum [™] G2 45° Wedge	1	Spectrum [™] G2 45° Wedge
1	Spectrum [™] G4 60° Wedge	1	Spectrum [™] G4 60° Wedge	1	Spectrum [™] G4 60° Wedge
1	Spectrum [™] G6 70° Wedge	1	Spectrum [™] G6 70° Wedge	1	Spectrum [™] G6 70° Wedge

1.3 Sonic® 1200S+/HR+ Packages

1.3.1 Sonic® 1200S+ Packages

Qty.	Sonic® 1200S+ Basic Kit	Qty.	Sonic® 1200S+ Standard Kit	Qty.	Sonic® 1200S+ Deluxe Kit
1	Sonic® 1200S+ Base Unit	1	Sonic® 1200S+ Base Unit	1	Sonic® 1200S+ Base Unit
	<i>Kit includes choice of one (1) of the following displays.</i>		<i>Kit includes choice of two (2) of the following displays.</i>		<i>Kit includes choice of two (2) of the following displays.</i>
1	Hi Brite EL Display Module	1	Hi Brite EL Display Module	1	Hi Brite EL Display Module
1	Backlit LCD Display Module	1	Backlit LCD Display Module	1	Backlit LCD Display Module
	<i>Included Accessories</i>		<i>Included Accessories</i>		<i>Included Accessories</i>
1	Li-Ion Battery	1	Li-Ion Battery	2	Li-Ion Battery
1	Universal Battery Charger	1	Universal Battery Charger	1	Universal Battery Charger
1	Power Cord	1	Power Cord	1	Power Cord
1	2 oz. bottle X30 Couplant	1	2 oz. bottle X30 Couplant	1	2 oz. bottle X30 Couplant
1	BNC-BNC 6' Cable	1	BNC-BNC 6' Cable	1	BNC-BNC 6' Cable
1	BNC-Microdot 6' Cable	1	BNC-Microdot 6' Cable	1	BNC-Microdot 6' Cable
1	Soft Protective Cover	1	Soft Protective Cover	1	Soft Protective Cover
1	Operation Manual	1	Operation Manual	1	Operation Manual
1	NIST Calibration Certificate	1	NIST Calibration Certificate	1	NIST Calibration Certificate
1	Hard Shell Travel Case	1	Hard Shell Travel Case	1	Hard Shell Travel Case
-	---	-	---	1	Pentax Printer Kit
-	---	-	---	1	FlawMaster Software Kit
1	Charger Cable	1	Charger Cable	1	Charger Cable

	<i>Kit includes choice of two (2) of the following transducers.</i>		<i>Kit includes choice of three (3) of the following transducers.</i>		<i>Kit includes choice of four (4) of the following transducers.</i>
1	Spectrum™ E8L 5MHz 0.5" PowerLink™ Transducer	1	Spectrum™ E8L 5MHz 0.5" PowerLink™ Transducer	1	Spectrum™ E8L 5MHz 0.5" PowerLink™ Transducer
1	Spectrum™ E4L 2.25MHz 0.75" PowerLink™ Transducer	1	Spectrum™ E4L 2.25MHz 0.75" PowerLink™ Transducer	1	Spectrum™ E4L 2.25MHz 0.75" PowerLink™ Transducer
1	Spectrum™ C17L 10MHz 0.25" PowerLink™ Transducer	1	Spectrum™ C17L 10MHz 0.25" PowerLink™ Transducer	1	Spectrum™ C17L 10MHz 0.25" PowerLink™ Transducer
1	Spectrum™ F2L 2.25MHz 0.5" PowerLink™ Angle Beam Transducer	1	Spectrum™ F2L 2.25MHz 0.5" PowerLink™ Angle Beam Transducer	1	Spectrum™ F2L 2.25MHz 0.5" PowerLink™ Angle Beam Transducer
1	Spectrum™ G2 45° Wedge	1	Spectrum™ G2 45° Wedge	1	Spectrum™ G2 45° Wedge
1	Spectrum™ G4 60° Wedge	1	Spectrum™ G4 60° Wedge	1	Spectrum™ G4 60° Wedge
1	Spectrum™ G6 70° Wedge	1	Spectrum™ G6 70° Wedge	1	Spectrum™ G6 70° Wedge

1.3.2 Sonic® 1200HR+ Packages

Qty.	Sonic® 1200HR+ Basic Kit	Qty.	Sonic® 1200HR+ Standard Kit	Qty.	Sonic® 1200HR+ Deluxe Kit
1	Sonic® 1200HR+ Base Unit	1	Sonic® 1200HR+ Base Unit	1	Sonic® 1200HR+ Base Unit
	<i>Kit includes choice of one (1) of the following displays.</i>		<i>Kit includes choice of two (2) of the following displays.</i>		<i>Kit includes choice of two (2) of the following displays.</i>
1	Hi Brite EL Display Module	1	Hi Brite EL Display Module	1	Hi Brite EL Display Module
1	Backlit LCD Display Module	1	Backlit LCD Display Module	1	Backlit LCD Display Module
1	Color LCD Display Module	1	Color LCD Display Module	1	Color LCD Display Module
	<i>Included Accessories</i>		<i>Included Accessories</i>		<i>Included Accessories</i>
1	Li-Ion Battery	1	Li-Ion Battery	2	Li-Ion Batteries
1	Universal Battery Charger	1	Universal Battery Charger	1	Universal Battery Charger
1	Power Cord	1	Power Cord	1	Power Cord
1	2 oz. bottle X30 Couplant	1	2 oz. bottle X30 Couplant	1	2 oz. bottle X30 Couplant
1	BNC-BNC 6' Cable	1	BNC-BNC 6' Cable	1	BNC-BNC 6' Cable
1	BNC-Microdot 6' Cable	1	BNC-Microdot 6' Cable	1	BNC-Microdot 6' Cable
1	Soft Protective Cover	1	Soft Protective Cover	1	Soft Protective Cover
1	Operation Manual	1	Operation Manual	1	Operation Manual
1	NIST Calibration Certificate	1	NIST Calibration Certificate	1	NIST Calibration Certificate
1	Hard Shell Travel Case	1	Hard Shell Travel Case	1	Hard Shell Travel Case
-	---	-	---	1	Pentax II Printer Kit
-	---	-	---	1	FlawMaster Software Kit
	<i>Kit includes choice of two (2) of the following transducers.</i>		<i>Kit includes choice of three (3) of the following transducers.</i>		<i>Kit includes choice of four (4) of the following transducers.</i>
1	Spectrum™ E8L 5MHz 0.5" PowerLink™ Transducer	1	Spectrum™ E8L 5MHz 0.5" PowerLink™ Transducer	1	Spectrum™ E8L 5MHz 0.5" PowerLink™ Transducer
1	Spectrum™ E4L 2.25MHz 0.75" PowerLink™ Transducer	1	Spectrum™ E4L 2.25MHz 0.75" PowerLink™ Transducer	1	Spectrum™ E4L 2.25MHz 0.75" PowerLink™ Transducer
1	Spectrum™ C17L 10MHz 0.25" PowerLink™ Transducer	1	Spectrum™ C17L 10MHz 0.25" PowerLink™ Transducer	1	Spectrum™ C17L 10MHz 0.25" PowerLink™ Transducer
1	Spectrum™ F2L 2.25MHz 0.5" PowerLink™ Angle Beam Transducer	1	Spectrum™ F2L 2.25MHz 0.5" PowerLink™ Angle Beam Transducer	1	Spectrum™ F2L 2.25MHz 0.5" PowerLink™ Angle Beam Transducer
1	Spectrum™ G2 45° Wedge	1	Spectrum™ G2 45° Wedge	1	Spectrum™ G2 45° Wedge
1	Spectrum™ G4 60° Wedge	1	Spectrum™ G4 60° Wedge	1	Spectrum™ G4 60° Wedge
1	Spectrum™ G6 70° Wedge	1	Spectrum™ G6 70° Wedge	1	Spectrum™ G6 70° Wedge

1.4 Optional Accessories

Description	Function
Transducers (Contact your Staveley Instruments sales representative for a complete list of transducers)	<i>for different thickness/measuring applications</i>
Hands-free chest harness/battery belt	<i>for hands-free use of instrument</i>
SPAN dual Ni-MH battery external charger	<i>for charging batteries outside of instrument</i>
Hard shell travel case	<i>for protection of instrument when not in use</i>
Pentax Pocket-Jet Printer (includes RS-232 cable)	<i>for printout of reports/data</i>
Parallel/Serial converter	<i>for use of parallel printer with instrument</i>
Printer battery	<i>provides remote power for printer</i>
Protective soft cover/carry case	<i>for protection of instrument while in use</i>
Replacement Ni-MH batteries	<i>10.8V Battery</i>
*+ Model Accessories	
External Li-Ion Charger	<i>for charging batteries outside of instrument</i>
Rechargeable Li-Ion Battery	<i>10.8V Battery</i>
Color LCD Display	<i>required for external VGA output - includes VGA adapter cable</i>
Heads-Up Display	<i>for use in areas where you cannot directly see instrument display / hands-free instrument use</i>



Hands-free Chest Harness/Battery Belt - This accessory is designed to hold the weight of the Sonic[®]/Nortec[®]/BondMaster 1200 series of nondestructive test (NDT) equipment and its accessories. Specifically, the pouch on the chest harness is designed to hold the DR-35 battery sled, which adds two batteries to the system to extend field operation time. **THE CHEST HARNESS IS NOT DESIGNED TO SAFELY SUPPORT THE WEIGHT OF THE USER IN ANY SITUATION!**

1.5 Initial Inspection Checklist

After the Sonic[®] 1200S/HR has been unpacked and the contents of the carton have been checked against the packing list, a visual inspection and a basic operation test should be

performed.

- *Cosmetic or structural damage?*
- Instrument Power “On”
- Power On Self Test
- EL/LCD Sign On Message displays?

1.6 Power Requirements

As a fully portable inspection instrument, the Sonic[®] 1200S/HR relies on two nickel-metal hydride (Ni-MH) batteries (one Lithium Ion (Li-Ion) battery on ‘+’ models) as the primary source of power. The battery compartment is located at the rear of the unit and is conveniently accessed by loosening the two quick release screws and removing the battery cover.

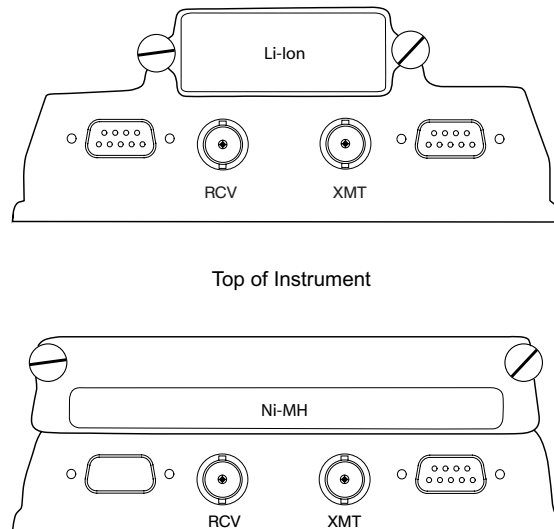

Figure 1-1: Battery Cover Locations

The batteries provided with the Sonic[®] 1200S/HR instrument are small, lightweight, portable, and capable of delivering long service life between recharges or battery replacement.

A Universal Battery Charger (UBC) unit is provided with the Sonic[®] 1200S/HR for recharging the batteries while in the instrument or external battery pack and allowing the Sonic[®] 1200S/HR to be operated from AC line power. The UBC unit auto senses 90-264 VAC, 47 to

63 Hz power.

The condition of the batteries used in the Sonic® 1200S/HR is monitored by the charger. Fully discharged Ni-MH batteries will require approximately 8 hours for a complete charging cycle (4 hours for each battery), while Li-Ion batteries will require approximately 6 hours. The charger will not charge batteries which are too hot, too cold, or too deeply discharged.

For optimum performance:

- Refer to the manual that came with your instrument or charger for charging instructions.
- When you charge your battery for the first time, your charger may indicate that charging is complete after just 10 to 15 minutes. This is normal and can happen with all rechargeable batteries when first charged. Simply remove the battery and then repeat the charging procedure.
- Upon first use, or after prolonged periods of storage, you may need to charge and discharge your battery two or three times before obtaining optimum performance.
- It is best to charge the battery at room temperature ranging between 59°F (15°C) and 86°F (30°C).
- It is normal for the battery to become warm during charging or after use.
- It is not necessary to fully discharge your battery before charging. You can top-off the charge at any time.
- A charged battery will gradually lose its charge if left in storage. We therefore suggest that you top-off the charge before use.
- Remove your battery from the equipment, charger or AC adapter when not in use. Store at room temperature in a dry place.

To avoid damage to the battery:

- Do not drop the battery or subject it to mechanical shock.
- Use the battery only with equipment that specifies its use.

For safe operation:

- Do not disassemble or attempt to open the battery under any circumstances.
- The battery can explode, leak, or catch on fire if heated or exposed to fire or high temperatures.
- Do not short circuit the battery by directly connecting the metal terminals (+, -). Be certain that no metal objects such as coins, paper clips, etc., touch the terminals.
- Only use the charger recommended by the device manufacturer.

Note that internal memory batteries should be changed as a preventative maintenance feature every two (2) years.



It is recommended that you refrain from operating the instrument while recharging fully discharged batteries. The charge may be incomplete and thus activate the temperature fault indicator — as a result, battery life and instrument run time may be shortened significantly. If the indicator is activated, shut off the instrument and disconnect the instrument from the charger. Allow the batteries to cool, then reconnect the charger to the instrument to start a new charge cycle.

1.7 Ni-MH Battery Characteristics

- *Higher capacity* - up to 40% longer run time than ordinary nickel-cadmium batteries of equivalent size
- *Fast Charge* - approximately 4 - 6 hours
- *Long cycle life* - up to 500 charge/discharge cycles
- *Temperature Range (charging)* - 32°F to 104°F (0°C to 40°C)
- *Temperature Range (operating)* - 32°F to 122°F (0°C to 50°C)
- *Temperature Range (storage)* - -4°F to 122°F (-20°C to 50°C)
- *Environmental friendliness* - 0% cadmium, no disposal problems
- *Size L x W x H* - 8.5 x 2.1 x 0.7 in. (215 x 53 x 19 mm)
- *Weight* - 18.4 oz. (515 g)
- *Nominal Voltage* - 10.8V
- *Rated capacity* - 3.8 Ah nominal
- *Hours of Operation* - 10+ hours with EL display or Monochrome LCD display

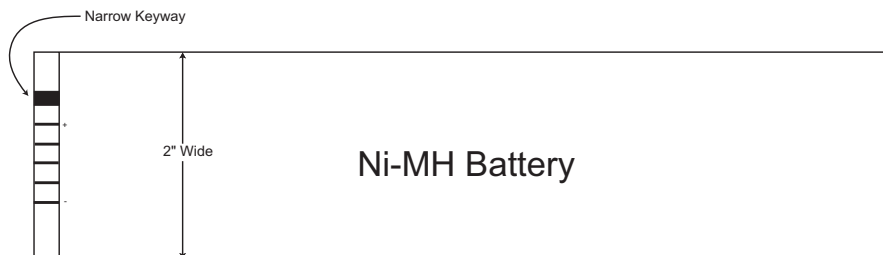

1.8 Li-Ion Battery Pack Characteristics

- *Higher capacity* - up to 60% longer run time than ordinary Ni-MH batteries of equivalent size
- *Fast Charge* - approximately 4 - 6 hours
- *Long cycle life* - up to 300 charge/discharge cycles
- *Temperature Range (charging)* - 32°F to 104°F (0°C to 40°C)
- *Temperature Range (operating)* - -4°F to 140°F (-20°C to 60°C)
- *Temperature Range (storage)* - -4°F to 122°F (-20°C to 50°C)
- *Environmental friendliness* - 0% cadmium, no disposal problems
- *Size L x W x H* - 8.5 x 2.3 x 0.9 in. (215 x 59 x 23 mm)
- *Weight* - 17.6 oz. (493 g)
- *Nominal Voltage* - 10.8V
- *Rated capacity* - 6.6 Ah nominal

- *Hours of Operation* - 8+ hours with EL display, Monochrome LCD, or Color LCD display

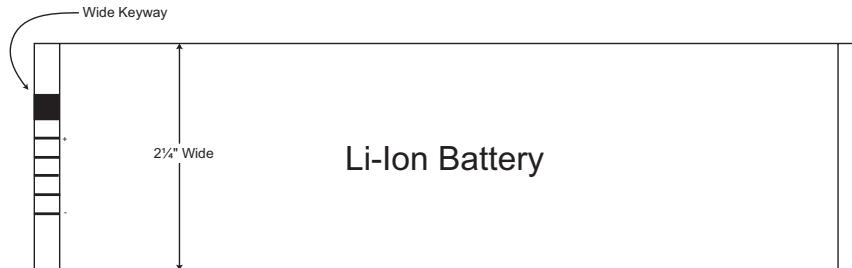

Fully charge battery before first use. Instrument run time is affected by variables such as: quality of charge, age of battery, and display type. The battery charge indicator on the display is an estimation of expected run time. Instruments are equipped with a circuit that shuts off power prior to full discharge. Battery life is affected by: number of charge/discharge cycles, storage conditions, temperature, and use. Batteries stored for extended periods of time (months/years) without use may no longer recharge. Under normal use Nickel-Metal Hydride (NiMH) batteries last approximately 500 charge/discharge cycles, while a Lithium-Ion battery will last approximately 300 cycles. Expect to change the batteries after 1 year of heavy use or 3 years of light use under normal conditions. Batteries must be disposed of in accordance to local law or returned to Olympus NDT Instruments. Olympus NDT Instruments does not warranty batteries, due to operating conditions beyond Olympus NDT's control affecting battery life.



Dual Ni-MH battery run time for the Sonic[®] 1200S/HR with the LCD module is at least 10 hours. Dual Ni-MH battery run time for the Sonic[®] 1200S/HR with the electroluminescent (EL) display module at 100% intensity, is at least ten (10) hours.

1.9 Charging the Ni-MH/Li-Ion Battery Pack

Proper charging of the Ni-MH/Li-Ion battery packs is critical for overall life and performance. The Universal Battery Charger (*UBC*) will charge either the Li-Ion battery used in the single battery instruments or both Ni-MH batteries in the dual battery instruments. The selection of charging system is made by the detachable cable to instrument connection. The two instrument categories have very different, non-interchangeable connectors to prevent an incorrect

connection. Note that the UBC to instrument cables are detachable and replaceable as catalog items.

The charger also functions as a battery eliminator to operate the instrument from the AC power source. Batteries do not have to be installed to operate the instrument from AC. When operated from the UBC without a battery installed in the instrument, disregard any battery charge status indications from the UBC charge indicator. The instrument can be operated while a Li-Ion battery is being charged, but is not recommended while charging Ni-MH batteries.

1.9.1 UBC Specifications

Power Requirements: 100-240 volts, 47 to 63 Hz.

The UBC contains an internal fuse.

Nickel Metal Hydride battery charging system: Sequentially charges two DR-35 style (Ni-MH) batteries. Charges at approximately 1 ampere rate. A pair of 3.8 AH batteries take about 8 hours to fully charge.

Lithium Ion battery charging system: Charges one Li-Ion battery. Charges at approximately 1.5 ampere rate. A 6.6 AH battery charges in approximately 6 to 8 hours.

Temperature range: Batteries should be charged between 40° to 100° F (4° to 38° C) for best results. If the batteries become too hot, the battery charger will terminate the charging process. If the batteries are being charged while using the instrument, the heat from normal operation of the instrument may cause the battery charger to terminate the charging process before the batteries are fully charged.

To start a charge cycle, the charger can be reset by disconnecting and reconnecting either the instrument or AC power to the UBC.

1.9.2 Charger Status Indicators

The charger status is indicated by a red/green LED lamp.

The light may blink red or green for a few seconds when first connected to either AC power or an instrument. It will then light steady red as the charging process starts. This is normal as the circuits initialize. If a problem is detected during charging, the light will blink red. Reset the charger by disconnecting the AC power for a few seconds and re-connect. If the problem persists, service is required.

1.9.3 Charger Operation Instructions

1. Connect the UBC to a source of AC power.
2. Connect either the single battery Li-Ion or dual Ni-MH cable to the instrument and charger.
3. **Ni-MH batteries:** The red charging indicator will light, indicating that the batteries are charging. The charger will charge one battery and automatically switch to the second battery when the first is charged. The indicator will turn green when both batteries are charged. If only charging one battery, the green charge complete indicator will not light. The red charging lamp will go out when the battery is charged. Ni-MH batteries generate heat while in use, especially during charging. This heat, added to that generated by the instrument, can cause the charger to terminate the charge cycle before the batteries are fully charged. It is not recommended that NiMH batteries be charged while operating the instrument. This is not due to power supply capacity, but heat build up within the instrument.
4. Ni-MH batteries receive a continuous trickle charge whenever they are connected to the UBC. If the instrument is being used on AC power for long periods of time, the batteries should be removed from the instrument. They should be re-installed and recharged and then removed at regular intervals to keep them fresh. 30 to 60 day intervals are recommended.
5. **Lithium-Ion batteries:** The red charging indicator will light, indicating that the batteries are charging. The indicator will turn green when the battery is charged.
6. The charger circuits can be reset if a problem occurs by disconnecting either the AC power for at least 15 seconds or the UBC to instrument cable (either end) and then re-connecting. Li-Ion batteries are sensitive to over charge. For this reason, the full charge detection system is very sensitive and may shut off the charging process before the charge is complete. If this happens, reset the charger. During use, the UBC case will become warm.
7. The charger is designed to shut off after a Li-Ion battery is fully charged (the instrument power is always available). It does not provide a maintenance charge, because Li-Ion batteries can be damaged by trickle charging. To recharge a Li-Ion battery, reset the charger by either disconnecting the AC supply or instrument for a few seconds to reset the charger circuit. Li-Ion batteries have a long shelf life and should only require recharging after many months of storage if not used.

1.9.4 Battery Safety

Old batteries that will no longer deliver satisfactory service should be disposed of in a legal and environmentally friendly manner. In the USA, call 1-800-8BATTERY for the nearest battery recycle center. If there is no convenient battery recycle center, the batteries may be returned to Olympus NDT Instruments for proper disposal.

No battery should be disposed of by fire or abused by puncturing its case or disassembled. All batteries contain potentially hazardous chemicals, however neither Ni-MH or Li-Ion batteries contain lead, cadmium or mercury.

Lithium-Ion batteries contain an internal safety circuit. Both Nickel-Metal Hydride and Lithium-Ion batteries contain internal fuses. If this fuse blows or the safety circuit shuts off the battery, the battery is no longer fit for service. The internal safety circuits are not serviceable.

Olympus NDT Instruments purchases batteries from reputable vendors. Although Olympus NDT Instruments tests and qualifies the batteries for use in Olympus NDT products, Olympus NDT can not guarantee that batteries obtained from other sources will be satisfactory or that Olympus NDT supplied batteries will work in non Olympus NDT products. The Universal Battery Charger is designed to work with Olympus NDT equipment *only*.

1.9.5 Battery Characteristics

Most batteries will not deliver their full charge on first use or after extended storage. Use them until the instrument shuts off after full discharge (automatic low battery shut off) and recharge. This will recondition the battery. This is especially prudent with Ni-MH batteries.

The battery is considered by the manufacturer to be beyond its service life when it delivers less than 80% of its rated capacity. A Ni-MH battery should have a life expectancy of 500 charge/discharge cycles and Li-ion batteries, 300 cycles. These specifications are obtained under laboratory conditions and real world usage will be different.

Battery life will be prolonged if they are not subjected to harsh temperatures, either hot or cold, and stored in a charged condition. Ni-MH batteries should be recharged periodically. They should not be left in the instrument when not being used over extended time.

Batteries have reduced capacity at low temperatures. Exact percentages are not specified but operation below freezing is not recommended.

1.9.6 UBC Spare Parts

Part Description	Part Number
Universal Battery Charger (UBC)	9522153
DIN connector cable for single battery instruments (Li-Ion battery)	9122229
7 pin Fischer cable for dual battery instruments (Ni-MH battery)	9122230
AC power cable (US three prong to IEC320)	0205959
AC power cable (UK 13 amp to IEC320)	0222159
AC power cable (Australian 3 conductor to IEC 320)	0222245
DR35 Nickel Metal Hydride Battery	0119447
Lithium Ion Battery	0119451

1.10 Operating Environment

The Sonic® 1200S/HR is designed as a portable instrument and, as such, requires no special site preparation before operation. When operating, the instrument should be firmly supported to prevent damage due to a fall. The unit should be protected as much as possible from water or chemical splashes, rapid temperature changes, and should be operated away from large electrical equipment that may interfere with the operation of internal circuitry.

2. Technical Data

Pulser:

Type: Square wave.

Pulse Width: 30 to 1000 ns (HR: 15 to 500 ns)

Accuracy: $\pm 10\%$ or 10 ns, whichever is greater.

Pulse Voltage: Selectable 300 or 150 volts.

Accuracy: $\pm 10\%$ - 15% .

Rise Time: < 15 ns.

Fall Time: < 60 ns damping 200 ohms. < 20 ns damping 50 ohms.

Damping: Selectable 25, 50 or 200 ohms.

Modes: Selectable single, dual, or through transmission.

Receiver:

Frequency Band: 0.3 to 20 MHz, ± 3 dB nominal.

Gain: 0 to 100 dB in wideband, highpass, 10 MHz, and 15 MHz (HR). 0 to 110 dB in 1, 2.25, and 5 MHz frequency settings.

Accuracy: ± 0.5 dB for any 10 dB increment, cumulative error $< \pm 2.0$ dB.

Control: Continuous adjustment in selectable 0.2, 1.0, 2.0, 6.0 or 12dB steps.

+dB switch: Selectable 6, 12, 18, or 24 increment.

Accuracy: ± 0.5 dB.

Tuning Range: Selectable 1, 2.25, 5, 10, 15(HR) MHz, wideband (0.3-15 MHz), and highpass (3-20MHz).

Q: 0.9 less than or equal to Q less than or equal to 1.2

Linear Reject: 0 to 80% full screen.

Accuracy: $\pm 0.5\%$.

Vertical Linearity: $\pm 2\%$ full screen for 10% to 90% of full screen display.

Dynamic Range: > 34 dB (largest signal = 100% full screen height, smallest signal $\leq 2\%$ full screen height).

Sensitivity: Better than 200 μ V.

Noise: < 15 μ V RMS

Display Modes: RF, RF+, RF-, fullwave, halfwave+, halfwave-, filter 1, 2, 3.

Thickness/RF: Thickness measure on live and frozen RF display modes.

DAC: Segmented with 25 operator selected points, segments generated automatically.

Range: 40dB, total of gain and DAC limited to 110dB maximum.

Accuracy: DAC range ± 2 dB, echo adjustment ± 0.5 dB.

Slew Rate: 6dB per μ s.

Depth: Sum of timebase delay and range up to 400 μ s.

DAC Display: Selection of multiple curves showing compensation; single curve at signal level (0 dB); three curves at +6 dB, 0, and -6 dB; four curves at +6 dB, 0, -6 dB, and -14 dB, JIS curves at +6 dB, 0, -6 dB, and -12 dB, DAC compensated echoes only; single curves with DAC compensated echoes.

Gates:

Gate Functions: Gate 1 time of flight, amplitude detection and flaw alarm. Gate 2 amplitude detection and flaw alarm, time of flight for echo-to-echo mode.

Gate Position:

- Start: 1.16 to 185" (-29 mm to 4694 mm) of steel (-10 to 1600 μ s).
- Width: 0.001 to 296" (0.001 mm to 7510 mm) of steel (0.001 to 2560 μ s).
- Control: Continuous over full range adjustment.
- Display: Alarm bar indicating position and threshold.
- Accuracy: $\pm 1\%$ of indicated position.

Threshold

- Control: Variable, 5 to 100% of full screen.
- Accuracy: $\pm 1\%$.

Flaw Alarm

- Logic: Selectable, positive or negative occurrence.
- Indicator: Switchable horn and flashing display indicators.

Peak Detector

- Amplitude: Peak amplitude of gated signal in percent of screen height.
- Accuracy: $\pm 1\%$.

Analog Output

- Amplitude: Scalable. 1000 mV to 4000 mV with offset -4000 mV to +4000 mV.
- Accuracy: Greater of 30 mV or 2% of display indication with a 1000 ohm load.

Alarm Output: 3.3 V logic signals (0V = no alarms, 3.3V = alarm condition).

Timebase:

Range

Range: 0.048 to 296" (1.23 mm to 7511mm) of steel (0.418 to 2560 μ s).

Accuracy: $\pm 1\%$.

Delay

Range: -1.16 to 185" (-29 mm to 4690mm) of steel (-10 to 1600 μ s).

Accuracy: $\pm 1\%$.

Velocity: 0.0250 to 0.6000 in/ μ s (635 to 15240 m/s).

Repetition Rate: 3450Hz maximum limited by range and pulse width settings.

- Control: Selectable in 50Hz steps.
- Accuracy: $\pm 0.05\%$.

Horiz. Linearity: $\pm 1\%$ of full screen.

Thickness:

Range: 0.010" (0.005 HR)-296" (or maximum display range, whichever is smaller).

Resolution: 0.010 (0.0005 HR) inch when display range is < 1.00 inch; 0.5% of display range when display range is equal to or greater than 1.00 inch

Distance Output

- Amplitude: Scalable. 1000mV to 4000mV.
- Accuracy: Greater of 30mV or 2% of display indication with a 1000 ohm load.

Modes: Selectable. Start-to-echo, echo-to-echo, autocal start-to-echo, autocal echo-to-echo.

Freeze: Thickness measurements on freeze display mode.

Trig Functions Angle beam calculations are performed and displayed, correction for curved surfaces.

Display: Soundpath, surface distance, and depth from the surface.

Angle: $0^\circ - 90^\circ$ in 0.1° increments.

Diameter: 0.250" - 100", flat (OFF).

RF Thickness: Thickness measurements in RF display mode.

Alarm Output: 3.3 v logic signals. (0 = no alarms; 2 v = alarm condition)

Connector:*Inputs*

POWER: Runs the instrument and recharges the battery from an external charger.

I/O

RS232C: DB9P connector, provides bi-directional serial RS232C communication port; port provides control and reporting of all instrument functions using a terminal or host computer.

Display Features:

Screen *Freeze*: On command, currently displayed signal is frozen

Waveform *Recall*: Select and display a stored waveform.

Reference Memory: Waveform recall and active signal displayed position control separate.

Peak Hold: Simultaneous display of peak amplitude waveform and active signal.

Storage: Up to 100 A-Scan waveforms may be stored for future playback or printout.

Control *Resolution*: Selection of 3 or 4 digit control.

Zoom: Expands gated region under Gate 1 to full display.

Additional Features:

Program Storage: Provides the ability to store up to 100 test setups in nonvolatile memory.

Report Fields: User-defined, 40 character report header; up to 7 user-defined, 40 character report fields and 26-character labels; and up to 3 user-defined, 26-character report entries may be downloaded through the RS-232 port, or entered through the report edit function.

Clock, *Calendar*: Time and date information stored and printed with each waveform.

Instrument ID: Manufacturer name and model printed with each waveform.

Int'l Menu: Selectable languages include English, Spanish, French, and German.

Lemo *XMT/RCV*: Optional European spec Lemo connectors for transmit and receive connectors.

PowerLink™: Automatic transducer recognition, instrument setup, and report field entry.

A-scan Security: Read-only selection prevents accidental erase of A-scan settings.

General:

Dimensions: 9.5" L x 5.5" W x 3.5" D (241 mm x 140 mm x 89 mm).

Weight:

- 1200S/HR: 6 lbs. (2.7Kg) with batteries installed.
- 1200S/HR+: 4 lbs (1.8Kg) with battery installed.
- 1200HR+: 4.6 lbs (2.09 Kg) with battery installed.

Display (EL): EL (electroluminescent), 3.0" x 3.8" (4.85" diagonal) (77 mm x 97 mm x 122 mm diagonal) active display area. 240 H x 320 pixel display resolution. 72 Hz refresh rate.
HR: EL (electroluminescent), 4.7" x 3.5" (5.7" diagonal) (120 mm x 90 mm x 145 mm diagonal) active display area. 320 H x 240 v pixel display resolution. 72 Hz refresh rate.

Display (LCD): Monochrome LCD (liquid crystal display), 3.0" x 3.8" (4.8" diagonal), 320 H x 240 V pixel. 72 Hz refresh rate. Backlight is adjustable for different viewing conditions.

Display (Color LCD) : Available as option for 1200S/HR+ and HR+ models. Color LCD (liquid crystal display), 3.0" x 3.8" (4.8" diagonal), 320 H x 240 V pixel. 72 Hz refresh rate. Backlight is adjustable for different viewing conditions.

Operating Temp: -4° to 140°F (-20° to 60°C)

Storage Temp: -40° to 176°F (-40° to 80°C)

Operating Humidity: 0% to 95% RH.

Power

- DC(2) 10.8V DR35 Ni-MH batteries or (1) 10.8 V Li-Ion battery, depending on model.
- ACExternal. Will recharge the battery pack in approximately 4-6 hours, and run the instrument simultaneously.

Battery Level: Front panel display. A warning message indicates when there is less than ½ hour of operating time left.

Operating *Time*: 8 to 10 hours typical at 75°F. The estimated operating time remaining is indicated by an icon on the status display.

3. FastBreak Operation

What's in this section?

- 3.1 Getting Started with FastBreak Operation
- 3.2 *Ready*
- 3.3 Operating Menu Structure
- 3.4 *Set* - Horizontal Screen Calibration-Angle Beam Inspection (10.0 Range)
- 3.5 *Go* - Weld Inspection

3.1 Getting Started with FastBreak Operation

The *FastBreak* Operation section was created for the more experienced nondestructive testing (NDT) operator. The intent is to provide a shortcut to instrument operation for the two most frequently used methods of flaw detection and thickness testing, Angle Beam Weld Inspection and Dual Element Thickness Measurement. Specific examples are given for 10.0" angle beam and 0.500" thickness measurements. If your particular application requires another method of flaw detection or thickness testing, a complete guide of step-by-step applications is provided in Section 5, *Applications*.

3.2 Ready

The following controls and menus are required for instrument set-up and calibration. Menus are activated by pressing the associated menu key. Parameters are selected by pressing the soft key below the parameter to be adjusted. Parameters may be changed by either rotating the SmartKnob™ or pressing the up and down arrow keys on the display module.

3.3 Sonic® 1200S/HR Operating Menu Structure

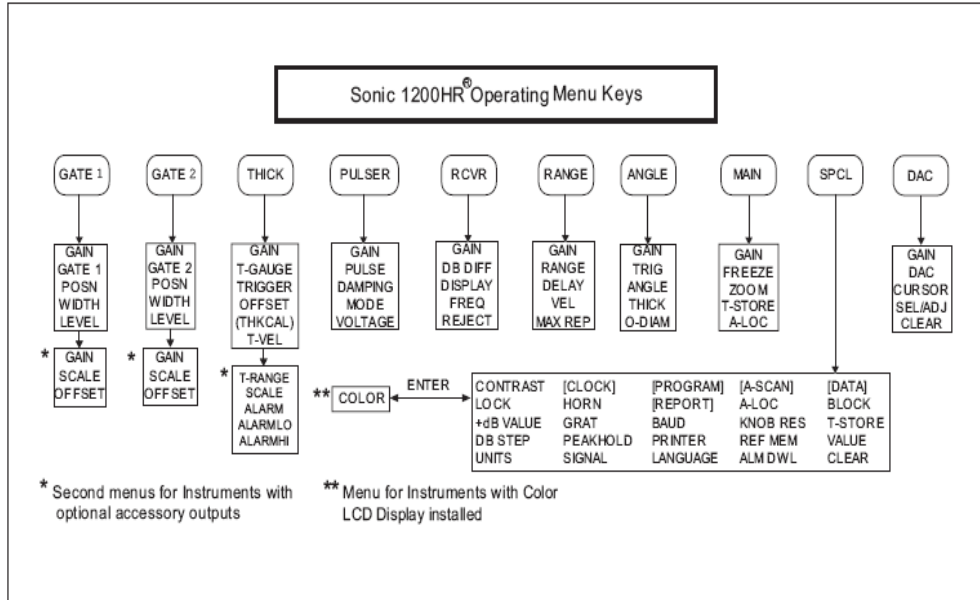
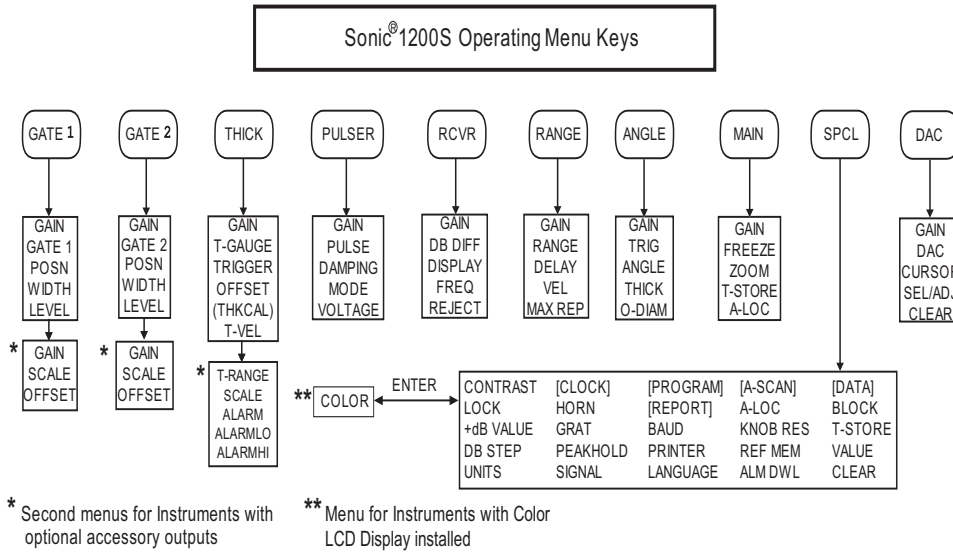

3.4 Set — *Horizontal Screen Calibration* — Angle Beam Inspection (10.0" range)

1. Adjust the timebase RANGE and VELOCITY to 10.0" and 0.1260 in/ μ s respectively.
2. Set the timebase DELAY to 0.600".
3. Set the PULSER mode to SINGLE.
4. Select RCVR GAIN and FREQUENCY appropriate for the transducer in use (60 dB is a good starting point).
5. Choose the RCVR DISPLAY mode which gives the best signal response.
6. Verify the transducer wedge angle and index point.
7. Using a standard block such as IIW Types I or II or the AWS B1 block, calibrate the screen range as follows:
 - a) Move the transducer to intercept the calibration reflector on the calibration block.
 - b) Adjust the timebase DELAY until the first echo falls on the graticule line outlined for the block in use.
 - c) Adjust the timebase VELOCITY until the second display echo falls on the graticule listed.
 - d) Repeat until all echoes align with appropriate graticule lines.

BLOCK	INDICATIONS		
	First Reflection	Second Reflection	Other Reflections
-	Line 4 (4")	Line 9 (9")	
IIW Type 1	Line 2 (2")	Line 4 (4")	
B1 Block	Line 1 (1")	Line 4 (4")	Lines 7,10 (7",10")

3.4.1 Horizontal Screen Calibration

1. Adjust the timebase RANGE and VELOCITY to 0.500" and 0.2310 in/ μ s, respectively.
2. Set the timebase DELAY to 0.400".
3. Set the PULSER mode to DUAL.
4. Select RCVR GAIN and FREQ appropriate for the transducer in use (60 dB is a good starting point).

5. Choose the RCVR DISPLAY mode which gives the best signal response.
6. Using a standard step block with graduated steps of at least 0.100" and 0.500", make the following instrument adjustments:
 - a) Move the transducer to the 0.100" step
 - b) Adjust the timebase DELAY until the first echo falls on the 2nd graticule line (0.100").
 - c) Move the transducer to the 0.500" step
 - d) Adjust the timebase VELOCITY until the first echo falls on the 10th graticule line (0.500").
 - e) Repeat the above adjustments and checks until the echoes fall on the correct graticule lines.

The calibration may be checked by testing other steps and verifying that the echoes fall on the correct lines.

3.4.2 Go - Weld Inspection

1. Calibrate the search unit reference level sensitivity using a calibrated reference block.
2. Adjust the RCVR GAIN in accordance with the inspection code. The weld may now be inspected using the scanning pattern indicated by code. Flaw location and sizing may be done using traditional methods.

When using the thickness gauge for flaw location:

1. Change the THICK T-GAUGE to IP-1 (IP to 1st echo).
2. Adjust the T-VEL to the welded material velocity.
3. Set the OFFSET to the wedge thickness (to find the wedge offset in μs , divide the wedge thickness by the wedge velocity) or use a calibration plate to find wedge offset.
4. From the ANGLE menu, set TRIG=ON.
5. Set the angle beam ANGLE to the wedge angle.
6. Change the angle beam THICKNESS to the plate or wall thickness.
7. Adjust the GATE1 POSN to cover the weld area.
8. Adjust the GATE1 LEVEL to approximately 70% of the reference level.
9. If a flaw is detected, adjusting the gain to determine flaw size will cause the defect echo to cross the flaw gate.

3.4.3 Dual Element Thickness Measurement - Manual Mode

1. Turn the THICK T-GAUGE to IP-1 (IP to 1st echo).
2. Adjust the T-VEL to the test material velocity.
3. Set the ANGLE beam ANGLE to OFF.
4. Adjust the GATE1 POSN and WIDTH to cover the test range.
5. Adjust the GATE1 LEVEL to approximately 50% of the reference level.
6. Using a step block with graduated steps of at least the test range, make the following instrument adjustments:
 - a) Move the transducer to the smallest desired step. Be sure the echo breaks the gate. Readjust the gate and GAIN as necessary.
 - b) Adjust the THICK OFFSET until the thickness readout reads the correct value.
 - c) Move the transducer to the largest desired step.
 - d) Adjust the THICK T-VEL until the thickness readout reads the correct value.

Repeat the above adjustments and checks until both test values read correctly.

The test piece may now be inspected.

The multi-echo mode may be used by selecting the THICK T-GAUGE E-E mode and repeating the above procedure with GATE1 placed over the first back echo and GATE2 over the second.

3.4.4 Dual Element Thickness Measurement - Auto Mode

1. Turn the THICK T-GAUGE to A IP-1 (Auto IP to 1st echo).
2. Set the ANGLE beam ANGLE to OFF.
3. Adjust the GATE1 POSN and WIDTH to cover the test range.
4. Adjust the GATE1 LEVEL to approximately 50% of the reference level.
5. Using a step block with graduated steps of at least the test range, make the following instrument adjustments:
 - a) Move the transducer to the largest desired step.
 - b) Select THK CAL (Cal Pt 1), and rotate the SmartKnob™ to select the largest step value.
 - c) Move the transducer to the smallest desired step. Be sure the echo breaks the gate. Readjust the gate and GAIN as necessary.
 - d) Press THK CAL soft key (Cal Pt 2), and rotate the SmartKnob™ to select the smallest step value. Press THK CAL.

The operator may begin the THK CAL either from the larger or the smaller thickness step block. Please keep in mind that Cal Pt 1 < Cal Pt 2 *OR* Cal Pt 1 > Cal Pt 2.

Calibration is complete. The test piece may now be inspected.

The multi-echo mode may be used by selecting the THICK T-GAUGE E-E mode and repeating the above procedure with GATE1 placed over the first back echo and GATE2 over the second.

4. Control Descriptions

What's in this section?

- 4.1 Instrument Controls
- 4.2 Power Button
- 4.3 Displays
- 4.4 Soft Keys
- 4.5 NC/DEC Arrow Keys
- 4.6 Main Menu Keys
- 4.7 Enter Key
- 4.8 Print Key
- 4.9 SmartKnob™
- 4.10 RCV and XMIT BNCs
- 4.11 Pulser Menu
- 4.12 Receiver Menu
- 4.13 Range Menu
- 4.14 Gate 1 Menu
- 4.15 Gate 2 Menu
- 4.16 Thickness Menu
- 4.17 Angle Menu
- 4.18 DAC Menu
- 4.19 Main Menu
- 4.20 SPCL Menu
- 4.21 Program Sub-Menu
- 4.22 Report Form Sub-Menu
- 4.23 Clock Sub-Menu

- 4.24 A-Scan Sub-Menu
- 4.25 A-Scan Attribute Sub-Menu
- 4.26 Data Sub-Menu
- 4.27 New Block Editor
- 4.28 Block Review Sub-Menu
- 4.29 Text Editor
- 4.30 Instrument Reset

4.1 Instrument Controls

This section covers the operational controls of the Sonic[®] 1200S/HR.

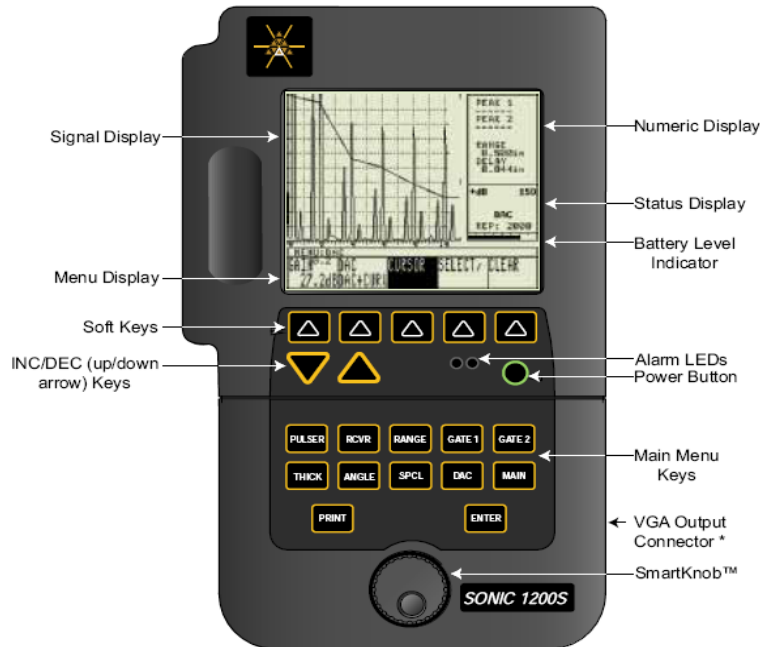

Figure 4-1A: Sonic[®] 1200S Controls

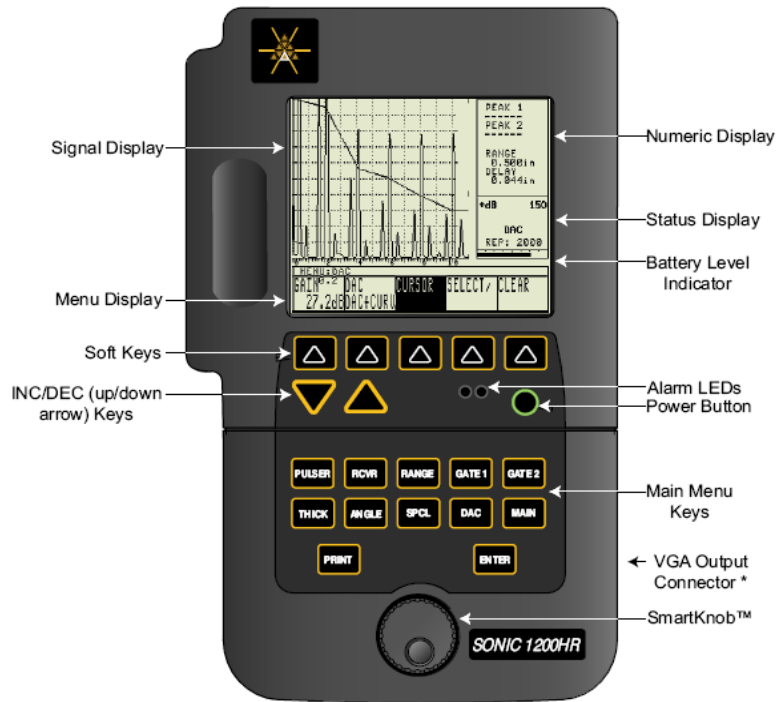

Figure 4-1B: Sonic® 1200HR Controls

4.2 Power Button

The POWER Button toggles instrument power on and off. Immediately after power is turned ON, an initialization routine is started. The instrument's microprocessor determines the instrument configuration, performs power-up diagnostics and calibration, and readies the instrument for operation. The instrument will normally attempt to restore its last configuration, but can be made to load factory default settings by pressing and holding the RANGE key while the instrument powers up.

4.3 Displays

The display contains a symbol indicating remaining battery life. When the unit has

approximately one half hour operating time remaining, a status message in the battery level window indicates a low-battery condition. A low-battery cutoff circuit will automatically switch the unit off to protect the batteries from excessive discharge.

The instrument may be configured with either an electroluminescent (EL), monochrome, or color liquid crystal display (LCD). All displays offer 240 H x 320 V resolution. The display area is divided into four sections.



The Sonic® 1200S/HR has user-interchangeable displays. Failure to turn off power before exchanging displays will result in loss of stored programs and A-scans, and may cause other memory corruption errors.



DO NOT attempt to plug a VGA monitor into the 15 pin D connector. This will result in a damaged instrument and/or VGA monitor.

Signal Display

Signal Display is used to display the ultrasonic signal return from the transducer. It contains a 10 division by 10 division electronic graticule for signal amplitude and position measurements. The graticule display is operator selectable.

Numeric Display

Numeric reading of display shows thickness or peak amplitude readings. In angle beam inspections, display will show sound path, distance, and depth readings simultaneously.

Status Display

The Status Display shows the operating status of the instrument and indicates when features are activated or conditions occur. It is also used to display prompts and error messages.

Menu Display

The Menu Display consists of *menu soft key* blocks for displaying instrument operating parameters. Each *menu soft key* block contains a descriptive label of the parameter and its current setting.



Placing the LCD display in direct sunlight will result in temporary fade due to the elevation of internal liquid temperature beyond design specification. Shade or angle the display away from the sun to assure optimal function.

Status Indicators	Condition	Menu
LOCK	Instrument parameters (excluding GAIN and LOCK) are locked and cannot be changed from the front panel until unlocked.	SPCL
ZOOM	The display is in zoom to display the gated region	MAIN
150V	Which pulser voltage is selected (150V or 300V).	PULSER
DUAL	The pulser/receiver is operating in dual element mode.	PULSER
REJ	Linear reject is being applied to the received signal.	RCVR
+dB	+dB feature status.	SPCL/ALL
DAC	Indicates DAC is being applied to the received signal.	DAC
PL	Indicates PowerLink™ transducer is being used.	
REP	Displays actual instrument repetition rate.	RANGE

The EL Hi-Brite Display is capable of switching from a 100% to 30% brightness level. This feature is accessed by highlighting the Contrast block in the Special Menu, then pressing ENTER. As with all of our displays, the instrument must be powered off prior to disconnecting/connecting a new display. Failure to follow this warning may result in instrument and/or display damage.



The EL Hi-Brite Display may go blank for approximately 1 second after connecting or disconnecting the Universal Battery Charger. This is normal operation.

4.4 Soft Keys

The *soft keys* located directly below the display are used to select instrument parameters for adjustment (using the arrow keys and the SmartKnob™). For some parameters, the *soft keys*,

when repeatedly pressed, will toggle through specific parameter settings (discrete steps). The first time a *soft key* is pressed, the parameter located in the display box directly above the key will be highlighted using inverse video.

4.5 INC/DEC Arrow Keys

The Increase/Decrease arrow keys may also be used to change parameter settings. The parameter being adjusted will be displayed in inverse video directly above one of the menu soft keys. Holding these keys down will cause the rate of adjustment to be increased over time.

4.6 Main Menu Keys

Referring to the front panel view, the PULSER, RCVR, RANGE, GATE 1, GATE 2, THICK, ANGLE, SPCL, DAC, and MAIN keys are all used to select menus. The parameter to be adjusted or selected is shown in inverse video above one of the five soft keys. The microprocessor keeps track of which parameter was last adjusted for each menu. It then returns the operator to that parameter when the menu key is struck again after moving to a different menu. The following sections show the different menus and briefly describe the parameters in each.

There are ten types of menu keys associated with normal inspection procedures that may be displayed in the soft key Display. Each menu key contains up to five parameters associated with instrument operation which may be adjusted. The ten primary menus are organized so that the most important instrument parameters are accessible within two key presses. The SPCL menu contains a grid of less frequently adjusted parameters.

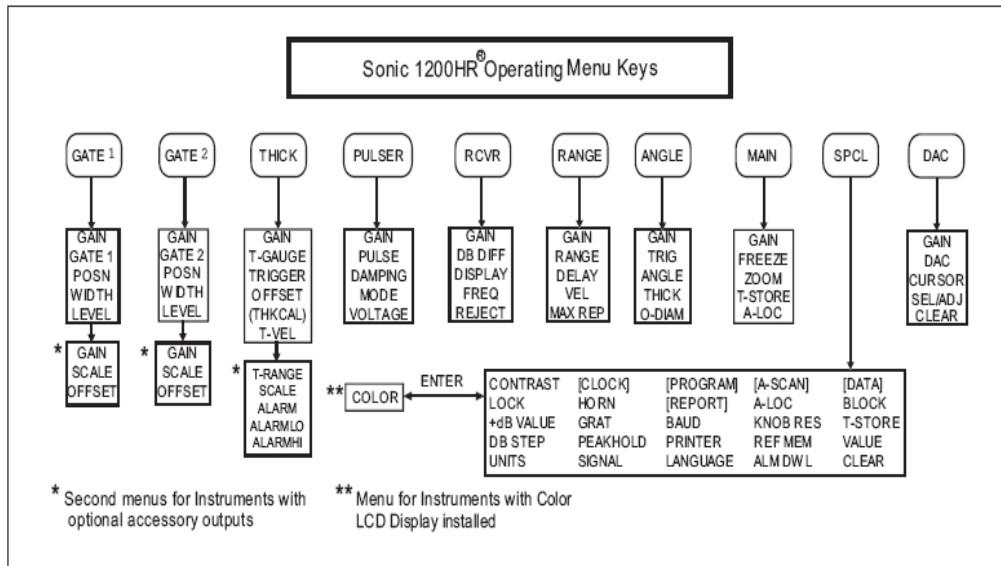
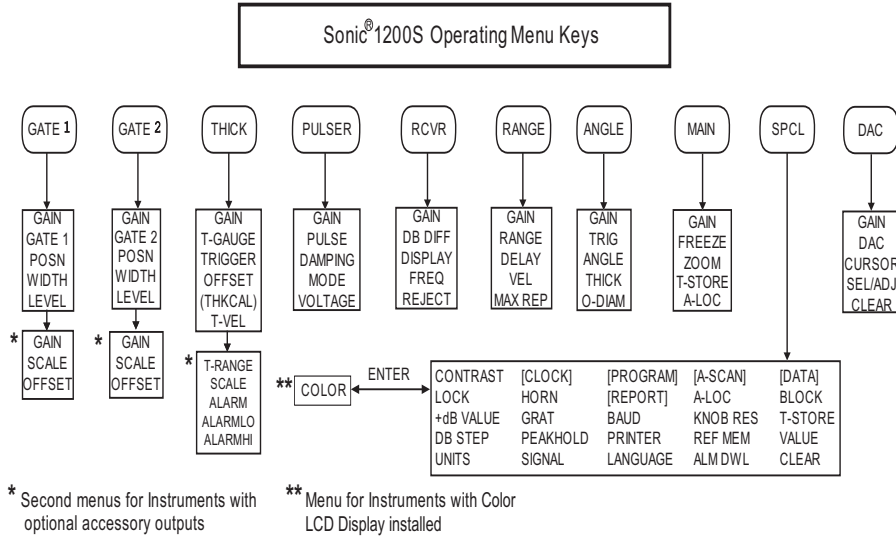

4.7 ENTER Key

The ENTER key may be used to select a sub-menu, toggle a parameter value, execute or confirm an instrument operation, or respond to an instrument prompt.

4.8 PRINT Key

The PRINT key may be used to produce a hard copy output of the screen information to an external printer via the RS-232 I/O port. If the printer is not connected or improperly configured, a SERIAL ERROR! warning will be displayed. Otherwise, a PRINTING message will be displayed.

4.9 SmartKnob™

The primary function of the SmartKnob™ is to change the selected instrument parameters. The parameter being adjusted will be displayed in inverse text directly above one of the *menu soft keys*. The SmartKnob™ is also used to select characters in the edit function for the programmable report form. In some instances, the SmartKnob™ may be used to respond to various prompts.

4.10 RCV and XMIT BNCs

The two transducer BNCs (RCV and XMIT) are connected together when the Pulse Echo mode of operation is selected. A single element transducer may be connected to either BNC with the same results.

For Dual and Through transmission modes of operation, the transducer excitation pulse is present at the XMIT BNC only. A fixed 100V load is connected to the RCV BNC in these modes. The RCV connector monitors the return echoes from the dual element transducer. The damping control is connected to the XMIT BNC only.



Poor quality or excessively long cable, while not detrimental to the instrument, can adversely affect signal-to-noise ratio. For best results, use quality cables no longer than necessary for the operation.

4.11 Pulser Menu



MENU:PULSER				
GAIN ^{0.2}	PULSE	DAMPING	MODE	VOLTAGE
30.0dB	100ns	200Ω	SINGLE	150V

The PULSER menu key invokes the pulser menu shown and is used to adjust the operating characteristics of the square wave pulser.

GAIN See GAIN parameter description in the Receiver menu section.

PULSE Adjusts the square wave pulse width. The adjustment range is 30ns to 1200ns in 1ns increments.

DAMPING Selects the damping applied to the transducer crystal. The selections are 25, 50, and 200 ohms. In PULSE ECHO mode, the damping load is electrically connected to both transmit XMIT and receive RCV BNCs. In DUAL and THRU XMIT modes, the receive crystal is connected to a fixed 100 ohm load and the damping load is electrically connected to the transmit BNC only.

MODE Selectable between SINGLE, DUAL, and THRU XMIT modes. In SINGLE and DUAL modes, the sound path distance displayed and the Menu Display range values are corrected for sound path down and back time.

VOLTAGE Adjusts the square wave pulse voltage. The selections are 150V and 300V. The selected voltage is shown on the status portion of the display.

4.12 Receiver Menu



MENU:RCVR				
GAIN ^{0.2}	DB DIFF	DISPLAY	FREQ	REJECT
30.0dB	0.0dB	FULLWAV	5MHZ	0%

The RCVR key invokes the receiver menu. This menu is used to adjust the receiver and display video characteristics.

GAIN Adjusts the receiver gain in 0.2, 1.0, 2.0, 6.0, or 12.0 dB steps (established in the SPCL menu). The adjustment range is 0 to 110 dB. The maximum gain is limited to 100 dB in

wideband, 10 MHz tuned settings, and all RF displays to limit screen noise. The gain setting is a relative value and does not reflect actual overall signal gain.

The instrument's +dB feature is toggled OFF and ON alternately by pressing the gain soft key when the gain parameter is highlighted. A +dB icon is shown in the status portion of the display if this feature is active.

DB DIFF Allows the operator to establish a gain reference for signal amplitude comparison. Pressing this soft key will force the instrument DB DIFF value to +0.0 dB. The DB DIFF value will track all future changes in the gain value (+/-).

DISPLAY Selects the type of video. Available modes are positive halfwave "HALF+", negative halfwave "HALF-", fullwave "FULLWAV", "RF", "RF+"(HR), "RF-"(HR), and display filter functions (FILTR1, FILTR2, and FILTR3). Filters are only accessible with software revision R00A or greater.

FREQ Selects the frequency of operation of the receiver filtering circuitry. Selections are 1MHz, 2.25 MHz, 5 MHz, 10 MHz, 15 MHz (HR), WIDEBAND (0.3 - 15 MHz), and HIPASS (3 - 15 MHz). When the frequency control is changed, the square wave pulse width is automatically set to one-half the wavelength of the selected setting.

REJECT Adjusts the linear reject level. This value is adjustable from 0 to 80% of full screen height in 1% increments. When reject is on, a status indicator is displayed.

4.13 Range Menu



The RANGE key calls up the range menu shown and is used to adjust the time base parameters.

GAIN See GAIN parameter description in the Receiver menu section.

RANGE Adjusts the time base range from 0.048 to 296 inches in steel. Adjustment step size varies from 0.001 to 1 unit. The range is corrected for the down and back time of the signal when operating in PULSE ECHO mode. *Refer to the VEL description for further Range limits.*

DELAY Adjusts the time base delay from -1.16 to 185 inches in steel. Adjustment step size varies from 0.001 to 1 unit. *Refer to the VEL description for further Delay limits.*

VEL Selects the material sound propagation velocity. The adjustment range is 0.0250 in/ μ s to 0.6000 in/ μ s. The allowable minimum and maximum values for range and delay are based on the velocity setting. *If the instrument limits the adjustment for range, delay, gate position, or gate width, it may be due to the current velocity setting.*

MAX REP Adjusts the frequency of the square wave pulse applied to the transducer crystal. The maximum rate is limited by the Range, Pulse Voltage, and Pulse Width settings. Decreasing MAX REP may reduce the noise on the display.

4.14 Gate 1 Menu



MENU:GATE 1				
GAIN ^{0.2}	GATE 1	POSN	WIDTH	LEVEL
30.0dB	OFF	1.00in	1.00in	49%

The GATE 1 key calls up the gate 1 menu shown and is used to adjust the gate 1 parameters. This menu sets up parameters such as polarity, position, width, and level for flaw gate 1. Gate 1 may also be used for thickness measurement by enabling the T-GAUGE control.

GAIN See GAIN parameter description in the Receiver menu section

GATE 1 Selections are “+”, “-”, and “OFF”; “+” signals a gate alarm when the signal amplitude is above the threshold level, and “-” signals an alarm when the flaw amplitude is below the threshold level. “OFF” turns off the flaw gate. If a gate is in the alarm state when the thickness gauge is OFF, the amplitude is displayed under the associated gate bar in inverse video.

POSN Adjusts the gate 1 start position from -1.160 to 185.0 inches in steel. The position is displayed as the distance from IP in the selected units. Adjustment step size varies from 0.001 to 1 unit. *Refer to the VEL description for further Gate Position limits.*

WIDTH Adjusts the width of gate 1 from 0.001 to 296.0 inches in steel. Adjustment step size is 0.001 to 1 unit. *Refer to the VEL description for further Gate Width limits.*

LEVEL Sets the gate 1 threshold value in terms of % of full screen height (FSH) for the alarm. Adjustable from 5% to 100% of FSH in 1% increments.

To access the Gate 1 *second* menu, press the GATE 1 key twice. This second menu sets up gate 1 parameters, such as scale and offset, for analog output of echo peak amplitude. When Gate 1 is turned off, the output 1 is set to 0mV. Thickness gauge operation disables Gate 1 outputs.

SCALE Any value from 1000 mV to 4000 mV in 250 mV increments. Default is 4000 mV.

OFFSET Adjustable between -4000 mV and 4000 mV in 10 mV increments. Default is 0 mV.

4.15 Gate 2 Menu



MENU:GATE 2				
GAIN ^{0.2}	GATE 2	POSN	WIDTH	LEVEL
30.0dB	OFF	1.00in	1.00in	30%

The GATE 2 key calls up the gate 2 menu shown and is used to adjust the gate 2 parameters. This menu sets up parameters such as polarity +/-, position, width, and level for flaw gate 2. Gate 2 may also be used by the thickness gauge for echo-echo thickness measurement.

GAIN See GAIN parameter description in the Receiver menu section

GATE2 Selections are “+”, “-”, and OFF; “+” selects the gate alarm when the signal amplitude is above the threshold, and “-” selects that gate alarm when the flaw amplitude is below the threshold level. “OFF” turns off the flaw gate. If a gate is in the alarm state when the thickness gauge is OFF, the amplitude is displayed under the associated gate bar in inverse video.

POSN Adjusts the gate 2 start position from -1.16 to 185.0 inches in steel. The position is displayed as the distance from IP in the selected units. Adjustment step size varies from 0.001 to 1 unit. *Refer to the VEL description for further Gate Position limits.*

WIDTH Adjusts the width of gate 2 from 0.001 to 296.0 inches in steel. Adjustment step size is 0.001 to 1 unit. *Refer to the VEL description for further Gate Width limits.*

LEVEL Sets the gate 2 threshold value in terms of % of full screen height (FSH) for the alarm. Adjustable from 5% to 100% of FSH in 1% increments.

To access the Gate 2 *second* menu, press GATE 2 key twice. This second menu sets up gate 2 parameters, such as scale and offset, for analog output of echo peak amplitude. When Gate 2 is turned off, the output 2 is set to 0mV.

SCALE Any value from 1200mV to 4000mV in 250mV increments. Default is 4000mV.

OFFSET Adjustable between -4000mV and 4000mV in 10mV increments. Default is 0mV.

4.16 Thickness Menu



MENU: THICK				
GAIN ^{0.2}	T-GAUGE	TRIGGER	OFFSET	T-VEL $\frac{in}{\mu s}$
30.0dB	OFF	EDGE	0.000us	0.2310

The THICK key calls up the thickness menu shown and is used to adjust the thickness gauge parameters. The thickness gauge controls are used to enable, configure, and calibrate the thickness gauge. The thickness gauge uses gate 1 for IP - 1ST and both gates (1 and 2) for ECHO - ECHO.

GAIN See GAIN parameter description in the Receiver menu section.

T-GAUGE Enables or disables the thickness gauge feature and selects the measurement mode. The thickness gauge may be set to operate in IP - 1st, Echo-to-Echo, Auto IP-1st, or Auto Echo-to-Echo mode. In Auto IP-1st or Auto Echo-to-Echo mode, Auto-Cal is based on acquiring readings of two known thickness references. Notice that in the Auto IP - 1st, or Auto Echo-to-Echo mode, the OFFSET soft key is replaced by the THK CAL soft key function.

Thickness gating is performed using the instrument's flaw gate(s). IP - 1st thickness measurements require gate 1, while Echo-Echo thickness measurements require both gates 1 and 2.

Turning the thickness gauge ON forces the appropriate gate or gates ON. Conversely, turning the thickness gauge OFF forces the appropriate gate or gates OFF. When the thickness gauge alarm is enabled and an alarm condition occurs, readings will be displayed in inverse video. Gate alarm conditions cause amplitude readings to be displayed in inverse video.

TRIGGER Selects the part of the signal used to trigger for the thickness measurement. Selections include edge (leading) or peak.

OFFSET Selects and displays the thickness gauge zero offset. The offset adjustment range is used to establish the starting point for IP - 1ST measurements. Offset is adjustable from -5 μ s to 100 μ s.

THK CAL Selects the thickness reference value for CAL PT 1 and CAL PT 2. Press ENTER key at each CAL PT to advance and calibrate.

T-VEL Selects and displays the thickness gauge material sound propagation velocity. The adjustment range is 0.0250 in/ μ s to 0.6000 in/ μ s.

The allowable minimum and maximum values for part thickness and outer diameter are based on the T-velocity setting. If the instrument limits the adjustment for part thickness and outer diameter, it may be due to the current T-velocity setting.

To access the Thickness *second* menu, press the THICK key twice. This second menu provides additional thickness gauge parameters.

T-RANGE Selectable 1in./25mm, 5in./125mm, 25in./600mm, 100in./2500mm, and 300in./7500mm. Default is 1in./25mm.

SCALE Output voltage scaleable between 1000mV and 4000mV in 250mV increments. Default is 4000mV. Over range voltage is 4000mV.

ALARM When the thickness gauge is turned off, the thickness alarm is set to OFF. Default is OFF.

ALARM LO Default is 0.0 inch. The low alarm cannot be set for a larger value than the high alarm.

ALARM HI Default is 1 inch. The high alarm cannot be set for a smaller value than the low alarm.

When the thickness gauge is OFF, the thickness alarm output is set to 0mV or to Gate 1 output (if the gate 1 is ON).

When the thickness gauge is ON and no signal intersects the gate(s), the alarm output is 4000mV.

4.17 Angle Menu



MENU: ANGLE				
GAIN ^{0.2}	TRIG	ANGLE	THICK	O-DIAM
30.0dB	OFF	30.0°	1.00in	10.0in

The ANGLE key activates the angle beam measurement menu. This function allows weld and other shear wave inspection trigonometric calculations to be displayed.

GAIN See GAIN parameter description in the Receiver menu section.

TRIG This control enables and disables the angle beam calculation feature.

ANGLE This control enables/disables angle beam calculations and specifies the refraction of the sound beam into the test part (wedge angle). This control may be adjusted from 0° (OFF) to 90° in 0.1° increments. When an angle is specified, the sound path, depth, and distance measurements are displayed simultaneously.

THICK The actual thickness of the part under inspection can be specified from 0.001 to 185.0 inches. This entry allows the microprocessor to determine which “leg” the sound beam is in when an echo is detected, and hence correct the sound path, distance, and depth values for the leg. This provides the operator with electronic weld soundpath calculation ability. Refer to the T-VEL description for further THICK limits.

O-DIAM Outer diameter of the curved surface for correction of depth and distance measurements. The outer diameter may be set to a value in the range of 0.001 inches to 185.0 inches, or it may be turned OFF for flat objects. Refer to the T-VEL description for further O-DIAM limits.

4.18 DAC Menu

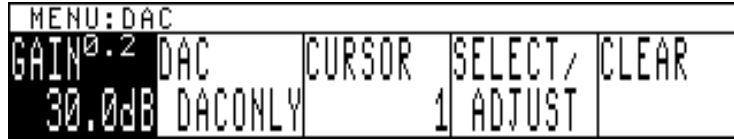

The DAC key activates the DAC menu. This menu offers controls that allow the operator to construct and modify a DAC/Curve.

GAIN See GAIN parameter description in the Receiver menu section

DAC The DAC control selects the operating mode of the DAC circuitry. The options are OFF, CURVONLY, 3 CURVES, 4 CURVES, JIS, DAONLY, and DAC+CURV. 3 CURVES displays the programmed curve and the curves ±6dB above and below the programmed curve. 4 CURVES displays the programmed curve, the curves 6dB above and below the programmed curve, and -14dB below the programmed curve. JIS displays the programmed curve, the curves 6dB above and below the programmed curve, and -12dB below the programmed curve.

CURSOR Allows a DAC cursor, a small display circle that tracks signal peaks, to be moved back and forth across the screen to select points where DAC compensation will be calculated, and the amplitude of the selected points will be adjusted. Repeated presses of this soft key control will jump the cursor from one previously defined point to the next.

SELECT/ADJUST This control allows selection of a new DAC point and/or amplitude adjustment of the selected DAC point. Amplitude adjustment is only available when the DAC control is set to DACONLY or DAC+CURV.

CLEAR Allows clearing the DAC/DAC Curve.

4.19 MAIN Menu



MENU: MAIN				
GAIN ^{0.2}	FREEZE	ZOOM	T-STORE	A-LOC
30.0dB	OFF	OFF	(1,1)	1(E)

The MAIN key invokes the main menu and its parameters. The main menu contains parameters that offer one touch storage and feature control.

GAIN See GAIN parameter description in the Receiver menu section.

FREEZE The FREEZE control activates and deactivates the freeze feature. The FREEZE function will “freeze” the current A-Scan display and allow thickness measurement. Pressing the PULSER, RCVR, RANGE, or SPCL key turns off the Freeze function.

ZOOM The ZOOM feature allows the operator to expand the contents of the gate 1 region to full screen width. Toggle ZOOM off and on for the desired display.

T-STORE With this parameter highlighted, repeated presses of the T-STORE soft key store the displayed thickness reading in the specified location and increment the location numbers. The arrow key may be used to increase or decrease the storage location. The instrument will not advance the location number beyond the limit of the block. To use T-STORE, T-gauge must be on and a data logger block defined.

A-LOC The A-LOC function stores the displayed A-Scan in the specified storage location and automatically increments the location number. If the selected location is FULL, the location number will have an “(F)” next to it, the store operation will NOT take place, and an “INVALID” indicator will be displayed on the status line. The instrument will not advance the location number beyond the A-Scan storage limit of 100.

4.20 SPCL Menu

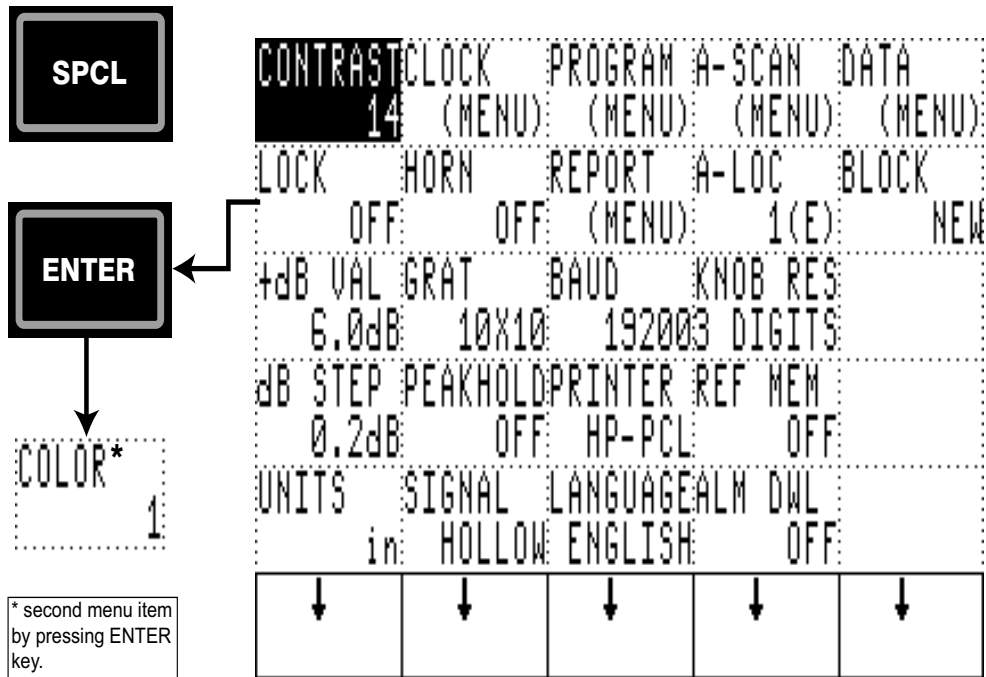

SPCL key provides parameters and features not associated with normal inspection operations. These include menus for front-panel lockout, date, program, A-Scan storage, and communications. Select SPCL menu parameters by pressing the appropriate column arrow soft key until the desired parameter box is highlighted. Use the SmartKnob, arrow keys, or ENTER key to activate or adjust a parameter. The sub-menus are described in the following sections.

CONTRAST Adjusts the contrast for the Monochrome LCD display. If the ambient temperature causes the LCD to become invisible, this adjustment can be reached on power up by simply pressing the SPCL key.

LOCK Enables or disables instrument front panel lock feature. When lock feature is enabled, all controls, except gain/lock, are disabled. Pressing ENTER invokes COLOR function if COLOR display exists.

COLOR Pressing ENTER while LOCK is highlighted brings up the COLOR palette option, if a color LCD module is detected, COLOR options are 1 to 8. Pressing ENTER again returns to the LOCK function.

+dB VALUE Establishes the amount of gain applied by the +dB feature. The selections include +6 dB, +12 dB, +18 dB, and +24 dB.

dB STEP Establishes step size used by SmartKnob™ and arrow keys to adjust gain value. Selections are 0.2, 1.0, 2.0, 6.0, and 12.0 dB.

UNITS Selects various operating units. Selections: inches (in), millimeters (mm) or microseconds (μs).

CLOCK System clock menu for setting the instrument time and date.

HORN Enables or disables the audible alarm horn.

GRATICULE Sets graticule to OFF, 5x5 graticule, 10x10 graticule, or JIS 10x10 graticule.

PEAKHOLD Performs a peak detect and hold function of the digitized wave forms. The peak amplitude of the digitized signal is displayed, held, and updated whenever a new higher peak amplitude is detected. The peak hold may be reset by pressing the ENTER key when this function is active.

SIGNAL Allows selection between a hollow or filled A-Scan display.

PROGRAM Program storage and retrieval sub-menu.

REPORT Report form editor sub-menu.

BAUD Used to set the baud rate for the RS-232 serial port selections. If the printer does not appear to work properly, or the instrument is connected to a host PC and is responding incorrectly, check to make sure this selection matches your application. For the optional printer available for use with this instrument, the default setting is 9600 baud.

PRINTER Used to select one of the printers supported by the Sonic® 1200S/HR. The printer selection includes Epson, HP-PCL, Canon, and Pentax II. Each of these selections may be used with a wide range of printers. To use a specific printer, your selection must support or emulate one of the printer selection modes and be configured accordingly. Some printers support several printer modes, so experimentation may be required to determine which mode provides the best printout.

LANGUAGE Sets language used for text. Selections include English, Spanish, French, German, Italian, Romanian.

A-SCAN A-Scan storage and retrieval sub-menu.

A-LOC Selects the next storage location for an A-Scan.

KNOB RES Knob Resolution allows selecting between 3-digit display or 4-digit display.

REF MEM The Reference Memory function allows the operator to save a waveform through normal A-Scan save in the Main menu, recall it as “REF MEM”, then compare the “REF MEM” with a live echo pattern. When recalled, the saved “REF MEM” waveform is displayed as a dotted line.

DATA Thickness data logger sub-menu.

BLOCK Selects the measurement block number.

T-STORE Selects the next storage location for a thickness reading.

VALUE Displays a stored value or empty status for the current block/location selection.

CLEAR Clears the contents of the selected LOCATION. Note that this operation is irreversible.

ALM DWL Alarm dwell is accessed through the Special Menu. Selections for alarm dwell are OFF, 0.2, 0.4, ..., 10.0 seconds and LATCH. If LATCH is chosen, the alarm is activated whenever an alarm condition is met and keeps alarming. To deactivate the latched alarm, press the SPCL key when the alarm condition no longer exists.

4.21 Program Sub-Menu

1. NAME OF PROGRAM		02/11/2003	
2.	(EMPTY)		
3.	(EMPTY)		
4.	(EMPTY)		
5.	(EMPTY)		
6.	(EMPTY)		
7.	(EMPTY)		
8.	(EMPTY)		
9.	(EMPTY)		
10.	(EMPTY)		
11.	(EMPTY)		
12.	(EMPTY)		
13.	(EMPTY)		
14.	(EMPTY)		
15.	(EMPTY)		
16.	(EMPTY)		

MENU: PROGRAM				
PROGRAM	STORE /	ERASE	NAME	PRINT
1(F)	RECALL			

The Sonic[®] 1200S/HR is capable of storing and retrieving 100 complete instrument programs. These setups are recorded with date and time, and may be named using up to 29 alphanumeric characters. Functions pertaining to program storage are store, recall, erase, name, and print.

PROGRAM This line displays the program storage location which is to be stored, recalled, erased, named, or printed. Turning the SmartKnob™ will cycle through the 100 program storage locations and highlight the current selection. The locations are displayed in pages of 16. Along with its storage location, the program's empty status or name and time stamp will be displayed.

STORE/RECALL Instrument settings are stored to or recalled from the selected program location. If the selected location is full, this control allows the operator to recall the stored program. If the location is empty, the operator is permitted to store the program. Whenever a program setting is recalled, the currently active instrument settings are overwritten and cannot be recovered unless these settings were previously stored in another program location.

ERASE The erase function allows the operator to erase the selected program location. This is normally done before saving a new program to that location. If it is desired to erase all program settings, the program location must be set to the ALL state. Operator confirmation ENTER is required to complete the erase operation. Note that this operation is irreversible.

NAME The name function allows the operator to enter a name of up to 29 characters for a stored program. Names may be used to describe the test settings that are stored, reference a

4.23 Clock Sub-Menu

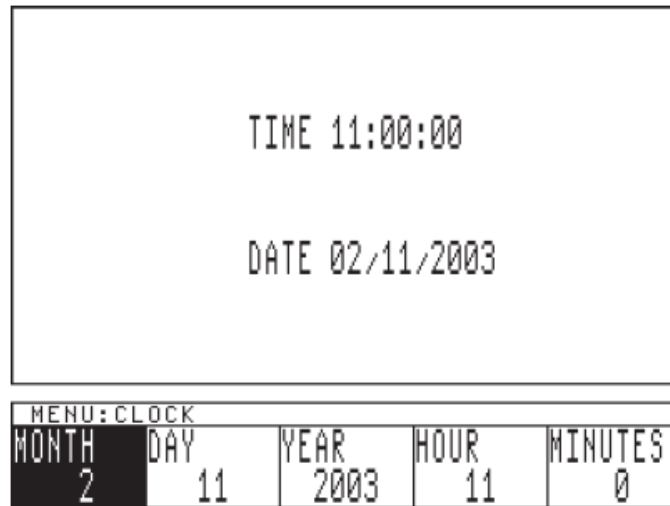

The Clock sub-menu is used to observe and modify the system clock parameters. The system date is expressed in DD MM YYYY format, while the system time is expressed in HH:MM format.

MONTH Sets the system clock month (i.e., 1 = January, 2 = February, etc.).

DAY Sets the system clock to the day of the month (days 1 through 31).

YEAR Sets the last 4 digits of the system clock year (1996 through 2095).

HOUR Sets the system clock to the hour (0 through 23).

MINUTES Sets the system clock to minutes (0 through 59).

4.24 A-Scan Sub-Menu

1. NAME OF A-SCAN		02/11/2003	
2.	(EMPTY)		
3.	(EMPTY)		
4.	(EMPTY)		
5.	(EMPTY)		
6.	(EMPTY)		
7.	(EMPTY)		
8.	(EMPTY)		
9.	(EMPTY)		
10.	(EMPTY)		
11.	(EMPTY)		
12.	(EMPTY)		
13.	(EMPTY)		
14.	(EMPTY)		
15.	(EMPTY)		
16.	(EMPTY)		

MENU: A-SCAN				
A-SCAN	RECALL	ERASE	NAME	PRINT
1(F)				

The Sonic[®] 1200S/HR is capable of storing and retrieving 100 complete A-Scans. These A-Scans are recorded with date and time, and may be named using up to 29 alphanumeric characters. A-Scans are stored in the MAIN menu using the A-LOC feature. Functions pertaining to stored A-Scans are recall, erase, name, and print.

A-SCAN This parameter displays the A-Scan memory location which is to be stored, recalled, erased, named, or printed. Turning the SmartKnob[™] will cycle through the 100 A-scan storage locations and highlight the current selection. Along with the displayed A-Scan storage location will be its empty status or name and time stamp.

RECALL A-Scan images may be recalled from the selected A-Scan location to the instrument screen for review. Only full A-Scan locations may be recalled. To resume normal instrument operation, press any key.

ERASE The erase A-Scan function allows the operator to erase the selected A-Scan location. This is normally done before saving a new A-Scan to that location. To erase all A-Scans, the A-Scan location must be set to the ALL state. Operator confirmation ENTER is required to complete the erase operation. Note that this operation is irreversible.

NAME The name function allows the operator to enter a name of up to 29 characters for a stored A-Scan. Names may be used to describe the test settings that are stored, reference a written test procedure, and so on. Only A-Scans that are full may be named.

PRINT The A-Scan print function uses the optional external serial printer option to make a hard copy of the stored A-Scan, program settings, and a custom report form.

ATTRIB Attribute appears only when A scan location is ALL. Press ENTER to access the A scan Attribute sub menu. when this soft key is highlighted.

4.25 A-Scan Attribute Sub Menu

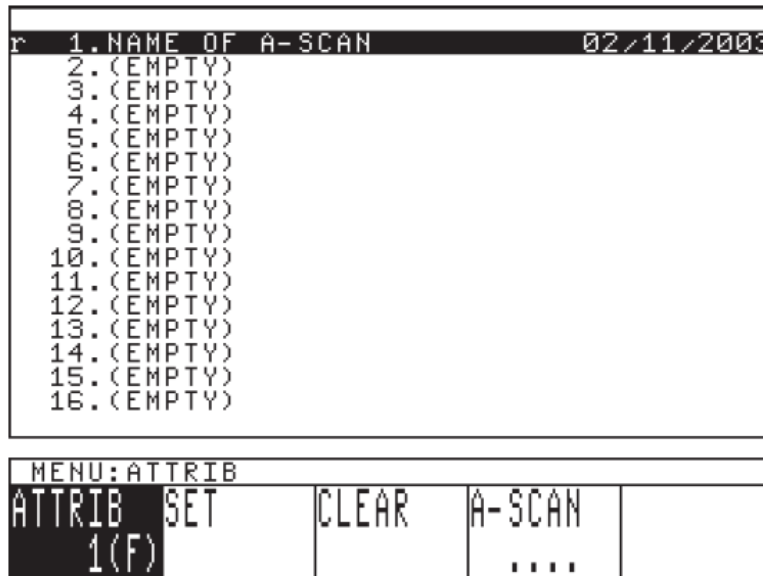

The first character in the table above indicates the *attribute* of the A-Scan location.

- [r]read-only
- [e]extension of previous location

Setting the attribute of A-Scan locations protects these locations from accidentally being erased. SET sets the attribute of the stored A-Scan, and CLEAR clears the attribute.

ATTRIB This parameter displays the A-Scan memory location on which the attribute is to be changed. Rotating the SmartKnob™ will cycle through the 100 A-Scan locations.

SET The SET function is used to set the attribute of the highlighted A-Scan location. The A-Scan can NOT be erased if the attribute is set.

CLEAR The CLEAR function is for clearing the attribute of the highlighted A-Scan location. The attribute must be cleared before attempting to erase the location in the A-Scan Sub-Menu.

A-SCAN Pressing this softkey or ENTER while it is highlighted returns unit to A-SCAN sub-menu.

4.26 Data Sub Menu

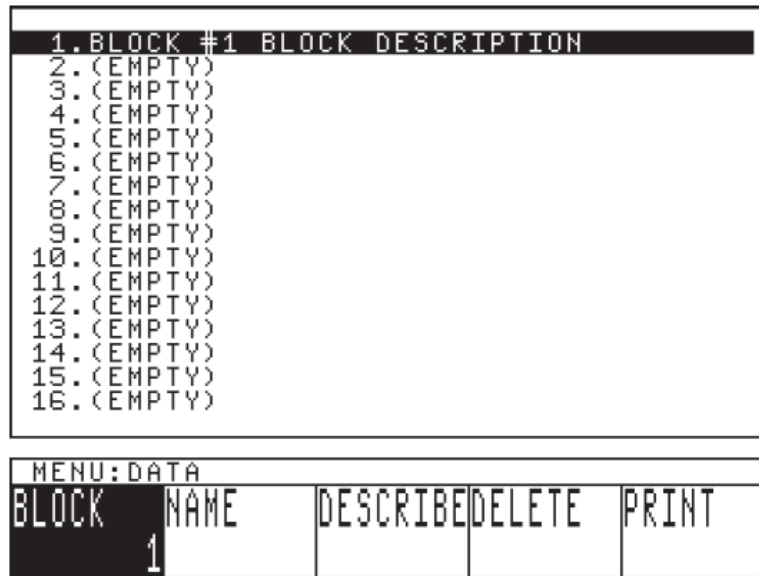

The screenshot shows a terminal-style interface. The top section is a list of 16 items, each consisting of a number followed by a description. Item 1 is highlighted with a black background. The list is as follows:

- 1. BLOCK #1 BLOCK DESCRIPTION
- 2. (EMPTY)
- 3. (EMPTY)
- 4. (EMPTY)
- 5. (EMPTY)
- 6. (EMPTY)
- 7. (EMPTY)
- 8. (EMPTY)
- 9. (EMPTY)
- 10. (EMPTY)
- 11. (EMPTY)
- 12. (EMPTY)
- 13. (EMPTY)
- 14. (EMPTY)
- 15. (EMPTY)
- 16. (EMPTY)

Below the list is a table with the following structure:

MENU: DATA				
BLOCK	NAME	DESCRIBE	DELETE	PRINT
1				

The data logger menu offers block creation, editing, and review features. Having selected a block number, the operator performs an operation by pressing ENTER or the appropriate soft key.

BLOCK Selects the block number to be REVIEWed, NAMED, DESCRIBEd, DELETED, or PRINTed. All blocks will be listed by name in the top part of the display. Setting the BLOCK number to less than 1 will allow the ALL selection to be used by the DELETE and PRINT features. Setting the block number to one greater than the last block number will allow the NEW selection to create a new data block. To create a new data block or review an existing block, press the ENTER key.

NAME The name function allows the operator to enter a name of up to 8 characters for data block.

DESCRIBE The describe function allows the operator to enter an alphanumeric block description of up to 26 characters.

DELETE Allows the operator to delete the selected block number. If it is desired to delete all data blocks, the block location must be set to the ALL state. Operator confirmation ENTER is required to complete the delete operation. Note that this operation is irreversible.

PRINT The block print function uses the optional external serial printer option to make a hard copy report of data contained in the selected block.

4.27 New Block Editor

```
BLOCK: 2
NAME: BLOCK #2
DESCRIBE: BLOCK 2 DESCRIPTION
ROWS: 1      COLS: 1
DIR: ROW
UNITS: in
```

MENU: BLOCK				
ROWS	COLS	DIR	NAME	DESCRIBE
1		1	ROW	

The new block editor is used to establish the storage requirements for a newly created data block. The operator must specify the number of rows and columns, as well as the storage direction. If a sequential configuration is desired, simply set either the rows or columns value to 1. This menu also offers the operator an opportunity to define the block's name and description.

ROWS Sets the number of grid rows for this data block. The number of rows is adjustable in the range of 1 to 5000, but may be limited by the number of columns or available reading locations.

COLUMNS Sets the number of grid columns in this data block. The number of columns is adjustable in the range of 1 to 5000, but may be limited by the number of rows or available reading locations.

DIR Sets the load direction for data storage. The selection (ROW or COLUMN) determines which index will advance after each store operation.

NAME The name function allows the operator to enter a name of up to 8 characters for the new data block.

DESCRIBE The describe function allows the operator to enter an alphanumeric block description of up to 26 characters.

4.28 Block Review Sub Menu

NAME: BLOCK #2				DIR: ROW	
ROWS: 1		COLS: 1			
DESCRIBE: BLOCK 2 DESCRIPTION					
LOCATION					
1					
ROW		COLUMN		VALUE	
1		1		*	

MENU: BLOCK				
T-LOC	ROW	COLUMN	T-MIN	CLEAR
1	1	1	0.000in	

The block review sub-menu is used to review the contents of stored data blocks. The screen contains the block definition items (name, rows, cols, ...) and a page of stored thickness readings. The readings are listed sequentially (in the order they were stored), but may be accessed sequentially by row or by column.

LOCATION Selects the block reading location. The location number will change either the row or column values, or both. Conversely, changes to the row and column values will affect

the location number. Setting the LOCATION number to less than 1 will allow the ALL selection for use by the CLEAR feature.

ROW Changes the row selection, which in turn changes the location value.

COLUMN Changes the column selection, which in turn changes the location value.

T-MIN Establishes the minimum allowable thickness reading permitted by this block. All readings that are less than this value are marked with an asterisk.

CLEAR Clears the reading(s) from the selected location(s). Operator confirmation ENTER is required to complete the clear operation. This operation will leave the selected location empty. Note that this operation is irreversible.

4.29 Text Editor



The text editor presents a screen similar to the figure shown above, displaying a list of available characters and a highlighted entry line with a pointer used to indicate the current character location.

The right and left arrow keys are used to move the current character space. Rotating the SmartKnob moves the highlight from character to character. Pressing ENTER selects the character and moves the pointer from one location to the right.

Right and Left Arrow Keys This line moves edit cursor left and right 1 character position (respectively). When the cursor exceeds either end of the string, its position wraps around to the other end.

CLEAR Clears the entire text line and places the edit cursor at the first character.

QUIT Terminates the text editor and aborts any changes made to the text string.

SAVE Saves the text string and exits the text editor.

4.30 Instrument Reset

The instrument operating parameters are reset to the default settings if the RANGE key is depressed when the instrument is turned on. The instrument will prompt “Press RANGE key for default reset” during the initialization routine. Stored programs, thicknesses, and A-Scans are not affected by the reset operation. The default parameters are listed in the following charts.

Pulser		Receiver		Range	
PULSE	100ns	GAIN ^{0.2}	30dB	RANGE	1.00in
DAMPING	200	DISPLAY	FULLWAV	DELAY	0.000in
MODE	Single Freq	FREQ	5MHz	VEL	0.2310in/μs
PULSER	150v	REJECT	0%	UNITS	in
Gate 1		Gate 2		Thickness	
GATE 1	Off	GATE 2	Off	T-GAUGE	Off
LEVEL	40%	LEVEL	50%	TRIGGER	Edge
POSN	0.500in	POSN	0.500in	OFFSET	0.000μs
WIDTH	0.250in	WIDTH	0.250in	T-VEL	0.2310in/μs
Angle		Special			
TRIG	Off	CONTRAST	14	GRATICULE	5 x 5
ANGLE	0.0°	LOCK	Off	PEAK-HOLD	Off
THICK	1.00in	+dB VALUE	+6dB	SIGNAL	Hollow
O-DIAM	Off	dB STEP	0.2dB	BAUD RATE	9600
---	---	UNITS	IN	PRINTER	HP-PCL
---	---	HORN	Off	LANGUAGE	English

5. Applications

What's in this section?

- 5.1 Pulse-Echo Contact Thickness Testing
- 5.2 Dual Transducer Thickness Testing
- 5.3 Delay Line Thickness Testing
- 5.4 Shear Wave (Angle Beam) Testing
- 5.5 Distance Amplitude Correction (DAC) Testing

5.1 Pulse-Echo Contact Thickness Testing

One of the major methods of ultrasonic thickness testing is the pulse-echo contact method. It provides excellent accuracy and is best suited for smooth surfaces. The test range is usually 0.10 inch to 20.0 inches. A wideband transducer is normally used. The thickness gauge offsets and sound velocity must be recalibrated each time the instrument is powered up.

The following accessories are required for this setup procedure:

STEP BLOCK — Sonic® #1920105.00 Steel Step Block or equivalent 0.100, 0.200, 0.300, 0.400, and 0.500 inch steps.

TRANSDUCER — The transducer used will depend on the material and thickness being tested. For steel or aluminum up to 5 inches thick, a *Spectrum E8L* (5 MHz) transducer is a good selection. For rough, corroded, or highly attenuative materials, a 2.25 MHz transducer (*Spectrum™ E4L*) may be required. Larger and lower frequency transducers may give better results on rough materials (that is, cast iron).

TRANSDUCER CABLE — Use a Sonic® BNC/Microdot (#9102894) or BNC/BNC (#9102892) to connect the specific transducer.

COUPLANT — Use a couplant that “fills in” the surface. On smooth surfaces, thinner couplants can be used such as water, light oil, or mineral oil. On rough surfaces, Sonic® X30S couplant (#3317450) is more appropriate.

5.1.1 Instrument Calibration - 0.5” Thickness Range, Steel

1. Connect the transducer cable to the Spectrum™ E8L transducer, and then to either BNC connector.
2. Turn on instrument power and adjust the operating controls as follows:



To select and change the following parameters, press the *menu soft key* below the selected menu box, then rotate the SmartKnob™ or press the INC/DEC arrow keys to change the value.

KEY	CONTROL	SETTING
Press RANGE menu key	Range	0.500 in.
	Delay	0.030 in
	Vel	0.2310 in./μs
	Gain	35.0 dB
Press RCVR menu key	Display	FULWAV
	Freq	5 MHz
	Reject	0%
Press PULSER menu key	Damping	50
	Mode	Single

3. Place X30S couplant on the step block and position the transducer on the thinnest (0.100) step.

4. Press the RCVR menu key, then the DISPLAY *menu soft key*, and rotate the SmartKnob™ to select HALF-. Observe the signals and select “+” or “-” depending upon best signal display.
5. Adjust Delay by pressing the RANGE menu key, then the DELAY *menu soft key*, and rotate the SmartKnob™ to line up the leading edge of the first echo on the #2 graticule line.
6. Adjust Gain by pressing the RANGE menu key, then GAIN *menu soft key*, and rotate the SmartKnob™ to increase the first echo amplitude to approximately 80% of full screen height (refer to **Figure 5-1**).
7. Move the transducer to the thickest (0.500) step. Adjust the Velocity by pressing the RANGE menu key, the VEL *menu soft key*, and rotate the SmartKnob™ to line up the leading edge of the first echo on the last graticule line (refer to **Figure 5-2**).
8. Repeat steps 3 - 8 to verify that both the 0.100 and 0.500 inch signals line up.
9. Check the 0.200, 0.300 and 0.400 inch steps. If they line up, the Sonic® 1200S/HR is calibrated. If they do not line up closely, repeat calibration steps 4 - 8.
10. The instrument should now be calibrated for 0.500 inches of steel across the full screen width. Each major graticule division corresponds to 0.050 inches of steel. For other ranges and materials, the Sonic® 1200S/HR is calibrated similarly. Use step blocks made of the same test material and thickness range as the material being measured.

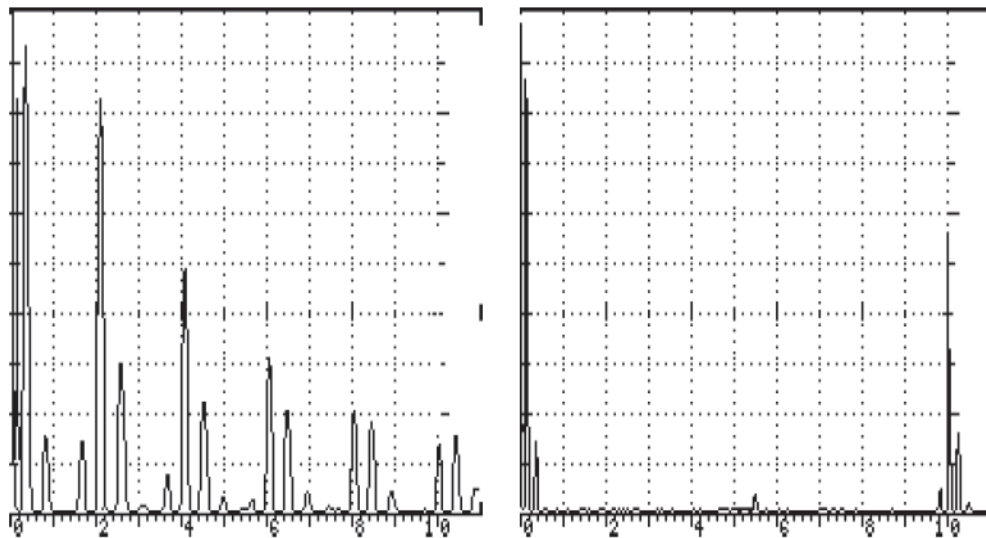

Figure 5-1: Multiple Echoes From 0.100 Step and Figure 5-2: Echo From 0.500 Step Block

5.1.2 Instrument Calibration - 1 to 10" of Aluminum

Use the same procedure as the previous 0.5 inch steel test, but adjust the controls using 1-to-10 inch aluminum step blocks as the thin and thick steps. After calibrating at 1.0 inch and 10.0 inches, check at 5.0 inches for accuracy.

To select and change the following parameters, press the *menu soft key* below the selected menu box, then rotate the SmartKnob™ or press the INC/DEC arrow keys to change the value.

KEY	CONTROL	SETTING
Press RANGE menu key	Range	10.0 inches
	Delay	0.030 inch
	Vel	0.2500 inch/ μ s
	Gain	50.0 dB
Press RCVR menu key	Display	FULWAV
	Freq	5 MHz
	Reject	0%
Press PULSER menu key	Damping	50
	Mode	Single

The Sonic® 1200S/HR is now calibrated for 10 inches of aluminum at full screen range with each major graticule division equal to 1 inch.

Different materials have different velocity attenuation and noise characteristics. The best accuracy is obtained by using step blocks made from the same material as that being tested.

With practice, you may optimize the displayed ultrasonic signals by using the Gain, Damping, Display, Frequency, and Reject control settings. The Reject setting can be used to improve the display by eliminating small baseline signals (or noise).

An operator must recalibrate the thickness gauge when changing from IP mode to 1st back wall reflection mode and to Multiple Echo mode to compensate for transducer offsets, surface

variations, and couplant thickness. In the Multiple Echo mode, the ultrasonic echoes being measured only include material thickness. Compensation for these offsets in the Multiple Echo mode is not required.

5.1.3 Alternate Calibration Test Method - Multiple Echo, 1.0 to 10.0” of Steel

Notice that several multiple echo signals can be observed during the thickness calibration and testing. These echoes can be used to calibrate over a wider range than when using the first echo technique. This method is especially useful if there is only one known thickness available.

For example, using only a 1 inch steel block (B1 Block), calibration of 1 to 10 inches or more can be performed. In highly attenuative materials, (that is, cast materials), it may not be possible to obtain multiple echoes over the desired thickness range, limiting this technique.

The same accessories (transducer, cable, couplant) are used except a block of only one known thickness is required, such as a B1 Block with a 1 inch thickness.

1. Connect the transducer by cable to either instrument BNC.
2. Turn on instrument power and adjust the operating controls as follows:

To select and change the following parameters, press the *menu soft key* below the selected menu box, then rotate the SmartKnob™ or press the INC/DEC arrow keys to change the value.

KEY	CONTROL	SETTING
Press RANGE menu key	Range	10.0 inches
	Delay	0.030 inch
	Vel	0.2310 inch/μs
	Gain	50.0 dB
Press RCVR menu key	Display	FULWAV
	Freq	5 MHz
	Reject	0%
Press PULSER menu key	Damping	50
	Mode	Single

3. Place the transducer (with couplant) on the 1.0 inch thickness portion of the test block and press the RANGE menu key.
4. Press DELAY *menu soft key* and rotate SmartKnob™ to line up the 1st echo on #1 graticule line.
5. Press VEL *menu soft key* and rotate SmartKnob™ to line up the 5th echo with #5 graticule line.
6. Repeat steps 3 - 5 until both echoes line up. All 10 echoes should then line up with a graticule line, as shown in **Figure 5-3**. If they do, the instrument is calibrated for 1.0 to 10.0 inches. If not, repeat calibration.

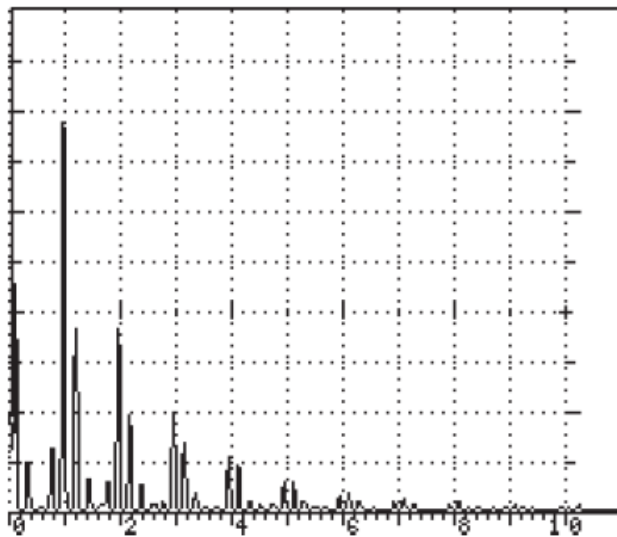

Figure 5-3: Multiple Echoes From 1.0 Block

5.1.4 Digital Thickness Calibration for Contact Transducers

Adjust the operating controls as follows:



To select and change the following parameters, press the *menu soft key* below the selected menu box, then rotate the SmartKnob™ or press the INC/DEC arrow keys to change the value. These settings are approximate and may vary due to the different types of transducers used.

KEY	CONTROL	SETTING
Press RANGE menu key	Range	1.0 inch
	Delay	0.030 inch
	Vel	0.2310 inch/ μ s
	Gain	35.0 dB
Press RCVR menu key	Display	FULWAV
	Freq	5MHz
	Reject	0%
Press PULSER menu key	Damping	50 Ω
	Mode	Single

1. Place couplant on the step block and position the transducer on the thinnest (0.100) step.
2. Press RCVR menu key, then DISPLAY *menu soft key*, and rotate the SmartKnob™ to select HALF-. Observe the signals and select "+" or "-" depending upon best signal display.
3. Adjust Delay by pressing the RANGE menu key, then DELAY *menu soft key*, and rotate the SmartKnob™ to line up the leading edge of the first echo on the No. 1 graticule line.
4. Adjust Gain by pressing the GAIN *menu soft key*, and rotate the SmartKnob™ to increase the first echo amplitude to approximately 80% of full screen height (see **Figure 5-4**).
5. Move the transducer to the thickest (0.500) step and press the RANGE menu key, then select the VEL *menu soft key*, and rotate the SmartKnob™ to line up the leading edge of the first echo on the #5 graticule line (see **Figure 5-5**).
6. Repeat steps 1 - 5 to verify that both the 0.100 and 0.500 inch signals line up.
7. The instrument should now be calibrated for 1.0 inch of steel across the full screen width. Each major graticule division corresponds to 0.100 inch of steel.

- Check the 0.200, 0.300 and 0.400 inch steps. If they line up, the Sonic® 1200S/HR is calibrated. If not, repeat calibration steps 1 - 5.

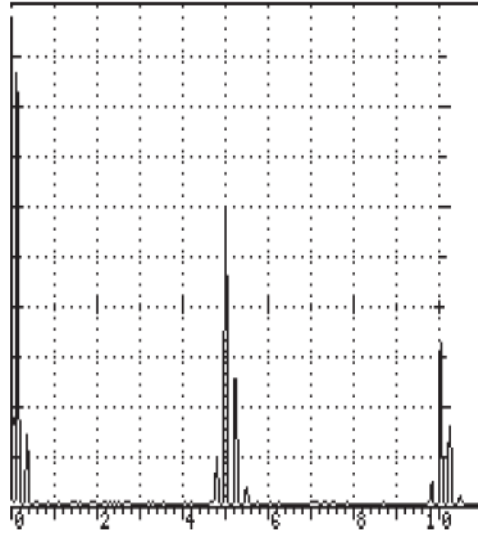
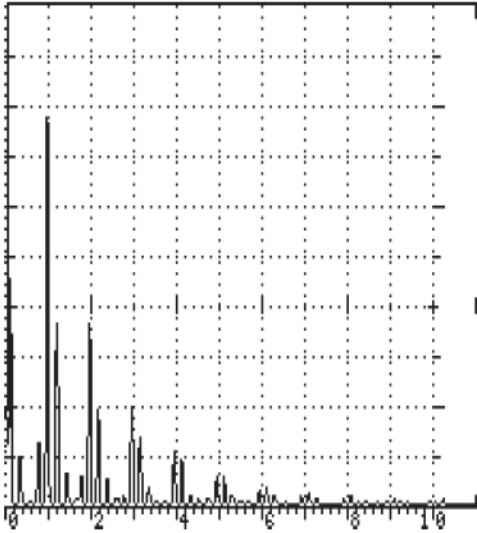

Figure 5-4: Echo From 0.100 Step and Figure 5-5: Echo From 0.500 Step

5.1.5 Digital Thickness Measurement From the Initial Pulse to the 1st Back Wall Reflection

Press the GATE1 menu key and the following menu will appear. This menu provides changeable parameters, such as Polarity, Position, Width, and Level, for either flaw or thickness measurements of Gate1.



MENU:GATE 1				
GAIN ^{0.2}	GATE 1	POSN	WIDTH	LEVEL
30.0dB	OFF	1.00in	1.00in	49%

For thickness measurements, adjust the controls as follows:

- To enable Gate1, press GATE1 menu key again and rotate the SmartKnob™ to select the “+” Gate1 alarm.
- Press the Gate LEVEL *menu soft key* and rotate the SmartKnob™ to the desired screen height, such as 40%.

3. Press the Gate POSN *menu soft key* and rotate the SmartKnob™, or press the POSN *menu soft key* repeatedly, to adjust the Gate position so that the start of the gate is to the left of the thinnest (0.100 inch) step (see **Figure 5-6**).
4. Press the Gate WIDTH *menu soft key* and rotate the SmartKnob™, or press the WIDTH *menu soft key* repeatedly, to adjust the Gate width to full screen or to the right of the thickest step (0.500 inch).

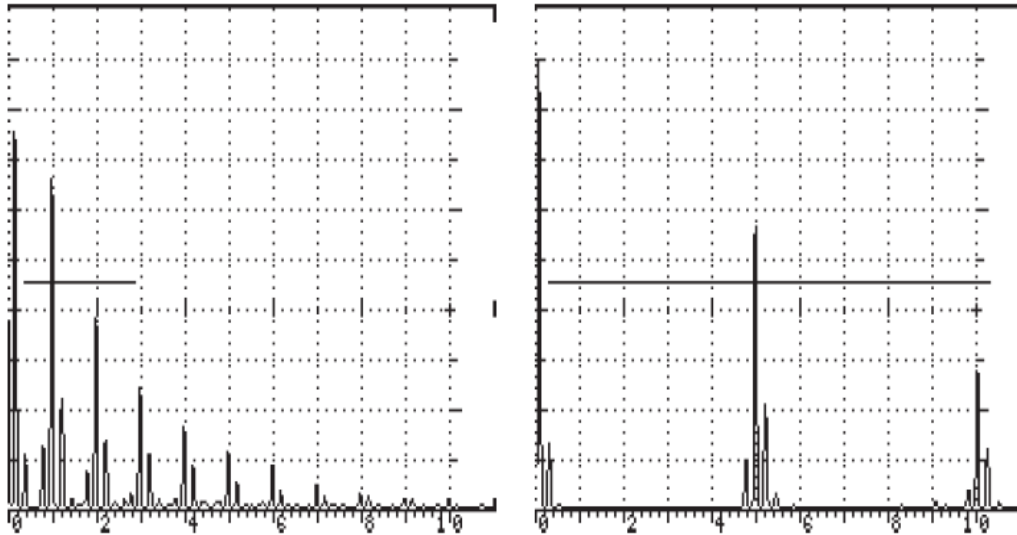

Figure 5-6: Echo From 0.100 Step and Figure 5-7: Echo From 0.500 Step

5. Press the THICK menu key, then the T-GAUGE softkey, and the following menu will display.

MENU: THICK				
GAIN ^{0.2}	T-GAUGE	TRIGGER	OFFSET	T-VEL $\frac{\text{in}}{\mu\text{s}}$
30.0dB	OFF	EDGE	0.000us	0.2310

6. Use the SmartKnob™ to toggle through the selections. Select AIP - 1st. Press the TRIGGER softkey and rotate the SmartKnob™ to toggle between peak or leading edge triggering for thickness measurements. Select EDGE.
7. Place the transducer on the thickest step (0.500 inch of steel), press the THK CAL softkey, and rotate the SmartKnob™ until the THK CAL value for CAL PT1 reads 0.500 inch. Press the ENTER key to log this value.

8. Place the transducer on the thinnest step (0.100), press the THK CAL softkey and rotate the SmartKnob™ until the THK CAL value for CAL PT2 reads 0.100 inch. Press the ENTER key to log this value.
9. Calibration is now done. Check the 0.200, 0.300, and 0.400 inch steps. If the thickness readings are correct, the thickness gauge is calibrated. If the thickness gauge is not calibrated, repeat calibration steps 5 through 8.

5.2 Dual Transducer Thickness Testing

Dual (pitch/catch) transducers produce better results for measuring thin (0.030 inch) materials or rough and corroded metals in the 0.050 inch to 5.00 inch range. They can also be used on smooth materials to more than 10 inches.

The following accessories are required for this setup procedure:

STEP BLOCK — Sonic® #1920105.00 steel step block or equal (0.100 to 0.500 inch).

TRANSDUCER — Harisonic® J4MD (¼ in. 5 MHz).

COUPLANT — Use a couplant that “fills in” the surface. On smooth surfaces, use thinner couplants (water, light oil, or mineral oil). On rough surfaces, the Sonic® X30S couplant (P/N #3317450) is more appropriate.

5.2.1 Instrument Calibration - 0.100 to 0.500 Inches Steel

1. Connect the two transducer leads into both BNC connectors.
2. Turn instrument power on.
3. Set the Sonic® 1200S/HR for Dual mode by pressing the PULSER menu key and then selecting the *MODE menu soft key*.
4. Adjust the operating controls as follows:

To select and change the following parameters, press the *menu soft key* below the selected

menu box, then rotate the SmartKnob™ or press the INC/DEC arrow keys to change the value.

KEY	CONTROL	SETTING
Press RANGE menu key	Range	0.500 inch
	Delay	0.400 inch
	Vel	0.2310 inch/μs
	Gain	55.0 dB
Press RCVR menu key	Display	FULWAV
	Freq	5 MHz
	Reject	0%
Press PULSER menu key	Damping	200Ω
	Mode	Dual

5. Place X30S couplant on the step block and position the transducer on the thinnest (0.100) step.
6. Press the RCVR menu key, then the DISPLAY *menu soft key*, and rotate the SmartKnob™ to select HALF-. Observe the signals and select “+” or “-” depending upon which signal displays the largest amplitude of the first cycle (see **Figure 5-8**).
7. Adjust Delay by pressing the RANGE menu key, then the DELAY *menu soft key*, and rotate the SmartKnob™ to line up the leading edge of the first echo on the #2 graticule line.
8. Adjust Gain by pressing the GAIN *menu soft key*, and rotate the SmartKnob™ to increase the first echo amplitude to approximately 70% of full screen height (refer to **Figure 5-8**).
9. Move the transducer to the thickest (0.500 inch) step. Adjust the Velocity by pressing the RANGE menu key, the VEL *menu soft key*, and rotate the SmartKnob™ to line up the leading edge of the first echo on the last graticule line (refer to **Figure 5-9**).
10. Repeat steps 7 - 9 to verify that both the 0.100 and 0.500 inch signals line up.
11. Check the 0.200, 0.300, and 0.400 inch steps. If they line up, the Sonic® 1200S/HR is calibrated. If they do not line up closely, repeat calibration steps 5 through 9.

12. The Sonic[®] 1200S/HR is now calibrated for steel from 0.100 inch to 0.500 inch. This method provides an accurate test over this range.

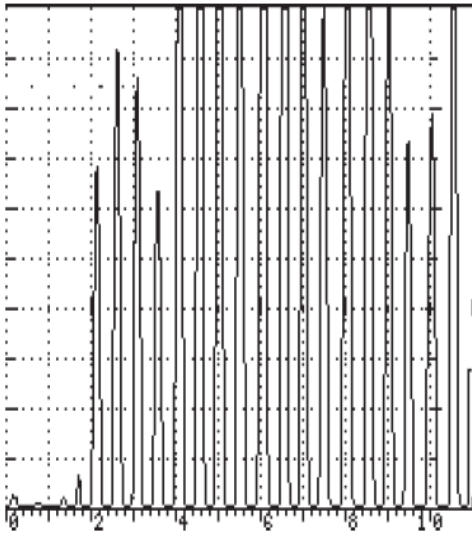

Figure 5-8. Pitch-Catch Echo from a 0.100 Step Block

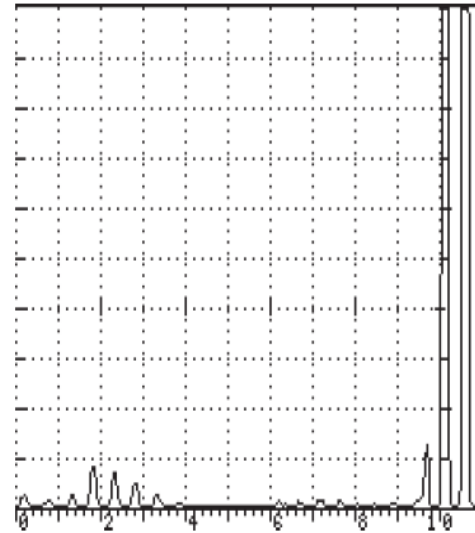

Figure 5-9. Pitch-Catch Echo from a 0.500 Step Block

5.2.2 Instrument Calibration - 1.0 to 10.0 Inches of Steel

Use the same procedure as the previous 0.100 to 0.500 inch steel test, but adjust the controls using 1 to 10 inch steel step blocks as the thin and thick steps. After calibrating at 1.0 inch and 10.0 inches, check at 5.0 inches for accuracy.

To select and change the following parameters, press the *menu soft key* below the selected menu box, then rotate the SmartKnob[™] or press the INC/DEC arrow keys to change the value.

KEY	CONTROL	SETTING
Press RANGE menu key	Range	10.0 inches
	Delay	0.400 inch
	Vel	0.2310 inch/ μ s
	Gain	55.0 dB
Press RCVR menu key	Display	FULWAV
	Freq	5 MHz
	Reject	0%
Press PULSER menu key	Damping	200
	Mode	Dual

The Sonic[®] 1200S/HR is now calibrated for 10 inches of steel at full screen range with each major graticule division equal to 1 inch.

Different materials will have different velocity, attenuation, and noise characteristics. The best accuracy will be obtained by using step blocks made from the same material as that being tested.

With practice, you may optimize the displayed ultrasonic signals by using the Gain, Damping, Display, Frequency, and Reject control settings. The Reject setting can be used to improve the display by eliminating small baseline signals (or noise).

5.2.3 Alternate Calibration Method - Multiple Echo, 1" - 10" Steel

The multiple echo calibration method can be used with the dual transducer. This method is especially useful if there is only one known thickness available.

For example, using only a 1 inch steel block (B1 Block), calibration of 1 to 10 inches or more

can be performed. In highly attenuative materials (for example, cast materials), it may not be possible to obtain multiple echoes over the desired thickness range, thus limiting this technique.

The same accessories (transducer, cable, couplant) are used, except a block of only one known thickness is required, such as a B1 block with 1 inch thickness.

1. Connect the two transducer leads into both BNC connectors.
2. Turn on instrument power and adjust the operating controls as follows:

To select and change the following parameters, press the *menu soft key* below the selected menu box, then rotate the SmartKnob™ or press the INC/DEC arrow keys to change the value.

KEY	CONTROL	SETTING
Press RANGE menu key	Range	10.0 inches
	Delay	0.400 inch
	Vel	0.2310 inch/μs
	Gain	55.0 dB
Press RCVR menu key	Display	FULWAV
	Freq	5 MHz
	Reject	0%
Press PULSER menu key	Damping	200
	Mode	Dual

3. Place the transducer (with couplant) on the 1.0 inch thickness portion of the test block and press the RANGE menu key.
4. Press DELAY *menu soft key* and rotate the SmartKnob™ to line up the 1st echo on the #1 graticule line.
5. Press VEL *menu soft key* and rotate the SmartKnob™ to line up the 5th echo with the #5 graticule line.

6. Repeat steps 4 and 5 until both echoes line up. All 10 echoes should then line up with a graticule line. If they do, the instrument is calibrated for 1.0 to 10.0 inches. If not, repeat calibration.
7. After calibration, you are ready to start testing for flaws. If the calibration block surfaces are similar to the test material, you can proceed. If the surface (inner or outer) is rougher or curved, you will need to adjust the Gain to acquire signals back up to about 70%. Rough outer surfaces will also cause echoes after the initial pulse which restricts the resolution of thin surfaces. Always make sure that the display signals are clear and “make sense” before proceeding with the test.

5.2.4 Dual Element High/Low Digital Thickness Calibration

Adjust the operating controls as follows:

To select and change the following parameters, press the *menu soft key* below the selected menu box, then rotate the SmartKnob™ or press the INC/DEC arrow keys to change the value.

KEY	CONTROL	SETTING
Press RANGE menu key	Range	0.500 inch
	Delay	0.400 inch
	Vel	0.2310 inch/μs
	Gain	55.0 dB
Press RCVR menu key	Display	FULWAV
	Freq	5MHz
	Reject	0%
Press PULSER menu key	Damping	200Ω
	Mode	Dual

5.2.5 Thickness Measurement from Initial Pulse to 1st Back Wall Reflection

Press the GATE1 menu key and the following menu will appear. This menu provides changeable parameters, such as Polarity, Position, Width, and Level, for either flaw or thickness measurements of Gate1.

MENU:GATE 1					↔↔
GAIN ^{0.2}	GATE 1	POSN	WIDTH	LEVEL	
30.0dB	OFF	1.00in	1.00in	49%	

For thickness measurements, adjust the controls as follows:

1. To enable Gate1, press GATE1 menu key again and rotate the SmartKnob™ to select the “+” Gate1 alarm.
2. Press the Gate LEVEL *menu soft key* and rotate the SmartKnob™ to the desired screen height, such as 40%.
3. Press the Gate POSN *menu soft key* and rotate the SmartKnob™, or press the POSN *menu soft key* repeatedly, so that the start of the gate is to the left of the thinnest step (0.100 inch). (Please refer to **Figure 5-10**).

- Press the Gate WIDTH *menu soft key*, and rotate the SmartKnob™, or press the WIDTH *menu soft key* repeatedly, to adjust the Gate width to full screen or to the right of the thickest step (0.500 inch). (Please refer to **Figure 5-11**).

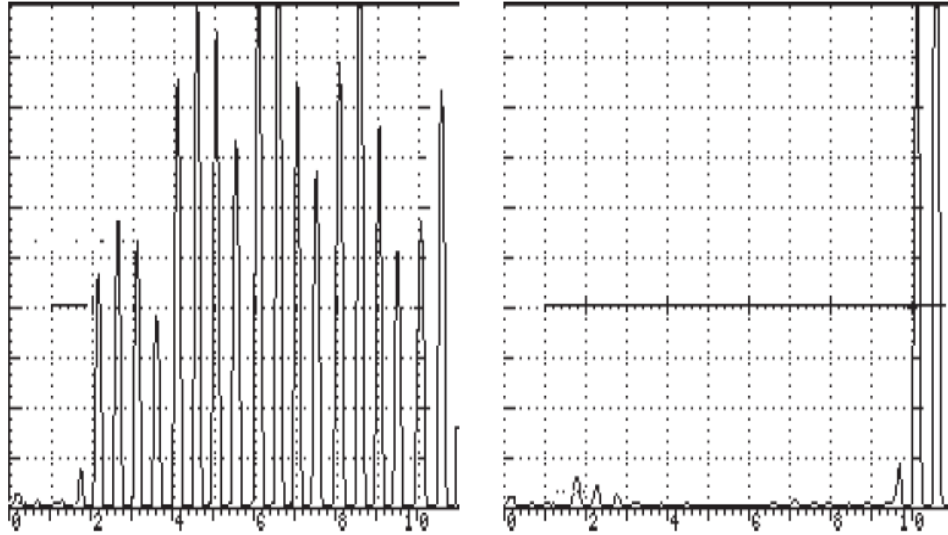

- Press the THICK menu key and the following menu will display. Press the T-GAUGE *menu soft key*, and use the UP/DOWN arrow keys to toggle through the selections. Select A IP - 1st.



- Press the TRIGGER softkey and rotate the SmartKnob™ to toggle between peak or leading edge triggering for thickness measurements. Select EDGE.
- Place the transducer on the thickest step (0.500 inch of steel), press the THK CAL softkey, and rotate the SmartKnob™ until the THK CAL value for CAL PT1 reads 0.500 inch. Press the ENTER key to log this value.
- Place the transducer on the thinnest step (0.100), press the THK CAL softkey and rotate the SmartKnob™ until the THK CAL value for CAL PT2 reads 0.100 inch. Press the ENTER key to log this value.
- Calibration is now done. Check the 0.200, 0.300, and 0.400 inch steps. If the thickness readings are correct, the thickness gauge is calibrated. If the thickness gauge is not calibrated, repeat calibration steps 5 through 8.

5.2.6 Thickness Using Multiple Echoes From the 1st Back Wall to 2nd Back Wall Reflection, Echo-to-Echo

Adjust the operating controls as follows:

KEY	CONTROL	SETTING
Press RANGE menu key	Range	1.00 inch
	Delay	0.500 inch
	Vel	0.2310 inch/ μ s
	Gain	55.0 dB
Press RCVR menu key	Display	FULLWAV
	Freq	5MHz
	Reject	0%
Press PULSER menu key	Damping	200
	Mode	Dual

To measure between echoes, both Gate 1 and Gate 2 are used for thickness measurements. Gate 1 position (start) must be to the left of the thinnest step (echo) for thickness measurements. The width must be wide enough to cover the area where the 1st back wall echo will appear (see *Figure 5-12*).

Gate 2 position (start) must be to the right of the 1st back wall echo and to the left of the thinnest 2nd back wall echo for accurate thickness measurements. The width of Gate 2 must be

wide enough to cover the area where the 2nd back wall echo will appear (see *Figure 5-13*).

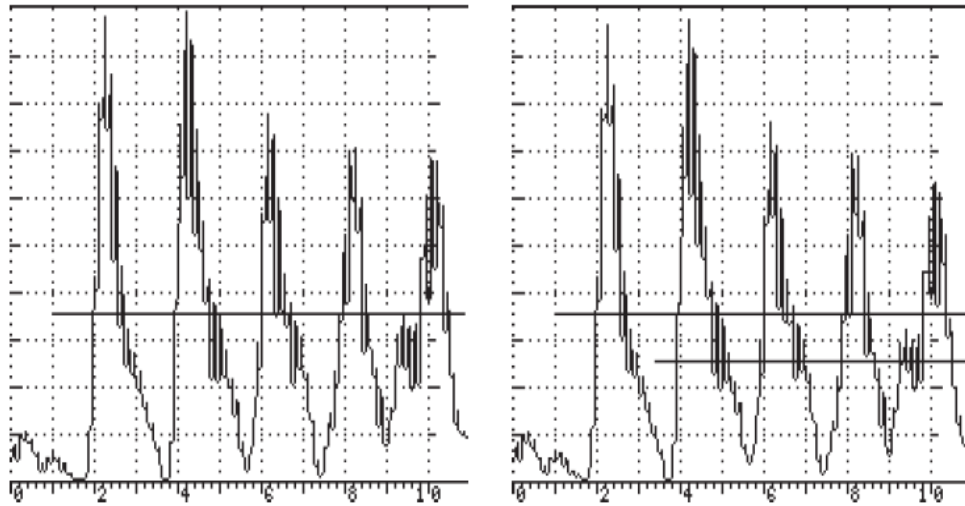

Figures 5-12 and 5-13

Press GATE1 menu key and the following menu will appear. This menu provides changeable parameters, such as Polarity, Position, Width, and Level, for either flaw or thickness measurements of Gate1.

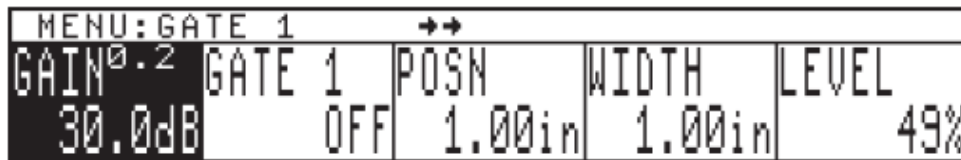

For thickness measurements, adjust the controls as follows.

1. To enable Gate1, press GATE1 menu key again and rotate the SmartKnob™ to select the “+” Gate1 alarm.
2. Press the Gate LEVEL menu soft key and rotate the SmartKnob™ to the desired screen height, such as 35%.
3. Press the Gate POSN menu soft key and rotate the SmartKnob™, or press the POSN menu soft key repeatedly, so that the start of the gate is to the left of the thinnest step (0.200 inch). (Please refer to *Figure 5-14*).
4. Press the Gate WIDTH menu soft key and rotate the SmartKnob™, or press the WIDTH menu soft key repeatedly, to adjust the Gate width until it goes past or through the 1st echo from the thinnest step (see *Figure 5-15*).

The Gate width must extend past the thickest step in the calibration procedure.

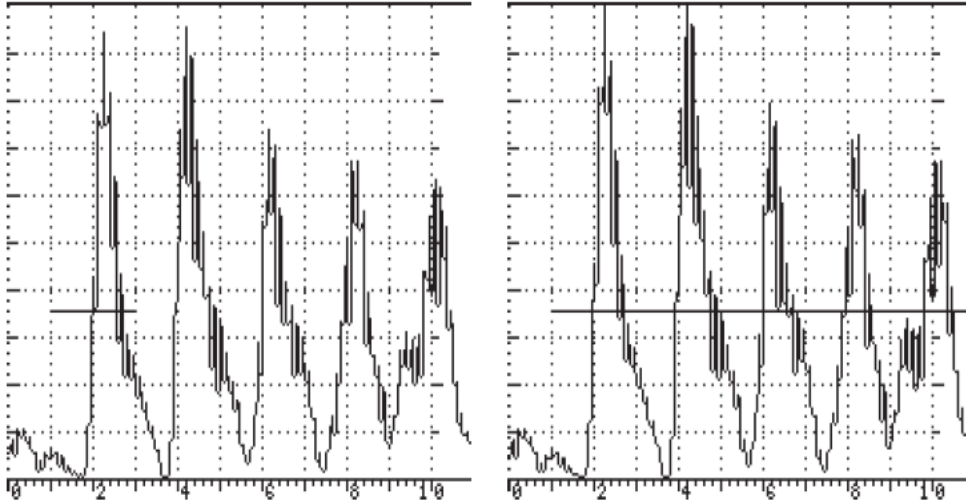

Figures 14 and 15

Press the GATE2 menu key and the following menu will appear. This menu provides changeable parameters, such as Polarity, Position, Width, and Level, for either flaw or thickness measurements of Gate2.

MENU:GATE 2				
GAIN ^{0.2}	GATE 2	POSN	WIDTH	LEVEL
30.0dB	OFF	1.00in	1.00in	30%

For this application, Gate2 is used for thickness.

1. To enable Gate2, press the GATE2 menu key again and rotate the SmartKnob™ to select the “+” Gate2 alarm.
2. Press the Gate LEVEL *menu soft key* and rotate the SmartKnob™ to the desired screen height, such as 25%.
3. Press the Gate POSN *menu soft key* and rotate the SmartKnob™, or press the POSN *menu soft key* repeatedly, so that the start of the gate is to the left of the 2nd back wall echo, or just to the right side of the 1st back reflection (see **Figure 5-16**).

- Press the Gate WIDTH *menu soft key* and rotate the SmartKnob™, or press the WIDTH *menu soft key* repeatedly, to adjust the Gate width to go past or through the 2nd back wall echo (see **Figure 5-17**).

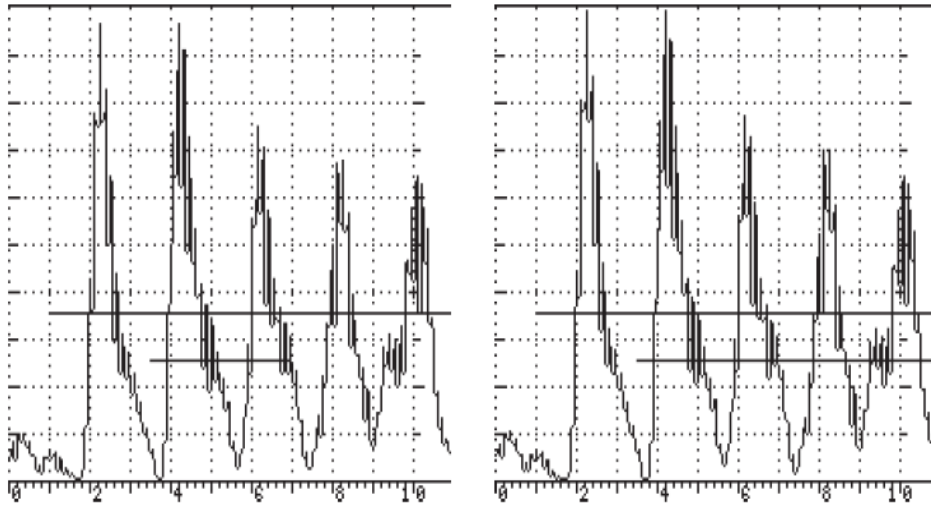

Figure 16 and 17

- For echo-to-echo measurements on thinner material than 0.500 inch, the Gate 2 position (start) and width must be adjusted for the thinnest echo-to-echo measurement, such as 0.200 inch (see **Figure 5-18**).
- Gate 2 must start prior to the 2nd back wall echo (left side of echo) and the width must be wide enough so the 2nd back wall echo passes through it (see **Figure 5-18**).
- Press the THICK menu key and the following menu will display. Press the T-GAUGE *menu soft key*, and use the UP/DOWN arrow keys to toggle through the selections. Select Auto Echo - Echo.

MENU: THICK				
GAIN ^{0.2}	T-GAUGE	TRIGGER	OFFSET	T-VEL $\frac{\text{in}}{\mu\text{s}}$
30.0dB	OFF	EDGE	0.000us	0.2310



Gate 1 must start prior to the 1st echo (left side of echo) and the width must be wide enough so the 1st back wall echo passes through it.

8. Place the transducer on the thinnest step (0.200 inch). Verify proper Gate1 and Gate2 positioning, as above (the thickness gauge starts the measurement with the 1st echo to break Gate1, and stops the measurement with the 1st echo to break Gate2). Press the THK CAL softkey, and rotate the SmartKnob until the THK CAL value for CAL PT1 reads 0.200 inch. Press ENTER to log this value (Please refer to *Figure 5-19*).
9. Place the transducer on the thickest step (0.500 inch of steel). Verify proper Gate1 and Gate2 positioning, as above (a slight adjustment of the Gate2 position may be required to prevent triggering on unwanted signals), press the THK CAL softkey, and rotate the SmartKnob until the THK CAL value for CAL PT2 reads 0.500 inch. Press ENTER to log this value. (Please refer to *Figure 5-20*).
10. Calibration is now done. Check other thickness values to verify; if the thickness readings are correct, the thickness gauge is calibrated. If the thickness gauge is not calibrated, repeat calibration steps 5 through 14 (velocity of the material under test).

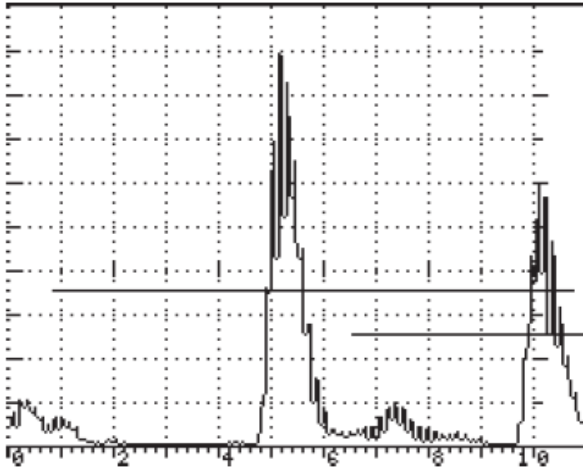

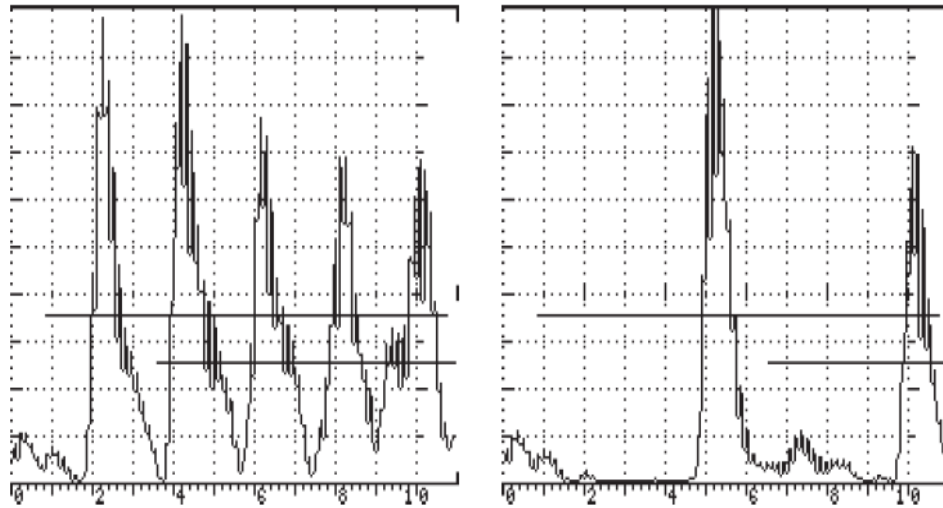

Figures 19 and 20

5.2.7 Manual Echo-to-Echo Mode Calibration

To calibrate the gage using Manual Echo-to-Echo mode, follow instructions for AUTO Echo-to-Echo calibration (see above) and instead of calibrating thickness using PT1 and PT2, do as follows:

1. From the THICK Menu, set VELOCITY according to nominal material velocity.
2. Place the transducer on the thin block and adjust OFFSET for the block value.
3. Place the transducer on the thick block and adjust the THICK VELOCITY for that value.
4. Repeat as necessary.

5.3 Delay Line Thickness Testing

In testing thin materials with smooth surfaces, the use of a wideband delay line transducer is a good method. The delay through the plastic enables better resolution. Thicknesses down to 0.010 inch can be resolved, since the delay moves the echoes away from the initial pulse ringing, as shown in *Figure 5-21*.

The range is limited by the delay in the plastic as the 2nd echo will interfere with the multiple

echoes. Usually the range is from 0.010 inch to 0.500 inch, but it can go up to 0.750 inch.

The measurement is made between the echoes (for best accuracy, the 1st and 2nd back echoes). The thickness gauge offsets, and sound velocity must be recalibrated, each time the instrument is powered up.

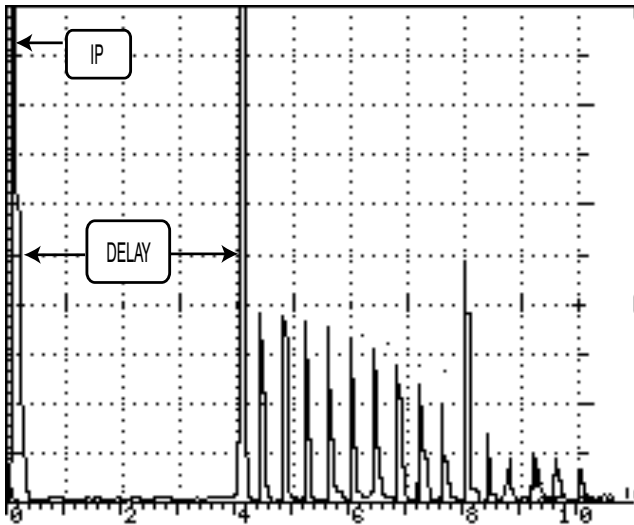

Figure 21: Delay Line Test Echoes

The following accessories are required for this procedure:

STEP BLOCK: Sonic® #1920105.00 Steel Step Block or equal (0.100, 0.200, 0.300, 0.400, 0.500 inch steps).

TRANSDUCER: A 10 MHz highly damped delay line transducer is usually the best choice, but a 5 MHz transducer may be used if the material is above 0.050 inch. Spectrum™ C17L is a good selection.

TRANSDUCER CABLE: Sonic® BNC/Microdot (#9102894).

COUPLANT: A thin couplant is preferred, such as Sonic® X30S couplant (#3317450), mineral oil, light oil, or possibly water.

5.3.1 Instrument Calibration - 0.500" Thickness Range, Steel

1. Connect the transducer cable to the Spectrum™ C17L transducer and to either BNC connector.
2. Turn on the instrument power, and adjust the operating controls as follows:

To select and change the following parameters, press the *menu soft key* below the selected menu box, then rotate the SmartKnob™ or press the INC/DEC arrow keys to change the value.

KEY	CONTROL	SETTING
Press RANGE menu key	Range	0.500 inch
	Delay	0.900 inch
	Vel	0.2310 inch/μs
	Gain	50.0 dB
Press RCVR menu key	Display	HALF + or HALF -
	Freq	10MHz
	Reject	0%
Press PULSER menu key	Damping	50Ω
	Mode	Single

3. Place couplant on the test block and position the transducer on the thinnest (0.100) step.
4. Press the RCVR menu key, then the DISPLAY *menu soft key*, and rotate the SmartKnob™ to select HALF-. Observe the signals and select “+” or “-” depending upon best signal display.
5. Adjust Delay by pressing the RANGE menu key, then the DELAY *menu soft key*, and rotate the SmartKnob™ to line up the leading edge of the first echo on the #2 graticule line.
6. Adjust Gain by pressing the RANGE menu key, then GAIN *menu soft key*, and rotate the SmartKnob™ to increase the first echo amplitude to approximately 70% of full screen height, #7 line vertical (refer to **Figure 5-22**).

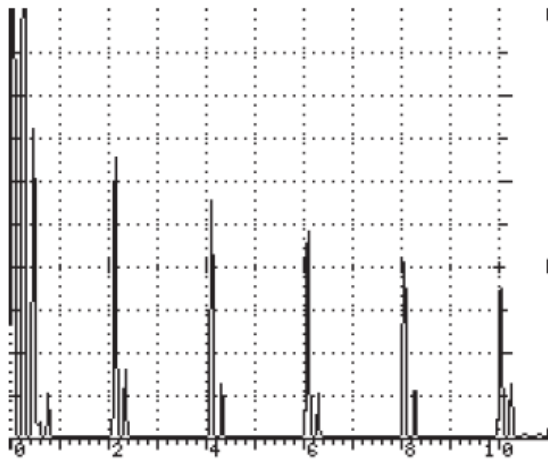

Figure 22: First Back Echo at 0.100"

7. Move the transducer to the thickest (0.500) step. Adjust the Velocity by pressing the RANGE menu key, the VEL *menu soft key*, and rotating the SmartKnob™ to line up the leading edge of the first echo on the last graticule line (refer to **Figure 5-23**).

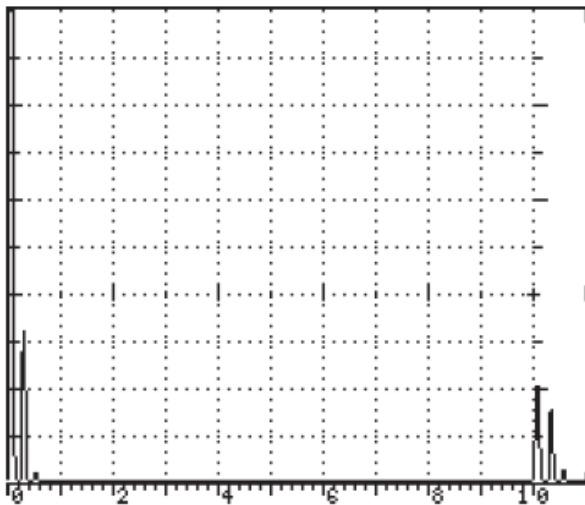

Figure 23: First Back Echo at 0.500"

8. Repeat steps 4 - 8 to verify that both the 0.100 and 0.500 inch signals line up.
9. Check the 0.200, 0.300 and 0.400 inch steps. If they line up, the Sonic® 1200S/HR is calibrated. If they do not line up closely, repeat calibration steps 4 - 8.

5.3.2 Instrument Calibration - Other Ranges

The instrument is calibrated similarly for other ranges and materials. Use step blocks made of the same test material and thickness range as the material being measured.

With practice, you may optimize the displayed ultrasonic signals by the use of Gain, Damping, Display, and Reject controls. Reject controls can be used to improve the display by eliminating small baseline signals or noise.

5.3.3 Instrument Calibration - Testing

When using the delay line method, the best results are obtained only when several multiples or echoes are displayed. In some attenuative materials or plastics, only one back echo may be obtained. In this case, the surface echo to 1st back echo signals can be used as a measurement, but accuracy will not be quite as good.

5.3.4 Thickness Measurements From Delay Line Interface to the 1st Back Wall Reflection

Press the GATE1 menu key and the following menu will appear. This menu provides changeable parameters, such as Polarity, Level, Position, and Width, for either flaw or thickness measurements of Gate1.

MENU: GATE 1					→→
GAIN ^{0.2}	GATE 1	POSN	WIDTH	LEVEL	
30.0dB	OFF	1.00in	1.00in	49%	

For thickness measurements, adjust the controls as follows.

1. To enable Gate1, press the GATE1 menu key again, and rotate the SmartKnob™ to select the “+” Gate1 alarm.
2. Press the Gate LEVEL *menu soft key* and rotate the SmartKnob™ to the desired screen height, such as 40%.

3. Press the Gate POSN *menu soft key* and rotate the SmartKnob™, or press the POSN *menu soft key* repeatedly, so that the start of the gate is to the left of the thinnest (0.100 inch) step (see **Figure 5-24**).
4. Press the Gate WIDTH *menu soft key* and rotate the SmartKnob™, or press the WIDTH *menu soft key* repeatedly, to adjust the Gate width to full screen or to the right of the thickest step (0.500 inch). (Please refer to **Figure 5-25**).

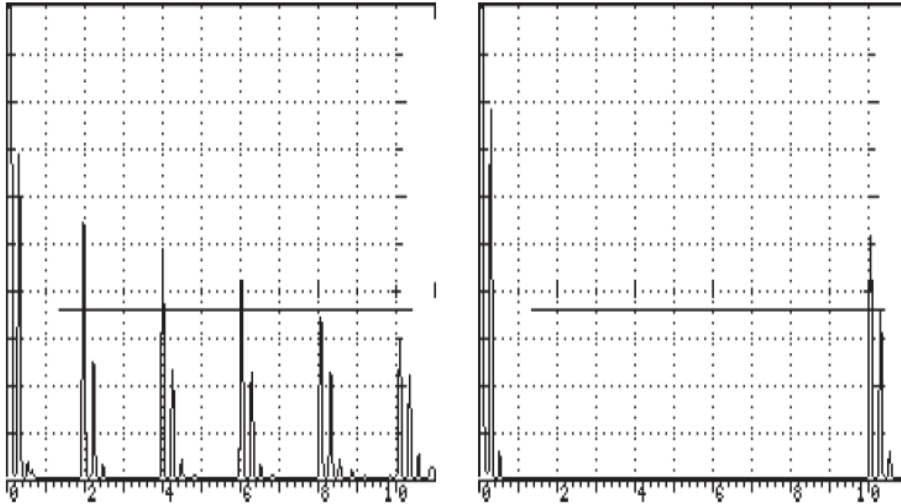

Figures 24 and 25

5. Press the THICK menu key and the following menu will display. Press the T-GAUGE *menu soft key*, and use the UP/DOWN arrow keys to toggle through the selections. Select A IP - 1st.

MENU: THICK				
GAIN ^{0.2}	T-GAUGE	TRIGGER	OFFSET	T-VEL $\frac{in}{us}$
30.0dB	OFF	EDGE	0.000us	0.2310

6. Press the TRIGGER softkey and rotate the SmartKnob™ to toggle between peak or leading edge triggering for thickness measurements. Select EDGE.
7. Place the transducer on the thickest step (0.500 inch of steel), press the THK CAL softkey, and rotate the SmartKnob™ until the THK CAL value for CAL PT1 reads 0.500 inch. Press the ENTER key to log this value.

8. Place the transducer on the thinnest step (0.100), press the THK CAL softkey and rotate the SmartKnob™ until the THK CAL value for CAL PT2 reads 0.100 inch. Press the ENTER key to log this value.
9. Calibration is now done. Check the 0.200, 0.300, and 0.400 inch steps. If the thickness readings are correct, the thickness gauge is calibrated. If the thickness gauge is not calibrated, repeat calibration steps 5 through 8.

5.3.5 Thickness Using Multiple Echoes From the 1st Back Wall to 2nd Back Wall Reflection, Echo-to-Echo

Adjust the operating controls as follows:

KEY	CONTROL	SETTING
Press RANGE menu key	Range	1.00 inch
	Delay	0.950 inch
	Vel	0.2310 inch/μs
	Gain	45.0 dB
Press RCVR menu key	Display	HALF -
	Freq	10MHz
	Reject	0%
Press PULSER menu key	Damping	50Ω
	Mode	Single

To measure between echoes, both Gate 1 and Gate 2 are used for thickness measurements. Gate 1 position (start) must be to the left of the thinnest step (echo) for thickness measurements. The width must be wide enough to cover the area where the 1st back wall echo will appear (see *Figure 5-26*).

Gate 2 position (start) must be to the right of the 1st back wall echo and to the left of the thinnest 2nd back wall echo for accurate thickness measurements. The width of Gate 2 must be wide enough to cover the area where the 2nd back wall echo will appear (see *Figure 5-27*)

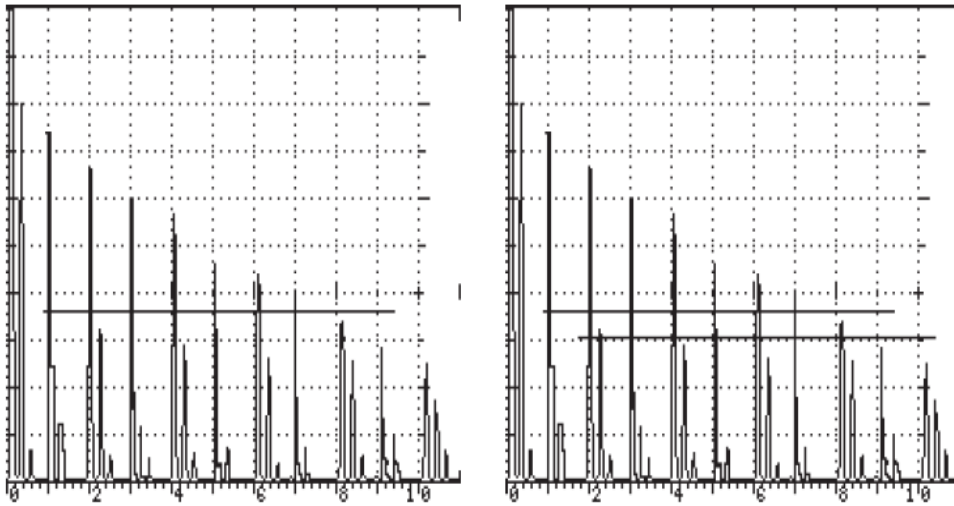

Figures 26 and 27

Press GATE1 menu key and the following menu will appear. This menu provides changeable parameters, such as Polarity, Position, Width, and Level, for either flaw or thickness measurements of Gate1.

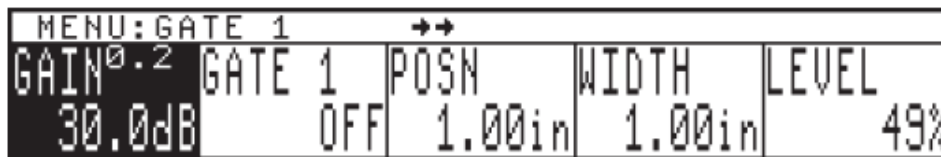

For thickness measurements, adjust the controls as follows.

1. To enable Gate1, press GATE1 menu key again, and rotate the SmartKnob™ to select the “+” Gate1 alarm.
2. Press the Gate LEVEL *menu soft key* and rotate the SmartKnob™ to the desired screen height, such as 40%.
3. Press the Gate POSN *menu soft key* and rotate the SmartKnob™, or press the POSN *menu soft key* repeatedly, so that the start of the gate is to the left of the thinnest step (0.100 inch). (Please see **Figure 5-28**).

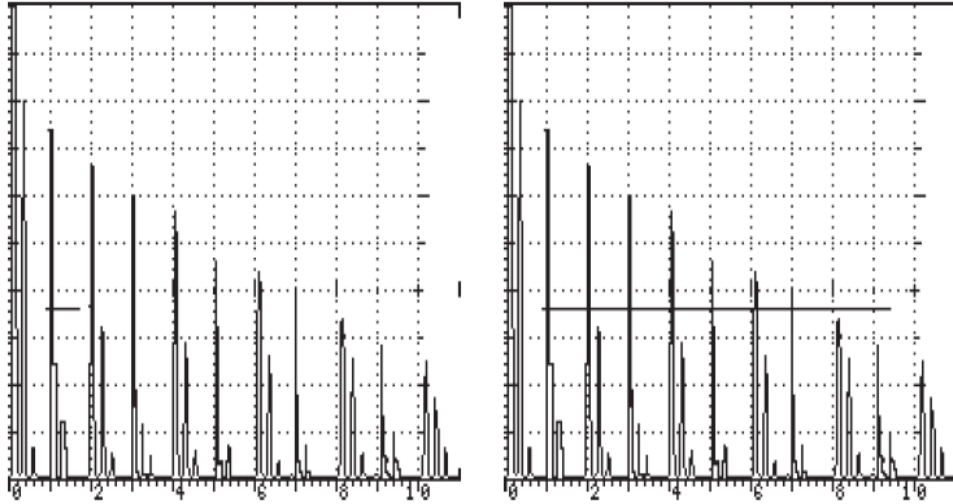

Figures 5-28 and 5-29

4. Press the Gate WIDTH *menu soft key* and rotate the SmartKnob™, or press the WIDTH *menu soft key* repeatedly, to adjust the Gate width until it goes past or through the 1st echo from the thinnest step (see **Figure 5-29**). The Gate width must extend past the thickest step in the calibration process.
5. Press the GATE2 menu key and the following menu will appear. This menu provides changeable parameters, such as Polarity, Position, Width, and Level, for either flaw or thickness measurements of Gate2.

MENU:GATE 2				
GAIN ^{0.2}	GATE 2	POSN	WIDTH	LEVEL
30.0dB	OFF	1.00in	1.00in	30%

For this application, Gate2 is used for thickness.

6. To enable Gate2, press the GATE2 menu key again and rotate the SmartKnob™ to select the “+” Gate2 alarm.
7. Press the Gate LEVEL *menu soft key* and rotate the SmartKnob™ to the desired screen height, such as 30%.

8. Press the Gate POSN menu soft key and rotate the SmartKnob™, or press the POSN *menu soft key* repeatedly, so that the start of the gate is to the left of the 2nd back wall echo, or just to the right side of the 1st back reflection (see **Figure 5-30**).
9. Press the Gate WIDTH *menu soft key* and rotate the SmartKnob™, or press the WIDTH *menu soft key* repeatedly, to adjust the Gate width to go past or through the 2nd back wall echo (see **Figure 5-31**).

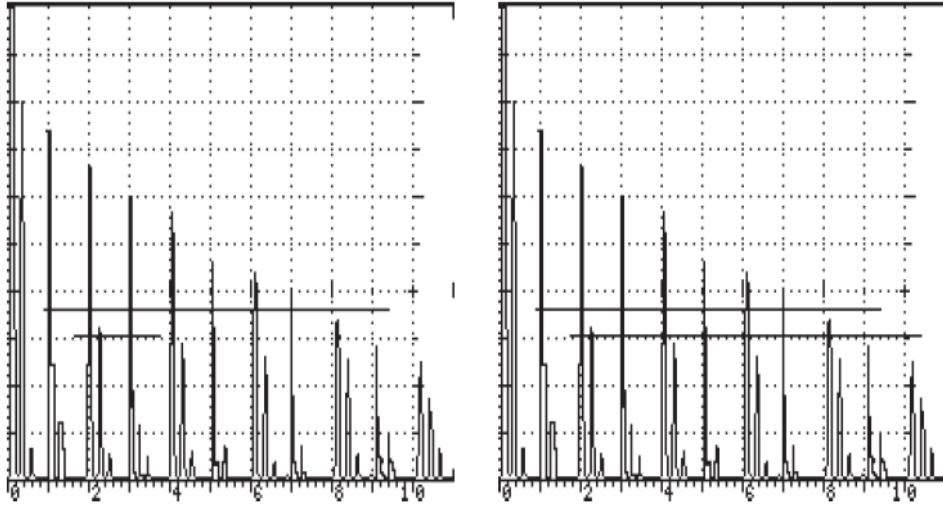

Figure 5-30 and 5-31

10. Press the THICK menu key and the following menu will display. Press the T-GAUGE *menu soft key*, and use the UP/DOWN arrow keys to toggle through the selections; select Auto Echo - Echo (AUTO E-E).



11. Place the transducer on the thinnest step (0.100 inch). Verify proper Gate1 and Gate2 positioning, as above (the thickness gauge starts the measurement with the 1st echo to break Gate1, and stops the measurement with the 1st echo to break Gate2). Press the THK CAL softkey, and rotate the SmartKnob until the THK CAL value for CAL PT1 reads 0.100 inch. Press ENTER to log this value (Please refer to **Figure 5-32**).

12. Place the transducer on the 0.400 inch step. Verify proper Gate1 and Gate2 positioning, as above (a slight adjustment of the Gate2 position may be required to prevent triggering on unwanted signals), press the THK CAL softkey, and rotate the SmartKnob until the THK CAL value for CAL PT2 reads 0.400 inch. Press ENTER to log this value. (Please refer to **Figure 5-33**).
13. Calibration is now done. Check other thickness values to verify; if the thickness readings are correct, the thickness gauge is calibrated. If the thickness gauge is not calibrated, repeat calibration steps 10 through 11.

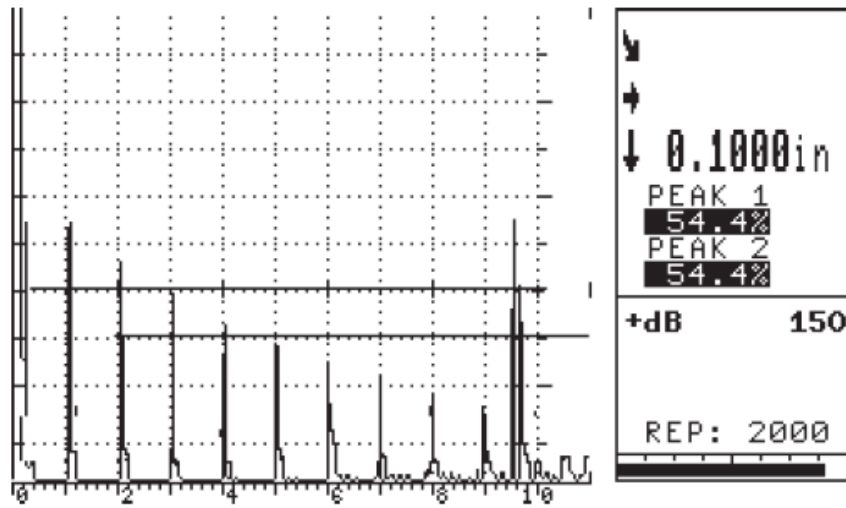

Figure 5-32

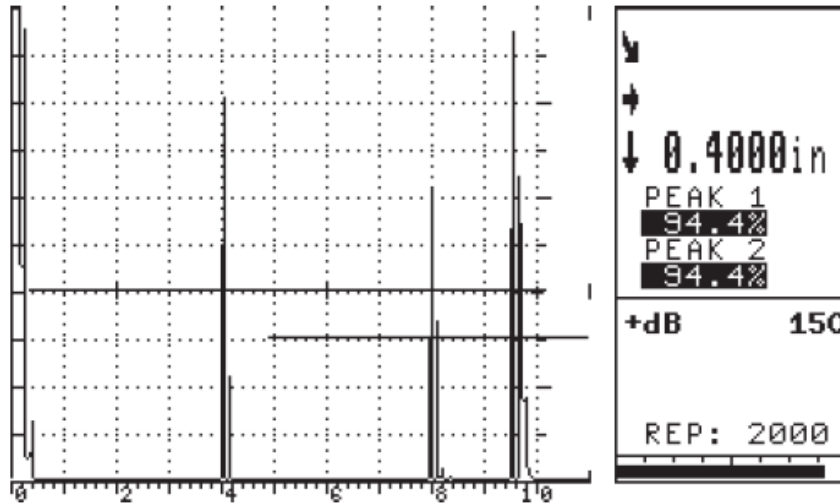

Figure 5-33

5.4 Shear Wave (Angle Beam) Testing

The primary method of testing welds is Angle Beam Shear Wave Ultrasonic Inspection. The angle beam allows testing at the proper angle to detect flaws in the weld zone. This is accomplished by using a Lucite wedge to convert the ultrasound into a shear wave at the proper angle. This angle is usually specified in AWS and ASME Standards to obtain the best results on a particular weld.

The following accessories are required for this setup procedure:

TRANSDUCER — A 2.25 MHz transducer with Lucite wedge is usually used, such as the Spectrum™ F2L, with a wedge at the desired angle. The transducer used will depend on the material, surface condition, and thickness.

TRANSDUCER CABLE — Use a Sonic® BNC/Microdot (P/N #9102894) to match the transducer.

COUPLANT — Use a couplant that “fills in” the surface. On smooth surfaces, use thinner couplants (water, light oil, or mineral oil). For rough surfaces, Sonic® X30S couplant (P/N #3317450) is more appropriate.

5.4.1 Instrument Calibration - 10" Thickness Range, Steel

1. Connect the transducer cable to the Spectrum™ F2L transducer and to either BNC connector.
2. Turn on instrument power and adjust the operating controls as follows:



To select and change the following parameters, press the *menu soft key* below the selected menu box, then rotate the SmartKnob™ or press the INC/DEC arrow keys to change the value.

KEY	CONTROL	SETTING
Press RANGE menu key	Range	10.0 inches
	Delay	0.600 inch
	Vel	0.1260 inch/μs
	Gain	65.0 dB
Press RCVR menu key	Display	FULLWAV
	Freq	2.25 MHz
	Reject	0%
Press PULSER menu key	Damping	200Ω
	Mode	Single

3. Place couplant on the top surface of the test block at the index point matching the wedge angle.
4. Place transducer on a calibration block at the index point. Refer to *Figure 5-34* and *Figure 5-35* for IIW Blocks and *Figure 5-36* for the B1 block positions.

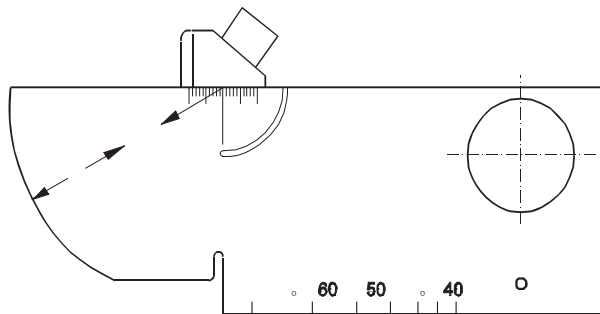

Figure 5-34: IIW Block Type 1

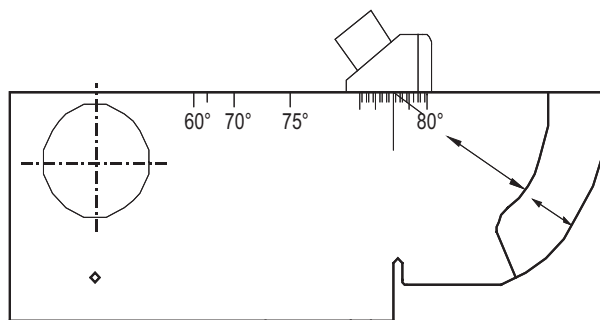

Figure 5-35: IIW Block Type 2

5. Swivel the transducer to peak the echoes.
6. Calibrate the EL/LCD display to the sound path by adjusting Delay. Adjust Delay by pressing the RANGE menu key, then the DELAY *menu soft key*, and rotate the SmartKnob™, or press the UP/DOWN arrow keys, so that the first echo lines up as follows for the three test blocks:

IIW Type 1 Block: Line 4 (4 inches). See first echo in *Figure 5-37*.

IIW Type 2 Block: Line 2 (2 inches). See first echo in *Figure 5-38*.

B1 Block: Line 1 (1 inch). See first echo in *Figure 5-39*.

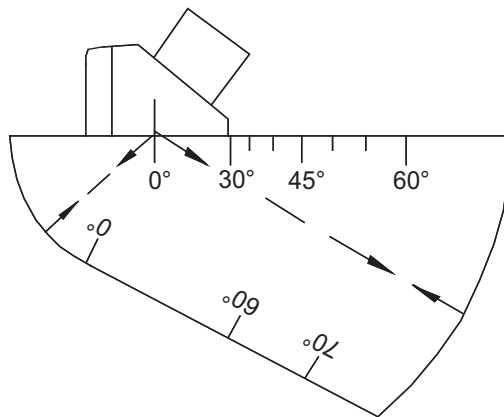

Figure 5-36: B1 Block

7. Adjust Velocity by pressing the RANGE menu key, then the VEL *menu soft key*, and rotate the SmartKnob™ to line up the second echo as follows:
 - IIW Type 1: Line 9 (9 inch). See second echo in **Figure 5-37**.
 - IIW Type 2: Line 4 (4 inch). See second echo in **Figure 5-38**.
 - B1: Line 4 (4 inch). See echo pattern in **Figure 5-39**.
8. Repeat steps 6 and 7 until both signals fall on the correct graticule lines. *Example:*
 - Test Block IIW Type 1 will have echoes positioned exactly at 4 inches and 9 inches.
 - Test Block IIW Type 2 echoes will be at 2 and 4 inches.
 - The B1 block will have echo signals at 1, 4, 7, and 10 inches.

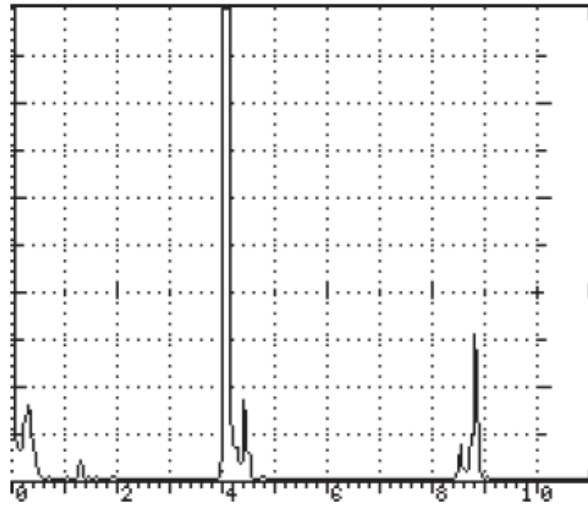

Figure 5-37: IIW Type 1 Block Echoes

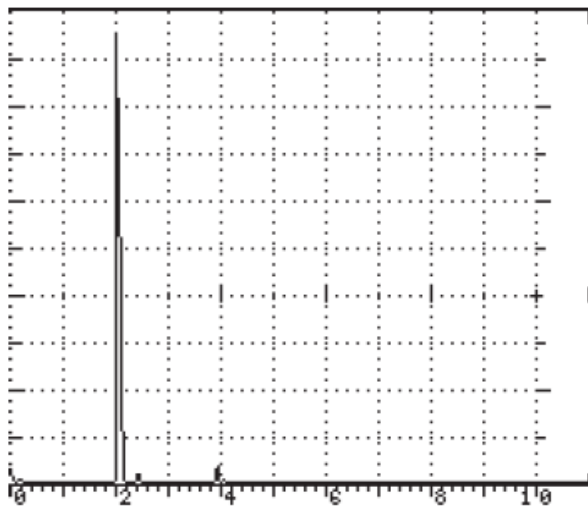

Figure 5-38: IIW Type 2 Block Echoes

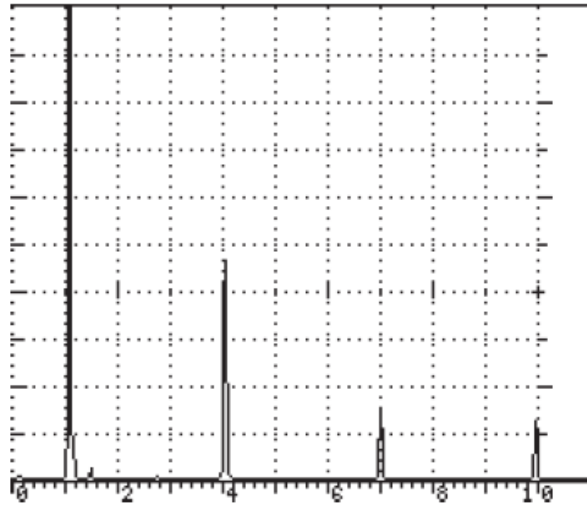

Figure 5-39: B1 Block Echoes

All figures represent a 10 inch screen range.

9. When the echoes are lined up at both points, the horizontal sweep is calibrated.

Measurement of the wedge angle by use of a IIW Test Block:

10. If the index point of the wedge is not known exactly, it is first necessary to determine it.

To find the true index point on the wedge:

11. Place the transducer with couplant on the block to reflect from the large 4 inch radius end (as shown in *Figure 5-40*).
12. Move the transducer to maximize the echo. The true index point will be directly at the center index mark. If this is different from the marking on the wedge, re-mark the index.
13. Now, check the wedge refraction angle by the following procedure: a) for IIW Block Types 1 and 2, and b) for the B1 Block.

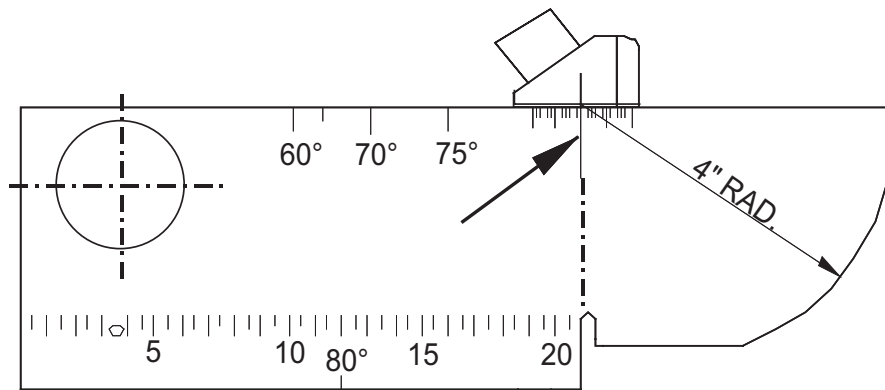

Figure 5-40: Leading Edge Index Point

a) Determination of the Angle of Refraction - The echo from the surface of the 2 inch (50 millimeter) diameter hole is used. The calibration markings engraved on both sides of the block make a direct determination of angles between 35° and 75° possible.

The exact angle of refraction can be read at the wedge index when the echo is at its maximum height. When measuring angles of refraction between 75° and 80°, the small hole (0.062 inch/1.6 millimeters) is used. Both transducer positions are shown in *Figure 5-41*. The wedge angle is always measured from the vertical.

- (1.) Move the transducer back and forth to maximize the reflection.

(2.) Read the angle from the true index mark to where it reads on the degree marks on the block. (Use the other side for above 60°).

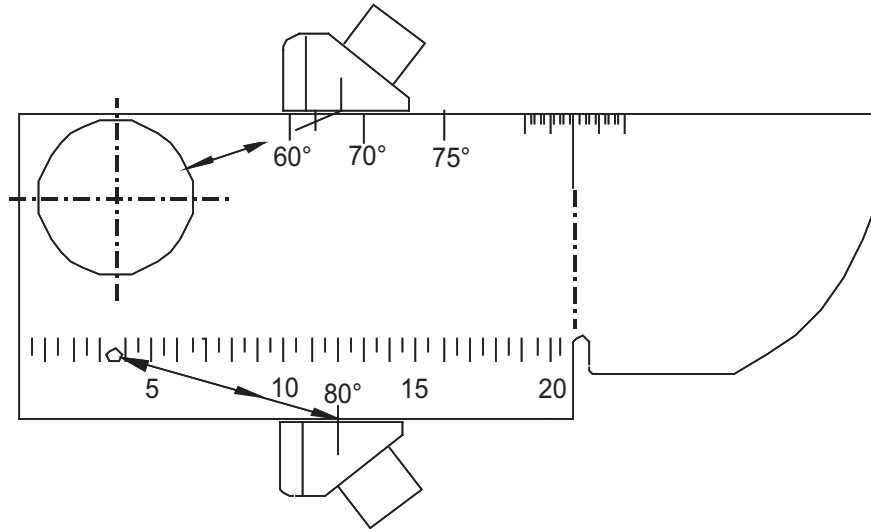

Figure 5-41: IIW Block Refraction Angle Calibration

b) B1 Block Refraction Angle Transducer Locations - For the B1 Block, use the reflection from the side drill hole, as shown in *Figure 5-42*, and maximize the echoes as before.

14. The measured angle should be within the specifications of the code or procedures used, normally ± 2 degrees.

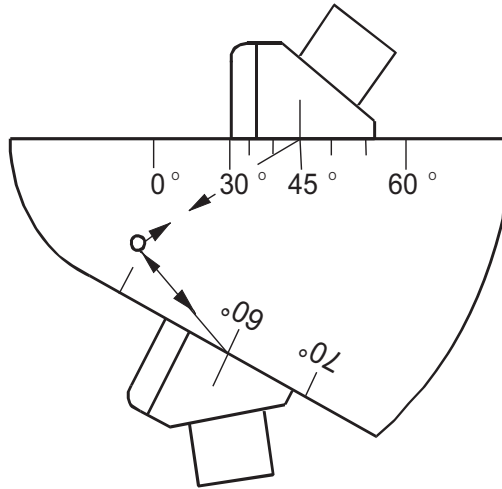

Figure 5-42: B1 Block Refraction Angle Transducer Locations

15. **Setting the reference level:** Set the echo signal level according to the specific code requirement. For example, use the 0.062 side drill as shown in *Figure 5-43*. The echo should be set to vertical line 5 to 7 (50 to 70%) as a reference.
16. Increase the Gain as specified in the code or procedure, and you are ready to scan.

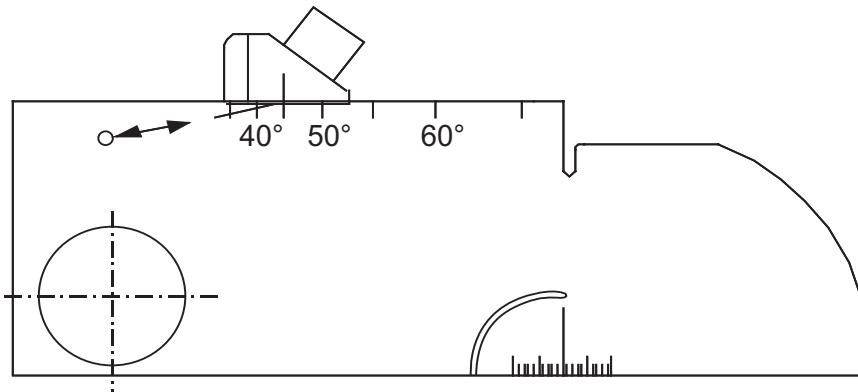

Figure 5-43: Reference Level Adjustment

5.4.2 Defect Location in Weld Inspection

It is important to determine the distance and depth of a located flaw or defect in a shear wave test. A Sonic[®] Ultrasonic Calculator for Weld Inspection can be used to graphically locate defects, or simple sine-cosine trigonometry can be used.

Direct Reflection Location of Flaws

1. Distance = sound path (as measured on EL/LCD) times the sine of the wedge angle.

$$\text{Dist} = S \cdot \sin(\text{angle})$$

2. Depth = sound path (as measured on the EL/LCD) times the cosine of the wedge angle.

$$\text{Depth} = S \cdot \cos(\text{angle})$$

3. Example:

A 60° wedge and EL/LCD measured sound path of 2 inches (refer to *Figure 5-44*).

$$\text{Dist} = 2 \cdot \sin 60^\circ = 1.74 \text{ inches}$$

and

$$\text{Depth} = 2 \cdot \cos 60^\circ = 1.00 \text{ inches}$$

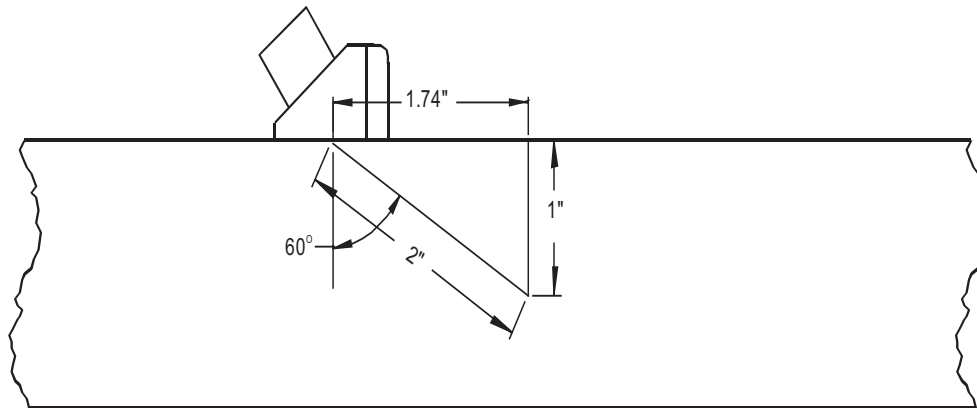

Figure 5-44: Defect Location in Shear Wave Inspection

5.4.3 Multiple Bounce Weld Inspection

If the sound path bounces or reflects one or more times from the sides of the test piece, the sound path and surface distance readings will be the same as for direct reflection. However, the depth calculation will give a result greater than the actual thickness (as shown in *Figure 5-45*).

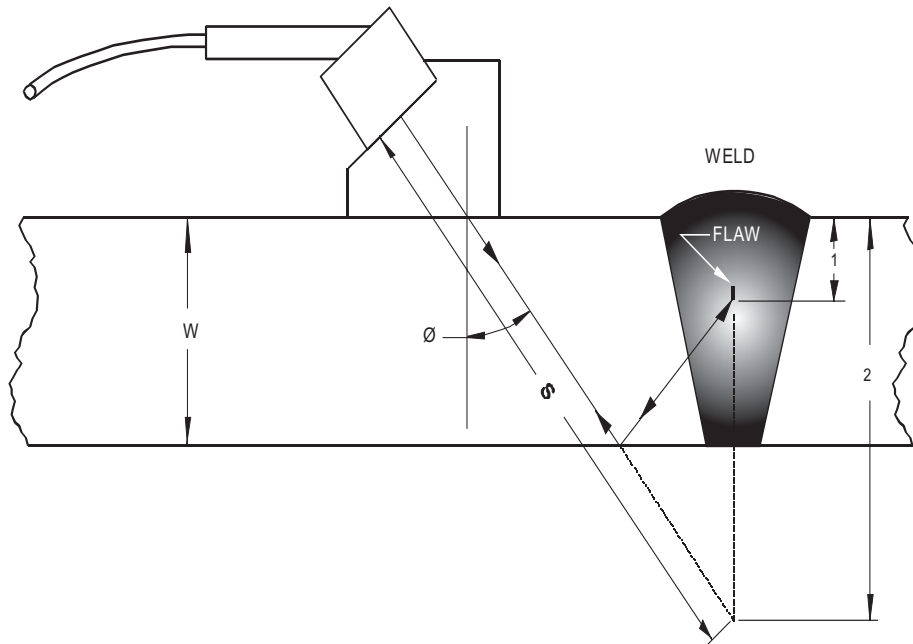

Figure 5-45: Multiple Bounce Shear Calibration

1 = actual depth w = wall thickness

2 = calculated depth s = sound path (measured on EL/LCD)

Depth calculation for one bounce: calculate the depth as in Direct Reflection.

depth (2) = $S \cdot \cos(\text{angle})$

Subtract the depth (2) from twice the wall thickness to obtain the actual depth.

actual depth (1) = $2w - \text{depth (2)}$

Example:

W = 1 inch and S = 3 inches and angle $\theta = 60^\circ$ then:

$$\text{depth}(2) = 3 \cdot \cos 60^\circ$$

$$= 1.5''$$

$$\text{actual depth}(1) = (2 \times 1'') - 1.5''$$

$$= 0.5''$$

Shear Wave (Angle Beam) Digital Thickness Calibration

Once the screen range is calibrated, continue with the setup of the Angle Beam (Trig functions) mode. Adjust the operating controls as follows:

1. For the correct thickness measurements, Gate1 must be adjusted as follows: **A IIW Type 1 Block is used for this application.**
2. Press the GATE1 menu key, GATE1 *menu soft key*, and press the UP/DOWN arrow keys or rotate the SmartKnob™ until the “+ “ is selected.
3. Press the LEVEL *menu soft key* and adjust the level to the desired screen height, such as 40%, with the UP/DOWN arrow keys or the SmartKnob™.
4. Press the POSN *menu soft key* and adjust the position: the start of the gate is to the right of the transducer wedge noise or IP, and to the left of the first echo (see **Figure 5-46**).
5. Press the WIDTH *menu soft key* and adjust the width to full screen, or to the right of the farthest echo, by rotating the SmartKnob™ or pressing the UP/DOWN arrow keys (see **Figure 5-47**).

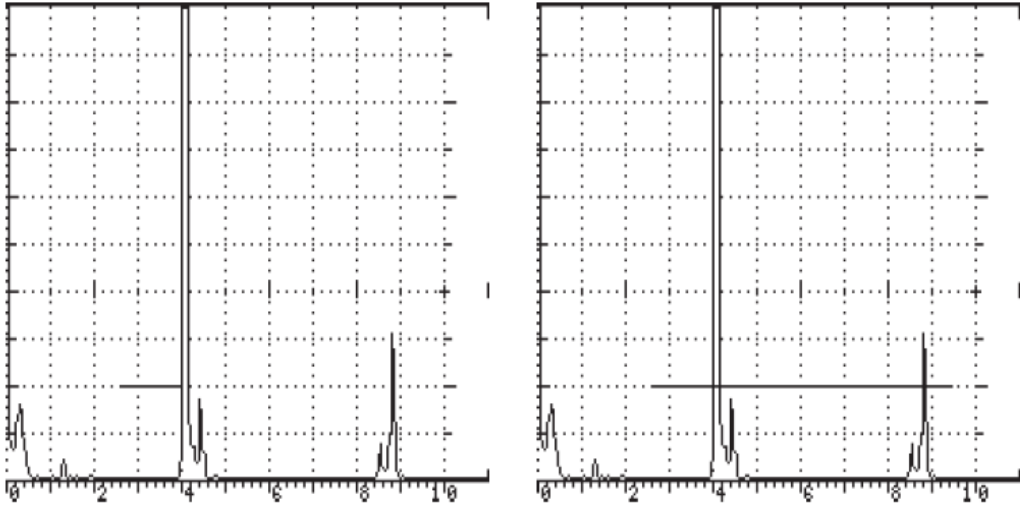

Figures 5-46 and 5-47

6. Ensure that both echoes (thinnest and thickest) go through the gate bar. The Thickness Gauge is now ready for calibration.
 - a) Press the THICK menu key and the following soft key menu will appear:

MENU: THICK				
GAIN ^{0.2}	T-GAUGE	TRIGGER	OFFSET	T-VEL $\frac{in}{us}$
30.0dB	OFF	EDGE	0.000us	0.2310

- b) Press the T-GAUGE *menu soft key* and rotate the SmartKnob™, or press the UP/DOWN arrow keys, to turn on T-gauge to A IP-1st.
- c) Select peak or leading edge triggering; normally, the leading edge is chosen.
- d) Place the transducer on the calibration block and peak out the thickest (farthest) echo by swiveling the transducer. Press the THK CAL softkey, and rotate the SmartKnob™ until the THK CAL value for CAL PT1 reads 9.00 inches. Press the ENTER key to log this value. (see **Figure 5-48.**)
- e) Adjust the thinnest (closest) echo by swiveling the transducer to peak out the echo at 4.00 inches, press the THK CAL softkey and rotate the SmartKnob™ until the THK CAL value for CAL PT2 reads 4.00 inches. Press the ENTER key to log this value.(see **Figure 5-49.**)

f) Calibration is now done. (see *Figure 5-50*.)

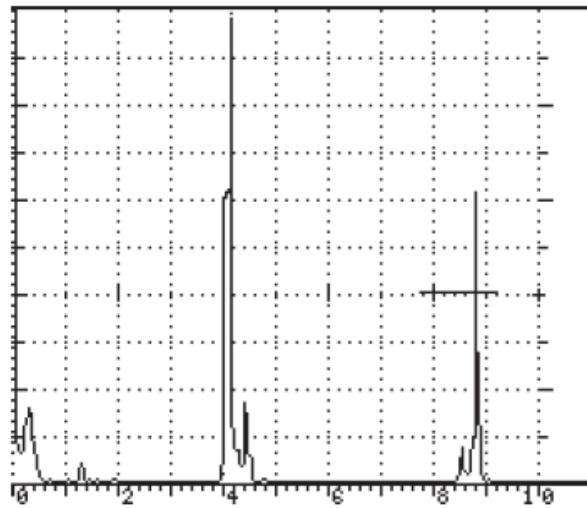

Figure 5-48

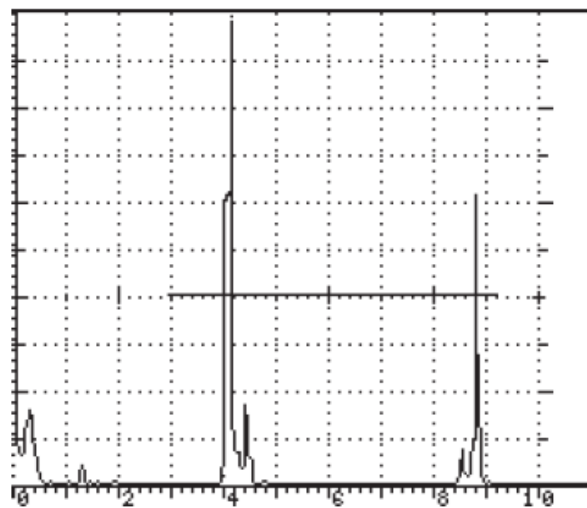

Figure 5-49

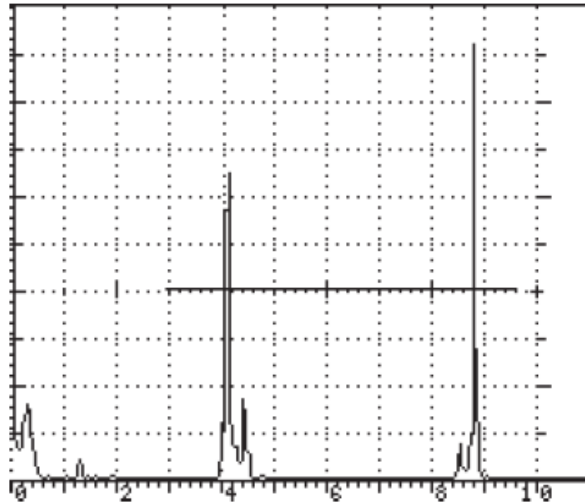

Figure 5-50

- g) Press the TRIG *menu soft key* and turn ON the trig function by using the UP/DOWN arrow keys or SmartKnob™.
- h) Press the ANGLE *menu soft key* and adjust the incidence angle to the desired value using the UP/DOWN arrow keys, SmartKnob™, or by pressing the ANGLE menu key repeatedly.
- i) Press the THICK *menu soft key* and use either the UP/DOWN arrow keys, the SmartKnob™, or press the THICK *menu soft key* repeatedly to enter the thickness of the part to be inspected. By entering the part thickness, the DEPTH of the reflector will always be measured from the surface of the part, no matter what leg or V path you are in.
- j) If the inspection is on a curved surface, press the O-DIAM *menu soft key*. Enter the outer diameter of the curved surface by pressing the UP/DOWN arrow keys or rotating the SmartKnob™. This corrects the trigometric functions for the curved surface.

5.5 Distance Amplitude Correction (DAC) Testing

Press the DAC menu key, and then DAC *menu soft key*, and with the UP/DOWN arrow keys or the SmartKnob, select one of the following modes of operation: 1) DAC CURVONLY; 2) 3

CURVES; 3) 4 CURVES; 4) DAONLY; and 5) DAC+CURV. For setup purposes, start with the DAC CURVONLY.

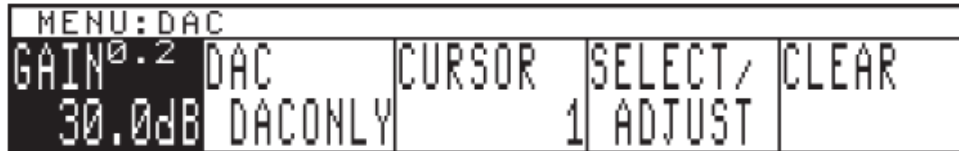

Be sure the Sonic 1200S/HR instrument is set up with the correct transducer setting. Adjust the screen range parameter to include the total range of the test part. For setup purposes, the screen display is for multiple echoes (see **Figure 5-51**).

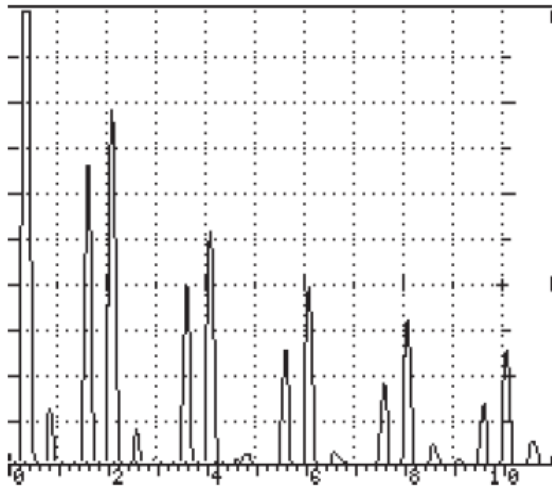

5.5.1 DAC CURVONLY

1. Press the CURSOR *menu soft key*; a small circle will appear on the display that selects the points/echoes where DAC compensation is calculated and the amplitude of the selected points is adjusted. With the UP/DOWN arrow keys or the SmartKnob™, move the cursor to the point/echo where the DAC Curve Only is to start (see **Figure 5-52**).

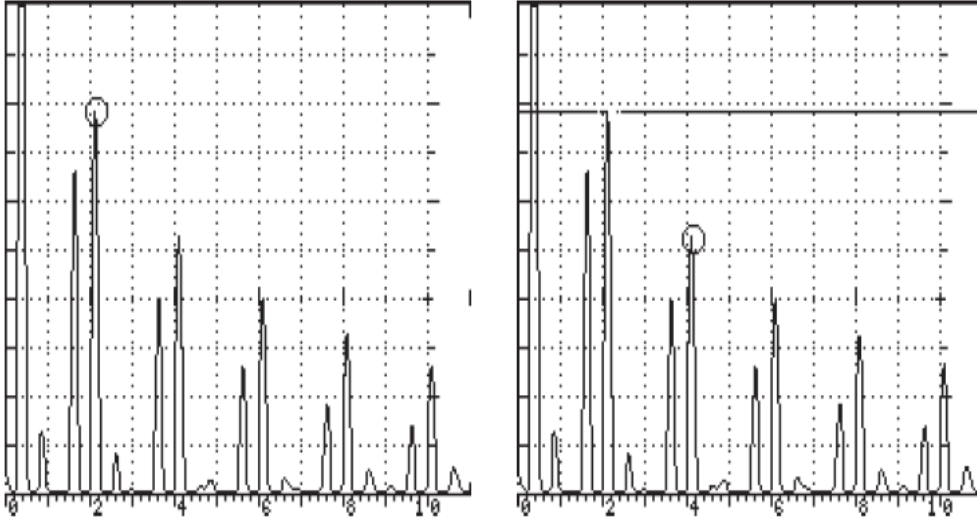

2. Press the SELECT menu soft key; this will start the DAC Curve and log the point.
3. Press the CURSOR *menu soft key*, and with the UP/DOWN arrow keys or SmartKnob™, adjust the cursor to the second point/echo (see **Figure 5-53**).
4. Press the SELECT *menu soft key*; this will log the second point/echo of the DAC Curve.
5. Press the CURSOR *menu soft key* and with the UP/DOWN arrow keys or SmartKnob™, adjust the cursor to the next point/echo.
6. Press the SELECT *menu soft key*; this will log the next point/echo of the DAC Curve.
7. Press the CURSOR *menu soft key*, and with the UP/DOWN arrow keys or SmartKnob™, adjust the cursor to the last point/echo.
8. Press the SELECT *menu soft key*; this will log the last point/echo of the DAC Curve (see **Figures 5-54 and 5-55**). The DAC Curve Only is now complete. If the curve is not correct, repeat the above steps.



Follow the same steps above (DAC CURVONLY) for the 3 CURVE or 4 CURVE mode of operation.

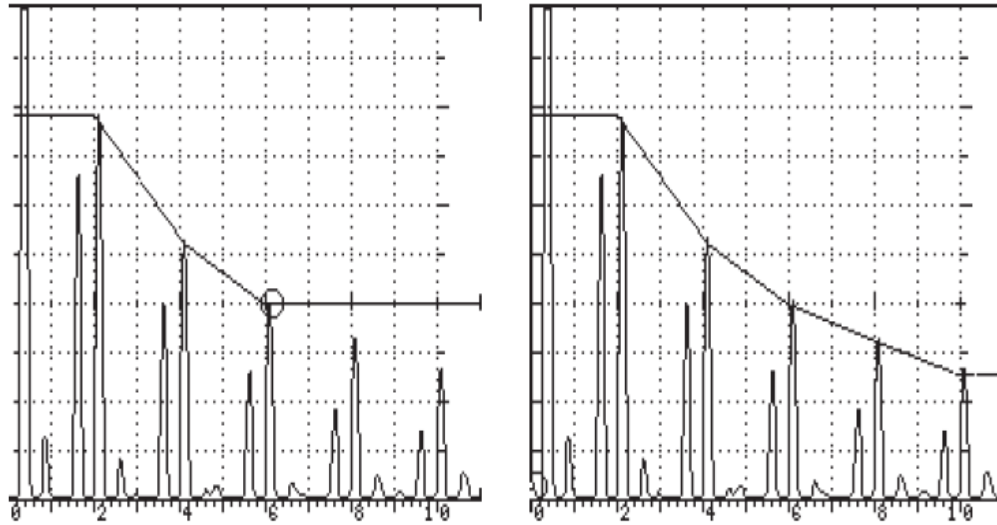

5.5.2 DACONLY

1. Press the *CURSOR menu soft key* and a small circle will appear on the display that selects the points/echo where DAC compensation is calculated and the amplitude of the selected points is adjusted. With the UP/DOWN arrow keys or the SmartKnob™, move the cursor to the point/echo where the DAC Only is to start (see *Figure 5-56*).
2. Press the *SELECT menu soft key*; this will log the next point/echo. SELECT will automatically change to ADJUST. With the UP/DOWN arrow keys or SmartKnob™, adjust the gain to increase the echo amplitude to the desired height: for example, from 70% FSH (full screen height) to 80% FSH (see *Figure 5-57*).
3. Press the *CURSOR menu soft key*, and with the UP/DOWN arrow keys or SmartKnob™, adjust the cursor to the next point/echo (see *Figure 5-58*).
4. Press the *SELECT menu soft key*; this will log the next point/echo. SELECT will automatically change to ADJUST. With the UP/DOWN arrow keys or SmartKnob™, adjust the gain to increase the echo amplitude to the desired height: for example, from 60% FSH to 80% FSH (see *Figure 5-59*).

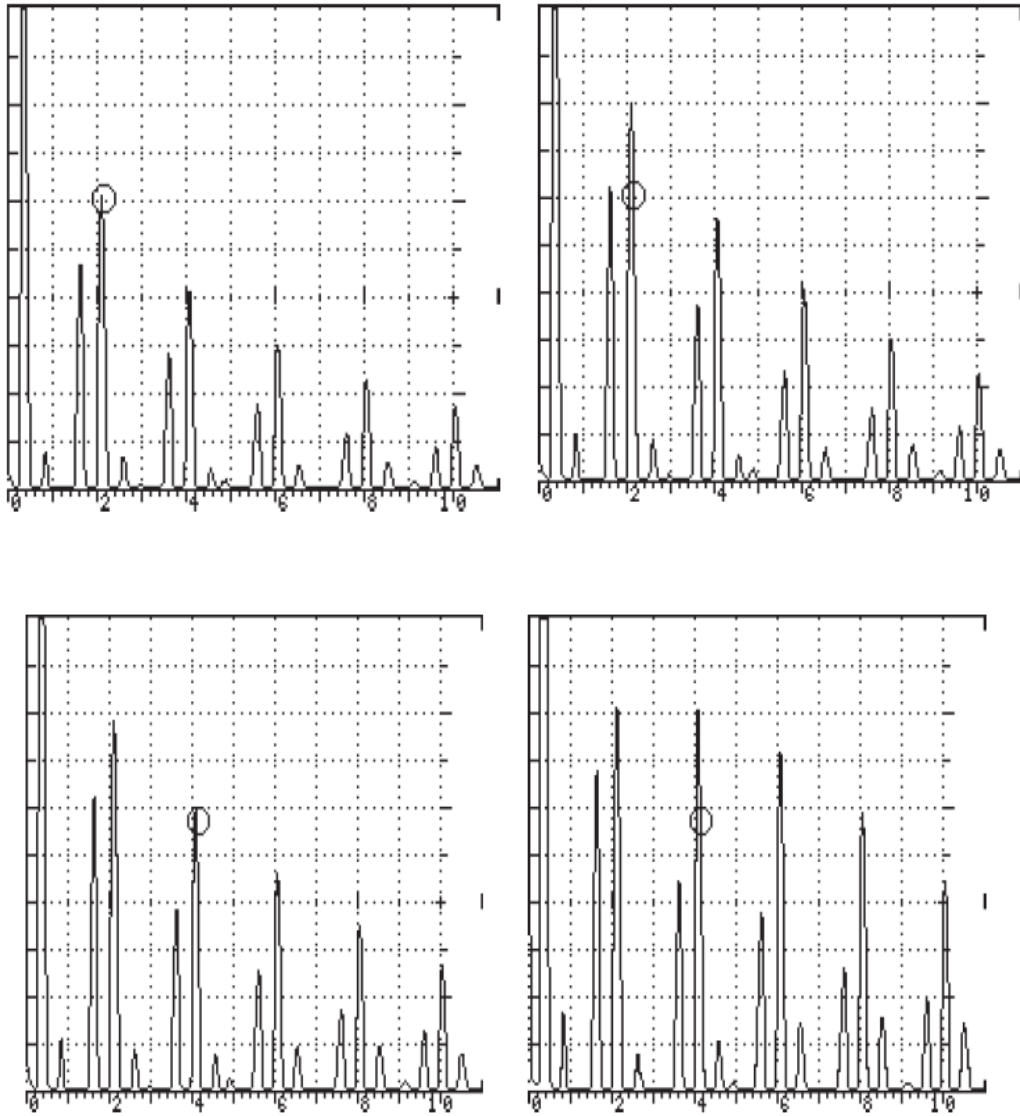
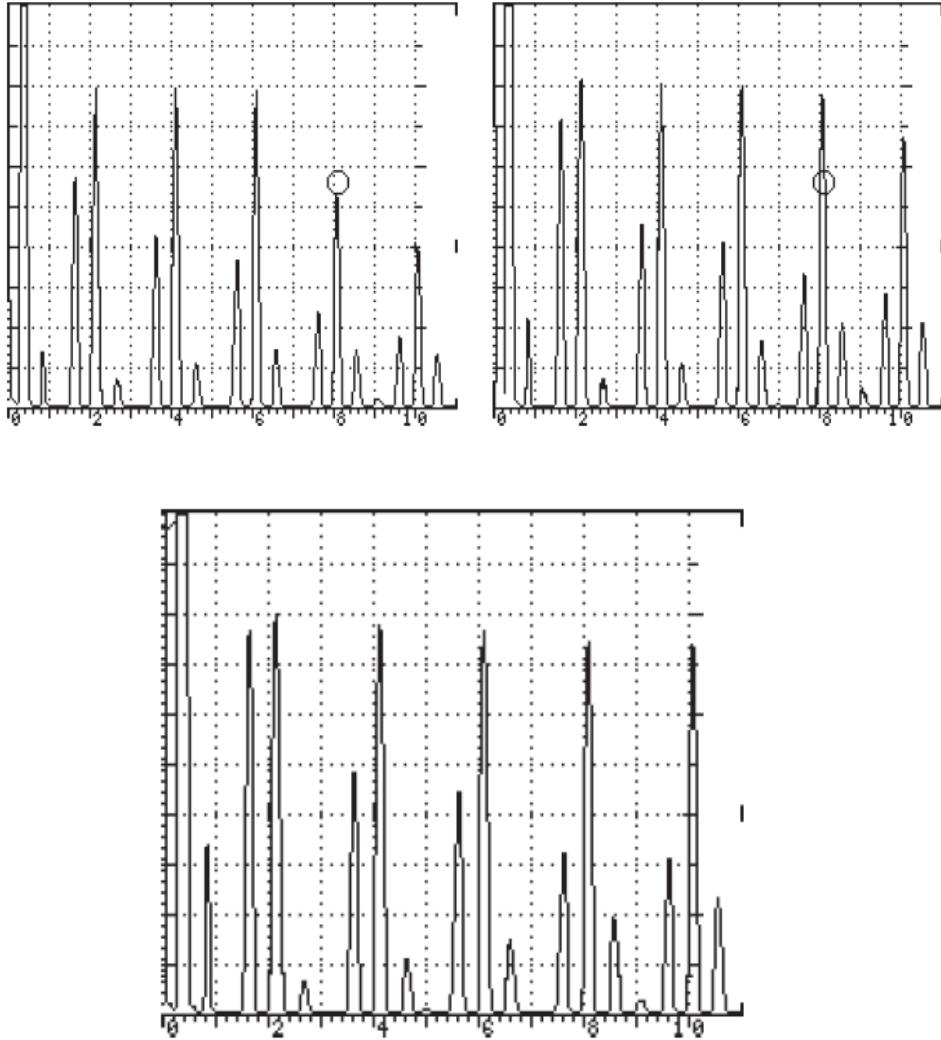

Figure 5-56 - 59

5. Press the *CURSOR menu soft key*, and with the UP/DOWN arrow keys or SmartKnob™, adjust the cursor to the next point/echo (see *Figure 5-60*).

6. Press the *SELECT menu soft key*, this will log the next point/echo. *SELECT* will automatically change to *ADJUST*. With the *UP/DOWN* arrow keys or *SmartKnob™*, adjust the gain to increase the echo amplitude to the desired height: for example, from 60% FSH to 80% FSH.
7. Continue following the above steps for all the points/echo that require DAC (see *Figures 5-61 and 5-62* for the points/echo at the same amplitude).



Figures 5-60 - 62

5.5.3 DAC+CURV

1. Press the DAC *menu soft key*, and with the UP/DOWN arrow keys or the SmartKnob™, select the DAC+CURVE mode.
2. Press the SELECT menu soft key; this will log all the Dac Curve points and automatically draw for the selected points/echoes (see *Figure 5-63*).
3. If the points/echoes are adjusted to the correct amplitude, the DAC+CURVE is complete. If the points/echoes are not at the correct amplitude, you may go back to the point/echo that needs adjustment by pressing the CURSOR *menu soft key* until the cursor is at the desired point/echo. The amplitude is adjusted by pressing the ADJUST *menu soft key*, and then the UP/DOWN arrow keys, or rotating the SmartKnob™.

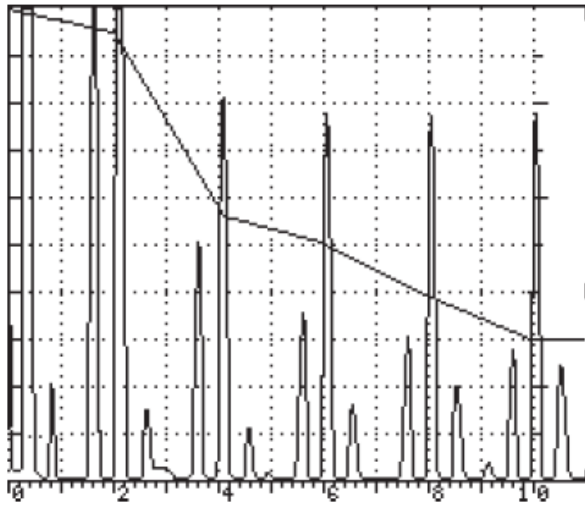

Figure 5-63

6. Internal Data Logger

What's in this section?

- 6.1 Introduction
- 6.2 Creating a New Block
- 6.3 Selecting a New Block
- 6.4 Storing Readings into Memory
- 6.5 Selecting Locations and Reviewing Readings
- 6.6 Clearing Readings
- 6.7 Clearing a Block
- 6.8 Deleting a Block
- 6.9 Deleting All Blocks

6.1 Introduction

The internal Data Logger of the Sonic1200S instrument provides a simple and reliable way to record thickness readings. Displayed readings are stored in one or more data blocks by pressing the T-STORE *menu soft key* in the MAIN menu. A built-in report format outputs a selected block or blocks, or the entire Data Logger memory, to a PC or compatible printer. As with instrument control settings, stored readings are retained in memory, even when batteries are removed.

A data block is a group of Data Logger locations for storing thickness readings (one reading per location) and reporting measurement data. Block size is determined when the operator sets the row and column definitions during the creation of a new block. The Sonic 1200S permits up to a maximum of 100 separate data blocks, although the actual number of data blocks allowed will vary with the number of available thickness storage locations. The Sonic 1200S has a total memory capacity of 5,000 thickness storage locations.

The first reading is stored in each block, starting with location number 1, unless the operator selects a different starting location. The Data Logger automatically advances to the next location, and subsequent readings are stored sequentially until all locations have been filled or another location or data block is selected to receive readings.

Location numbers and stored readings can be viewed from the data block editor. Readings in individual block locations, entire blocks, or all of the Data Logger memory can be cleared.

The Sonic 1200S/HR stores readings in memory indefinitely, even when the batteries have been removed. However, data could be lost or corrupted if the instrument were damaged or exposed to extreme environmental conditions. For extended storage, data blocks should be transferred to a computer for storage on disk or tape.

6.2 Creating a New Block

Readings cannot be stored in the Data Logger until at least one data block has been created and selected, and the thickness gauge must be on and calibrated. The number of data blocks and their size is dependent upon the number of available Data Logger storage locations. The data logger offers up to 5,000 thickness readings.

Use the following procedure to create a new data block:

1. Select SPCL, DATA Sub-menu, and ENTER.
2. Highlight the block number parameter using the corresponding soft key.
3. Select a NEW block by adjusting the block number as high as the instrument will permit. When the last block number is exceeded, the word NEW will appear. If all 100 blocks are in use, the Sonic® 1200S will not permit a new block to be created.
4. Press the ENTER key to create the new block and activate the new block editor.

This new block will be assigned the next available sequential block number. The block is automatically stored in the column direction with one row by one column grid dimensions. The block name and description are initially blank.

To customize the block, use the following controls:

1. Set the desired number of rows and columns using the appropriate menu soft key and the SmartKnob™. If the instrument prevents a particular row or column setting, the problem is likely to be a lack of available memory.
2. Toggle the storage direction between ROW and COLUMN by pressing the direction menu soft key.

3. Enter an 8 character block name by pressing the *NAME menu soft key* (also available in the Data sub-menu).
4. Enter a 26 character block description by pressing the *DESCRIBE menu soft key* (also available in the Data sub-menu).

Ensure that the correct number of rows, number of columns, and storage direction are selected before leaving this menu. Once defined, the rows, columns, and storage direction cannot be modified. Changing a block definition requires deleting the block and creating a new block with the correct definition.

The Sonic 1200S automatically sets the current Data Logging block to the new block number and the location to 1. To begin data storage, switch to the main menu by pressing the *MAIN* key.

6.3 Selecting a Block

Before readings can be stored in the Data Logger, one of the data blocks created using the procedure in the preceding section must be selected to receive the data.

When a new block is created, it automatically becomes the current block selection. To select a different data block:

1. Select the *SPCL* menu.
2. Highlight the *BLOCK* parameter box using the *column menu soft key*.
3. Adjust the *BLOCK* number using the *SmartKnob™* or the *Increase/Decrease* keys.

Each time the block number is changed, the reading storage location (*T-STORE*) is automatically reset to that location. The Sonic 1200S automatically returns to the last selected data block when the instrument is switched on.

6.4 Storing Readings into Memory

To store thickness or other soundpath distance measurements in the Data Logger, the following function settings must be enabled:

- The thickness gauge must be set *ON*.
- A data block must be created and selected.
- An *EMPTY* storage location must be selected.
- The main menu will be displayed when the *MAIN* key is pressed.

The enlarged thickness reading is automatically displayed in the numeric display portion of the screen.

To record a displayed thickness value in the current location, press the T-STORE *menu soft key*. Once the reading has been stored, the block location number will be incremented automatically. The Sonic 1200S will not advance the location number beyond the end of the block, nor will the Sonic 1200S record the displayed value(s) if they are zero (0).

6.5 Selecting Locations and Reviewing Readings

Any location in the currently selected block number and the value stored in that location can be selected and viewed from either the SPCL menu or the Data Review sub-menu. From the instrument's MAIN menu, the T-STORE location number may be altered using the arrow keys.

The value presently stored in memory is displayed in one of three ways:

EMPTY No measurement has been stored.

X.XXX in (XX.X mm) The value presently stored in the displayed location number. Stored readings are always displayed in the "as stored unit of measure." The set using the UNITS function is in the SPCL menu. The units for the data block are set to the instrument setting when the block is defined.

To review stored readings from the SPCL menu:

1. Display the SPCL menu.
2. Select the desired location number T-STORE.
3. Observe the stored thickness reading or message.

To review readings from the Data Review sub-menu:

1. Display the Data Review sub-menu SPCL, DATA sub-menu, ENTER, BLOCK #, ENTER.
2. Select the desired storage location either by the location number or by row and column.
3. The selected stored thickness reading or message will be highlighted.

6.6 Clearing Readings

The value stored in any location in the currently selected block number can be cleared from Data Logger either from the SPCL menu or the Block Review sub-menu.



Clearing a stored reading permanently erases it from memory. It cannot be recovered.

The contents of the currently selected block location will be permanently lost. However, the contents of the data block may be transferred to a printer or personal computer prior to clearing.

To clear the contents of a storage location from the SPCL menu:

1. Display the SPCL menu.
2. Select the desired BLOCK number.
3. Select the desired location number T-STORE.
4. Select the CLEAR function using menu soft keys and the ENTER key.
5. Press the ENTER key to confirm the clear location operation, any other key to abort.

To clear the contents of a storage location from the Data Review sub-menu:

1. Display the Data Review sub-menu SPCL, DATA sub-menu, ENTER, BLOCK #, ENTER
2. Select the desired storage location either by the location number or by row and column.
3. Select the CLEAR function using the CLEAR *menu soft key*.
4. Press the ENTER key to confirm the clear location operation, any other key to abort. Once the location has been cleared, it is then available for the recording of new measurement data.

6.7 Clearing a Block

The entire contents of the currently selected block can be cleared from Data Logger memory and from the Block Review sub-menu. All data in the cleared data block will be permanently lost. However, the contents of the data block may be transferred to a printer or personal computer prior to clearing.

To clear the contents of a data block:

1. Display the Data Review sub-menu SPCL, DATA sub-menu, ENTER, BLOCK #, ENTER.
2. Press LOCATION *menu soft key*.

3. Use the SmartKnob™ to decrease the location number until the word ALL appears.



Clearing a stored reading permanently erases it from memory. It cannot be recovered.

4. Press the CLEAR *menu soft key*
5. Press the ENTER key to confirm the clear operation, any other key to abort.

All locations in the data block have been cleared and are available for recording of measurement data.

6.8 Deleting a Block

A data block and its contents can be deleted from the Data sub-menu, but the block definition and its contents will be permanently lost. However, the contents of the selected block may be transferred to a printer or personal computer prior to deleting.

To delete a Data Logger block:

1. Display the Data sub-menu SPCL, DATA sub-menu, ENTER.
2. Press BLOCK *menu soft key*.
3. Adjust the block number until the desired number is displayed.



Clearing a stored reading permanently erases it from memory. It cannot be recovered.

4. Press the DELETE *menu soft key*
5. Press the ENTER key to confirm the delete operation, any other key to abort.

6.9 Deleting All Blocks

The All Data Logger blocks can be deleted from the Data sub-menu. All data in the Data Logger will be permanently lost. However, the contents of one or all blocks may be transferred to a printer or personal computer prior to deleting.

To delete the entire Data Logger memory:

1. Display the Data sub-menu SPCL, DATA sub-menu, ENTER.
2. Press BLOCK *menu soft key*.
3. Decrease the block number below 1 until the word ALL appears.



Clearing a stored reading permanently erases it from memory. It cannot be recovered.

4. Press the DELETE menu soft key.
5. Press the ENTER key to confirm the delete operation, any other key to abort.

7. Computer Interface

What's in this section?

- 6.1 Description
- 6.2 RS-232C Communication
- 6.3 Modes of Operation
- 6.4 Command Strings
- 6.5 Status Reporting
- 6.6 RS-232 Command Set
- 6.7 Examples

7.1 Description

The Sonic[®] 1200S/HR instrument has the capability of being controlled and monitored by an external computer or terminal. The RS-232C communication port allows an external device to send commands to or obtain information from the Sonic[®] 1200S/HR. With the exception of a few controls, all operations available from the front panel are also available from the RS-232 interface.



Use of single quotes (') and double quotes (") throughout this description are for the purpose of discussion only. These two symbols are used to delineate specific characters and character strings used in the RS-232 interface, and are NOT to be used in actual RS-232 communications.

7.2 RS-232C Communication

The Sonic® 1200S/HR serial interface is configured as Data Terminal Equipment (DTE). This allows a direct connection between the instrument and Data Communication Equipment (DCE) without the need for crossover connections. The default communication protocol is shown in the following table:

RS-232 Parameter	Sonic® 1000S Configuration
Baud Rate	9600 bps
Word Size	8
Parity	NONE
Stop Bits	1

The RS-232C serial interface will communicate with either a serial interface printer or an externally connected computer. The 9-pin D-subminiature male connector is designed to connect directly to an industry standard IBM-AT compatible serial port. Pinouts are listed below:

1. Not connected
2. Output; TXD (transmitted data)
3. Input; RXD (received data)
4. Input; CTS (clear to send)
5. Signal ground
6. Not connected
7. Not connected
8. Output; RTS (request to send)
9. Not connected

Using a readily available 9-pin to 25-pin serial adapter cable, it will also connect to standard IBM-PC serial connectors by using a 25-pin to 25-pin cable with female connectors on both ends. Interface cables are also available from Olympus NDT Instruments.

Proper connections of the serial port to various devices are tabulated below:

Sonic® Instrument Serial Connector (9 pin male)	Serial Printer (25 pin female)	IBM-PC Serial Connector (25 pin male)	IBM-AT Serial Connector (9-pin male)
pin 2 (TXD)	pin 3 (RXD)	pin 3 (RXD)	pin 2 (RXD)
pin 3 (RXD)	pin 2 (TXD)	pin 2 (TXD)	pin 3 (TXD)
pin 4 (CTS)	pin 20 (DTR)	pin 20 (DTR)	pin 4 (DTR)
pin 5 (GND)	pin 7 (GND)	pin 7 (GND)	pin 5 (GND)
pin 8 (RTS)	pin 5 (CTS)	pin 5 (CTS)	pin 8 (CTS)

7.2.1 9-Pin Auxiliary Output

The 9-pin, D-subminiature female connector, labeled OUTPUT, provides optional alarm and analog level signals from the gates and the thickness gauge. Separate digital and analog ground pins and a pulse for synchronizing to the pulser are also provided. Alarm signals should be referenced to digital grounds, and peak signal and distance outputs referenced to the analog ground. Pinouts are listed below:

1. Gate 1 Alarm 1
2. Thickness Gauge Alarm
3. Digital Ground
4. Synchronize to Pulser
5. Peak 1/Distance Analog Out
6. Gate 2 Alarm 2
7. Digital Ground
8. Analog Ground
9. Peak 2 Analog Out

7.3 Modes of Operation

Two communication modes are available: HOST mode, which permits computer communication with the instrument, and TERMINAL mode, which is designed for use with a terminal. Each time the Sonic[®] 1200S/HR is powered on, the operating mode is set to HOST mode. The RS-232 command set is identical for both modes, but the way in which the Sonic[®] 1200S/HR responds to serial input differs.

Terminal Mode

In terminal mode, each character is echoed back as it is received. Carriage returns are echoed back as carriage return and line feed. All responses are terminated by carriage return and line feed. Prompts, terminated by carriage return and line feed, are returned in all cases.

PromptDescription

“>”....Command Accepted

“C?”....Invalid Command

“V?”....Invalid Value

HOST Mode

In HOST mode, characters are not echoed back. All responses are terminated by a carriage return only. Prompts are only returned in the event of error conditions, such as the following:

PromptDescription

“C?”....Invalid Command

“V?”....Invalid Value

Space (20 Hex) and line feed (0A Hex) characters are ignored in most cases. To prevent the loss of data, it is important that the HOST/TERMINAL not attempt another serial transaction until a response from the previous transaction is received (carriage return for HOST mode; prompt, carriage return, and line feed for TERMINAL mode). All commands to the Sonic[®] 1200S/HR must be terminated by a carriage return (0D Hex). All information sent by the Sonic[®] 1200S/HR is terminated according to the serial mode (carriage return for HOST mode; carriage return and line feed for TERMINAL mode).

7.4 Command Strings

Serial communication is performed using ASCII characters (with the exception of binary data transfers). A command string is comprised of three or more ASCII characters and a carriage

return (terminator). The command string has three parts, not all of which are used in every case.

1. **Command Code:** A three character code that identifies the instrument item or function (refer to RS-232 Command Set).
2. **Command Operation:** A one character code that identifies the operations as READ '?', WRITE '=', or EXECUTE (carriage return).
3. **Command Value:** The type and number of ASCII characters in this part of the command string is variable and depends on the parameter specification.

The Sonic[®] 1200S/HR recognizes three types of commands: READ, WRITE, and EXECUTE. The type of command is indicated by the command operation. To perform a read operation, the '?' symbol is used. To perform a write operation, the '=' symbol is used. To perform an execute operation, a carriage return is used.



The Sonic[®] 1200S/HR does NOT process a command string until a carriage return is received.

7.5 Status Reporting

After receiving a command, the Sonic[®] 1200S/HR checks the string for errors. If no errors are detected, the desired operation is executed. Upon completion of error checking or command execution, the Sonic[®] 1200S reports back to the host/terminal with a prompt. The prompts vary with the RS-232 mode and the results of the error detection.

Prompts indicating successful completion of a command are to be used by the host/terminal as a signal indicating that the Sonic[®] 1200S/HR is ready for another command. In host mode, the prompt is simply a carriage return (0D Hex). In terminal mode, an angle bracket '>' is sent, followed by a carriage return (0D Hex) and line feed (0A Hex).

If an error is encountered, error prompts are returned to the host/terminal. Two types of error prompts are used to indicate BAD COMMANDS and BAD VALUES. If a bad command is received (Command code), the Sonic[®] 1200S/HR will return C? terminated with a carriage return (and line feed for terminal mode). If a bad value is received (Command value), the Sonic[®] 1200S/HR will return V? terminated with a carriage return (and line feed for terminal mode).

7.6 RS-232 Command Set

RS-232 control of the Sonic[®] 1200S/HR is achieved using ASCII command strings terminated by a carriage return (0D Hex). For commands that require ASCII letters A-Z (or a-z), upper or lower case may be used. Space (20 Hex) and line feed (0A Hex) characters may be included in the command strings (that is, spaces may be included in report strings), but are usually ignored. When specifying a real number value, the decimal point is only required when resolution beyond integers is desired.

Each instrument parameter permits a specific subset of the three available command types (**R**ead, **W**rite, or **eX**ecute). Command types permitted by each parameter are listed in the following tables.

Function	RWX	Code	Range	Description
Pulse Width	RW	PUL	30 - 1000 ns (Regular version) 15 - 500 ns (HR version)	Pulser pulse width
Damping	RW	DMP	"25" "50" "200" (Ohm)	Pulser damping
Mode	RW	MOD	"SINGLE" "DUAL" "THRU"	Transducer mode
Pulser Voltage	RW	PVO	"150" "300" (volts)	Pulser voltage selection
Gain	RW	GAN	0.0 - 110.0 (dB)	Receiver gain setting
Display	RW	DSP	"RF" "FULLWAV" "RF+" "FLTR 1" "RF-" "FLTR 2" "HALF+" "FLTR 3" "HALF-"	Receiver display mode
Color	RW	CSH	1-8	Changes color palette on '+' instruments
Reject	RW	REJ	0 - 80 (%)	Receiver linear reject

Function	RWX	Code	Range	Description
Frequency	RW	FRQ	"1MHz" "2.25MHz" "5MHz" "10MHz" "15MHz" (HR version only) "HIPASS" "WB"	Receiver tuning frequencies
Gate 1	RW	GT1	"OFF", "+", "-"	Gate 1 OFF/ON and polarity
Gate 1 Level	RW	LV1	5 - 100 (%)	Gate 1 alarm level
Gate 1 Position	RW	PS1	-1.16 ~ 185 (in) -29.0 ~ 4694 (mm)	Gate 1 start position (depends on velocity)
Gate 1 Width	RW	WD1	0.001 ~ 296 (in) 0.1 ~ 7510 (mm)	Gate 1 width (depends on Gate1 position and velocity settings)
Gate 2	RW	GT2	"OFF", "+", "-"	Gate 2 OFF/ON and polarity
Gate 2 Level	RW	LV2	5 - 100 (%)	Gate 2 alarm level
Gate 2 Position	RW	PS2	-1.16 ~ 185 (in) -29.0 ~ 4694 (mm)	Gate 2 start position (depends on velocity)
Gate 2 Width	RW	WD2	0.001 ~ 296 (in) 0.1 ~ 7510 (mm)	Gate 2 width (depends on Gate2 position and velocity settings)
Range	RW	RNG	0.048 ~ 296 (in) 1.23 ~ 7510 (mm)	Sweep range (depends on velocity)
Delay	RW	DLY	-1.16 ~ 185 (in) -29.0 ~ 4694 (mm)	Sweep delay (depends on velocity)
Velocity	RW	VEL	0.025 - 0.600 (in/ μ s) 635 - 15240 (m/s)	Sweep velocity
Maximum Repetition Rate	RW	RRM	50 - 3450 (Hz)	Maximum pulser pulse repetition rate
Actual Rep. Rate	R	REP	50 - 3450 (Hz)	Actual pulser pulse repetition rate
Units	RW	UNT	"US" "IN" "MM"	Operating units

Function	RWX	Code	Range	Description
Thickness Enable	RW	TGE	"OFF" "IP-1ST" "E-E" "A IP-1ST" "AUTO E-E"	T-Gauge enable
Thickness Trigger	RW	TGT	"EDGE" "PEAK"	T-Gauge measurement trigger on EDGE (rising edge only) or on PEAK
Face Plate Offset	RW	FPO	-5.0 ~ 100.0 (μs)	T-Gauge transducer offset
Thickness Velocity	RW	TMV	0.025 ~ 0.600 (in/μs) 635 ~ 15240 (m/s)	velocity setting for T-Gauge functions
Angle Beam Enable	RW	ABE	"OFF" "ON"	Trigonometric function enable
Angle Degrees	RW	ADG	0.0 ~ 90.0 (°)	Angle beam angle
Part Thickness	RW	PTH	0.001 in ~ 185 in 0.1 mm ~ 4694 mm	Angle beam part thickness (depends on thickness velocity)
Outer Diameter	RW	DIA	OFF ~ 185 in OFF ~ 4694 mm	Curved surface diameter: OFF = flat surface
Sound Path	R	TSP	"----" OR floating point number	Sound path
Thickness	R	TDP	"----" OR floating point number	Thickness reading
Distance	R	TDS	"----" OR floating point number	Distance reading
Thickness Calibration Point 1	RW	TK1	0.001 in ~ 185 in 0.1 mm ~ 4694 mm	Thickness cal point 1 value
Thickness Calibration Point 2	RW	TK2	0.001 in ~ 185 in 0.1 mm ~ 4694 mm	Thickness cal point 2 value
Calculate Thickness Calibration Point	W	STK		Start thickness calibration on current calibration point
Program Status	W	PEF	1 - 100	Stored program status. Response: "EMPTY" or "FULL"

Function	RWX	Code	Range	Description
Program Store	W	PST	1 - 100	Program store operation
Program Recall	W	PRC	0 - 200	Program recall operation 0: load all defaults 1-100: recall program stored in location 1-100 101-200: recall program stored in ascan location 1-100
Program Erase	W	PER	1 - 100	Program erase operation
Read Program Name	W	PRN	1 - 100	Read stored program name
Write Program Name	W	PWN	1 - 100	Write stored program name (26 characters)
Program Upload	W	PUP	1 - 100	Upload stored program (binary format)
Program Download	W	PDN	1 - 100	Download program (binary format)
Scan Status	W	SEF	1 - 100	A-Scan storage location status. Response: "EMPTY" "FULL" (normal display mode) "PK-1", "PK-2" (live & peak if enable) "RF-1", "RF-2" (half + & - in RF mode) Add "R" if attribute is set.
Scan Store	W	SST	1 - 100	Store A-Scan in location specified
Scan Erase	W	SER	1 - 100	Erase A-Scan location specified
Read A-Scan Name	W	ARN	1 - 100	Read stored A-Scan name
Write A-Scan Name	W	AWN	1 - 100	Write stored A-Scan name (26 characters)
Scan Upload	W	SUP	1 - 100	Upload stored A-Scan (binary format)
Scan Download	W	SDN	1 - 100	Download A-Scan (binary format)

Function	RWX	Code	Range	Description
Upload Wave	W	UPW	0 - 101	Upload wave form data (220 points) 0 = current display sweep 1 - 100 = stored a-scan 101 = current display 2nd sweep.
Upload Display	R	UPD	N/A	Upload bit image reproduction of the display (10,240 points)
Read Report Header	W	RHD	N/A	Read the report header
Set Report Header	W	SHD	N/A	Write the report header (40 characters)
Read Report Label	W	RLB	1 - 7	Read a report label
Set Report Label	W	SLB	1 - 7	Write a report label (26 characters)
Read Report Field	W	RFL	1 - 7	Read a report field
Set Report Field	W	SFL	1 ~ 7	Write a report field (40 characters)
Read Report Entry	W	REN	1 ~ 3	Read a report entry
Set Report Entry	W	SEN	1 ~ 3	Write a report entry (26 characters)
LCD Backlight Brightness	RW	CNT	0 ~ 31	LCD Backlight brightness adjustment
Knob Resolution	RW	RES	3, 4 (digits)	Knob resolution
Gain Step Size	RW	GSS	"0.2" "1.0" "2.0" "6.0" "12.0" (dB)	Gain adjustment step size
+dB Value	RW	+DB	"6", "12", "18", "24" (dB)	+dB feature gain setting

Function	RWX	Code	Range	Description
+dB Status	RW	DBS	"OFF" "ON"	+dB feature status
dB Difference	RW	DIF	-110.0 - 110.0 (dB)	dB reference gain difference
Lock Out	RW	LOK	"OFF" "ON"	Front panel lock out
Battery Status	R	BAT	"OK" "LOW"	Instrument battery status
Alarm Dwell	RW	ADW	OFF, .2, .4 ... 10, LATCH	Alarm dwell in seconds (<i>command not available on Sonic® 1000i</i>)
Clock Hours	RW	HR.	0 - 23	Instrument clock hours setting
Clock Minutes	RW	MIN	0 - 59	Instrument clock minutes setting
Clock Month	RW	MON	1 - 12	Instrument clock month setting
Clock Year	RW	YR.	1996 - 2095	Instrument clock year setting
Peak Hold	RW	PKH	"OFF" "ON"	Peak hold feature enable
Signal Fill	RW	FIL	"OFF" (Hollow) "ON" (Filled)	Signal fill enable
Alarm 1 Status	R	G1A	"OFF" "ON"	Gate 1 alarm status
Alarm 2 Status	R	G2A	"OFF" "ON"	Gate 2 alarm status
Gate 1 Peak Amplitude	R	PA1	0 - 246	Gate 1 peak amplitude reading
Gate 2 Peak Amplitude	R	PA2	0 - 246	Gate 2 peak amplitude reading

Function	RWX	Code	Range	Description
Freeze	RW	FRZ	"OFF" "ON"	Freeze feature OFF/ON control
Zoom Mode	RW	ZOM	"OFF" "ON"	Zoom feature OFF/ON control
Language	RW	LAN	"ENGLISH" "FRANCAIS" "DEUTSCH" "ESPANOL" "ITALIANO" "ROMENO"	Instrument operating language
Alarm Horn	RW	HRN	"OFF" "ON"	Gate alarm horn enable
Graticule	RW	GRT	"OFF" "5X5" "10X10" "JIS"	Signal display graticule enable
Printer	RW	PRT	"EPSON" "CANON" "HP-PCL" "PENTAXII"	RS-232 printer selection
Baud Rate	RW	BPS	"2400" "19200" "4800" "38400" "9600" "57600"	RS-232 baud rate setting
A-LOC	RW	ALO	0 - 100	Current Ascan Location: 0=ALL, 1-100
Transducer Model	R	XMD		Transducer model
Transducer Serial Number	R	XSN		Transducer serial number
Instrument Name	R	NAM	N/A	Request instrument name
Firmware Version	R	VER	N/A	Request firmware version
Active Soft Key	RW	ASI	1 - 5	Active soft key number
Pulser Key	X	KPL	N/A	Execute the pulser key remotely

Function	RWX	Code	Range	Description
Receiver Key	X	KRC	N/A	Execute the receiver key remotely
Range Key	X	KRN	N/A	Execute the range key remotely
Gate 1 Key	X	KG1	N/A	Execute the gate 1 key remotely
Gate 2 Key	X	KG2	N/A	Execute the gate 2 key remotely
Thick Key	X	KTH	N/A	Execute the thick key remotely
Angle Key	X	KAN	N/A	Execute the angle key remotely
SPCL Key	X	KSP	N/A	Execute the SPCL key remotely
Main Key	X	KMN	N/A	Execute the main key remotely
Print Key	X	KPR	N/A	Execute the print key remotely
Up Arrow Key	X	KUA	N/A	Execute the UP arrow key remotely
Down Arrow Key	X	KDA	N/A	Execute the DOWN arrow key remotely
Enter Key	X	KEN	N/A	Execute the enter key remotely
Soft Key 1	X	KS1	N/A	Execute the soft key 1 remotely
Soft Key 2	X	KS2	N/A	Execute the soft key 2 remotely
Soft Key 3	X	KS3	N/A	Execute the soft key 3 remotely
Soft Key 4	X	KS4	N/A	Execute the soft key 4 remotely
Soft Key 5	X	KS5	N/A	Execute the soft key 5 remotely
Terminal Mode	X	TRM	N/A	Terminal mode communications
Host Mode	X	HST	N/A	Host mode communications
Instrument Reset	X	RST	N/A	Reset the instrument
Clear Program	X	CLP	N/A	Clear ALL stored programs
Clear A-Scans	X	CLS	N/A	Clear ALL stored A-Scans

Function	RWX	Code	Range	Description
Clear Report	X	CLR	N/A	Clear/Reset report header, labels, fields, and entries
Clear Instrument	X	CLI	N/A	Clear Programs, A-Scans, Data , and instrument
Load All Default	X	LAD	N/A	Load all defaults
Load Some Default	X	LOD	N/A	Load defaults except report header, baud, contrast, printer, language

DAC

Function	RWX	Code	Range	Description
DAC	RW	DAC	"OFF" "CURVONLY" "3 CURVES" "4 CURVES" "JIS" "DACONLY" "DAC+CURV"	DAC mode control
DAC Clear	X	DCL	N/A	Clear ALL DAC points
Clear A-Scan Attribute	W	CLA	0 - 100	Clear A-Scan attribute 0 = clear ALL
Set A-Scan Attribute	W	SSA	0 - 100	Set A-Scan attribute, 0 = set ALL
Block	RW	BLK	1 - 100	Active data logger block number
Clear Block	W	CLB	1 - 100	Clear data logger block
Read Block	W	RDB	1 - 100	Read contents of data logger block
Block Status	W	BEF	1 - 100	Data logger block storage status. Response: "EMPTY" - defined, but no data "FULL" "NEW" - not defined "BLANK" - defined, has data, not full yet
Read Block Name	W	BRN	1 - 100	Read data logger block name
Write Block Name	W	BWN	1 - 100	Write data logger block name (8 characters)
Read Block Description	W	BRD	1 - 100	Read data logger block description
Write Block Description	W	BWD	1 - 100	Write data logger block description (26 characters)

Function	RWX	Code	Range	Description
Create Block	W	CRB		Create a new data logger block
New Block Rows	RW	NBR	1 - 1000	Specify number of rows for new data logger block
New Block Columns	RW	NBC	1 - 1000	Specify number of columns for new data logger block
New Block Direction	RW	NBN	"ROW" "COLUMN"	Specify store direction for new data logger block
Last Block Number	R	LBN	1 - 100	Request the last data logger block number
T_STORE	RW	LOC	1 - 5000	Next data logger storage location in current block
Thickness Store	W	TST	1 - 5000	Store thickness operation
Row	RW	ROW	1 - 1000	Next row for data logger storage
Column	RW	COL	1 - 1000	Next column for data logger storage
Location Status	W	LEF	0, 1 - 5000	Data logger storage location status: 0 = Current location response: "EMPTY" "FULL"
Clear Location	W	CLL	0, 1 - 5000	Clear data logger location: 0 = All location in current block
Read Location	W	RDL	0, 1 - 5000	Read data logger location: 0 = Current location
Reference Memory	RW	MLO	0 - 100	Ref Mem location: 0=OFF
DAC Key	X	KDC	N/A	Execute the DAC key remotely

Function	RWX	Code	Range	Description
T-Min	RW	TMN	0.001 in - 185 in 0.1 mm - 4694 mm	Minimum permissible reading for current thickness block
Free Location	R	FLO	0 - 5000	Number of EMPTY locations in current data logger block
Memory Available	R	MAV	0 - 5000	Number of available locations for new blocks
Location Circuit Name	RW	LCN	5-character string	Circuit name of current location in current data block
Location TML ID	RW	LTN	10-character string	Thickness monitoring location ID
Location Delete	W	LDL		Delete current location in current data block
Location Insert	W	LIN		Insert a data point at current location

1. Text Read/Upload Commands

The instrument responds to text read commands with an ASCII string terminated with a carriage return (0D Hex). To ensure proper transfer, the following steps are used to upload a text string:

- a) Host sends a “Read Text” command.
- b) Host waits for the Sonic[®] 1200S/HR to respond with an ASCII text string (terminated with a carriage return, 0D Hex) or an error prompt.

2. Text Write/Download Commands

The Sonic[®] 1200S/HR utilizes only a subset of the printable ASCII characters (**A-Z, 0-9, ., -, /, #, %, and SPACE**). All other characters should be avoided. To ensure proper transfer, these steps are used to write a text string:

- a) Host sends the appropriate “Write Text” command.
- b) Host waits for the Sonic[®] 1200S/HR to respond with a carriage return (0D Hex) or an error prompt.
- c) If no error was encountered, the host sends the text string and waits for a prompt.

3. Binary Read/Upload Commands

The binary upload transfer consists of a 2-byte size count (SS), followed by the binary data information (B..B), and a 1-byte checksum (C). The size count is sent in low byte then high byte order. To ensure data integrity, the host should calculate its own checksum and compare it to that sent by the Sonic[®] 1200S/HR. The checksum is generated by summing all byte values, excluding the size count and checksum, modulus 256.

$$(\text{Byte1} + \text{Byte2} + \dots + \text{ByteN}) \% 256$$

To ensure proper transfer, the following steps are used to upload a scan:

- a) Host sends a “Binary Upload” command.
- b) Host waits for the Sonic[®] 1200S/HR to respond with a carriage return (0D Hex) or an error prompt.
- c) If no error was encountered, the Sonic[®] 1200S/HR proceeds immediately with the upload.

4. Binary Write/Download Commands

The binary download transfer consists of a 2-byte size count (SS), followed by the binary data information (B..B), and a 1-byte checksum (C).

This command is used to send stored binary data, acquired through the corresponding binary upload command, back to the Sonic[®] 1200S/HR. The Sonic[®] 1200S/HR assumes that the data has not been altered. Altered data will yield unpredictable results. To ensure proper transfer, the following steps are used to download stored data.

- a) Host sends a “Binary Download” command.
- b) Host waits for the Sonic[®] 1200S/HR to respond with a carriage return (0D Hex) or an error prompt.
- c) If no error was encountered, the host sends the binary data information and waits for a prompt.

7.7 Examples

Example 1. Set instrument gain to 30.0 dB.

Host	G	A	N	=	3	0	.	0	c/R								
Sonic [®] Instrument										c/R							

Example 2. Read instrument gain.

Host	G	A	N	?	c/R												
Sonic [®] Instrument						3	0	.	0	c/R							

Example 3. Set report label 1 string to $L_1 \dots L_{26}$.

Host	S	L	B	=	1	c/R		L_1	.	.	.	L_{26}	c/R			
Sonic® Instrument							c/R							c/R		

Example 4. Read report label 1 text string.

Host	R	L	B	=	1	c/R										
Sonic® Instrument								L_1	.	.	.	L_{26}	c/R			

Example 5. Upload stored program 1.

Host	P	U	P	=	1	c/R										
Sonic® Instrument							S_1	S_2	P_1	.	.	P_N	C_1	c/R		

Example 6. Download to program location 2.

Host	P	D	N	=	2	c/R		S_1	S_2	P_1	0	0	P_N	C_1		
Sonic® Instrument							c/R								c/R	

Documentation Comments

Olympus NDT is always interested in improving its documentation. Please complete this questionnaire and return your responses to:

Olympus NDT
info@OlympusNDT.com
Attention: NDT Marketing Dept., Technical Publications

The following questionnaire is from the Society for Technical Communication and “Revision Checklist” from *Technical Writing*, Seventh Edition.

Document Title:

Document Number:

Documentation Usability Ratings

Please rate the usability of the document according to the following rating system:

1 - Poor 2 - Average 3 - Excellent

Audience and purpose

Does the document fulfill the purpose?	1	2	3
Is the audience clearly defined?	1	2	3
Does the document meet audience needs?	1	2	3

Organization

Is the organization appropriate and logical?	1	2	3
Are the headings specific and helpful?	1	2	3
Is the Table of Contents complete and useful?	1	2	3

Content

Do explanations enable readers to understand what to do?	1	2	3
--	---	---	---

Is everything accurate?	1	2	3
Are the main points properly stressed?	1	2	3
Are there sufficient examples?	1	2	3

Writing and Editing

Is the reading level appropriate to the audience?	1	2	3
Are the tone and style appropriate for the purpose and audience?	1	2	3
Is terminology consistent?	1	2	3
Are grammar, syntax, spelling, and punctuation correct?	1	2	3

Illustrations

Do the illustrations contribute to the usefulness of the document?	1	2	3
Are the illustrations effectively integrated into the text?	1	2	3

Layout and Design

Is the layout effective for the audience and purpose?	1	2	3
Is the overall design consistent and coherent?	1	2	3
Overall Document	1	2	3

Additional Comments

Which topics are not covered that you would like to see covered in the next revision?

Errors found in this manual

Page #	Description of Error
--------	----------------------

Name:

Company and Mailing Address:

Phone:

E-Mail:

Fax: