

Users Instructions and Customer Care Guide

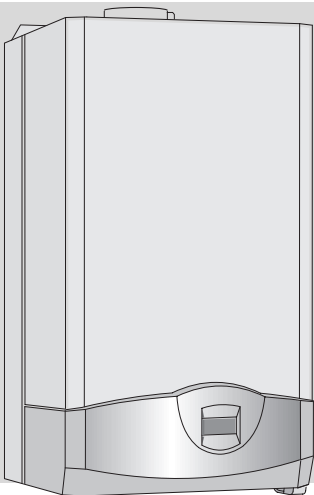

Greenstar HE plus combi Condensing boiler



6 720 610 598-00.10

ZWBR 7-28 HE plus GC-Number: 47 311 56

ZWBR 11-35 HE plus GC-Number: 47 311 57

benchmark

6 720 610 598 GB (01.07) OSW

**WORCESTER**
Bosch Group

Contents

| | |
|-------------------------------------|----------|
| Excellence comes as standard | 4 |
|-------------------------------------|----------|

| | |
|---------------------------|----------|
| Safety precautions | 5 |
|---------------------------|----------|

| | |
|------------------------|----------|
| 1 General notes | 7 |
|------------------------|----------|

| | |
|-------------------|-----------|
| 2 Controls | 10 |
|-------------------|-----------|

| | |
|---------------------------------------|-----------|
| 3 Operating the Appliance | 11 |
| 3.1 Preparation | 11 |
| 3.2 Switching the Appliance On/Off | 13 |
| 3.3 Switching on the Central Heating | 14 |
| 3.4 Controlling Central Heating | 14 |
| 3.5 Setting the Hot Water Temperature | 15 |
| 3.6 Summer Mode, Hot Water Only | 16 |
| 3.7 Frost protection | 16 |
| 3.8 Fault Condition | 17 |

| | |
|---|-----------|
| 4 Text Display | 18 |
| 4.1 General Description | 18 |
| 4.2 Programming | 18 |
| 4.2.1 Deleting a setting | 21 |
| 4.2.2 Resetting all parameters to their original settings | 21 |
| 4.3 Menu structure | 22 |
| 4.4 Setting the time/day | 23 |
| 4.4.1 Setting the time and day | 23 |
| 4.4.2 Holidays | 23 |
| 4.5 Heating | 24 |
| 4.5.1 Heating program | 24 |
| 4.5.2 Setting the Economy temperature | 25 |

| | | |
|-----------|---|-----------|
| 4.6 | Hot water | 26 |
| 4.6.1 | Hot water program | 26 |
| 4.6.2 | Hot water immediately | 26 |
| 4.7 | i Info | 27 |
| 4.8 | Settings | 28 |
| 4.8.1 | Heating (TR 2) | 28 |
| 4.8.2 | Service | 28 |
| 4.9 | Individual timer programmes | 30 |
| <hr/> | | |
| 5 | Fault finding | 31 |
| <hr/> | | |
| 6 | Tips on saving energy | 32 |
| <hr/> | | |
| 7 | General Information | 34 |
| <hr/> | | |
| 8 | Maintaining your appliance | 34 |
| <hr/> | | |
| 9 | Service centres | 35 |
| <hr/> | | |
| 10 | Fault or breakdown | 36 |
| <hr/> | | |
| 11 | Your Bosch guarantee | 37 |
| <hr/> | | |
| 12 | Guarantee registration | 38 |
| <hr/> | | |
| 13 | Operating Instructions Quick Reference | 40 |

Excellence comes as standard

Thank you for purchasing a Worcester Greenstar condensing appliance.

The Worcester Greenstar Series has been developed by the Bosch Group and the strictest quality control standards are demanded throughout every stage of production.

Indeed, the Bosch Group have led the field in innovative appliance design and performance for many years.

The result is that your new Greenstar appliance offers you the very best of everything – quality, efficiency, economical running costs, proven reliability and value for money.

What's more, you also have the assurance of our no nonsense 2 year parts and labour guarantee.

And it's backed up by Worcester Care Call a complete maintenance scheme to keep your boiler operating at peak condition and efficiency.

No wonder that more and more people are agreeing that when it is gas, it has to be a Worcester Condensing appliance.

Benchmark

The "Benchmark" initiative is the new code of practice to encourage the correct installation, commissioning and servicing of domestic central heating boilers and system equipment.

The "log-book" is a vital document that must be completed by the installer at the time of installation. It confirms that the boiler has been installed and commissioned according to the manufacturers instructions.

Without the completion of the "log-book", manufacturers may refuse to respond to a call-out from a householder, who will be advised that he or she must call back the installer, who has not fulfilled his obligations to record the information required by the initiative.

Safety precautions

Gas Safety (Installation and Use) Regulations 1998

It is the law that all gas appliances are installed by a competent person in accordance with the above regulations. Failure to install appliances correctly could lead to prosecution. It is in your interest, and that of safety, to ensure compliance with the law.

If you smell gas:

- ▶ Turn off gas service cock at the meter.
- ▶ Open all doors and windows.
- ▶ Do not operate any electrical switches.
- ▶ Do not smoke.
- ▶ Extinguish any naked flames.
- ▶ Call your gas company.

If you smell fumes from the appliance:

- ▶ Switch off appliance.
- ▶ Open windows and doors.
- ▶ Inform your heating engineer.

Fitting and modifications

- ▶ Fitting of the appliance or any modifications to the appliance may only be carried out by a competent person.
- ▶ Flue systems must not be modified in any way.

Maintenance

- ▶ We **recommend that you** take out a maintenance contract with a competent installer and have the appliance serviced at regular intervals.
- ▶ Ensure that your Service Engineer uses only genuine spare parts!

Safety precautions

Combustible materials

- ▶ Do not store or use any combustible materials (paper, thinners, paints etc.) in the vicinity of the appliance.

Health and safety

- ▶ This appliance contains no asbestos products.
- ▶ There is no potential hazard due to the appliance being electrically unsafe.
- ▶ There are no substances used in the construction that are a potential hazard in relation to the COSHH Regulations (Control of Substances Hazardous to Health Regulations 1988).

Combustion Air/Ambient Air

- ▶ Keep combustion air/ambient air free of corrosive substances (e. g. halogenated hydrocarbons which contain chlorine or fluorine compounds). In this way corrosion can be prevented.

1 General notes

To get the best from your appliance please read these instructions carefully.

Sealed heating systems

The appliance is fitted to a sealed heating system which is pre-pressurised. Your installer will tell you of the minimum and maximum pressure which must be indicated on the pressure gauge. Check regularly that the pressure is maintained and contact your installer or maintenance engineer if there is a permanent significant drop in the pressure. If the system loses pressure it should be repressurised and the cause of the fall investigated.

Central heating systems

During the first few hours of operation of the central heating system, check that all radiators are being heated at an even rate. If the top of a radiator is at a lower temperature than the bottom then it should be vented by releasing air through the venting screw at the top of the radiator. Ask your installer to show you how this is done. Repeated venting will reduce the quantity of water in the system and this must be replenished for safe and satisfactory operation of the appliance.

Should water leaks be found in the system or excessive venting is required then a service engineer must be contacted to inspect the installation and rectify any fault.

Only additives that are compatible with aluminium may be used in the system. Any incompatible additive used will invalidate the guarantee.

Condensate drain

This is a condensing appliance and the terminal will, at times, give out a plume of water vapour. This is quite normal.

The appliance produces quantities of condensate which is discharged regularly through the siphon.

General notes

Clearances

Your installer will have provided adequate space around the appliance for safety and servicing access. Do not restrict this space with the addition of cupboards, shelves etc. next to the appliance.

| | |
|---------------------------|--------|
| Left-hand side | 100 mm |
| Right-hand side | 100 mm |
| In Front | 600 mm |
| Above Casing (Vert. Flue) | 75 mm |
| Above Flue Turret | 30 mm |
| Below | 250 mm |

Table 1

Room thermostat

A room thermostat with volt free contacts (i.e. battery operated) may be fitted to control the central heating. Refer to the instructions supplied with the thermostat for information on siting and setting. A programmable thermostat may also be used with this appliance to provide additional timed control of the central heating.

Thermostatic radiator valves

It is recommended that this type of valve is fitted to all the radiators except one, usually the bathroom radiator. They should conform to the requirements of BS2767:10.

Showers, bidets, taps and mixing valves

Standard hot and cold taps and mixing valves must be suitable for operating at mains pressure. Thermostatically controlled or pressure equalising shower valves will guard against the flow of water at too high a temperature.

Hot and cold mains fed water can be supplied directly to an overrim flushing bidet subject to local water company requirements.

With all mains fed systems the flow of water from individual taps will vary with the number of outlets operated simultaneously and the cold water mains supply pressure to the property.

Flow balancing using “ball-o-fix” type valves is recommended to avoid an excessive reduction in flow to individual outlets.

For further information contact Worcester Heat Systems Technical Services Department.

Hot and cold flow

The flow of water demanded from both hot and cold service outlets is dependent upon the mains supply, it may not be possible in some installations to operate all outlets simultaneously.

Water mains failure

If there is a failure of the mains water supply then no water will be available at a tap or shower until the mains supply is restored. The appliance will still operate in the central heating mode.

Use in hard water areas

In exceptionally hard water areas a device to prevent scale formation may be fitted. Installation of a scale inhibitor assembly should be in accordance with the requirements of the local water company. An isolating valve should be fitted to allow for servicing.

Alternatively the maximum temperature of the domestic hot water may be reset to about 45 °C which will reduce the risk of scale formation in these hard water areas.

Ventilation

This is a room sealed appliance and does not require any air for combustion from inside the house. If the appliance is fitted into a cupboard or a compartment is built around the appliance after installation then the compartment must be separated from the boiler space by a perforated non-combustible partition as described in BS6798:87.

Notwithstanding the requirements of BS6798:87, there is no need for ventilation openings to be provided in the compartment because of the low heat loss from the casing.

Do not allow the flue terminal fitted on the outside wall to become obstructed or damaged.

Pump

The pump will have been set by the manufacturer and must not be manually re-adjusted.

2 Controls

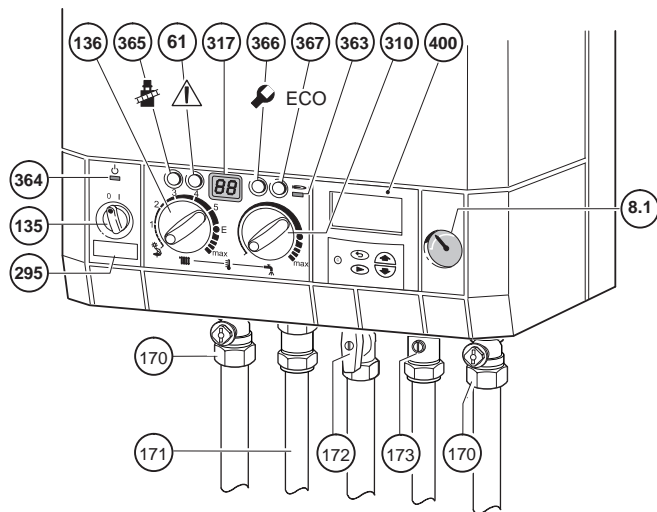

6 720 610 598-01.10

Fig. 1

- 8.1** System Pressure gauge
- 61** Reset button
- 135** Master switch
- 136** Central heating temperature control
- 170** Service valves in CH flow and return
- 171** Hot water
- 172** Gas isolation valve (open)
- 173** Cold water inlet
- 295** Identification sticker
- 310** Hot water temperature control
- 317** Display
- 363** Indicator lamp for "burner on"
- 364** Indicator lamp for "off/on"
- 365** "Chimney sweep" button
- 366** Service button
- 367** "ECO" button
- 400** Text Display

3 Operating the Appliance

3.1 Preparation

Turn on the gas cock (172).

- ▶ Press in the handle and turn it anti-clockwise as far as the stop (when handle is in line with direction of flow, the cock is open).

Central heating system valves (170)

- ▶ Using a spanner, turn square nut until groove is in line with direction of flow (see detail).
Groove at right angles to direction of flow = off.

Cold water inlet valve (173)

- ▶ Turn handle so that it is in line with direction of flow.
When handle is at right angles to direction of flow, the valve is closed.

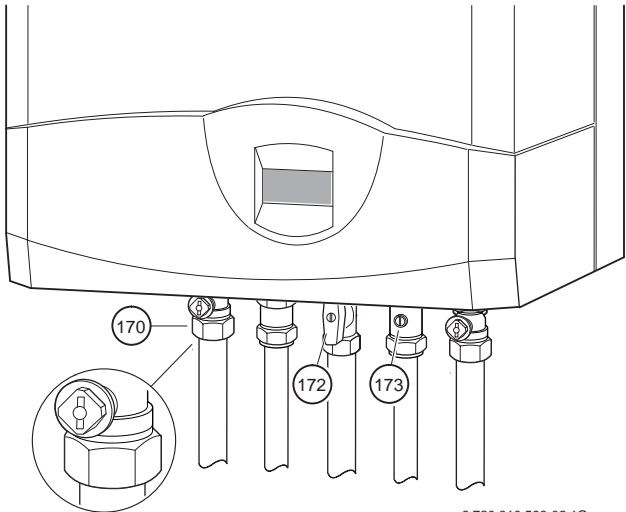

6 720 610 598-02.10

Fig. 2

Operating the Appliance

Check the central heating system pressure

- ▶ The pointer on the pressure gauge (8.1) should be about 1 bar.
- ▶ If the pointer is below 1 bar (when the system is cold), top up the system with water until the pointer is 1 bar. Your installer will have shown you how to do this.
- ▶ The **maximum operating pressure** of 2.5 bar at maximum central heating flow temperature must not be exceeded. If the pressure increases to 3 bar then the relief valve (15) opens.

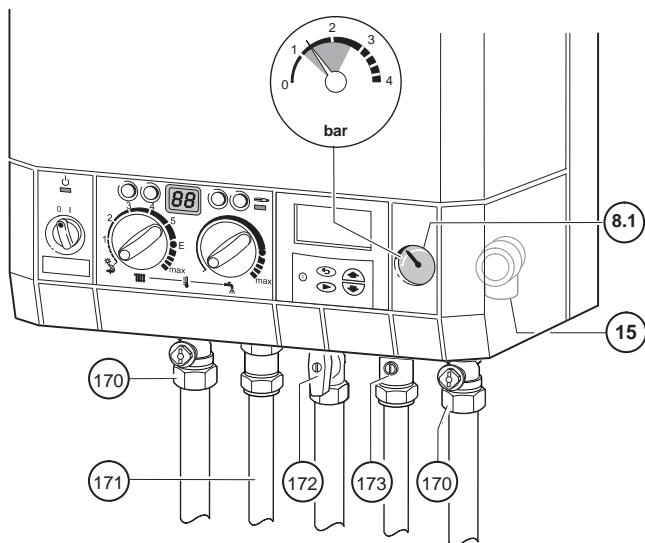

6 720 610 598-03.10

Fig. 3

3.2 Switching the Appliance On/Off

Switching on

- ▶ Switch on the appliance at the master switch (**I**).
The indicator lamp shows green and the display will show the central heating flow temperature, when the appliance is operating in the central heating mode.

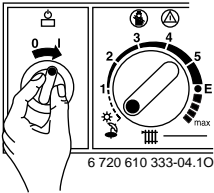

Fig. 4



If the display alternates between **-||-** and the central heating flow temperature, the trap filling programme is active.

The trap filling programme ensures that the condensation trap is filled after the appliance has been installed or after the appliance has been out of use for a long period. For that reason, the appliance remains at minimum heating output for 15 minutes.

Switching off

- ▶ Switch off the appliance at the master switch (**0**).
The green indicator lamp goes out. The optional timer will continue running until the emergency supply is exhausted.

3.3 Switching on the Central Heating

- ▶ Turn the central heating temperature control  to the desired level:
 - “**Min**” setting: 35 °C
 - Low-temperature heating: setting “**E**” (approx. 75 °C)
 - “**Max**” setting: 88 °C

When the burner is lit, the **red** indicator lamp is illuminated.

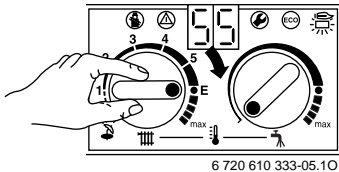



Fig. 5

3.4 Controlling Central Heating

- ▶ Set room thermostat to the desired room temperature.
- ▶ Set outside- temperature driven control unit, if fitted. Refer to the instructions with the control.
- ▶ Set the thermostatic radiator valves to the desired settings.

3.5 Setting the Hot Water Temperature

Hot water temperature

The hot water temperature can be set to between approx. 40 °C and 60 °C using the temperature control .

The domestic hot water temperature is not shown on the display.

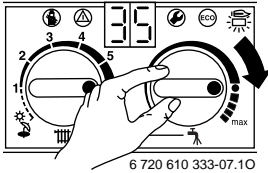

Fig. 6

| Control Setting | Water Temperature |
|----------------------|-------------------|
| Anti-clockwise limit | approx. 40 °C |
| ● | approx. 55 °C |
| Clockwise limit | approx. 60 °C |

Table 2

“ECO” button

By pressing and holding the “ECO” button , until the display lights, you can switch between **Comfort mode** and **Economy mode**.

Comfort mode: button is not lit (factory setting)

The appliance is held constantly at the set temperature. This means that hot water is available almost instantaneously at the tap. Consequently the appliance will switch on at intervals, even if no hot water is being drawn.

Operating the Appliance

ECO mode with demand detection, button is lit

The demand detection function enables maximum gas and water economy.

Briefly turning a hot water tap on and then off again signals demand to the appliance which then heats up the water to the set temperature.

Hot water is thus available in about 1 minute.

ECO mode, button is lit

Water is not heated up until hot water is drawn. This means that there is a longer waiting period before hot water is available.

3.6 Summer Mode, Hot Water Only

With room thermostat

- ▶ Turn temperature control  on the appliance anti-clockwise as far as the stop.

The central heating is now turned off. The hot water function and the mains power supply for the heating programmer and timer remain switched on.

3.7 Frost protection

- ▶ Leave master switch switched on.

If the appliance is to be left for long periods switch the central heating off:

- ▶ Add a suitable anti-freeze fluid to the water in the central heating system.

Suitable products are available from Betz-Dearborn Tel.: 0151 4209563 and Fernox Tel.: 01799 550811.

3.8 Fault Condition

In the unlikely event of a fault occurring while the appliance is in operation:

The display and the text display then shows a fault code and the button  may also flash.

If the button  flashes:

- ▶ Press and hold the button  until the display shows “- -”.
The appliance will then start up again and the display will show the central heating flow temperature.

If the button  does not flash:

- ▶ Switch the appliance off and then on again at the master switch.
The appliance will start up again and the central heating flow temperature will be displayed.

If the fault remains and can not be cleared:

- ▶ Call your approved installer or Greenstar Customer Service for assistance, giving a description of the fault and, if possible, the fault code from the facia display.

4 Text Display

4.1 General Description

- The text display is used to display information about the appliance and the system and to alter the settings displayed.
- Once the appliance has been in operation for one day, the text display module has a power buffer period of about 10 hours during which it will run without the mains power supply. After that period has elapsed, the clock function shuts down but all other settings are retained.

4.2 Programming

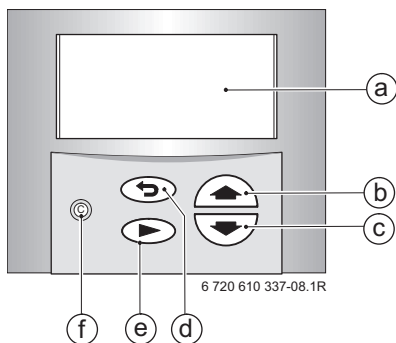

Fig. 7 Controls

- a** Display
- b** "Up"/"More" button
- c** "Down"/"Less" button
- d** "Back" button
- e** "Next" button
- f** "Delete" button

The standard display shows the following information:

- Time
- Room temperature (if TR 2 connected)
- CH flow temperature.

Additional indication if a special programme is active:

- x holidays
- Hot water immediately.

Other special operating modes may be displayed during commissioning, servicing, etc.

The programming procedure is described in detail below **using the clock** function as an example:

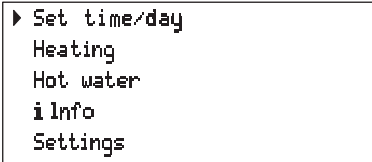

- ▶ To start programming, press any button, e. g. .
The display lighting switches on and the main menu is displayed:



```
▶ Set time/day
  Heating
  Hot water
  i l n f o
  Settings
```

6 720 610 598-04.10

Fig. 8 *Main menu*

- ▶ Use the  or  button to move the cursor arrow on the left of the menu so that it points to the desired menu item.
In this example, the cursor is positioned next to the menu item **Set time/day**.
- ▶ Confirm the selection by pressing the  button.
The corresponding submenu is displayed:

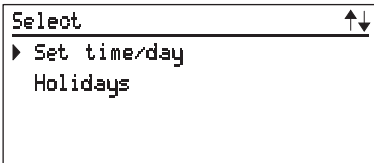



```
Select ↑↓
▶ Set time/day
  Holidays
```

6 720 610 598-05.10

Fig. 9 *Submenu: Set time/day*

Text Display

In the submenus, the top line indicates what action is required. The bottom line shows the previous menu level, if applicable (see Fig. 10).



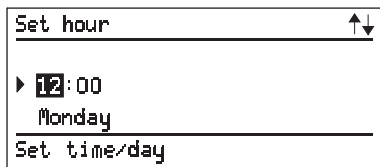





- ▶ Use the  or  button to select **Set time/day**.
- ▶ Confirm the selection by pressing the  button. The corresponding submenu is displayed:



6 720 610 598-06.10

Fig. 10 *Setting the hour*

When settings are being entered, the setting to be altered is indicated on the top line. In addition, the setting being altered is displayed with a dark background.

- ▶ Use the  or  button to set the hour.
 - Press and release to change the display by one unit at a time
 - Press and hold to change the display rapidly
- ▶ Confirm the setting by pressing the .
- ▶ Use the  or  button to set the minutes.
- ▶ Confirm the setting by pressing the .
- ▶ Use the  or  button to set the day of the week.
- ▶ Press the  button to confirm the setting. The cursor then returns to the top line.

-or-

- ▶ Press the  button to confirm the setting and return to the previous menu (Fig. 9 page 19).

-or-

- ▶ Do not press any other buttons for 15 minutes.

4.2.1 Deleting a setting

Either overwrite the setting or press the  button to delete it.

- ▶ Find the setting to be deleted.
- ▶ Press and release the  button.
The display shows --:--

4.2.2 Resetting all parameters to their original settings.



The hours of service can not be reset to 0.

- ▶ Press and hold the  button for more than 15 seconds.
After about 5 seconds, the following message appears on the display:

ATTENTION

**Delete all parameters
in x seconds**

Once the reset has been completed, the following message is displayed:

Please wait... Initialising

4.3 Menu structure

| Main menu | Submenu | | | Parameters to change/select | Page |
|--------------|-----------------------------------|------------------------|----|--|-----------------|
| | 1. | 2. | 3. | | |
| Set hour/day | Set hour/day | - | - | - Hours - Minutes - Day of week | 23 |
| | Holidays | - | - | Days holiday | 23 |
| Heating | Heating program | - | - | - Day - 1st operating mode - 1st switching point ... - 6th switching point | 24 |
| | Set economy temp. | - | - | 5...30 °C | 25 |
| Hot water | Hot water program | - | - | - Day - 1st operating mode - 1st switching point ... - 6th switching point | 26 |
| | Hot water immediately | - | - | Off/On | 26 |
| Info | - | - | - | - | 27 |
| Settings | Heating | - | - | Optimum Start Off/On | 28 |
| | Service | Display service param. | - | - | 28 |
| | | | | | Further options |
| | -Time correction -LCD contrast | 28 29 | | | |
| | Operating times | - | 29 | | |
| | Fault history | - | 29 | | |

4.4 Setting the time/day

4.4.1 Setting the time and day

For details of how to set the time and day, refer to page 19.





Changing winter and summer time:

- ▶ Only adjust the clock! Do not alter the switching points (for heating, economy, etc.).
-

4.4.2 Holidays

In the Holiday programme, the central heating runs in Economy mode and the hot water is switched off (frost protection function remains active).

- ▶ From the main menu, select **Set time/day**, and from the first submenu select **Holidays**.
 - ▶ Enter the number of days holiday by pressing  or  (max. 99 days holiday).
After the set number of days, the text display module automatically cancels Economy mode at midnight on the last day and returns to Automatic mode.
-



The day on which you enter the days holiday counts as the first day of the holiday, i.e. the unit starts the holiday program immediately. Only include the day on which you are returning if you **don't** want the heating to return to the normal program on that day!

To cancel Holiday mode early:

- ▶ In the **Holidays** submenu:
Press the  button until the display shows **0**.

4.5 Heating

4.5.1 Heating program

Basic setting (Automatic mode)



- The appliance switches automatically between normal heating, Economy mode and Frost protection mode according to the timer settings entered.
- Heating mode (=“Day”): the text display module controls the system according to the temperature set for Heating mode (**On (Comfort)**) (Heating curve).
- Economy mode (= “Night”): the text display module controls the system according to the temperature set for Economy mode (**Off (Economy)**) (Reduced-temperature heating curve).
- Basic setting:
 - Heating starts at 6:00 am
 - Economy starts at 10:00 pm

Setting options

- Maximum of six switching points per day with three different operating modes (Heating, Economy, Frost protection).
- Same times for Monday to Friday.
- Same times for Saturday and Sunday.
- Different times for every day.

Setting switching times and operating mode

- ▶ From the main menu select **Heating** and then from the first submenu, select **Heating program**.
- ▶ Select Monday - Friday, Saturday and Sunday or an individual day of the week.
 - **Monday - Friday:** to have “Heating” and “Economy” or “Frost protection” switching on at the same times every weekday.

- **Saturday - Sunday**: to have "Heating" and "Economy" or "Frost protection" switching on at the same times Saturday and Sunday.
- Individual day of the week (e. g. **Thursday**): to have the relevant program always switching on at the specified time on that day of the week, i.e. "Heating", "Economy" or "Frost protection" at the same time every Thursday.
- ▶ Press . The display shows **Set 1. operating mode**.
- ▶ Set the desired first operating mode (Heating, Economy or Frost protection).
- ▶ Press . The display shows **Set 1. time period**.
- ▶ Set the desired first time period.
- ▶ Press . Set the following operating modes and time periods as described for the first.
- ▶ If necessary: select the next day and enter the operating modes and timer periods as described above.



If the settings for a particular day of the week are different from the settings for the other days, then if **Monday -Friday or Saturday and Sunday** is selected, the display shows **--:--**, i.e. there are no common switching points for those options.



Timer periods and operating modes are you do not wish to change can be skipped by pressing .

4.5.2 Setting the Economy temperature

This option allows you to set the room temperature for Economy mode (**Off (Economy)**).

This function is only active if:

- Automatic mode or Economy mode is set on the TR 2 room thermostat.

- ▶ From the main menu, select **Heating** and then from the first submenu, select **Set Economy temp..**
- ▶ Use the  or  button to set a temperature between 5 and 30 °C.

4.6 Hot water



General description

- The basic settings provide a straightforward timer programme: enabled from 5:00 am, disabled from 10:00 pm. The ECO button must not be lit (Comfort mode).

4.6.1 Hot water program

- Up to six switching points per day can be set.
- There are two operating modes: Blocked and Released.
- ▶ From the main menu, select **Hot water** and then from the first submenu, select **Hot water program**.
- ▶ Set the days of the week, Blocked/Released (operating mode) in the same way as for the switching points and modes for heating as described on page 24.

4.6.2 Hot water immediately

- **Hot water immediately ON:**
 - Comfort mode is active for 2 hours.
- **Comfort mode is active for 2 hours:** normal automatic program (Hot water mode according to timer programme entered).
- ▶ From the main menu, select **Hot water** and then from the first submenu, select **Hot water immediately**.
- ▶ Press  or  to switch **Hot water immediately** on or off.

4.7 i Info

- Select **Info** from the main menu.



You can view the following information:

| Display text | Description |
|--|---|
| Room temperature (if TR 2 connected) | Current temperature in the room where TR 2 is installed |
| Required room temperature (if TR 2 connected) | Required temperature in room where TR 2 is installed |
| Operating mode (if TR 2 connected) | E. g. Heating, Economy in Automatic mode or Economy, Heating, Frost protection in manual mode |
| Max. flow temp. | Maximum CH flow temperature set on the temperature control for CH flow |
| Actual flow temp. | Actual CH flow temperature |
| Required flow temp. | Required CH flow temperature |
| Max HW temp. | Maximum permissible hot water outflow temperature |
| Required HW temp. | Required hot water temperature |
| Actual HW temp. | Actual hot water outflow temperature |
| Boiler operat. mode winter/ summer | Indicates which mode the CH flow temperature control is set to |
| Burner on/off | Indicates whether the burner is alight or not |
| Pump on/off | Indicates whether the integral pump is switched on or off |

4.8 Settings

4.8.1 Heating (TR 2)

Optimum Start

- ▶ From the main menu, select **Settings** and from the first sub-menu, select **Heating**.
- ▶ Press  or  to switch Optimum Start on or off.

4.8.2 Service



Displaying service functions

This option displays various current settings and statuses of the electrically controlled appliance and system components for the benefit of the heating engineer.

Service parameters

Language







Available languages are: English, Français (French), Deutsch (German).

- ▶ From the main menu, select **Settings**, from the first submenu select **Service**, from the Second submenu select **Further options**, and from the third submenu select **Language**.
- ▶ Press  or  to select the desired language.

Two other supplementary functions can be selected from the third submenu Language:







- Time correction
- LCD contrast.

Time correction:

- ▶ Press and hold the  button (about 5 seconds) until the display shows **Time correction and LCD contrast**.
- ▶ Press  or  to select **Time correction**.
- ▶ Press the  button. The display shows **Change value**.
- ▶ Press  or  to set the number of seconds in 24 hours.

Basic setting: “+ 0 s”

LCD contrast:

- ▶ Press and hold the  button (about 5 seconds) until the display shows **Time correction and LCD contrast**.
- ▶ Press  or  to select **LCD contrast**.
- ▶ Press the  button. The display shows **Change value**.
- ▶ Press  or  to adjust the **LCD contrast**.

Basic setting: e. g. “47”

Operating times

This option shows the hours of service (appliance, burner and hot water) since commissioning.

- ▶ From the main menu, select **Settings**, from the first submenu select **Service**, from the Second submenu select **Further options**, and from the third submenu select **Operating times**.

Fault history

This option displays any faults that have occurred for the information of the service engineer. The first fault displayed may still be active. Any other faults displayed are no longer active.

- ▶ From the main menu, select **Settings**, from the first submenu select **Service**, from the Second submenu select **Further options**, and from the third submenu select **Fault history**.

4.9 Individual timer programmes

| Heating periods for central heating | | | | | | | | | | | | |
|-------------------------------------|----------------|------|----------------|------|----------------|------|----------------|------|----------------|------|----------------|------|
| Switching point | 1. | | 2. | | 3. | | 4. | | 5. | | 6. | |
| Status | Operating mode | Time | Operating mode | Time | Operating mode | Time | Operating mode | Time | Operating mode | Time | Operating mode | Time |
| Monday | | | | | | | | | | | | |
| Tuesday | | | | | | | | | | | | |
| Wednesday | | | | | | | | | | | | |
| Thursday | | | | | | | | | | | | |
| Friday | | | | | | | | | | | | |
| Saturday | | | | | | | | | | | | |
| Sunday | | | | | | | | | | | | |

| Enable/disable hot water function | | | | | | | | | | | | |
|-----------------------------------|----------------|------|----------------|------|----------------|------|----------------|------|----------------|------|----------------|------|
| Switching point | 1. | | 2. | | 3. | | 4. | | 5. | | 6. | |
| Status | Operating mode | Time | Operating mode | Time | Operating mode | Time | Operating mode | Time | Operating mode | Time | Operating mode | Time |
| Monday | | | | | | | | | | | | |
| Tuesday | | | | | | | | | | | | |
| Wednesday | | | | | | | | | | | | |
| Thursday | | | | | | | | | | | | |
| Friday | | | | | | | | | | | | |
| Saturday | | | | | | | | | | | | |
| Sunday | | | | | | | | | | | | |

5 Fault finding

| Problem | Cause | Remedy |
|---|---|---|
| Desired room temperature is not reached | Thermostatic valve(s) set too low | Increase thermostatic valve setting(s) |
| | Temperature control for CH flow set too low | Increase CH flow temperature control setting |
| | Air trapped in heating system | Bleed radiators and heating system |
| Desired room temperature exceeded by large amount | Radiators are too hot | Turn down thermostatic valves |
| Temperature rises instead of falling | Clock is incorrectly set | Check setting |
| Room temperature too high in Economy mode | Building retains heat well | Start Economy mode sooner |
| No display or display unit does not respond | Momentary power failure | Switch off appliance at master switch, wait a few seconds and switch on again |

6 Tips on saving energy

Heating economically

The boiler is designed to provide a high level of comfort while keeping gas consumption and the resulting environmental effect as low as possible. The gas supply to the burner is controlled according to the level of demand for heat. The boiler continues to operate with a low flame if the demand for heat reduces. The technical term for this process is modulating control. Modulating control keeps temperature fluctuations small and provides even distribution of heat throughout the home. This means that the boiler may stay on for relatively long periods but will use less gas than an appliance that continually switches on and off.

Central heating systems with room thermostats/thermostatic radiator valves

The central heating control on the boiler should be set to the maximum rated temperature of the central heating system or to position "E", when the maximum central heating water temperature obtained is 75 °C.

The temperature can be set individually in each room (except primary room with the room thermostat) using the thermostatic radiator valves. If you wish to have a lower temperature in the primary room than in the other rooms, leave the room thermostat at the set temperature and turn down the radiator using the radiator valve.

Reduced-output operation

Considerable fuel savings can be made by slightly reducing the room temperature. Lowering the temperature by 1 °C can bring about energy savings of up to 5 %. However, it is not advisable to allow the room temperature to fall below +15 °C. The room temperature for reduced-output mode can be set separately on the room thermostat. Instructions are given in the control unit operating instructions.

Hot water

A lower setting on the hot water temperature control can result in considerable energy savings.

The **on-demand activation** using the ECO-button makes possible the maximum savings of gas and water.

Now you know how to heat your home economically with the Greenstar gas condensing boiler. If you have any other questions, please contact your installer – or write to us.

7 General Information

Cleaning the Outer Case

Wipe down the outer case with a damp cloth. Do not use abrasive or caustic cleaning agents.

Appliance details

If you ever need to call Greenstar Customer Service it helps us a great deal if you can provide precise details of your appliance.

The information is printed on the appliance identification plate/sticker (see page 10, item 295).

Your installer will have completed the Benchmark “log-book” giving details of the boiler together with name, address and registration number. Have the “log-book” to hand when calling a Service Engineer.

8 Maintaining your appliance

Your new Worcester Greenstar gas-fired appliance represents a long-term investment in a reliable, high quality product.

In order to realise its maximum working life, and to ensure it continues to operate at peak efficiency and performance, it is essential that your boiler receives regular, competent servicing and maintenance checks beyond the initial 2 year guarantee period.

Regular service contracts can be arranged with your installer – however if you have difficulty making a satisfactory arrangement simply contact Worcester Heat Systems on 08705 256206 for help.

If you would like to know more about Worcester’s extended warranty options please tick the appropriate box on your warranty registration card.

9 Service centres

| Region | Telephone | Fax | Operating Hours (Mon-Fr) | Operating Hours (Sat) |
|------------------|-------------------------|-------------------|--------------------------|--------------------------|
| Sc Scotland | 08705 256206 | (01506) 441687 | 8.00 am TO 6.00 pm | 8.30 am TO 1.00 pm |
| NW North West | | (01625) 614308 | | |
| E Eastern | | | | |
| W Western | | (01905) 757536 | | |
| SE South | | | | |
| SW South | | | | |

Table 3

We have Service Centres situated throughout the country. If you have a service request simply call our local rate number above and your request will be routed to your Regional Service Centre.

10 Fault or breakdown

This product is supported in the UK by Worcester Heat Systems Ltd. – part of the Bosch Group.

A specialist factory trained field SERVICE ENGINEER is available to attend a breakdown or manufacturing fault occurring on this appliance.

No charge will be made for parts and/or labour providing:

- An appliance fault is found and the appliance has been installed within the past 24 months. Reasonable evidence of this must be supplied on request.
- 2nd year warranty is dependent on annual servicing.

A call-out charge will be made where:

- The appliance has been installed for over 24 months.
OR
- Our Field Service Engineer finds no fault with the appliance (see **NOTE**).
OR
- The cause of breakdown is misuse or with other parts of your plumbing/heating system, or with equipment not supplied by Worcester.

NOTE: No appliance fault is found on over 30 % of all service call outs.

If in doubt contact our Technical Helpline on 08705 266241.

IN THE EVENT OF AN APPLIANCE FAULT OR BREAK-DOWN please contact your Service Centre (see over). Your service administrator will arrange for an engineer to call with the minimum of delay; under normal circumstances this will be within the period 1-3 working days (excluding weekends) for priority breakdown situations (no hot water and/or heating service).

INVOICES FOR ATTENDANCE AND REPAIR WORK CARRIED OUT ON THIS APPLIANCE BY ANY THIRD PARTY WILL NOT BE ACCEPTED.

11 Your Bosch guarantee

This appliance is guaranteed against faulty material or workmanship for a period of 24 calendar months from the date of installation subject to the following conditions and exceptions.

- That during the currency of this guarantee any components of the unit which are proved to be faulty or defective in manufacture will be exchanged or repaired free of material charges and free of labour charges by Worcester Heat Systems Limited.
- That the householder may be asked to prove the date of installation, that the appliance was correctly commissioned and, where appropriate, the first 2 year service has been carried out to the satisfaction of Worcester Heat Systems Limited when requested.
- That any product or part thereof returned for servicing under the guarantee any components of the unit which are proved to be faulty guarantee must be accompanied by a claim stating the Model, Serial Number, Date of Installation.
- That Worcester Heat Systems Limited will not accept responsibility for damage caused by faulty installation, neglect, misuse or accidental damage, the non observance of the instructions contained in the Installation and Users Instructions Leaflets.
- That the appliance has been used only for normal domestic purposes for which it was designed.
- That this guarantee applies only to equipment purchased and used in Great Britain.

This guarantee is given in addition to all your normal statutory rights.

12 Guarantee registration

You should complete and return the postpaid Guarantee Registration Card within 14 days of purchase.

The card will register you as the owner of your new Worcester Greenstar appliance and will assist us in maintaining an effective and efficient customer service by establishing a reference and permanent record for your boiler.

This will not affect your statutory rights in any way.

Important:

For your own record:

Model

.....

Serial number:.....

(See identity label inside appliance casing)

Type/size:.....

Date of installation:.....

Check that the Benchmark “log-book” has been completed by your installer or service engineer.

EXCELLENCE COMES AS STANDARD

**Worcester Heat Systems Limited. Cotswold Way, Warn-
don, Worcester WR4 9SW.**

Telephone: (01905) 754624 Fax: (01905) 754619

SERIAL NUMBER. Copy the number off the Guarantee Card.

Notice

13 Operating Instructions Quick Reference

Switching on

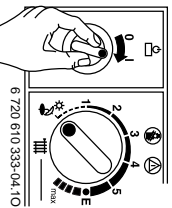

Switching the central heating on

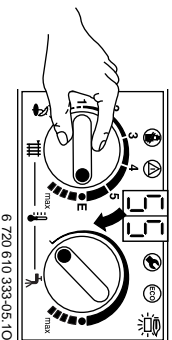

Text Display

Set switching times and operating mode within the text display.

Hot water temperature

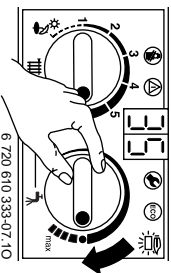

“ECO”-button lit –

Economy mode.

“ECO”-button not lit –

Comfort mode

Fault Condition

Refer to page 17.

Switching off

