

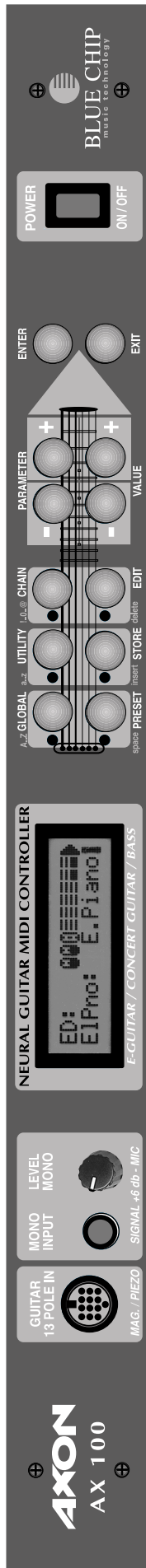


BLUE CHIP
music technology

USERS MANUAL

AXON AX-100

AXON AX-100 SB



2. Edition
April 1999

Table of Contents

| | |
|--|-----------|
| Accessories AX-100 / AX-100SB | 5 |
| AXON Setup | 6 |
| Front Panel AX-100 | 7 |
| Rear Panel AX-100 | 8 |
| About the AXON AX 100 (-SB) | 9 |
| Quickstart | 10 |
| Basic Settings | 10 |
| Changing a preset sound | 12 |
| About the User Interface of your AXON | 14 |
| The Four AXON Modes of operation | 15 |
| GLOBAL MODE | 15 |
| PRESET MODE | 15 |
| UTILITY MODE | 15 |
| CHAIN MODE | 15 |
| GLOBAL MODE | 16 |
| Global Parameters | 16 |
| BASIC CHANNEL | 16 |
| HOLD CHANNEL | 16 |
| SEQ CHANNEL | 17 |
| PBEND RANGE | 17 |
| SND PBENDRG | 17 |
| LOCAL MODE | 18 |
| TUNE BASE | 18 |
| GUITAR NO... | 19 |
| TYP | 19 |
| PICKUP | 19 |
| NOTE OFF LIM | 20 |
| TRIG. LEVEL | 20 |
| SENSE | 20 |
| PAN ENABLE | 21 |
| REV ENABLE | 21 |
| CHOR ENABLE | 21 |
| VAR ENABLE | 21 |
| CC DEFAULTS... | 22 |
| PRESET MODE | 23 |
| Preset Parameters | 23 |
| Recalling Presets | 23 |
| Guitar Tuner | 23 |
| PRESET PROGRAMMING | 24 |
| String Split | 24 |
| Fret Split | 24 |
| Pick Split | 24 |
| Split Combinations | 24 |
| Selecting Split Zones | 25 |
| Changing the Split Parameters | 25 |
| Choose Instrument | 26 |
| BANK MSB / BANK LSB | 26 |
| VOLUME | 26 |
| TRANSPOSE | 26 |
| QUANTIZE | 26 |
| PAN POS | 27 |

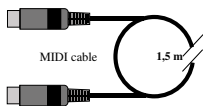
| | |
|--|-----------|
| PAN SPREAD | 28 |
| REVERB | 28 |
| CHORUS | 28 |
| VARIATION | 28 |
| VEL SENSE | 28 |
| VEL OFFSET | 29 |
| PICK CONTROL... .. | 29 |
| PICK VAL1 | 29 |
| PICK VAL2 | 29 |
| Diagram Velocity Mapping | 30 |
| Changing split-common Parameters | 31 |
| Preset Name | 31 |
| STRING MODE | 32 |
| HOLDMD | 32 |
| COMMON | 32 |
| SEP... .. | 32 |
| HOLD PRESET | 33 |
| VOLUME: | 33 |
| SEQ PATTERN | 33 |
| SEQ TRACK | 33 |
| SEQ TEMPO | 34 |
| LAYER... .. | 34 |
| LAYER PRESET | 34 |
| SEQ PATTERN | 34 |
| SEQ TRACK | 34 |
| SEQ TEMPO | 35 |
| ARPEG... .. | 35 |
| ARPEG PRESET | 35 |
| TEMPO | 35 |
| LENGTH | 36 |
| SCAN | 36 |
| PATTERN | 36 |
| SYNC | 38 |
| OCTAVES | 38 |
| REPEATS | 38 |
| VELOCITY | 39 |
| SEQ PATTERN | 39 |
| SEQ TRACK | 39 |
| Editing HOLD Presets | 40 |
| CNTRL... .. | 40 |
| HOLD CONTROLLER | 40 |
| SEQ PATTERN | 40 |
| SEQ TRACK | 41 |
| SEQ TEMPO | 41 |
| STACK... .. | 41 |
| WHEELCNTL... .. | 41 |
| NRPN/RPN... .. | 42 |
| FINGER PICK | 43 |
| STRING SPLIT | 43 |
| FRET SPLIT | 43 |
| PICK SPLIT 1 and 2 | 44 |
| REV | 44 |
| CHOR | 44 |
| VAR | 44 |


| | |
|---|-----------|
| Chain Mode | 45 |
| Creating Chain Presets | 45 |
| CHAIN PRESET NAME | 45 |
| PROGRAM | 45 |
| STEP | 46 |
| Saving Chain Presets | 46 |
| UTILITY MODE | 47 |
| Utility Parameters | 47 |
| DISPLAY | 47 |
| PRESET NAMES | 48 |
| DCLIC RESPNS | 48 |
| XMIT SYSEX... | 49 |
| RECEIVE SYSEX | 50 |
| EDIT SEQUENCE... | 50 |
| TEMPO | 50 |
| VOLUME | 50 |
| REVERB SEND | 51 |
| CHORUS SEND | 51 |
| VARIAT SEND | 51 |
| MODE | 51 |
| PATTERN... | 51 |
| TRACK... | 52 |
| EDIT REVERB... | 54 |
| REVERB TYPES | 54 |
| Reverb Parameters | 55 |
| GLOBAL REVERB PARAMETERS | 55 |
| EDIT CHORUS... | 56 |
| CHORUS TYPES | 56 |
| Chorus parameters | 57 |
| GLOBAL CHORUS PARAMETERS | 57 |
| EDIT VARIAT | 58 |
| VARIATIONS EFFECT TYPES | 58 |
| Variations Effect Parameters | 61 |
| GLOBALE VARIATIONSPARAMETER | 66 |
| ADC MONITOR | 67 |
| Appendix | 68 |
| Factory Presets | 68 |
| Problem Solving | 76 |
| External MIDI instrument doesn't play | 76 |
| String bending does not function properly..... | 76 |
| Sometimes wrong notes | 76 |
| Varying string volume levels | 77 |
| Dynamic difference between notes is too great | 77 |
| Wrong sounds | 77 |
| SYSTEM EXCLUSIVE IMPLEMENTATION | 78 |
| Parameter Overview Global | 80 |
| Parameter Overview Chain | 81 |
| Parameter Overview Global | 81 |
| Parameter Overview Utility | 82 |
| Midi Implementation Chart | 83 |

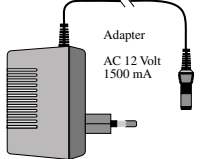
Accessories AX-100 / AX-100SB



Standard Accessories AXON AX-100

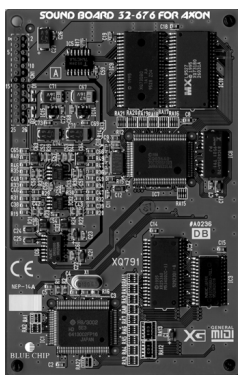
- 

MIDI cable 1,5 m (5')
- 

Footswitch for Hold / Chain function
- 

Power adapter 115 V or 230 V
- User manual

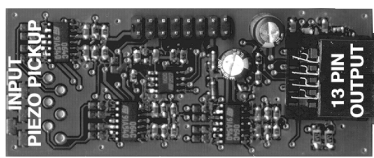
Optional accessories available for the AXON AX-100



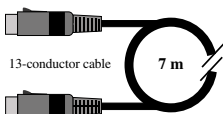
Sound card SB-676
GM / XG sound card with 480 sounds, 11 reverbs, 41 effects..



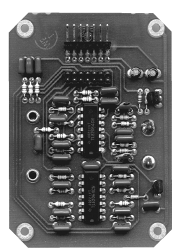
Piezo Pickup
Hex piezo pickup for acoustic guitars



AIX-110
Interface board for piezo pickup



13-conductor cable AXK-100
length 7 m (23 foot)



AIX-210
Interface board for the Godin guitar "Multiac"



AIX-101
Interface for any guitar with 6 steel strings.



AFS-100
Swell pedal for control function of the AX-100. (filter, volume, panorama, etc.)



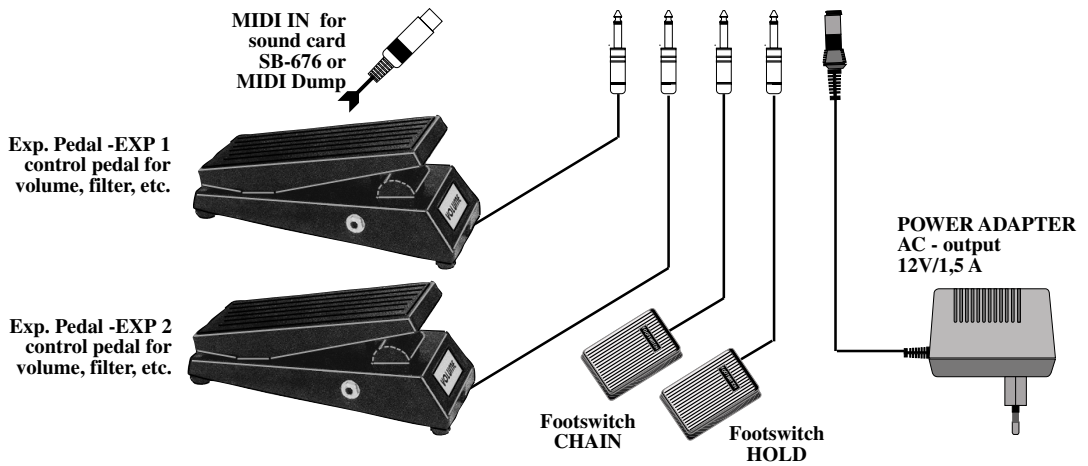
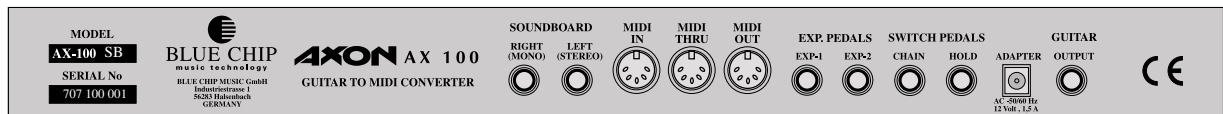
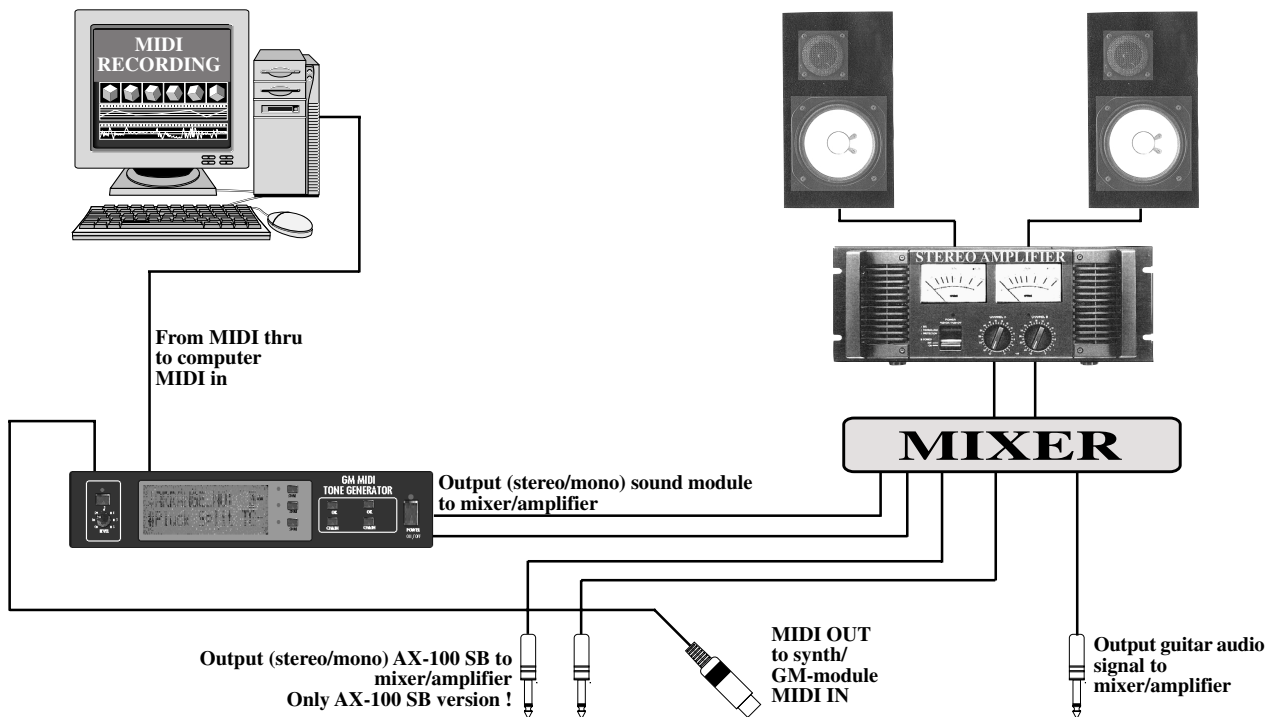
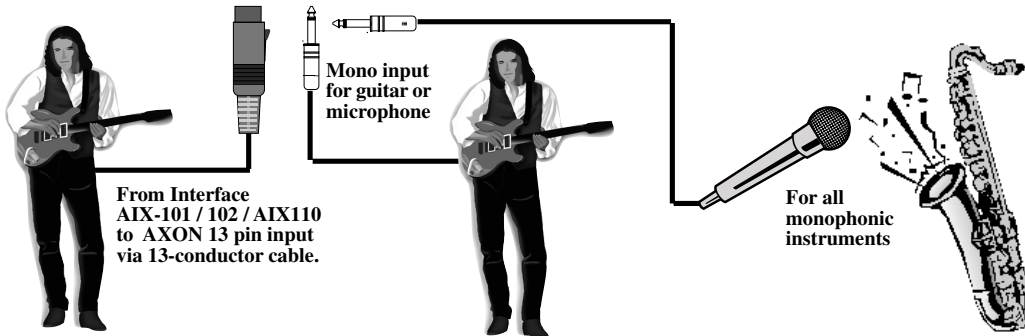
AIX-102
Interface for Bass guitar with 4 steel strings.



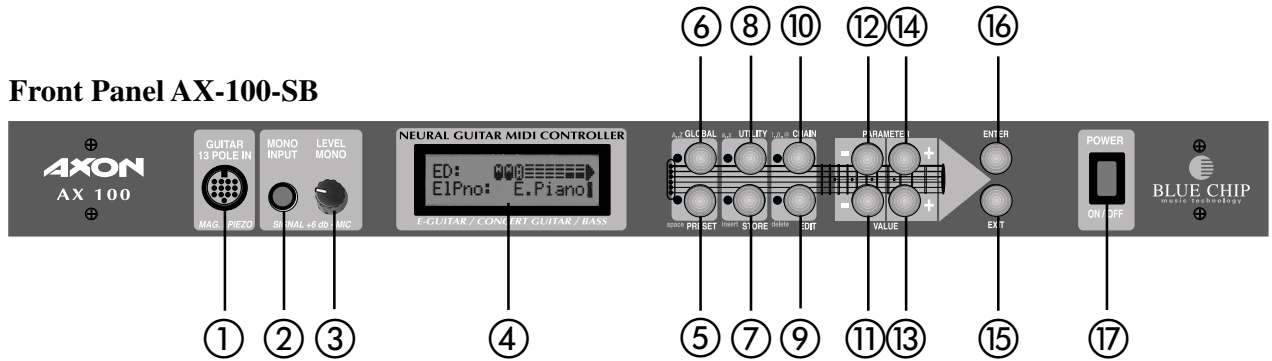
AFT-100
Footswitch with closing contact for Hold/Chain function.

AXON Setup

AXON connections and setup for AX-100



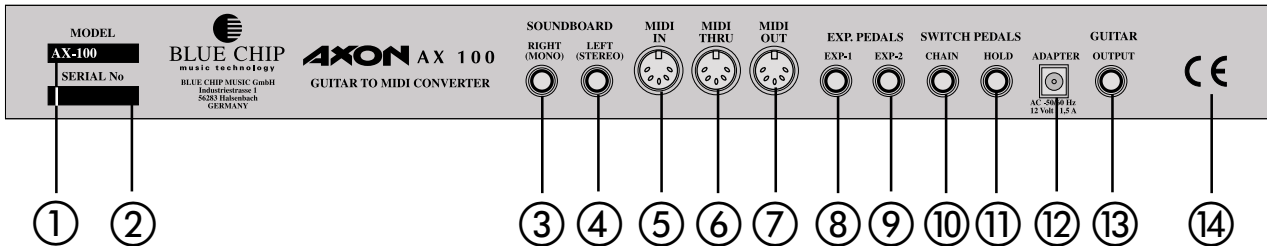
Front Panel AX-100



- ① Guitar Interface Jack. Connect your guitar interface to this jack using the 13-conductor cable provided.
- ② MONO IN Input Jack. Use this jack to input any analog signal to your AXON. The AXON will then convert it to MIDI information.
- ③ LEVEL MONO. Sensitivity pot for the MONO IN jack.
- ④ The high-contrast LCD display shows preset names as well as various parameters, some of which are shown graphically.
- ⑤ Using the PRESET button, you can change from GLOBAL, UTILITY and CHAIN modes directly to PRESET mode. The LED just to the left of the PRESET button shows you the status. In PRESET mode, the presently selected preset is shown in the display. You also have the option of seeing the built in instrument tuner in the bottom half of the display. Use the +/- Value buttons to cycle through and select presets. In the Text-Editor, using the PRESET button gives you a space.
- ⑥ Using the GLOBAL button, you have access to general system settings such as MIDI channel, guitar settings, as well as the default values of all MIDI controllers. In addition you can prohibit output of Panorama, Reverb, Chorus and Variation controllers separately. In the Text-Editor, using the PRESET button (A...Z) changes the presently selected character to a capital or if no character is selected, gives you a capital "A".
- ⑦ The STORE button allows you to save preset data, arpeggiator patterns, drum sequences and chains to the permanent battery-backed-up RAM of your AXON. In the Text-Editor, using the STORE button inserts a character at the present cursor position, shifting all following characters one character to the right.
- ⑧ In UTILITY mode there are various special functions available:
 - output of sysex (system exclusive) data for archival purposes
 - access to the pattern-oriented drum sequencer built in to the AXON AX 100 SB
 - flexible effect editor for all available effects including reverb, delay, modulation, equalization, etc.
 In the Text-Editor, using the UTILITY button (a...z) removes the presently selected character to small case, or if no character is selected, inserts a small case "a".
- ⑨ Using the EDIT button in PRESET mode allows you access to the various preset parameters. In CHAIN mode you can select various series of presets that can be toggled using a foot pedal. In the Text-Editor, using the EDIT button (delete) removes the presently selected character and moves all the following characters one character to the left.
- ⑩ Use the CHAIN button to get to CHAIN mode, where you can use a foot pedal to cycle through preprogrammed preset series. In the Text-Editor, using the CHAIN button (!...@) inserts a punctuation or special character.
- ⑪ ⑬ The +/- Value buttons increase or decrease the presently selected value of a parameter in the display. You can also use the UP/DOWN buttons on your guitar interface.
- ⑫ ⑭ The +/- Parameter buttons allow you to cycle through the various parameters in a parameter list in the display. In PRESET mode these buttons have no function.
- ⑮ Use the EXIT button to leave the present sub menu. Pressing it several times brings you to the root level of PRESET mode. Use the EXIT button to cancel a save function as well.
- ⑯ The ENTER button serves as a confirmation of saves and copies as well as opening a sub menu. The presence of a sub menu is shown as "...". You can leave any sub menu using the EXIT button.
- ⑰ POWER ON/OFF. Here is where you turn your AXON on and off. When you turn it on, the display shows your last used preset in PRESET mode and is in LOCAL ON mode.

Rear Panel AX-100

Rear Panel AX-100-SB



- ① Model number of your AXON from the factory. If there is "SB" after the "AXON AX 100", your AXON is equipped with the internal sound board built in at the factory. You can of course opt to purchase the sound board later.
- ② Serial Number of your AXON.
- ③ RIGHT (MONO): This is the right side line level output from the internal sound board, if you have the AXON AX 100 SB. If this output jack alone is connected (without the left output being connected) the resulting signal from this output jack is a composite MONO signal.
- ④ LEFT (STEREO): This is the left side line level output from the internal sound board, if you have the AXON AX 100 SB. If this output jack alone is connected (without the right jack being connected) the resulting signal from this jack is still the left side of the stereo signal alone.
- ⑤ MIDI IN jack: Your AXON AX 100 (SB) receives program change and sysex data on this port. If you also use the setting LOCAL OFF in GLOBAL mode, you can have all incoming MIDI data sent directly to the optional internal sound board. This is the typical setting if you are using your AXON with a sequencer.
- ⑥ MIDI THRU jack: All data that is received on the MIDI IN jack will be echoed unchanged to this port.
- ⑦ MIDI OUT jack: All MIDI data generated by your AXON will be sent to this port. If you are using an external MIDI instrument with your AXON, be sure to connect this port with the MIDI IN port on your external instrument.
- ⑧ ⑨ EXP1, EXP2 jacks for foot swell pedals: You can connect to separate swell pedals to these jacks to control any MIDI controller you choose. Especially valuable when assigned to modulation and filter effects. Because your AXON supports the NRPN/RPN controllers, you can assign controllers #6 and #38 to these pedals and have access to a wide variety of usable functions that are not presently available in any other machine of this category.
- ⑩ CHAIN footpedal jack: In chain mode, you can use a pedal switch attached to this port to cycle through a series of preprogrammed presets.
- ⑪ HOLD footpedal jack: connect the foot pedal included with your AXON to this port to access any of the various HOLD modes such as COMMON, SEPARATE, LAYER, ARPEGGIATOR and CONTROL.
- ⑫ ADAPTER: Connect the powersupply included with your AXON to this jack.
- ⑬ GUITAR OUT jack: The normal analog signal from your guitar pickups is transmitted through the 13-conductor cable from your guitar interface along with all the other information sent to your AXON. This unchanged analog signal is fed through your AXON to this port so that you can, for example, combine your natural guitar sound with the MIDI sounds generated by your AXON. In order to eliminate possible hum from the guitar analog signal, always use this port and the signal coming through the 13-conductor cable for the source of your analog guitar sound if you are going to be combining it with MIDI sounds. Your guitar interface AX101/102 has a mini phone jack for this purpose. You can connect it directly to the included 13-conductor cable.
- ⑭ CE symbol: This symbol certifies that your AXON follows the appropriate standards of the European Union (EU).

About the AXON AX 100 (-SB)

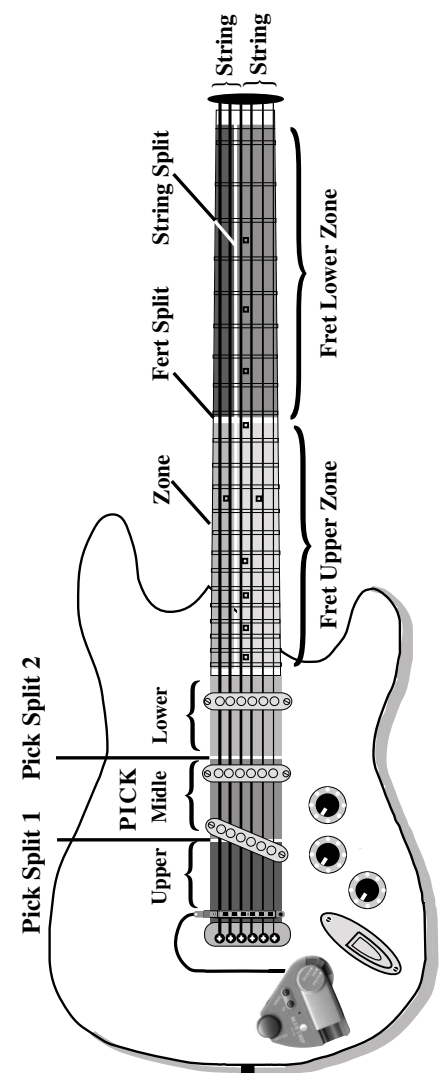
Congratulations on your purchase of the AXON AX 100 (-SB), the fastest and highest performance Guitar to Midi Converter presently on the market. The AXON AX 100 represents a new generation of the NGC 77, which up until now has been the standard for innovative technology and which has become standard equipment for many professional guitarists like John McLaughlin for example. With the development of the Neural Net System, with its ability to learn your personal guitar playing style, the AXON AX 100 is capable of recognizing the exact pitch that you play immediately as you play it, whereas other converters need several string vibrations for pitch analysis.

Transient Early Recognition is a process that allows the AXON to immediately and simultaneously recognize and translate pitch, volume, and even the pick position of your right hand, a characteristic that is to date unique to the AXON. This is because of the AXON's unique structure of Splits. You can divide the six strings of your guitar into two separate groups and then assign two separate sounds to those string groups. Or you can make use of a "Fretsplit", to divide the fingerboard of your guitar into two totally distinct play areas, assigning separate sounds or characteristics to each area. Using "Picksplit" you can divide the area of your guitar where you pick the strings into three separate ranges, allowing you to assign various sounds and sound characteristics to each range. In this way you can switch from sound to sound with lightning speed, simply by moving your right hand forward or backward.

Impressive effects can be controlled by the Pickcontrol function, allowing you to assign such Midi controller effects as Modulation to various pick ranges. Other effects such as COMMON (Bypass), SEPARATE (Hold), LAYER (ensemble/doubling), etc. can be controlled by the fully programmable hold pedal.

The implementation of a sophisticated Arpeggiator gives you the possibilities of variation and expression and accompaniment. Splits and effects can be freely combined and saved in up to 128 presets, which can then be called up quickly.

Also unique to the AXON AX 100 is the ability to use special piezo pickups in your bass guitar or even acoustic and nylon stringed instruments, allowing you complete control of your AXON from acoustic instruments. Finally a door to the midi world for bass guitarists and classical guitarists is wide open for new and modern forms of musical expression.



The internal sound board built into the AXON AX 100-SB makes your AXON a professional guitar synthesizer with 480 excellent and well-thought-out sounds, as well as 11 drum kits. Aside from the fact that the soundboard totally adheres to XG-MIDI-MODE, the newest standard in General-MIDI, there are numerous digital effects. All the reverb, chorus and variation effects (11 reverb, 11 chorus, 42 variation) can be freely combined and simultaneously implemented. In addition the AXON AX 100-SB is a freely editable drum sequencer. And because the AXON AX 100 is structured modularly, you can choose at any time to add the optional sound board, upgrading to the SB version.

Quickstart

It's certainly understandable that you are not in the mood right now to learn all about the theory and structure of your AXON. You can do that later in the pages of this manual. Now it's time to dabble a little:

Basic Settings

Before you start, it's important to tell the AXON a few things about the instrument you'll be playing. The more exact you are about these basic settings, the more exact your AXON's neural net will be able to interpret your playing style and adjust to how you play. The default parameters are so thought-out so that you will probably only have to change a few of them. Then later, when you get to know your AXON a bit better, you will be able to fine-tune these settings (Global Parameters).

1. Using the 13 pin jack on the front side of the AXON, connect your guitar interface to it using the 13 connector cable provided. If you will be using an external MIDI instrument, connect it using the MIDI-out port on the AXON and the MIDI-in port on the synth using normal MIDI cables
2. Turn the AXON on. Wait for a moment until the AXON has completed its initialisation process and the display is still.
3. Press the GLOBAL button. In the display you now see "BASIC CHANNEL." If you see a "1" after the colon, leave it. If not, use the +/- Value buttons to set this value to 1.



```
GLOBALS  
BASIC CHANNEL: 1
```

4. Press the + Parameter button, to get to the next Global parameter. Check to make sure that the parameter "HOLD CHANNEL" is set to "7." If your AXON does not have the optional internal sound board built in, you should skip to step 5. Otherwise press the + Parameter button again and set the value for "SEQ CHANNEL" to "16" (+/- Value buttons) if the value is different than 16.

```
GLOBALS
HOLD CHANNEL: 7
```

5. Press the + Parameter button to set the values for "PBEND RANGE." This value sets the maximum number of halfsteps that are allowed when Pitchbend information is analysed. What you set this value for will be determined by the MIDI instrument you will be using. If in doubt, read the user's manual of your MIDI instrument. If your instrument allows, use the +/- Value buttons to set this value to 12 (one octave).

```
GLOBALS
PBEND RANGE: 12
```

6. Press the + Parameter button to get to "SND PBENDRG." If your MIDI instrument supports setting separate pitchbend parameters for each sound preset, set this value to "ON" (+/- Value buttons). If in doubt, read the user's manual of your MIDI instrument. If you are using the internal sound card of the AXON AX 100-SB, set this value to "OFF."

```
GLOBALS
SND PBENDRG: ON
```

7. Press the + Parameter button repeatedly until you see "GUITAR NO" in the display. Now press the ENTER button to get to the submenu. At the prompt "TYP:" use the +/- Value buttons to set the instrument you will be playing into your AXON: "BASS", "GUITAR", "VIOLINE" OR "CELLO" (+/- Value buttons).

```
INPUT:  -----
TYP:      GUITAR
```

8. Press the + Parameter button to tell the AXON about the type of pickup you are using on your instrument. If you are using an acoustic guitar or bass with a piezo pickup, choose "PIEZO" (+/- Value buttons). Otherwise leave the default setting at "AIX101."

```
INPUT:  -----
PICKUP:  AIX101
```

You have now completed the basic settings and your AXON is ready to be played. The changes you made have been automatically saved in static RAM so that they will still be available after you restart your AXON. Press the "EXIT" button twice to get back to normal play mode.



Changing a preset sound

Make sure your AXON is in PRESET MODE (PRESET LED on the front panel is on). This is the mode that your AXON is in when you first turn it on or if you have not pressed any of the other mode buttons (GLOBAL, UTIL, CHAIN). The top half of the display contains the name of the active preset. To the right, the preset number. You can change the preset by pressing the +/- Value buttons or by using the UP/DOWN buttons on your guitar interface, stepping you through 256 presets. Presets 1-128 can be freely manipulated and edited by the user. 129-256 contain factory presets that are undeditable. We have copied the factory presets to positions 1-128 for you so that there will be playable sounds already available in those slots. Perhaps you'd like to play with a few of these factory presets. If you see an abbreviation in the Preset name, for example "SS", the present preset contains a split, in this case a String split. Other split abbreviations are:

- FS: Fret split
- PS: Pick split
- MS: Multi split
- HL: Hold mode layer (activated using the hold pedal)
- HS: Hold Mode Stack (simultaneously without Hold pedal)
- HA: Hold mode arpeggio (activated using the hold pedal)
- HC: Hold mode control (activated using the hold pedal)
- PC: Pick control (control using your pick position)
- WH: Wheel control (control using the wheel)

Now that you have sufficiently looked at and tried the factory presets, let's edit one of them:



1. Using the +/- Value buttons, find Preset number 2 "EPno2+HdPad" (the same as factory preset 130). You can also use the UP/DOWN buttons on your guitar interface to maneuver to Preset no. 2. Now press the EDIT button.

2. Press the ENTER button to get to the split zone area of your AXON. Press the ENTER button to accept the selected split zone.



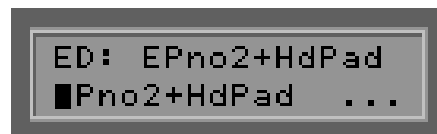
3. If your AXON is equipped with the internal sound module, press the - Parameter button and use the +/- Value buttons to select any of the instrument groups. With the + Parameter button, you can now move to the area where you can select a particular instrument for that group. (+/- Value buttons).

If you don't own the internal sound board, choose a GM (General MIDI) instrument that you like and set the following parameters "BANK MSB" and "BANK LSB" (using the + Parameter button) to the value of "0" (+/- Value buttons). If the instrument shown in the display is different than the sound you hear, you may have to set your external MIDI instrument to GM (General MIDI) mode. If this isn't possible, maybe because your instrument is older and does not conform to the General MIDI standard, you can still use the somewhat less user-friendly method of setting Bank and program numbers. See the chapter "UTILITY MODE" for a description. We won't however go into that at this time.

4. Press the + Parameter button. Set the value for "VOLUME" to your desired level using the +/- Value buttons. If you like, you can also change the next parameter "TRANSPOSE", which is valuable, for example, for bass players. This parameter changes the pitch value of your MIDI instrument in halfstep increments (like moving your fingers up or down on the fingerboard.) To do this, press the + Parameter button again and set it's value using the +/- Value buttons. ("+12" or "-12" for up an octave or down and octave respectively.)



5. Press the EXIT button twice to get back to the top of the Preset area. We now want to give our new (changed) preset a new name. Press the ENTER button. The editor cursor is now over the "E" of the old name "EPno2+HdPad." With the +/- Value buttons you can change the letter where the cursor is. Think of a new name and change the first letter accordingly. With the +/- Parameter buttons you can move the editor cursor one character to the right or to the left respectively. Repeat this process until your new name is complete in the display. If your new name is shorter than the old one, you can simply change the left over letters to spaces.



6. Press the EXIT button twice to end your Preset text editing session. The upper half of the display is blinking. This signals that you have changed some parameters that have not yet been saved. Press the STORE button. Now you can determine at which slot you want to save your new Preset. You can either overwrite the Preset you have been editing or save it at another location within the user-definable area (1-128). Choose, for example, Preset No. 128 (+/- Value buttons). Now when you press the ENTER button, your preset will be copied to slot 128 and saved there. This also now becomes the active preset.

About the User Interface of your AXON

The flexibility of of your AXON with all of its sophistication also requires that many parameters to be set in order to achieve all the possibilities. Here is a short description of the structure of the user interface, in order to give you an overview of how the AXON works.

In order to keep the user interface as simple and as transparent as possible, the structure of functions has been divided into four modes or sections of operation that can all be accessed directly from the front panel. Each of these Modes (GLOBAL, PRESET, UTILITY, CHAIN) contain a series of related parameters that are accessed by pressing the +/- Parameter buttons. The + Parameter button takes you to the next parameter in the series, the - Parameter button to the previous.

The values of each individual parameter can then be changed by using the +/- Value buttons. The + Value button increases the value to the next highest and the - Value button to the next lowest. By holding the value buttons down, you can cycle through the available values step by step. And so that you don't fall asleep waiting for the appropriate value in a long list, you can, after pressing the desired +/- Value buttons and are holding it down, also pressing the other one (+ or -) and holding both down. This will speed the scrolling of values considerably. You can also change values in parameters by using the UP/DOWN buttons on your guitar interface, although these are primarily designed to change presets.

Some of the parameters have submenus with further parameters. You can tell if this is the case by the "... " at the end of the Parameter name. Use the ENTER button to get to these submenus. You can then navigate the submenus using the +/- Parameter buttons. The EXIT button takes you back to the next level up in the submenu hierarchy; to the parameter (...) before you pressed the ENTER button. Also use the EXIT button to get back to the PRESET mode, the standard mode of your AXON.

The Four AXON Modes of operation

GLOBAL MODE

All of the parameters in Global mode apply to all the presets in your AXON, for example information regarding MIDI channels, the instrument you are playing, basic tuning, or the sensitivity of each string you play. Some of these parameters should be checked/changed before you use your AXON for the first time so that it can operate optimally with your instrument.

PRESET MODE

This is where you find all the parameters that relate to the administration of individual presets. The Preset mode along with the Utility mode is most sophisticated of the modes and contains numerous split and effect settings. If you are not in any of the other modes, Preset mode is always active.

UTILITY MODE

Owners of the AXON AX 100-SB will find here numerous settings for drum sequences and programmable digital effects. Here are also functions for loading and saving SYSEX data using MIDI, so that you can, for example, back up all your AXON settings to a floppy or hard disk drive on your computer, providing you have the appropriate software.

CHAIN MODE

You can define chains of presets for use in live performance that are then easily accessible.

GLOBAL MODE

The GLOBAL MODE is activated by pressing the GLOBAL button on the front panel of your AXON. This is confirmed by the lighted LED just to the right of the GLOBAL button.

Global Parameters

All of the parameters in Global mode apply to all the presets in your AXON, for example information regarding MIDI channels, the instrument you are playing, basic tuning, or the sensitivity of each string you play. Some of these parameters should be checked/changed before you use your AXON for the first time so that it can operate optimally with your instrument.



BASIC CHANNEL

Basic MIDI Channel (1...11)

The MIDI information that your AXON generates based on the vibrations of your guitar strings that are sent to it have to be assigned to a channel in order for that information to get to the sound module or the external MIDI instrument that will then play the information. The ideal scenario (see STRING MODE SEPARATE) is for each individual string to be assigned its own MIDI channel. The advantage is that controller information that is generated parallel to pitch information only effects the sound generated by that particular string. For example pitchbend information generated by pulling a string should only affect that one string and not all the others that are presently sounding and not being pulled. With the parameter BASIC CHANNEL, you need only set the FIRST of the six channels for your six strings. The other five will automatically be assigned respectively. For example, if this value is set to "1", then channels 1-6 will be reserved for the six strings. If you set this value for "5", then channels 5-10 will be reserved, the value "11" will reserve channels 11-16, etc. Typically this parameter is set to "1", reserving channels 1-6 for string input.



HOLD CHANNEL

Hold MIDI Channel (1...11)

In the same way that the first of six channels was set for the BASIC CHANNEL parameter, so the first of an additional six MIDI channels is set here for Hold effects such as SEPARATE, LAYER, ARPEGGIO. It is important here that basic channels and hold channels do not coincide. In other words, make sure that the basic channel and the hold channel values are at least six digits apart. Typically this parameter is set to "7", reserving channels 7-12 for the hold functions.

SEQ CHANNEL

MIDI channel for internal soundboard drum sequences (1...16)

The output from the drum sequencer that is built into the internal soundboard will have its own separate MIDI channel. It is important here that the SEQ CHANNEL not coincide with any of the BASIC CHANNEL or HOLD CHANNEL reserved MIDI channels. Make sure you choose a free channel and reserve it for drum sequences using this parameter. Typically this value is set for "16." This parameter is only available to those who have the internal sound board installed.

PBEND RANGE

Pitchbend limit values (OFF, 1...24)

Techniques often used by guitarists are string bends, pulloffs, hammerons, slides. In order to effectively interpret these techniques that are fairly unique to guitar, your AXON uses the MIDI controller Pitchbend. In much the same way that a keyboard player hits a key and then uses his pitchwheel to modify the pitch, your AXON can generate pitchbend information for picked notes. In order for the built in sound module or the external MIDI instrument to correctly play this pitchbend information, the limit values for pitchbending need to be set. The value you choose relates to the number of halfsteps that the pitch will be allowed to be bent. Make sure that your MIDI instrument can interpret the values you program for this parameter. If possible set this value to 12 (one octave). For bass guitar, we recommend a setting of 24. The value OFF sends no pitchbend information, so that when you bend strings or slide, the resulting pitch will change in halfstep increments.



```

GLOBALS
PBEND RANGE: 12

```

SND PBENDRG

Send Pitchbend Range (ON/OFF)

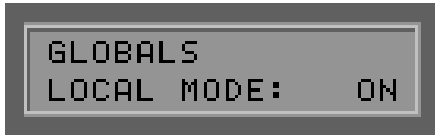
If your MIDI instrument allows pitchbend parameter settings for every Preset (sound), set this parameter to ON. In this case your AXON sends the pitchbend range event directly after every program change event. If your MIDI instrument saves pitchbend information in its global area, set this value to OFF.



```

GLOBALS
SND PBENDRG: ON

```



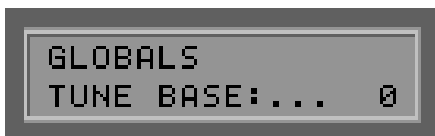
LOCAL MODE

Local operation mode (ON/OFF)

ON: This is the internal operating mode of your AXON. The internal sound module will be directly triggered. Received program change events (via MIDI IN) will affect the program selected in your AXON. These events are then sent on to the MIDI OUT port. In this way, other connected MIDI instruments can be controlled. This value should be set if you are not using an external sequencer to drive your AXON or other synths. This would probably be the case most often in live situations.

OFF: If you want to control your AXON from a hardware or software sequencer in cooperation with other connected MIDI instruments, you can deactivate local control. Your internal sound module will now act like a normal expander. You can no longer change the Presets of your internal sound module through the MIDI IN port. Of course you can still select presets using the front panel buttons. All the MIDI data that your AXON generates will now be exclusively sent to the MIDI OUT port. Make sure you have the sequencer connected to the MIDI OUT port of the AXON and that the MIDI OUT port on the sequencer is connected to MIDI IN on your AXON. Switch the echo function in your sequencer on, so that the incoming signal from your AXON will be echoed to the OUT port and back to the AXON and to its internal sound module.

After turning off your AXON, the LOCAL MODE parameter is automatically reset to ON. If you set this parameter to OFF, it will only remain off as long as your AXON is powered up.



TUNE BASE

Basic Tuning (-99...+99)


All the MIDI notes generated by your AXON are compared to the reference tuning of 40 Hz plus or minus the value you set with this parameter. If you are playing with other musicians using instruments that are difficult to tune (piano for example), it is much easier to tune your AXON to their instrument. Here's how to do that: carefully tune the A string of your guitar to the other instrument, to which you want to tune (piano). Press the ENTER button. In the display you see "PICK THE OPEN A STRING". When you play the A string, your AXON analyses the pitch and adjusts its tune base to the correct value. You can also set the value manually using the +/- Value buttons, if you know the value. After this step, you can now tune the other strings of your guitar using the AXON's built in tuning function. When you play alone (solo), you should set the tune base value to "0".



GUITAR NO...

Guitar number and guitar-specific settings (1...4)

In order for your AXON to optimally translate the information coming from your guitar into MIDI information, there are a few basic parameters that need to be set in terms of sensitivity, etc. These settings are dependant upon the structure of your guitar, and are very specific. They can be totally different for different guitars. If, in the middle of a live performance, you decide you want to play another guitar with your AXON, you can quickly call up settings for that particular instrument.. It is simply a matter of selecting the appropriate guitar number. You can program basic settings for four totally distinct instruments into your AXON. When you press the ENTER button, you toggle through the various settings. Use the +/- Parameter buttons to select the individual functions. The values can then be changed using the +/- Value buttons. Within these basic settings, the first line in your display shows a VU meter. The position of the small dashes correspond to the strings of your guitar. When you play a string, you will see that the associated dash fills in more and more until playing loudly fills out the entire character space.



```

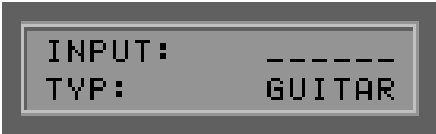
GLOBALS
GUITAR NO: ... 1

```

TYP

Type of instrument (GUITAR, BASS, VIO:LINE, CELLO)

You decide here what type of instrument you will be using. This is particularly important for the assigning of string and hold channels.



```

INPUT: ----
TYP: GUITAR

```

PICKUP

The type of pickup in your instrument (AIX101, PIEZO)

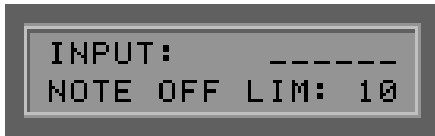
Choose the type of pickup you will be using to drive your AXON. AIX101 is the normal setting if, for example, you are using the Guitar Interface AIX-101. The setting PIEZO allows for the use of polyphonic Piezo-Pickups (optional). The signal from piezo pickups is very true to the original acoustic sound of the instrument and have been developed especially for acoustic guitars. The advantages of these pickups for acoustic guitarists are that the pickup is totally invisible (installed under the bridge) and that you can use nylon stringed instruments (classical guitars) to drive your AXON.



```

INPUT: ----
PICKUP: AIX101

```



NOTE OFF LIM

Note off Limiter (10...30)

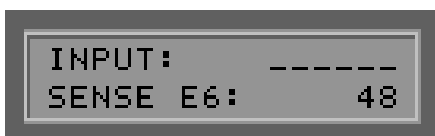
Unlike a keyboard, where a key is pressed and the note ends when you release the key, a guitar string sounds until its vibrations decay totally or until it is dampened. The decay time is most definitely dependant upon the quality and structure of the guitar and the strings. Some guitars sound more percussive; others have a longer sustain. Synthesizers recreate these characteristics using a so-called "envelope curve," to graphically reproduce an instrument's characteristic of decaying amplitude (volume) as it diminishes to zero. Be setting a limit point within the envelope, we can determine at what point in time a note's "release" comes; the point at which it ceases to sound. The higher this value, the earlier a MIDI NOTE OFF event will be sent to the MIDI instruments. Smaller values will allow the note to be held longer. In this way you can adjust this value to match your instrument optimally.



TRIG. LEVEL

Trigger Level (0...9)

Using this parameter you can set the volume level at which your AXON reacts to a signal from your instrument (at which volume level a MIDI NOTE ON event is sent). The smaller the value, the more sensitively your AXON reacts even to very softly played notes. Higher values mean that you have to play loudly in order for the AXON to send a NOTE ON event. You should experiment with this parameter in order to find a setting that feels good to you and your playing style.



SENSE

Guitar/Bass input sensitivity: E6...E1 or B6...C1 (16...64)

Using the +/- Parameter buttons you can toggle through all the strings of your instrument and set each one's input sensitivity separately. Higher values mean a higher level of sensitivity. Your AXON, like many electronic devices that translate analog audio into a digital signal, is very sensitive and can easily be overdriven. But the other extreme is equally as true: you shouldn't drive your AXON with too low of an input signal level either. You will probably have to increase the sensitivity of the thin strings to obtain a balance between the strings and to reproduce a natural sound. When setting up a bass guitar, for reasons of compatibility, your AXON takes for granted that you are playing a six-string bass. If you are playing an instrument with less than six strings, simply bypass the strings that don't apply.

PAN ENABLE

Panorama Controller (ON/OFF)

Within a given preset of your AXON, it is possible to set distinct stereo panorama placement for each individual split. Panorama is MIDI Controller #10 which is sent to your MIDI instruments. If you don't want to send Controller #10 events, perhaps because you would rather use the panorama settings within a connected keyboard, for example, or because a given MIDI instrument is older and doesn't support Controller 10 information, set this value to OFF. If this parameter is set to ON, the values will be sent that were set in the Play Area parameters (see PRESET MODE). As will all other controller information, you AXON will only send Controller 10 if the panorama settings have changed from what was previously sent, so as not send redundant information.

| | | | | | | | | | |
|---------|---------|--|--|--|--|--|--|--|----|
| GLOBALS | | | | | | | | | |
| PAN | ENABLE: | | | | | | | | ON |

REV ENABLE

Reverb Controller (ON/OFF)

For the same reasons (see PAN ENABLE), you may not want MIDI Controller #91 information (Reverb) for a preset split sent to your MIDI instruments. Set this value to OFF. If your AXON is equipped with the internal soundboard, a third parameter, NO EFFECT, is also listed as a choice. If this is selected, the programmed reverb function of the preset will be ignored by the soundboard.

| | | | | | | | | | |
|---------|---------|--|--|--|--|--|--|--|----|
| GLOBALS | | | | | | | | | |
| REV | ENABLE: | | | | | | | | ON |

CHOR ENABLE

Chorus Controller (ON/OFF)

Here you determine whether MIDI Controller #93 (Chorus) will be sent to your MIDI instruments or not. (see PAN ENABLE) If your AXON is equipped with the internal soundboard, a third parameter, NO EFFECT, is also listed as a choice. If this is selected, the programmed chorus function of the preset will be ignored by the soundboard.

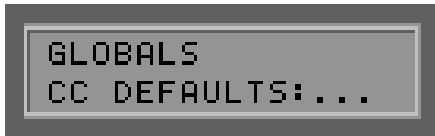
| | | | | | | | | | |
|---------|---------|--|--|--|--|--|--|--|----|
| GLOBALS | | | | | | | | | |
| CHOR | ENABLE: | | | | | | | | ON |

VAR ENABLE

Variation Controller (ON/OFF)

Here you determine whether MIDI Controller #94 (Variation) will be sent to your MIDI instruments or not. (see PAN ENABLE) If your AXON is equipped with the internal soundboard, a third parameter, NO EFFECT, is also listed as a choice. If this is selected, the programmed variation function of the preset will be ignored by the soundboard.

| | | | | | | | | | |
|---------|---------|--|--|--|--|--|--|--|----|
| GLOBALS | | | | | | | | | |
| VAR | ENABLE: | | | | | | | | ON |



CC DEFAULTS...

Controller defaults...

In using the various possibilities of control you have using modulation wheels or, in our case, pick control functionality, it is necessary for the controller value to be reset to its default value (usually zero) after a preset change for example. But there are exceptions. The optional soundboard expects a standard value of 64 for Controllers 71-74 because these controllers are used as offsets. Because there are numerous non-standard Controllers available in the MIDI Protocol, that manufacturers can use at will, your AXON is equipped with the ability to determine and set the default value for all these controllers.

Press the ENTER button to get to the submenu. In the first line of the display shows the name and number of the presently selected controller and in the second line, its default value in hexadecimal format. The cursor is in the first line and by using the +/- Value buttons, you can select the controller you want to work with. The + Parameter button moves the cursor to the second line, and then the default value can be changed using the +/- Value buttons. The value you enter here will be saved in a battery-backed-up memory area of your AXON. The table contains the factory default values. All standardized MIDI controllers have a default value of zero. Refer to the user manual of MIDI instrument or module you are using for the default values of any controller used by the manufacturer and set it here. Use the EXIT button to leave the Submenu.



MIDI MAPPING:

Program change commands that are received on the selected active BASIC CHANNEL can be assigned to any AXON presets using this mapping table. Press the ENTER button.

The first line of the display shows the program number that your AXON receives; the second line of the display shows the Preset to which the change will be made. The default setting is the program change will be sent to the AXON preset with the same program number. If you want to change this setting, use the +/- VALUE buttons to change to the appropriate value. Your entry will be immediately saved in the AXON's internal battery-backed-up memory, and does not have to be saved. Use the EXIT button to leave the submenu.

PRESET MODE

Preset Mode is always active unless you activate another mode. When you leave one of the other modes, you will always be sent back to Preset Mode. Preset Mode is signaled by a lit LED just to the right of the PRESET button on the front panel.

Preset Parameters

These parameters contain all the settings that relate to individual presets. A preset is a playing environment that you determine, saved and easily retrievable, with the flexibility and complexity to give you total control over playing and sound characteristics. You can program, save and recall up to 128 complex presets. How complex a preset is, is something you determine. For example you have the capability of dividing the strings of your guitar into a total of 12 totally separate and individual splits and then to freely combine them. Each of these presets can have its own set of effects, selected from a copious list, as well as its own set of playing parameters.

Recalling Presets

Use the +/- Value buttons to cycle through your presets. You can also use the UP/DOWN buttons on your guitar interface.

Guitar Tuner

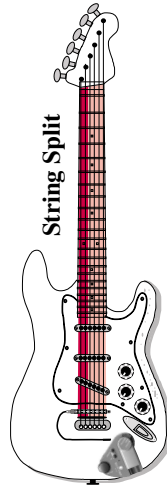
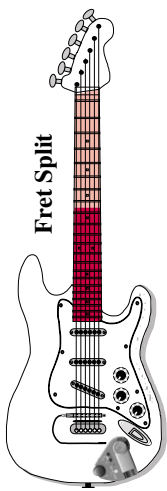
In the default setting (see UTILITY MODE, DISPLAY) the bottom half of the display shows a tuner that monitors your instrument as you play to insure correct tuning. It is important that your instrument is tuned within a certain tolerance so that your AXON will send the proper MIDI pitch information to your MIDI instruments. Tune every string so that the meter pointer is directly over the arrow in the middle of the scale. As long as the Tune Base Parameter is set to "0", the arrow in the middle of the scale represents a standard tuning of 440 Hz. There may be reasons for changing this basic tuning standard, for example if you want to play with an acoustic piano that is somewhat under the pitch. (see Global Parameters, TUNE BASE) In this case you can tell the AXON to orient itself to the tuning of your guitar, giving you a new standard. In this case the arrow in the middle of the tuning scale represents the new tuning standard.





PRESET PROGRAMMING

When your AXON is in preset mode, you can press the EDIT button to program/edit a preset. The graphic at the bottom of the display shows the actual split zones of the presently selected preset. In order for you to better understand what a split zone is, let us look a little closer at the split possibilities that your AXON is equipped with. A split is simply the dividing up of the play area of an instrument into two or more zones. Your AXON is capable of the following split possibilities:

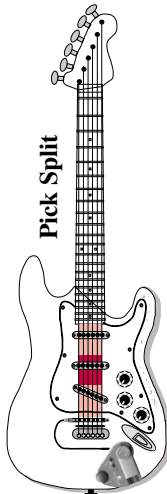


String Split

You can divide the six strings of your guitar into two separate groups, each of which can be assigned a separate synthesizer sound. You can, for example, assign a Bass guitar sound to the bottom E and A strings, and then give the other four strings a piano sound. It is totally up to you between which strings you want to set the split.

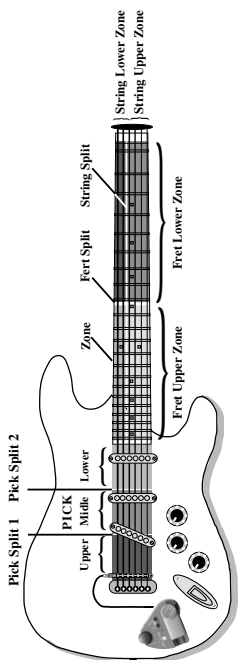
Fret Split

Likewise you can divide the fretboard of your guitar into two zones divided by a particular fret, so that regardless of which string you play, in one zone above or below the given fret one synth sound will be heard, and in the other zone another one. The fret at which the split occurs is determined by your own preference.



Pick Split

The area of your guitar between the bridge and the highest fret is the area where you normally pick or strum your guitar. This area can be divided into up to three split zones. The width of these zones is also flexible and can be freely programmed. This function allows you to play up to three different synth sounds with your guitar depending on whether you pick/strum close to the bridge, in the middle, or close to the neck.



Split Combinations

These three different types of splits can be totally independently combined giving you a total of 12 split combinations (2 string splits, 2 fret splits, 3 pick splits). And because you can freely choose where the split points are in each of the three split types, the combination possibilities are more than numerous.

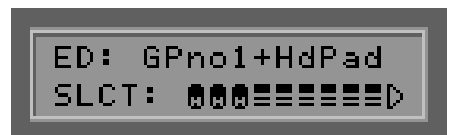
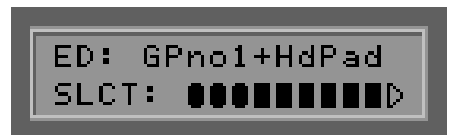
Selecting Split Zones

Make sure your AXON is in PRESET MODE (PRESET LED next to the PRESET button on the front panel is on.) Press the EDIT button. The bottom half of the display now shows a small graphic to help you visualize the play area of your guitar. The little triangle at the far right symbolizes the nut and at the left the symbols for the three pick splits, that can be split into six different parts when combined with a string split. The part of the graphic in between the pick split symbols and the triangle for the nut represent the fingerboard and can be divided into 4 parts symbolizing a combination of string and fret splits. As you program your splits, this graphic will change allowing you to see graphically where your split zones are. The simplest form is when the preset that is presently selected has no splits. If you assign a string split, you will see that the fingerboard area of the graphic now has either the upper or the lower half filled in contrasting the other half, depending upon which split zone is presently active. Using the +/- Value buttons you can step through all the possible split zones. Depending upon the complexity of the preset, you can half up to twelve different split zones. Now try to determine by looking at the graphic what split types are combined in the presently selected preset. With very little practice you will soon understand and be able to immediately decipher the help graphic. Press the EXIT button once to return to normal play mode.



Changing the Split Parameters

Select a split zone as described above and press the ENTER button. Just to the left of the help graphic described above the text SLCT is flashing. Your AXON is waiting for you to either press the ENTER button to accept the split definitions as they stand, or to define your own split definitions. Notice the similar graphic painted on the front panel around the buttons that we have used up until now. It is very similar to the help graphic on the display and has the same function. Except for the ENTER and EXIT buttons, all the other ones now function to let you select one of the split zones to edit. For right now, let's create a simple string split causing the upper half of fret area in the help graphic to be filled. Every button represents a particular split zone that can be activated for editing by pressing once, or deactivated by pressing again. Press all the upper buttons to turn them on and make sure the lower buttons are off. Now press the ENTER button. Using the +/- Parameter buttons we can now edit a series of sound characteristics for our split as follows:





Choose Instrument

Here you determine which MIDI patch/sound will be used for this split. With your AXON in XG MODE (see Utility Parameters), you will see all XG (Extended General MIDI) Sound names in your display. You can make your choice based on instrument group or instrument name. Press the – Parameter button to place the cursor in the instrument group box. Choose a random group using the +/- Value buttons. The selected instrument name will automatically be the first in the sound group. For our example here, select the group Bass instruments (e.g.: AkBas). Now press the + Parameter button to select the Bass of your choice from the group.

BANK MSB / BANK LSB

Bank Select (0...127)

You can select banks with this function, if there is no sound board build in the AX100.



VOLUME

Volume level (0...127)

Every split allows for an independent volume level that you set here. Using the +/- Value buttons set the level for your Bass sound to a value of your choosing.



TRANSPOSE

Transposition (-36...+36)

You can set a pitch offset in half step increments to affect the tuning for this split. This is a way for you to play notes with your guitar that you couldn't normally reach with the guitar alone. For our example set this value to -12 (-1 octave), so that the Bass will play within its typical range.



QUANTIZE

Pitch Quantization (AUTO, OFF, ON, TRIGGER)

With this parameter you tell your AXON to execute pitch changes using your normal pitchbend settings or step-wise (quantized):

AUTO:

This setting corresponds to your AXON's unique ability to recognize your intentions as you play with respect to pitch quantization and then translate them appropriately. Chords for example, are interpreted exactly (no pitchbend information), whereas for melodic notes of a solo which contain string bends and slides, hammer-ons and pull-offs, pitch quantization is turned off, allowing for normal pitchbend information to be sent.

OFF:

All pitch changes (hammer-ons, pull-offs, slides, etc.) will be translated into pitchbend information allowing for true representation of what you play. (see Global Parameters: Pitchbend range).

ON:

Any variation in pitch will NOT be translated in pitchbend information until the given pitch reaches the next half step and will at that point jump to the new pitch chromatically, but using pitchbend information and NOT sending new note information. Hammer-ons, pull-offs, slides, etc. will not be carried out as they are intended. The pitches you play are then locked (quantized) to the nearest half step. This setting is advantageous for playing chords.

TRIGGER:

This setting turns pitchbend off altogether, affecting simple chromatic half steps when playing bends or slides. It is the same as setting the global setting PBEND RANGE to OFF (see Global Parameters), but only affects this one particular split zone. It is recommendable to use this setting when using a piano sound, for example, which characteristically cannot be bent.

For our example set the Quantize parameter to AUTO. It applies to the Bass split and allows for string bending (pitchbend), whereas the piano sound will be triggered in half steps.

PAN POS

Panorama Position (L15...L1, MID, R1...R15)

This is where you place the selected sound of your MIDI instrument in the overall panorama left to right in stereo. The values L15 to L1 represent the left side, L15 being all the way to the left and R15 to R1 being the same in reverse. R1 and L1 are close to the center. MID is exactly centered in the stereo panorama.

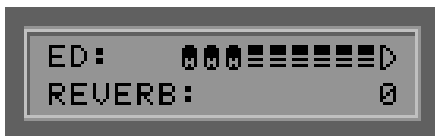




PAN SPREAD

Panorama spread (-15...+15)

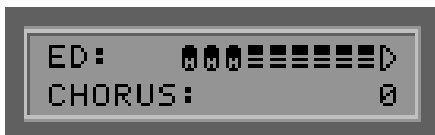
So that not all sounds (up to six 6 per Split) aren't all in the same panorama position (see above), you can use this parameter to separate each of the sounds within the general panorama set above in PAN POS. Set the PAN POS to MID, for example, and then while you play your guitar, adjust the PAN SPREAD value, keeping in mind that your MIDI instrument must be capable of interpreting Panorama information. If you need to, read your user's manual for the MIDI instrument in question.



REVERB

Reverb mix (0...127)

If your MIDI instrument is equipped with built-in reverb, you can control it with this parameter. The higher the value, the more reverb will be added to the mix in the output signal of your MIDI instrument.



CHORUS

Chorus Effect (0...127)

If your MIDI instrument is equipped with built-in Chorus, you can control it with this parameter. The higher the value, the more chorus will be added to the mix in the output signal of your MIDI instrument. The optional sound board has this feature built in.



VARIATION

Variation Effect (0...127)

If your MIDI instrument is equipped with built-in variation effects (such as Auto-wah), you can control it with this parameter. The optional sound board contains numerous variation effects that can be randomly combined with Reverb and Chorus.



VEL SENSE

Velocity Sensitivity (0...127)

You can limit the dynamic range of your MIDI instrument by adjusting the value of this parameter. The smaller the value, the less dynamic range there will be between note events. In the extreme case, a value of zero plays all notes on your MIDI instrument at the same dynamic level, regardless of how loud or softly you play your guitar. With a value of 127, you achieve the highest sensitivity and dynamic range for the notes you play.

VEL OFFSET

Velocity Offset (-64...+64)

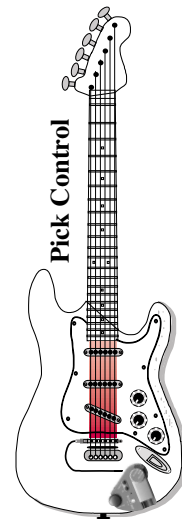
If the average dynamic level of your MIDI instrument is too soft or too loud after limiting the dynamic using VEL SENSE (see above), you can set the middle/average volume here. (see the graphic on the following page.)



PICK CONTROL...

Pick Controller (NO CONTROLLER, CONTRLxxx)

Because your AXON has the ability to recognize the position of your right hand on the strings (where you pick or strum), you can link this function with a MIDI Controller, allowing you to simulate the modulation wheel on a synth, or after touch, etc. with the position of your right hand over the string pick area. Further interesting effects can be generated by assigning Ctrl 74 (Filter) or Ctrl 10 (Pan) to pick control. Press the ENTER button and choose the controller you desire using the +/- Value buttons. The function of the chosen controller will appear in text in the display window. For controllers that are not standardized, you see a horizontal line. Using the following parameters you will now assign the value areas of the chosen controllers. This controller only affects one pick split zone. (Your AXON can have up to 3 pick zones to which you can theoretically apply 3 different pick controllers.) As a rule, you will not use more than one pick split for a pick control effect. Set both parameters PICKSPLIT1 and PICKSPLIT2 to 0. If you don't do this, the controller will only affect one pick split and not the entire pick area between bridge and fingerboard.



PICK VAL1

Pick Value 1 for Pick Controller (0...127)

Now that you have linked a particular MIDI controller to your split zone using PICK CONTRL, you are now ready to input the beginning value for that controller using this parameter. The further you move your right hand away from the bridge on your guitar, the more this beginning value increases continually until you reach its final value which is set in PICK VAL2.



PICK VAL2

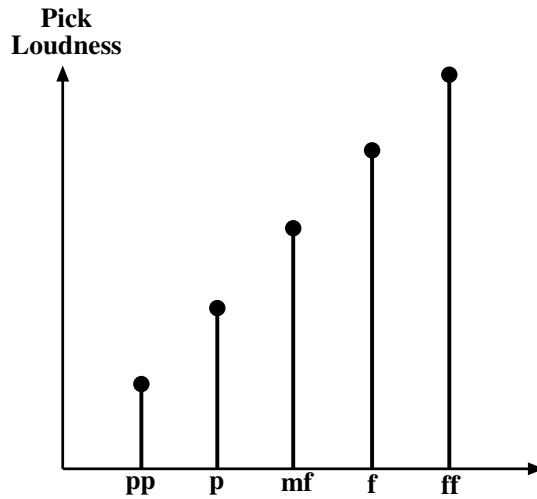
Pick Value 2 for Pick Controller (0...127)

Now that you have linked a particular MIDI controller to your split zone using PICK CONTRL, you are now ready to input the final value for that controller using this parameter. The further you move your right hand away from the bridge and toward the upper frets on your guitar, the more the beginning value increases continually until you reach this final value which you set using this parameter. To leave the sub menu, press EXIT.

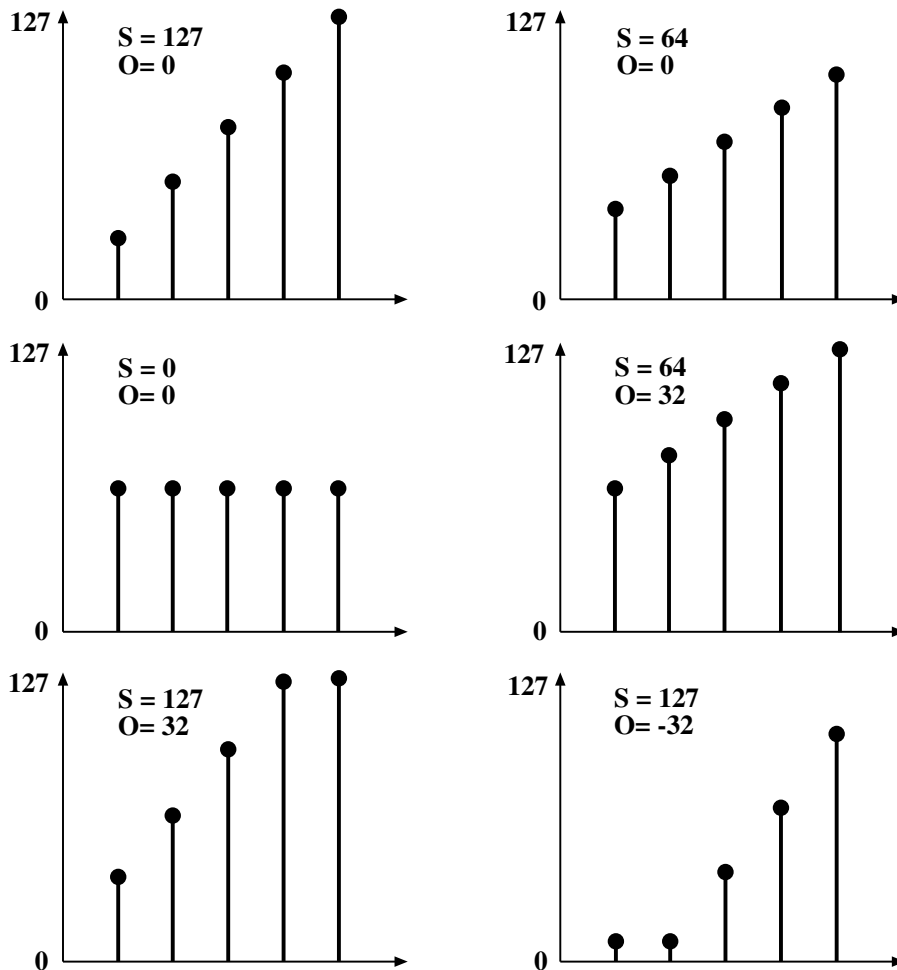


Diagram Velocity Mapping

EXAMPLE INPUT OF VELOCITY MAPPING



MIDI VELOCITY VALUES BY DIFFERENT SETTINGS OF VELOCITY SENSITIVITY AND VELOCITY OFFSET



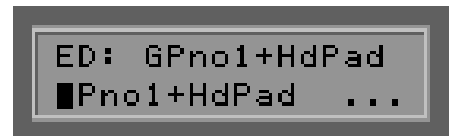
Changing split-common Parameters

Up until now the preset parameters that we have worked with have been specific to the individual split zones. There is however one preset that contains parameters that are common to all split zones and control characteristics of the entire preset. This is also where you will set the points at which the split types change. In PRESET MODE (Preset LED is on), press the EDIT button. (If you are presently still in the split zone level of the menu hierarchy, press the EXIT button.) Using the +/- Parameter buttons you can choose the following parameters, and then change their values using the +/- Value buttons.



Preset Name

In order to identify your preset easily, you should name it carefully with a description of its function. The name can be up to 12 characters in length. Press the ENTER button to begin editing the preset name. The cursor jumps to the first letter which can now be changed using the +/- Value buttons. You can use both small case or capital letters as well as special characters. To move the cursor to the right or back to the left by one character, use the +/- Parameter buttons. While in this edit mode some of the buttons on the front panel have special functions:



The GLOBAL button changes to capital letters, jumping directly to capital 'A'.

The UTIL button changes to small case letters, jumping directly to small case 'a'.

The CHAIN button changes to special characters, jumping directly to '!'.
The PRESET button changes the presently selected character to a space.

The STORE button provides for an insert function, allowing you to insert a character at the cursor position, and displacing all the characters after it one position to the right. The last character (at position 12) will be overwritten.

The EDIT button provides a delete function, deleting the character at the cursor and moving all characters to its right one position to the left. A space is then inserted at the end of the string.

The EXIT button allows you to leave the Text Editor.

STRING MODE

String Mode (COM, SEP)

String mode allows you to decide how the various strings of your guitar/Bass are assigned to MIDI channels:

COM

In COMMON mode all the strings of your instrument are assigned to the basic MIDI channel. To avoid conflict of strings that continue sounding when you play new ones, no pitchbend information is sent in this mode, when more than one note are played simultaneously. Solo playing is still possible, although somewhat limited. If your MIDI instrument can only receive on one channel, you should set STRING MODE to COM. In the same way, some sequencer software programs only allow recording on one channel at a time. In this case you should set STRING MODE to COM.

```
ED: GPno1+HdPad
STRING MODE: SEP
```

SEP

In SEPARATE mode, every string on your guitar/Bass is assigned a separate channel all its own. (see Global Parameters) This is the setting that allows you the most flexibility. Pitchbend information such as string-bending, hammer-ons, pull-offs, slides, etc. only effect the string on which they are actually played. All this information is string specific and will maintain the desired effect.. Most modern MIDI instruments are equipped “multi-mode” allowing reception of MIDI information on more than one channel. You should use the SEP setting whenever it’s at all possible.

HOLDMD

Hold Mode (COMMON, SEP..., LAYER..., ARPEG..., CNTRL..., TACK) While playing, you have access to several different “hold” functions using the hold pedals. Your AXON supports 5 different hold functions:

```
ED: GPno1+HdPad
HOLDMD: COMMON
```

COMMON

When you press the hold pedal, no MIDI data can e received until you release the pedal. This is a sort of bypass function allowing you to play a chord, press and hold the pedal so that the played chord will be sustained on your MIDI instrument until you release it, no matter what you may play on your guitar while the pedal is being held.

```
ED: GPno1+HdPad
HOLDMD: SEP...
```

SEP...

Using this setting, you can make use of the various HOLD CHANNELS (see Global Parameters) that you defined. You can, for example, play and hold a pad sound, and then play a solo over it, allowing you to in effect accompany yourself. Using the sub menu

(ENTER), set an appropriate pad sound for the accompaniment. Press the hold pedal and play the chord you want your pad sound to play and then immediately release the pedal. The chord you played will continue to sound until you press the pedal again, which causes the chord to stop, at which time you can play a new one, which will then continue to sound when you release the pedal again. To get back to normal play mode, simply press and release the hold pedal without playing anything. In the sub menu, you can set the following parameters:

HOLD PRESET

(1...128)

Using the +/- Value buttons, choose the sound you want to hear after pressing the hold pedal.



VOLUME:

(OFF,0...127)

In order to have a balanced relationship between the volume of the Main and Hold presets, you have the option to adjust the volume of Hold presets. The settings within the Hold preset itself will not be affected.



SEQ PATTERN

(OFF, 1...32)

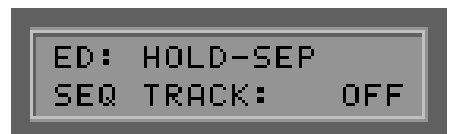
If you own the AXON AX 100SB, you have the option alongside the normal Hold Preset, to set a drum pattern sequence (see UTILITY MODE, EDIT SEQUENCE). As soon as you press the hold pedal, the selected drum pattern will play on a separate MIDI channel. The pattern will be repeated until you press the hold pedal two times quickly. Choose one drum pattern of 1-32, that you want to play when you press the hold pedal, or set this parameter to OFF.



SEQ TRACK

(OFF, 1...8)

If you own the internal sound board, you can set a complex track sequence to play instead of a pattern (see UTILITY MODE, EDIT SEQUENCE) parallel to the hold preset. As soon as you press the hold pedal, the selected track pattern will play on a separate MIDI channel. The pattern will be repeated until you press the hold pedal two times quickly. Or you can set the number of times that you want the sequence to be played. Choose one track pattern of 1-8, that you want to play when you press the hold pedal, or set this parameter to OFF. Please note that you can only use one of the two sequence possibilities at a time: either SEQ TRACK or SEQ PATTERN. Make sure the other one is set to OFF.



```
ED: HOLD-SEP
SEQ TEMPO: 120
```

SEQ TEMPO

(EXT., 41...240)

The tempo of your sequence can be set externally using Midi clock (EXT/MIDI IN) or internally using BPM (beats per minute) between 41 (very slow) and 240 (very fast). In the case of external synchronization, (e.g.. MIDI-Drums, sequencer software) the sequence will only start when the “start” command is received from the MIDI IN port.

```
ED: GPno1+HdPad
HOLDMD: LAYER...
```

LAYER...

This function allows you to play 2 sounds over each other (layer). In this way you can play particularly full, rich sounds by layering them one on top of the other. Using the sub menu (ENTER) select a sound for layering. Now when you press the hold pedal, this sound will be added to your present sound as long as the hold pedal is depressed. After pressing the ENTER button, you can set the following parameters in the sub menu:

```
ED: HOLD-LAYER
Hold Pad1 90
```

LAYER PRESET

(1...128)

Using the +/- Value buttons select the sound you want to layer with your normal play sound as long as you have the hold pedal depressed.

```
ED: HOLD-LAYER
SEQ PATTERN: OFF
```

SEQ PATTERN

(OFF, 1...32)

If you own the AXON AX 100SB, you have the option alongside the normal Hold Preset, to set a drum pattern sequence (see UTILITY MODE, EDIT SEQUENCE). As soon as you press the hold pedal, the selected drum pattern will play on a separate MIDI channel. The pattern will be repeated until you press the hold pedal two times quickly. Choose one drum pattern of 1-32, that you want to play when you press the hold pedal, or set this parameter to OFF.

```
ED: HOLD-LAYER
SEQ TRACK: OFF
```

SEQ TRACK

(OFF, 1...8)

If you own the internal sound board, you can set a complex track sequence to play instead of a pattern (see UTILITY MODE, EDIT SEQUENCE) parallel to the hold preset. As soon as you press the hold pedal, the selected track pattern will play on a separate MIDI channel. The pattern will be repeated until you press the hold pedal two times quickly. Or you can set the number of times that you want the sequence to be played. Choose one track pattern of 1-8, that you want to play when you press the hold pedal, or set this parameter to OFF. Please note that you can only use one of the two sequence possibilities at a time: either SEQ TRACK or SEQ PATTERN. Make sure the other one is set to OFF.

SEQ TEMPO

(EXT., 41...240)

The tempo of your sequence can be set externally using Midi clock (EXT/MIDI IN) or internally using BPM (beats per minute) between 41 (very slow) and 240 (very fast). In the case of external synchronization, (e.g.. MIDI-Drums, sequencer software) the sequence will only start when the “start” command is received from the MIDI IN port.

```
ED: HOLD-LAYER
SEQ TEMPO: 120
```

ARPEG...

In addition to the above mentioned sequencing possibilities you can use the powerful arpeggiator in your AXON to accompany yourself. Along side the function SEP, which allows you to hold a single chord as accompaniment, the ARPEG function allows you more complex accompaniment structures. When you press the hold pedal, and play a series of notes, these notes are received and then played back in the same order as you played them. The recording of your arpeggio is ended when you release the hold pedal. The sequence of recording notes is now played back immediately and endlessly (on the preselected Hold channel), allowing you to play your solo or other part above them. By pressing the hold pedal again, the arpeggio is stopped, but simultaneously able to record a new sequence of notes, making it possible to play and change your accompaniment sequence without stopping. To stop the arpeggio, simply press the hold pedal once and release without playing any notes.

```
ED: GPno1+HdPad
HOLDMD: ARPEG...
```

The parameter settings for the arpeggiator determine how the notes you play into it will be played back. You can control the order in which the notes are played back, or stretch out the intervals between them into several octaves. But the most interesting characteristic of the arpeggiator is its ability to quantize the notes played into it into freely programmable rhythmic patterns. Press the ENTER button to get to the Sub menu of the arpeggiator:

ARPEG PRESET

(1...128)

Select the sound you want to use when playing back by using the +/- Value buttons.

```
ED: ARPEGGIATOR
Hold Pad1 90
```

TEMPO

(EXT., 41...240)

The tempo of your arpeggiator can be set externally using Midi clock (EXT/MIDI IN) or internally using BPM (beats per minute) between 41 (very slow) and 240 (very fast). In the case of external synchronization, (e.g.. MIDI-Drums, sequencer software) the sequence will only start when the “start” command is received from the MIDI IN port.

```
ED: ARPEGGIATOR
TEMPO: 120
```

```
ED: ARPEGGIATOR
ARP. LENGTH: 4
```

LENGTH

(1...32)

This parameter allows you to set the maximum number of notes for the arpeggiator sequence. The buffer memory of the arpeggiator is expanded to include one more note every time you play a new one with the hold pedal depressed, until this maximum number is reached. If you play more notes than this maximum number, the oldest note in the series will be replaced for every note played beyond the limit you set here. An arpeggiator sequence can be as long as 32 notes long.

```
ED: ARPEGGIATOR
SCAN: ASSIGN
```

SCAN

(ASSIGN, REVERS, RECYCLE, UP, DOWN, UP/DOWN, RANDOM)

There are a number of options that determine how an arpeggiator sequence will be played back:

ASSIGN allows for playback of notes in the same order in which they were recorded. REVERS acts like a stack of notes where the last one recorded is the first one replayed. The arpeggiator plays the notes in reverse order than they were entered. RECYCLE plays the arpeggiator sequence in normal order as with ASSIGN, but when the end of the sequence is reached, it is played back in reverse order as with REVERS until the first note in the sequence is reached, at which point the process begins from the beginning again. In UP mode, the notes will be sorted from lowest to highest in pitch and played in that order. In DOWN mode, the notes are sorted from highest to lowest in pitch and played in that order. In UP/DOWN mode, the pitches are played from lowest to highest and then back down to lowest, somewhat simulating finger picking. RAND plays back the notes of the arpeggiator sequence in total random order.

PATTERN

(1/16thSt...USER#1...16)

This parameter allows you to set the quantize function of the arpeggiator sequence. The following quantize functions are available:

1/16thSt:

Classic Arpeggio. Plays back the arpeggiator sequence in staccato 16th notes.

1/16thLg:

16th notes same as above except legato.

1/8thSt:

Plays back the arpeggiator sequence in staccato 8th notes.

1/8thLg:

8th notes same as above except legato.

1/4thSt:

Plays back the arpeggiator sequence in staccato quarter notes.

1/4thLg:

Quarter notes same as above except legato.

1/2th:

Plays back the arpeggiator sequence in quarter note values with quarter rests.

1/8Trpl:

Plays back the arpeggiator sequence in 8th note triplets.

The following patterns represent rhythmical styles (grooves) and have been preprogrammed for you:

BLUES 1:

Blues rhythm. Especially effective for Bass guitar riffs.

BLUES 2:

A variation on BLUES 1.

BOOGI 1:

Boogie rhythm. Especially effective for Bass guitar riffs.

BOOGI 2:

A variation of BOOGI 1.

DISCO 1:

Disco groove. Especially effective for Bass guitar riffs.

DISCO 2:

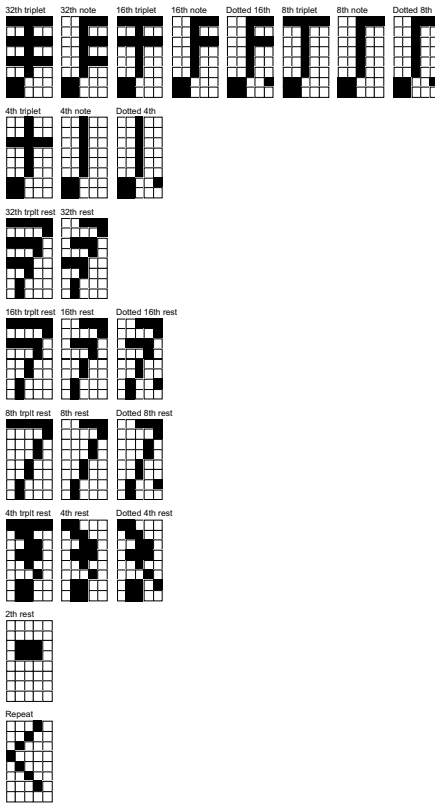
A variation of DISCO 1.

ROCK:

Rock groove for Bass guitar riffs.

HOUSE:

House rhythm. Effective for Organ riffs.



Using the patterns USER#1...USER#16, you can program up to sixteen of your own quantize patterns for use with arpeggiator playback. Select one of the user patterns and press the ENTER button. In the display you will see the Pattern Editor, with which you can set the note values for the arpeggiator playback. Move the cursor to the desired position using the +/- Parameter buttons, and select the appropriate note value using the +/- Value buttons. The “<” represents the end of the sequence (the LOOP). The pattern will be continuously repeated from beginning to end using the notes that are recorded into the sequence as described above. A maximum of 8 different note values can be implemented for every pattern. The “<” LOOP symbol is not affected by the note values entered.

While in this edit mode some of the buttons on the front panel have special functions:

The STORE button provides for an insert function, allowing you to insert a character at the cursor position, and displacing all the characters after it one position to the right. The last character (at position 12) will be overwritten.

The EDIT button provides a delete function, deleting the character at the cursor and moving all characters to its right one position to the left. A “<” LOOP symbol is then inserted at the end of the string.

The EXIT button allows you to leave the Text Editor.



SYNC
(ON, OFF)

If you enter fewer notes than the value set in LENGTH, the quantize pattern is continued with the next note value, but using the beginning pitch in the sequence again.



OCTAVES
(1...4)

Here you determine if the arpeggio should be repeated in another octave than the one in which it was recorded. If you enter a 2 for this value, for example, the first playback of the sequence will be in the original octave, the first repetitions in the octave directly above the original. The maximum value is 4. The value 1 plays back the arpeggio in the original octave in which the notes were recorded.



REPEATS
(1...16)

The individual notes in an arpeggio can be repeated up to 16 times. If you set this value to 1, each note in the sequence is played only once.

VELOCITY

(OFF, 0...127)

If this value is OFF, the velocity (loudness) of the recorded notes are played back in the velocity at which they were recorded. Otherwise you can set the loudness of the playback notes to a constant level, 127 being the loudest.



```
ED: ARPEGGIATOR
VELOCITY: OFF
```

SEQ PATTERN

(OFF, 1...32)

If you own the AXON AX 100SB, you have the option alongside the normal Hold Preset, to set a drum pattern sequence (see UTILITY MODE, EDIT SEQUENCE). As soon as you press the hold pedal, the selected drum pattern will play on a separate MIDI channel. The pattern will be repeated until you press the hold pedal two times quickly. Choose one drum pattern of 1-32, that you want to play when you press the hold pedal, or set this parameter to OFF.



```
ED: ARPEGGIATOR
SEQ TRACK: OFF
```

SEQ TRACK

(OFF, 1...8)

If you own the internal sound board, you can set a complex track sequence to play instead of a pattern (see UTILITY MODE, EDIT SEQUENCE) parallel to the hold preset. As soon as you press the hold pedal, the selected track pattern will play on a separate MIDI channel. The pattern will be repeated until you press the hold pedal two times quickly. Or you can set the number of times that you want the sequence to be played. Choose one track pattern of 1-8, that you want to play when you press the hold pedal, or set this parameter to OFF. Please note that you can only use one of the two sequence possibilities at a time: either SEQ TRACK or SEQ PATTERN. Make sure the other one is set to OFF.



```
ED: ARPEGGIATOR
SEQ PATTERN: OFF
```

Editing HOLD Presets

While you are editing HOLDMD: SEP..., HOLDMD: LAYER... and HOLDMD: ARPEG..., it is possible to move directly to the parameter settings for the Hold Presets when the Hold preset is in the display by pressing the EDIT button. The first line of the display now shows the text: ED: <Presetname>. Except for the Effect types (only the SB), all parameters can be edited normally. When you press the EXIT button, you are taken back to where you were last. The display of the Hold preset name blinks until you save your changes using the STORE button.

```
ED: GPno1+HdPad
HOLDMD: CNTRL...
```

CNTRL...

With this function, you have the ability to link your Hold pedal to any MIDI controller you desire. When you press the hold pedal, the controller value is set to its maximum value 127 (7Fh). As soon as you release the pedal, the controller value 0 is sent. Controllers that work well with this function are Sustain (64), Portamento (65). To get to the sub menu, press the ENTER button to set the following parameters:

```
HOLDCONTROL IS:
PORTAMNT TIME 5
```

HOLD CONTROLLER

(CNTRL 0...119)

Choose the appropriate MIDI controller that will be set to its maximum value (127) when you press the hold pedal. The function of the controller will appear in text in your display.

```
HOLDCONTROL IS:
SEQ PATTERN: OFF
```

SEQ PATTERN

(OFF, 1...32)

If you own the AXON AX 100SB, you have the option alongside the normal Hold Preset, to set a drum pattern sequence (see UTILITY MODE, EDIT SEQUENCE). As soon as you press the hold pedal, the selected drum pattern will play on a separate MIDI channel. The pattern will be repeated until you press the hold pedal two times quickly. Choose one drum pattern of 1-32, that you want to play when you press the hold pedal, or set this parameter to OFF.

SEQ TRACK

(OFF, 1...8)

If you own the internal sound board, you can set a complex track sequence to play instead of a pattern (see UTILITY MODE, EDIT SEQUENCE) parallel to the hold preset. As soon as you press the hold pedal, the selected track pattern will play on a separate MIDI channel. The pattern will be repeated until you press the hold pedal two times quickly. Or you can set the number of times that you want the sequence to be played. Choose one track pattern of 1-8, that you want to play when you press the hold pedal, or set this parameter to OFF. Please note that you can only use one of the two sequence possibilities at a time: either SEQ TRACK or SEQ PATTERN. Make sure the other one is set to OFF.



```
HOLDCONTROL IS:
SEQ TRACK:    OFF
```

SEQ TEMPO

(EXT., 41...240)

The tempo of your sequence can be set externally using Midi clock (EXT/MIDI IN) or internally using BPM (beats per minute) between 41 (very slow) and 240 (very fast). In the case of external synchronization, (e.g.. MIDI-Drums, sequencer software) the sequence will only start when the “start” command is received from the MIDI IN port.



```
HOLDCONTROL IS:
SEQ TEMPO:    120
```

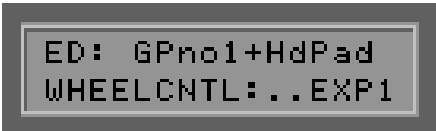
STACK...

The effect is the same as in Hold Mode LAYER. The difference is that in this mode the Hold pedal must not be explicitly pressed. The Layer effect is always available. Otherwise all parameters of LAYER mode are available. (see LAYER.)

WHEELCNTL...

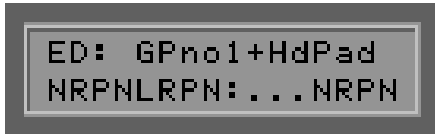
WHEEL CONTROLLER (AIX, EXP1, EXP2)

Your AXON offers you the option of using up to three different wheel controllers simultaneously: AIX is the wheel on the guitar interface AX101/102, EXP1 and EXP2 are swell pedals, which can be plugged into the back of the AXON. Choose the desired wheel using the +/- Value buttons, that you want to link a controller to, and press ENTER. The first line of the display shows the wheel that you just choose; the second line shows the controller that is assigned to the selected wheel. Use the +/- Value buttons to select the desired controller. The function of the selected controller appears in simple text in the display. The nonstandardized MIDI controllers have the “_____” description. The setting “NO CONTROLLER” means that no MIDI controller at all is assigned to the selected wheel. One practical use for this setting is for example, when you want to affect an arpeggio but not the main sound (preset) using the wheel on the guitar interface.



```
ED: GPno1+HdPad
WHEELCNTL:..EXP1
```

To do this, set the wheel AIX 101/102 to a Filter Controller (74). Your main preset should then be set to “NO CONTROLLER” instead of “VOLUME 7”, so that only the arpeggiator will be affected by the wheel and the volume setting of the main sound will remain constant. Use the EXIT button to get back to the main menu.



NRPN/RPN...

NRPN/RPN (NONE, NRPN, RPN)

Many manufacturers of synths allow you to set sound characteristics of their presets using so called NRPN’s (nonregistered parameter numbers) or RPN’s (registered parameter numbers). According to MIDI specifications RPN’s have standardized functions and NRPN’s do not. The functions of NRPN’s are dependent upon the manufacturer and are found in the individual user’s manuals. The process for using RPN’s and NRPN’s is identical as follows:

NRPN-LSB and MSB or RPN-LSB and MSB set system parameters using Controller #6 (DATA ENTRY MSB) or Controller #38 (DATA ENTRY LSB) to access them. Here is how you access these settings in your AXON:

You have extracted from the user’s manual of your synth/sound module that the manufacturer uses NRPN: MSB=01h and LSB=21h for a filter function for example. Use the +/- Value buttons to select the setting “NRPN/RPN:...NRPN” and press the ENTER button. The first line of your display shows you whether you are editing NRPN’s or RPN’s. The second line shows you the present value for MSB and LSB. The cursor is in the MSB field at first. Use the +/- Value buttons to set this value to 01h. With the +/- Parameter buttons move the cursor to the filed LSB and set the value here to 21h. You have now set the NRPN so that Controller #6 (or #38) can be used as a filter controller. As a source for controller #6/#38, you have the option of using Pick control or any of the three wheel options. If for example you set the AIX 101/102 wheel on your interface to controller #6/#38, you can now control the actual sound of your synth using the wheel. Press the EXIT button to leave the sub menu.

Note: If you are not an experienced user, it is advised that you steer clear of using the RPN controllers because pitchbend and even tuning information can be changed.

Another note for “Insiders”: Normally after using a DATA ENTRY controller for NRPN or RPN Data, these values are reset to “NULL” (7fh), so that the DATA ENTRY controller has no more influence. Your AXON does NOT do this, because this would drastically increase the amount of MIDI data processed and sent. However, when you change a Preset, or when you edit an NRPN/RPN, these controllers ARE set to NULL.

FINGER PICK

Finger picking (OFF, ON)

This parameter allows you to turn on a series of detailed settings that are particularly valuable for finger picking techniques. In this case however, you will not have access to the Pick split and Pick control functions. Make sure that the selected preset does not use Pick split and that the Pick controller is set to “NO CONTROLLER”.

```
ED: GPno1+HdPad
FINGER PICK: OFF
```

STRING SPLIT

String Split (1...5)

To implement a string split, enter the first string of the bottom split. The values are assigned to the strings, 1 being the high E-string. The value of 4 here means that the two Bass strings (5, 6) are set for the upper split and the 4 high strings for the lower string split zone.

```
ED: GPno1+HdPad
STRING SPLIT: 4
```

FRET SPLIT

Fret Split (0 ... 23)

If you are using a fret split in your preset, this parameter defines the first fret of the left segment (the left split on the front panel graphic). The frets are numbered starting with the lowest fret (furthest from the bridge) being fret number 1. Open strings are assigned the value of 0. The value of 4 means that frets 1 through 3 (including of course open strings) are assigned to the right split and frets 4 to the highest fret to the left split zone.

```
ED: GPno1+HdPad
FRET SPLIT: 13
```

```
ED: GPno1+HdPad
PICK SPLIT1: 36
```

PICK SPLIT 1 and 2

Pick Split 1 and 2 (0...99)

If you use the Pick split option with your Preset, this is where you set the width of each Pick segment between the bridge and the highest fret. This area of your guitar is divided into 100 units: 0 is the bridge and 99 is the top end of the fingerboard. If you want to divide the pick area into 2 segments, enter the split point for the segment furthest to the right into the parameter PICK SPLIT 1 (see graphic on front panel). If you enter the value 50, for example, you divide the pick area into two segments of equal size, dividing the pick area in the middle. If you want to divide the pick area into 3 segments, you need to enter a second value into PICK SPLIT 2 for the split point at the beginning of the left most segment. If, for example, you want to divide the pick area of your guitar into 3 equal-sized segments, set the value for PICK SPLIT 1 to 33 and the value for PICK SPLIT 2 for 66.

```
ED: GPno1+HdPad
REV: HALL1
```

REV

Reverb Program (NO EFFECT, HALL1...BASEMENT)

If your AXON is equipped with the optional sound module, you can use this parameter to choose one of several reverb options. The program name then appears in your display. If you don't want to use reverb, set this parameter to NO EFFECT.

```
ED: GPno1+HdPad
CHOR: CELESTE4
```

CHOR

Chorus Program (NO EFFECT, CHORUS1...FLANGER3)

The optional sound module is equipped with numerous chorus options, from which you can choose here. The name of the program you choose is shown in the display. Set this parameter to NO EFFECT if you don't want to use chorus.

```
ED: GPno1+HdPad
VAR: DELAY LCR
```

VAR

Variation Program (NO EFFECT, HALL1...AUTOWAH)

The optional sound module is equipped with further variation effects that can be mixed with reverb or chorus effects. The name of the chosen variation effect is shown in your display. If you don't want to use a variation effect, select NO EFFECT.

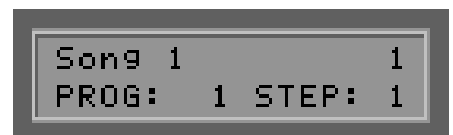
For more detailed information about the digital effects in the sound module and their programmable options, see the chapter UTILITY MODE.

Chain Mode

In live performance, you will need to have easy access to your various programmed presets. In Chain Mode, your AXON offers you the ability to “chain” presets together in a series that you can quickly and easily recall in the order that you need them for your performance. You can have up to 32 Chain Presets, each containing up to 32 “steps” or “links”. Using the UP/DOWN buttons on your guitar interface, you can toggle through the chain presets or the individual steps in a chain preset, and using a pedal, you can toggle through the steps in a chain. The footpedal is plugged into the jack “Chain” on the back of your AXON. Pressing the pedal once moves to the next step in the chain, pressing it twice quickly moves to the previous step. Combining use of the UP/DOWN buttons with the pedal, you have complete control of all your chains and the individual steps in them directly from your guitar (without having to access the front panel of your AXON).

Creating Chain Presets

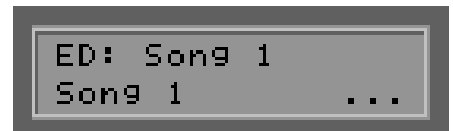
Press the CHAIN button on the front of your AXON, and select the desired chain preset using the +/- Value buttons. Press the EDIT button, and you are now ready to begin programming your chain. The following parameters can be accessed by pressing the +/- Parameter buttons:



CHAIN PRESET NAME

(max. 12 Characters)

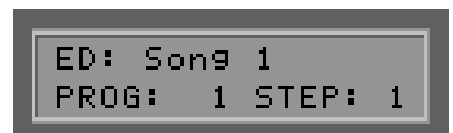
Use a name that describes the function of of your chain, e.g. the name of the song with which it will be used. Press the RETURN button and use the +/- Value buttons to select each character and the +/- Parameter buttons to maneuver to the next (or previous) character.. Press the EXIT button when you are finished naming your Chain Preset. As with all other Text-Editor functions some of the front panel buttons have special functions when in this mode (A...Z, a...z, !...9, space, insert, delete).



PROGRAM

(1...128)

Use the +/- Value buttons to select the desired Preset number for the present step. Press the ENTER button. This moves you to the next step in the chain.



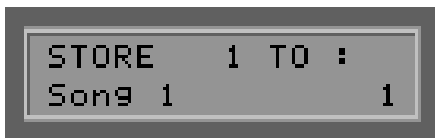
STEP

(1...32)

Using the +/- Value buttons, select the step in the chain you want to edit. In the display you see the program number of the presently selected preset for that step.

If you want to add a step in the middle of a chain, simply press the STORE button on the front panel. A new step is inserted directly after the selected step and all the following steps are moved one step down in the chain. When you create a new step, the default settings for the new step are the same as the step from which you inserted the new one.

In the same way you can delete a step in the chain by selecting the one you want to delete and pressing the EDIT button. The step is deleted and the following steps are moved one up in the chain to fill the empty spot.



Saving Chain Presets

Press the EXIT button to leave CHAIN MODE. If you have made changes, the display will flash to remind you that you have not yet saved the changes. Press the STORE button and your AXON asks you where (at which chain preset position: 1...32) to store your preset. Pressing the ENTER button saves your changes. If you don't change the preset number, your changes will be written over the preset that you just edited. You can, of course, save your changes to a different preset if you may want to save the previous version of the preset for later use. If you don't want to save your changes at all, simply press the EXIT button again.

UTILITY MODE

To activate **UTILITY MODE**, press the **UTIL** button on the front of your **AXON**. The LED next to the **UTIL** button will be lit.

Utility Parameters

Utility Mode controls the appearance of information in your display. This mode also controls the load and save functions via MIDI (**SYSEX**), so that you can save all of your valuable presets and parameters to a floppy disk using the appropriate communications software. Owners of the **AXON AX 100-SB** will find here numerous settings for drum sequences and programmable digital effects.

DISPLAY

Control instrument and the LCD display (**TUNING**, **LEVEL**)

Here you decide which instrument in **PRESET MODE** you want be shown in the bottom half of the display:

TUNING

With this setting selected, the bottom half of your **AXON**'s LCD display shows a guitar tuner, that can be used during play to check and correct the tuning of your input instrument. Tune each string so that the arrow points to the middle of the scale. If the Tune Base Parameter is set to 0 (zero), the middle point on the tuning scale in the display represents the standard tuning calibration of 440 Hertz.



LEVEL

With this selection, instead of a tuner, you see a **VU (LEVEL)** meter in the bottom half of the display. The small vertical bars represent the present levels of each of the six strings of your guitar. The higher the bar, the louder the string.



PRESET NAMES

Display of sound presets (patches) (NUM, GM, XG)

Your AXON has the ability to display selected presets in various forms:

NUM

All sound presets (patches) will be displayed in their numeric form in their given MIDI bank. A MIDI bank contains 128 preset numbers. It is possible to split MIDI banks using MSB (most significant byte) and LSB (least significant byte) information, so that you can actually have as many as 128 x 128 MIDI banks. Use this option if your sound module/synth is not GM (General MIDI) capable.

GM

The sound presets or patches follow the GM (General MIDI) standard. The names of patches appear in text form in the display. The General MIDI standard dictates 128 sounds, and some manufacturers of GM capable sound modules have implemented kits that allow for choosing various MIDI sound banks. Your AXON divides its MIDI bank into an MSB (most significant byte) and an LSB (least significant byte) data group, which allows 128 x 128 GM kits. Use this option if your sound module/synth is not GM (General MIDI) capable.

XG

The sound presets or patches follow the XG (Extended General MIDI) standard. The names of patches appear in text form in the display. Information about MIDI bank numbers is not included. If your MIDI instrument is XG capable, you should certainly make use of it. It is a very easy way to maintain an overview of the numerous normal patches available. The built-in sound module of the AXON AX 100-SB is XG compatible and offers you all of the XG sounds in superior quality.

DCLIC RESPNS

Double-click response (1...20)

Here you set the amount of time in which a double click (double press) of the two foot switches should take place in order to be recognized as a double click. Remember that you can double click the chain foot switch in order to jump one step back in your chain. Double clicking the Hold pedal allows you to stop the presently running drum sequence (AX100SB only).

XMIT SYSEX...**Send System Exclusive Data**

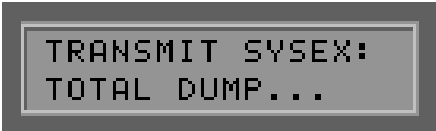
This sub menu gives you access to all the important parameters and settings that allow your AXON to send data over MIDI. The receiver can be a computer with the appropriate software (e.g. Sequencer software) or another AXON AX 100. One possibility would be to save the numerous settings of your AXON to a floppy disk to be shared with others, or as an archive for later use. Users of the AXON AX 100-SB can use this method to collect an entire sound library from external programmable synth section. Press the ENTER button and use the +/- Parameter buttons to select the area you would like to send. Use the +/- Value buttons to select individual parts. The transfer begins when you press the ENTER button again. When you see "READY" in the display, you know the transmission has been completed.



```
UTILITIES
XMIT SYSEX...
```

TOTAL DUMP...

This allows you to transmit the entire contents of the AXON with all its present parameters and settings in one large file.



```
TRANSMIT SYSEX:
TOTAL DUMP...
```

PRESET... (ALL, 1...128)

You can choose to send all 128 USER presets or individual ones.

CHAIN... (ALL, 1...32)

Sends all or individual Chain presets.

ARP-PATTRN...(ALL, 1...16)

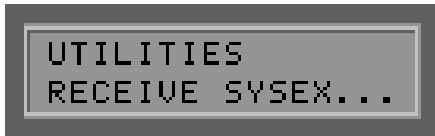
Send all or individual rhythm patterns used by the arpeggiator.

EFFECTS...(ALL, REV, CHOR, VAR)

Owners of the AXON AX 100-SB can choose to send the parameters for the entire effect section or just those for the individual areas: reverb, chorus, variation.

SEQUENC... (ALL, PATTRN, TRACKS)

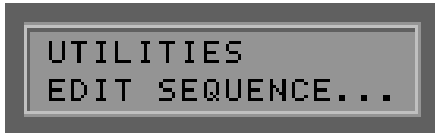
Owners of the AXON AX 100-SB can send their programmed drum sequences either in complete form or separately.



RECEIVE SYSEX

Receive System Exclusive Data

In the same way as the AXON sends sysex data to another AXON or computer via MIDI, it can also receive sysex data with the help of this sub menu. The data blocks that are received by the AXON will overwrite the same parameters in the AXON.

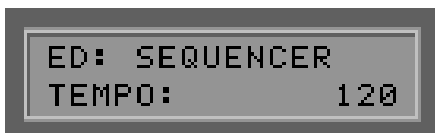


EDIT SEQUENCE...

Drum Sequence Editing

Owners of the AXON AX 100-SB have the option of programming drum sequences that can be accessed in PRESET MODE using the hold pedal. It is necessary to differentiate between pattern sequences and track sequences.

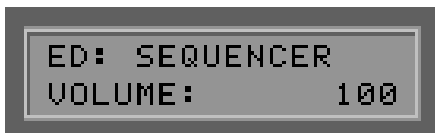
A pattern is made up of 16 steps that are divided into equal time units over the entire pattern. You have the option of choosing up to 4 drum sounds from any drum kit to be played within each step. This can be given 3 different dynamic levels. Up to 32 patterns can be created in the Pattern Editor. These patterns can then be integrated into a track sequence, that controls the playing of the pattern according to your wish. 32 program steps are possible that can be combined in any order or repetition. Press the ENTER button to get to the Drum sequencer menu.



TEMPO

Tempo (EXT, 41...240)

The tempo of the drum sequencer can be set externally using Midi clock (EXT/MIDI IN) or internally using BPM (beats per minute) between 41 (very slow) and 240 (very fast). In the case of external synchronization, (e.g.. MIDI-Drums, sequencer software) the sequence will only start when the “start” command is received from the MIDI IN port.



VOLUME

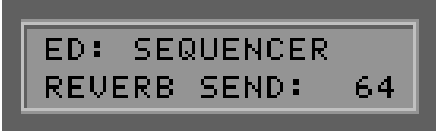
Volume Level (0...127)

The drum sequencer is equipped with its own separate volume control. Set the level here to create a good mix with the other sounds.

REVERB SEND

Reverb (0...127)

The drum sequencer is equipped with its own separate reverb control. Using the +/- Value buttons, set this value to your desired strength of reverb for drum sounds. If you want totally “dry” drums, select 0 (zero).

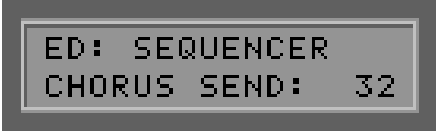


```
ED: SEQUENCER
REVERB SEND: 64
```

CHORUS SEND

Chorus (0...127)

Set your desired amount of chorus for drums here. If you don't want any chorus effect on the drums, set this value to 0 (zero).

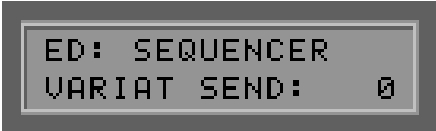


```
ED: SEQUENCER
CHORUS SEND: 32
```

VARIAT SEND

Variation Effect (0...127)

Set your desired amount of variation effect for drums here. If you don't want any chorus effect on the drums, set this value to 0 (zero).

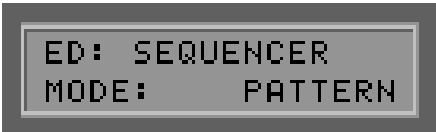


```
ED: SEQUENCER
VARIAT SEND: 0
```

MODE

Mode (PATTERN, TRACK)

As we have already discussed, your AXON allows two different ways to play drum sequences. You can play either individual patterns, or entire tracks made up of several patterns. Here is where you decide whether you want simple patterns or entire tracks to be played when you press the hold pedal in PRESET MODE.

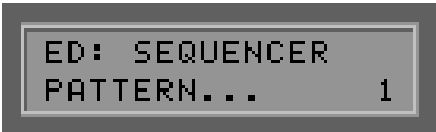


```
ED: SEQUENCER
MODE: PATTERN
```

PATTERN...

Pattern Editor (1...32)

With this sub menu, you can edit your drum patterns. You can create up to 32 patterns that can be played back either individually or as part of a track sequence. Use the +/- Value buttons to select the desired pattern number and press the ENTER button to begin editing it.



```
ED: SEQUENCER
PATTERN... 1
```



KIT (STANDARD1...SFX2)

There are 11 drum kits available, from which you can choose a maximum of four instruments for each pattern. Use the +/- Value buttons to select the drum kit from which you want to use drum sounds.



STEPS (1...16)

Here is where you select the actual step in the pattern you want to edit. Every step can contain 4 drum sounds with 3 different dynamic levels. The larger the number of steps you set with this parameter, the finer the resolution of your pattern will be. You can also set values for uneven meters. The value of 12, for example, will result in 3/4 time with a resolution of 16th notes.

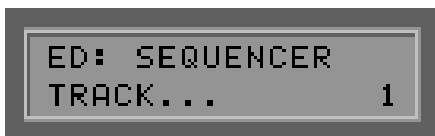


DRUM INSTRUMENT (1...4)

Choose a drum instrument from the list of drum sounds available in the presently active drum kit and press the ENTER button to begin editing. In the bottom half of the display appears a dotted line with a cursor whose position is dependent upon the individual steps (see STEPS). You can move the cursor to the left or right by using the +/- Parameter buttons. Use the +/- Value buttons to then add an accent at the proper step position. You will see a small vertical bar at that position. Press the +/- Value buttons repeatedly to increase or decrease the strength of the accent, visible in the display as a thicker or thinner bar. You can make the accent so weak that it disappears altogether. When you are finished, press the EXIT button. You can of course repeat this process for the 3 other instruments you have selected for the pattern. A further press of the EXIT button takes you out of the PATTERN EDITOR. The flashing display signals you that you have changed a pattern but have not yet saved it. Press STORE to save the pattern to battery-backed-up RAM.



TRACK...




Track Editor (1...8)

With the help of this sub menu, you can use the Track Editor for drum sequences to create up to 8 tracks that can be accessed from PRESET MODE by pressing the hold pedal. A track sequence contains up to 32 steps in which your own programmed patterns can be combined in any order or repeated as desired. Use the +/- Value buttons to select the desired track number and press the ENTER button to begin editing. Press the EXIT button when finished. The following is a description of the parameters in the sub menu:

ST: (0...31)

Here you select the step number of the track sequence you want to work on. The individual steps will then be chained together step-wise according to their number. You can have a maximum of 32 steps.



```
ED: TRACK 1
ST: 0 C: 1 PT: 1
```

C: (0...127)

This is the number of repeats the pattern will execute within the step. The value 1 plays the pattern one time. The value 0 (zero) indicates the end of a track sequence. When the drum sequencer gets to this point, it will automatically stop playing.


PT: (1...32)

Choose the pattern number to be used in the selected step (ST).

When you press EXIT, the flashing display indicates that you have not yet saved your changes to the track. Press STORE to save your changes in battery-backed-up RAM.



```
UTILITIES
EDIT 05300...
```



```
ED: 05300
Cry Baby 5...
```



UTILITIES
EDIT REVERB...

EDIT REVERB...

Owners of the AXON AX 100-SB can customize the built-in reverb effect in the sound board. You need to first select one of the 11 types of reverb effects available in your AXON. Depending upon the type of reverb you've selected, there are different parameters available for customizing.

REVERB TYPES

NO EFFECT:

Turns the reverb off.

HALL1:

Simulates the reverb found in a concert hall.

HALL2:

A variation of HALL1.

ROOM1:

Simulates the reverb found in a normal room.

ROOM2:

A variation of ROOM1.

ROOM3:

A variation of ROOM1.

STAGE1:

For use with a solo instrument's reverb program.

STAGE2:

A variation of STAGE1.

PLATE:

Simulates the reverb effect generated by metal plate reverb units found in recording studios.

WHITE ROOM:

A short reverb program followed by a fast delay.

TUNNEL:

Simulates a tunnel that becomes increasingly wider.

BASEMENT:

A short delay followed by massive reverb.

Reverb Parameters

It would be impossible for us to describe in detail the various effects and parameters available for various reverb possibilities and it's not our purpose to do that here. The following is general description. There is specific literature available if you want more information than you find here.



PROGRAMS: HALL1,2, ROOM1,2,3, STAGE1,2, PLATE:

RevTime (0.3s ... 30.0s) / Reverb length
 Diffusion (0 ... 10) / Diffusion of reverb reflections
 PreDelay (0.1ms ... 99.3ms) / Delay before reverb
 HPF Cut (20Hz ... 8.0kHz) / High Pass Filtercutoff
 LPF Cut (1.0kHz ... 20.0kHz) / Low Pass Filtercutoff
 Dry/wet (1 ... 127) / Amount of effect
 RevDelay (0.1ms ... 99.3ms) / Amount of reverb delay
 Density (0 ... 3) / Reverb Intensity
 Er/rev Bal (1 ... 127) / Balance
 Fdbck Level (-63 ... +63) / Level of Feedback

PROGRAMS: WHITE ROOM, TUNNEL, BASEMENT:

RevTime (0.3s ... 30.0s) / Reverb length
 Diffusion (0 ... 10) / Diffusion of Reverb Reflections
 PreDelay (0.1ms ... 99.3ms) / Delay before Reverb
 HPF Cut (20Hz ... 8.0kHz) / High Pass Filtercutoff
 LPF Cut (1.0kHz ... 20.0kHz) / Low Pass Filtercutoff
 Width (0.5 ... 10.2) / Room width in Meter
 Height (0.5 ... 20.2) / Room height in Meter
 Depth (0.5 ... 30.2) / Room length in Meter
 Wall vary (0 ... 30) / Simulation of the Walls
 Dry/wet (1 ... 127) / Amount of effect
 RevDelay (0.1ms ... 99.3ms) / Reverb Delay
 Density (0 ... 3) / Reverb Intensity
 Er/rev Bal (1 ... 127) / Balance
 Fdbck Level (-63 ... +63) / Feedback level

GLOBAL REVERB PARAMETERS

Reverb Ret (-64 ... +63) / Amount of Reverb Return Signal
 Reverb Pan (L63 ... R63) / Reverb Panorama



UTILITIES
EDIT CHORUS...

EDIT CHORUS...

Owners of the AXON AX 100-SB can customize the built-in chorus effect in the sound board. You need to first select one of the 11 types of chorus effects available in your AXON. Depending upon the type of chorus you've selected, there are different parameters available for customizing.

CHORUS TYPES

NO EFFECT:

Turns Chorus off.

CHORUS1:

Conventional chorus effect for a full sound.

CHORUS2:

Variation of CHORUS1-Effect.

CHORUS3:

Variation of CHORUS1-Effect.

CHORUS4:

Variation of CHORUS1-Effect with Stereo-Input.

CELESTE1:

LFO modulated in 3 Phases.

CELESTE2:

Variation of CELESTE1-Effect.

CELESTE3:

Variation of CELESTE1-Effect.

CELESTE4:

LFO modulated in 3 Phases.

FLANGER1:

Chorus with Phase-shifting (Jet-Effect)

FLANGER2:

Variation of FLANGER1-Effect.

FLANGER3:

Variation of FLANGER1-Effect.

Chorus parameters

It would be impossible for us to describe in detail the various effects and parameters available for various reverb possibilities and it's not our purpose to do that here. The following is general description. There is specific literature available if you want more information than you find here.



PROGRAMS: CHORUS1,2,3,4, CELESTE1,2,3,4:

LFO Freq (0.00Hz ... 39.70Hz) / Frequency of the Low Freq. Osc.
 LFO PM Depth (0 ... 127) / Depth of Pitch-Modulation
 Fdbck Level (-63 ... +63) / Feedback level
 Delay Offs (0.0 ... 50.0) / Delay offset for Modulation
 EQ Low (50Hz ... 2.0kHz) / Equalization for low Freq.
 EQ LowGain (-12dB ... +12dB) / EQ-level for lower frequencies
 EQ Hi (500Hz ... 16.0kHz) / Equalization for high Freq.
 EQ HiGain (-12dB ... +12dB) / EQ-level for higher frequencies
 Dry/wet (1 ... 127) / Amount of effect
 Input (MONO, STEREO) / Input signal MONO or STEREO

PROGRAMS: FLANGER1,2,3:

LFO Freq (0.00Hz ... 39.70Hz) / Frequency of the Low Freq. Osc.
 LFO Depth (0 ... 127) / Modulation depth
 Fdbck Level (-63 ... +63) / Feedback level
 Delay Offs (0.0 ... 50.0) / Delay offset for Modulation
 EQ Low (50Hz ... 2.0kHz) / Equalization for low Freq.
 EQ LowGain (-12dB ... +12dB) / EQ-level for low frequencies
 EQ Hi (500Hz ... 16.0kHz) / Equalization for high Freq.
 EQ HiGain (-12dB ... +12dB) / EQ-level for high frequencies
 Dry/wet (1 ... 127) / Amount of effect
 LFO Phase (-180° ... +180°) / LFO phase control

GLOBAL CHORUS PARAMETERS

Chorus Ret (-64 ... +63)
 Chorus return signal.

Chorus Pan (L63 ... R63)
 Panorama of the chorus signal.

Chor -> Rev (0 ... 127)
 Mixes the chorus effect .with Reverb. The higher the value, the more chorus in the mix.

EDIT VARIAT ...

Owners of the AXON AX 100-SB can customize the built-in variation effect in the sound board. You need to first select one of the 42 types of variation effects available in your AXON. Depending upon the type of variation you've selected, there are different parameters available for customizing.

VARIATIONS EFFECT TYPES

NO EFFECT:

Turns variation effects off.

HALL1:

Simulates reverb in a concert hall.

HALL2:

Variation of HALL1 Effect.

ROOM1:

Simulates reverb in a normal room.

ROOM2:

Variation of ROOM1 Effect.

ROOM3:

Variation of ROOM1 Effect.

STAGE1:

For use with a solo instruments reverb program.

STAGE2:

Variation of STAGE1 Effect.

PLATE:

Simulates the metal plate reverb system found in recording studios.

DELAY L;C;R:

Delay effect (Panoramaposition Left, Right, Center).

DELAY L;R:

Delay effekt (Panoramaposition Links und Rechts).

ECHO:

Echoeffect with independent feedback control for left and right.

CROSSDLY:

Delay effect with changing Panorama-Feedback-Loops.



UTILITIES
EDIT VARIAT...

EARLYREF1:

Only generates the first reverb reflection.

EARLYREF2:

Variation of EARLY REF1-Effect.

GATED REV:

Gated Reverb Effect. (made popular by Phil Collins)

REV GATE:

Reverse Gated Reverb Effekt.

KARAOKE 1:

A Karaoke-typical reverb effect.

KARAOKE 2:

Variation of KARAOKE 1-Effect.

KARAOKE 3:

Variation of KARAOKE 1-Effect.

CHORUS1:

Conventional chorus effect for a full sound.

CHORUS2:

Variation of CHORUS1-Effect.

CHORUS3:

Variation of CHORUS1-Effect.

CHORUS4:

Variation of CHORUS1-Effect with Stereo-Input.

CELESTE1:

LFO with 3 Phase Modulation.

CELESTE2:

Variation of CELESTE1-Effect.

CELESTE3:

Variation of CELESTE1-Effect.

CELESTE4:
LFO with 3 Phase Modulation.

FLANGER1:
Chorus with Phaseshifting (Jet-Effect)

FLANGER2:
Variation of FLANGER1-Effect.

FLANGER3:
Variation of FLANGER1-Effect.

SYMPHONIC:
Multi-Phase-variant of CELESTE1-Effect.

ROTARY:
Simulation of a Leslie cabinet.

TREMOLO:
Effect based on amplitude variation.

AUTO PAN:
Effect based on panorama variation.

PHASER1:
Effect based on phase shifting.

PHASER2:
Variation of PHASER1-Effect with Stereo-Input.

DISTORTION:
Distortion simulator.

OVERDRIVE:
Simulation of overdriving a tube guitar amplifier.

GUITARAMP:
Simulation a tube guitar amplifier.

3BANDEQU:
A MONO-Equalizer with controls for Lows, Mids, Highs..

2BANDEQU:
A STEREO-Equalizer with controls for Lows, Mids, Highs.

AUTOWAH:
Automatic Wah-Wah Effect.

Variations Effect Parameters

It would be impossible for us to describe in detail the various effects and parameters available for various reverb possibilities and it's not our purpose to do that here. The following is general description. There is specific literature available if you want more information than you find here.



PROGRAMS HALL1 ... PLATE:

(see. Reverb parameters)

PROGRAMS DELAY L,C,R:

Lch Dly (0.1ms ... 715.0ms) / Delay left channel
 Rch Dly (0.1ms ... 715.0ms) / Delay right channel
 Cch Dly (0.1ms ... 715.0ms) / Delay Center
 Fdb Dly (0.1ms ... 715.0ms) / Feedback Delay
 Fdbck Level (-63 ... +63) / Feedback level
 Cch Level (0 ... 127) / Center level
 High Damp (1 ... 10) / Highs roll-off
 Dry/wet (1 ... 127) / Amount of effect signal
 EQ Low (50Hz ... 2.0kHz) / Equalization for low freq.
 EQ LowGain (-12dB ... +12dB) / EQ-Level for low freq.
 EQ Hi (500Hz ... 16.0kHz) / Equalization for high Freq.
 EQ HiGain (-12dB ... +12dB) / EQ-Level for high frequencies

PROGRAM DELAY L,R:

Lch Dly (0.1ms ... 715.0ms) / Delay right channel
 Rch Dly (0.1ms ... 715.0ms) / Delay left channel
 Fdb1 Dly (0.1ms ... 715.0ms) / Feedback 1 Delay
 Fdb2 Dly (0.1ms ... 715.0ms) / Feedback 2 Delay
 Fdbck Level (-63 ... +63) / Feedback level
 High Damp (1 ... 10) / Highs roll-off
 Dry/wet (1 ... 127) / Amount of effect signal
 EQ Low (50Hz ... 2.0kHz) / Equalization for low Freq.

EQ LowGain (-12dB ... +12dB) / EQ-Level for low Freq.
 EQ Hi (500Hz ... 16.0kHz) / Equalization for high Freq.
 EQ HiGain (-12dB ... +12dB) / EQ-Level for high frequencies

PROGRAM ECHO:

Lch Dly1 (0.1ms ... 355.0ms) / Left Channel Delay 1
 Lch Fdbck (-63 ... +63) / Left Channel Feedback
 Rch Dly1 (0.1ms ... 355.0ms) / Right Channel Delay 1
 Rch Fdbck (-63 ... +63) / Right Channel Feedback
 High Damp (1 ... 10) / Highs roll-off
 Lch Dly2 (0.1ms ... 355.0ms) / Left Channel Delay 2
 Rch Dly2 (0.1ms ... 355.0ms) / Right Channel Delay 2
 Delay2 Lev (0 ... 127) / Delay 2 Level
 Dry/wet (1 ... 127) / Amount of echo
 EQ Low (50Hz ... 2.0kHz) / Equalization for low Freq.
 EQ LowGain (-12dB ... +12dB) / EQ-Level for low freq.
 EQ Hi (500Hz ... 16.0kHz) / Equalization for high Freq.
 EQ HiGain (-12dB ... +12dB) / EQ-Level for high frequencies

PROGRAM CROSSDLY:

L ->R Dly (0.1ms ... 355.0ms) / Crossdelay Left/Right
 R ->L Dly (0.1ms ... 355.0ms) / Crossdelay Right/Left
 Fdbck Level (-63 ... +63) / Feedback level
 Inp Select (L, R, L&R) / Input selection for L, R, or both
 High Damp (1 ... 10) / Highs roll-off
 Dry/wet (1 ... 127) / Amount of effect signal
 EQ Low (50Hz ... 2.0kHz) / Equalization for low Freq.
 EQ LowGain (-12dB ... +12dB) / EQ-Level for low frequencies
 EQ Hi (500Hz ... 16.0kHz) / Equalization for high Freq.
 EQ HiGain (-12dB ... +12dB) / EQ-level for high frequencies

PROGRAM EARLYREF1,2:

Type (SHORT, LARGE, RANDOM, REVERS, PLATE, SPRING) /
 Reverb-Typ
 Room size (0.1m ... 7.0m) / Size of room
 Diffusion (0 ... 10) / Diffusion reverb reflections
 PreDelay (0.1ms ... 99.3ms) / Delay before reverb
 Fdbck Level (-63 ... +63) / Feedback level
 HPF Cut (20Hz ... 8.0kHz) / Low frequency Cutoff
 LPF Cut (1.0kHz ... 20.0kHz) / High frequency Cutoff
 Dry/wet (1 ... 127) / Amount of effect signal
 Liveness (0 ... 10) / Liveness
 Density (0 .. 3) / Intensity
 High Damp (1 ... 10) / Highs roll-off

PROGRAMS GATED REV, REV GATE:

Type (TYPE A, TYPE B, L<->RB, L->RB, L<-RB, LTURNB) /
 Reverb-Typ
 Room size (0.1m ... 7.0m) / Size of room
 Diffusion (0 ... 10) / Diffusion of reverb reflections
 PreDelay (0.1ms ... 99.3ms) / Delay before reverb
 Fdbck Level (-63 ... +63) / Feedback level
 HPF Cut (20Hz ... 8.0kHz) / Low frequency Cutoff
 LPF Cut (1.0kHz ... 20.0kHz) / High frequency Cutoff
 Dry/wet (1 ... 127) / Amount of effect signal
 Liveness (0 ... 10) / Liveness
 Density (0 .. 3) / Intensity
 High Damp (1 ... 10) / Highs roll-off

PROGRAMS KARAOKE1,2,3:

DlyTime (0.1ms ... 200.0ms) / Delay-Time
 Fdbck Level (-63 ... +63) / Feedback level
 HPF Cut (20Hz ... 8.0kHz) / Low frequency Cutoff
 LPF Cut (1.0kHz ... 20.0kHz) / High frequency Cutoff
 Dry/wet (1 ... 127) / Amount of effect signal

PROGRAMS CHORUS1 ... FLANGER3:

(see Chorus Parameter)

PROGRAM SYMPHONIC:

LFO Freq (0.00Hz ... 39.70Hz) / Frequency of the Low Frequency
 Oscillators
 LFO Depth (0 ... 127) / Modulation depth
 Delay Offs (0.0 ... 50.0) / Delay offset for the Modulation
 EQ Low (50Hz ... 2.0kHz) / Equalization for low Freq.
 EQ LowGain (-12dB ... +12dB) / EQ-Level for low frequencies
 EQ Hi (500Hz ... 16.0kHz) / Equalization for high Freq.
 EQ HiGain (-12dB ... +12dB) / EQ-level for high frequencies
 Dry/wet (1 ... 127) / Amount of effect signal

PARAMETERS THE LESLIE PROGRAM:

LFO Freq (0.00Hz ... 39.70Hz) / Frequency of Low Frequency Oscillator
 LFO Depth (0 ... 127) / Modulation depth
 EQ Low (50Hz ... 2.0kHz) / Equalization for low Freq.
 EQ LowGain (-12dB ... +12dB) / EQ-Level for low frequencies
 EQ Hi (500Hz ... 16.0kHz) / Equalization for high Freq.
 EQ HiGain (-12dB ... +12dB) / EQ-level for high frequencies
 Dry/wet (1 ... 127) / Amount of effect signal

PROGRAM TREMOLO:

LFO Freq (0.00Hz ... 39.70Hz) / Freq. of Low Frequency Oscillators
 AM Depth (0 ... 127) / Depth of amplitude modulation
 PM Depth (0 ... 127) / Depth of pitch modulation
 EQ Low (50Hz ... 2.0kHz) / Equalization for low Freq.
 EQ LowGain (-12dB ... +12dB) / EQ-Level for low frequencies
 EQ Hi (500Hz ... 16.0kHz) / Equalization for high Freq.
 EQ HiGain (-12dB ... +12dB) / EQ-level for high frequencies
 LFO Phase (-180° ... +180°) / LFO Phase difference
 Input (MONO, STEREO) / Input MONO or STEREO

PROGRAM AUTOPAN:

LFO Freq (0.00Hz ... 39.70Hz) / Frequenz of the Low Frequency Oscillator
 L/R Depth (0 ... 127) / Depth left and right
 PM Depth (0 ... 127) / Depth front and back
 Pan Direc (L<->R, L->R, L<-R, LTURN, RTURN, L/R) / Direction of Panorama shifting
 EQ Low (50Hz ... 2.0kHz) / Equalization for low Freq.
 EQ LowGain (-12dB ... +12dB) / EQ-Level for low frequencies
 EQ Hi (500Hz ... 16.0kHz) / Equalization for high Freq.
 EQ HiGain (-12dB ... +12dB) / EQ-level for high frequencies

PROGRAMS PHASER1,2:

LFO Freq (0.00Hz ... 39.70Hz) / Frequenz of the Low Frequency Oscillator

LFO Depth (0 ... 127) / Modulation depth

Phase Offset (0 ... 127) / Phaseshift Offset

Fdbck Level (-63 ... +63) / Feedback level

EQ Low (50Hz ... 2.0kHz) / Equalization for low Freq.

EQ LowGain (-12dB ... +12dB) / EQ-Level for low frequencies

EQ Hi (500Hz ... 16.0kHz) / Equalization for high Freq.

EQ HiGain (-12dB ... +12dB) / EQ-level for high frequencies

Dry/wet (1 ... 127) / Amount of effect signal

Stage (PHASER1: 6 ... 10, PHASER2: 3 ... 5) / Phaser-Step

Diffusion (MONO, STEREO) / Mono- or Stereo

LFO Phase (-180° ... +180°) / LFO Phase control

PROGRAMS DISTORTION, OVERDRIVE:

Drive (0 ... 127) / Amount of overdrive

EQ Low (50Hz ... 2.0kHz) / Equalization for low Freq.

EQ LowGain (-12dB ... +12dB) / EQ-level for low Frequencies

LPF Cut (1.0kHz ... 20.0kHz) / Cutoff of upper frequencies

Output Level (0 ... 127) / Output level

EQ Mid (500Hz ... 10.0kHz) / Equalization for midrange Freq.

EQ Mid Gain (-12dB ... +12dB) / EQ-Level for midrange frequencies

EQ Mid Width (10 ... 120) / Equalization for Midrange

Dry/wet (1 ... 127) / Amount of effect signal

Edge (0 ... 127) / Clipping-Curve

PROGRAM GUITARAMP:

Drive (0 ... 127) / Overdrive

AMP type (OFF, STACK, COMBO, TUBE) / Amplifier type

LPF Cut (1.0kHz ... 20.0kHz) / Cutoff of highrange frequencies

Output Level (0 ... 127) / Output level

Dry/wet (1 ... 127) / Amount of effect signal

Edge (0 ... 127) / Clipping-Curve

PROGRAM 3BANDEQU:

EQ LowGain (-12dB ... +12dB) / EQ-Level for lowrange frequencies
 EQ Mid (500Hz ... 10.0kHz) / Equalizer for midrange Freq.
 EQ Mid Gain (-12dB ... +12dB) / EQ-Level for midrange frequencies
 EQ Mid Width (10 ... 120) / Equalizer for midrange Freq.
 EQ HiGain (-12dB ... +12dB) / EQ-Level for highrange frequencies
 EQ Low (50Hz ... 2.0kHz) / Equalizer for lowrange Freq.
 EQ Hi (500Hz ... 16.0kHz) / Equalizer for highrange frequencies

PROGRAM 2BANDEQU:

EQ Low (50Hz ... 2.0kHz) / Equalization for low Freq.

EQ LowGain (-12dB ... +12dB) / EQ-Level for low frequencies
 EQ Hi (500Hz ... 16.0kHz) / Equalization for high Freq.
 EQ HiGain (-12dB ... +12dB) / EQ-level for high frequencies

PROGRAM AUTOWAH:

LFO Freq (0.00Hz ... 39.70Hz) / Frequency of the Low Frequency Oscillator
 LFO Depth (0 ... 127) / Modulation depth
 Cutoff Offs (0 ... 127) / Cutoff Frequency Offset
 Resonance (10 ... 120) / Resonance
 EQ Low (50Hz ... 2.0kHz) / Equalization for low Freq.
 EQ LowGain (-12dB ... +12dB) / EQ-Level for low frequencies
 EQ Hi (500Hz ... 16.0kHz) / Equalization for high Freq.
 EQ HiGain (-12dB ... +12dB) / EQ-level for high frequencies
 Dry/wet (1 ... 127) / Amount of effect signal

GLOBALE VARIATIONSPARAMETER

Var Ret (-64 ... +63)
 Amount of variation effect signal

Var Pan (L63 ... R63)
 Panorama placement of variation effect.

Var -> Rev (-64 ... +63)
 Mixes variation effect signal with reverb signal. The higher the value, the more variation in the mix.

Var -> Chor -(-64 ... +63)

Var Connect (INS, SYS)

In SYS, the normal setting, variation effects are sent to all 16 MIDI channels. If this value is INS, variation effect will only be sent to the MIDI channel set in VarPart (see below).

Var Part (OFF, 1... 16)

If you want to send variation effect to only one MIDI channel, you can set this value to the channel of your choice. You must, however, also have set VarConnect (see above) to INS.

ADC MONITOR

This option allows you a small window into the actual ANALOG/DIGITAL CONVERTER of your AXON. When you press the ENTER button, you can see the actual (digital) HEX data that have been converted by your AXON from the analog string information sent from your guitar. This feature is primarily for diagnostic purposes like detecting which conductor of the cable between guitar interface and AXON may be bad, for example.



```
UTILITIES
ADC MONITOR...
```

Appendix

FACTORY RESET

Press the PRESET and EXIT buttons together to initialize the AX100 and reset it to the factory settings. This applies to all presets as well, so be sure to save your work to a sequencer or computer beforehand.

Factory Presets

Presets starting at number 129 have been preprogrammed in ROM at the factory. We have created these to demonstrate the flexibility and complexity that your AXON has to offer. You can play with them and experiment with them at will, and if you want to save any of your changes to the factory presets, you can do that within the USER area: 1...128. Here is a short description of each of the factory presets:

129. GPno1+HdPad : Simple preset with no split function. Uses a basic piano sound. Pitchbend has been turned off. For notes played and bent or slid on your guitar that bend the pitch more than one half step, a new MIDI Note On event is sent. You can use a hold pedal to play a pad sound in the background.

130. EPno2+HdPad : Simple preset with no split function. Uses an electric piano sound. Pitchbend has been turned on, but with pitch quantize. That means that for notes played and bent or slid on your guitar that bend the pitch more than one half step, the pitch jumps in half step increments. You can use a hold pedal to play a pad sound in the background.

131. Flute+HdPad : Simple preset with no split function. Uses a basic flute sound. Pitch quantize is ON and makes realistic trills possible using string vibrato for example, especially in the higher range. You can use a hold pedal to play a pad sound in the background.

132. Marmb+HdPad : Simple preset with no split function. Uses a basic percussion sound. You can use a hold pedal to play a pad sound in the background.

133. Orgn1+HdPad : Simple preset with no split function. Uses a basic organ sound. Especially noteworthy here is the parameter "Velocity Sensitivity" which has been set to 0 (zero) and the Offset belonging to it to 63. In this case all notes sound with the same velocity (level). You can use a hold pedal to play a pad sound in the background.

134. JzGt1+HdPad : Simple preset with no split function. Uses a basic Electric guitar sound. Of course now we want to pay attention to stringbends, etc. so that each string will react the way live guitar would be played. You can use a hold pedal to play a pad sound in the background.

135. RkGt1+HdPad : Simple preset with no split function. Uses a distorted guitar sound. You can use a hold pedal to play a pad sound in the background.

136. Bass1+HdPad : Simple preset with no split function. Uses a fretless bass guitar sound. Note: “Transpose” has been set to -12 so that the bass guitar sound played on your guitar will be in the correct octave. You can use a hold pedal to play a pad sound in the background.

137. Bass2+HdPad : Simple preset with no split function. Uses a synthesizer bass guitar sound. Note: “Transpose” has been set to -12 so that the bass guitar sound played on your guitar will be in the correct octave. You can use a hold pedal to play a pad sound in the background.

138. Strg1+HdPad : Simple preset with no split function. Uses a basic string sound. You can use a hold pedal to play a pad sound in the background.

139. Trmp1+HdPad : Simple preset with no split function. Uses a basic Trumpet sound. Pitch Quantize has been turned ON to make realistic trills possible from your guitar using String vibrato. You can use a hold pedal to play a pad sound in the background.

140. Sax1+HdPad : Simple preset with no split function. Uses a basic Saxophone sound. Pitch Quantize is ON. You can use a hold pedal to play a pad sound in the background.

141. Lead1+HdPad : Simple preset with no split function. Uses a basic synthesizer sound. You can use a hold pedal to play a pad sound in the background.

142. Pad1+HdPad : Simple preset with no split function. Uses a basic synthesizer sound. You can use a hold pedal to play a pad sound in the background.

143. ADrm1+HdPad : Simple preset with no split function. Uses a basic analog drum kit. “Transpose” has been set to -10 to allow you to play a bass drum using the open low E-string. You can use a hold pedal to play a pad sound in the background.

144. Synt1+HdPad :

145. Synt2+HdPad :

146. Synt3+HdPad :

147. Synt4+HdPad : Simple presets with no split function. Use some synth sound from the internal sound board. You can use a hold pedal to play a pad sound in the background.

148. PC:Organ+Mod : Preset with Pick Control. Uses an organ sound with Modulation. The intensity of the modulation is controlled by where you pick your guitar.

149. PC:Sax+Reverb : Preset with Pick Control. Uses a saxophone sound. The intensity of the reverb is controlled by where you pick your guitar.

150. PC:Synth+Pan : Preset with Pick Control. Uses a synthesizer sound. The panorama placement is controlled by where you pick your guitar.

151. PC:Bass+Filt : Preset with Pick Control. Uses a synthesizer bass sound. A filter is controlled by where you pick your guitar.

152. WH:Organ+Mod : Preset with Wheel control. Basically the same as “PC:Organ+Mod”, the difference being that now the intensity of the modulation is controlled using the wheel on the guitar interface instead of pick control.

153. WH:Bass+Filt : Preset with Wheel control. Same as “PC:Bass+Filt” only the filter is controlled by the wheel on the guitar interface instead of pick control. Note: if you want to use this preset as an arpeggiator preset, you can control the filter with the wheel while the arpeggiator is playing its sequences. In this way you can create typical techno grooves. In this case it would be advantageous to have a swell foot pedal (connected to EXP1 or EXP2), in order to use the swell pedal to control the filter, leaving the wheel free to control the volume.

154. HC:Trmp+Mod : Preset with hold controller. The trumpet sound used here can be modulated with a modulation effect by pressing a foot pedal. When you release the pedal, the modulation value will return to its default value (usually zero).

155. HC:Synt+Port : Preset with hold controller and pick control function. Portamento effect is used here. Portamento needs two controllers: one to turn the effect off and on, and the other to control the portamento time parameter. Here the portamento time is controlled using pick control. We have set the default values for both ends of the pick splits to the same value so that no matter where you pick, the portamento time remains the same. You can change these values to suite your needs. The hold pedal switches portamento ON when depressed and OFF when released.

156. HL:Pian+Bass : Preset with layer function. Layers two presets one on top of the other. The piano sound will have Preset 9, “Bass2+HdPad” added to it when the hold pedal is pressed. The bass sound is assigned a separate MIDI channel.. When the pedal is released, only the piano sound will be heard.

157. HL:Sax+Bass : Preset with layer function. Similar to “HL:Pian+Bass”. Two presets layered one on top of the other. The saxophone sound will have Preset 9, “Bass2+HdPad” added to it when the hold pedal is pressed. The bass sound is assigned a separate MIDI channel.. When the pedal is released, only the piano sound will be heard.

158. HL:EPno+Five : Preset with layer function. Similar to “HL:Pian+Bass”. Two presets layered one on top of the other. The saxophone sound will have Preset 9, “EPiano Fifth” added to it when the hold pedal is pressed. The two sounds are basically identical except for the fact that the layered piano sound has been transposed a perfect fifth up. The fifth piano sound is assigned a separate MIDI channel.. When the pedal is released, only the piano sound will be heard.

159. HA:16thMarmb : Preset with arpeggiator. The main sound is a piano sound; the arpeggiator is assigned Preset 4, “Marmb+HdPad”. In this example the arpeggiator generates classic 16th notes in 3 octaves.

160. HA:BluesBass : Preset with arpeggiator. The main sound is a jazz guitar sound; the arpeggiator is assigned Preset 8 “Bass1+HdPad”. This example shows how the arpeggiator can be used as a bass sequencer. Recommendation: Press the hold pedal and play a low A and then release the pedal. You can now improvise with your guitar. Later you can add several notes to the bass line, holding down the pedal. If you press and release the pedal without playing any notes, the arpeggiator stops.

It’s also possible to play a preprogrammed drum pattern. To stop the drum sequencer, you need to press the pedal 2 times quickly... a sort of double-click. We have not activated the drum sequencer for our factory presets. You can do that at any time by setting the parameters “SEQ PATTERN” or “SEQ TRACK” in the Arpeggiator Parameter section.

161. HA:RockBass : Preset with arpeggiator. Similar to the above preset. The main sound is a distorted guitar sound; the arpeggiator is assigned Preset 8 “Bass1+HdPad”. The arpeggiator generates a simple driving bass groove.

162. HA:HouseStuf : Preset with arpeggiator. The main sound is a synth sound; the arpeggiator is assigned Preset 5 “Orgn1+HdPad”. This example demonstrates once again the use of rhythmic arpeggios. Interesting results can be obtained by entering simple random bass notes with the pedal depressed. While the arpeggiator is playing, switch to the arpeggio menu and experiment with various parameters, especially SCAN, SYNC, OCTAVES and REPEAT. Or activate a drum pattern that can be started with a pedal press. To stop the drum sequencer it is necessary to press the pedal 2 times quickly.

163. HS Bass+Pno 5: Preset with layered sound. The second preset (Hold Preset) is immediately turned on... Hold pedal not necessary. The main preset uses a bass sound which is layered with the preset EPiano Fifth.

164. HS Brass+Sect: Preset with layered sound. The second preset (Hold Preset) is immediately turned on... Hold pedal not necessary. The main preset uses an Altosax sound which is layered with the preset Trumpet.

165 HS Morph Vol: Preset with layered sound. Here layering is controlled by pick position. The pick controller is identical for both presets (CC:VOLUME) only reversing the values for PICKVAL1 and PICKVAL2.

166 HS:MorphAtck: Preset with layered sound. Similar to the previous preset:HS:MorphVol except that Controller #73 (ATTACK) is used instead of volume. Depending on the pick position, one sound will be heard first with the other layered later.

167. SS:Bass+Guit : Preset with string split. The two lowest strings are assigned to a bass sound, the 4 upper strings, a guitar sound. Like the above presets, a hold preset is implemented here to give you a layered pad sound when you press the hold pedal.

168. SS:Bass+Slap : Preset with string split. The bottom four strings are assigned to a fretless bass sound, the upper two a slap bass sound. Both are transposed down one octave.

169. SS:Drum+Bass : Preset with string split. The bottom two strings are assigned to a drum kit; the upper four to a bass sound.

170. SS:Sitr+Flut : Preset with string split. The bottom two strings are assigned to a sitar; the upper four to a flute sound.

171. SS:Tuba+Brss : Preset with string split. The bottom two strings are assigned to a tuba; the upper four to a brass sound.

172. FS:Guit+Dist : Preset with fret split. Up to the 7th fret a jazz guitar is played. Above that, a distorted guitar.

173. FS:Bass+Bass : Preset with fret split. Up to the 9th fret a pick bass is played. Above that, a fretless bass. These are transposed down an octave.

174. FS:Guit+Ocar : Preset with fret split. Up to the 9th fret a distorted guitar is played. Above that, an ocarina. The ocarina is transposed one octave up.

175. FS:Clari+Sax : Preset with fret split. Up to the 9th fret a clarinet is played. Above that, a saxophone. Pitchbend is quantized to afford trills using string vibrato.

176. PS:Orgn+Orgn : Preset with 1 pick split. 2 different organ sounds that can be switched between depending on your pick position. The split point is approximately in the middle of the pick area.

177. PS:Bass+Bass : Preset with 1 pick split. 2 different bass sounds that can be switched between depending on your pick position. The split point is approximately in the middle of the pick area.

178. PS:2xAc.Bass : Preset with 1 pick split. 2 different bass sounds that can be switched between depending on your pick position. The split point is approximately in the middle of the pick area.

179. PS:BassVar : Preset with 2 pick splits. 3 different bass sounds that can be switched between depending on your pick position. The split points are divided approximately in thirds of the pick area. All three bass sounds are transposed down one octave.

180. PS:2xGuitar : Preset with 1 pick split. 2 different guitar sounds that can be switched between depending on your pick position. The split point is approximately in the middle of the pick area.

181. PS:GuitVar : Preset with 2 pick splits. 3 different guitar sounds that can be switched between depending on your pick position. The split points are divided approximately in thirds of the pick area.

182. MS:Strg+Fret : Preset with multi splits. Combination of a string split and a fret split. The result is four play zones. The three lower strings play bass sounds; in the lower zone below the 7th fret, an acoustic bass, in the upper frets above the 7th fret a fretless. The three higher strings in the lower frets a slap bass, in the higher frets a synth bass.

183. MS:Strg+Pick : Preset with multi splits. Combination of a string split and a pick split. The result is four play zones. The three lower strings near the bridge, a marimba, near the fingerboard, a pad sound. The three higher strings near the bridge a flute, near the fingerboard an organ.

184. MS:Fret+Pick : Preset with multi split. Combination of a fret split and a pick split. The result is four play zones. Near the fingerboard and in the lower frets a synth sound, above the 7th fret an oboe. Near the bridge and in the lower frets an acoustic guitar, above the 7th fret an organ.

185. MS:StrFrtPck : Preset with multi split. Combination of all split options. The result is 12 different play zones. This example is not very practical but is here to show the flexibility of the AXON. Remember that you you can use multi splits like this one not only to access various sounds, but more practically to access various characteristics such as TRANSPOSE, QUANTIZE, VOLUME, REVERB, PICK CONTROL, thereby maintaining the same sound for all split zones.

Problem Solving

External MIDI instrument doesn't play

Description: When I play the guitar, the AXON reacts properly on the meters in the display but my external MIDI instrument does not play.

Possible problem: Set up... cable connections

Solution:

- Make sure the MIDI cables are connected properly. From the AXON's MIDI OUT jack to the instrument's MIDI IN jack.
- The MIDI channels of both instruments need to be correctly set.
- The MIDI instrument should be in multi timbral mode.
- Make sure the audio cable between your MIDI instrument and the amplifier is correctly connected.
- Check the volume control on your guitar interface.
- The select button on your guitar interface could be set to "GUITAR". (This would cause no signal to the AXON.)

String bending does not function properly.

Description: When I play a string, I hear the right note, but hammer-ons, pull-offs, slides, and string bending do not function like I expect.

Possible problem: The Pitchbend settings on your AXON do not match the settings in your MIDI instrument; or Pitch Quantize is turned on.

Solution:

- Make sure that the pitchbend range settings in your MIDI instrument correspond to the same settings in your AXON (GLOBAL MODE).
- Make sure the QUANTIZE value in the preset split (PRESET MODE) is set to AUTO or OFF.

Sometimes wrong notes

Description: When I play the guitar, the notes I hear are all or partly wrong notes.

Possible problem: Discrepancy in tuning.

Solution:

- Tune your guitar using the AXON's tuning aids.
- If you want to tune your AXON to your guitar, use the Tune-Base function in GLOBAL MODE.
- It's possible that the transpose function in the preset split is ON. Turn TRANSPOSE OFF in PRESET MODE.
- Your MIDI instrument may be set to another tuning or have its transpose function turned ON. Check to see if these parameters are set to the correct values.

Varying string volume levels

Description: One or more strings are not loud enough in comparison to the others.

Possible problem: The string sensitivity of the individual strings is not set well.

Solution: In GLOBAL MODE, try resetting the sensitivity of the problematic strings.

Dynamic difference between notes is too great

Description: With some sounds the drastic dynamic differences between notes is irritating.

Possible problem: Setting problems in the touch sensitivity parameters.

Solution: The touch sensitivity settings in your AXON should correspond to the sound in your MIDI instrument that you are using. Try reducing the value in the touch sensitivity parameter of the preset split (PRESET MODE) and then try adding some value to the Velocity Offset parameter.

Wrong sounds

Description: The sounds that appear in the AXON's display do not correspond with the sounds I hear from my MIDI instrument.

Possible problem: Your external MIDI instrument is not set to XG/General MIDI mode or does not support this standard.

Solution:

- Set your MIDI instrument to GM mode. Set the AXON's parameter for preset names to "GM" (see UTILITY MODE).
- If your MIDI instrument doesn't support these standards, set your AXON's preset names parameter to "NUM". You can now access the desired sound using the corresponding MIDI bank and program number.

SYSTEM EXCLUSIVE IMPLEMENTATION

| | |
|-----|-----------------------|
| F0H | - Exclusive status |
| 00H | - European ID's |
| 20H | - European ID's |
| 2DH | - BCM ID |
| 20H | - Model ID AX100 |
| 00H | - Device ID |
| ah | - Address high |
| am | - Address mid |
| al | - Address low |
| ch | - Byte Count high |
| cm | - Byte Count mid |
| cl | - Byte Count low |
| dh | - Data #0 high 7 bits |
| dl | - Data #0 low 7 bits |
| ... | - Data ... |
| ... | - Data ... |
| dh | - Data #n high 7 bits |
| dl | - Data #n low 7 bits |
| cc | - Checksum |
| F7H | - End of exclusive |

The following dumps are presently supported:

Total dump

Presetdump (All, 1...128)

Chaindump (All, 1...32)

Patterndump for Arpeggiator (All, 1...16)

Total Effectdump (Rev setup, all revs, chor setup, all chors, var setup, all vars)

Reverbdump (Rev setup, all reverb programs)

Chorusdump (Chor setup, all chorus programs)

Variationdump (Var setup, all variation programs)

Total Sequencerdump (Seq setup, pattern 1...32, tracks 1...8)

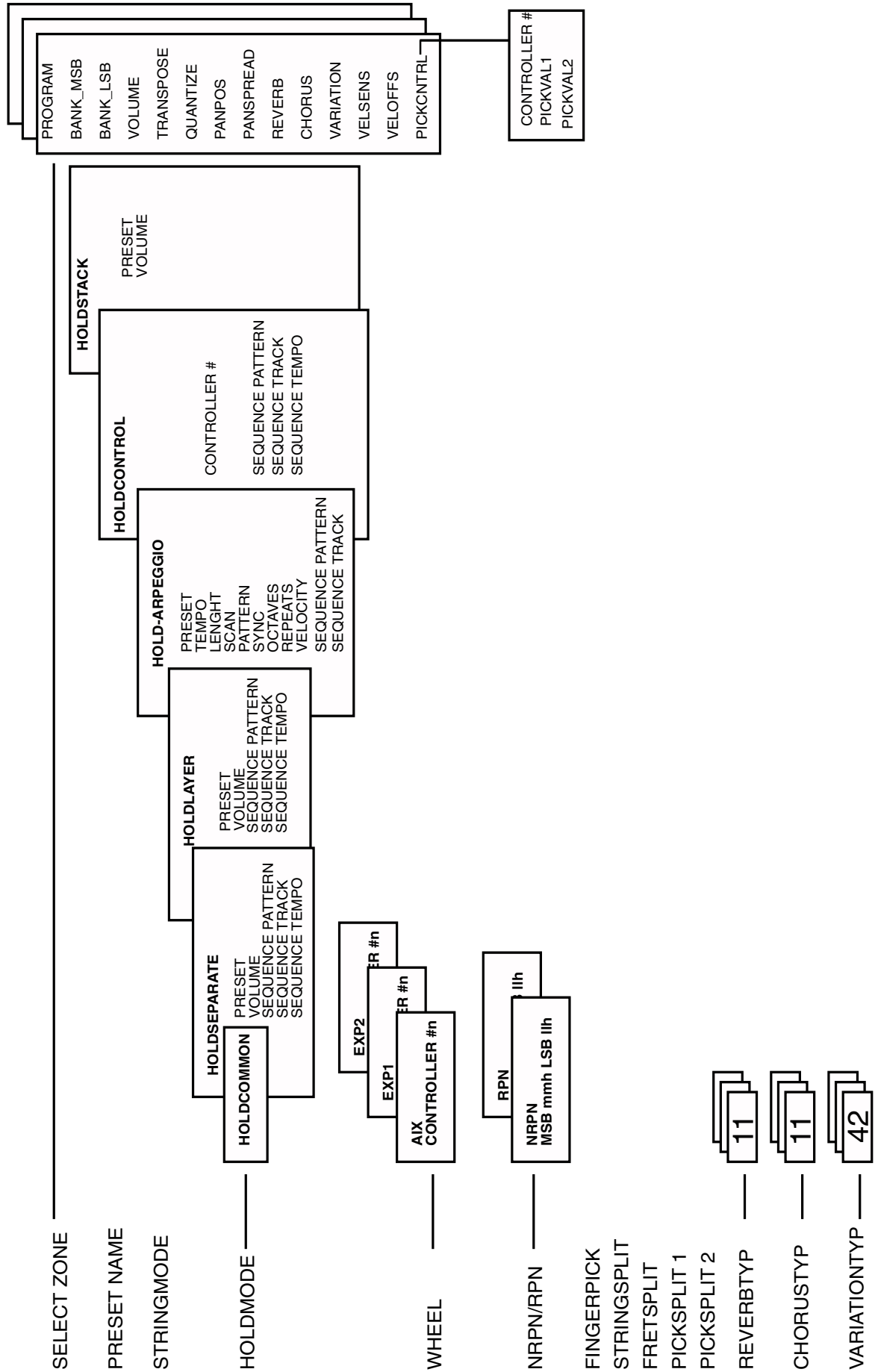
Patterndump for Sequencer (All)

Trackdump for Sequencer (All)

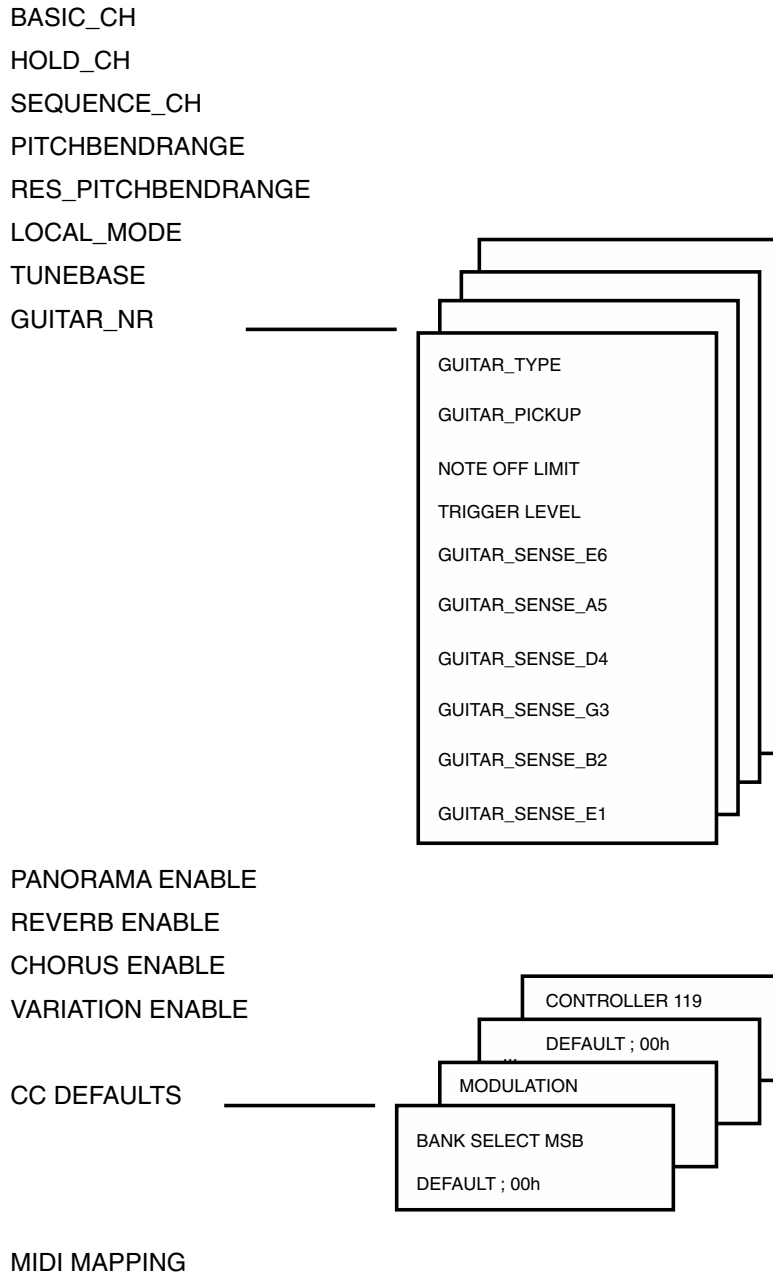
Byte Count corresponds to „Size“ in the following table. The value for Checksum is chosen so that the sum of Address, Byte Counte, Data and Checksums is zero.

| | Addr High | Addr Mid | Addr Low | Size | Description |
|---------------|----------------------|---------------------|---------------------|-------------|------------------------------------|
| System | 00 | 00 | 00 | F842h | dump all Data |
| not implem. | 00 | 00 | 7F | --- | Reset all Parameters |
| Presets | 00 | 00 | 01 | B800h | Dump all presets |
| | 00 | 00 | 02 | B00h | Dump all chain presets |
| | 00 | 00 | 03 | 200h | Dump all arpeggio pattern |
| | 00 | 00 | 04 | B60h | Dump all effects |
| | 00 | 00 | 05 | 164h | Dump all reverb effects |
| | 00 | 00 | 06 | 166h | Dump all chorus effects |
| | 00 | 00 | 07 | 896h | Dump all variation effects |
| | 00 | 00 | 09 | A08h | Dump all sequence (tracks/pattern) |
| | 00 | 00 | 0A | 600h | Dump all sequence pattern |
| | 00 | 00 | 0B | 400h | Dump all sequence tracks |
| Single Preset | 00 | 01 | #n (00h..7Fh) | 170h | Dump preset 1..128 |
| | 00 | 02 | #n (00h..1Fh) | 58h | Dump chain preset 1..32 |
| | 00 | 03 | #n (00h..0Fh) | 20h | Dump arpeggio pattern 1..16 |
| not implem. | 00 | 05 | #n (00h..0Ah) | 20h | Dump reverb effect 1..11 |
| not implem. | 00 | 06 | #n (00h..0Ah) | 20h | Dump chorus effect 1..11 |
| not implem. | 00 | 07 | #n (00h..29h) | 34h | Dump variation effect 1..42 |
| not implem. | 00 | 0A | #n (00h..1Fh) | 30h | Dump sequence pattern 1..32 |
| not implem. | 00 | 0B | #n (00h..07h) | 80h | Dump sequence track 1..8 |

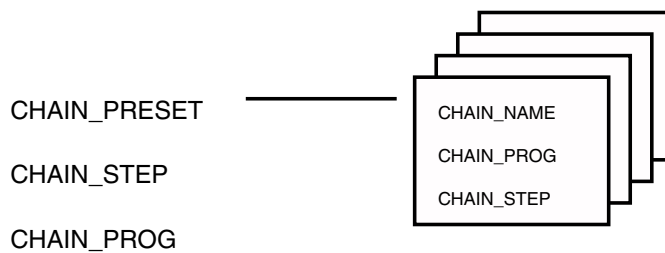
Parameter Overview Global



Parameter Overview Global



Parameter Overview Chain



Parameter Overview Utility



Midi Implementation Chart

Model AX100 (SB) Date : 16.07.97 Version : 1.0

| .Function... | | Transmitted | Recognized | Remarks |
|-------------------------|----------------------------|--|-----------------|--|
| BasicChannel | DefaultChanged | 11..10 | 1X *1 | |
| HoldChannel | DefaultChanged | 71..10 | XX | |
| SequencerChannel | DefaultChanged | 161..16 | XX | |
| Mode | DefaultChanged- Altered | 3,4XX | XX *1X | |
| NoteNumber | True Voice | 0..127xxxxxxxx | X *1X *1 | |
| Velocity | Note On Note Off | 09 _n v = 1..127 08 _n v = 10 | X *1X *1 | |
| AfterTouch | Key'sChannels | XX | X *1X *1 | |
| PitchBend | | O | X *1 | |
| ControlChange | 012..119 | OOO | O *1O *1X *1 | Bank Select MSB Bank Select LSB |
| ProgramChange | True # | 0..127 | 0..127 *1 | |
| SystemExclusive | | O | O *1 | |
| SystemCommon | | X | X *1 | |
| SystemReal Time | ClockCommands | OO | O *1O *1 | |
| AuxMessages | | X | X *1 | |

Notes

*1 extended MIDI implementation for AX100 - SB models
(detailed information for soundboard available)

Mode 1 : Omni On, Poly **Mode 2 : Omni On, Mono**
Mode 3 : Omni Off, Poly **Mode 4 : Omni Off, Mono**

O : Yes
X : No



BLUE CHIP
music technology

BLUE CHIP MUSIC GmbH
Industriestrasse 1
56283 HALSENBACH

GERMANY

Phone: +49 (0) 6747 - 8903

Fax: +49 (0) 6747 - 8914

Homepage: www.blue-chip-music.net

Email: info@bluechipmusic.net