

Using a compass to sight a bearing to a distant target.

Measures an angle between
Magnetic North,
your location, and
the distant target.

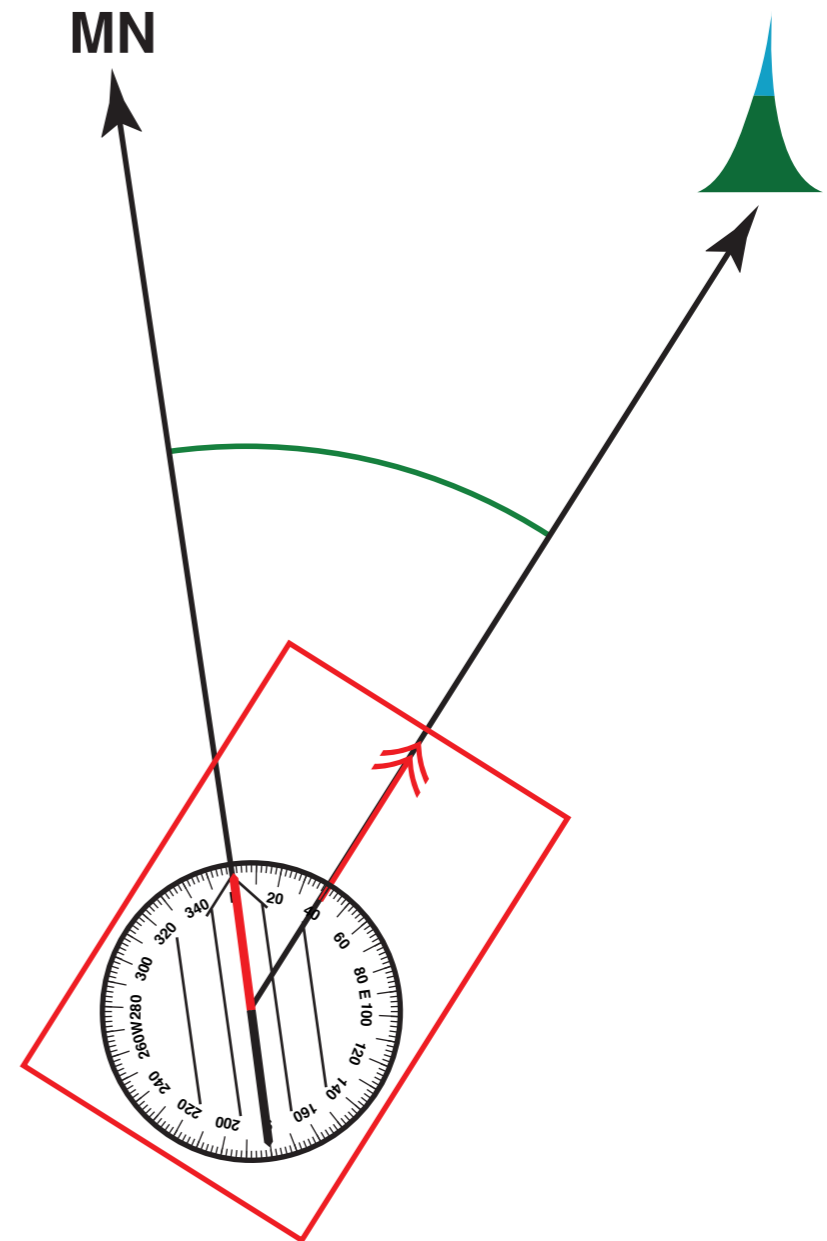

Using a compass to get a bearing to a distant target.

- Sight to the target with the compass.
- Turn the ring to align the orienting arrow with the red end of the magnetic needle.
- Read the bearing from the ring at the index line.

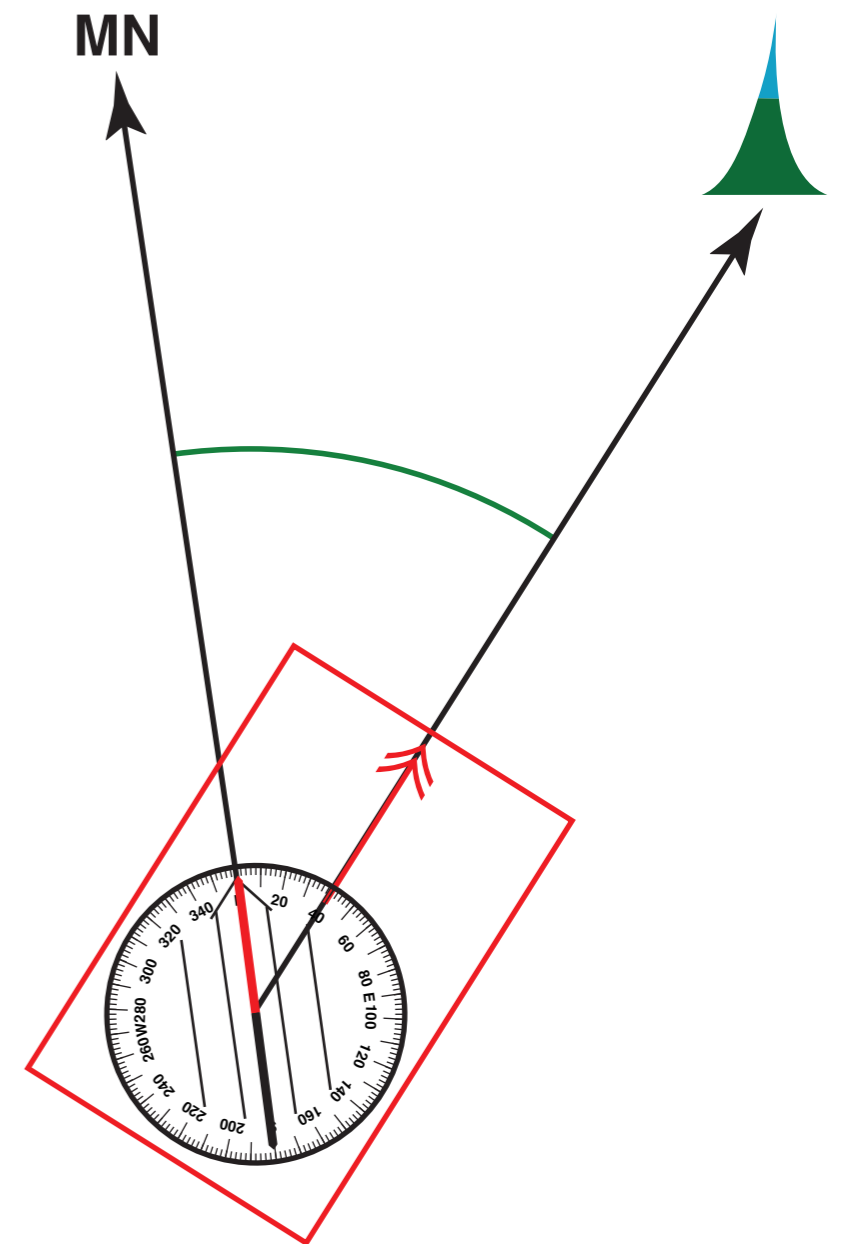

Sighting with a Mirrored Compass

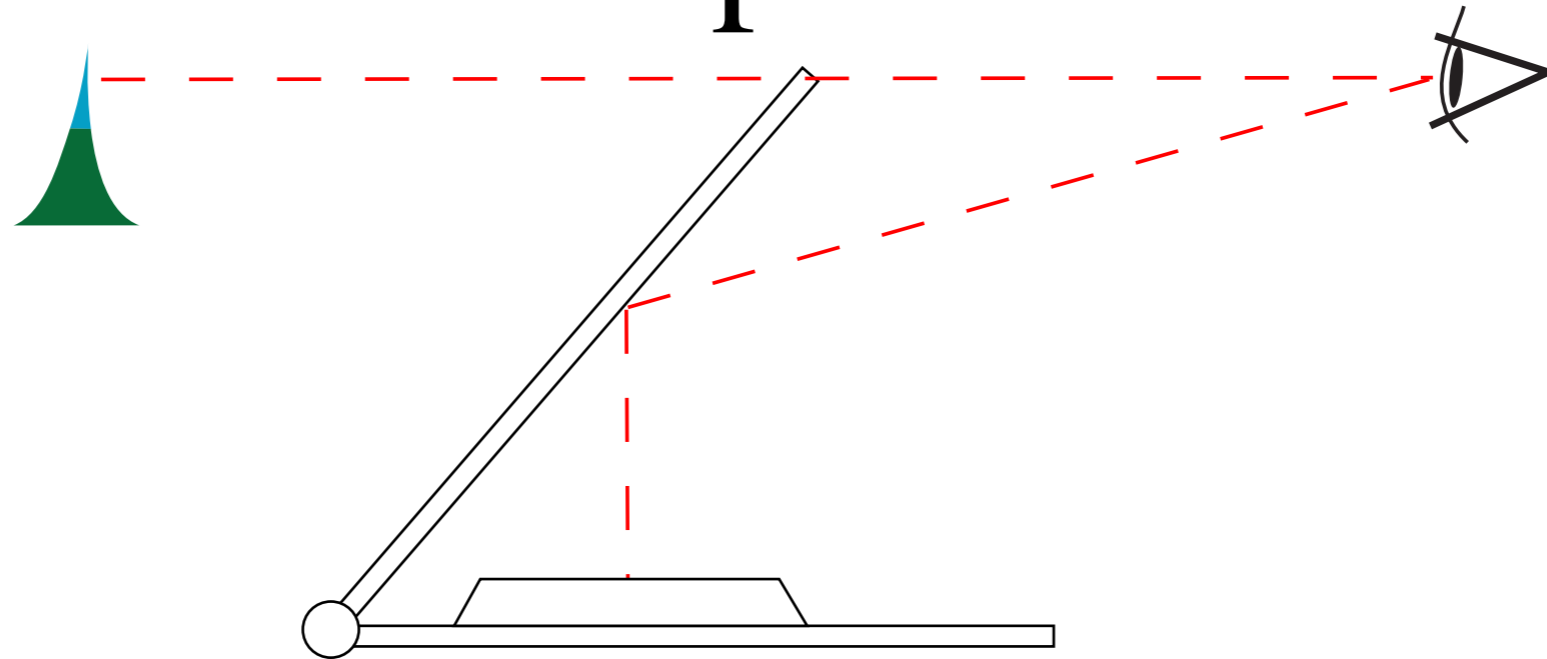

- Hold the compass level with the mirror at about a 45° angle.
- Use the sighting notch to align the compass with the target.
- Looking into the mirror, turn the dial to align the orienting arrow with the north needle.







Sighting with a Mirrored Compass

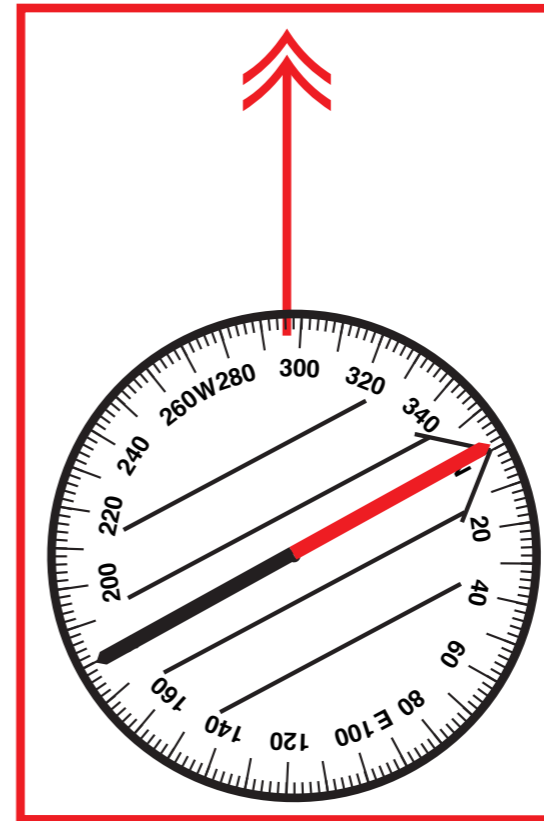
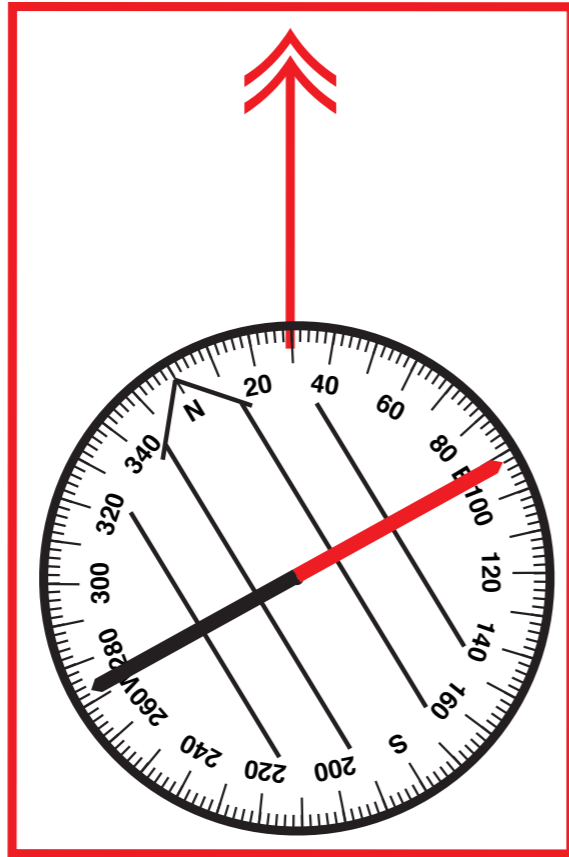

- Turn the dial to align the orienting arrow with the north arrow.



Needle Parallax

Good

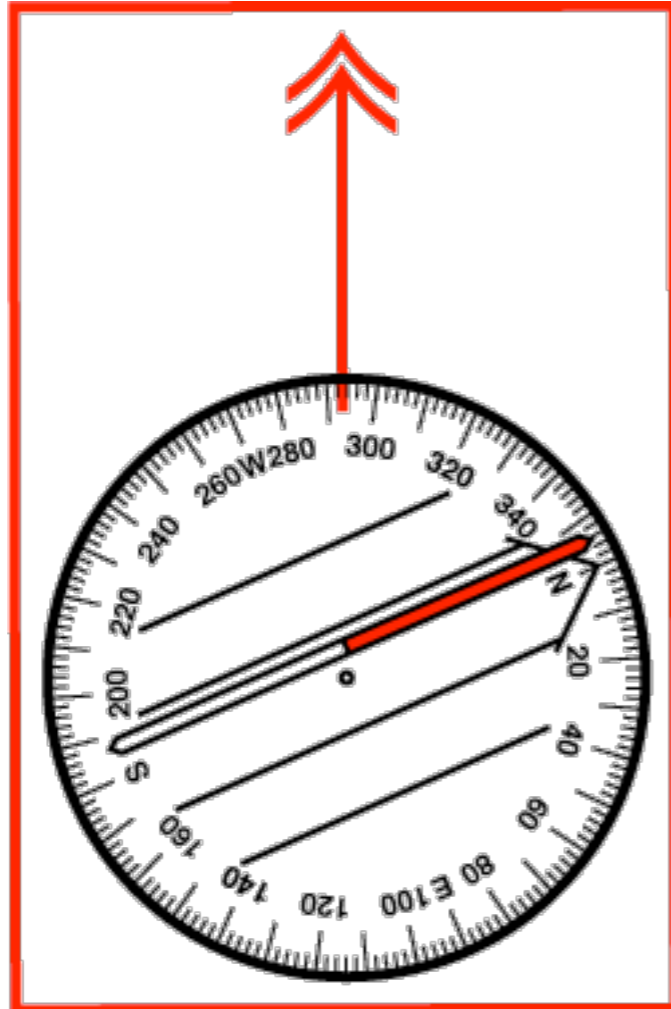

Bad

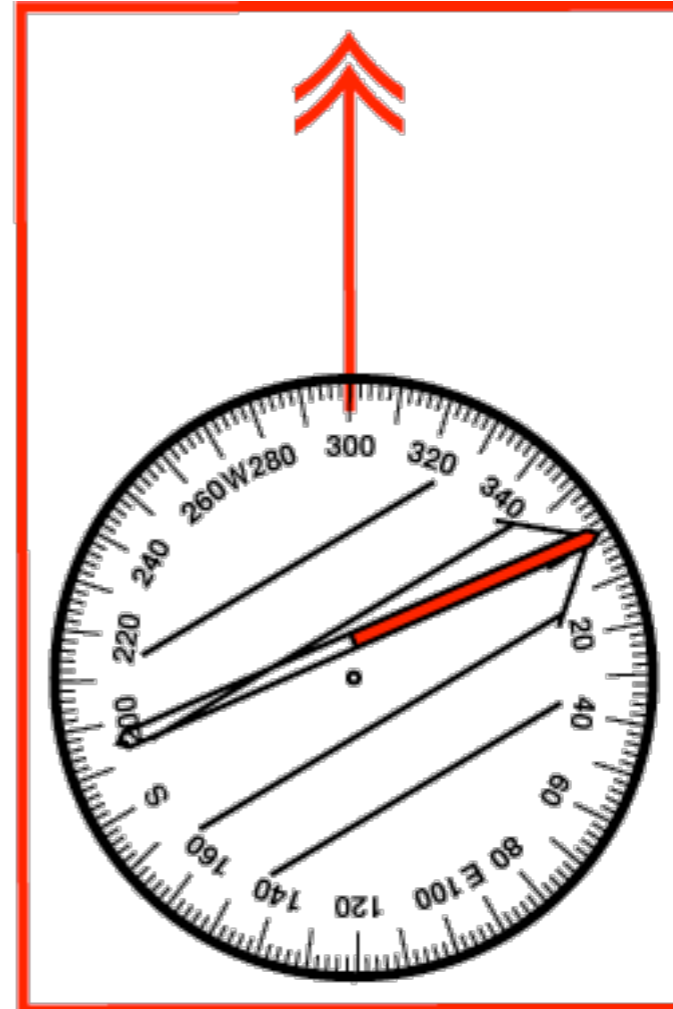

Keep the needle parallel to the orienting arrow.

Parallax Side View

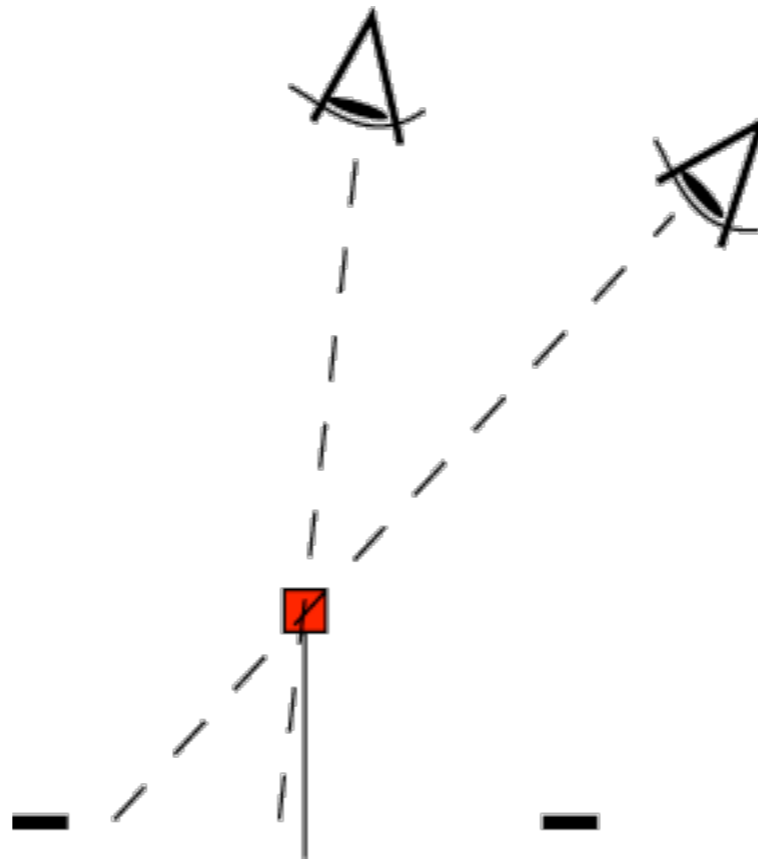

Needle Parallax

View from Above

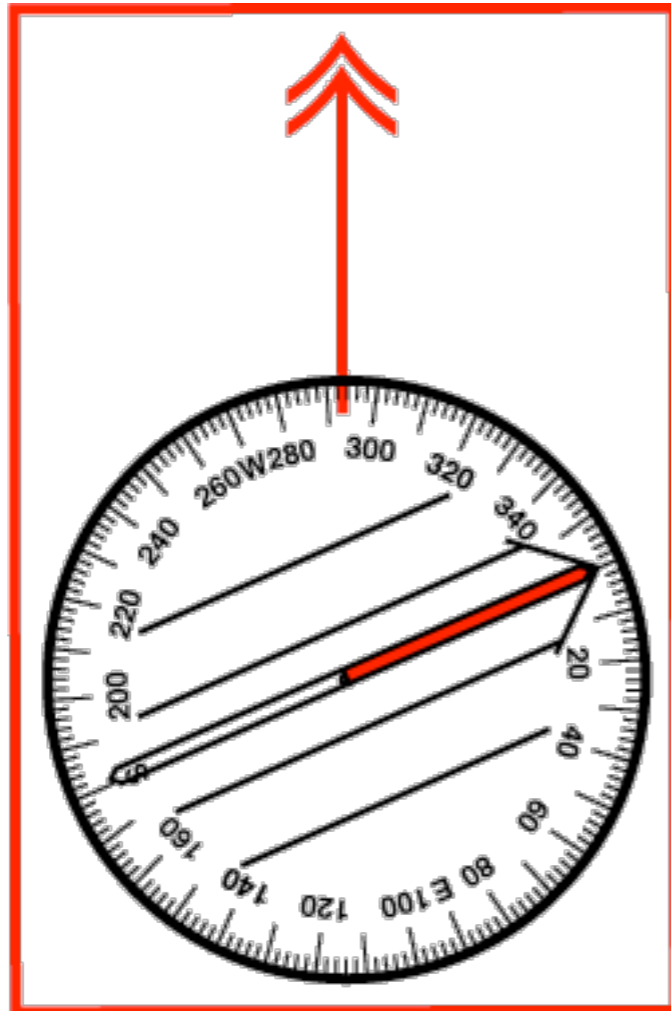

View from Behind

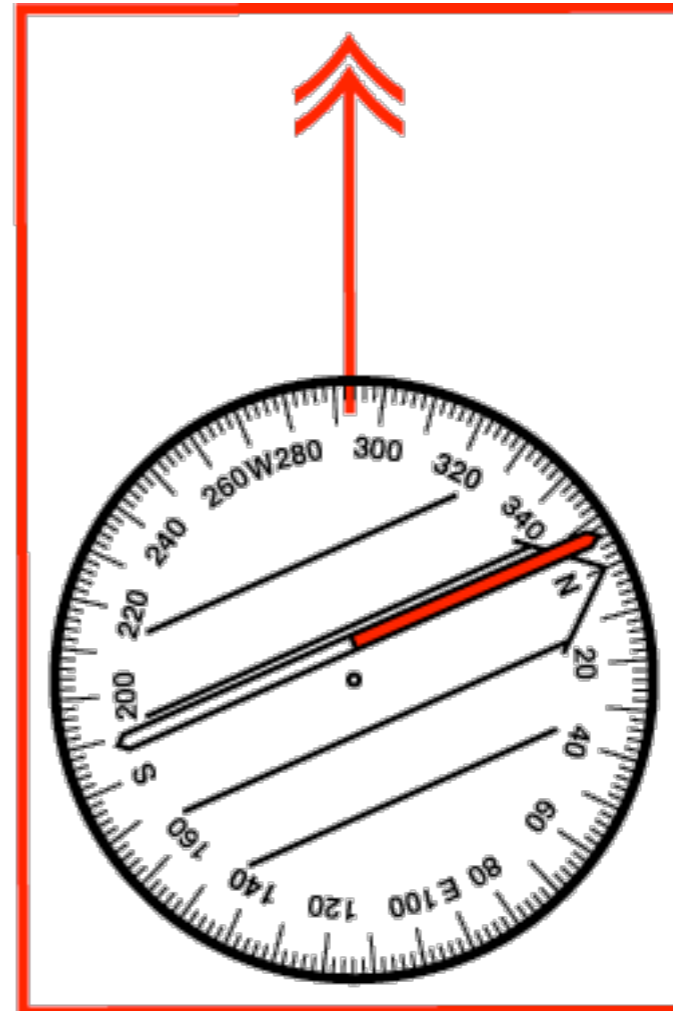

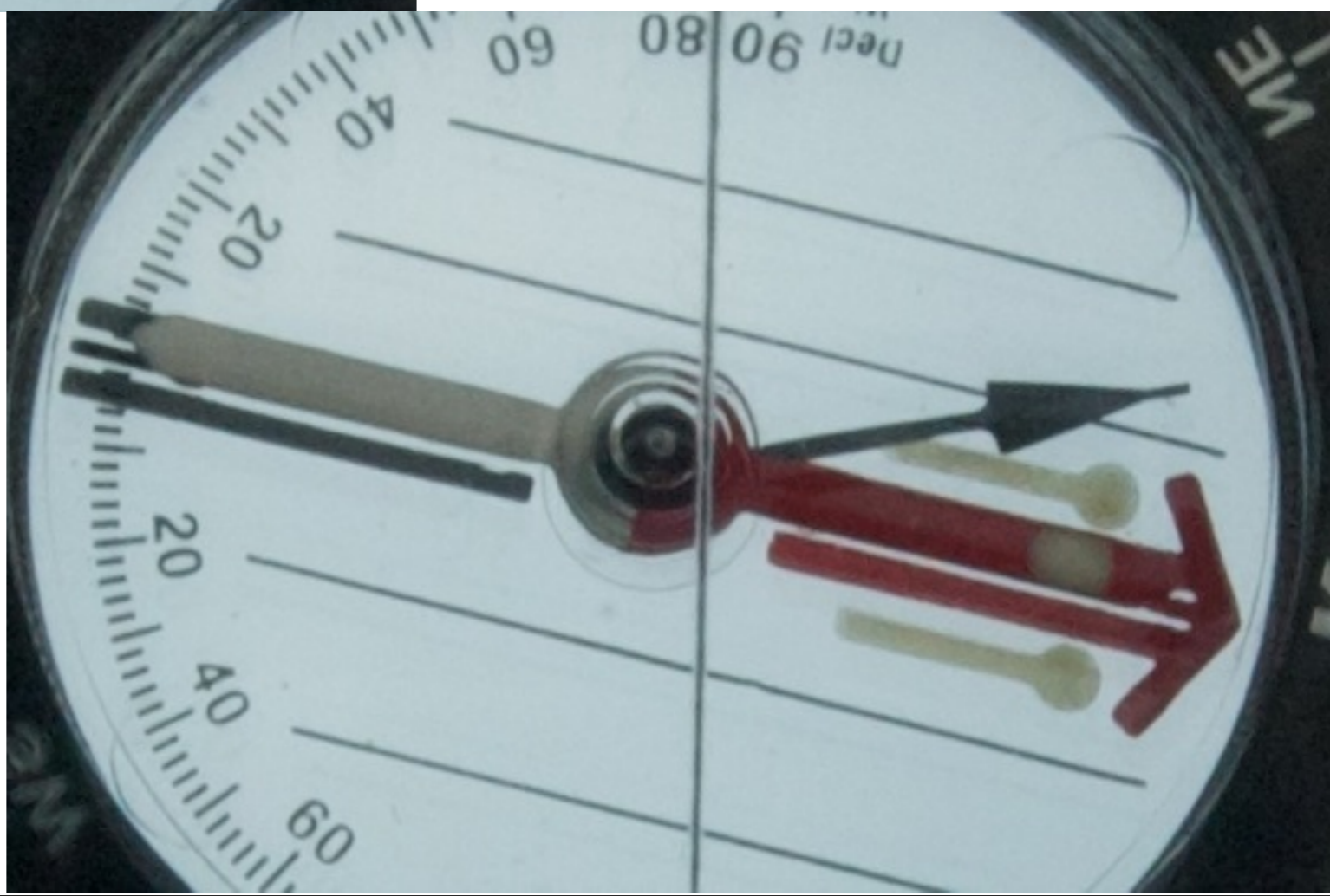

Sighting with a Mirrored Compass

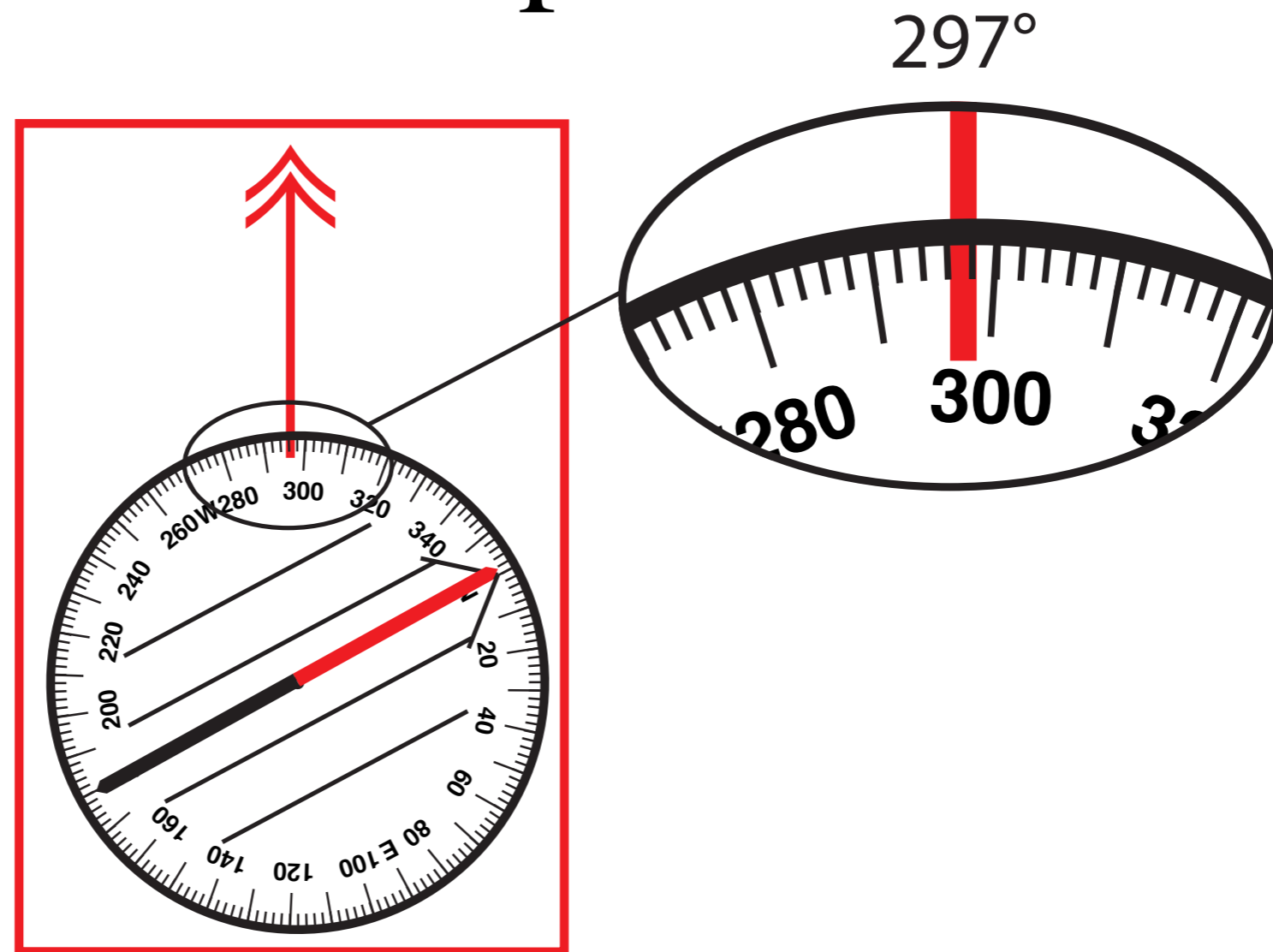

- Read the bearing from the index line



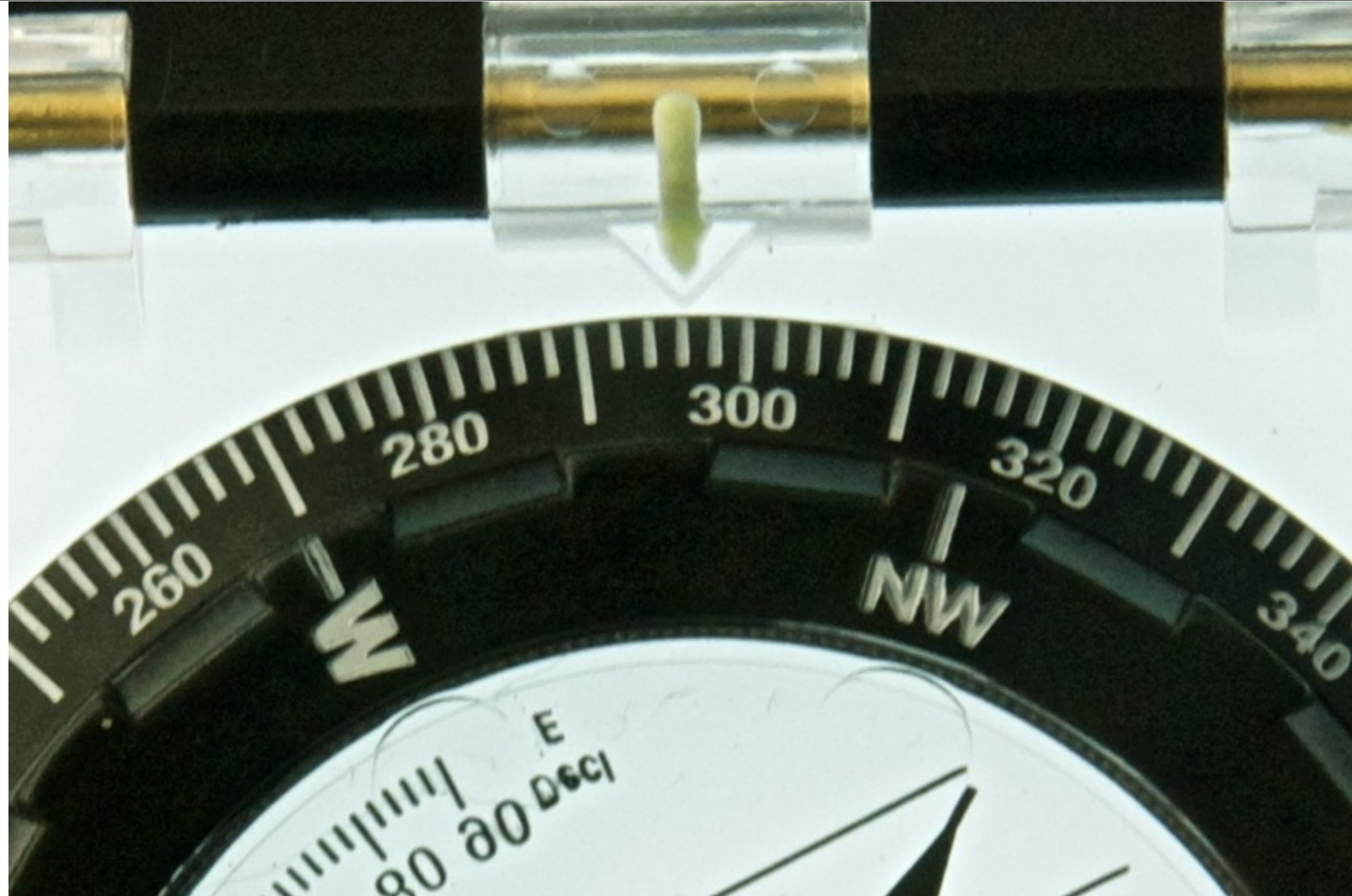

**Each increment is 2°
Longer tics every 10°
Labeled every 20°**

296°

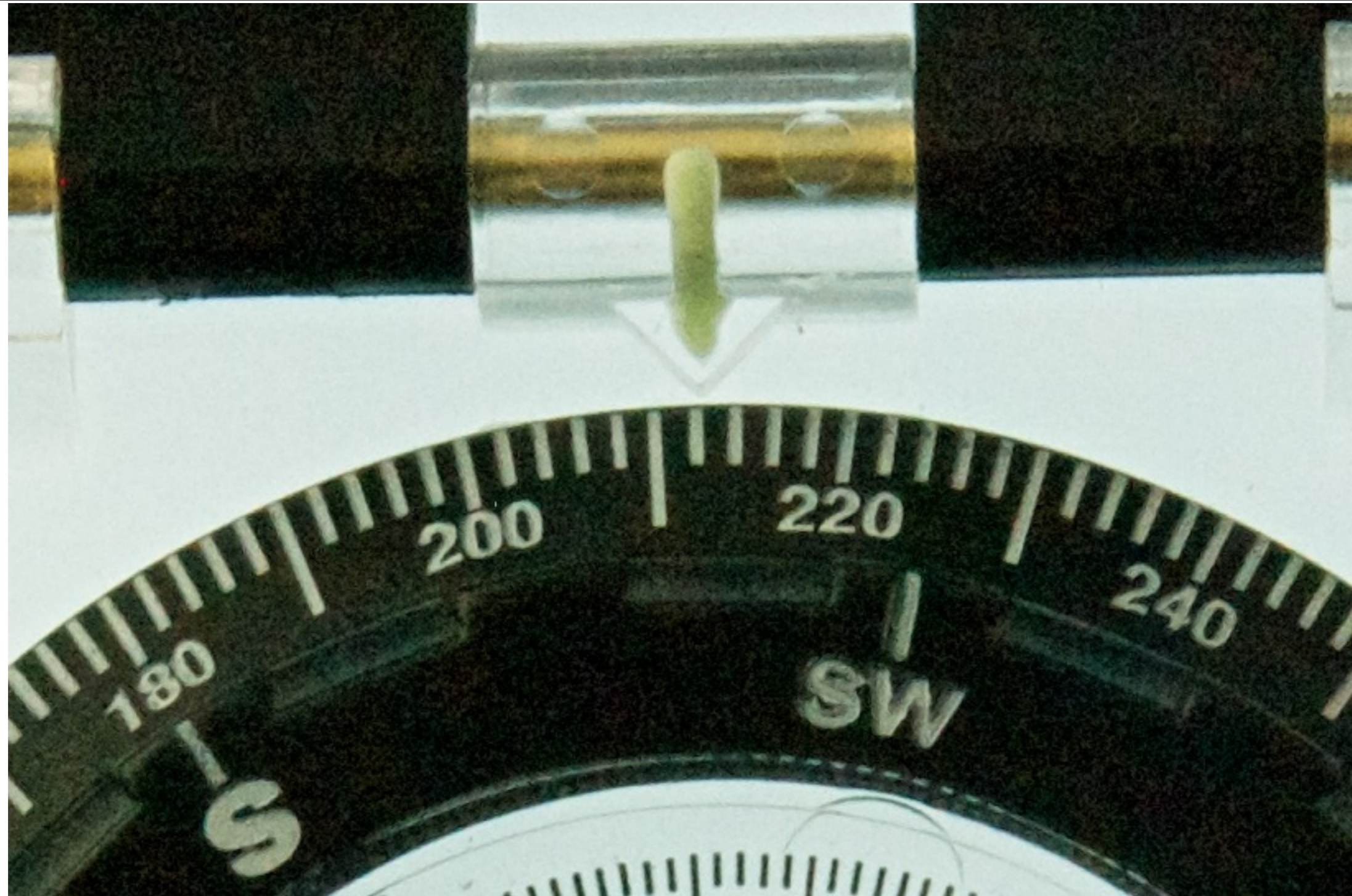

212°

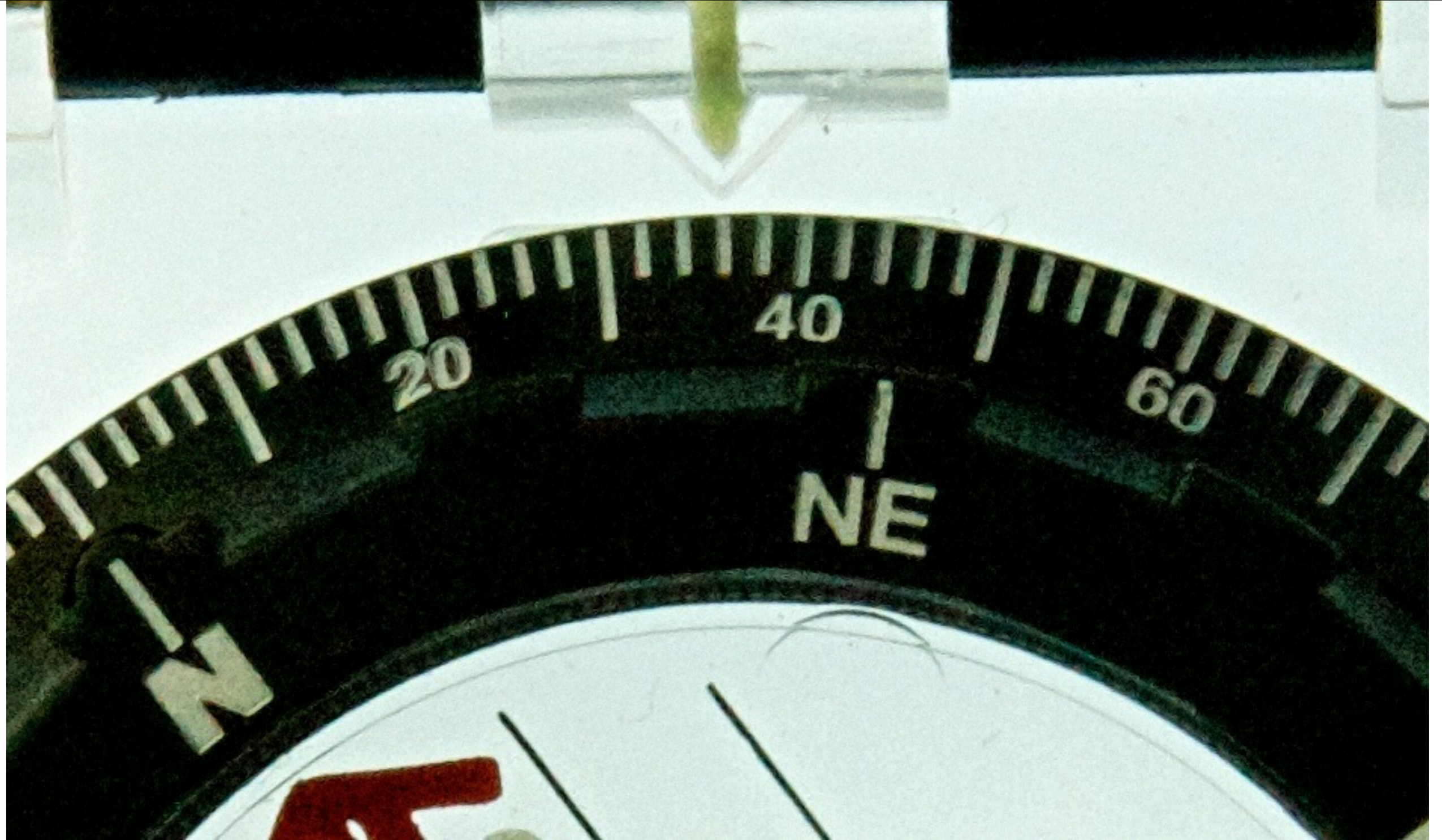

36°

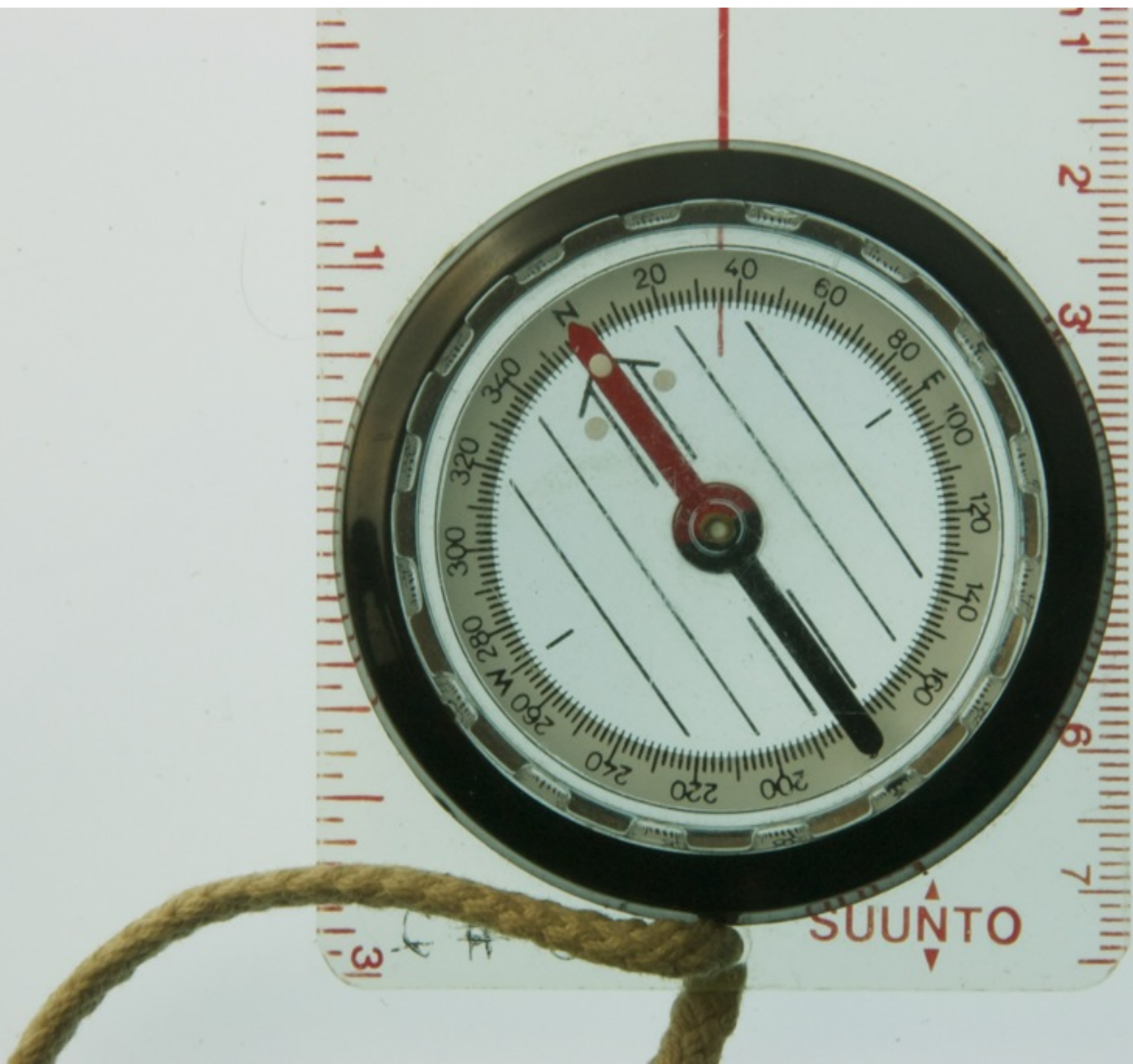

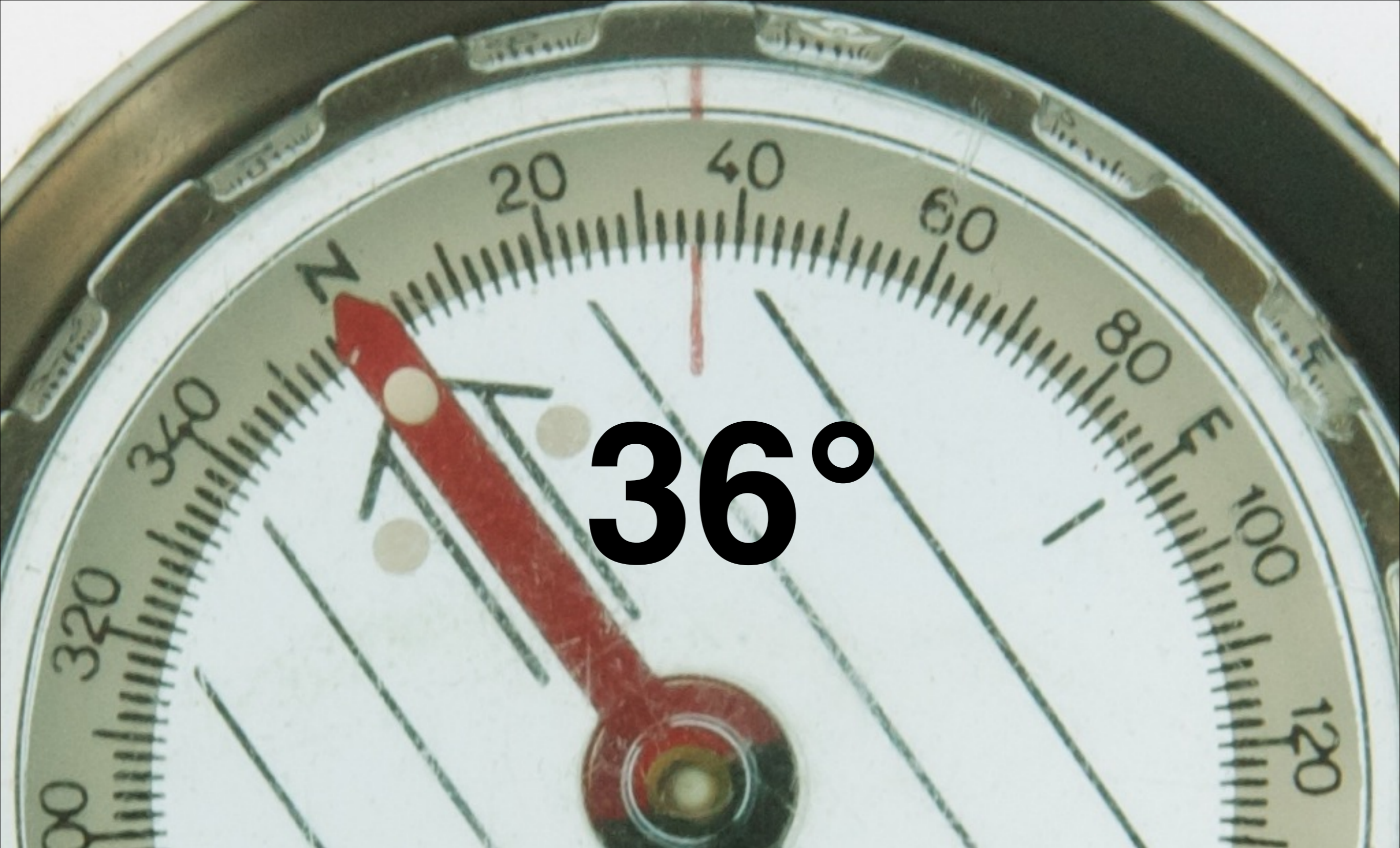

36°

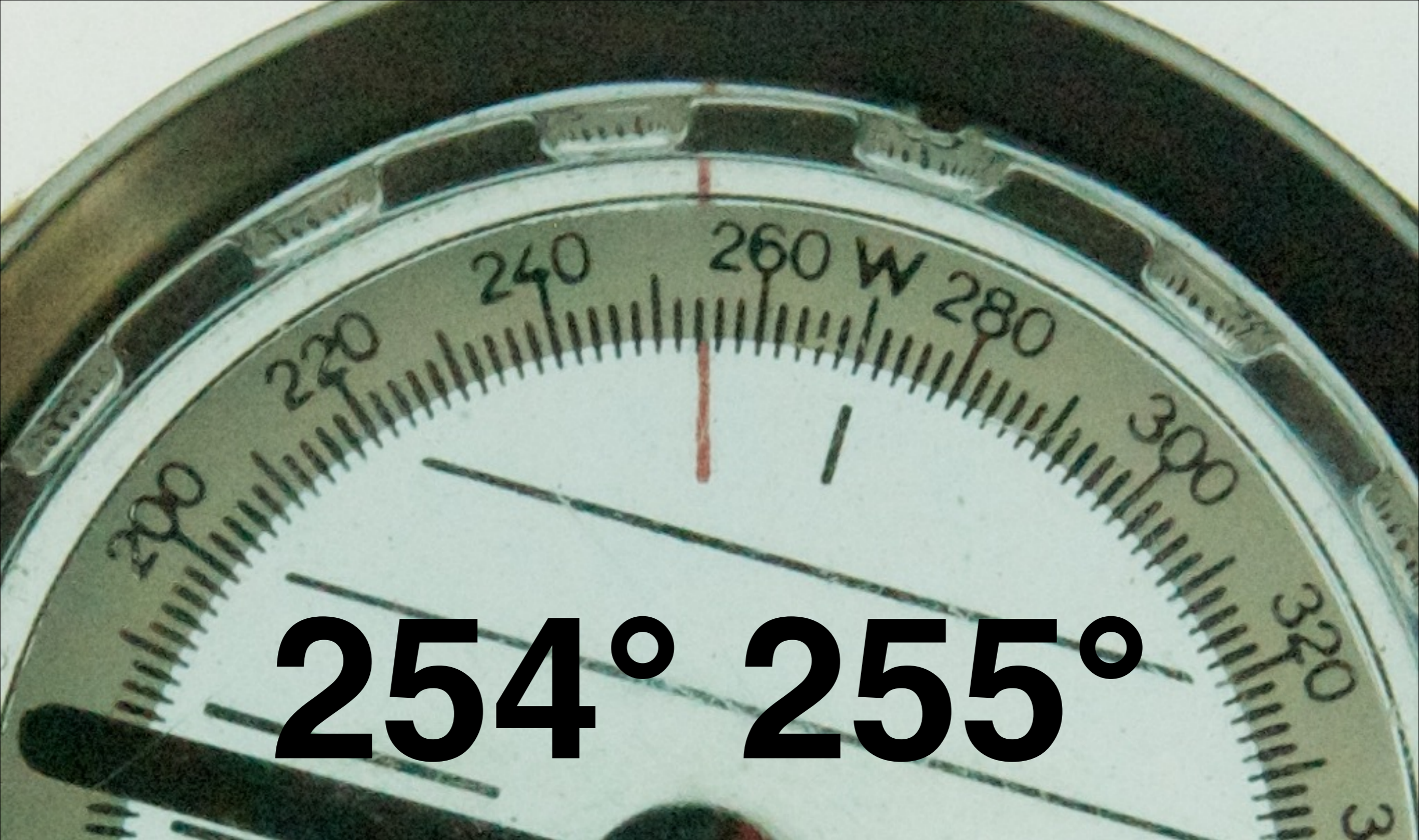

254° 255°

?

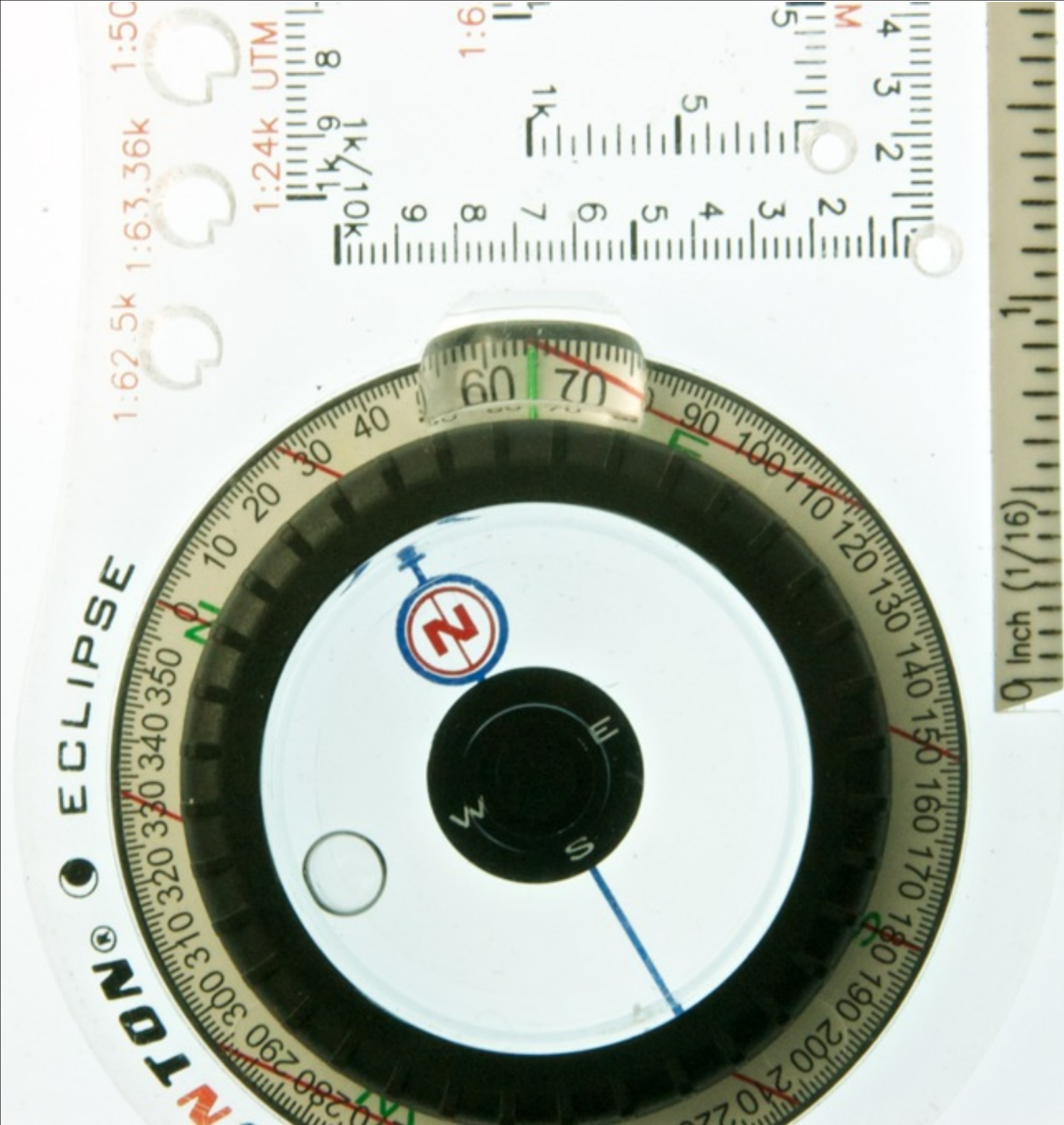

**Circle in a Circle
to
“Box the Needle”**

**Labeled every 10°
Longer tics every 5°
Each increment is 1°**

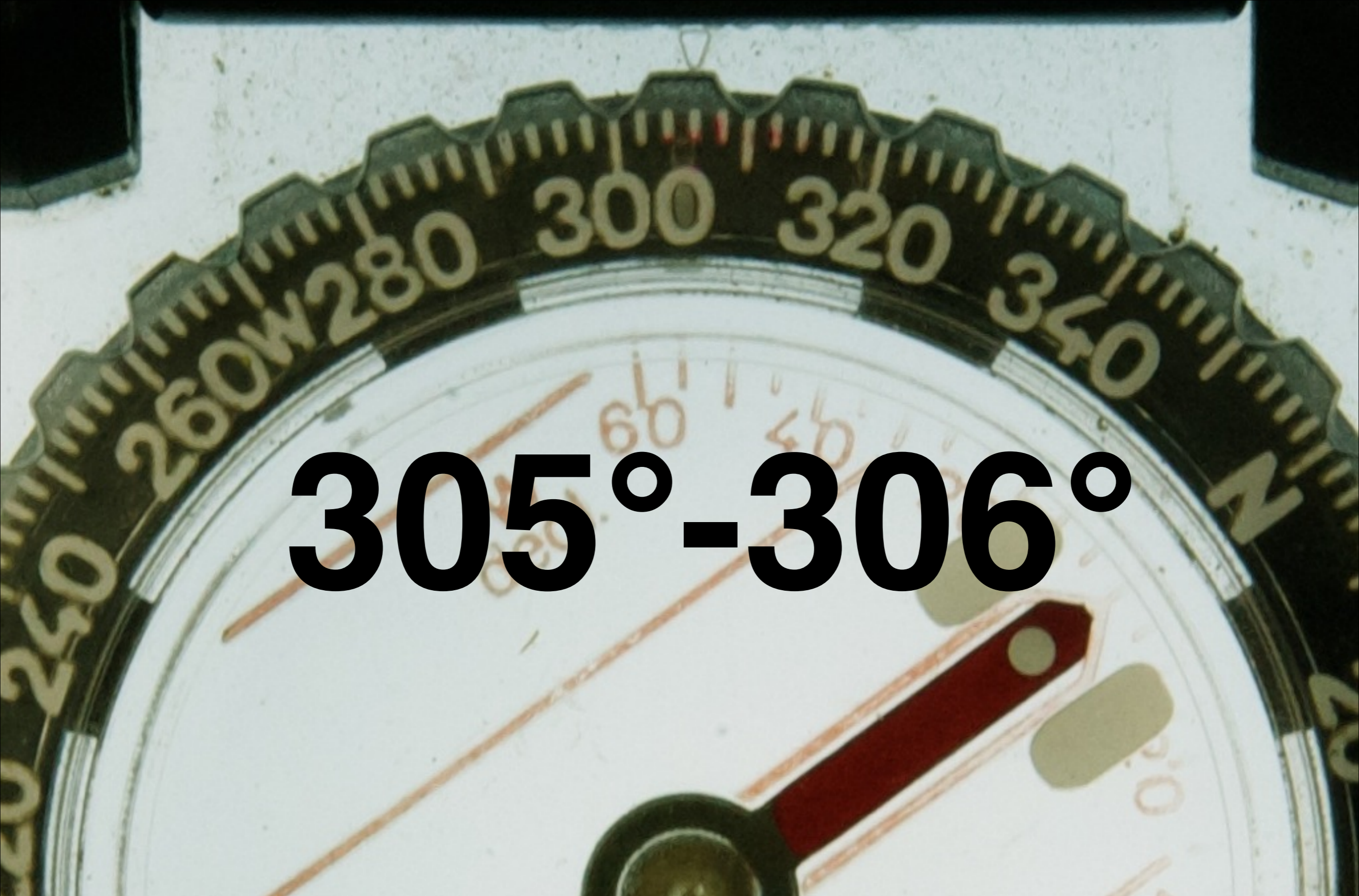

305°-306°



357°



357.5°

Sighting with a Lensatic Style Compass





**Labeled in
Degrees and Mils
(6400 mils = 360°)**

**Degrees
Labeled every 20°
Ticks every 5°**

**Mils
Labeled every 200 mils
Long tics every 100 mils
Increment every 20 mils**

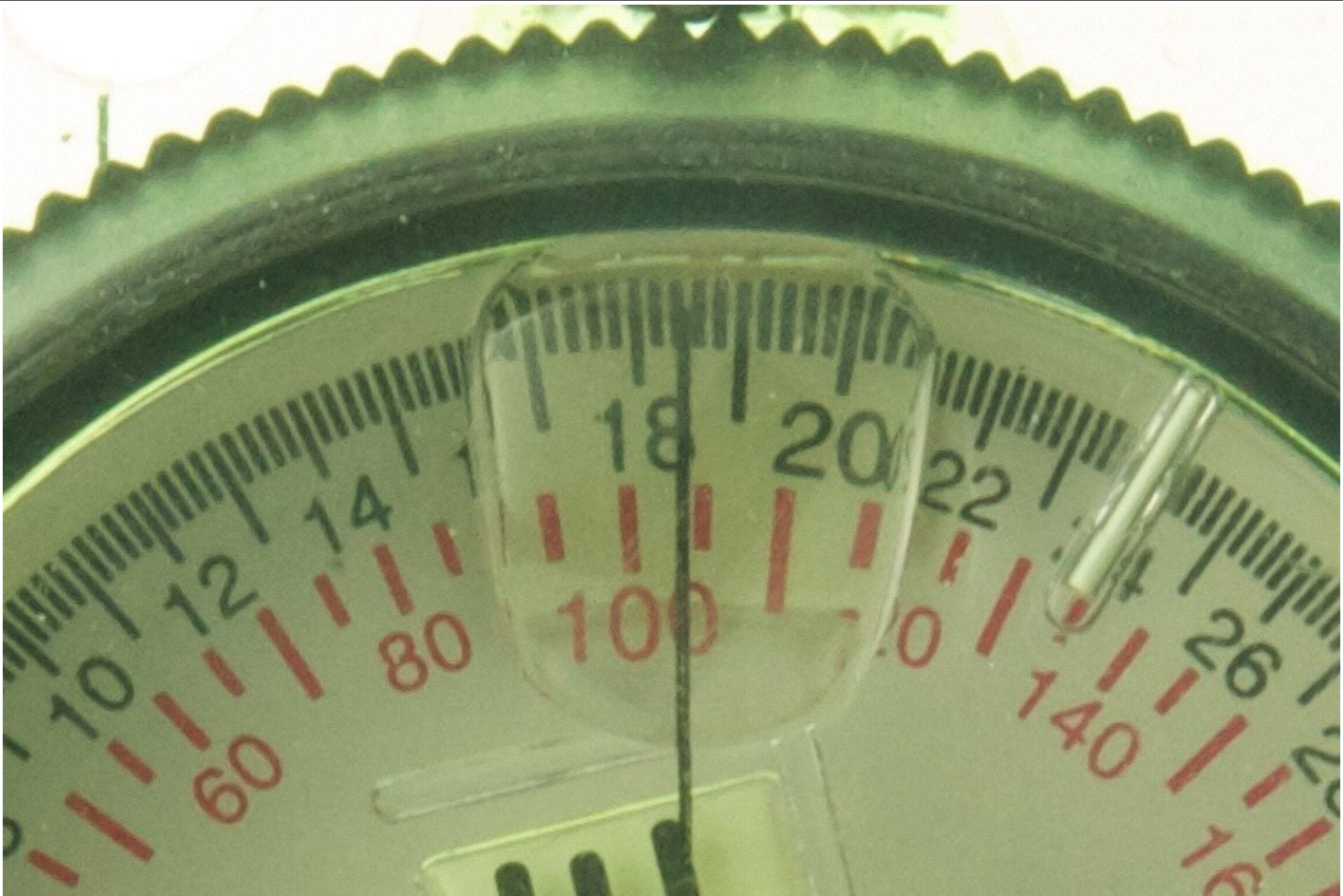

1850 mils
104°



550 mils
31°



4640 mils
261°

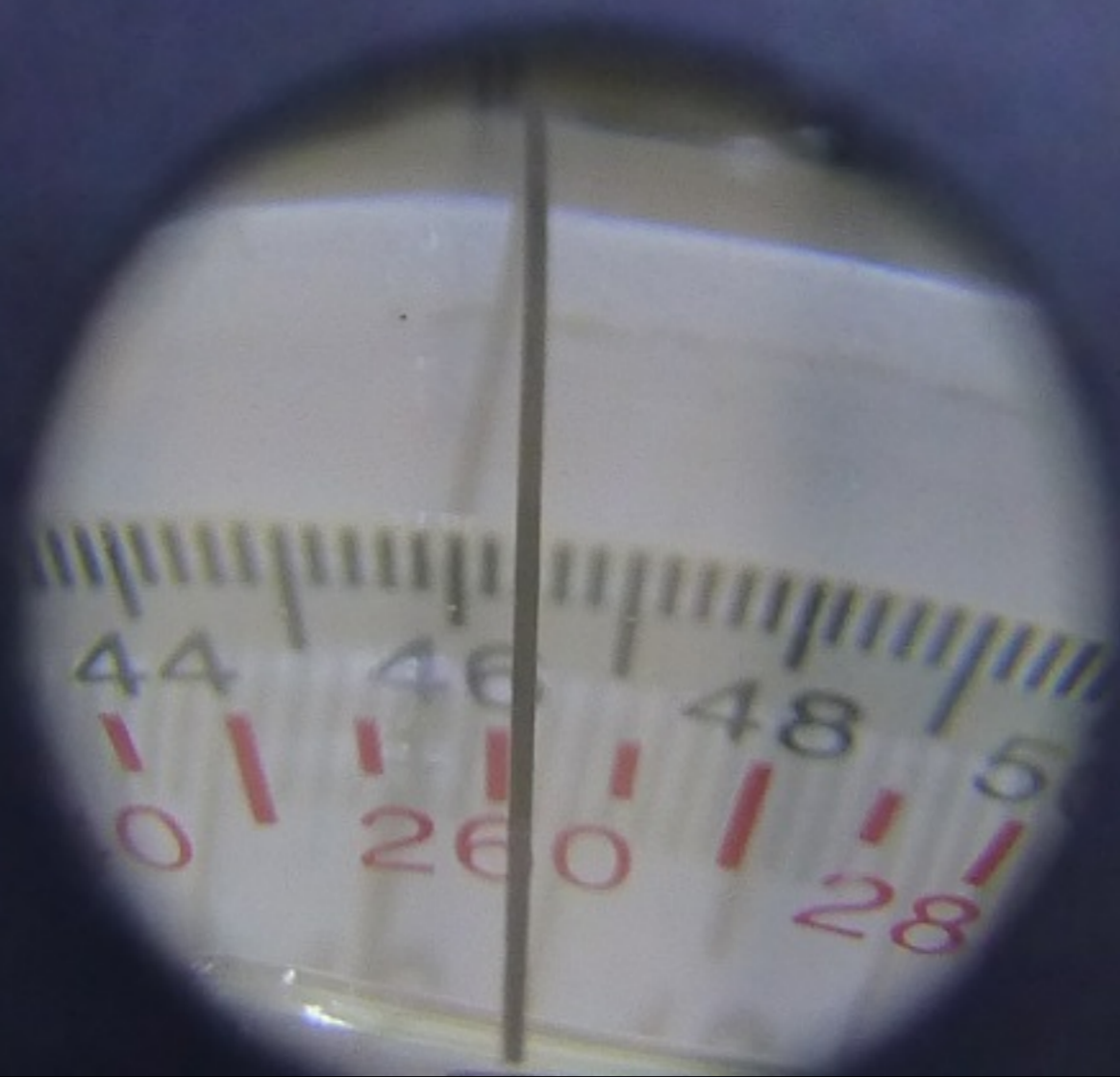

5750 mils

323°

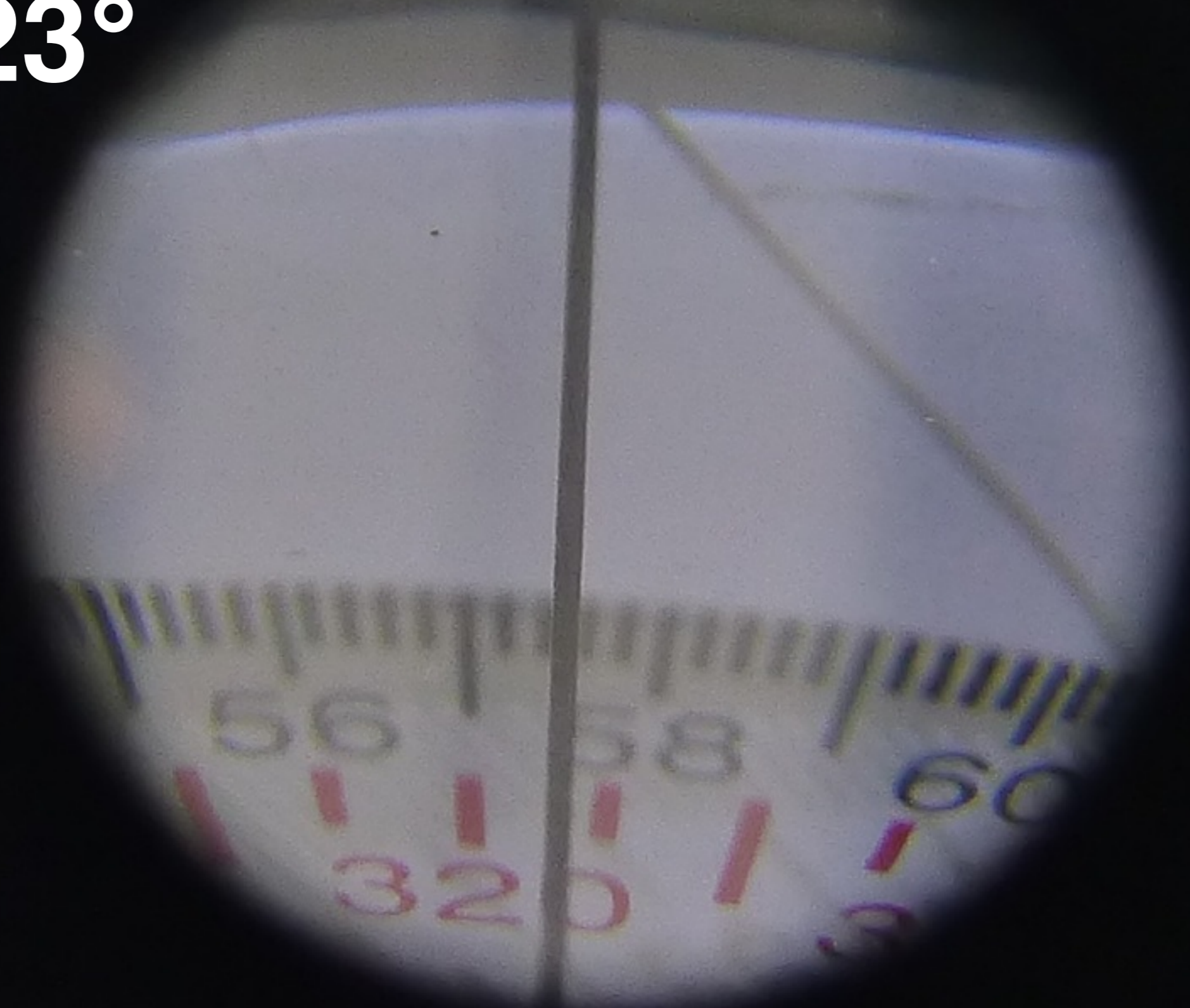

Sighting with a Direct Sighting Style Compass



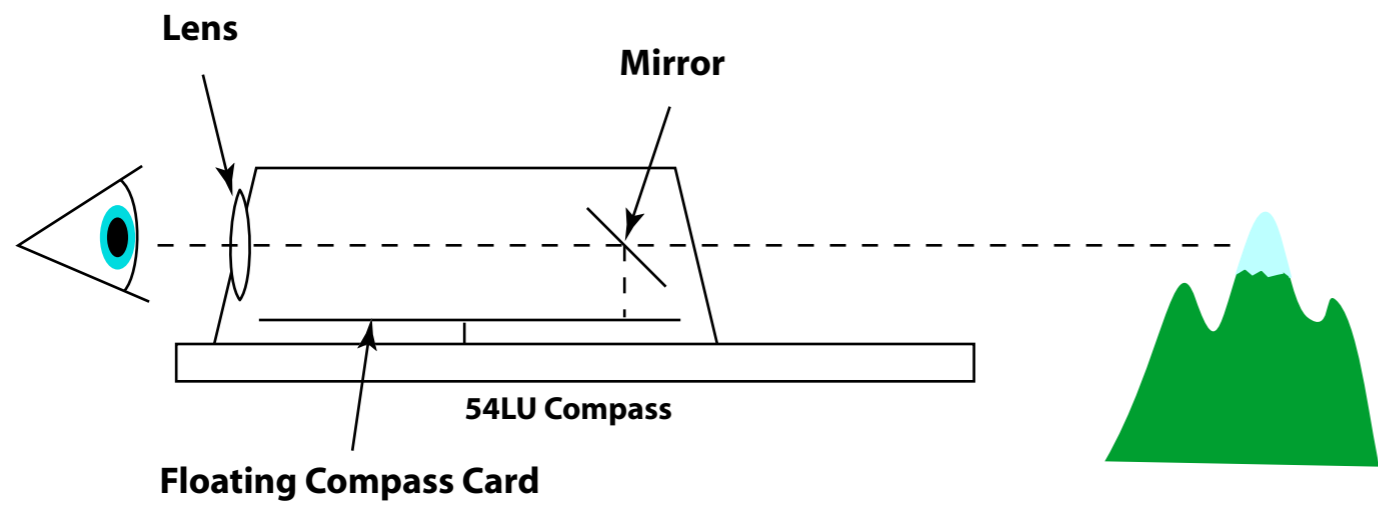

Floating Compass Card

Side View

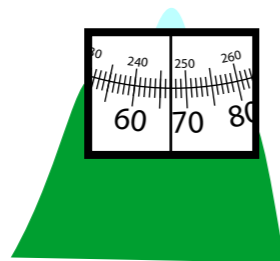

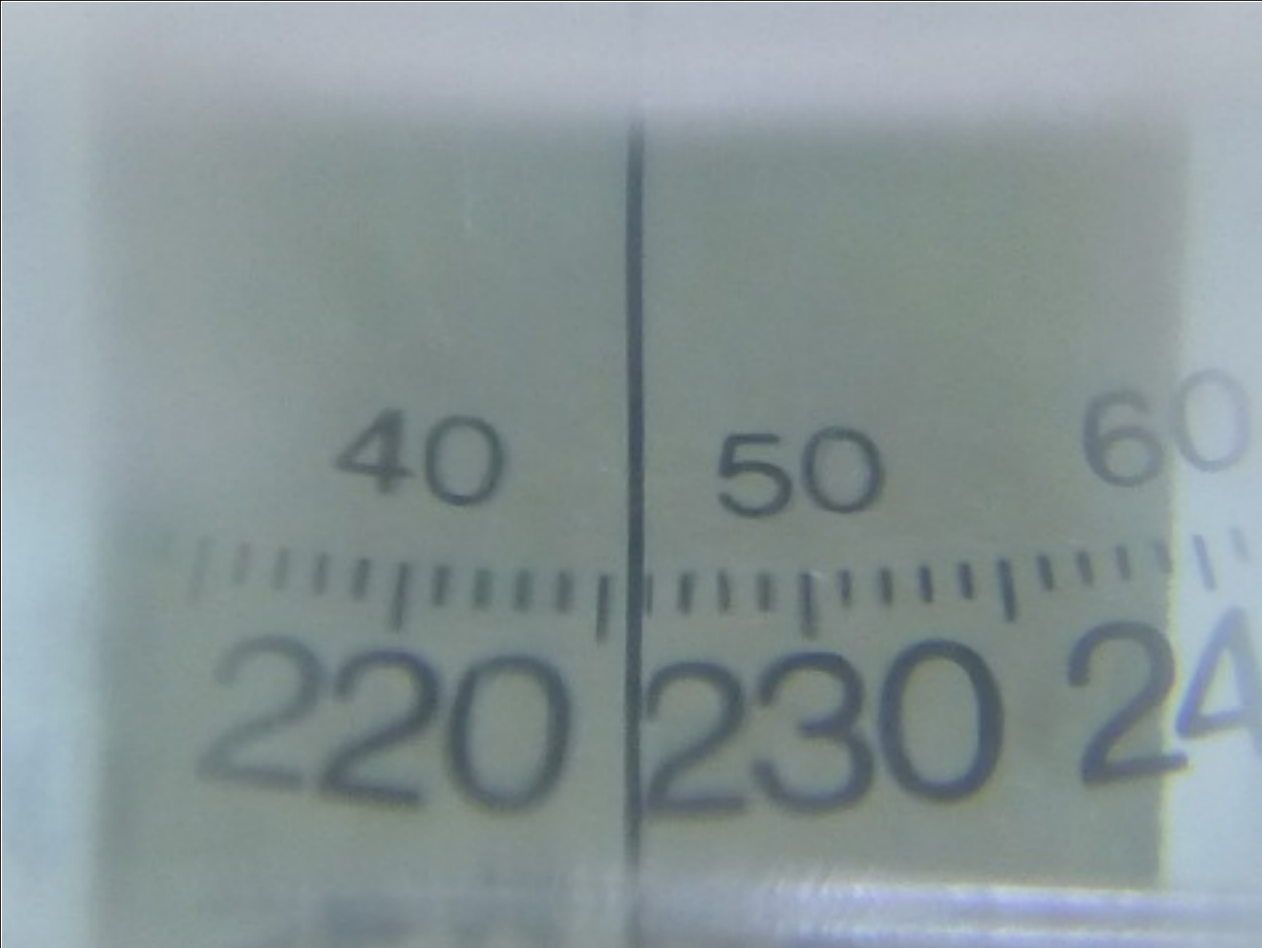

**Forward bearings in
large type
Back bearings in
small type**

**Labeled every 10°
Increases left-to-right
Longer tics every 5°
Each increment is 1°**

Forward bearing?

226°

Back bearing?

46°



Forward bearing?

275.5°

Back bearing?

95.5°

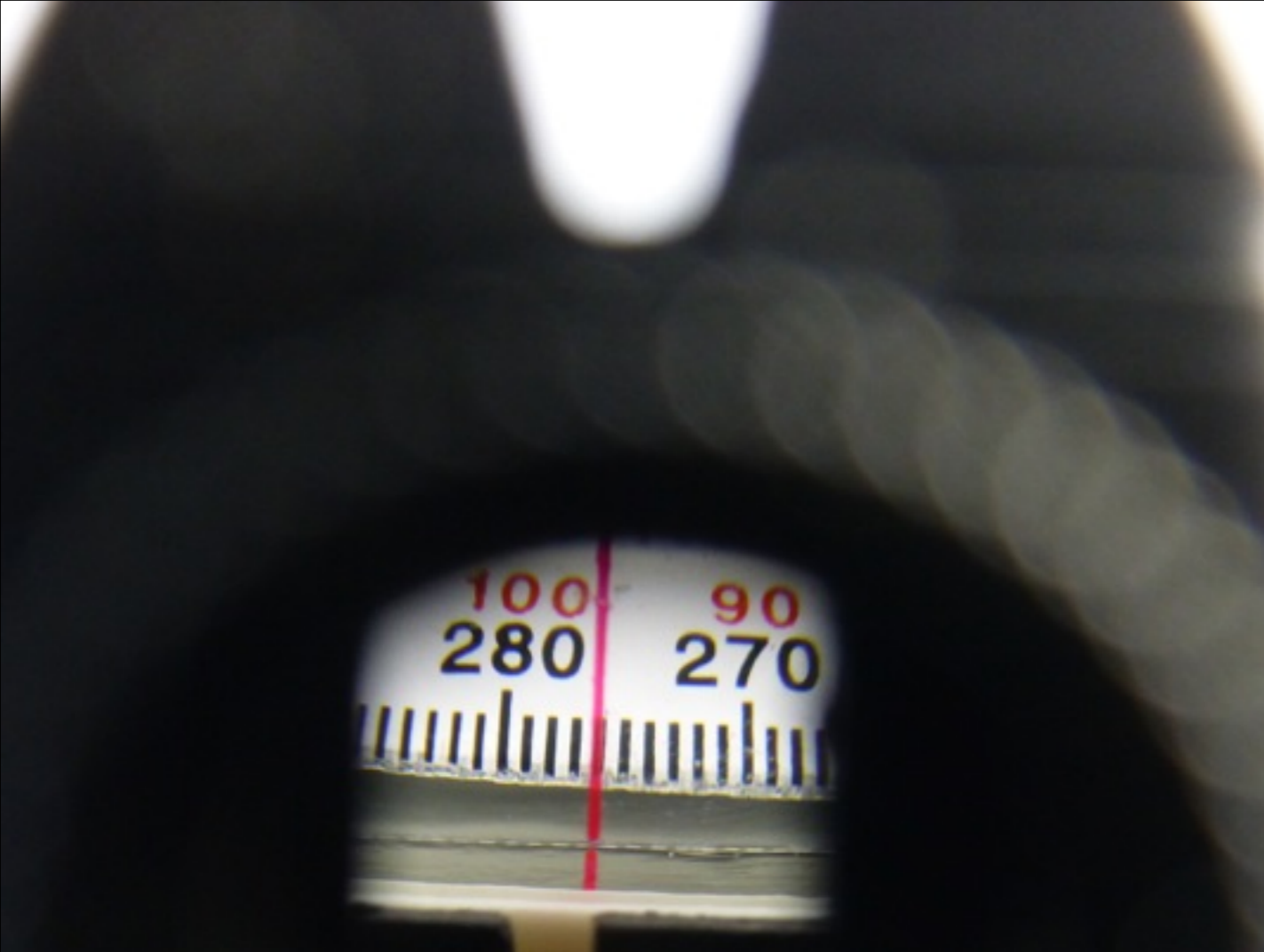

**Forward bearings in
black type
Back bearings in
red type**

**Labeled every 10°
Increases right-to-left
Each increment is 1°**

Forward bearing?

276°

Back bearing?

96°