

Corbin
Russwin

ASSA ABLOY

UT5200 Series

Pre-Assembled Unit Locksets

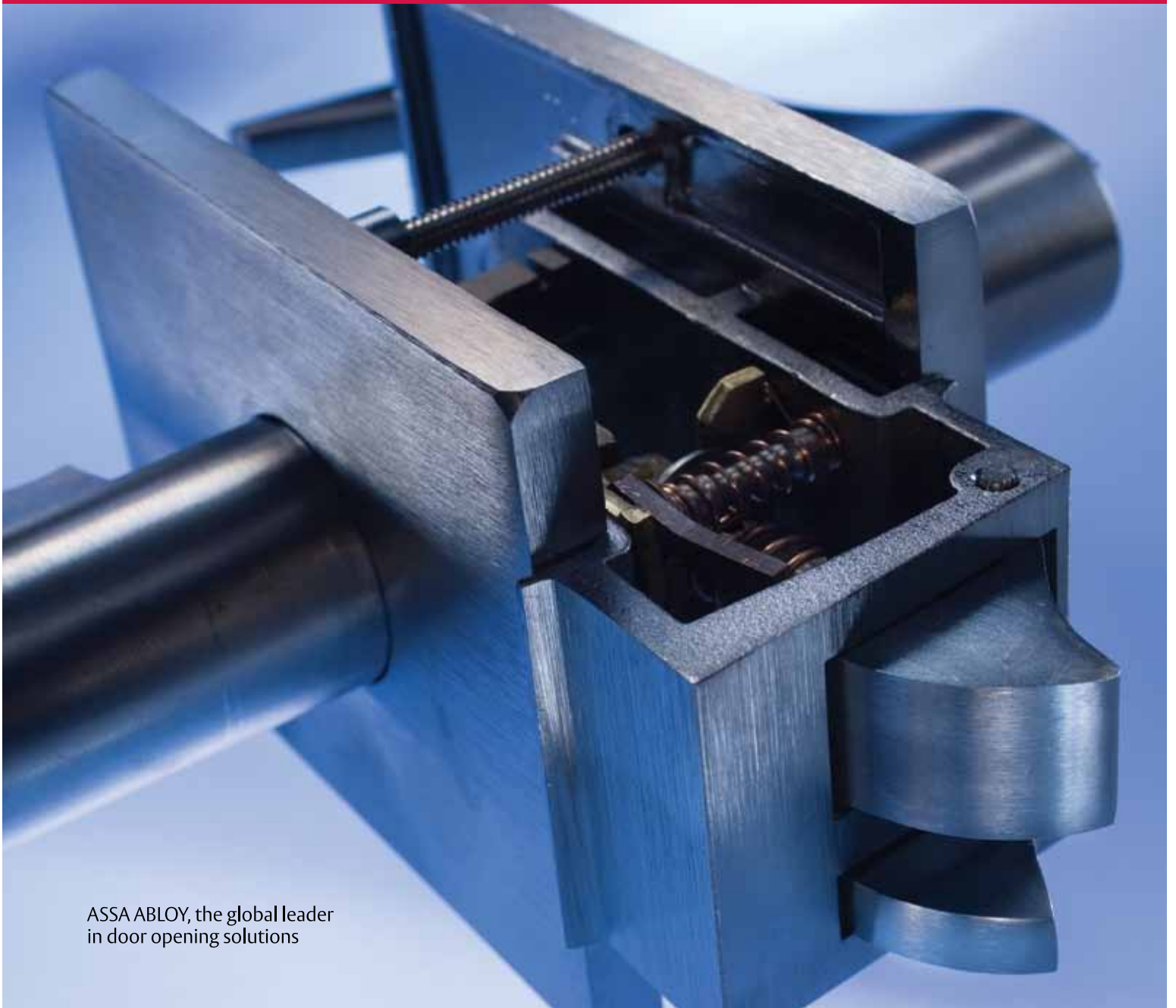

ASSA ABLOY, the global leader
in door opening solutions



Applications

UT5200

Applications

This lock has provided decades of service in some of the world's most prestigious buildings. Its pre-assembled, unitized construction is ideal for projects where installation costs are to be minimized. Typical high-traffic commercial, institutional and industrial applications include:

- Schools and universities
- Office buildings
- Hospitals
- Municipal buildings
- Historic buildings



Advantages

- Factory pre-assembled for quick, economical, one-piece installation: no job site assembly required
- 3/4" radius latchbolt, designed to wedge more tightly into the strike when tampered with, while meeting all ADA force-to-latch requirements.

Table of Contents

Applications..... 2

Features..... 3

Functions..... 4

Trim Designs..... 5

Options and Accessories 6

How to Order..... 8

Helpful Terms..... 10

How to Specify..... 11

Features

Handing

Specify hand. All functions are handed.

Door Thickness

1-3/4" (44mm) only.

Backset

2-3/4" (70mm) only.

Lock Chassis

One-piece investment cast frame. Machined internal parts of steel, bronze and stainless steel. Zinc dichromated for corrosion resistance.

Front

Beveled 1/8" (3mm) in 2" (51mm).

Latchbolt

Brass, chrome plated, 3/4" (19mm) throw pivoted, swinging type.

Auxiliary Latch

Deadlocks latchbolt, preventing manipulation when door is closed.

Strike

Wrought brass or bronze, ANSI strike with nylon adjusting screw, standard. 4-7/8" (124mm) x 1-1/4" (32mm) x 1-1/4" (32mm) lip to center. Optional strikes and lip lengths available; see pages 6 and 9.

Cylinder

Brass, 6-pin, L4 keyway, 0-bitted standard.

Keys

Two nickel silver standard.

Keying Features Available

- Master keying
- Construction master keying
- Visual key control
- Concealed key control
- Interchangeable core (IC)
- Security
- Security (IC)
- Pyramid High Security
- Pyramid High Security (IC)
- Pyramid Security
- Pyramid Security (IC)
- Master ring

Warranty

One-year limited.

Certification/Compliance

ANSI

Meets A156.2 Series 2000.
Meets A117.1 Accessibility Code (lever design only).

Federal

Meets FF-H-106C.

California State Reference Code (Formerly Title 19, California State Fire Marshal Standard)

All levers with return comply; levers return to within 1/2" (13mm) of door face.

UL/ULC

All locks listed for A label and lesser class doors, single or pair, maximum door size 3'8" (111.7cm) x 7'2" (218.4cm). All locksets also listed for B label doors, single or pair, maximum door size 4' x 8'. Letter F and UL symbol on lock frame indicate listing.

Any retrofit or other field modification to a fire-rated opening can potentially impact the fire rating of the opening, and Corbin Russwin, Inc. makes no representations or

warranties concerning what such impact may be in any specific situation. When retrofitting any portion of an existing fire-rated opening, or specifying and installing a new fire-rated opening, please consult with a code specialist or local code official (Authority Having Jurisdiction) to ensure compliance with all applicable codes and ratings.

Finishes

612	US10	Satin Bronze
613	US10B	Oxidized Bronze, oil rubbed, available lacquered
625	US26	Bright Chromium Plated
626	US26D	Satin Chromium Plated
626C	—	Satin Chromium Plated with MicroShield®

Installation of preassembled lockset requires only tightening three through bolts, significantly reducing costs and potential for error

Precision machined internal parts ensure smooth operation and long life

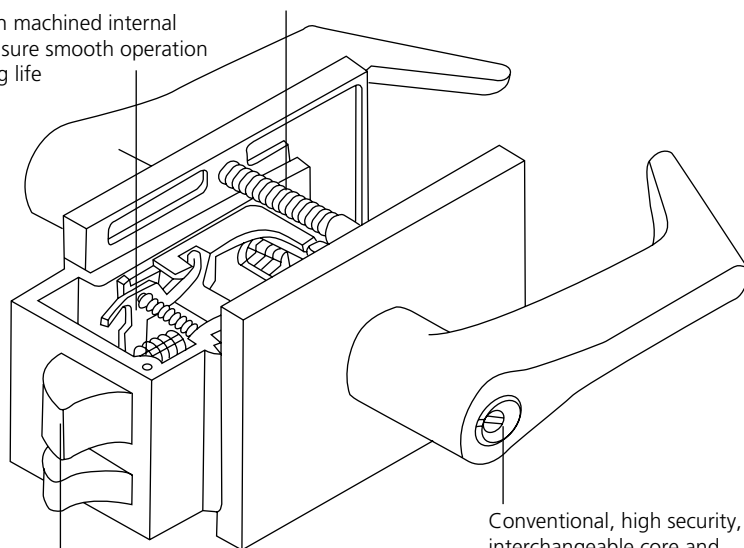



3/4" throw latchbolt provides security and meets all force-to-latch requirements

Conventional, high security, interchangeable core and master ring cylinders available for keying flexibility

Functions

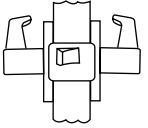
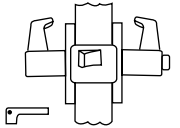
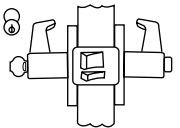
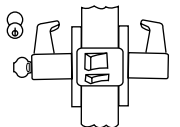
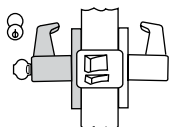
UT5200

Outside	Inside	Series/Function	Type	ANSI No. Series 2000	Function Description
		UT5210	Passage or Closet	F36	<ul style="list-style-type: none"> Latchbolt by grip either side. Both grips always free.
		UT5220	Privacy Bedroom or Bathroom	F37	<ul style="list-style-type: none"> Latchbolt by grip either side. Outside grip locked by push button. Outside grip unlocked by emergency release tool outside, by rotating inside grip or by closing door. Inside grip always free.
		UT5251	Entrance or Office	F40	<ul style="list-style-type: none"> Deadlocking latchbolt by grip either side, except when turn button locks outside grip. Key outside retracts latchbolt. Outside grip unlocked by turn button. Inside grip always free.
		UT5255	Classroom	F42	<ul style="list-style-type: none"> Deadlocking latchbolt by grip either side, except when key outside locks outside grip. Outside grip unlocked by key outside. Inside grip always free.
		UT5257	Storeroom or Closet	F44	<ul style="list-style-type: none"> Deadlocking latchbolt by key in outside grip or by rotating inside lever. Outside grip always rigid. Inside grip always free.
		UT5282	Store Door	F46	<ul style="list-style-type: none"> Deadlocking latchbolt by grip either side, except when key either side locks both grips. Keyed alike unless specified otherwise.

 Indicates optional interchangeable core available; see How to Order, page 9.

 Indicates rigid grip.

Trim Designs

UT5200

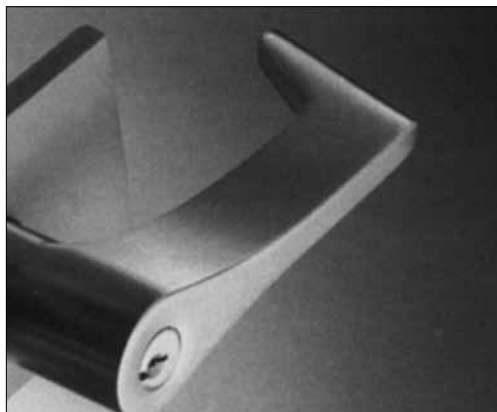

Essex

Complies with codes requiring lever to return to within 1/2" (13mm) of door face.

Brass.

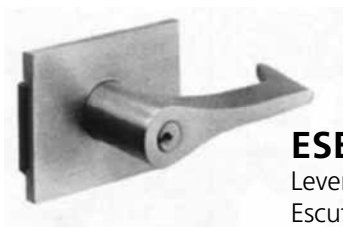

ESE

Lever: Forged
Escutcheon: Forged

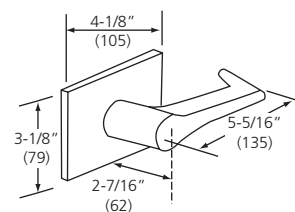

Options and Accessories

UT5200

Strikes

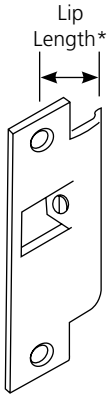

*Lip length for ANSI strikes measured from lip to center

ANSI Curved Lip

Brass or bronze.
4-7/8" (124mm) x 1-1/4" (32mm) x 1-1/4" (32mm) lip to center.
Nylon set screw to adjust clearance.
No optional lip lengths.
Wrought box not available.
To order with lockset, see How to Order, pages 8 and 9. To order separately, specify 236L75 x Finish.

ANSI Straight Lip for Extended Lip Escutcheon

Brass or bronze.
4-7/8" (124mm) x 1-1/4" (32mm) x 15/16" (24mm) lip to center.
Nylon set screw to adjust clearance.
Furnished standard with extended lip escutcheon option.
To order separately, specify 610L43 x Finish.

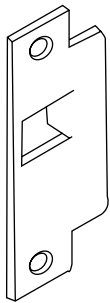

ANSI Straight Lip for Pairs of Doors

Brass or bronze.
4-7/8" (124mm) x 1-1/4" (32mm) x 1" (25mm) lip to center.
Non-adjustable.
To order with lockset, see How to Order, pages 8 and 9.
To order separately, specify 610L44 x Finish.

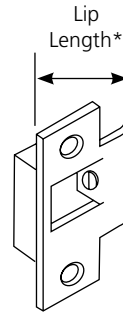

*Lip length for non ANSI strikes measured from back of the strike to the lip.

Curved Lip Box

Brass or bronze.
3-1/4" (83mm) x 1-1/8" (29mm) x 2-1/8" (54mm).
Nylon set screw to adjust clearance.
Optional lip lengths (measured from back of strike to edge of lip): 2" (51mm), 2-1/4" (57mm), 2-1/2" (64mm), 2-3/4" (70mm), 3" (76mm).
To order with lockset, see How to Order, page 9.
To order separately, specify 083L96 x Lip Length x Finish.

For Extended Lip Escutcheon

Brass or bronze.
3-1/4" (83mm) x 1-1/8" (29mm) x 1-13/16" (46mm) lip length.
Nylon set screw to adjust clearance. Lip not curved.
To order with lockset, see How to Order, page 9.
To order separately, specify 293L14 x Finish.

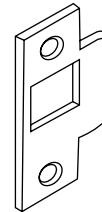

For Pairs of Doors

Brass or bronze. Non-adjustable
3-1/4" (83mm) x 1-1/16" (27mm) x 1-13/16" (46mm).
To order with lockset, see How to Order, page 9.
To order separately, specify 82L67 x Finish.

Cylinders

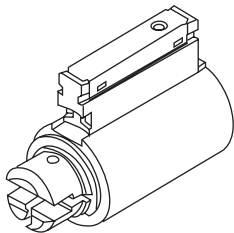
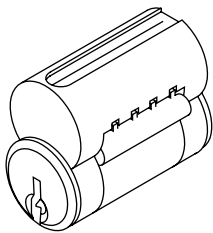
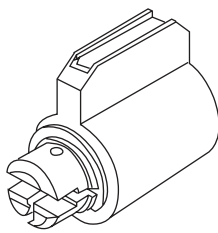
	 <p>Standard Cylinder .552" plug diameter Brass, 6-pin 2 nickel silver keys Finishes: 606, 626 .496" plug diameter Pyramid</p>	 <p>Interchangeable Core .509" plug diameter conventional .552" plug diameter high security Brass, 6-pin 2 nickel silver keys Finishes: 612, 613, 625, 626 .496" plug diameter Pyramid</p>	 <p>Master Ring Cylinder .552" plug diameter Brass, 6-pin 2 nickel silver keys Finishes: 606, 626</p>
Conventional 6-Pin	2000-052	8000	2060-052
Conventional 7-Pin	N/A	8000-7	N/A
Security	2010-052	8010	N/A
Pyramid High Security	2020-052	8020	N/A
Pyramid Security	2027-052	8027	N/A

To order optional cylinder with lockset, see How to Order, page 9.

To order cylinder separately, specify Part No. x Keyway x Finish) (e.g., 2000-052 x L4 x 626).

How to Order

UT5200

Ordering Examples

Stock Order

Quantity	Series/Function	Trim	Finish	Hand
100	UT5251	ESE	626	RH

Split Finish Order

Quantity	Series/ Function	Trim	Finish		Hand
			Outside	Inside	
12	UT5251	ESE	626	625	RH

Contract / Detailed Order

Quantity	Keyset	Series/ Function	Trim	Finish	Hand	Optional Strike	Misc. Options	Optional Cylinder	Keying
24	AA1	UT5251	ESE	626	RHR	SC200	M21	MR	VKC3

Where to find ordering information and Quick Codes

Series/Function	Page 4
Trim Designs	Page 5
Finish	Page 9
Handing	Page 9
Strikes	Page 9
Miscellaneous Options	Page 9
Cylinder and Keying	Page 9

Cylinder and Keying

Description	Specify
Conventional 6-pin	(standard)
Less cylinder(s)	LC
IC 6-pin	C6
IC 6-pin with temporary construction core	CT6
IC 6-pin less core	CL6
IC 7-pin (ESE trim only)	C7
IC 7-pin with temporary construction core (ESE trim only)	CT7
IC 7-pin less core (ESE trim only)	CL7
High Security	HS
High Security IC	CHS
Master ring	MR
0-bitted with 2 blank keys	(standard)
Keyed random	KR
Construction master keyed	CMK
Pyramid Security Fixed Core	PS
Pyramid Security IC	PCS
Pyramid High Security Fixed Core	PHS
Pyramid High Security IC	PCHS
Pyramid IC with Temporary Construction Core	CTP
Pyramid IC with Temporary Disposable Core	CTPD
Pyramid IC Less Core	CLP
IC 6-pin with Temporary Construction Core (Red)	CT6R
IC 6-pin with Temporary Construction Core (Blue)	CT6B
IC 6-pin with Temporary Construction Core (Green)	CT6G
IC 6-pin with Temporary Disposable Core	CT6D
IC 7-pin with Temporary Construction Core (Red)	CT7R
IC 7-pin with Temporary Construction Core (Blue)	CT7B
IC 7-pin with Temporary Construction Core (Green)	CT7G
IC 7-pin with temporary Disposable Core	CT7D
No Stamping	VKC0
Keys only	VKC1
Cylinders and keys (not for HS or CHS)	VKC2
Cylinders only (not for HS or CHS)	VKC3
Concealed key control (CKC)	
CKC cylinders with VKC keys	CKC2
CKC cylinders only	CKC3
2 keys per lock	(standard)
More than 2 keys	KY# (e.g., KY6)

Strikes

Lip Length	ANSI Curved Lip Specify	Curved Lip Box* Specify
1-1/4" (32mm)	(standard)	N/A
2" (51mm)	N/A	SA200
2-1/8" (54mm)	N/A	SA218
2-1/4" (57mm)	N/A	SA214
2-1/2" (64mm)	N/A	SA212
2-3/4" (70mm)	N/A	SA234
3" (76mm)	N/A	SA300

Lip Length	ANSI* Straight Lip for Door Pair Specify	For Door Pair* Specify
1-13/16" (46mm)	SA136	SP136

Lip Length	ANSI Straight Lip for Extended Lip Escutcheon	For Extended Lip Escutcheon
15/16" (24mm)	Standard when extended lip escutcheon option is specified	SX156

*Lip is measured from back of strike

Miscellaneous Options

Description	Specify
Delrin insert	M01
Spanner head screws	M02
Lever to accept Best®-type core	M08
Knob to accept Best®-type core	M10
Extended lip escutcheon (for single door reverse bevel; 630 finish to match 626 only)	M11
Knurling outside and inside	M20
Knurling outside only	M21
Knurling inside only	M22
Abrasive coat outside and inside	M23
Abrasive coat inside only	M24
Abrasive coat outside only	M25
Lead-lined escutcheon (inside only)	M28
Unstaked lever retainer	M33
MicroShield Coating (626C only)	C

Finish

Description	Specify
US10 Satin Bronze	612
US10B Dark Oxidized Satin Bronze, oil rubbed	613
US26 Bright Chromium Plated	625
US26D Satin Chromium Plated	626
Satin Chromium Plated with MicroShield	626C

Handing

Hand	Specify
Right Hand	RH
Left Hand	LH
Right Hand Reverse	RHR
Left Hand Reverse	LHR

Helpful Terms

UT5200

Abrasive Coat

Hard granular material applied to a knob or lever to provide a non-slip tactile surface for the visually impaired.

Auxiliary Latchbolt

A supplementary latch which, when the door is closed, automatically deadlocks the latchbolt. Protects the latchbolt from forced retraction or "credit carding."

Backset

The distance from the front of the lock to the centerline of the cylinder or knob/lever hub.

Bevel

The angle of the edge of a door in relation to the inside and outside surfaces of the stile. The most common bevel for commercial doors is 1/8" in 2".

Box Strike

A strike equipped with an enclosure behind the hole(s) for the latchbolt and/or deadbolt. Protects the strike area from mortar and cement.

Chassis

The housing of a lockset, containing most of the working parts.

Curved Lip Strike

A strike with the lip curved to conform to the detail of the door frame.

Front

The part of a lock visible on the edge of a door.

Hand

The direction a door swings.

Knurling

A permanently applied tactile warning engraved in the metal of a knob or lever to warn the visually impaired of dangerous conditions on the other side of the door.

Latchbolt

A lock component having a beveled end that projects from the lock front but may be forced back into the lockcase by end pressure or drawn back by action of the retractor. When the door is closed, the latchbolt projects into a hole provided in the strike, holding the door in the closed position.

Lead Lined

Pertains to a lockset whose trim has a lining of lead to prevent the passage of radiation. Generally used in hospital applications.

Lip of Strike

The projecting part of a strike which first engages the latch; may be curved or straight.

Return

The part of a lever handle which angles or turns back toward the face of the door. Also, the distance between the end of the return of the lever and the surface of the door.

Strike

A metal plate that is pierced or recessed to receive the deadbolt or latchbolt of a lock (sometimes called a keeper).

Throw

The distance that a lock's deadbolt or latchbolt projects when in the locked position. The effective throw is the distance that a latchbolt projects when deadlocked.

Wrought Strike Box

A metal box mounted behind the strike to protect the strike opening from mortar or cement.

Keying and Cylinder Terms

Concealed Key Control (CKC)

The marking of standard key symbols on a cylinder in a location which is not visible once the cylinder is installed.

Construction Core

An interchangeable core for temporary use during construction. It is replaced by the permanent core when construction personnel no longer need access.

Construction Master Keying (CMK)

A cylinder preparation which allows temporary access by construction personnel.

Control Key

A key used to remove and install interchangeable cores.

Cylinder

A lock component containing the combination which determines which keys will operate.

Interchangeable Core (IC)

A cylinder which can be removed and installed quickly with a control key by non-skilled personnel when rekeying is required.

Key Section

The cross-section of a key blade, as viewed from bow to tip.

Key Symbol

A letter/number combination in standard industry format (e.g., 1AA, AA1, etc) which indicates exactly how a key or cylinder fits into a keying system.

Keyway

The opening in a cylinder plug through which the key enters.

Master Keying

Preparation of a cylinder to operate with keys of different levels of access.

Master Ring Cylinder

A cylinder which offers a wider range of keying.

Visual Key Control (VCK)

The marking of standard key symbols on keys and on the visible portion of the front of a cylinder.

Suggested Specification

All locksets shall be UT5200 Series Pre-Assembled Unit Locksets, as manufactured by Corbin Russwin Architectural Hardware, Berlin, Connecticut, USA.

Locksets shall be the unit type, completely pre-assembled at the factory, requiring no dis-assembly to install on the door. Knobs/levers and escutcheons shall be part of the pre-assembled lockset.

The lock frame, levers, escutcheons and bolts shall be made from non-ferrous metals. Escutcheons shall be forged brass, 5/16" thick, and when installed on specified reverse bevel doors shall be the extended lip type to provide additional security. The latchbolt shall be extruded brass, pivoted swinging type with 3/4" throw. The cylinder shall be universal with a horizontal keyway to assure correct orientation. Conventional, high security, interchangeable core and master ring cylinders shall be available.

Lever handle designs shall return to within 1/2" of door surface.

All locksets shall be listed by Underwriters Laboratories for A label and lesser class doors, single or pair, maximum door size 3'8" x 7'2". All locksets shall also be UL listed for B label doors, single or pair, maximum door size 4' x 8'.

Certification:

Federal Specification FF-H-106C

ANSI A156.2 Series 2000

ANSI A117.1 Accessibility Code (lever handle trim)

California State Reference Code, 1989 (formerly Title 19, California State Fire Marshal Standard) (lever handle trim)

All locks, trim and cylinders shall be from one manufacturer.

All locksets shall carry a one-year limited warranty.



ASSA ABLOY

In U.S.

Corbin Russwin
Architectural Hardware
225 Episcopal Road
Berlin, CT 06037
Phone: 800-543-3658
Fax: 800-447-6714
corbinruswin.com

In Canada

ASSA ABLOY Door
Security Solutions Canada
160 Four Valley Drive
Vaughan, Ontario
Canada L4K 4T9
Phone: 800-461-3007

For more information regarding Corbin Russwin Locksets, Exit Devices, Door Controls and Key Systems, contact your authorized Corbin Russwin Distributor or Sales Representative.



MicroShield®

As part of their promise to provide innovative solutions to their customers, certain ASSA ABLOY Group brands offer the MicroShield® technology, a silver-based antimicrobial coating designed to inhibit the growth of bacteria. MicroShield® is a registered trademark of Yale Security Inc., an ASSA ABLOY Group company.

Corbin Russwin and Design® is a registered trademark of Corbin Russwin, Inc., an ASSA ABLOY Group company. Other products' brand names may be trademarks or registered trademarks of their respective owners and are mentioned for reference purposes only. These materials are protected under US copyright laws. All contents current at time of publication. Corbin Russwin, Inc., an ASSA ABLOY Group company reserves the right to change availability of any item in this catalog, its design, construction, and/or its materials. Copyright © 2000, 2012 Corbin Russwin, Inc., an ASSA ABLOY Group company. All rights reserved. Reproduction in whole or in part without the express written permission of Corbin Russwin, Inc. is prohibited.

ASSA ABLOY is the global leader in door opening solutions, dedicated to satisfying end-user needs for security, safety and convenience.

45090-11/12